

Oracle® Database

Development Guide

12c Release 2 (12.2)

E49632-16

April 2017

Oracle Database Development Guide, 12c Release 2 (12.2)

E49632-16

Copyright © 1996, 2017, Oracle and/or its affiliates. All rights reserved.

Primary Author: Amith Kumar

Contributing Authors: Louise Morin, Chuck Murray, Tom Kyte, D. Adams, L. Ashdown, S. Moore, E. Paapanen, R. Strohm, R. Ward

Contributors: D. Alpern, G. Arora, T. Chang, B. Cheng, R. Day, R. Decker, G. Doherty, A. Ganesh, M. Hartstein, Y. Hu, J. Huang, C. Iyer, N. Jain, V. Krishnaswamy, R. Kumar, S. Kumar, C. Lei, B. Llewellyn, K. Mohan, V. Moore, J. Muller, R. Murthy, R. Pang, B. Sinha, S. Vemuri, W. Wang, D. Wong

This software and related documentation are provided under a license agreement containing restrictions on use and disclosure and are protected by intellectual property laws. Except as expressly permitted in your license agreement or allowed by law, you may not use, copy, reproduce, translate, broadcast, modify, license, transmit, distribute, exhibit, perform, publish, or display any part, in any form, or by any means. Reverse engineering, disassembly, or decompilation of this software, unless required by law for interoperability, is prohibited.

The information contained herein is subject to change without notice and is not warranted to be error-free. If you find any errors, please report them to us in writing.

If this is software or related documentation that is delivered to the U.S. Government or anyone licensing it on behalf of the U.S. Government, then the following notice is applicable:

U.S. GOVERNMENT END USERS: Oracle programs, including any operating system, integrated software, any programs installed on the hardware, and/or documentation, delivered to U.S. Government end users are "commercial computer software" pursuant to the applicable Federal Acquisition Regulation and agency-specific supplemental regulations. As such, use, duplication, disclosure, modification, and adaptation of the programs, including any operating system, integrated software, any programs installed on the hardware, and/or documentation, shall be subject to license terms and license restrictions applicable to the programs. No other rights are granted to the U.S. Government.

This software or hardware is developed for general use in a variety of information management applications. It is not developed or intended for use in any inherently dangerous applications, including applications that may create a risk of personal injury. If you use this software or hardware in dangerous applications, then you shall be responsible to take all appropriate fail-safe, backup, redundancy, and other measures to ensure its safe use. Oracle Corporation and its affiliates disclaim any liability for any damages caused by use of this software or hardware in dangerous applications.

Oracle and Java are registered trademarks of Oracle and/or its affiliates. Other names may be trademarks of their respective owners.

Intel and Intel Xeon are trademarks or registered trademarks of Intel Corporation. All SPARC trademarks are used under license and are trademarks or registered trademarks of SPARC International, Inc. AMD, Opteron, the AMD logo, and the AMD Opteron logo are trademarks or registered trademarks of Advanced Micro Devices. UNIX is a registered trademark of The Open Group.

This software or hardware and documentation may provide access to or information about content, products, and services from third parties. Oracle Corporation and its affiliates are not responsible for and expressly disclaim all warranties of any kind with respect to third-party content, products, and services unless otherwise set forth in an applicable agreement between you and Oracle. Oracle Corporation and its affiliates will not be responsible for any loss, costs, or damages incurred due to your access to or use of third-party content, products, or services, except as set forth in an applicable agreement between you and Oracle.

Contents

Preface	xxiii
Audience	xxiii
Documentation Accessibility	xxiii
Related Documents.....	xxiii
Conventions.....	xxiv
Changes in Oracle Database 12c Release 2 (12.2)	xxvii
Part I Database Development Fundamentals	
1 Design Basics	
1.1 Design for Performance	1-1
1.2 Design for Scalability.....	1-2
1.3 Design for Extensibility.....	1-2
1.3.1 Data Cartridges.....	1-3
1.3.2 External Procedures	1-3
1.3.3 User-Defined Functions and Aggregate Functions	1-3
1.3.4 Object-Relational Features	1-4
1.4 Design for Security	1-4
1.5 Design for Availability.....	1-5
1.6 Design for Portability	1-5
1.7 Design for Diagnosability.....	1-6
1.8 Design for Special Environments	1-6
1.8.1 Data Warehousing.....	1-6
1.8.2 Online Transaction Processing (OLTP).....	1-7
1.9 Features for Special Scenarios.....	1-8
1.9.1 SQL Analytic Functions.....	1-8
1.9.2 Materialized Views	1-9
1.9.3 Partitioning.....	1-10
1.9.4 Temporal Validity Support.....	1-11

2 Connection Strategies for Database Applications

2.1 Design Guidelines for Connection Pools.....	2-1
2.1.1 Connection Storms	2-2
2.1.2 Guideline for Preventing Connection Storms: Use Static Pools	2-2
2.2 Design Guideline for Login Strategy	2-3
2.3 Design Guideline for Preventing Programmatic Session Leaks	2-4
2.3.1 Drained Connection Pools	2-4
2.3.2 Checking for Session Leaks.....	2-4
2.3.3 Lock Leaks	2-4
2.3.4 Logical Corruption.....	2-5
2.4 Using Runtime Connection Load Balancing.....	2-5
2.4.1 About Runtime Connection Load Balancing.....	2-5
2.4.2 Enabling and Disabling Runtime Connection Load Balancing	2-6
2.4.3 Receiving Load Balancing Advisory FAN Events.....	2-8

3 Performance and Scalability

3.1 Performance Strategies.....	3-1
3.1.1 Designing Your Data Model to Perform Well.....	3-1
3.1.2 Setting Performance Goals (Metrics).....	3-4
3.1.3 Benchmarking Your Application	3-4
3.2 Tools for Performance	3-5
3.2.1 DBMS_APPLICATION_INFO Package.....	3-5
3.2.2 SQL Trace Facility (SQL_TRACE).....	3-6
3.2.3 EXPLAIN PLAN Statement	3-7
3.3 Monitoring Database Performance	3-8
3.3.1 Automatic Database Diagnostic Monitor (ADDM).....	3-8
3.3.2 Monitoring Real-Time Database Performance.....	3-9
3.3.3 Responding to Performance-Related Alerts.....	3-9
3.3.4 SQL Advisors and Memory Advisors.....	3-9
3.4 Testing for Performance.....	3-10
3.5 Using Client Result Cache	3-11
3.5.1 About Client Result Cache	3-12
3.5.2 Benefits of Client Result Cache.....	3-12
3.5.3 Guidelines for Using Client Result Cache	3-13
3.5.4 Client Result Cache Consistency	3-17
3.5.5 Deployment-Time Settings for Client Result Cache.....	3-18
3.5.6 Client Result Cache Statistics.....	3-21
3.5.7 Validation of Client Result Cache	3-21
3.5.8 Client Result Cache and Server Result Cache	3-22
3.5.9 Client Result Cache Demo Files	3-23
3.5.10 Client Result Cache Compatibility with Previous Releases.....	3-23
3.5.11 Where to Find More Information About Client Result Cache.....	3-24

3.6	Statement Caching	3-24
3.7	OCI Client Statement Cache Auto-Tuning	3-25
3.8	Client-Side Deployment Parameters.....	3-25
3.9	Using Query Change Notification.....	3-25
3.10	Using Database Resident Connection Pool.....	3-26
3.10.1	About Database Resident Connection Pool.....	3-27
3.10.2	Configuring DRCP	3-28
3.10.3	Sharing Proxy Sessions.....	3-29
3.10.4	Using JDBC with DRCP.....	3-29
3.10.5	Using OCI Session Pool APIs with DRCP	3-29
3.10.6	Session Purity and Connection Class	3-30
3.10.7	Starting Database Resident Connection Pool.....	3-32
3.10.8	Enabling DRCP	3-32
3.10.9	Benefiting from the Scalability of DRCP in an OCI Application.....	3-32
3.10.10	Benefiting from the Scalability of DRCP in a Java Application.....	3-33
3.10.11	Best Practices for Using DRCP	3-33
3.10.12	Compatibility and Migration.....	3-35
3.10.13	DRCP Restrictions	3-35
3.10.14	Using DRCP with Custom Pools.....	3-36
3.10.15	Explicitly Marking Sessions Stateful or Stateless.....	3-36
3.10.16	Using DRCP with Oracle Real Application Clusters	3-37
3.10.17	Using DRCP with Pluggable Databases.....	3-37
3.10.18	DRCP with Data Guard.....	3-38

4 Designing Applications for Oracle Real-World Performance

4.1	Using Bind Variables.....	4-1
4.2	Using Instrumentation	4-2
4.3	Using Set-Based Processing.....	4-2
4.3.1	Iterative Data Processing.....	4-3
4.3.2	Set-Based Processing.....	4-9

5 Security

5.1	Enabling User Access with Grants, Roles, and Least Privilege.....	5-1
5.2	Automating Database Logins	5-2
5.3	Controlling User Access with Fine-Grained Access Control	5-3
5.4	Using Invoker's and Definer's Rights for Procedures and Functions	5-4
5.4.1	What Are Invoker's Rights and Definer's Rights?	5-4
5.4.2	Protecting Users Who Run Invoker's Rights Procedures and Functions.....	5-5
5.4.3	How Default Rights Are Handled for Java Stored Procedures	5-6
5.5	Managing External Procedures for Your Applications.....	5-6
5.6	Auditing User Activity.....	5-7

6	High Availability	
6.1	Transparent Application Failover (TAF).....	6-1
6.1.1	About Transparent Application Failover.....	6-1
6.1.2	Configuring Transparent Application Failover	6-2
6.1.3	Using Transparent Application Failover Callbacks	6-2
6.2	Fast Application Notification (FAN) and Fast Connection Failover (FCF).....	6-3
6.2.1	About Fast Application Notification (FAN)	6-3
6.2.2	About Receiving FAN Event Notifications	6-4
6.2.3	About Fast Connection Failover (FCF).....	6-4
6.3	Application Continuity and Transaction Guard.....	6-5
6.3.1	Overview of Application Continuity.....	6-6
6.3.2	Overview of Transaction Guard.....	6-7
6.4	Service and Load Management for Database Clouds	6-7
6.4.1	About Service and Load Management for Database Clouds.....	6-7

7 Advanced PL/SQL Features

7.1	PL/SQL Data Types	7-1
7.2	Dynamic SQL	7-1
7.3	PL/SQL Optimize Level	7-2
7.4	Compiling PL/SQL Units for Native Execution.....	7-2
7.5	Exception Handling.....	7-2
7.6	Conditional Compilation.....	7-2
7.7	Bulk Binding.....	7-2

Part II SQL for Application Developers

8 SQL Processing for Application Developers

8.1	Description of SQL Statement Processing.....	8-1
8.1.1	Stages of SQL Statement Processing.....	8-2
8.1.2	Shared SQL Areas.....	8-4
8.2	Grouping Operations into Transactions.....	8-4
8.2.1	Deciding How to Group Operations in Transactions	8-4
8.2.2	Improving Transaction Performance.....	8-5
8.2.3	Managing Commit Redo Action	8-6
8.2.4	Determining Transaction Outcome After a Recoverable Outage	8-8
8.3	Ensuring Repeatable Reads with Read-Only Transactions	8-13
8.4	Locking Tables Explicitly.....	8-14
8.4.1	Privileges Required to Acquire Table Locks	8-15
8.4.2	Choosing a Locking Strategy	8-15
8.4.3	Letting Oracle Database Control Table Locking.....	8-18
8.4.4	Explicitly Acquiring Row Locks.....	8-18
8.4.5	Examples of Concurrency Under Explicit Locking	8-19

8.5	Using Oracle Lock Management Services (User Locks).....	8-27
8.5.1	When to Use User Locks	8-28
8.5.2	Viewing and Monitoring Locks.....	8-29
8.6	Using Serializable Transactions for Concurrency Control	8-29
8.6.1	Transaction Interaction and Isolation Level	8-30
8.6.2	Setting Isolation Levels.....	8-32
8.6.3	Serializable Transactions and Referential Integrity.....	8-33
8.6.4	READ COMMITTED and SERIALIZABLE Isolation Levels	8-35
8.7	Nonblocking and Blocking DDL Statements.....	8-37
8.8	Autonomous Transactions	8-38
8.8.1	Examples of Autonomous Transactions	8-40
8.8.2	Declaring Autonomous Routines.....	8-44
8.9	Resuming Execution After Storage Allocation Errors.....	8-45
8.9.1	What Operations Have Resumable Storage Allocation?	8-45
8.9.2	Handling Suspended Storage Allocation.....	8-45

9 Using SQL Data Types in Database Applications

9.1	Using the Correct and Most Specific Data Type	9-1
9.1.1	How the Correct Data Type Increases Data Integrity	9-2
9.1.2	How the Most Specific Data Type Decreases Storage Requirements	9-2
9.1.3	How the Correct Data Type Improves Performance	9-3
9.2	Representing Character Data	9-5
9.3	Representing Numeric Data.....	9-7
9.3.1	Floating-Point Number Components.....	9-8
9.3.2	Floating-Point Number Formats	9-8
9.3.3	Representing Special Values with Native Floating-Point Data Types	9-10
9.3.4	Comparing Native Floating-Point Values	9-11
9.3.5	Arithmetic Operations with Native Floating-Point Data Types	9-11
9.3.6	Conversion Functions for Native Floating-Point Data Types.....	9-12
9.3.7	Client Interfaces for Native Floating-Point Data Types.....	9-13
9.4	Representing Date and Time Data	9-13
9.4.1	Displaying Current Date and Time	9-15
9.4.2	Inserting and Displaying Dates.....	9-16
9.4.3	Inserting and Displaying Times	9-17
9.4.4	Arithmetic Operations with Datetime Data Types.....	9-18
9.4.5	Conversion Functions for Datetime Data Types.....	9-18
9.4.6	Importing, Exporting, and Comparing Datetime Types	9-19
9.5	Representing Specialized Data	9-20
9.5.1	Representing Spatial Data	9-20
9.5.2	Representing Multimedia Data	9-20
9.5.3	Representing Large Amounts of Data.....	9-20
9.5.4	Representing Searchable Text.....	9-22
9.5.5	Representing XML Data	9-22

9.5.6	Representing Dynamically Typed Data	9-22
9.5.7	Representing ANSI, DB2, and SQL/DS Data.....	9-24
9.6	Identifying Rows by Address	9-24
9.7	Displaying Metadata for SQL Operators and Functions	9-26
9.7.1	ARGn Data Type	9-27
9.7.2	DISP_TYPE Data Type.....	9-27
9.7.3	SQL Data Type Families.....	9-27
10	Using Regular Expressions in Database Applications	
10.1	Overview of Regular Expressions	10-1
10.2	Oracle SQL Support for Regular Expressions	10-2
10.3	Oracle SQL and POSIX Regular Expression Standard	10-4
10.4	Operators in Oracle SQL Regular Expressions.....	10-5
10.4.1	POSIX Operators in Oracle SQL Regular Expressions.....	10-5
10.4.2	Oracle SQL Multilingual Extensions to POSIX Standard.....	10-8
10.4.3	Oracle SQL PERL-Influenced Extensions to POSIX Standard.....	10-9
10.5	Using Regular Expressions in SQL Statements: Scenarios	10-11
10.5.1	Using a Constraint to Enforce a Phone Number Format.....	10-11
10.5.2	Example: Enforcing a Phone Number Format with Regular Expressions.....	10-12
10.5.3	Example: Inserting Phone Numbers in Correct and Incorrect Formats.....	10-12
10.5.4	Using Back References to Reposition Characters	10-13
11	Using Indexes in Database Applications	
11.1	Guidelines for Managing Indexes	11-1
11.2	Managing Indexes.....	11-2
11.3	When to Use Domain Indexes.....	11-2
11.4	When to Use Function-Based Indexes	11-2
11.4.1	Advantages of Function-Based Indexes.....	11-3
11.4.2	Disadvantages of Function-Based Indexes.....	11-4
11.4.3	Example: Function-Based Index for Precomputing Arithmetic Expression.....	11-5
11.4.4	Example: Function-Based Indexes on Object Column.....	11-6
11.4.5	Example: Function-Based Index for Faster Case-Insensitive Searches.....	11-7
11.4.6	Example: Function-Based Index for Language-Dependent Sorting	11-8
12	Maintaining Data Integrity in Database Applications	
12.1	Enforcing Business Rules with Constraints	12-2
12.2	Enforcing Business Rules with Both Constraints and Application Code.....	12-3
12.3	Creating Indexes for Use with Constraints.....	12-4
12.4	When to Use NOT NULL Constraints.....	12-5
12.5	When to Use Default Column Values.....	12-6
12.6	Choosing a Primary Key for a Table (PRIMARY KEY Constraint).....	12-7
12.7	When to Use UNIQUE Constraints.....	12-7
12.8	Enforcing Referential Integrity with FOREIGN KEY Constraints	12-8

12.8.1	FOREIGN KEY Constraints and NULL Values	12-10
12.8.2	Defining Relationships Between Parent and Child Tables	12-10
12.8.3	Rules for Multiple FOREIGN KEY Constraints	12-11
12.8.4	Deferring Constraint Checks	12-11
12.9	Minimizing Space and Time Overhead for Indexes Associated with Constraints	12-14
12.10	Guidelines for Indexing Foreign Keys.....	12-14
12.11	Referential Integrity in a Distributed Database.....	12-14
12.12	When to Use CHECK Constraints.....	12-15
12.12.1	Restrictions on CHECK Constraints.....	12-15
12.12.2	Designing CHECK Constraints.....	12-16
12.12.3	Rules for Multiple CHECK Constraints.....	12-16
12.12.4	Choosing Between CHECK and NOT NULL Constraints	12-16
12.13	Examples of Defining Constraints.....	12-17
12.13.1	Privileges Needed to Define Constraints.....	12-18
12.13.2	Naming Constraints	12-18
12.14	Enabling and Disabling Constraints	12-19
12.14.1	Why Disable Constraints?.....	12-19
12.14.2	Creating Enabled Constraints (Default).....	12-19
12.14.3	Creating Disabled Constraints	12-20
12.14.4	Enabling Existing Constraints	12-21
12.14.5	Disabling Existing Constraints	12-21
12.14.6	Guidelines for Enabling and Disabling Key Constraints	12-22
12.14.7	Fixing Constraint Exceptions.....	12-22
12.15	Modifying Constraints	12-22
12.16	Renaming Constraints.....	12-23
12.17	Dropping Constraints	12-24
12.18	Managing FOREIGN KEY Constraints	12-25
12.18.1	Data Types and Names for Foreign Key Columns.....	12-25
12.18.2	Limit on Columns in Composite Foreign Keys.....	12-25
12.18.3	Foreign Key References Primary Key by Default.....	12-26
12.18.4	Privileges Required to Create FOREIGN KEY Constraints	12-26
12.18.5	Choosing How Foreign Keys Enforce Referential Integrity.....	12-26
12.19	Viewing Information About Constraints	12-27

Part III PL/SQL for Application Developers

13 Coding PL/SQL Subprograms and Packages

13.1	Overview of PL/SQL Subprograms	13-2
13.2	Overview of PL/SQL Packages	13-2
13.3	Overview of PL/SQL Units.....	13-4
13.3.1	PLSQL_OPTIMIZE_LEVEL Compilation Parameter.....	13-4
13.4	Creating PL/SQL Subprograms and Packages	13-6
13.4.1	Privileges Needed to Create Subprograms and Packages	13-7

13.4.2	Creating Subprograms and Packages.....	13-7
13.4.3	PL/SQL Object Size Limits	13-8
13.4.4	PL/SQL Data Types.....	13-8
13.4.5	Returning Result Sets to Clients.....	13-11
13.4.6	Returning Large Amounts of Data from a Function.....	13-16
13.4.7	PL/SQL Function Result Cache	13-16
13.4.8	Overview of Bulk Binding	13-16
13.4.9	PL/SQL Dynamic SQL.....	13-19
13.5	Altering PL/SQL Subprograms and Packages.....	13-20
13.6	Deprecating Packages, Subprograms, and Types.....	13-20
13.7	Dropping PL/SQL Subprograms and Packages.....	13-20
13.8	Compiling PL/SQL Units for Native Execution.....	13-21
13.9	Invoking Stored PL/SQL Subprograms.....	13-21
13.9.1	Privileges Required to Invoke a Stored Subprogram.....	13-22
13.9.2	Invoking a Subprogram Interactively from Oracle Tools	13-22
13.9.3	Invoking a Subprogram from Another Subprogram.....	13-24
13.9.4	Invoking a Remote Subprogram	13-25
13.10	Invoking Stored PL/SQL Functions from SQL Statements.....	13-28
13.10.1	Why Invoke PL/SQL Functions from SQL Statements?.....	13-29
13.10.2	Where PL/SQL Functions Can Appear in SQL Statements.....	13-29
13.10.3	When PL/SQL Functions Can Appear in SQL Expressions.....	13-30
13.10.4	Controlling Side Effects of PL/SQL Functions Invoked from SQL Statements...	13-30
13.11	Analyzing and Debugging Stored Subprograms.....	13-36
13.11.1	PL/Scope	13-36
13.11.2	PL/SQL Hierarchical Profiler.....	13-36
13.11.3	Debugging PL/SQL and Java.....	13-37
13.12	Package Invalidations and Session State.....	13-38
13.13	Example: Raising an ORA-04068 Error.....	13-39
13.14	Example: Trapping ORA-04068.....	13-39

14 Using PL/Scope

14.1	Overview of PL/Scope.....	14-1
14.2	Privileges Required for Using PL/Scope	14-2
14.3	Specifying Identifier and Statement Collection.....	14-2
14.4	How Much Space is PL/Scope Data Using?.....	14-3
14.5	Viewing PL/Scope Data	14-4
14.5.1	Static Data Dictionary Views for PL/SQL and SQL Identifiers	14-4
14.5.2	Static Data Dictionary Views for SQL Statements.....	14-12
14.5.3	SQL Developer.....	14-16
14.6	Overview of Data Dictionary Views Useful to Manage PL/SQL Code.....	14-16
14.7	Sample PL/Scope Session	14-17

15	Using the PL/SQL Hierarchical Profiler	
15.1	Overview of PL/SQL Hierarchical Profiler	15-1
15.2	Collecting Profile Data	15-2
15.3	Understanding Raw Profiler Output	15-4
15.3.1	Namespaces of Tracked Subprograms	15-6
15.3.2	Special Function Names	15-7
15.4	Analyzing Profile Data.....	15-7
15.4.1	Creating Hierarchical Profiler Tables	15-8
15.4.2	Understanding Hierarchical Profiler Tables	15-9
15.5	plshprof Utility.....	15-15
15.5.1	plshprof Options.....	15-15
15.5.2	HTML Report from a Single Raw Profiler Output File.....	15-15
15.5.3	HTML Difference Report from Two Raw Profiler Output Files	15-21
16	Using PL/SQL Basic Block Coverage to Maintain Quality	
16.1	Overview of PL/SQL Basic Block Coverage	16-1
16.2	Collecting PL/SQL Code Coverage Data.....	16-2
16.3	PL/SQL Code Coverage Tables Description	16-2
17	Developing PL/SQL Web Applications	
17.1	Overview of PL/SQL Web Applications	17-1
17.2	Implementing PL/SQL Web Applications	17-2
17.2.1	PL/SQL Gateway	17-2
17.2.2	PL/SQL Web Toolkit	17-3
17.3	Using mod_plsql Gateway to Map Client Requests to a PL/SQL Web Application	17-4
17.4	Using Embedded PL/SQL Gateway.....	17-5
17.4.1	How Embedded PL/SQL Gateway Processes Client Requests	17-5
17.4.2	Installing Embedded PL/SQL Gateway	17-6
17.4.3	Configuring Embedded PL/SQL Gateway	17-6
17.4.4	Invoking PL/SQL Stored Subprograms Through Embedded PL/SQL Gateway.	17-19
17.4.5	Securing Application Access with Embedded PL/SQL Gateway	17-19
17.4.6	Restrictions in Embedded PL/SQL Gateway	17-19
17.4.7	Using Embedded PL/SQL Gateway: Scenario	17-20
17.5	Generating HTML Output with PL/SQL	17-22
17.6	Passing Parameters to PL/SQL Web Applications.....	17-22
17.6.1	Passing List and Dropdown-List Parameters from an HTML Form	17-23
17.6.2	Passing Option and Check Box Parameters from an HTML Form.....	17-24
17.6.3	Passing Entry-Field Parameters from an HTML Form.....	17-24
17.6.4	Passing Hidden Parameters from an HTML Form	17-26
17.6.5	Uploading a File from an HTML Form.....	17-26
17.6.6	Submitting a Completed HTML Form.....	17-26
17.6.7	Handling Missing Input from an HTML Form.....	17-27

17.6.8	Maintaining State Information Between Web Pages.....	17-27
17.7	Performing Network Operations in PL/SQL Subprograms	17-28
17.7.1	Internet Protocol Version 6 (IPv6) Support	17-28
17.7.2	Sending E-Mail from PL/SQL.....	17-28
17.7.3	Getting a Host Name or Address from PL/SQL	17-29
17.7.4	Using TCP/IP Connections from PL/SQL.....	17-29
17.7.5	Retrieving HTTP URL Contents from PL/SQL.....	17-30
17.7.6	Using Tables, Image Maps, Cookies, and CGI Variables from PL/SQL	17-32

18 Using Continuous Query Notification (CQN)

18.1	About Object Change Notification (OCN).....	18-2
18.2	About Query Result Change Notification (QRCN)	18-2
18.2.1	Guaranteed Mode.....	18-3
18.2.2	Best-Effort Mode.....	18-3
18.3	Events that Generate Notifications	18-5
18.3.1	Committed DML Transactions.....	18-5
18.3.2	Committed DDL Statements.....	18-5
18.3.3	Deregistration	18-6
18.3.4	Global Events	18-7
18.4	Notification Contents	18-7
18.5	Good Candidates for CQN.....	18-8
18.6	Creating CQN Registrations	18-10
18.7	Using PL/SQL to Create CQN Registrations	18-10
18.7.1	PL/SQL CQN Registration Interface.....	18-11
18.7.2	CQN Registration Options.....	18-11
18.7.3	Prerequisites for Creating CQN Registrations	18-16
18.7.4	Queries that Can Be Registered for Object Change Notification (OCN).....	18-16
18.7.5	Queries that Can Be Registered for Query Result Change Notification (QRCN)..	18-16
18.7.6	Using PL/SQL to Register Queries for CQN	18-19
18.7.7	Best Practices for CQN Registrations	18-25
18.7.8	Troubleshooting CQN Registrations.....	18-25
18.7.9	Deleting Registrations.....	18-26
18.7.10	Configuring CQN: Scenario.....	18-26
18.8	Using OCI to Create CQN Registrations.....	18-31
18.8.1	Using OCI for Query Result Set Notifications	18-31
18.8.2	Using OCI to Register a Continuous Query Notification.....	18-32
18.8.3	Using OCI Subscription Handle Attributes for Continuous Query Notification ..	18-33
18.8.4	OCI_ATTR_CQ_QUERYID Attribute	18-35
18.8.5	Using OCI Continuous Query Notification Descriptors	18-35
18.8.6	Demonstrating Continuous Query Notification in an OCI Sample Program	18-37
18.9	Querying CQN Registrations.....	18-47
18.10	Interpreting Notifications	18-47
18.10.1	Interpreting a CQ_NOTIFICATION\$_DESCRIPTOR Object	18-48

18.10.2	Interpreting a CQ_NOTIFICATION\$_TABLE Object	18-49
18.10.3	Interpreting a CQ_NOTIFICATION\$_QUERY Object	18-50
18.10.4	Interpreting a CQ_NOTIFICATION\$_ROW Object	18-50

Part IV Advanced Topics for Application Developers

19 Using Oracle Flashback Technology

19.1	Overview of Oracle Flashback Technology	19-1
19.1.1	Application Development Features.....	19-2
19.1.2	Database Administration Features	19-3
19.2	Configuring Your Database for Oracle Flashback Technology	19-4
19.2.1	Configuring Your Database for Automatic Undo Management.....	19-4
19.2.2	Configuring Your Database for Oracle Flashback Transaction Query.....	19-5
19.2.3	Configuring Your Database for Flashback Transaction.....	19-5
19.2.4	Enabling Oracle Flashback Operations on Specific LOB Columns.....	19-5
19.2.5	Granting Necessary Privileges	19-6
19.3	Using Oracle Flashback Query (SELECT AS OF)	19-7
19.3.1	Example: Examining and Restoring Past Data	19-7
19.3.2	Guidelines for Oracle Flashback Query	19-8
19.4	Using Oracle Flashback Version Query.....	19-9
19.5	Using Oracle Flashback Transaction Query	19-11
19.6	Using Oracle Flashback Transaction Query with Oracle Flashback Version Query	19-12
19.7	Using DBMS_FLASHBACK Package	19-14
19.8	Using Flashback Transaction	19-15
19.8.1	Dependent Transactions.....	19-16
19.8.2	TRANSACTION_BACKOUT Parameters	19-16
19.8.3	TRANSACTION_BACKOUT Reports	19-17
19.9	Using Flashback Data Archive.....	19-18
19.9.1	Creating a Flashback Data Archive	19-19
19.9.2	Altering a Flashback Data Archive	19-20
19.9.3	Dropping a Flashback Data Archive	19-21
19.9.4	Specifying the Default Flashback Data Archive	19-21
19.9.5	Enabling and Disabling Flashback Data Archive	19-22
19.9.6	DDL Statements on Tables Enabled for Flashback Data Archive	19-23
19.9.7	Viewing Flashback Data Archive Data	19-24
19.9.8	Flashback Data Archive Scenarios	19-25
19.10	General Guidelines for Oracle Flashback Technology	19-27
19.11	Performance Guidelines for Oracle Flashback Technology	19-29
19.12	Multitenant Container Database Restrictions for Oracle Flashback Technology.....	19-29

20 Choosing a Programming Environment

20.1	Overview of Application Architecture	20-2
20.1.1	Client/Server Architecture	20-2

20.1.2	Server-Side Programming.....	20-2
20.1.3	Two-Tier and Three-Tier Architecture.....	20-2
20.2	Overview of the Program Interface.....	20-3
20.2.1	User Interface.....	20-3
20.2.2	Stateful and Stateless User Interfaces.....	20-3
20.3	Overview of PL/SQL.....	20-4
20.4	Overview of Oracle Database Java Support.....	20-4
20.4.1	Overview of Oracle JVM.....	20-5
20.4.2	Overview of Oracle JDBC.....	20-6
20.4.3	Overview of Oracle SQLJ.....	20-9
20.4.4	Comparison of Oracle JDBC and Oracle SQLJ.....	20-11
20.4.5	Overview of Java Stored Subprograms.....	20-12
20.4.6	Overview of Oracle Database Web Services.....	20-12
20.5	Choosing PL/SQL or Java.....	20-13
20.5.1	Similarities of PL/SQL and Java.....	20-14
20.5.2	PL/SQL Advantages Over Java.....	20-14
20.5.3	Java Advantages Over PL/SQL.....	20-15
20.6	Overview of Precompilers.....	20-15
20.6.1	Overview of the Pro*C/C++ Precompiler.....	20-15
20.6.2	Overview of the Pro*COBOL Precompiler.....	20-18
20.7	Overview of OCI and OCCI.....	20-19
20.7.1	Advantages of OCI and OCCI.....	20-20
20.7.2	OCI and OCCI Functions.....	20-21
20.7.3	Procedural and Nonprocedural Elements of OCI and OCCI Applications.....	20-21
20.7.4	Building an OCI or OCCI Application.....	20-22
20.8	Comparison of Precompilers and OCI.....	20-22
20.9	Overview of Oracle Data Provider for .NET (ODP.NET).....	20-23
20.10	Overview of OraOLEDB.....	20-24

21 Developing Applications with Multiple Programming Languages

21.1	Overview of Multilanguage Programs.....	21-1
21.2	What Is an External Procedure?.....	21-3
21.3	Overview of Call Specification for External Procedures.....	21-3
21.4	Loading External Procedures.....	21-4
21.4.1	Define the C Procedures.....	21-5
21.4.2	Set Up the Environment.....	21-6
21.4.3	Identify the DLL.....	21-8
21.4.4	Publish the External Procedures.....	21-9
21.5	Publishing External Procedures.....	21-9
21.5.1	AS LANGUAGE Clause for Java Class Methods.....	21-10
21.5.2	AS LANGUAGE Clause for External C Procedures.....	21-11
21.6	Publishing Java Class Methods.....	21-12
21.7	Publishing External C Procedures.....	21-13

21.8	Locations of Call Specifications	21-13
21.8.1	Example: Locating a Call Specification in a PL/SQL Package	21-14
21.8.2	Example: Locating a Call Specification in a PL/SQL Package Body	21-14
21.8.3	Example: Locating a Call Specification in an ADT Specification	21-14
21.8.4	Example: Locating a Call Specification in an ADT Body	21-15
21.8.5	Example: Java with AUTHID	21-15
21.8.6	Example: C with Optional AUTHID	21-15
21.8.7	Example: Mixing Call Specifications in a Package	21-15
21.9	Passing Parameters to External C Procedures with Call Specifications	21-16
21.9.1	Specifying Data Types	21-17
21.9.2	External Data Type Mappings	21-19
21.9.3	Passing Parameters BY VALUE or BY REFERENCE	21-22
21.9.4	Declaring Formal Parameters	21-22
21.9.5	Overriding Default Data Type Mapping	21-23
21.9.6	Specifying Properties	21-23
21.10	Running External Procedures with CALL Statements	21-30
21.10.1	Preconditions for External Procedures	21-31
21.10.2	CALL Statement Syntax	21-32
21.10.3	Calling Java Class Methods	21-32
21.10.4	Calling External C Procedures	21-33
21.11	Handling Errors and Exceptions in Multilanguage Programs	21-33
21.12	Using Service Routines with External C Procedures	21-34
21.12.1	OCIExtProcAllocCallMemory	21-34
21.12.2	OCIExtProcRaiseExcp	21-38
21.12.3	OCIExtProcRaiseExcpWithMsg	21-39
21.13	Doing Callbacks with External C Procedures	21-40
21.13.1	OCIExtProcGetEnv	21-40
21.13.2	Object Support for OCI Callbacks	21-42
21.13.3	Restrictions on Callbacks	21-42
21.13.4	Debugging External C Procedures	21-43
21.13.5	Example: Calling an External C Procedure	21-44
21.13.6	Global Variables in External C Procedures	21-44
21.13.7	Static Variables in External C Procedures	21-44
21.13.8	Restrictions on External C Procedures	21-45

22 Developing Applications with Oracle XA

22.1	X/Open Distributed Transaction Processing (DTP)	22-2
22.1.1	DTP Terminology	22-3
22.1.2	Required Public Information	22-5
22.2	Oracle XA Library Subprograms	22-6
22.2.1	Oracle XA Library Subprograms	22-6
22.2.2	Oracle XA Interface Extensions	22-7
22.3	Developing and Installing XA Applications	22-8

22.3.1	DBA or System Administrator Responsibilities	22-8
22.3.2	Application Developer Responsibilities.....	22-9
22.3.3	Defining the xa_open String	22-9
22.3.4	Using Oracle XA with Precompilers.....	22-13
22.3.5	Using Oracle XA with OCI.....	22-15
22.3.6	Managing Transaction Control with Oracle XA	22-15
22.3.7	Examples of Precompiler Applications.....	22-16
22.3.8	Migrating Precompiler or OCI Applications to TPM Applications	22-17
22.3.9	Managing Oracle XA Library Thread Safety	22-18
22.3.10	Using the DBMS_XA Package	22-19
22.4	Troubleshooting XA Applications	22-21
22.4.1	Accessing Oracle XA Trace Files	22-22
22.4.2	Managing In-Doubt or Pending Oracle XA Transactions	22-23
22.4.3	Using SYS Account Tables to Monitor Oracle XA Transactions	22-23
22.5	Oracle XA Issues and Restrictions.....	22-24
22.5.1	Using Database Links in Oracle XA Applications.....	22-24
22.5.2	Managing Transaction Branches in Oracle XA Applications	22-25
22.5.3	Using Oracle XA with Oracle Real Application Clusters (Oracle RAC)	22-25
22.5.4	SQL-Based Oracle XA Restrictions	22-29
22.5.5	Miscellaneous Restrictions	22-30

23 Developing Applications with the Publish-Subscribe Model

23.1	Introduction to the Publish-Subscribe Model.....	23-1
23.2	Publish-Subscribe Architecture	23-2
23.2.1	Database Events.....	23-2
23.2.2	Oracle Advanced Queuing	23-2
23.2.3	Client Notification.....	23-3
23.3	Publish-Subscribe Concepts	23-3
23.4	Examples of a Publish-Subscribe Mechanism	23-5

24 Using the Oracle ODBC Driver

24.1	About Oracle ODBC Driver	24-1
24.2	For All Users.....	24-2
24.2.1	Oracle ODBC Driver	24-2
24.2.2	Configuration Tasks.....	24-11
24.2.3	Modifying the oraodbc.ini File	24-21
24.2.4	Connecting to a Data Source.....	24-21
24.2.5	Troubleshooting.....	24-22
24.3	For Advanced Users	24-22
24.3.1	Creating Oracle ODBC Driver TNS Service Names.....	24-22
24.3.2	SQL Statements.....	24-23
24.3.3	Data Types.....	24-23
24.3.4	Implementation of Data Types (Advanced).....	24-23

24.3.5	Limitations on Data Types	24-24
24.3.6	Error Messages.....	24-24
24.4	For Programmers	24-26
24.4.1	Format of the Connection String.....	24-26
24.4.2	SQLDriverConnect Implementation.....	24-29
24.4.3	Reducing Lock Timeout in a Program	24-29
24.4.4	Linking with odbc32.lib (Windows) or libodbc.so (UNIX).....	24-29
24.4.5	Information About rowids	24-30
24.4.6	Rowids in a WHERE Clause	24-30
24.4.7	Enabling Result Sets.....	24-30
24.4.8	Enabling EXEC Syntax.....	24-35
24.4.9	Enabling Event Notification for Connection Failures in an Oracle RAC Environment.....	24-36
24.4.10	Using Implicit Results Feature Through ODBC	24-40
24.4.11	About Supporting Oracle TIMESTAMP WITH TIME ZONE and TIMESTAMP WITH LOCAL TIME ZONE Column Type in ODBC	24-41
24.4.12	About the Effect of Setting ORA_SDTZ in Oracle Clients (OCI, SQL*Plus, Oracle ODBC driver, and Others).....	24-43
24.4.13	Supported Functionality.....	24-46
24.4.14	Unicode Support.....	24-47
24.4.15	Performance and Tuning.....	24-54
25	Using the Identity Code Package	
25.1	Identity Concepts.....	25-1
25.2	What Is the Identity Code Package?	25-5
25.3	Using the Identity Code Package	25-6
25.3.1	Storing RFID Tags in Oracle Database Using MGD_ID ADT	25-6
25.3.2	Building a Function-Based Index Using the Member Functions of the MGD_ID Column Type.....	25-10
25.3.3	Using MGD_ID ADT Functions	25-11
25.3.4	Defining a Category of Identity Codes and Adding Encoding Schemes to an Existing Category.....	25-14
25.4	Identity Code Package Types.....	25-18
25.5	DBMS_MGD_ID_UTL Package	25-19
25.6	Identity Code Metadata Tables and Views	25-20
25.7	Electronic Product Code (EPC) Concepts	25-22
25.7.1	RFID Technology and EPC v1.1 Coding Schemes.....	25-23
25.7.2	Product Code Concepts and Their Current Use	25-23
25.8	Oracle Database Tag Data Translation Schema.....	25-26
26	Understanding Schema Object Dependency	
26.1	Overview of Schema Object Dependency	26-1
26.1.1	Example: Displaying Dependent and Referenced Object Types.....	26-1

26.1.2	Example: Schema Object Change that Invalidates Some Dependents	26-3
26.1.3	Example: View That Depends on Multiple Objects	26-4
26.2	Querying Object Dependencies	26-4
26.3	Object Status	26-4
26.4	Invalidation of Dependent Objects	26-5
26.4.1	Session State and Referenced Packages	26-9
26.4.2	Security Authorization	26-9
26.5	Guidelines for Reducing Invalidation	26-9
26.5.1	Add Items to End of Package	26-9
26.5.2	Reference Each Table Through a View	26-10
26.6	Object Revalidation	26-10
26.6.1	Revalidation of Objects that Compiled with Errors	26-10
26.6.2	Revalidation of Unauthorized Objects	26-10
26.6.3	Revalidation of Invalid SQL Objects	26-10
26.6.4	Revalidation of Invalid PL/SQL Objects	26-11
26.7	Name Resolution in Schema Scope	26-11
26.8	Local Dependency Management	26-12
26.9	Remote Dependency Management	26-12
26.9.1	Dependencies Among Local and Remote Database Procedures.....	26-12
26.9.2	Dependencies Among Other Remote Objects.....	26-13
26.9.3	Dependencies of Applications.....	26-13
26.10	Remote Procedure Call (RPC) Dependency Management	26-13
26.10.1	Time-Stamp Dependency Mode	26-14
26.10.2	RPC-Signature Dependency Mode	26-15
26.10.3	Controlling Dependency Mode.....	26-19
26.11	Shared SQL Dependency Management.....	26-21

27 Using Edition-Based Redefinition

27.1	Overview of Edition-Based Redefinition	27-1
27.2	Editions.....	27-2
27.2.1	Editioned and Noneditioned Objects	27-2
27.2.2	Creating an Edition	27-10
27.2.3	Editioned Objects and Copy-on-Change	27-11
27.2.4	Making an Edition Available to Some Users.....	27-15
27.2.5	Making an Edition Available to All Users	27-15
27.2.6	Current Edition and Session Edition	27-16
27.2.7	Retiring an Edition	27-20
27.2.8	Dropping an Edition	27-20
27.3	Editioning Views.....	27-22
27.3.1	Creating an Editioning View	27-23
27.3.2	Partition-Extended Editioning View Names.....	27-24
27.3.3	Changing the Writability of an Editioning View	27-24
27.3.4	Replacing an Editioning View	27-24

27.3.5	Dropped or Renamed Base Tables.....	27-24
27.3.6	Adding Indexes and Constraints to the Base Table	27-24
27.3.7	SQL Optimizer Index Hints	27-25
27.4	Crossedition Triggers.....	27-25
27.4.1	Forward Crossedition Triggers	27-26
27.4.2	Reverse Crossedition Triggers.....	27-26
27.4.3	Crossedition Trigger Interaction with Editions	27-26
27.4.4	Creating a Crossedition Trigger.....	27-30
27.4.5	Transforming Data from Pre- to Post-Upgrade Representation	27-33
27.4.6	Dropping the Crossedition Triggers.....	27-35
27.5	Displaying Information About EBR Features.....	27-36
27.5.1	Displaying Information About Editions	27-36
27.5.2	Displaying Information About Editioning Views	27-37
27.5.3	Displaying Information About Crossedition Triggers.....	27-38
27.6	Using EBR to Upgrade an Application.....	27-38
27.6.1	Preparing Your Application to Use Editioning Views	27-39
27.6.2	Procedure for EBR Using Only Editions	27-40
27.6.3	Procedure for EBR Using Editioning Views.....	27-42
27.6.4	Procedure for EBR Using Crossedition Triggers	27-43
27.6.5	Rolling Back the Application Upgrade	27-44
27.6.6	Reclaiming Space Occupied by Unused Table Columns	27-45
27.6.7	Example: Using EBR to Upgrade an Application.....	27-45

28 Using Transaction Guard

28.1	Problem That Transaction Guard Solves.....	28-2
28.2	Solution That Transaction Guard Provides	28-2
28.3	Transaction Guard Concepts and Scope	28-3
28.3.1	Logical Transaction Identifier (LTXID).....	28-4
28.3.2	At-Most-Once Execution	28-4
28.3.3	Transaction Guard Coverage.....	28-5
28.3.4	Transaction Guard with XA Transactions	28-6
28.3.5	Transaction Guard Exclusions.....	28-6
28.4	Database Configuration for Transaction Guard.....	28-7
28.4.1	Configuration Checklist	28-7
28.4.2	Transaction History Table.....	28-8
28.4.3	Service Parameters	28-8
28.5	Developing Applications That Use Transaction Guard.....	28-10
28.5.1	Typical Transaction Guard Usage	28-10
28.5.2	Details for Using the LTXID	28-11
28.5.3	Transaction Guard and Transparent Application Failover.....	28-12
28.5.4	Using Transaction Guard with ODP.NET	28-12
28.5.5	Connection-Pool LTXID Usage	28-13
28.5.6	Improved Commit Outcome for XA One Phase Optimizations	28-13

28.5.7 Additional Requirements for Transaction Guard Development.....	28-14
28.6 Transaction Guard and Its Relationship to Application Continuity.....	28-14

Index

List of Tables

3-1	Table Annotation Result Cache Modes.....	3-15
3-2	Effective Result Cache Table Mode.....	3-16
3-3	Client Configuration Parameters (Optional).....	3-20
3-4	Setting Client Result Cache and Server Result Cache.....	3-23
3-5	Session Purity and Connection Class Defaults.....	3-32
8-1	COMMIT Statement Options.....	8-6
8-2	Examples of Concurrency Under Explicit Locking.....	8-20
8-3	Ways to Display Locking Information.....	8-29
8-4	ANSI/ISO SQL Isolation Levels and Possible Transaction Interactions.....	8-30
8-5	ANSI/ISO SQL Isolation Levels Provided by Oracle Database.....	8-31
8-6	Comparison of READ COMMITTED and SERIALIZABLE Transactions.....	8-36
8-7	Possible Transaction Outcomes.....	8-41
9-1	SQL Character Data Types.....	9-6
9-2	Range and Precision of Floating-Point Data Types.....	9-9
9-3	Binary Floating-Point Format Components.....	9-9
9-4	Summary of Binary Format Storage Parameters.....	9-10
9-5	Special Values for Native Floating-Point Formats.....	9-10
9-6	Values Resulting from Exceptions.....	9-12
9-7	SQL Datetime Data Types.....	9-13
9-8	SQL Conversion Functions for Datetime Data Types.....	9-19
9-9	Large Objects (LOBs).....	9-20
9-10	Display Types of SQL Functions.....	9-27
9-11	SQL Data Type Families.....	9-28
10-1	Oracle SQL Pattern-Matching Condition and Functions.....	10-2
10-2	Oracle SQL Pattern-Matching Options for Condition and Functions.....	10-3
10-3	POSIX Operators in Oracle SQL Regular Expressions.....	10-5
10-4	POSIX Operators and Multilingual Operator Relationships.....	10-9
10-5	PERL-Influenced Operators in Oracle SQL Regular Expressions.....	10-10
10-6	Explanation of the Regular Expression Elements.....	10-12
10-7	Explanation of the Regular Expression Elements.....	10-13
14-1	Identifier Types that PL/Scope Collects.....	14-5
14-2	Usages that PL/Scope Reports.....	14-7
15-1	Raw Profiler Output File Indicators.....	15-5
15-2	Function Names of Operations that the PL/SQL Hierarchical Profiler Tracks.....	15-7
15-3	PL/SQL Hierarchical Profiler Database Tables.....	15-7
15-4	DBMSHP_RUNS Table Columns.....	15-9
15-5	DBMSHP_FUNCTION_INFO Table Columns.....	15-10
15-6	DBMSHP_PARENT_CHILD_INFO Table Columns.....	15-11
16-1	DBMSPCC_RUNS Table Columns.....	16-3
16-2	DBMSPCC_UNITS Table Columns.....	16-3
16-3	DBMSPCC_BLOCKS Table Columns.....	16-4
17-1	Commonly Used Packages in the PL/SQL Web Toolkit.....	17-3
17-2	Mapping Between mod_plsql and Embedded PL/SQL Gateway DAD Attributes.....	17-7
17-3	Mapping Between mod_plsql and Embedded PL/SQL Gateway Global Attributes.....	17-9
17-4	Authentication Possibilities for a DAD.....	17-13
18-1	Continuous Query Notification Registration Options.....	18-11
18-2	Attributes of CQ_NOTIFICATION\$_REG_INFO.....	18-21
18-3	Quality-of-Service Flags.....	18-23
18-4	Attributes of CQ_NOTIFICATION\$_DESCRIPTOR.....	18-48
18-5	Attributes of CQ_NOTIFICATION\$_TABLE.....	18-49
18-6	Attributes of CQ_NOTIFICATION\$_QUERY.....	18-50

18-7	Attributes of CQ_NOTIFICATION\$_ROW.....	18-50
19-1	Oracle Flashback Version Query Row Data Pseudocolumns.....	19-10
19-2	Flashback TRANSACTION_BACKOUT Options.....	19-17
19-3	Static Data Dictionary Views for Flashback Data Archive Files.....	19-24
20-1	PL/SQL Packages and Their Java Equivalents.....	20-13
21-1	Parameter Data Type Mappings.....	21-17
21-2	External Data Type Mappings.....	21-19
21-3	Properties and Data Types.....	21-24
22-1	Required XA Features Published by Oracle Database.....	22-6
22-2	XA Library Subprograms.....	22-7
22-3	Oracle XA Interface Extensions.....	22-7
22-4	Required Fields of xa_open string.....	22-10
22-5	Optional Fields in the xa_open String.....	22-11
22-6	TX Interface Functions.....	22-15
22-7	TPM Replacement Statements.....	22-18
22-8	Sample Trace File Contents.....	22-22
22-9	Tightly and Loosely Coupled Transaction Branches.....	22-25
24-1	Files Installed by the Oracle ODBC Driver Kit.....	24-10
24-2	Oracle ODBC Driver and Oracle Database Limitations on Data Types.....	24-24
24-3	Error Message Values of Prefixes Returned by the Oracle ODBC Driver.....	24-25
24-4	Keywords that Can Be Included in the Connection String Argument of the SQLDriverConnect Function Call.....	24-26
24-5	Keywords Required by the SQLDriverConnect Connection String.....	24-29
24-6	How Oracle ODBC Driver Implements Specific Functions.....	24-46
24-7	Supported SQL Data Types and the Equivalent ODBC SQL Data Type.....	24-48
25-1	General Structure of EPC Encodings.....	25-2
25-2	Identity Code Package ADTs.....	25-18
25-3	MGD_ID ADT Subprograms.....	25-19
25-4	DBMS_MGD_ID_UTL Package Utility Subprograms.....	25-19
25-5	Definition and Description of the MGD_ID_CATEGORY Metadata View.....	25-21
25-6	Definition and Description of the USER_MGD_ID_CATEGORY Metadata View.....	25-21
25-7	Definition and Description of the MGD_ID_SCHEME Metadata View.....	25-21
25-8	Definition and Description of the USER_MGD_ID_SCHEME Metadata View.....	25-22
26-1	Database Object Status.....	26-4
26-2	Operations that Cause Fine-Grained Invalidation.....	26-6
26-3	Data Type Classes.....	26-17
27-1	*_ Dictionary Views with Edition Information.....	27-36
27-2	*_ Dictionary Views with Editioning View Information.....	27-37
28-1	LTXID Condition or Situation, Application Actions, and Next LTXID to Use.....	28-11
28-2	Transaction Manager Conditions/ Situations and Actions.....	28-13

Preface

Oracle Database Development Guide explains topics of interest to experienced developers of databases and database applications. Information in this guide applies to features that work the same on all supported platforms, and does not include system-specific information.

Preface Topics:

Audience

This guide is intended primarily for application developers who are either developing applications or converting applications to run in the Oracle Database environment. This guide might also help anyone interested in database or database application development, such as systems analysts and project managers.

This guide assumes that you are familiar with the concepts and techniques in the "2 Day" guides relevant to your job, such as *Oracle Database 2 Day Developer's Guide* and *Oracle Database 2 Day DBA*. To use this guide most effectively, you also need a working knowledge of:

- Structured Query Language (SQL)
- Object-oriented programming

Documentation Accessibility

For information about Oracle's commitment to accessibility, visit the Oracle Accessibility Program website at <http://www.oracle.com/pls/topic/lookup?ctx=acc&id=docacc>.

Access to Oracle Support

Oracle customers that have purchased support have access to electronic support through My Oracle Support. For information, visit <http://www.oracle.com/pls/topic/lookup?ctx=acc&id=info> or visit <http://www.oracle.com/pls/topic/lookup?ctx=acc&id=trs> if you are hearing impaired.

Related Documents

For more information, see these documents in the Oracle Database 12c Release 2 (12.2) documentation set:

- *Oracle Database PL/SQL Language Reference*

- *Oracle Call Interface Programmer's Guide*
- *Oracle Database Security Guide*
- *Pro*C/C++ Programmer's Guide*
- *Oracle Database SQL Language Reference*
- *Oracle Database Administrator's Guide*
- *Oracle Database Concepts*
- *Oracle Database Java Developer's Guide*
- *Oracle Database JDBC Developer's Guide*
- *Oracle XML Developer's Kit Programmer's Guide*
- *Oracle XML DB Developer's Guide*
- *Oracle Database Migration Guide*
- *Oracle Database Globalization Support Guide*
- *Oracle Database Sample Schemas*

See Also:

- *Oracle PL/SQL Programming* by Steven Feuerstein, Bill Pribyl. Sixth Edition. O'Reilly & Associates, 2014.
 - *Oracle PL/SQL Best Practices* by Steven Feuerstein. Second Edition. O'Reilly & Associates, 2007.
-
-

Conventions

This guide uses these text conventions:

Convention	Meaning
boldface	Boldface type indicates graphical user interface elements associated with an action, or terms defined in text or the glossary.
<i>italic</i>	Italic type indicates book titles, emphasis, or placeholder variables for which you supply particular values.
monospace	Monospace type indicates commands within a paragraph, URLs, code in examples, text that appears on the screen, or text that you enter.

Also:

- **_view* means all static data dictionary views whose names end with *view*. For example, **_ERRORS* means *ALL_ERRORS*, *DBA_ERRORS*, and *USER_ERRORS*. For more information about any static data dictionary view, or about static dictionary views in general, see *Oracle Database Reference*.

- Table names not qualified with schema names are in the sample schema HR. For information about the sample schemas, see *Oracle Database Sample Schemas*.

Changes in Oracle Database 12c Release 2 (12.2)

The following are changes in *Oracle Database Development Guide* for Oracle Database 12c Release 2 (12.2):

New Features

- Dropping an edition has been enhanced to postpone dropping each editioned object it contains until after the object is no longer inherited by a usable descendent edition.
See : [Dropping an Edition](#) (page 27-20)
- The PL/SQL Basic Block Coverage feature helps you insure some quality predictability and consistency by assessing how well your tests actually test your code. See : [Using PL/SQL Basic Block Coverage to Maintain Quality](#) (page 16-1)
- PL/Scope reports on SQL Identifier and Statement metadata for SQL statements, tables, views and sequences appearing in PL/SQL source code.
See : [Using PL/Scope](#) (page 14-1)
- PL/SQL `DEPRECATE` pragma, See: [Deprecating Packages, Subprograms, and Types](#) (page 13-20)
- Sharding is the ability to partition data horizontally across independent databases. Each database in this configuration is called a shard. All the shards together make up a single logical database that is called a sharded database. See : *Oracle Database Administrator's Guide* for more information about developing applications in a sharded database.
- Added new `MAX_TXN_THINK_TIME` parameter to configure DRCP. See [Configuring DRCP](#) (page 3-28) for more information.
- Support for sharing proxy sessions in DRCP with other applications. See [Sharing Proxy Sessions](#) (page 3-29) for more information.
- Support for shared connections in both PDB and non-PDB environments using DRCP. See [About Database Resident Connection Pool](#) (page 3-27) for more information.
- Support for receiving FAN event notifications. See [About Receiving FAN Event Notifications](#) (page 6-4) for more information.

- Transaction Guard support for Oracle XA Transactions. See [Using Transaction Guard](#) (page 28-1) for more information about Transaction Guard.

Deprecated Features

The following features are deprecated in this release, and may be desupported in a future release:

- Oracle SQL Extensions (oracle.sql.*) are deprecated in favor of standard Java classes or oracle.jdbc extension types.
- The DBMS_DEBUG package is deprecated. Use DBMS_DEBUG_JDWP package instead.
See [Debugging PL/SQL and Java](#) (page 13-37) for more information.

Desupported Features

Some features previously described in this document are desupported in Oracle Database 12c Release 2 (12.2).

- Desupport of server-side SQLJ and JPublisher.

Part I

Database Development Fundamentals

This part presents fundamental information for developers of Oracle Database and database applications. The chapters in this part cover mainly high-level concepts, and refer to other chapters and manuals for detailed feature explanations and implementation specifics.

Related links:

- *Oracle Database 2 Day Developer's Guide* and *Oracle Database 2 Day DBA* form more information on Oracle Database concepts and techniques.
 - <http://asktom.oracle.com> for books and articles about Oracle database concepts by Tom Kyte
-
-

Chapters:

- [Design Basics](#) (page 1-1)
- [Performance and Scalability](#) (page 3-1)
- [Security](#) (page 5-1)
- [High Availability](#) (page 6-1)
- [Advanced PL/SQL Features](#) (page 7-1)

Design Basics

This chapter explains several important design goals for database developers.

See Also:

- [Database Development Fundamentals](#) (page 1) for high-level database concepts
 - *Oracle Database 2 Day Developer's Guide* and *Oracle Database 2 Day DBA* form more information on Oracle Database concepts and techniques.
-

This chapter contains the following topics:

- [Design for Performance](#) (page 1-1)
- [Design for Scalability](#) (page 1-2)
- [Design for Extensibility](#) (page 1-2)
- [Design for Security](#) (page 1-4)
- [Design for Availability](#) (page 1-5)
- [Design for Portability](#) (page 1-5)
- [Design for Diagnosability](#) (page 1-6)
- [Design for Special Environments](#) (page 1-6)
- [Features for Special Scenarios](#) (page 1-8)

1.1 Design for Performance

The key to database and application performance is design, not tuning. While tuning is quite valuable, it cannot make up for poor design. Your design must start with an efficient data model, well-defined performance goals and metrics, and a sensible benchmarking strategy. Otherwise, you will encounter problems during implementation, when no amount of tuning will produce the results that you could have obtained with good design. You might have to redesign the system later, despite having tuned the original poor design.

See Also:

- [Performance and Scalability](#) (page 3-1) for an overview of designing databases and applications for performance.
 - *Oracle Database Performance Tuning Guide* and *Oracle Database SQL Tuning Guide* for more information on performance tuning.
-
-

1.2 Design for Scalability

Scalability is the ability of a system to perform well as its load increases. Load is a combination of number of data volumes, number of users, and other relevant factors. To design for scalability, you must use an effective benchmarking strategy, appropriate application development techniques (such as bind variables), and appropriate Oracle Database architectural features like shared server connections, clustering, partitioning, and parallel operations.

See Also:

[Performance and Scalability](#) (page 3-1) and *Oracle Database 2 Day Developer's Guide* for more information about scalability.

1.3 Design for Extensibility

Extensibility is the ease with which a database or database application accommodates future growth. The more extensible the database or application, the easier it is to add or change functionality with minimal impact on existing functionality.

Note:

Extensibility differs from **forward compatibility**, the ability of an application to accept data from a future version of itself and use only the data that it was designed to accept.

For example, suppose that an early version of an application processes only text and a later version of the same application processes both text and graphics. If the early version can accept both text and graphics, and ignore the graphics and process the text, then it is forward-compatible. If the early version can be upgraded to process both text and graphics, then it is extensible. The easier it is to upgrade the application, the more extensible it is.

To maximize extensibility, you must design it into your database and applications by including mechanisms that allow enhancement without major changes to infrastructure. Early versions of the database or application might not use these mechanisms, and perhaps no version will ever use all of them, but they are essential to easy maintenance and avoiding early obsolescence.

Topics:

- [Data Cartridges](#) (page 1-3)
- [External Procedures](#) (page 1-3)

- [User-Defined Functions and Aggregate Functions](#) (page 1-3)
- [Object-Relational Features](#) (page 1-4)

1.3.1 Data Cartridges

Data cartridges extend the capabilities of the Oracle Database server by taking advantage of Oracle Extensibility Architecture framework. This framework lets you capture business logic and processes associated with specialized or domain-specific data in user-defined data types. Data cartridges that provide new behavior without using additional attributes can do so with packages rather than user-defined data types. With either user-defined types or packages, you determine how the server interprets, stores, retrieves, and indexes the application data. Data cartridges package this functionality, creating software components that plug into a server and extend its capabilities into a new domain, making the database itself extensible.

You can customize the indexing and query optimization mechanisms of an extensible database management system and provide specialized services or more efficient processing for user-defined business objects and rich types. When you register your implementations with the server through extensibility interfaces, you direct the server to implement your customized processing instructions instead of its own default processes.

See Also:

Oracle Database Data Cartridge Developer's Guide for more information about data cartridges

1.3.2 External Procedures

External procedures are highly extensible because you can enhance their functionality without affecting their invokers. The reason is that the call specification of an external procedure, which has all the information needed to invoke it, is separate from the body of the procedure, which has the implementation details. If you change only the body, and not the specification, then invokers are unaffected.

See Also:

[Developing Applications with Multiple Programming Languages](#) (page 21-1), for more information about external procedures

1.3.3 User-Defined Functions and Aggregate Functions

User-defined PL/SQL functions that can appear in SQL statements or expressions can extend the functionality of SQL.

User-defined aggregate functions are part of the Oracle Extensibility Architecture framework.

See Also:

- [Invoking Stored PL/SQL Functions from SQL Statements](#) (page 13-28) for information about invoking user-defined PL/SQL functions in SQL statements and expressions
 - *Oracle Database Data Cartridge Developer's Guide* for information about user-defined aggregate functions
-

1.3.4 Object-Relational Features

The object relational features of Oracle Database are the user-defined Abstract Data Types (ADTs). ADTs are highly extensible because you can enhance their functionality without affecting their invokers. The reason is that the call specification of an external procedure, which has all the information needed to invoke it, is separate from the body of the procedure, which has the implementation details. If you change only the body, and not the specification, then invokers are unaffected.

See Also:

- *Oracle Database PL/SQL Language Reference* for information about the CREATE TYPE statement
 - *Oracle Database PL/SQL Language Reference* for information about the CREATE TYPE BODY statement
 - *Oracle Database Object-Relational Developer's Guide* for more information about object relational features
-

1.4 Design for Security

Database security involves a wide range of potential activities, including:

- Designing and implementing security policies to protect the data of an organization, users, and applications from accidental, inappropriate, or unauthorized actions
- Creating and enforcing policies and practices of auditing and accountability for inappropriate or unauthorized actions
- Creating, maintaining, and terminating user accounts, passwords, roles, and privileges
- Developing applications that provide desired services securely in a variety of computational models, leveraging database and directory services to maximize both efficiency and ease of use

See Also:

- *Oracle Database Security Guide* for more information about security.
 - [Security](#) (page 5-1) for information about considerations and techniques for providing security.
-

1.5 Design for Availability

Availability is the degree to which an application, service, or function is accessible on demand. A system designed for high availability provides uninterrupted computing services during essential time periods, during most hours of the day throughout the year, with minimal downtime for operations such as upgrading the system's hardware or software. The main characteristics of a highly available system are:

- Reliability
- Recoverability
- Timely error detection
- Continuous operation

See Also:

- [High Availability](#) (page 6-1) for information about important considerations and techniques for providing high availability.
 - *Oracle Database High Availability Overview* and other manuals in the High Availability group in the Oracle Database documentation library.
-

1.6 Design for Portability

While PL/SQL is not designed for portability between Oracle Database and third-party databases, it is highly portable across operating systems and languages. Most programming languages can invoke PL/SQL, and PL/SQL is implemented consistently on every platform that supports Oracle Database, including Macintosh, Linux, and Windows. If you develop PL/SQL applications on one platform, you can be highly confident that they will work consistently on all other platforms.

PL/SQL stored procedures provide some application portability across multiple databases. Although using stored procedures written in the language of a given vendor may seem to tie you to that vendor to some extent, stored procedures make the application's visual component (user interface) and application logic portable. The data logic is encoded optimally for the database on which the application runs. Because the data logic is hidden in stored procedures, you can use the vendor's extensions and features to optimize the data layer.

When developed and deployed on a database, the application can stay deployed on that database forever. If the application is moved to another database, the visual component and application logic can move independently of the data logic in the stored procedures, which simplifies the move. (Reworking the application in combination with the move complicates the move.)

See Also:

Oracle Database PL/SQL Language Reference for conceptual, usage, and reference information about PL/SQL

1.7 Design for Diagnosability

Oracle Database includes a fault diagnosability infrastructure for preventing, detecting, diagnosing, and resolving database problems. Problems include critical errors such as code bugs, metadata corruption, and customer data corruption. The goals of the diagnosability infrastructure are to detect problems proactively, limit damage and interruptions after a problem is detected, reduce the time required to diagnose and resolve problems, and simplify any possible interaction with Oracle Support.

Automatic Diagnostic Repository (ADR) is a file-based repository that stores database diagnostic data such as trace files, the alert log, and Health Monitor reports. ADR is located outside the database, which enables Oracle Database to access and manage ADR when the physical database is unavailable.

See Also:

- *Oracle Database Concepts* for an overview of diagnostic files
 - *Oracle Database Administrator's Guide* for detailed information about the Oracle Database fault diagnosability infrastructure.
-
-

1.8 Design for Special Environments

This topic introduces designing for the following special database and application environments:

- [Data Warehousing](#) (page 1-6)
- [Online Transaction Processing \(OLTP\)](#) (page 1-7)

1.8.1 Data Warehousing

A data warehouse is a relational database that is designed for query and analysis rather than for transaction processing. It usually contains historical data derived from transaction data, but can include data from other sources. Data warehouses separate analysis workload from transaction workload and enable an organization to consolidate data from several sources. This strategy helps the organization maintain historical records and analyze the data to better understand and improve its business.

In addition to a relational database, a data warehouse environment can include:

- An extraction, transportation, transformation, and loading (ETL) solution
- Statistical analysis
- Reporting
- Data mining capabilities
- Client analysis tools
- Applications that manage the process of gathering data; transforming it into useful, actionable information; and delivering it to business users

Data warehousing systems typically:

- Use many indexes
 - Use some (but not many) joins
 - Use denormalized or partially denormalized schemas (such as a star schema) to optimize query and analytical performance
 - Use derived data and aggregates
 - Have workloads designed to accommodate ad hoc queries and data analysis
- Because you might not know the workload of your data warehouse in advance, you must optimize the data warehouse to perform well for a wide variety of possible query and analytical operations.

- Are updated regularly (nightly or weekly) by the ETL process, using bulk data modification techniques

The end users of a data warehouse do not directly update the data warehouse except when using analytical tools (such as data mining) to make predictions with associated probabilities, assign customers to market segments, and develop customer profiles.

See Also:

Oracle Database Data Warehousing Guide for information about data warehousing, including a comparison with online transaction processing (OLTP)

1.8.2 Online Transaction Processing (OLTP)

Online transaction processing (OLTP) systems are optimized for fast and reliable transaction handling. Compared to data warehouse systems, most OLTP interactions involve a relatively small number of rows, but a larger group of tables. In OLTP systems, performance requirements require that historical data be frequently moved to an archive.

OLTP systems typically:

- Use few indexes.
- Use many joins.
- Use fully normalized schemas to optimize update, insert, and delete performance, and to guarantee data consistency.
- Rarely use derived data and aggregates.
- Have workloads consisting of predefined operations.
- Have users routinely issuing individual data modification statements to the database, so that the OLTP database always reflects the current state of each transaction.

See Also:

See *Oracle Database Concepts* for more information, including links to manuals with detailed information

1.9 Features for Special Scenarios

This topic introduces Oracle Database features that are particularly useful in scenarios that involve very large databases and the need for high performance.

Topics:

- [SQL Analytic Functions](#) (page 1-8)
- [Materialized Views](#) (page 1-9)
- [Partitioning](#) (page 1-10)
- [Temporal Validity Support](#) (page 1-11)

1.9.1 SQL Analytic Functions

A **SQL analytic function** computes an aggregate value based on a group of rows. A SQL analytic function differs from an aggregate function in that it returns multiple rows for each group. For each row, a window of rows is defined. The window determines the range of rows used to perform the calculations for the current row. Window sizes can be based on either a physical number of rows or a logical interval such as time.

SQL analytic functions bring to set-oriented SQL the ability to use array semantics on result sets. They provide coding efficiency, because they enable concise, straightforward coding of logic that is otherwise cumbersome or impossible. They also provide processing efficiency, because they are integral to Oracle Database and use internal optimizations.

A typical use of analytic functions is to retrieve the most current information in a table. For example, a query of the following form returns information from the row with the most recent update time for each customer with records in a table:

```
SELECT ... FROM my_table t1
  WHERE upd_time = ( SELECT MAX(UPD _TIME)
                    FROM my_table t2
                    WHERE t2.cust_id = t1.cust_id );
```

The preceding query uses a correlated subquery to find the `MAX(UPD _TIME)` by `cust _id`, record by record. Therefore, the correlated subquery could be evaluated once for each row in the table. If the table has very few records, performance may be adequate; if the table has tens of thousands of records, the cumulative cost of repeatedly executing the correlated subquery is high.

The following query makes a single pass on the table and computes the maximum `UPD_TIME` during that pass. Depending on various factors, such as table size and number of rows returned, the following query may be much more efficient than the preceding query:

```
SELECT ...
  FROM ( SELECT t1.*,
              MAX(UPD_TIME) OVER (PARTITION BY cust _id) max_time
        FROM my_table t1
```

```

)
WHERE upd_time = max_time;

```

The available analytic functions are:

```

AVG
CORR
COUNT
COVAR_POP
COVAR_SAMP
CUME_DIST
DENSE_RANK
FIRST
FIRST_VALUE
LAG
LAST
LAST_VALUE
LEAD
LISTAGG
MAX
MIN
NTH_VALUE
NTILE
PERCENT_RANK
PERCENTILE_CONT
PERCENTILE_DISC
RANK
RATIO_TO_REPORT
REGR_ (Linear Regression) Functions
ROW_NUMBER
STDDEV
STDDEV_POP
STDDEV_SAMP
SUM
VAR_POP
VAR_SAMP
VARIANCE

```

See Also:

- *Oracle Database Concepts* for an overview of SQL analytic functions
 - *Oracle Database SQL Language Reference* for syntax and reference information
 - *Oracle Database Data Warehousing Guide* for an extensive discussion of SQL for analysis and reporting
-

1.9.2 Materialized Views

Materialized views are query results that have been stored ("materialized") as schema objects. Like tables and views, materialized views can appear in the FROM clauses of queries.

Materialized views are used to summarize, compute, replicate, and distribute data. They are useful for pre-answering general classes of questions—users can query the materialized views instead of individually aggregating detail records. Some

environments where materialized views are useful are data warehousing, replication, and mobile computing.

Materialized views require time to create and update, and disk space for storage, but these costs are offset by dramatically faster queries. In these respects, materialized views are like indexes, and they are called "the indexes of your data warehouse." Unlike indexes, materialized views can be queried directly (with `SELECT` statements) and sometimes updated with DML statements (depending on the type of update needed).

A major benefit of creating and maintaining materialized views is the ability to take advantage of **query rewrite**, which transforms a SQL statement expressed in terms of tables or views into a statement accessing one or more materialized views that are defined on the detail tables. The transformation is transparent to the end user or application, requiring no intervention and no reference to the materialized view in the SQL statement. Because query rewrite is transparent, materialized views can be added or dropped like indexes without invalidating the SQL in the application code.

The following statement creates and populates a materialized aggregate view based on three master tables in the SH sample schema:

```
CREATE MATERIALIZED VIEW sales_mv AS
  SELECT t.calendar_year, p.prod_id, SUM(s.amount_sold) AS sum_sales
  FROM   times t, products p, sales s
  WHERE  t.time_id = s.time_id
  AND    p.prod_id = s.prod_id
  GROUP BY t.calendar_year, p.prod_id;
```

See Also:

- *Oracle Database Concepts* for an overview of materialized views
 - *Oracle Database Data Warehousing Guide* to learn how to use materialized views, including the use of query rewrite with materialized views, in a data warehouse
 - [Partitioning](#) (page 1-10) for more information about how to partition like tables and materialized views.
-
-

1.9.3 Partitioning

Partitioning is the database ability to physically break a very large table, index, or materialized view into smaller pieces that it can manage independently. Partitioning is similar to parallel processing, which breaks a large process into smaller pieces that can be processed independently.

Each partition is an independent object with its own name and, optionally, its own storage characteristics. Partitioning is useful for many different types of database applications, particularly those that manage large volumes of data. Benefits include increased availability, easier administration of schema objects, reduced contention for shared resources in OLTP systems, and enhanced query performance in data warehouses.

To partition a table, specify the `PARTITION BY` clause in the `CREATE TABLE` statement. `SELECT` and DML statements do not need special syntax to benefit from the partitioning.

A common strategy is to partition records by date ranges. The following statement creates four partitions, one for records from each of four years of sales data (2008 through 2011):

```
CREATE TABLE time_range_sales
  ( prod_id      NUMBER(6)
  , cust_id      NUMBER
  , time_id      DATE
  , channel_id   CHAR(1)
  , promo_id     NUMBER(6)
  , quantity_sold NUMBER(3)
  , amount_sold  NUMBER(10,2)
  )
PARTITION BY RANGE (time_id)
(PARTITION SALES_2008 VALUES LESS THAN (TO_DATE('01-JAN-2009','DD-MON-YYYY')),
 PARTITION SALES_2009 VALUES LESS THAN (TO_DATE('01-JAN-2010','DD-MON-YYYY')),
 PARTITION SALES_2010 VALUES LESS THAN (TO_DATE('01-JAN-2011','DD-MON-YYYY')),
 PARTITION SALES_2011 VALUES LESS THAN (MAXVALUE)
);
```

See Also:

- *Oracle Database Concepts* for an overview of partitions
 - *Oracle Database VLDB and Partitioning Guide* for detailed explanations and usage information about partitioning with very large databases (VLDB)
-
-

1.9.4 Temporal Validity Support

Temporal Validity Support lets you associate one or more valid time dimensions with a table and have data be visible depending on its time-based validity, as determined by the start and end dates or time stamps of the period for which a given record is considered valid. Examples of time-based validity are the hire and termination dates of an employee in a Human Resources application, the effective date of coverage for an insurance policy, and the effective date of a change of address for a customer or client.

Temporal Validity Support is typically used with Oracle Flashback Technology, for queries that specify the valid time period in `AS OF` and `VERSIONS BETWEEN` clauses. You can also use the `DBMS_FLASHBACK_ARCHIVE.ENABLE_AT_VALID_TIME` procedure to specify an option for the visibility of table data: all table data (the default), data valid at a specified time, or currently valid data within the valid time period at the session level.

Temporal Validity Support is useful in Information Lifecycle Management (ILM) and any other application where it is important to know when certain data becomes valid (from the application's perspective) and when it becomes invalid (if ever).

Note:

Creating and using a table with valid time support and changing data using Temporal Validity Support assume that the user has privileges to create tables and perform data manipulation language (DML) and (data definition language) DDL operations on them.

Example 1-1 Creating and Using a Table with Valid Time Support

The following example creates a table with Temporal Validity Support, inserts rows, and issues queries whose results depend on the valid start date and end date for individual rows.

```

CREATE TABLE my_emp(
  empno NUMBER,
  last_name VARCHAR2(30),
  start_time TIMESTAMP,
  end_time TIMESTAMP,
  PERIOD FOR user_valid_time (start_time, end_time));

INSERT INTO my_emp VALUES (100, 'Ames', '01-Jan-10', '30-Jun-11');
INSERT INTO my_emp VALUES (101, 'Burton', '01-Jan-11', '30-Jun-11');
INSERT INTO my_emp VALUES (102, 'Chen', '01-Jan-12', null);

-- Valid Time Queries --

-- AS OF PERIOD FOR queries:

-- Returns only Ames.
SELECT * from my_emp AS OF PERIOD FOR user_valid_time TO_TIMESTAMP('01-Jun-10');

-- Returns Ames and Burton, but not Chen.
SELECT * from my_emp AS OF PERIOD FOR user_valid_time TO_TIMESTAMP('01-Jun-11');

-- Returns no one.
SELECT * from my_emp AS OF PERIOD FOR user_valid_time TO_TIMESTAMP('01-Jul-11');

-- Returns only Chen.
SELECT * from my_emp AS OF PERIOD FOR user_valid_time TO_TIMESTAMP('01-Feb-12');

-- VERSIONS PERIOD FOR ... BETWEEN queries:

-- Returns only Ames.
SELECT * from my_emp VERSIONS PERIOD FOR user_valid_time BETWEEN
  TO_TIMESTAMP('01-Jun-10') AND TO_TIMESTAMP('02-Jun-10');

-- Returns Ames and Burton.
SELECT * from my_emp VERSIONS PERIOD FOR user_valid_time BETWEEN
  TO_TIMESTAMP('01-Jun-10') AND TO_TIMESTAMP('01-Mar-11');

-- Returns only Chen.
SELECT * from my_emp VERSIONS PERIOD FOR user_valid_time BETWEEN
  TO_TIMESTAMP('01-Nov-11') AND TO_TIMESTAMP('01-Mar-12');

-- Returns no one.
SELECT * from my_emp VERSIONS PERIOD FOR user_valid_time BETWEEN
  TO_TIMESTAMP('01-Jul-11') AND TO_TIMESTAMP('01-Sep-11');

```

To add Temporal Validity Support to an existing table without explicitly adding columns, use the ALTER TABLE statement with the ADD PERIOD FOR clause. For example, if the CREATE TABLE statement did not create the START_TIME and END_TIME columns, you could use the following statement to create the same:

```
ALTER TABLE my_emp ADD PERIOD FOR user_valid_time;
```

The preceding statement adds two hidden columns to the table MY_EMP: USER_VALID_TIME_START and USER_VALID_TIME_END. You can insert rows that specify values for these columns, but the columns do not appear in the output of the

SQL*Plus DESCRIBE statement, and SELECT statements show the data in those columns only if the SELECT list explicitly includes the column names.

[Example 1-2](#) (page 1-13) uses Temporal Validity Support for data change in the table created in [Example 1-1](#) (page 1-12). In [Example 1-2](#) (page 1-13), the initial record for employee 103 has the last name Davis. Later, the employee changes his or her last name to Smith. The END_TIME value in the original row changes from NULL to the day before the change is to become valid. A new row is inserted with the new last name, the appropriate START_TIME value, and END_TIME set to NULL to indicate that it is valid until set otherwise.

Example 1-2 Data Change Using Temporal Validity Support

```
-- Add a record for Davis.
INSERT INTO my_emp VALUES (103, 'Davis', '01-Jan-12', null);

-- To change employee 103's last name to Smith,
-- first set an end date for the record with the old name.
UPDATE my_emp SET end_time = '01-Feb-12' WHERE empno = 103;

-- Then insert another record for employee 103, specifying the new last name,
-- the appropriate valid start date, and null for the valid end date.
-- After the INSERT statement, there are two records for #103 (Davis and Smith).
INSERT INTO my_emp VALUES (103, 'Smith', '02-Feb-12', null);

-- What's the valid information for employee 103 as of today?
SELECT * from my_emp AS OF PERIOD FOR user_valid_time SYSDATE WHERE empno = 103;

-- What was the valid information for employee 103 as of a specified date?

-- First, as of a date after the change to Smith.
SELECT * from my_emp AS OF PERIOD FOR user_valid_time TO_TIMESTAMP('01-Jul-12')
WHERE empno = 103;

-- Next, as of a date before the change to Smith.
SELECT * from my_emp AS OF PERIOD FOR user_valid_time TO_TIMESTAMP('20-Jan-12')
WHERE empno = 103;
```

See Also:

- CREATE TABLE and ALTER TABLE
 - SELECT
 - *Oracle Database PL/SQL Packages and Types Reference*
 - Chapter about Information Lifecycle Management (ILM) in *Oracle Database VLDB and Partitioning Guide*, especially the section about temporal validity
 - [Using Oracle Flashback Technology](#) (page 19-1) for more information about Oracle Flashback Technology.
 - *Oracle Database PL/SQL Packages and Types Reference* for more information about DBMS_FLASHBACK_ARCHIVE.ENABLE_AT_VALID_TIME procedure.
 - [Multitenant Container Database Restrictions for Oracle Flashback Technology](#) (page 19-29)
-

Connection Strategies for Database Applications

A **database connection** is a physical communication pathway between a client process and a database instance. A **database session** is a logical entity in the database instance memory that represents the state of a current user login to a database. A session lasts from the time the user is authenticated by the database until the time the user disconnects or exits the database application. A single connection can have 0, 1, or more sessions established on it.

Most OLTP performance problems that the Oracle Real-World Performance group investigates relate to the application connection strategy. For this reason, designing a sound connection strategy is crucial for application development, especially in enterprise environments that must scale to meet increasing demand.

Topics:

- [Design Guidelines for Connection Pools](#) (page 2-1)
- [Design Guideline for Login Strategy](#) (page 2-3)
- [Design Guideline for Preventing Programmatic Session Leaks](#) (page 2-4)
- [Using Runtime Connection Load Balancing](#) (page 2-5)

2.1 Design Guidelines for Connection Pools

A **connection pool** is a cache of connections to an Oracle database that is usable by an application.

At run time, the application requests a connection from the pool. If the pool contains a connection that can satisfy the request, then it returns the connection to the application. The application uses the connection to perform work on the database, and then returns the connection to the pool. The released connection is then available for the next connection request.

In a **static connection pool**, the pool contains a fixed number of connections and cannot create more to meet demand. Thus, if the pool cannot find an idle connection to satisfy a new application request, then the request is queued or an error is returned. In a **dynamic connection pool**, however, the pool creates a new connection, and then returns it to the application. In theory, dynamic connection pools enable the number of connections in the pool to increase and decrease, thereby conserving system resources that are otherwise lost on maintaining unnecessary connections. However, in practice, a dynamic connection pool strategy allows for potential connection storms and over-subscription problems.

2.1.1 Connection Storms

A **connection storm** is a race condition in which application servers initiate an increasing number of connection requests, but the database server CPU is unable to schedule them immediately, which causes the application servers to create more connections.

During a connection storm, the number of database connections can soar from hundreds to thousands in less than a minute.

Dynamic connection pools are particularly prone to connection storms. As the number of connection requests increases, the database server becomes oversubscribed relative to the number of CPU cores. At any given time, only one process can run on a CPU core. Thus, if 32 cores exist on the server, then only 32 processes can be doing work at one time. If the application server creates hundreds or thousands of connections, then the CPU becomes busy trying to keep up with the number of processes fighting for time on the system.

Inside the database, wait activity increases as the number of active sessions increase. You can observe this activity by looking at the wait events in ASH and AWR reports. Typical wait events include latches on enqueues, row cache objects, latch free, enq: TX - index contention, and buffer busy waits. As the wait events increase, the transaction throughput decreases because sessions are unable to perform work. Because the server computer is oversubscribed, monitoring tool processes must fight for time on the CPU. In the most extreme case, using the keyboard becomes impossible, making debugging difficult.

Video:

RWP #13: Large Dynamic Connection Pools - Part 1

2.1.2 Guideline for Preventing Connection Storms: Use Static Pools

The Oracle Real-World Performance group recommends that you use static connection pools rather than dynamic connection pools.

Over years of diagnosing connection storms, the Oracle Real-World Performance group has discovered that dynamic connection pools often use too many processes for the necessary workload. A prevalent myth is that a dynamic connection pool creates connections as required and reduces them when they are not needed. In reality, when the connection pool is exhausted, application servers enable the size of the pool of database connections to increase rapidly. The number of sessions increases with little load on the system, leading to a performance problem when all the sessions become active.

Because dynamic connection pools can destabilize the system quickly, the Oracle Real-World Performance group recommends that you use static rather than dynamic connection pools.

Reducing the number of connections reduces the stress on the CPU, which leads to faster response time and higher throughput. This result may seem paradoxical. Performance improves for the following reasons:

- Fewer sessions means fewer contention-related wait events inside the database. After reducing connections, the CPU that formerly consumed cycles on latches and arbitrating contention can spend more time processing database transactions.

- As the number of connections decreases, connections can stay scheduled on the CPU for longer. As a result, all memory pages associated with these processes stay resident in the CPU cache. They become increasingly efficient at scheduling, and stall less in memory

As a rule of thumb, the Oracle Real-World Performance group recommends a 90/10 ratio of %user to %system CPU utilization, and an average of no more than 10 processes per CPU core on the database server. The number of connections should be based on the number of CPU cores and not the number of CPU core threads. For example, suppose a server has 2 CPUs and each CPU has 18 cores. Each CPU core has 2 threads. Based on the Oracle Real-World Performance group guidelines, the application can have between 36 and 360 connections to the database instance.

Video:

RWP #14: Large Dynamic Connection Pools - Part 2

2.2 Design Guideline for Login Strategy

A problem facing all database developers is how and when the application logs in to the database to initiate transactions.

In a suboptimal design, the database application performs the following steps for every SQL request:

1. Log in to the database.
2. Issue a SQL request, such as an `INSERT` or `UPDATE` statement.
3. Log out of the database.

Applications that use a login/logout strategy may meet functional requirements. Also, they may perform well when the number of transactions per second is low. However, logging in and out of the database is an extremely resource-intensive operation. The Oracle Real-World Performance group has found that applications that use such algorithms do not scale well and can cause severe performance problems, especially when used with dynamic connection pools. A login/logout strategy usually uses no connection pool.

If an application uses a login/logout design, and if the DBAs and developers do not realize the source of the problem, then the first symptoms may be low database throughput and erratic, excessively high response times. A diagnostic investigation of the database may show that relatively few sessions are active, while resource contention is low.

The clue to the suboptimal performance is that the number of logins per second is close to the number of transactions per second. When a login/logout per transaction strategy is used, the database instance and operating system perform a lot of work behind the scenes to create the new process, database connection, and associated memory area. Many of these steps are serialized, leading to low CPU utilization combine with low transaction throughput.

For the preceding reasons, the Oracle Real-World Performance group strongly recommends against a login/logout design for any application that must scale to support a high number of transactions.

Video:

RWP #2 Bad Performance with Cursors and Logons

2.3 Design Guideline for Preventing Programmatic Session Leaks

A **session leak** occurs when a program loses a connection, but its session remains active in the database instance. A leaked session is programmatically lost to the application.

An optimally designed application prevents session leaks. Typically, session leaks occur because of exceptions caught by the application. If the application does not handle the exception correctly, then it may terminate the connection without executing a commit or rollback, thus leaking the session.

Session leaks can cause severe problems for database performance and data integrity. Typically, the problems take the following forms:

- Drained connection pools
- Lock leaks
- Logical corruption

2.3.1 Drained Connection Pools

Design flaws can cause connection pools to drain.

For example, assume that an application design flaw causes it to leak sessions consistently. Even if the leak rate is low, a dynamic connection pool leads to an ever-increasing number of sessions become programmatically impossible to use.

The effect is to reduce the usable connection pool and prevent the remaining connections from keeping up with the workload. The number of unusable sessions climbs until there are no usable connections left in the pool.

2.3.2 Checking for Session Leaks

Session leaks occur due to issues in the application or application server and cannot be fixed from the database alone. The issue needs to be addressed in the application or application server. An easy way to check for session leaks is by modifying the connection pool to use one connection to the database and test the application. Testing with one connection makes it easier to find the root cause of the problem in the application.

2.3.3 Lock Leaks

A **lock leak** is typically a side-effect of a session leak.

For example, a leaked session that was in the middle of a batch update may hold TX locks on multiple rows in a table. If a leaked session is holding a lock, then sessions that want to acquire the lock form a queue behind the leaked session.

The program that is holding the lock is waiting for interaction from the client to release that lock, but because the connection is lost programmatically, the message will not be sent. Consequently, the database cannot commit or roll back any transaction active in the session.

2.3.4 Logical Corruption

A leaked session can contain uncommitted changes to the database. For example, a transaction is partway through its work when the database connection is unexpectedly released.

This situation can lead to the following problems:

- The application reports an error to the UI. In this case, customers may complain that they have lost work, for example, a business order or a flight schedule
- The UI receive a commit message even though no commit or rollback has occurred. This is the worst case, because a subsequent transaction might commit both its own work and the half of the transaction from the leaked session. In this case, the database is logically corrupted.

2.4 Using Runtime Connection Load Balancing

Topics:

- [About Runtime Connection Load Balancing](#) (page 2-5)
- [Enabling and Disabling Runtime Connection Load Balancing](#) (page 2-6)
- [Receiving Load Balancing Advisory FAN Events](#) (page 2-8)

2.4.1 About Runtime Connection Load Balancing

Oracle Real Application Clusters (Oracle RAC) is a database option in which a single database is hosted by multiple instances on multiple nodes. The Oracle RAC shared disk method of clustering databases increases scalability. The nodes can easily be added or freed to meet current needs and improve availability, because if one node fails, another can assume its workload. Oracle RAC adds high availability and failover capacity to the database, because all instances have access to the whole database.

Work requests are balanced at both connect time (**connect time load balancing**, provided by Oracle Net Services) and runtime (**runtime connection load balancing**). For Oracle RAC environments, session pools use service metrics received from the Oracle RAC load balancing advisory through Fast Application Notification (FAN) events to balance application session requests. The work requests coming into the session pool can be distributed across the instances of Oracle RAC offering a service, using the current service performance.

See Also:

- `cdemosp.c` in the directory `demo`
 - [Using Database Resident Connection Pool](#) (page 3-26)
-

Connect time load balancing occurs when an application creates a session. Pooled sessions must be well distributed across Oracle RAC instances when the sessions are created to ensure that sessions on each instance can execute work.

Runtime connection load balancing occurs when an application selects a session from an existing session pool (and thus is a very frequent activity). Runtime connection load

balancing routes work requests to sessions in a session pool that best serve the work. For session pools that support services at only one instance, the first available session in the pool is adequate. When the pool supports services that span multiple instances, the work must be distributed across instances so that the instances that are providing better service or have greater capacity get more work requests.

OCI, OCCI, JDBC, and ODP.NET client applications all support runtime connection load balancing.

See Also:

- *Oracle Call Interface Programmer's Guide* for more information about runtime load balancing using the OCI interface
 - *Oracle C++ Call Interface Programmer's Guide* for more information about runtime load balancing using the OCCI interface
 - *Oracle Database JDBC Developer's Guide* for more information about runtime load balancing using the JDBC interface
 - *Oracle Universal Connection Pool for JDBC Java API Reference*
 - *Oracle Data Provider for .NET Developer's Guide for Microsoft Windows* for more information about runtime load balancing using the ODP.NET interface
-
-

2.4.2 Enabling and Disabling Runtime Connection Load Balancing

Enabling and disabling runtime connection load balancing on the client depends on the client environment.

Topics:

- [OCI](#) (page 2-6)
- [OCCI](#) (page 2-7)
- [JDBC](#) (page 2-7)
- [ODP.NET](#) (page 2-7)

2.4.2.1 OCI

For an OCI client application, runtime connection load balancing is enabled by default in an Oracle Database 11g Release 1 (11.1) or later client communicating with a server of Oracle Database 10g Release 2 (10.2) or later when you perform the following operations to ensure that your application receives service metrics based on service time:

- Link the application with the threads library.
- Create the OCI environment in `OCI_EVENTS` and `OCI_THREADED` modes.
- Configure the load balancing advisory goal and the connection load balancing goal for a service that is used by the session pool.

To disable runtime connection load balancing for an OCI client, set the `mode` parameter to `OCI_SPC_NO_RLB` when calling `OCISessionPoolCreate()`.

FAN HA (FCF) for OCI requires AQ_HA_NOTIFICATIONS for the service to be TRUE.

See Also:

Oracle Call Interface Programmer's Guide for information about `OCISessionPoolCreate()`

2.4.2.2 OCCI

For an OCCI client application, runtime connection load balancing is enabled by default in an Oracle Database 11g Release 1 (11.1) or later client communicating with a server of Oracle Database 10g Release 2 (10.2) or later when you perform the following operations:

- Link the application with the threads library.
- Create the OCCI environment in `EVENTS` and `THREADED_MUTEXED` modes.
- Configure the load balancing advisory goal and the connection load balancing goal for a service that is used by the session pool.

To disable runtime connection load balancing for an OCCI client, use the `NO_RLB` option for the `PoolType` attribute of the `StatelessConnectionPool` class.

FAN HA (FCF) for OCCI requires AQ_HA_NOTIFICATIONS for the service to be TRUE.

See Also:

Oracle C++ Call Interface Programmer's Guide for more information about runtime load balancing using the OCCI interface

2.4.2.3 JDBC

In the JDBC environment, runtime connection load balancing is enabled by default in an Oracle Database 11g Release 1 (11.1) or later client communicating with a server of Oracle Database 10g Release 2 (10.2) or later when Fast Connection Failover (FCF) is enabled.

In the JDBC environment, runtime connection load balancing relies on the Oracle Notification Service (ONS) infrastructure, which uses the same out-of-band ONS event mechanism used by FCF processing. No additional setup or configuration of ONS is required to benefit from runtime connection load balancing.

To disable runtime connection load balancing in the JDBC environment, call `setFastConnectionFailoverEnabled()` with a value of `false`.

See Also:

Oracle Database JDBC Developer's Guide for more information about runtime load balancing using the JDBC interface

2.4.2.4 ODP.NET

In an ODP.NET client application, runtime connection load balancing is disabled by default. To enable runtime connection load balancing, include "Load

Balancing=true" in the connection string and make sure "Pooling=true" (default).

FAN HA (FCF) for ODP.NET requires AQ_HA_NOTIFICATIONS for the service to be TRUE.

See Also:

Oracle Data Provider for .NET Developer's Guide for Microsoft Windows for more information about runtime load balancing

2.4.3 Receiving Load Balancing Advisory FAN Events

Your application can receive load balancing advisory FAN events only if all of these requirements are met:

- Oracle RAC environment with Oracle Clusterware is set up and enabled.
- The server is configured to issue event notifications.
- The application is linked with the threads library.
- The OCI environment is created in OCI_EVENTS and OCI_THREADED modes.
- The OCCI environment is created in THREADED_MUTEXED and EVENTS modes.
- You configured or modified the Oracle RAC environment using the DBMS_SERVICE package.

You must modify the service to set up its goal and the connection load balancing goal as follows:

```
EXEC DBMS_SERVICE.MODIFY_SERVICE("myService",  
    DBMS_SERVICE.GOAL_SERVICE_TIME,  
    clb_goal => DBMS_SERVICE.CLB_GOAL_SHORT);
```

The constant GOAL_SERVICE_TIME specifies that Load Balancing Advisory is based on elapsed time for work done in the service plus bandwidth available to the service.

The constant CLB_GOAL_SHORT specifies that connection load balancing uses Load Balancing Advisory, when Load Balancing Advisory is enabled. You can set the connection balancing goal to CLB_GOAL_LONG. However, CLB_GOAL_LONG is typically useful for closed workloads (that is, when the rate of completing work is equal to the rate of starting new work).

See Also:

- *Oracle Real Application Clusters Administration and Deployment Guide* for information about enabling OCI clients to receive FAN events
 - *Oracle Database PL/SQL Packages and Types Reference* for information about `DBMS_SERVICE`
 - *Oracle Call Interface Programmer's Guide* for information about `OCISessionPoolCreate()`
 - *Oracle Database JDBC Developer's Guide* for more information about runtime load balancing using the JDBC interface
-

Performance and Scalability

This chapter explains some techniques for designing performance and scalability into the database and database applications.

Topics:

- [Performance Strategies](#) (page 3-1)
- [Tools for Performance](#) (page 3-5)
- [Monitoring Database Performance](#) (page 3-8)
- [Using Instrumentation](#) (page 4-2)
- [Testing for Performance](#) (page 3-10)
- [Using Bind Variables](#) (page 4-1)
- [Using Client Result Cache](#) (page 3-11)
- [Statement Caching](#) (page 3-24)
- [OCI Client Statement Cache Auto-Tuning](#) (page 3-25)
- [Client-Side Deployment Parameters](#) (page 3-25)
- [Using Query Change Notification](#) (page 3-25)
- [Using Database Resident Connection Pool](#) (page 3-26)

3.1 Performance Strategies

Topics:

- [Designing Your Data Model to Perform Well](#) (page 3-1)
- [Setting Performance Goals \(Metrics\)](#) (page 3-4)
- [Benchmarking Your Application](#) (page 3-4)

3.1.1 Designing Your Data Model to Perform Well

This topic briefly describes the important concepts of data modeling. Entire books about this subject are available; refer to them for details and further guidance.

Design your data model for optimal performance of the most important and frequent queries, following this basic procedure:

1. [Analyze the Data Requirements of the Application](#) (page 3-2)

2. [Create the Database Design for the Application](#) (page 3-2)
3. [Implement the Database Application](#) (page 3-3)
4. [Maintain the Database and Database Application](#) (page 3-4)

3.1.1.1 Analyze the Data Requirements of the Application

Analyze the data requirements of your application by following this basic procedure:

1. Collect data.

Interview people to learn about the business, the nature of the application, who uses information and how, and the expectations of end users. Collect business documents—personnel forms, invoice forms, order forms, and so on—to learn how the business uses information.

2. Analyze the collected data.

This bottom-up process includes normalization of the data, entity-relationship modeling, and transaction analysis.

3. Do a functional analysis of the data.

The end result of this top-down process is a data flow diagram that identifies the main process blocks and how data flows into and out of them over its life time.

3.1.1.2 Create the Database Design for the Application

To create the database design, you must first create the logical design, and then translate this logical design into a physical design.

Topics:

- [Create the Logical Design](#) (page 3-2)
- [Create the Physical Design](#) (page 3-3)

See Also:

Oracle Database Performance Tuning Guide for more information about designing and developing for performance

3.1.1.2.1 Create the Logical Design

The logical design is a graphical representation of the database. The logical design models both relationships between database objects and transaction activity of the application. Effective logical design considers the requirements of different users who must own, access, and update data.

To model relationships between database objects:

1. Translate the data requirements into data items (columns).
2. Group related columns into tables.
3. Map relationships among columns and tables, determining primary and foreign key attributes for each table.

4. Normalize the tables to minimize redundancy and dependency.

To model transaction activity:

- Know the most common transactions and those that users consider most important.
- Trace transaction paths through the logical model.
- Prototype transactions in SQL and develop a volume table that indicates the size of your database.
- Determine which tables are accessed by which users in which sequences, which transactions read data, and which transactions write data.
- Determine whether the application mostly reads data or mostly writes data.

3.1.1.2.2 Create the Physical Design

The physical design is the implementation of the logical design on the physical database.

Because the logical design integrates the information about tables and columns, the relationships between and among tables, and all known transaction activity, you know how the database stores data in tables and creates other structures, such as indexes.

Using this knowledge, create scripts that use SQL data definition language (DDL) to create the schema definition, define the database objects in their required sequence, define the storage requirements to specification, and so on.

3.1.1.3 Implement the Database Application

Implement the database application by following this basic procedure:

1. Implement the application in a test environment.

In a test environment that is as similar as possible to the production environment, run the scripts that implement the physical database design. Load the data into the physical schema. Select the programming language in which to develop the application, develop the user interface, create and test the transactions, and so on.

2. Ensure that the application runs to specification.

Ensure that all components are exercised, the application is fully operational, and the database features that the application uses are optimally configured. For information about tools for testing performance, see [Tools for Performance](#) (page 3-5).

3. Run benchmark tests on the application.

Benchmark tests determine whether the application performs as expected under various workloads (including peak activity) with simulated real-time operations, such as adding data and users. Ensure that the application scales well. For information about benchmarking your application, see [Benchmarking Your Application](#) (page 3-4).

If the application does not meet the benchmarks, tune your SQL statements to perform optimally, first with no workload and then with increasing workloads.

See Also:

- *Oracle Database SQL Tuning Guide* for more information about SQL tuning
 - *Oracle Database 2 Day + Performance Tuning Guide* for more information about SQL tuning
 - *Oracle Database Performance Tuning Guide* for more information about workload testing, modeling, and implementation
-

4. Implement the application in the production environment.

See Also:

Oracle Database Performance Tuning Guide for more information about deploying new applications

3.1.1.4 Maintain the Database and Database Application

Maintaining the database, the database application, and the operating system are ongoing tasks for the database administrator, the application developer, and the system administrator, respectively. The resources that the business allocates to maintenance depend on the importance of the database and the database application, its growth potential, the need to accommodate more users, and so on.

If you are responsible for maintenance, you must periodically monitor the system, schedule maintenance periods, and inform users of upcoming maintenance periods. If maintenance periods require down time, schedule them for periods with little or no database activity.

Application maintenance includes fixing bugs, applying patches, and releasing upgrades. Test maintenance work in a test environment to catch and resolve any before implemented it on production systems.

3.1.2 Setting Performance Goals (Metrics)

Start your application development project by setting performance goals (metrics), including:

- Expected number of application users
- Expected number of transactions per second at peak load times
- Expected query response times at peak load times
- Expected number of records for each table per unit of time (such as one day, one month, or one year)

Use these metrics to create benchmark tests.

3.1.3 Benchmarking Your Application

Benchmarks are tests that measure aspects of application performance. Benchmark results either validate application design or raise issues that you can resolve before putting the application into production.

Usually, you first run benchmarks on an isolated single-user system to minimize interference from other factors. Results from such benchmarks provide a performance baseline for the application. For meaningful benchmark results, you must test the application in the environment where you expect it to run.

You can create small benchmarks that measure performance of the most important transactions, compare different solutions to performance problems, and help resolve design issues that could affect performance.

You must develop much larger, more complex benchmarks to measure application performance during peak user loads, peak transaction loads, or both. Such benchmarks are especially important if you expect the user or transaction load to increase over time. You must budget and plan for such benchmarks.

After the application is in production, run benchmarks regularly in the production environment and store their results in a database table. After each benchmark run, compare the previous and new records for transactions that cannot afford performance degradation. Using this method, you isolate issues as they arise. If you wait until users complain about performance, you might be unable to determine when the problem started.

See Also:

Oracle Database Performance Tuning Guide for more information about benchmarking applications

3.2 Tools for Performance

Several tools report runtime performance information about your application.

Topics:

- [DBMS_APPLICATION_INFO Package](#) (page 3-5)
- [SQL Trace Facility \(SQL_TRACE\)](#) (page 3-6)
- [EXPLAIN PLAN Statement](#) (page 3-7)

See Also:

Oracle Database Testing Guide for more information about tools for tuning the database

3.2.1 DBMS_APPLICATION_INFO Package

Use the DBMS_APPLICATION_INFO package with the SQL Trace facility (described in [SQL Trace Facility \(SQL_TRACE\)](#) (page 3-6)) and Oracle Trace and to record the names of executing modules or transactions in the database. System administrators and performance tuning specialists can use this recorded information to track the performance of individual modules and for debugging. System administrators can also use this information to track resource use by module.

When you register the application with the database, its name and actions are recorded in the views V\$SESSION and V\$SQLAREA.

The `DBMS_APPLICATION_INFO` package provides subprograms that set the following columns in the `V$SESSION` view:

- `MODULE` (name of application or package)
- `ACTION` (name of transaction or packaged subprogram)
- `CLIENT_INFO` (additional information about the client application, such as initial bind variable values for the current session)

The `DBMS_APPLICATION_INFO` package also provides subprograms that return information from the preceding `V$SESSION` columns for the current session.

You can also use the `DBMS_APPLICATION_INFO` package to track the progress of commands that take many seconds to display results (such as those that create indexes or update many rows). The `DBMS_APPLICATION_INFO` package provides a subprogram that stores information about the command in the `V$SESSION_LONGOPS` view. The `V$SESSION_LONGOPS` view shows when the command started, how far it has progressed, and its estimated time to completion.

See Also:

- *Oracle Database PL/SQL Packages and Types Reference* for more information about the `DBMS_APPLICATION_INFO` package
 - *Oracle Database Reference* for information about the `V$SESSION` view
 - *Oracle Database Reference* for information about the `V$SESSION_LONGOPS` view
 - *Oracle Database Reference* for information about the `V$SQLAREA` view
-
-

3.2.2 SQL Trace Facility (`SQL_TRACE`)

Use the SQL Trace facility, `SQL_TRACE`, to trace all SQL statements and PL/SQL blocks that your application executes. By enabling the SQL Trace facility for a single statement or module and then disabling it after the statement or module runs, you can get trace information for only that statement or module.

For best results, use the SQL Trace facility with `TKPROF` and the `EXPLAIN PLAN` statement. The SQL Trace facility provides performance information for individual SQL statements. `TKPROF` formats the trace file contents in a readable file. The `EXPLAIN PLAN` statement shows the execution plans chosen by the optimizer and the execution plan for the specified SQL statement if it were executed in the current session (for more information, see [EXPLAIN PLAN Statement](#) (page 3-7)).

Use the SQL Trace facility while designing your application, so that you know what you want to trace and how the application performs before putting it into production. If you wait until performance problems develop in the production environment, your application structure might make using the SQL Trace facility almost impossible.

See Also:

Oracle Database SQL Tuning Guide for more information about `SQL_TRACE` and `TKPROF`

3.2.3 EXPLAIN PLAN Statement

When you run a SQL statement, the optimizer generates several possible execution plans, calculates the cost of each plan, and uses the plan with the lowest cost.

Plan cost is based on statistics such as the data distribution and storage characteristics of the tables, indexes, and partitions that the SQL statement accesses. The cost of access paths and join orders is based on estimated use of computer resources such as I/O, CPU, and memory.

When you use the statement `EXPLAIN PLAN FOR statement` before running *statement*, the `EXPLAIN PLAN` statement stores the execution plan for *statement* in a plan table. By querying the plan table, you can examine the execution plan that the optimizer chose.

The plan table presents the execution plan as a row source tree, which shows the steps that Oracle Database uses to execute the SQL statement. The row source tree shows the order in which the statement references tables, the join method for tables affected by join operations, and data operations such as filtering, sorting, and aggregation. The plan table also contains optimization information, such as the cost and cardinality of each operation, partitioning information (such as the set of accessed partitions), and parallel execution information (such as the distribution method of join inputs). This information provides valuable insight into how and why the optimizer chose the execution plan.

If you have information about the data that the optimizer does not have, you can give the optimizer a hint, which might change the execution plan. If tests show that the hint improves performance, keep the hint in your code.

Note:

You must regularly test code that contains hints, because changing database conditions and query performance enhancements in subsequent releases can significantly impact how hints affect performance.

The `EXPLAIN PLAN` statement shows only how Oracle Database would run the SQL statement when the statement was explained. If the execution environment or explain plan environment changes, the optimizer might use a different execution plan. Therefore, Oracle recommends using SQL plan management to build a SQL plan baseline, which is a set of accepted execution plans for a SQL statement.

First, use the `EXPLAIN PLAN` statement to see the statement's execution plan. Second, test the execution plan to verify that it is optimal, considering the statement's actual resource consumption. Finally, if the plan is optimal, use SQL plan management.

See Also:

- *Oracle Database SQL Tuning Guide* for more information about the query optimizer
 - *Oracle Database SQL Tuning Guide* for more information about query execution plans
 - *Oracle Database SQL Tuning Guide* for more information about influencing the optimizer with hints
 - *Oracle Database SQL Tuning Guide* for more information about SQL plan management
-

3.3 Monitoring Database Performance

Oracle Database provides advisors and powerful tools to help you manage and tune your database.

Topics:

- [Automatic Database Diagnostic Monitor \(ADDM\)](#) (page 3-8)
- [Monitoring Real-Time Database Performance](#) (page 3-9)
- [Responding to Performance-Related Alerts](#) (page 3-9)
- [SQL Advisors and Memory Advisors](#) (page 3-9)

3.3.1 Automatic Database Diagnostic Monitor (ADDM)

Automatic Database Diagnostic Monitor (ADDM) is an advisor that analyzes data captured in Automatic Workload Repository (AWR). ADDM and AWR are part of the Oracle Diagnostic Pack.

ADDM determines where database performance problems might exist and where they do not exist, and recommends corrections for the former.

ADDM performs its analysis after each AWR snapshot and stores the results in the database. By default, the AWR snapshot interval is 1 hour and the ADDM results retention period is 8 days.

Oracle Enterprise Manager Cloud Control (Cloud Control) displays ADDM Findings on the Database home page. This AWR snapshot data confirms ADDM results, but lacks the analysis and recommendations that ADDM provides. (AWR snapshot data is similar to Statspack data that database administrators used for performance analysis.)

See Also:

Oracle Database 2 Day + Performance Tuning Guide for more information about configuring ADDM, reviewing ADDM analysis, interpreting ADDM findings, implementing ADDM recommendations, and viewing snapshot statistics using Enterprise Manager

3.3.2 Monitoring Real-Time Database Performance

Using Oracle Enterprise Manager Cloud Control (Cloud Control), you can monitor real-time database performance from the Performance page. From the Performance page, you can access pages that identify performance issues and resolve those issues without waiting for the next ADDM analysis.

See Also:

Oracle Database 2 Day + Performance Tuning Guide for more information about monitoring real-time database performance

3.3.3 Responding to Performance-Related Alerts

The Database home page in Oracle Enterprise Manager Cloud Control (Cloud Control) displays performance-related alerts generated by the database. You can improve database performance by resolving problems indicated by these alerts. Oracle Database by default enables alerts for tablespace usage, snapshot too old, recovery area low on free space, and resumable session suspended. You can view metrics and thresholds, set metric thresholds, respond to alerts, clear alerts, and set up direct alert email notification. Using this built-in alerts infrastructure allows you to be notified for these special performance-related alerts.

See Also:

- *Oracle Database Administrator's Guide* for more information about using alerts to help you monitor and tune the database and managing alerts
 - *Oracle Database 2 Day + Performance Tuning Guide* for more information about monitoring performance alerts
-
-

3.3.4 SQL Advisors and Memory Advisors

Oracle Database provides SQL advisors and memory advisors that you can use to help improve database performance.

SQL advisors include SQL Tuning Advisor and SQL Access Advisor, which are part of the Oracle Database Tuning Pack.

SQL Tuning Advisor accepts one or more SQL statements as input and returns specific tuning recommendations. Each recommendation includes a rationale and expected benefit. Recommendations are based on object statistics, new index creation, SQL statement restructuring, and SQL profile creation.

SQL Access Advisor enables you to optimize data access paths of SQL queries by recommending a set of materialized views and view logs, indexes, and partitions for a given SQL workload.

Memory advisors include Memory Advisor, SGA Advisor, Shared Pool Advisor, Buffer Cache Advisor, and PGA Advisor. Memory advisors provide graphical analyses of total memory target settings, SGA and PGA target settings, and SGA component size settings. Use these analyses to tune database performance and to plan for possible situations.

See Also:

- *Oracle Database 2 Day DBA* for more information about using advisors to optimize database performance, including a brief description of each performance advisor
 - *Oracle Database 2 Day DBA* for more information about optimizing memory usage with the memory advisors
 - *Oracle Database 2 Day + Performance Tuning Guide* for more information about tools for tuning the database
 - *Oracle Database SQL Tuning Guide* for more information about SQL Tuning Advisor
 - *Oracle Database SQL Tuning Guide* for more information about SQL Access Advisor
-

3.4 Testing for Performance

When testing an application for performance, follow these guidelines:

- Use Automatic Database Diagnostic Monitor (ADDM) and SQL Tuning Advisor for design validation.

ADDM determines where database performance problems might exist and recommends corrections. For example, if ADDM finds high-load SQL statements, then you can use SQL Tuning Advisor to analyze those statements and provide tuning recommendations.

For more information about ADDM and SQL Tuning Advisor, see [Automatic Database Diagnostic Monitor \(ADDM\)](#) (page 3-8) and [SQL Advisors and Memory Advisors](#) (page 3-9), respectively.

See Also:

Oracle Database 2 Day + Performance Tuning Guide for more information about tuning SQL statements using the SQL Tuning Advisor

- Test with realistic data volumes and distributions.

The test database must contain data representative of the production system. Tables must be fully populated and represent the data volume and cardinality between tables found in the production system. All production indexes must be built and the schema statistics must be populated correctly.

- Test with the optimizer mode to be used in production.

Because Oracle Database research and development focuses on the query optimizer, Oracle recommends using the query optimizer in both the test and production environments.

- Test a single user performance first.

Start testing with a single user on an idle or lightly-used database. If a single user cannot achieve acceptable performance under ideal conditions, then multiple users cannot achieve acceptable performance under real conditions.

- Get an execution plan for each SQL statement.
Verify that the optimizer uses optimal execution plans, and that you understand the relative cost of each SQL statement in terms of CPU time and physical I/O. Identify heavily used transactions that would benefit most from tuning.
- Test with multiple users.
This testing is difficult to perform accurately because user workload and profiles might not be fully quantified. However, you must test DML transactions in a multiuser environment to ensure that there are no locking conflicts or serialization problems.
- Test with a hardware configuration as close as possible to the production system.
Testing on a realistic system is particularly important for network latencies, I/O subsystem bandwidth, and processor type and speed. Testing on an unrealistic system can fail to reveal potential performance problems.
- Measure steady state performance.
Each benchmark run must have a ramp-up phase, where users connect to the database and start using the application. This phase lets frequently cached data be initialized into the cache and lets single-execution operations (such as parsing) be completed before reaching the steady state condition. Likewise, each benchmark run must end with a ramp-down period, where resources are freed from the system and users exit the application and disconnect from the database.

See Also:

- *Oracle Database Performance Tuning Guide* for more information about performance tuning, workload testing, modeling, and implementation
-
-

3.5 Using Client Result Cache

Topics:

- [About Client Result Cache](#) (page 3-12)
- [Benefits of Client Result Cache](#) (page 3-12)
- [Guidelines for Using Client Result Cache](#) (page 3-13)
- [Client Result Cache Consistency](#) (page 3-17)
- [Deployment-Time Settings for Client Result Cache](#) (page 3-18)
- [Client Result Cache Statistics](#) (page 3-21)
- [Validation of Client Result Cache](#) (page 3-21)
- [Client Result Cache and Server Result Cache](#) (page 3-22)
- [Client Result Cache Demo Files](#) (page 3-23)
- [Client Result Cache Compatibility with Previous Releases](#) (page 3-23)
- [Where to Find More Information About Client Result Cache](#) (page 3-24)

3.5.1 About Client Result Cache

Applications that use Oracle Database drivers and adapters built on OCI libraries—including C, C++, Java (JDBC-OCI), PHP, Python, Ruby, and Perl—can use client result cache to improve response times of repetitive queries.

Client result cache enables client-side caching of SQL query (`SELECT` statement) result sets in client memory. Because retrieving results from a client process is faster than calling the database and rerunning the query, frequently run queries perform significantly faster when their results are cached. Client result cache also reduces the server CPU time that would have been used to process the query, thereby improving server scalability.

OCI statements from multiple sessions can match the same cached result set in the OCI process memory if they have similar schemas, SQL text, bind values, and session settings. If not, the query execution is directed to the server.

Client result cache is transparent to applications, and its cache of result set data is kept consistent with session or database changes that affect its result set data.

Applications that use client result cache benefit from faster performance for queries that have cache hits. These applications use the cached result sets on clients or middle tiers.

Client result cache works with OCI features such as the OCI session pool, the OCI connection pool, DRCP, and OCI transparent application failover (TAF).

When using client result cache, you must also enable OCI statement caching or cache statements at the application level.

See Also:

- *Oracle Call Interface Programmer's Guide* for information about statement caching
 - *Oracle Database JDBC Developer's Guide* for information about JDBC statement caching
-
-

3.5.2 Benefits of Client Result Cache

The benefits of client result cache are:

- Because client result cache is on the client, a cache hit causes fetch (`OCIStmtFetch2()`) and execute (`OCIStmtExecute()`) calls to be processed locally, eliminating a server round trip. Eliminating server round trips reduces the use of server resources (such as server CPU and server I/O), significantly improving performance.
- Client result cache is transparent and consistent.
- Client result cache is available to every process, so multiple client sessions can simultaneously use matching cached result sets.
- Client result cache minimizes the need for each OCI application to have its own custom result cache.
- Client result cache transparently manages:

- Concurrent access by multiple threads, multiple statements, and multiple sessions
- Invalidation of cached result sets that might have been affected by database changes
- Refreshing of cached result sets
- Cache memory management
- Client result cache is automatically available to applications and drivers that use OCI libraries, including JDBC OCI, ODP.NET, OCCI, Pro*C/C++, Pro*COBOL, and ODBC.
- Client result cache uses OCI client memory, which might be less expensive than server memory.
- A local cache on the client has better locality of reference for queries executed by that client.

See Also:

`OCIStmtExecute()` and `OCIStmtFetch2()` in *Oracle Call Interface Programmer's Guide*

3.5.3 Guidelines for Using Client Result Cache

You can enable or disable client result cache at three levels, which are, in order of descending precedence:

1. Query

For a specific query, you can enable or disable client result cache with a SQL hint (for details, see [SQL Hints](#) (page 3-14)). To add or change a SQL hint, you must change the application.

2. Table

For all queries on a specific table, you can enable or disable client result cache with a table annotation, without changing the application (for details, see [Table Annotation](#) (page 3-15)).

3. Session

For all queries in your database session, you can enable or disable client result cache with a session parameter, without changing the application (for details, see [Session Parameter](#) (page 3-15)).

Higher-level settings take precedence over lower-level ones. For examples, see [Result Cache Mode Use Cases](#) (page 3-17).

Oracle recommends enabling client result cache only for queries on read-only and seldom-updated tables (tables that are rarely updated). That is, enable client result cache:

- At query level only for queries of read-only and seldom-read tables
- At table level only for read-only and seldom-read tables

- At session level only when running applications that query only read-only or seldom-read tables

Enabling client result cache for queries that have large result sets or many sets of bind values can use a large amount of client result cache memory. Each set of bind values (for the same SQL text) creates a different cached result set.

When client result cache is enabled for a query, its result sets can be cached on the client, server, or both. Client result cache can be enabled even if the server result cache (which is enabled by default) is disabled.

For OCI, the first `OCIStmtExecute()` call of every OCI statement handle call always goes to the server even if there might be a valid cached result set. An `OCIStmtExecute()` call must be made for each statement handle to be able to match a cached result set. Oracle recommends that applications either have their own statement caching for OCI statement handles or use OCI statement caching so that `OCIStmtPrepare2()` can return an OCI statement handle that has been executed once. Multiple OCI statement handles, from the same or different sessions, can simultaneously fetch data from the same cached result set.

For OCI, for a result set to be cached, the `OCIStmtExecute()` or `OCIStmtFetch2()` calls that transparently create this cached result set must fetch rows until `ORA-01403` (No Data Found) is returned. Subsequent `OCIStmtExecute()` or `OCIStmtFetch2()` calls that match a locally cached result set need not fetch to completion.

See Also:

`OCIStmtExecute()`, `OCIStmtPrepare2()`, and `OCIStmtFetch2()` in *Oracle Call Interface Programmer's Guide*

Topics:

- [SQL Hints](#) (page 3-14)
- [Table Annotation](#) (page 3-15)
- [Session Parameter](#) (page 3-15)
- [Effective Table Result Cache Mode](#) (page 3-16)
- [Displaying Effective Table Result Cache Mode](#) (page 3-16)
- [Result Cache Mode Use Cases](#) (page 3-17)
- [Queries Never Result Cached in Client Result Cache](#) (page 3-17)

3.5.3.1 SQL Hints

The SQL hint `RESULT_CACHE` or `NO_RESULT_CACHE` applies to a single query, for which it enables or disables client result cache. These hints take precedence over both table annotations and the `RESULT_CACHE_MODE` server initialization parameter.

For OCI, the SQL hint `/*+ result_cache */` or `/*+ no_result_cache */` must be set in SQL text passed to `OCIStmtPrepare()` and `OCIStmtPrepare2()` calls.

For JDBC OCI, the SQL hint `/*+ result_cache */` or `/*+ no_result_cache */` is included in the query (`SELECT` statement) as part of the query string.

See Also:

- *Oracle Database SQL Language Reference* for general information about SQL hints
- `OCIStmtPrepare()`, `OCIStmtPrepare2()` in *Oracle Call Interface Programmer's Guide*
- *Oracle Database JDBC Developer's Guide* for information about SQL hints in JDBC

3.5.3.2 Table Annotation

A **table annotation** enables or disables client result cache for all queries on a specific table. A table annotation takes precedence over the `RESULT_CACHE_MODE` server initialization parameter, but the SQL hints `/*+ RESULT_CACHE */` and `/*+ NO_RESULT_CACHE */` take precedence over a table annotation.

You annotate a table with either the `CREATE TABLE` or `ALTER TABLE` statement, using the `RESULT_CACHE` clause. To enable client result cache, specify `RESULT_CACHE (MODE FORCE)`; to disable it, use `RESULT_CACHE (MODE DEFAULT)`.

[Table 3-1](#) (page 3-15) summarizes the table annotation result cache modes.

Table 3-1 Table Annotation Result Cache Modes

Mode	Description
DEFAULT	The default value. Result caching is not determined at the table level. You can use this value to clear any table annotations.
FORCE	If all table names in the query have this setting, then the query result is always considered for caching unless the <code>NO_RESULT_CACHE</code> hint is specified for the query. If one or more tables named in the query are set to <code>DEFAULT</code> , then the effective table annotation for that query is <code>DEFAULT</code> .

See Also:

- *Oracle Database SQL Language Reference* for more information about `RESULT_CACHE` clause of `ALTER TABLE` and `CREATE TABLE`
- *Oracle Database JDBC Developer's Guide* for information about table annotations in JDBC

3.5.3.3 Session Parameter

The session parameter `RESULT_CACHE_MODE` enables or disables client result cache for all queries for your database session. `RESULT_CACHE_MODE` can be overruled for specific tables by table annotations and for specific queries by SQL hints.

You can set `RESULT_CACHE_MODE` in either the server parameter file (`init.ora`) or the `ALTER SESSION` or `ALTER SYSTEM` statement. To enable client result cache, set `RESULT_CACHE_MODE` to `FORCE`; to disable it, set `RESULT_CACHE_MODE` to `MANUAL`.

See Also:

Oracle Database Reference for more information about `RESULT_CACHE_MODE`

3.5.3.4 Effective Table Result Cache Mode

The effective result cache mode for a table depends on both the table annotation result cache mode and the `RESULT_CACHE_MODE` session parameter setting, as [Table 3-2](#) (page 3-16) shows.

Table 3-2 Effective Result Cache Table Mode

Table Annotation Result Cache Mode	<code>RESULT_CACHE_MODE = MANUAL</code>	<code>RESULT_CACHE_MODE = FORCE</code>
FORCE	FORCE	FORCE
DEFAULT	MANUAL	FORCE

When the effective mode is `FORCE`, every query is considered for result caching unless the query has the `NO_RESULT_CACHE` hint, but actual result caching depends on internal restrictions for client and server caches, query potential for reuse, and space available in the client result cache.

The effective table result cache mode `FORCE` is similar to the SQL hint `RESULT_CACHE` in that both are only requests.

3.5.3.5 Displaying Effective Table Result Cache Mode

To display the result cache mode for one or more tables, see the `RESULT_CACHE` column of a `*_TABLES` static data dictionary view. For example:

- This query displays the result cache mode for the table `T`:

```
SELECT result_cache FROM all_tables WHERE table_name = 'T'
```
- This query displays the result cache mode for all relational tables that you own:

```
SELECT table_name, result_cache FROM user_tables
```

If the result cache mode is `DEFAULT`, then the table is not annotated.

If the result cache mode is `FORCE`, then the table was annotated with the `RESULT_CACHE (MODE FORCE)` clause of the `CREATE TABLE` or `ALTER TABLE` statement.

If the result cache mode is `MANUAL`, then the session parameter `RESULT_CACHE_MODE` was set to `MANUAL` in either the server parameter file (`init.ora`) or an `ALTER SESSION` or `ALTER SYSTEM` statement.

See Also:

Oracle Database Reference for more information about `*_TABLES` static data dictionary views

3.5.3.6 Result Cache Mode Use Cases

The following examples show when SQL hints take precedence over table annotations and the `RESULT_CACHE_MODE` session parameter.

- If the `emp` table is annotated with `ALTER TABLE emp RESULT_CACHE (MODE FORCE)` and the session parameter has its default value, `MANUAL`, then queries on `emp` are considered for result caching.

However, results of the query `SELECT /*+ no_result_cache */ empno FROM emp` are not cached, because the SQL hint takes precedence over the table annotation and session parameter.

- If the `emp` table is not annotated, or is annotated with `ALTER TABLE emp RESULT_CACHE (MODE DEFAULT)`, and the session parameter has its default value, `MANUAL`, then queries on `emp` are not result cached.

However, results of the query `SELECT /*+ result_cache */ * FROM emp` are considered for caching, because the SQL hint takes precedence over the table annotation and session parameter.

- If the session parameter `RESULT_CACHE_MODE` is set to `FORCE`, and no table annotations or SQL hints override it, then all queries on all tables are considered for query caching.

3.5.3.7 Queries Never Result Cached in Client Result Cache

Results of the following queries are never cached in client result cache (even if the queries include the `RESULT_CACHE` hint):

- Queries that contain any of the following:
 - Remote object
 - Complex type in the select list
 - PL/SQL function
- Snapshot-based queries
- Flashback queries
- Queries executed in serializable, read-only transactions
- Queries of tables on which virtual private database (VPD) policies are enabled

Such queries might be cached on the database if the server result cache feature is enabled—for more information, see *Oracle Database Concepts*.

3.5.4 Client Result Cache Consistency

Client result cache transparently keeps its result sets consistent with any database or session state changes that affect them.

When a transaction modifies the data or metadata of any database object used to construct a cached result set, invalidation of that cached result set is sent to the client on its next round trip to the server. If the application does no database calls for a period of time, then the client result cache lag setting forces the next `OCIStmtExecute()` call to make a database call to check for such invalidations.

Cached result sets relevant to database invalidations are immediately invalidated. Any OCI statement handles that are fetching from cached result sets when their invalidations are received can continue fetching from them, but no subsequent `OCIStmtExecute()` calls can match them.

The next `OCIStmtExecute()` call by the process might cache the new result set if the client result cache has space available. Client result cache periodically reclaims unused memory.

If a session has a transaction open, OCI ensures that its queries that reference database objects changed in this transaction go to the server instead of client result cache.

This consistency mechanism ensures that client result cache is always close to committed database changes. If the application has relatively frequent calls involving database round trips due to queries that cannot be cached (DMLs, `OCILOB` calls, and so on), then these calls transparently keep client result cache consistent with database changes.

Sometimes, when a table is modified, a trigger causes another table to be modified. Client result cache is sensitive to such changes.

When the session state is altered—for example, when NLS session parameters are modified—query results can change. Client result cache is sensitive to such changes and for subsequent query executions, returns the correct result set. However, client result cache keeps the current cached result sets (and does not invalidate them) so that other sessions in the process can match them. If other processes do not match them, these result sets are "Ruled" after a while. Result sets that correspond to the new session state are cached.

For an application, keeping track of database and session state changes that affect query result sets can be cumbersome and error-prone, but client result cache transparently keeps its result sets consistent with such changes.

Client result cache does not require thread support in the client.

See Also:

`OCIStmtExecute()` in *Oracle Call Interface Programmer's Guide*

3.5.5 Deployment-Time Settings for Client Result Cache

When you deploy your application, you can set the following for client result cache (without changing the application):

- Server initialization parameters (see section [Server Initialization Parameters](#) (page 3-19))
- Client configuration parameters (see section [Client Configuration Parameters](#) (page 3-20))
- Table annotations (see section [Table Annotation](#) (page 3-15))
- `RESULT_CACHE_MODE` session parameter (see section [Session Parameter](#) (page 3-15))

See Also:

[Client-Side Deployment Parameters](#) (page 3-25)

3.5.5.1 Server Initialization Parameters

The server initialization parameters to set for client result cache when you deploy your application are:

- [COMPATIBLE](#) (page 3-19)
- [CLIENT_RESULT_CACHE_SIZE](#) (page 3-19)
- [CLIENT_RESULT_CACHE_LAG](#) (page 3-20)

3.5.5.1.1 COMPATIBLE

Specifies the release with which Oracle Database must maintain compatibility. To enable client result cache, `COMPATIBLE` must be at least 11.0.0.0. To enable client result cache for views, `COMPATIBLE` must be at least 11.2.0.0.

3.5.5.1.2 CLIENT_RESULT_CACHE_SIZE

Specifies the maximum size of the client result set cache for each OCI client process. The default value, 0, means that client result cache is disabled. To enable client result cache, set `CLIENT_RESULT_CACHE_SIZE` to at least 32768 bytes (32 kilobytes (KB)).

If client result cache is enabled on the server by `CLIENT_RESULT_CACHE_SIZE`, then its value can be overridden by the `sqlnet.ora` configuration parameter `OCI_RESULT_CACHE_MAX_SIZE`. If client result cache is disabled on the server, then `OCI_RESULT_CACHE_MAX_SIZE` is ignored and client result cache cannot be enabled on the client.

Oracle recommends either enabling client result cache for all Oracle Real Application Clusters (Oracle RAC) nodes or disabling client result cache for all Oracle RAC nodes. Otherwise, within a client process, some sessions might have caching enabled and other sessions might have caching disabled (thereby getting the latest results from the server). This combination might present an inconsistent view of the database to the application.

`CLIENT_RESULT_CACHE_SIZE` is a static parameter. Therefore, if you use an `ALTER SYSTEM` statement to change the value of `CLIENT_RESULT_CACHE_SIZE`, you must include the `SCOPE = SPFILE` clause and restart the database before the change will take effect.

The maximum value for `CLIENT_RESULT_CACHE_SIZE` is the least of these values:

- Available client memory
- ((Possible number of result sets to be cached) * (average size of a row in a result set) * (average number of rows in a result set))
- 2 gigabytes (GB)

If you specify a value greater than 2 GB, then the value is 2 GB.

Note:

Do not set the `CLIENT_RESULT_CACHE_SIZE` parameter during database creation, because that can cause errors.

3.5.5.1.3 CLIENT_RESULT_CACHE_LAG

Specifies the maximum time in milliseconds that client result cache can lag behind changes in the database that affect its result sets. The default is 3000 milliseconds.

`CLIENT_RESULT_CACHE_LAG` is a static parameter. Therefore, if you use an `ALTER SYSTEM` statement to change the value of `CLIENT_RESULT_CACHE_LAG`, you must include the `SCOPE = SPFILE` clause and restart the database before the change will take effect.

3.5.5.2 Client Configuration Parameters

Client configuration parameters are optional, but if set, they override the equivalent parameters in the server initialization file `init.ora`.

Client configuration parameters can be set in the `oraaccess.xml` file (see *Oracle Call Interface Programmer's Guide*), the `sqlnet.ora` file, or both. When equivalent parameters are set both files, the `oraaccess.xml` setting takes precedence over the corresponding `sqlnet.ora` setting. When a parameter is not set in `oraaccess.xml`, the process searches for its setting in `sqlnet.ora`.

When a client configuration parameter can be set in both `oraaccess.xml` and `sqlnet.ora`, Oracle recommends setting the parameter in `oraaccess.xml`. However, for a network configuration, `sqlnet.ora` is the primary file, because `oraaccess.xml` does not support network level settings.

[Table 3-3](#) (page 3-20) describes the equivalent `oraaccess.xml` and `sqlnet.ora` client configuration parameters.

Table 3-3 Client Configuration Parameters (Optional)

oraaccess.xml Parameter	sqlnet.ora Parameter	Description
<code>max_size</code>	<code>OCI_RESULT_CACHE_MAX_SIZE</code>	Maximum size in bytes for the client result cache for each process. Specifying a size less than 32768 in <code>sqlnet.ora</code> disables client result cache for client processes the read <code>sqlnet.ora</code> .
<code>max_rset_size</code>	<code>OCI_RESULT_CACHE_MAX_RSET_SIZE</code>	Maximum size of any result set in bytes in the client result cache for each process.
<code>max_rset_rows</code>	<code>OCI_RESULT_CACHE_MAX_RSET_ROWS</code>	Maximum size of any result set in rows in the client result cache for each process.

The result cache lag cannot be set on the client.

3.5.6 Client Result Cache Statistics

On round trips to the server from the OCI client, OCI periodically sends client result cache statistics to the server. These statistics, shown in the `CLIENT_RESULT_CACHE_STATS$` view, include number of result sets successfully cached, number of cache hits, and number of cached result sets invalidated. The number of cache misses for queries is at least equal to the number of Create Counts in client result cache statistics. More precisely, the cache miss count equals the number of server executions in server Automatic Workload Repository (AWR) reports.

See Also:

- *Oracle Database Reference* for information about the `CLIENT_RESULT_CACHE_STAT$` view
 - *Oracle Database Performance Tuning Guide* to find the client process IDs and session IDs for the sessions doing client result caching
-
-

3.5.7 Validation of Client Result Cache

Some ways to validate client result cache are:

- [Measure Execution Times](#) (page 3-21)
- [Query V\\$MYSTAT](#) (page 3-21)
- [Query V\\$SQLAREA](#) (page 3-22)

3.5.7.1 Measure Execution Times

First, measure the execution time of the queries without `RESULT_CACHE` hints. Then add `RESULT_CACHE` hints to the queries and measure the execution time again. The difference in execution times is your performance gain.

3.5.7.2 Query V\$MYSTAT

Note:

To query the `V$MYSTAT` view, you must have the `SELECT` privilege on it.

1. Run this query 5 times:

```
SELECT count(*) FROM table_name
```

2. Query `V$MYSTAT`:

```
SELECT * FROM V$MYSTAT
```

3. Run this query 5 times:

```
SELECT /*+ result_cache */ count(*) FROM table_name
```

Because the query results are cached, this step requires fewer round trips between client and server than step 1 (page 3-21) did.

4. Query V\$MYSTAT:

```
SELECT * FROM V$MYSTAT
```

Compare the values of the columns for this query to those for the query in step [2](#) (page 3-21).

Instead of adding the hint to the query in step [3](#) (page 3-21), you can add the table annotation `RESULT_CACHE (MODE FORCE)` to `table_name` at step [3](#) (page 3-21) and then run the query in step [1](#) (page 3-21) a few times.

3.5.7.3 Query V\$SQLAREA**Note:**

To query the V\$SQLAREA view, you must have the SELECT privilege on it.

1. Run this query 5 times:

```
SELECT count(*) FROM table_name
```

2. Query V\$SQLAREA:

```
SELECT executions, fetches, parse_calls FROM V$SQLAREA
WHERE sql_text LIKE '% FROM table_name'
```

3. Run this query 5 times:

```
SELECT /*+ result_cache */ count(*) FROM table_name
```

4. Query V\$SQLAREA:

```
SELECT executions, fetches, parse_calls FROM V$SQLAREA
WHERE sql_text LIKE '% FROM table_name'
```

Compare the values of the columns `executions`, `fetches`, and `parse_calls` for this query to those for the query in step [2](#) (page 3-22). The difference in execution times is your performance gain.

Instead of adding the hint to the query in step [3](#) (page 3-22), you can add the table annotation `RESULT_CACHE (MODE FORCE)` to `table_name` at step [3](#) (page 3-22) and then run the query in step [1](#) (page 3-22) a few times.

3.5.8 Client Result Cache and Server Result Cache

Client result cache is different from server result cache. Client result cache caches results of top-level SQL queries in OCI client memory, whereas server result cache caches result sets and query fragments in server SGA memory.

You can enable client result cache independently of server result cache, though they share the result cache SQL hints, table annotations, and session parameter `RESULT_CACHE_MODE`. [Table 3-4](#) (page 3-23) shows the result cache association for result cache parameters, the PL/SQL package `DBMS_RESULT_CACHE`, and result cache views. For more information about server result cache, see *Oracle Database Concepts*.

Table 3-4 Setting Client Result Cache and Server Result Cache

Parameters, PL/SQL Package, and Database Views	Result Cache Association
CLIENT_RESULT_CACHE_* parameters: <ul style="list-style-type: none"> CLIENT_RESULT_CACHE_SIZE CLIENT_RESULT_CACHE_LAG 	client result cache
SQL hints: <ul style="list-style-type: none"> RESULT_CACHE NO_RESULT_CACHE 	client result cache, server result cache
sqlnet.ora OCI_RESULT_CACHE* parameters: <ul style="list-style-type: none"> OCI_RESULT_CACHE_MAX_SIZE OCI_RESULT_CACHE_MAX_RSET_SIZE OCI_RESULT_CACHE_MAX_RSET_ROWS 	client result cache
CLIENT_RESULT_CACHE_STATS\$ view	client result cache
RESULT_CACHE_MODE parameter	client result cache, server result cache
All other RESULT_CACHE_* parameters (for example, RESULT_CACHE_MAX_SIZE)	server result cache
DBMS_RESULT_CACHE package	server result cache
V\$RESULT_CACHE_* and GV\$RESULT_CACHE_* views (for example, V\$RESULT_CACHE_STATISTICS and GV\$RESULT_CACHE_MEMORY)	server result cache
CREATE TABLE annotation	client result cache, server result cache
ALTER TABLE annotation	client result cache, server result cache

3.5.9 Client Result Cache Demo Files

For OCI applications, demonstration files for client result cache are `cdemoqc.sql`, `cdemoqc.c`, and `cdemoqc2.c` (in the `demo` directory for your operating system).

3.5.10 Client Result Cache Compatibility with Previous Releases

To use client result cache, applications must be relinked with Oracle Database 11g Release 1 (11.1) or later client libraries and be connected to an Oracle Database 11g Release 1 (11.1) or later database server. Client result cache is available to all OCI applications, including JDBC Type II driver, OCCI, Pro*C/C++, and ODP.NET. OCI drivers automatically pass the SQL hint `RESULT_CACHE` to `OCIStmtPrepare()` and `OCIStmtPrepare2()` calls.

See Also:

`OCIStmtPrepare()`, `OCIStmtPrepare2()` in *Oracle Call Interface Programmer's Guide*

3.5.11 Where to Find More Information About Client Result Cache

More information about client result cache is in the following documentation:

- *Oracle Call Interface Programmer's Guide*
- *Oracle C++ Call Interface Programmer's Guide*
- *Oracle Database JDBC Developer's Guide*
- *Oracle Database Performance Tuning Guide*
- *Oracle Database Concepts*
- *Oracle Database SQL Language Reference* for information about SQL hints and `RESULT_CACHE` clause of `ALTER TABLE`, and `CREATE TABLE`
- *Oracle Database Reference* for information about `RESULT_CACHE_MODE` initialization parameter and `CLIENT_RESULT_CACHE_STAT$` view

3.6 Statement Caching

Statement caching is a feature that establishes and manages a cache of statements for each session. In the server, statement caching lets cursors be used without reparsing the statement, eliminating repetitive statement parsing. You can use statement caching with both connection pooling and session pooling, thereby improving performance and scalability. You can also use statement caching without session pooling in OCI and without connection pooling in OCCI, in the JDBC interface, and in the ODP.NET interface. You can also use dynamic SQL statement caching in Oracle precompiler applications that rely on dynamic SQL statements, such as Pro*C/C++ and ProCOBOL.

In the JDBC interface, you can enable and disable implicit and explicit statement caching independently of the other—you can use either, neither, or both. Implicit and explicit statement caching share a single cache for each connection. You can also disable implicit caching for a particular statement.

See Also:

- *Oracle Call Interface Programmer's Guide* for more information and guidelines about using statement caching in OCI
 - *Oracle C++ Call Interface Programmer's Guide* for more information about statement caching in OCCI
 - *Oracle Database JDBC Developer's Guide* for more information about using statement caching
 - *Oracle Data Provider for .NET Developer's Guide for Microsoft Windows* for more information about using statement caching in ODP.NET applications
 - *Oracle Database Programmer's Guide to the Oracle Precompilers, Pro*C/C++ Programmer's Guide, and Pro*COBOL Programmer's Guide* for more information about using dynamic SQL statement caching in precompiler applications that rely on dynamic SQL statements
-

3.7 OCI Client Statement Cache Auto-Tuning

OCI client statement cache auto-tuning optimizes OCI client session features of middle-tier applications to improve performance without changing your OCI application.

Without auto-tuning, the OCI client statement cache size setting can become suboptimal—for example, when a changing workload causes a different working set of SQL statements. If the size is too low, it causes excess network activity and more parses at the server. If the size is too high, it causes excess memory use. It can be difficult for the client application to keep the cache size optimal.

Auto-tuning solves this potential performance problem by automatically and periodically reconfiguring the OCI statement cache size.

Auto-tuning is achieved by providing a deployment-time setting that provides an option to reconfigure OCI statement caching. These settings are provided as connect-string-based deployment settings in a client `oraaccess.xml` file that overrides programmatic settings to the user configuration of OCI features.

Middle-tier application developers and database administrators (DBAs) can expect reduced time and effort in diagnosing and fixing performance problems with each part of their system using the auto-tuning OCI client statement caching parameter setting.

For information about OCI auto-tuning parameters, implementation, and usage, see *Oracle Call Interface Programmer's Guide*.

3.8 Client-Side Deployment Parameters

Beginning with Oracle Database 12c Release 1 (12.1.0.1), OCI deployment parameters are available in a new configuration file, `oraaccess.xml`, as described in *Oracle Call Interface Programmer's Guide*.

3.9 Using Query Change Notification

Continuous Query Notification (CQN) lets client applications register queries with the database and receive notifications of DML or DDL changes on the objects (object change notification (OCN)) or result set changes associated with the queries (query result change notification (QRCN)). The database publishes notifications when the DML or DDL transaction commits.

A **CQN registration** associates one or more queries with a notification type (OCN or QRCN) and a notification handler. To create a CQN registration, you can use:

- PL/SQL interface

When you use the PL/SQL interface, the notification handler is a server-side PL/SQL stored procedure. PL/SQL registration can be used by nonthreaded languages and systems, such as PHP. For PHP, the PL/SQL listener invokes a PHP callback when it receives the database notification.

- Oracle Call Interface (OCI)

When you use OCI, the notification handler is a client-side C callback procedure.

- Java Database Connectivity (JDBC) interface

When you use the JDBC interface, the JDBC driver creates a registration on the server. The JDBC driver launches a new thread that listens for notifications from the server (through a dedicated channel), converts them to Java events, and then notifies all listeners registered with this registration.

See Also:

- [Using Continuous Query Notification \(CQN\)](#) (page 18-1) for a complete discussion of the concepts of this feature and how to use the PL/SQL and OCI interfaces to create CQN registrations
 - *Oracle Database JDBC Developer's Guide* for information about using JDBC for CQN registration on the server
-

3.10 Using Database Resident Connection Pool

Database Resident Connection Pool (DRCP) provides a connection pool in the database server for typical web application usage scenarios where the application acquires a database connection, works on the database for a relatively short time, and then releases the connection.

Topics:

- [About Database Resident Connection Pool](#) (page 3-27)
- [Configuring DRCP](#) (page 3-28)
- [Sharing Proxy Sessions](#) (page 3-29)
- [Using JDBC with DRCP](#) (page 3-29)
- [Using OCI Session Pool APIs with DRCP](#) (page 3-29)
- [Session Purity and Connection Class](#) (page 3-30)
- [Starting Database Resident Connection Pool](#) (page 3-32)
- [Enabling DRCP](#) (page 3-32)
- [Benefiting from the Scalability of DRCP in an OCI Application](#) (page 3-32)
- [Benefiting from the Scalability of DRCP in a Java Application](#) (page 3-33)
- [Best Practices for Using DRCP](#) (page 3-33)
- [Compatibility and Migration](#) (page 3-35)
- [DRCP Restrictions](#) (page 3-35)
- [Using DRCP with Custom Pools](#) (page 3-36)
- [Explicitly Marking Sessions Stateful or Stateless](#) (page 3-36)
- [Using DRCP with Oracle Real Application Clusters](#) (page 3-37)
- [Using DRCP with Pluggable Databases](#) (page 3-37)
- [DRCP with Data Guard](#) (page 3-38)

3.10.1 About Database Resident Connection Pool

DRCP pools server processes, each of which is the equivalent of a dedicated server process and database session combined; these are called **pooled servers**. Pooled servers can be shared by multiple applications running on the same or several hosts. A connection broker process manages the pooled servers at the database instance level.

DRCP is a configurable feature, chosen at application runtime. It allows concurrent use of traditional and DRCP-based connection architectures.

DRCP is especially useful for architectures with multiprocess single-threaded application servers (such as PHP and Apache) that cannot do middle-tier connection pooling. DRCP is also very useful in large-scale web deployments where hundreds or thousands of web servers or middle-tiers need database access and client-side pools (even in multithreaded systems and languages such as Java). Using DRCP, the database can scale to tens of thousands of simultaneous connections. If your database web application must scale to large numbers of connections, DRCP is your connection pooling solution.

DRCP complements middle-tier connection pools that share connections between threads in a middle-tier process. DRCP also enables sharing of database connections across middle-tier processes on the same middle-tier host, across multiple middle-tier hosts, and across multiple middle-tiers (web servers, containers) that accommodate applications written in different languages. This sharing significantly reduces the database resources needed to support a large number of client connections, thereby reducing the database tier memory footprint and increasing the scalability of both middle and database tiers. Having a pool of readily available servers also reduces the cost of creating and releasing client connections.

Clients get connections from the DRCP, which is connected to an Oracle Database background process called the connection broker. The connection broker implements the pool functionality and multiplexes pooled servers among persistent inbound connections from the client.

When a client needs database access, the connection broker gets a server process from the pool and gives it to the client. The client is then directly connected to the server. After the server executes the client request, the server process returns to the pool and the connection from the client is restored to the connection broker as a persistent inbound connection from the client process. In DRCP, releasing resources leaves the session intact, but no longer associated with a connection (server process). Because this session stores its user global area (UGA) in the program global area (PGA), not in the system global area (SGA), a client can reestablish a connection transparently upon detecting activity.

DRCP is typically recommended for applications with a large number of connections. Shared servers are recommended for applications with a medium number of connections and dedicated sessions are recommended for applications with a small number of connections. The threshold sizes depend on the amount of memory available on the database host.

DRCP has these advantages:

- DRCP enables resource sharing among multiple client applications and middle-tier application servers.
- DRCP improves scalability of databases and applications by reducing resource usage on the database host.

Compared to client-side connection pooling and shared servers:

- DRCP provides a direct connection to the database server, furnished by client-side connection pooling (like client-side connection pooling but unlike shared servers).
- DRCP can pool database servers (like client-side connection pooling and shared servers).
- DRCP can pool sessions (like client-side connection pooling but unlike shared servers).
- DRCP can share connections across middle-tier boundaries (unlike client-side connection pooling).

DRCP supports shared connections in both PDB and non-PDB environments.

DRCP offers a unique connection pooling solution that addresses scalability requirements in environments requiring large numbers of connections with minimal database resource usage.

See Also:

- *Oracle Database Concepts* for details about DRCP architecture
 - “Switching to a Container Using the ALTER SESSION Statement” in *Oracle Database Administrator’s Guide* for more information about switch service enhancements.
-
-

3.10.2 Configuring DRCP

DRCP is installed by default, but the DBA must start, and configure it using the `DBMS_CONNECTION_POOL` package. Configuration options include minimum and maximum number of pooled servers, number of connection brokers, maximum number of connections that each connection broker can handle, and so on.

Starting with Oracle Database 12c Release 2 (12.2.0.1), the new `MAX_TXN_THINK_TIME` parameter specifies the maximum time of inactivity allowed before termination for a client with an open transaction. This can be set to allow more time than the client that does not have transactions (specified by the `MAX_THINK_TIME` parameter value). This allows efficient pool reuse, while giving incomplete transactions a longer time to conclude.

OCI session pool APIs have been extended to interoperate with DRCP.

See Also:

- *Oracle Database PL/SQL Packages and Types Reference* for details about the `DBMS_CONNECTION_POOL` package
 - *Oracle Database Administrator’s Guide* for more information about Configuring the Connection Pool for Database Resident Connection Pooling
 - *Oracle Call Interface Programmer’s Guide*
 - *Oracle Database JDBC Developer’s Guide*
 - *Oracle Universal Connection Pool for JDBC Developer’s Guide*
-
-

3.10.3 Sharing Proxy Sessions

Starting with Oracle Database 12c Release 2 (12.2.0.1), proxy sessions in DRCP are shared among applications that are connected to the same schema.

3.10.4 Using JDBC with DRCP

Beginning with Oracle Database 12c Release 1 (12.1.0.1), Oracle JDBC drivers support DRCP. The DRCP implementation creates a pool on the server side, which is shared across multiple client pools. These client pools use Universal Connection Pool for JDBC. Using Universal Connection Pool significantly lowers memory consumption (because of the reduced number of server processes on the server) and increases the scalability of the Database server.

To track check-in and checkout operations of server-side connections, Java applications must use a client-side pool such as Universal Connection Pool for JDBC or a third-party Java connection pool.

[Starting Database Resident Connection Pool](#) (page 3-32) explains how the DBA starts DRCP on the server side.

To enable DRCP on the client side, you must do the following:

- Pass a non-NULL, nonempty String value to the connection property `oracle.jdbc.DRCPConnectionClass`.
- Pass `(SERVER=POOLED)` in the long connection string.

You can also specify `(SERVER=POOLED)` in the short URL form as follows:

```
jdbc:oracle:thin://<host>:<port>/<service_name>[:POOLED]
```

For example:

```
jdbc:oracle:thin://localhost:5221/orcl:POOLED
```

For an example of enabling JDBC on the client side, see the section on enabling DRCP on the client side in *Oracle Database JDBC Developer's Guide*.

By setting the same DRCP Connection class name for all the pooled server processes on the server using the connection property `oracle.jdbc.DRCPConnectionClass`, you can share pooled server processes on the server across multiple connection pools.

In DRCP, you can also apply a tag to a given connection and easily retrieve that tagged connection later. For more information about enabling connection tagging in DRCP, see *Oracle Database JDBC Developer's Guide*.

3.10.5 Using OCI Session Pool APIs with DRCP

The OCI session pool APIs `OCISessionPoolCreate()`, `OCISessionGet()`, and `OCISessionRelease()` interoperate with DRCP.

An OCI application initializes the environment for the OCI session pool for DRCP by invoking `OCISessionPoolCreate()`, which is described in *Oracle Call Interface Programmer's Guide*.

To get a session from the OCI session pool for DRCP, an OCI application invokes `OCISessionGet()`, specifying `OCI_SESSGET_SPOOL` for the mode parameter. For information about `OCISessionGet()`, see *Oracle Call Interface Programmer's Guide*.

To release a session to the OCI session pool for DRCP, an OCI application invokes `OCISessionRelease()`, which is described in *Oracle Call Interface Programmer's Guide*.

To improve performance, the OCI session pool can transparently cache connections to the connection broker. An OCI application can reuse the sessions within which the application leaves sessions of a similar state either by invoking `OCISessionGet()` with the `authInfofp` parameter set to `OCI_ATTR_CONNECTION_CLASS` and specifying a connection class name or by using the `OCIAuthInfo` handle before invoking `OCISessionGet()`. For details, see [Session Purity and Connection Class](#) (page 3-30).

DRCP also supports features offered by the traditional client-side OCI session pool, such as tagging, statement caching, and TAF.

3.10.6 Session Purity and Connection Class

In Oracle Database 11g Release 1 (11.1), OCI introduced two settings that can be specified when obtaining a session using `OCISessionGet()`: session purity and connection class.

Topics:

- [Session Purity](#) (page 3-30)
- [Connection Class](#) (page 3-31)
- [Example: Setting the Connection Class as HRMS](#) (page 3-31)
- [Example: Setting the Connection Class as RECMS](#) (page 3-31)
- [Session Purity and Connection Class Defaults](#) (page 3-32)

3.10.6.1 Session Purity

Session purity specifies whether an OCI application can reuse a pooled session (`OCI_SESSGET_PURITY_SELF`) or must use a new session (`OCI_SESSGET_PURITY_NEW`).

The application can set session purity either on the `OCIAuthInfo` handle before invoking `OCISessionGet()` or in the mode parameter when invoking `OCISessionGet()`.

[Example 3-1](#) (page 3-30) shows how a connection pooling application sets up a new session.

Example 3-1 Setting Session Purity for New Session

```
/* OCIAttrSet method */
ub4 purity = OCI_ATTR_PURITY_NEW;
OCIAttrSet(authInfofp, OCI_HTYPE_AUTHINFO, &purity, (ub4)sizeof(purity)
OCI_ATTR_PURITY, errhp);

/* OCISessionGet mode method */
OCISessionGet (envhp, errhp, &svchp, authInfofp, poolName, poolNameLen, NULL, 0,
NULL, NULL, NULL, OCI_SESSGET_SPOOL);
/* poolName is the name returned by OCISessionPoolCreate() */
```

Note:

When reusing a pooled session, the NLS attributes of the server override those of the client.

For example, if the client sets `NLS_LANG` to `french_france.us7ascii` and then is assigned a German session from the pool, the client session becomes German.

To avoid this problem, use connection classes to restrict sharing.

3.10.6.2 Connection Class

Connection class defines a logical name for the type of connection that an OCI application needs. When a pooled session has a connection class, OCI ensures that the session is not shared outside of that connection class.

For example, a connection class can prevent the following from sharing pooled sessions:

- Different users
(A session first created for user HR is assigned only to subsequent requests by user HR.)
- Different sessions of the same user
- Different applications being run by the same user
(Each application can have its own connection class.)

To set the connection class, you can use the `OCI_ATTR_CONNECTION_CLASS` attribute of the `OCIAuthInfo` handle. A connection class name is a string of at most 1024 bytes, and it cannot include an asterisk (*).

3.10.6.3 Example: Setting the Connection Class as HRMS

You can use the `OCISessionPoolCreate` API to set a connection class as HRMS.

[Example 3-2](#) (page 3-31) specifies that an HRMS application needs sessions with the connection class HRMS.

Example 3-2 Setting the Connection Class as HRMS

```
OCISessionPoolCreate (envhp, errhp, spoolhp, &poolName, &poolNameLen, "HRDB",
    strlen("HRDB"), 0, 10, 1, "HR", strlen("HR"), "HR", strlen("HR"),
    OCI_SPC_HOMOGENEOUS);

OCIAttrSet (authInfofp, OCI_HTYPE_AUTHINFO, "HRMS", strlen ("HRMS"),
    OCI_ATTR_CONNECTION_CLASS, errhp);

OCISessionGet (envhp, errhp, &svchp, authInfofp, poolName, poolNameLen, NULL, 0,
    NULL, NULL, NULL, OCI_SESSGET_SPOOL);
```

3.10.6.4 Example: Setting the Connection Class as RECMS

You can use the `OCISessionPoolCreate` API to create a connection class as RECMS.

[Example 3-3](#) (page 3-32) specifies that a recruitment application needs sessions with the connection class RECMS.

Example 3-3 Setting the Connection Class as RECMS

```

OCISessionPoolCreate (envhp, errhp, spoolhp, &poolName, &poolNameLen, "HRDB",
    strlen("HRDB"), 0, 10, 1, "HR", strlen("HR"), "HR", strlen("HR"),
    OCI_SPC_HOMOGENEOUS);

OCIAttrSet (authInfop, OCI_HTYPE_AUTHINFO, "RECMS", strlen("RECMS"),
    OCI_ATTR_CONNECTION_CLASS, errhp);
OCISessionGet (envhp, errhp, &svchp, authInfop, poolName, poolNameLen, NULL, 0,
    NULL, NULL, NULL, OCI_SESSGET_SPOOL);

```

3.10.6.5 Session Purity and Connection Class Defaults

[Table 3-5](#) (page 3-32) shows the defaults for the attributes and settings of connections that an OCI application gets from the OCI session pool (using `OCISessionGet()`) and from other sources.

Table 3-5 Session Purity and Connection Class Defaults

Attribute or Setting	Default Value for Connection From OCI Session Pool	Default Value for Connection Not From OCI Session Pool
OCI_ATTR_PURITY	OCI_ATTR_PURITY_SELF	OCI_ATTR_PURITY_NEW
OCI_ATTR_CONNECTION_CLASSES	OCI-generated globally unique name for each client-side session pool, used as the default connection class for all connections in the OCI session pool	SHARED
Sessions shared by ...	Threads that request sessions from the OCI session pool	Connections to a particular database that have the SHARED connection class

3.10.7 Starting Database Resident Connection Pool

The DBA must log on as SYSDBA and start the default pool, `SYS_DEFAULT_CONNECTION_POOL`, using `DBMS_CONNECTION_POOL.START_POOL` with the default settings.

For detailed information about configuring the pool, see *Oracle Database Administrator's Guide*.

3.10.8 Enabling DRCP

To enable DRCP in an application, specify either `:POOLED` in the Easy Connect string (as in [Example 3-4](#) (page 3-32)) or `(SERVER=POOLED)` in the TNS connect string (as in [Example 3-5](#) (page 3-32)).

Example 3-4 Enabling DRCP With :POOLED in Easy Connect String

```
oraclehost.company.com:1521/books.company.com:POOLED
```

Example 3-5 Enabling DRCP With SERVER=POOLED in TNS Connect String

```
BOOKSDB = (DESCRIPTION=(ADDRESS=(PROTOCOL=tcp)(HOST=oraclehost.company.com)
(PORT=1521))(CONNECT_DATA = (SERVICE_NAME=books.company.com)(SERVER=POOLED)))
```

3.10.9 Benefiting from the Scalability of DRCP in an OCI Application

Consider the following OCI application scenarios and how they benefit from DRCP:

- An application neither uses the OCI session pool nor specifies a connection class or purity setting (or specifies `PURITY=NEW`).

The application gets a new session from DRCP. When the application returns a connection to the pool, the session is not shared with other instances of the same application by default. Therefore, the pooled server remains assigned to the client for the life of the client session. (SQL*Plus is an example of a client that does not use the OCI session pool. SQL*Plus keeps connections even when they are idle.)

The application benefits from reusing an existing pooled server.

- An application invokes `OCISessionGet()` outside of the OCI session pool, or to specify the connection class and `PURITY=SELF`.

The application can reuse both DRCP pooled servers and sessions. However, after an `OCISessionRelease()` call, OCI terminates the connection to the connection broker. On the next `OCISessionGet()` call, the application reconnects to the broker, and then DRCP assigns a pooled server (and session) belonging to the specified connection class. Reconnecting incurs the cost of connection establishment and reauthentication.

The application achieves better sharing of DRCP resources (processes and sessions) but does not benefit from caching connections to the connection broker.

- An application uses OCI session pool APIs, specifies a connection class, and specifies `PURITY=SELF`.

The application uses all DRCP functionality, reusing both the pooled server and the associated session and benefiting from cached connections to the connection broker. Cached connections do not incur the cost of reauthentication on the `OCISessionGet()` call.

See Also:

Oracle Call Interface Programmer's Guide for information about `OCISessionPoolCreate()`, `OCISessionGet()`, `OCISessionRelease()`, and `OCISessionPoolDestroy()`

3.10.10 Benefiting from the Scalability of DRCP in a Java Application

Java applications benefit from DRCP as OCI applications do (see [Benefiting from the Scalability of DRCP in an OCI Application](#) (page 3-32)).

A customer who uses Universal Connection Pool (UCP), or uses `ConnectionPoolDataSource` as the connection factory, can upgrade to using DRCP by changing only the configuration (not the code).

3.10.11 Best Practices for Using DRCP

The steps for designing an application that can benefit from the full power of DRCP are very similar to those for an application that uses the OCI session pool (for details, see *Oracle Call Interface Programmer's Guide*).

The only additional step is that for best performance, when deployed to run with DRCP, the application must explicitly specify a connection class.

Multiple instances of the same application must specify the same connection class for best performance and enhanced sharing of DRCP resources. Ensure that the different instances of the application can share database sessions.

[Example 3-6](#) (page 3-34) shows a DRCP application.

Example 3-6 DRCP Application

```

/* Assume that all necessary handles are allocated. */

/* This middle tier uses a single database user. Create a homogeneous
   client-side session pool */
OCISessionPoolCreate (envhp, errhp, spoolhp, &poolName, &poolNameLen, "BOOKSDB",
    strlen("BOOKSDB"), 0, 10, 1, "SCOTT", strlen("SCOTT"), "password",
    strlen("password"), OCI_SPC_HOMOGENEOUS);

while (1)
{
    /* Process a client request */
    WaitForClientRequest();
    /* Application function */

    /* Set the Connection Class on the OCIAuthInfo handle that is passed as
       argument to OCISessionGet*/

    OCIAttrSet (authInfop, OCI_HTYPE_AUTHINFO, "BOOKSTORE", strlen("BOOKSTORE"),
        OCI_ATTR_CONNECTION_CLASS, errhp);

    /* Purity need not be set, as default is OCI_ATTR_PURITY_SELF
       for OCISessionPool connections */

    /* You can get a SCOTT session released by Middle-tier 2 */
    OCISessionGet(envhp, errhp, &svchp, authInfop, poolName, poolNameLen, NULL, 0,
        NULL, NULL, NULL, OCI_SESSGET_SPOOL);

    /* Database calls using the svchp obtained above */
    OCIStmtExecute(...)

    /* This releases the pooled server on the database for reuse */
    OCISessionRelease (svchp, errhp, NULL, 0, OCI_DEFAULT);
}

/* Middle tier is done - exiting */
OCISessionPoolDestroy (spoolhp, errhp, OCI_DEFAULT);

```

[Example 3-7](#) (page 3-34) and [Example 3-8](#) (page 3-35) show connect strings that deploy code in 10 middle-tier hosts that service the BOOKSTORE application from [Example 3-6](#) (page 3-34).

In [Example 3-7](#) (page 3-34), assume that the database is Oracle Database 12c (or earlier) in dedicated server mode with DRCP not enabled and that the client has 12c libraries. The application gets dedicated server connections from the database.

Example 3-7 Connect String for Deployment in Dedicated Server Mode Without DRCP

```

BOOKSDB = (DESCRIPTION=(ADDRESS=(PROTOCOL=tcp)(HOST=oraclehost.company.com)
    (PORT=1521))(CONNECT_DATA = (SERVICE_NAME=books.company.com)))

```

In [Example 3-8](#) (page 3-35), assume that DRCP is enabled on the Oracle Database 12c database. All middle-tier processes can benefit from the pooling capability of DRCP. The database resource requirement with DRCP is much less than it would be in dedicated server mode.

Example 3-8 Connect String for Deployment With DRCP

```
BOOKSDB = (DESCRIPTION=(ADDRESS=(PROTOCOL=tcp)(HOST=oraclehost.company.com)
(PORT=1521))(CONNECT_DATA = (SERVICE_NAME=books.company.com)(SERVER=POOLED)))
```

3.10.12 Compatibility and Migration

An OCI application linked with Oracle Database 12c client libraries works unaltered with:

- An Oracle Database 12c database with DRCP disabled
- A database server from a release earlier than Oracle Database 12c
- An Oracle Database 12c database server with DRCP enabled, when deployed with the DRCP connect string

Suitable clients benefit from enhanced scalability offered by DRCP if they are appropriately modified to use the OCI session pool APIs with the connection class and purity settings previously described.

As of Oracle Database 12c Release 1 (12.1.0.1), Oracle JDBC drivers support DRCP. For more information, see *Oracle Database JDBC Developer's Guide*.

3.10.13 DRCP Restrictions

The following cannot be performed with pooled servers:

- Shutting down the database
- Stopping DRCP
- Changing the password for the connected user
- Using shared database links to connect to a DRCP that is on a different instance
- Using Advanced Security Options (ASO) with TCPS
- Using Enterprise user security with DRCP
- Using migratable sessions on the server side, either directly (using the OCI_MIGRATE option) or indirectly (invoking OCI_SessionPoolCreate())
- Using initial client roles
- Using application context attributes (such as OCI_ATTR_APPCTX_NAME and OCI_ATTR_APPCTX_VALUE)

Sessions created before DDL statements run can be assigned to clients after DDL statements run. Therefore, be careful when running DDL statements that affect database users in the pool. For example, before dropping a user, ensure that there are no sessions of that user in the pool and no connections to the broker that were authenticated as that user.

If sessions with explicit roles enabled are released to the pool, they can later be assigned to connections (of the same user) that need the default logon role. Therefore, avoid releasing sessions with explicit roles; instead, terminate them.

Note:

You can use Oracle Advanced Security features such as encryption and strong authentication with DRCP.

Users can mix data encryption/data integrity combinations. However, users must segregate each such combination by using connection classes. For example, if the user application must specify AES256 as the encryption mechanism for one set of connections and DES for another set of connections, then the application must specify different connection classes for each set.

3.10.14 Using DRCP with Custom Pools

Oracle highly recommends using the OCI session pool, which is already integrated with DRCP, FAN, and RLB. However, an application that does not use the OCI session pool can still use DRCP if either of the following is true:

- The application was built using its own custom connection pool.
- The application uses no pool, but has periods when it does not use its session (and could therefore release it to a pool) and does not depend on getting back the same session

To use DRCP with such an application, the session must be stateful; that is, the session must have the `OCI_ATTR_SESSION_STATE` attribute (described in *Oracle Call Interface Programmer's Guide*). When an application is stateful and DRCP is enabled, OCI transparently assigns it an appropriate session from the DRCP pool. If the application is stateless (has the `OCI_SESSION_STATELESS` attribute) and DRCP is enabled, OCI transparently returns the session to the DRCP pool.

Applications must identify session state as promptly as possible for efficient utilization of underlying database resources. For more information, see [Explicitly Marking Sessions Stateful or Stateless](#) (page 3-36).

Note:

An application that specifies the attribute `OCI_ATTR_SESSION_STATE` or `OCI_SESSION_STATELESS` must also specify session purity and connection class, which are explained in [Session Purity and Connection Class](#) (page 3-30).

3.10.15 Explicitly Marking Sessions Stateful or Stateless

An application typically requires a specific database session for the duration of a unit of work. For this duration, the session is **stateful**. After this duration, if the application does not depend on retaining the specific session for subsequent units of work, then the session is **stateless**.

When an application or caller detects a session's transition from stateful to stateless, or the reverse, the application can explicitly inform OCI of the transition by using the `OCI_ATTR_SESSION_STATE` or `OCI_SESSION_STATELESS` attribute. This information lets OCI and Oracle Database transparently perform scalability optimizations, such as reassigning the session that the application is not using to someone else and then assigning the application a new session when necessary.

See Also:[Using DRCP with Custom Pools](#) (page 3-36)

[Example 3-9](#) (page 3-37) shows a code fragment that explicitly marks session states.

Example 3-9 Explicitly Marking Sessions Stateful or Stateless

```

wait_for_transaction_request();
do {

    ubl state;

    /* mark database session as STATEFUL */
    state = OCI_SESSION_STATEFUL;
    checkerr(errhp, OCIAttrSet(usrhp, OCI_HTYPE_SESSION,
        &state, 0, OCI_ATTR_SESSION_STATE, errhp));
    /* do database work consisting of one or more related calls to the database */

    ...

    /* done with database work, mark session as stateless */
    state = OCI_SESSION_STATELESS;
    checkerr(errhp, OCIAttrSet(usrhp, OCI_HTYPE_SESSION,
        &state, 0, OCI_ATTR_SESSION_STATE, errhp));

    wait_for_transaction_request();

} while(not _done);

```

A session obtained from outside the OCI session pool is marked `OCI_SESSION_STATEFUL` and remains `OCI_SESSION_STATEFUL` unless the application explicitly marks it `OCI_SESSION_STATELESS`.

A session obtained from the OCI session pool is marked `OCI_SESSION_STATEFUL` by default when the first call is initiated on that session. When the session is released to the pool, it is marked `OCI_SESSION_STATELESS` by default. Therefore, you need not explicitly mark sessions as stateful or stateless when you use the OCI session pool.

See Also:

Oracle Call Interface Programmer's Guide for more information about `OCI_ATTR_SESSION_STATE`

3.10.16 Using DRCP with Oracle Real Application Clusters

Oracle Real Application Clusters (Oracle RAC) is a database option in which a single database is hosted by multiple instances on multiple nodes. When DRCP is configured in a database in an Oracle RAC environment, the pool configuration is applied to each database instance. Starting or stopping the pool on one instance starts or stops the pool on all instances.

3.10.17 Using DRCP with Pluggable Databases

The DRCP in a multitenant container database (CDB) is configured and managed in the root container. You can configure, start, and stop the pool when you are connected

to the root container. The pool maintains the pooled servers of different pluggable databases to which the clients are connected using different service names.

3.10.18 DRCP with Data Guard

When operating DRCP in a Data Guard environment:

- On a physical standby database:
 - You can start the pool only if the pool is running on the primary database.
 - You can stop the pool only if the pool is stopped on the primary database.
 - You cannot configure, restore to defaults, or alter pool parameters.

The preceding restrictions cease to apply to the physical standby database if it becomes the primary database.

- On a logical standby database, all pool operations are allowed.

Designing Applications for Oracle Real-World Performance

When you design applications for real world performance, you should consider how code for bind variables, instrumentation, and set-based processing.

Topics:

- [Using Bind Variables](#) (page 4-1)
- [Using Instrumentation](#) (page 4-2)
- [Using Set-Based Processing](#) (page 4-2)

4.1 Using Bind Variables

A bind variable placeholder in a SQL statement or PL/SQL block indicates where data must be supplied at runtime.

Suppose that you want your application to insert data into the table created with this statement:

```
CREATE TABLE test (x VARCHAR2(30), y VARCHAR2(30));
```

Because the data is not known until runtime, you must use dynamic SQL.

The following statement inserts a row into table `test`, concatenating string literals for columns `x` and `y`:

```
INSERT INTO test (x,y) VALUES ( ' ' || REPLACE (x, ' ', ' ') || ' ',  
                                ' ' || REPLACE (y, ' ', ' ') || ' ');
```

The following statement inserts a row into table `test` using bind variables `:x` and `:y` for columns `x` and `y`:

```
INSERT INTO test (x,y) VALUES (:x, :y);
```

The statement that uses bind variable placeholders is easier to code.

Now consider a dynamic bulk load operation that inserts 1,000 rows into table `test` using each of the preceding methods.

The method that concatenates string literals uses 1,000 `INSERT` statements, each of which must be hard-parsed, qualified, checked for security, optimized, and compiled. Because each statement is hard-parsed, the number of latches greatly increases. Latches are mutual-exclusion locking mechanisms—serialization devices, which inhibit concurrency.

A method that uses bind variable placeholders uses only one `INSERT` statement. The statement is soft-parsed, qualified, checked for security, optimized, compiled, and cached in a shared pool. The compiled statement from the shared pool is used for each

of the 1000 inserts. This statement caching is a very important benefit of using bind variables.

An application that uses bind variable placeholders is more scalable, supports more users, requires fewer resources, and runs faster than an application that uses string concatenation—and it is less vulnerable to SQL injection attacks. If a SQL statement uses string concatenation, an end user can modify the statement and use the application to do something harmful.

You can use bind variable placeholders for input variables in `DELETE`, `INSERT`, `SELECT`, and `UPDATE` statements, and anywhere in a PL/SQL block that you can use an expression or literal. In PL/SQL, you can also use bind variable placeholders for output variables. Binding is used for both input and output variables in nonquery operations.

See Also:

- *Oracle Database PL/SQL Language Reference* for more information about using bind variables to protect your application from SQL injection
 - *Oracle Call Interface Programmer's Guide* for more information about using bind variable placeholders in OCI
-
-

Videos:

To learn Oracle Real-World Performance techniques for using bind variables, see the following videos:

- RWP #3: Connection Pools and Hard Parsing
 - RWP #4: Bind Variables and Soft Parsing
 - RWP #5: Shared Cursors and One Parse
 - RWP #6: Leaking Cursors
 - RWP #19: Architecture with an AWR Report
-
-

4.2 Using Instrumentation

To use instrumentation means adding debug code throughout your application. When enabled, this code generates trace files, which contain information that helps you identify and locate problems. Trace files are especially helpful when debugging multitier applications; they help you identify the problematic tier.

See Also:

[SQL Trace Facility \(SQL_TRACE\)](#) (page 3-6) for more information

4.3 Using Set-Based Processing

A common task in database applications in a data warehouse environment is querying or modifying a huge data set.

For example, an application might join data sets numbering in the tens of millions of rows, filter on a set of criteria, perform aggregations, and then display the result to the user. Alternatively, an application might filter out rows from one billion-row table based on specified criteria, and then insert matching rows into another table.

The problem for application developers is how to achieve high performance when processing these large data sets. Processing techniques fall into two categories: iterative, and set-based. Over years of testing, the Oracle Real-World Performance group has discovered that set-based processing techniques perform orders of magnitude better for database applications that process large data sets.

Topics:

- [Iterative Data Processing](#) (page 4-3)
- [Using Set-Based Processing](#) (page 4-2)

4.3.1 Iterative Data Processing

Iterative data processing processes data row by row, using arrays, or using manual parallelism.

Topics:

- [About Iterative Data Processing](#) (page 4-3)
- [Iterative Data Processing: Row-By-Row](#) (page 4-3)
- [Iterative Data Processing: Arrays](#) (page 4-5)
- [Iterative Data Processing: Manual Parallelism](#) (page 4-6)

4.3.1.1 About Iterative Data Processing

In this type of processing, applications use conditional logic to iterate through a set of rows.

You can write iterative applications in PL/SQL, Java, or any other procedural or object-oriented language. The technique is "iterative" because it breaks the row source into subgroups containing one or more rows, and then processes each subgroup. A single process can iterate through all subgroups, or multiple processes can iterate through the subgroups in parallel.

Typically, although not necessarily, iterative processing uses a client/server model as follows:

1. Transfer a group of rows from the database server to the client application.
2. Process the group within the client application.
3. Transfer the processed group back to the database server.

You can implement iterative algorithms using three main techniques: row-by-row processing, array processing, and manual parallelism. Each technique obtains the same result, but from a performance perspective, each has its benefits and drawbacks.

4.3.1.2 Iterative Data Processing: Row-By-Row

Of the iterative techniques, row-by-row processing is the most common.

A single process loops through a data set and operates on a single row a time. In a typical implementation, the application retrieves each row from the database,

processes it in the middle tier, and then sends the row back to the database, which executes DML and commits.

Assume that your functional requirement is to query an external table named `ext_scan_events`, and then insert its rows into a heap-organized staging table named `stage1_scan_events`. The following PL/SQL block uses a row-by-row technique to meet this requirement:

```
declare
  cursor c is select s.* from ext_scan_events s;
  r c%rowtype;
begin
  open c;
  loop
    fetch c into r;
    exit when c%notfound;
    insert into stage1_scan_events d values r;
    commit;
  end loop;
  close c;
end;
```

The row-by-row code uses a cursor loop to perform the following actions:

1. Fetch a single row from `ext_scan_events` to the application running in the client host, or exit the program if no more rows exist.
2. Insert the row into `stage1_scan_events`.
3. Commit the preceding insert.
4. Return to Step 1.

The row-by-row technique has the following advantages:

- It performs well on small data sets. Assume that `ext_scan_events` contains 10,000 records. If the application processes each row in 1 millisecond, then the total processing time is 10 seconds.
- The looping algorithm is familiar to all professional developers, easy to write quickly, and easy to understand.

The row-by-row technique has the following disadvantages:

- Processing time can be unacceptably long for large data sets. If `ext_scan_events` contains 1 billion rows, and if the application processes each row in an average of 1 miliseconds, then the total processing time is 12 days. Processing a trillion-row table requires *32 years*.
- The application executes serially, and thus cannot exploit the native parallel processing features of Oracle Database running on modern hardware. For example, the row-by-row technique cannot benefit from a multi-core computer, Oracle RAC, or Oracle Exadata Machine. For example, if the database host contains 16 CPUs and 32 cores, then 31 cores will be idle when the sole database server process reads or write each row. If multiple instances exist in an Oracle RAC deployment, then only one instance can process the data.

Video:

RWP #7: Set-Based Processing

4.3.1.3 Iterative Data Processing: Arrays

Array processing is identical to row-by-row processing, except that it processes a group of rows in each iteration rather than a single row.

Like the row-by-row technique, array processing is serial, which means that only one database server process operates on a group of rows at one time. In a typical array implementation, the application retrieves each group of rows from the database, processes it in the middle tier, and then sends the group back to the database, which performs DML for the group of rows, and then commits.

Assume that your functional requirement is the same as in the example in [Iterative Data Processing: Row-By-Row](#) (page 4-3): query an external table named `ext_scan_events`, and then insert its rows into a heap-organized staging table named `stage1_scan_events`. The following PL/SQL block, which you execute in SQL*Plus on a separate host from the database server, uses an array technique to meet this requirement:

```
declare
  cursor c is select s.* from ext_scan_events s;
  type t is table of c%rowtype index by binary_integer;
  a t;
  rows binary_integer := 0;
begin
  open c;
  loop
    fetch c bulk collect into a limit array_size;
    exit when a.count = 0;
    forall i in 1..a.count
      insert into stage1_scan_events values a(i);
    commit;
  end loop;
  close c;
end;
```

The preceding code differs from the equivalent row-by-row code in using a BULK COLLECT operator in the FETCH statement, which is limited by the `array_size` value of type `PLS_INTEGER`. For example, if `array_size` is set to 100, then the application fetches rows in groups of 100.

The cursor loop performs the following sequence of actions:

1. Fetch an array of rows from `ext_scan_events` to the application running in the client host, or exit the program when the loop counter equals 0.
2. Loop through the array of rows, and insert each row into the `stage1_scan_events` table.
3. Commit the preceding inserts.
4. Return to Step 1.

In PL/SQL, the array code differs from the row-by-row code in using a counter rather than the cursor attribute `c%notfound` to test the exit condition. The reason is that if the fetch collects the last group of rows in the table, then `c%notfound` forces the loop

to exit, which is undesired behavior. When using a counter, each fetch collects the specified number of rows, and when the collection is empty, the program exits.

The array technique has the following advantages over the row-by-row technique:

- The array enables the application to process a group of rows at the same time, which means that it reduces network round trips, COMMIT time, and the code path in the client and server. When combined, these factors can potentially reduce the total processing time by an order of magnitude
- The database is more efficient because the server process batches the inserts, and commits after every group of inserts rather than after every insert. Reducing the number of commits reduces the I/O load and lessens the probability of log sync wait events.

The disadvantages of this technique are the same as for row-by-row processing. Processing time can be unacceptable for large data sets. For a trillion-row table, reducing processing time from 32 years to 3.2 years is still unacceptable. Also, the application must run serially on a single CPU core, and thus cannot exploit the native parallelism of Oracle Database.

4.3.1.4 Iterative Data Processing: Manual Parallelism

Manual parallelism uses the same iterative algorithm as row-by-row and array processing, but enables multiple server processes to work on the job concurrently.

In a typical implementation, the application scans the source data multiple times, and then uses the `ORA_HASH` function to divide the data among the parallel insert processes.

The `ORA_HASH` function computes a hash value for a given expression. The function accepts three arguments:

- *expr*, which is typically a column name
- *max_bucket*, which specifies the number of hash buckets
- *seed_value*, which enables multiple results from the same data (the default is 0)

For example, the following statement divides the sales table into 10 buckets of rows, numbered 0 to 9, and returns the rows from bucket 1:

```
SELECT * FROM sales WHERE ORA_HASH(cust_id, 9) = 1;
```

If an application uses `ORA_HASH` in this way, and if *n* hash buckets exists, then each server process operates on $1/n$ of the data.

Assume the functional requirement is the same as in the row-by-row and array examples: to read scan events from source tables, and then insert them into the `stage1_scan_events` table. The primary differences are as follows:

- The scan events are stored in a mass of flat files. The `ext_scan_events_dets` table describes these flat files. The `ext_scan_events_dets.file_seq_nbr` column stores the numerical primary key, and the `ext_file_name` column stores the file name.
- 32 server processes must run in parallel, with each server process querying a different external table. The 32 external tables are named `ext_scan_events_0` through `ext_scan_events_31`. However, each server process inserts into the same `stage1_scan_events` table.

- You use PL/SQL to achieve the parallelism by executing 32 threads of the same PL/SQL program, with each thread running simultaneously as a separate job managed by Oracle Scheduler. A job is the combination of a schedule and a program.

The following PL/SQL code, which you execute in SQL*Plus on a separate host from the database server, uses manual parallelism:

```

declare
  sqlstmt varchar2(1024) := q'[
-- BEGIN embedded anonymous block
  cursor c is select s.* from ext_scan_events_${thr} s;
  type t is table of c%rowtype index by binary_integer;
  a t;
  rows binary_integer := 0;
begin
  for r in (select ext_file_name from ext_scan_events_dets where
ora_hash(file_seq_nbr,${thrs}) = ${thr})
  loop
    execute immediate
      'alter table ext_scan_events_${thr} location' || '(' || r.ext_file_name || ')';
    open c;
    loop
      fetch c bulk collect into a limit ${array_size};
      exit when a.count = 0;
      forall i in 1..a.count
        insert into stagel_scan_events d values a(i);
      commit;
-- demo instrumentation
      rows := rows + a.count; if rows > 1e3 then exit when not
sd_control.p_progress('loading','userdefined',rows); rows := 0; end if;
    end loop;
    close c;
  end loop;
end;
-- END embedded anonymous block
]';

begin
  sqlstmt := replace(sqlstmt, '${array_size}', to_char(array_size));
  sqlstmt := replace(sqlstmt, '${thr}', thr);
  sqlstmt := replace(sqlstmt, '${thrs}', thrs);
  execute immediate sqlstmt;
end;

```

This program has three iterative constructs, from outer to inner:

1. An outer FOR LOOP that retrieves names of flat files, and uses DDL to specify the flat file name as the location of an external table
2. A middle LOOP statement that fetches groups of rows from a query of the external table.
3. An innermost FORALL statement that iterates through each group and inserts the rows

In this sample program, you set \$thrs to 31 in every job, and set \$thr to a different value between 0 and 31 in every job. For example, job 1 might have \$thr set to 0, job 2 might have \$thr set to 1, and so on.

In the program executed by the first job, with `$thr` set to 0, the outer `FOR LOOP` iterates through the results of the following query:

```
select ext_file_name
from   ext_scan_events_dets
where  ora_hash(file_seq_nbr,31) = 0
```

The `ORA_HASH` function divides the `ext_scan_events_dets` table into 32 evenly distributed buckets, and then the `SELECT` statement retrieves the file names for bucket 0. For example, the query result set might contain the following file names:

```
/disk1/scan_ev_101
/disk2/scan_ev_003
/disk1/scan_ev_077
...
/disk4/scan_ev_314
```

The middle `LOOP` iterates through the list of file names. For example, the first file name in the result set might be `/disk1/scan_ev_101`. For job 1 the external table is named `ext_scan_events_0`, so the first iteration of the `LOOP` changes the location of this table as follows:

```
alter table ext_scan_events_0 location(/disk1/scan_ev_101);
```

In the innermost `FORALL` statement, the `BULK COLLECT` operator retrieves rows from the `ext_scan_events_0` table into an array, inserts the rows into the `stage1_scan_events` table, and then commits the bulk insert. When the program exits the `FORALL` statement, the program proceeds to the next item in the loop, changes the file location of the external table to `/disk2/scan_ev_003`, and then queries, inserts, and commits rows as in the previous iteration. Job 1 continues processing in this way until all records contained in the flat files corresponding to hash bucket 0 have been inserted in the `stage1_scan_events` table.

While job 1 is executing, the other 31 Oracle Scheduler jobs execute in parallel. For example, job 2 sets `$thr` to 1, which defines the cursor as a query of table `ext_scan_events_1`, and so on through job 32, which sets `$thr` to 31 and defines the cursor as a query of table `ext_scan_events_31`. In this way, each job simultaneously reads a different subset of the scan event files, and inserts the records from its subset into the same `stage1_scan_events` table.

The manual parallelism technique has the following advantages over the alternative iterative techniques:

- It performs far better on large data sets because server processes are working in parallel. For example, if 32 processes are dividing the work, and if the database has sufficient CPU and memory resources and experiences no contention, then the database might perform 32 insert jobs in the time that the array technique took to perform a single job. The performance gain for a large data set is often an order of magnitude greater than serial techniques.
- When the application uses `ORA_HASH` to distribute the workload, each thread of execution can access the same amount of data. If each thread reads and writes the same amount of data, then the parallel processes can finish at the same time, which means that the database utilizes the hardware for as long as the application takes to run.

The manual parallelism technique has the following disadvantages:

- The code is relatively lengthy, complicated, and difficult to understand. The algorithm is complicated because the work of distributing the workload over many threads falls to the developer rather than the database. Effectively, the application runs serial algorithms in parallel rather than running a parallel algorithm.
- Typically, the startup costs of dividing the data have a fixed overhead. The application must perform a certain amount of preparatory work before the database can begin the main work, which is processing the rows in parallel. This startup limitation does not apply to the competing techniques, which do not divide the data.
- If multiple threads perform the same operations on a common set of database objects, then lock and latch contention is possible. For example, if 32 different server processes are attempting to update the same set of buffers, then buffer busy waits are probable. Also, if multiple server processes are issuing COMMIT statements at roughly the same time, then log file sync waits are probable.
- Parallel processing consumes significant CPU resources compared to the competing iterative techniques. If the database host does not have sufficient cores available to process the threads simultaneously, then performance suffers. For example, if only 4 cores are available to 32 threads, then the probability of a thread having CPU available at a given time is 1/8.

Video:

RWP #8: Set-Based Parallel Processing

4.3.2 Set-Based Processing

Set-based processing is a SQL technique that processes a data set inside the database.

In a set-based model, the SQL statement defines the result, and allows the database to determine the most efficient way to obtain it. In contrast, iterative algorithms use conditional logic to pull each row or group of rows from the database to the client application, process the data on the client, and then send the data back to the database. Set-based processing eliminates the network round-trip and database API overhead because the data never leaves the database. It reduces the number of COMMITS.

Assume the same functional requirement as in the previous examples. The following SQL statements meet this requirement using a set-based algorithm:

```
alter session enable parallel dml;
insert /*+ APPEND */ into stagel_scan_events d
  select s.* from ext_scan_events s;
commit;
```

Because the INSERT statement contains a subquery of the `ext_scan_events` table, a *single* SQL statement reads and writes all rows. Also, the application executes a *single* COMMIT after the database has inserted all rows. In contrast, iterative applications execute a COMMIT after the insert of each row or each group of rows.

The set-based technique has significant advantages over iterative techniques:

- As demonstrated in Oracle Real-World Performance demonstrations and classes, the performance on large data sets is orders of magnitude faster. It is not unusual for the run time of a program to drop from several hours to several seconds. The

improvement in performance for large data sets is so profound that iterative techniques become extremely difficult to justify.

- A side-effect of the dramatic increase in processing speed is that DBAs can eliminate long-running and error-prone batch jobs, and innovate business processes in real time. For example, instead of running a 6-hour batch job every night, a business can run a 12-second job as needed during the day.
- The length of the code is significantly shorter, as short as two or three lines of code, because SQL defines the result and not the access method. This means that the database, rather than the application, decides the best way to divide, retrieve, and manipulate the rows.
- In contrast to manual parallelism, parallel DML is optimized for performance because the database, rather than the application, manages the processes. Thus, it is not necessary to divide the workload manually in the client application, and hope that each process finishes at the same time.
- When joining data sets, the database automatically uses highly efficient hash joins instead of relatively inefficient application-level loops.
- The `APPEND` hint forces a direct-path load, which means that the database creates no redo and undo, thereby avoiding the waste of I/O and CPU. In typical ETL workloads, the buffer cache poses a problem. Modifying data inside the buffer cache, and then writing back the data and its associated undo and redo, consumes significant resources. Because the buffer cache cannot manage blocks fast enough, and because the CPU costs of manipulating blocks into the buffer cache and back out again (usually one 8 K block at a time) are high, both the database writer and server processes must work extremely hard to keep up with the volume of buffers.

The disadvantages of set-based processing:

- The techniques are unfamiliar to many database developers, so they are more difficult. The `INSERT` example is relatively simple. However, more complicated algorithms required more complicated statements that may require multiple outer joins. Developers who are not familiar with pipelining outer joins and using `WITH` clauses and `CASE` statements may be daunted by the prospect of both writing and understanding set-based code.
- Because a set-based model is completely different from an iterative model, changing it requires completely rewriting the source code. In contrast, changing row-by-row code to array-based code is relatively trivial.

Despite the disadvantages of set-based processing, the Oracle Real-World Performance group believes that the enormous performance gains for large data sets justify the effort.

Videos:

- [RWP #7 Set-Based Processing](#)
 - [RWP #8: Set-Based Parallel Processing](#)
 - [RWP #9: Set-Based Processing--Data Deduplication](#)
 - [RWP #10: Set-Based Processing--Data Transformations](#)
 - [RWP #11: Set-Based Processing--Data Aggregation](#)
-
-

This chapter explains some fundamentals of designing security into the database and database applications.

Topics:

- [Enabling User Access with Grants, Roles, and Least Privilege](#) (page 5-1)
- [Automating Database Logins](#) (page 5-2)
- [Controlling User Access with Fine-Grained Access Control](#) (page 5-3)
- [Using Invoker's and Definer's Rights for Procedures and Functions](#) (page 5-4)
- [Managing External Procedures for Your Applications](#) (page 5-6)
- [Auditing User Activity](#) (page 5-7)

5.1 Enabling User Access with Grants, Roles, and Least Privilege

This topic explains how you can grant privileges and roles to users to restrict access to data. It also explains the importance of the concept of least privilege, introduces secure application roles as a way to automatically filter out users who attempt to log in to your applications.

A user **privilege** is the right to perform an action, such as updating or deleting data. You can grant users privileges to perform these actions. A **role** is named collection of privileges that are grouped together, usually to enable users to perform a set of tasks related to their jobs. For example, a role called `clerk` can enable clerks to do things like create, update, and delete files. The `clerk_mgr` role can include the `clerk` role, plus some additional privileges such as approving the clerks' expense reports or managing their performance appraisals.

When you grant privileges to users, apply the principle of least privilege: *Grant users only the privileges that they need.* If possible, do not directly grant the user a privilege. Instead, create a role that defines the set of privileges the user needs and then grant the user this role. For example, grant user `fred` the `CREATE SESSION` privilege so that he can log in to a database session. But for the privileges that he needs for his job, such as the `UPDATE TABLE` privilege, grant him a role that has those privileges.

You can design your applications to automatically grant a role to the user who is trying to log in, provided the user meets criteria that you specify. To do so, you create a **secure application role**, which is a role that is associated with a PL/SQL procedure (or PL/SQL package that contains multiple procedures). The procedure validates the user: if the user fails the validation, then the user cannot log in. If the user passes the validation, then the procedure grants the user a role so that he or she can use the application. The user has this role only while he or she is logged in to the application. When the user logs out, the role is revoked.

See Also:

- *Oracle Database Security Guide* more information about privilege and role authorization
 - *Oracle Database Security Guide* more information about secure application roles
-

[Example 5-1](#) (page 5-2) shows a secure application role procedure that allows the user to log in during business hours (8 a.m. to 5 p.m.) from a specific set of work stations. If the user passes these checks, then the user is granted the `hr_admin` role and then is able to log in to the application.

Example 5-1 Secure Application Role Procedure to Restrict Access to Business Hours

```
CREATE OR REPLACE PROCEDURE hr_admin_role_check
AUTHID CURRENT_USER
AS
BEGIN
  IF (SYS_CONTEXT ('userenv','ip_address')
      BETWEEN '192.0.2.10' and '192.0.2.20'
      AND
      TO_CHAR (SYSDATE, 'HH24') BETWEEN 8 AND 17)
  THEN
    EXECUTE IMMEDIATE 'SET ROLE hr_admin';
  END IF;
END;
```

5.2 Automating Database Logins

To automate database logins, you create a logon trigger to run a PL/SQL procedure that can validate a user who is attempting to log in to an application. When the user logs in, the trigger executes. Logon triggers can perform multiple actions, such as generating an alert if the user fails the validation, displaying error messages, and so on.

[Example 5-2](#) (page 5-2) shows a simple logon trigger that executes a PL/SQL procedure.

Example 5-2 Creating a Logon Trigger

```
CREATE OR REPLACE TRIGGER run_logon_trig AFTER LOGON ON DATABASE
BEGIN
  sec_mgr.check_user_proc;
END;
```

See Also:

- *Oracle Database PL/SQL Language Reference* for detailed information about the `CREATE TRIGGER` statement
 - *Oracle Database Security Guide* for information about how to create a logon trigger that runs a database session application context package
-

5.3 Controlling User Access with Fine-Grained Access Control

There are several ways that you can control the level of access users have to data from your applications.

- **Oracle Virtual Private Database (VPD):** VPD enables you to create policies that can restrict database access at the row and column level. Essentially, VPD adds a dynamic `WHERE` clause to a SQL statement that is issued against the table, view, or synonym to which an VPD security policy was applied.

For example, suppose the user enters the `SELECT * FROM OE.ORDERS` statement. A VPD policy can transform this statement to the following statement instead, so that only the sales representative who owns the order can view this data:

```
SELECT * FROM OE.ORDERS
WHERE SALES_REP_ID = SYS_CONTEXT('USERENV', 'SESSION_USER');
```

- **Oracle Data Redaction:** Oracle Data Redaction masks data at run time, at the moment the user attempts to access the data (that is, at query-execution time). This solution works well in a dynamic production system in which data is constantly changing. During the time that the data is being redacted, all data processing is performed normally, and the back-end referential integrity constraints are preserved. You typically redact sensitive data, such as credit card or Social Security numbers.

You can mask the data in the following ways:

- **Full redaction, in which the entire data is masked.** For example, the number 37828224 can be displayed as a zero.
- **Partial redaction, in which only a portion of the data is redacted.** With this type, the number 37828224 can be displayed as *****224.
- **Random redaction, in which the data is displayed as randomized data.** Here, the number 37828224 can appear as 93204857.
- **Regular expressions, in which you redact data based on a search pattern.** You can use regular expressions in both full and partial redaction. For example, you can redact the user name of email addresses, so that only the domain shows: jsmith in the email address jsmith@example.com can be replaced with [redacted] so that the email address appears as [redacted]@example.com.
- **No redaction, which enables you to test the internal operation of your redaction policies, with no effect on the results of queries against tables with policies defined on them.** You can use this option to test the redaction policy definitions before applying them to a production environment.
- **Oracle Label Security:** Oracle Label Security secures your database tables at the row level, and assigns these rows different levels of security based on the needs of your site. Rows that contain highly sensitive data can be assigned a label entitled `HIGHLY SENSITIVE`; rows that are less sensitive can be labeled as `SENSITIVE`, and so on. Rows that all users can have access to can be labeled `PUBLIC`. You can create as many labels as you need, to fit your site's security requirements.

For example, when user `fred`, who is a low-level employee, logs in, he would see only data that is available to all users, as defined by the `PUBLIC` label. Yet when

his director, `hortensia`, logs in, she can see all the sensitive data that has been assigned the `HIGHLY SENSITIVE` label.

- **Oracle Database Vault:** Oracle Database Vault enables you to restrict administrative access to your data. By default, administrators (such as user `SYS` with the `SYSDBA` privilege) have access to all data in the database. Administrators typically must perform tasks such performance tuning, backup and recovery, and so on. However, they do not need access to your salary records. Database Vault enables you to create policies that restrict the administrator's actions yet not prevent him or her from performing normal administrative activities.

A typical Database Vault policy could, for example, prevent an administrator from accessing and modifying the `HR.EMPLOYEES` table. You can create fine-tuned policies that impose restrictions such as limiting the hours the administrator can log in, which computers he can use, whether he can log in to the database using dynamic tools, and so on. Furthermore, you can create policies that generate alerts if the administrator tries to violate a policy.

See Also:

- *Oracle Database Security Guide* for more information about Oracle Virtual Private Database
 - *Oracle Database Advanced Security Guide* for more information about Oracle Data Redaction
 - *Oracle Label Security Administrator's Guide* for more information about Oracle Label Security
 - *Oracle Database Vault Administrator's Guide* for more information about Oracle Database Vault
 - *Oracle Database 2 Day + Security Guide* for tutorials on all of these fine-grained access control features
-
-

5.4 Using Invoker's and Definer's Rights for Procedures and Functions

Topics:

- [What Are Invoker's Rights and Definer's Rights?](#) (page 5-4)
- [Protecting Users Who Run Invoker's Rights Procedures and Functions](#) (page 5-5)
- [How Default Rights Are Handled for Java Stored Procedures](#) (page 5-6)

5.4.1 What Are Invoker's Rights and Definer's Rights?

When you create a procedure or function (that is, a program unit), you can design it so that it runs with either the privileges of the owner (you) or the privileges of the person who is invoking it. Definer's rights run the program unit using the owner's privileges and invoker's rights run the program unit using the privileges of the person who runs it. For example, suppose user `harold` creates a procedure that updates the table `orders`. User `harold` then grants the `EXECUTE` privilege on this procedure to user `hazel`. If `harold` had created the procedure with definer's rights, then the procedure

would expect the `orders` table to be in `harold`'s schema. If he created it with invoker's rights, then the procedure would look for the `orders` table in `hazel`'s schema.

To designate a program unit as definer's rights or invoker's rights, use the `AUTHID` clause in the creation statement. If you omit the `AUTHID` clause, then the program unit is created with definer's rights.

[Example 5-3](#) (page 5-5) shows how to use the `AUTHID` clause in a `CREATE PROCEDURE` statement to specify definer's rights or invoker's rights.

Example 5-3 Creating Program Units with Definer's Rights or Invoker's Rights

```
CREATE PROCEDURE my_def_proc AUTHID DEFINER -- Definer's rights procedure
AS ...

CREATE PROCEDURE my_inv_proc AUTHID CURRENT_USER -- Invoker's rights procedure
AS ...
```

See Also:

- *Oracle Database PL/SQL Language Reference* for details about definer's rights and invoker's rights procedures and functions
 - *Oracle Database PL/SQL Language Reference* for details about the `CREATE PROCEDURE` statement
 - *Oracle Database PL/SQL Language Reference* for details about the `CREATE FUNCTION` statement
-

5.4.2 Protecting Users Who Run Invoker's Rights Procedures and Functions

An important consideration when you create an invoker's rights program unit is the level of privilege that the invoking users have. Suppose user `harold` is a low-ranking employee who has few privileges and `hazel` is an executive with many privileges. When `hazel` runs `harold`'s invoker's rights procedure, the procedure temporarily inherits `hazel`'s privileges (all of them). But because `harold` owns this procedure, he can modify it without her knowing it to behave in ways that take advantage of `hazel`'s privileges, such as giving `harold` a raise. To help safeguard against this type of scenario, after she has ensured that `harold` is trustworthy, user `hazel` can grant `harold` permission so that his invoker's rights procedures and functions have access to `hazel`'s privileges when she runs them. To do so, she must grant him the `INHERIT PRIVILEGES` privilege.

[Example 5-4](#) (page 5-5) shows how invoking user `hazel` can grant user `harold` the `INHERIT PRIVILEGES` privilege.

Example 5-4 Granting a Program Unit Creating the INHERIT PRIVILEGES Privilege

```
GRANT INHERIT PRIVILEGES ON hazel TO harold;
```

If `harold` proves untrustworthy, `hazel` can revoke the `INHERIT PRIVILEGES` privilege from him.

Administrators such as user `SYS` and `SYSTEM` have the `INHERIT ANY PRIVILEGES` privilege, which enable these users' invoker's rights procedures to have access to the privileges of any invoking users. As with all `ANY` privileges, grant this privilege only to trusted users.

See Also:

Oracle Database Security Guide for more information about managing security for definer's rights and invoker's rights procedures and functions

5.4.3 How Default Rights Are Handled for Java Stored Procedures

By default, Java class schema objects run with the privileges of their invoker, not with definer's rights. If you want your Java schema objects to run with definer's rights, then when you load them by using the `loadjava` tool, specify the `-definer` option.

[Example 5-5](#) (page 5-6) shows how to use the `-definer` option in a `loadjava` command.

Example 5-5 Loading a Java Class with Definer's Rights

```
loadjava -u joe -resolve -schema TEST -definer ServerObjects.jar
Password: password
```

You can use the `-definer` option on individual classes. Be aware that different definers may have different privileges. Apply the `-definer` option with care, so that you can achieve the desired results. Doing so helps to ensure that your classes run with no more than the privileges that they need.

See Also:

- *Oracle Database Java Developer's Guide* for detailed information about the `loadjava` tool
 - *Oracle Database Java Developer's Guide* for more information about controlling the current user in Java applications
-

5.5 Managing External Procedures for Your Applications

For security reasons, Oracle external procedures run in a process that is physically separate from Oracle Database. When you invoke an external procedure, Oracle Database creates the `extproc` operating system process (or agent), by using the operating system privileges of the user that started the listener for the database instance.

You can configure the `extproc` agent to run as a designated operating system credential. To use this functionality, you define a credential to be associated with the `extproc` process, which then can authenticate impersonate (that is, run on behalf of the supplied user credential) before loading a user-defined shared library and executing a function. To configure the `extproc` user credential, you use the PL/SQL package `DBMS_CREDENTIAL` and the PL/SQL statement `CREATE LIBRARY`.

See Also:

Oracle Database Security Guide for more information about securing external procedures

5.6 Auditing User Activity

You can create audit policies to audit specific actions in the database. Oracle Database then records these actions in an audit trail. The database mandatorily audits some actions and writes these to the audit trail as well. The audit policies that you create can be simple, such as auditing all actions by a specific user, or complex, such as testing for specific conditions and sending email alerts if these conditions are violated.

When you install an Oracle Database, you can choose how your database is audited.

- **Unified auditing:** In unified auditing, all audit trails are written to a single audit trail, viewable by the `V$UNIFIED_AUDIT_TRAIL` and `GV$UNIFIED_AUDIT_TRAIL` dynamic views. This audit trail encompasses not only Oracle Database-specific actions, but also actions performed in Oracle Real Application Security, Oracle Recovery Manager, Oracle Database Vault, and Oracle Label Security environments. The audit records from these sources are presented in a consistent, uniform format. You can create named audit policies and enable and disable them as necessary. If you want to use unified auditing, then you must migrate your databases to it.
- **Mixture of unified auditing and pre-Release 12c auditing:** For the most part, this option enables you to use the pre-Release 12c auditing, in which audit records are written to different locations using their own formats. However, Release 12c functionality, such as using auditing in a multitenant environment, is available. This type of auditing is the default for both new and upgraded databases.

In both cases, when you upgrade your databases to Oracle Database 12c Release 1 (12.1.0.1), the audit records from the previous release are preserved. If you decide to migrate to use unified auditing fully, you can archive these earlier records and then purge the audit trail. After you complete the migration, the new audit records are written to the unified audit trail.

See Also:

- *Oracle Database Security Guide* for more information about creating and managing unified auditing policies
 - *Oracle Database Security Guide* to find a detailed comparison of unified auditing and pre-Release 12c auditing
 - *Oracle Database Upgrade Guide* for information about migrating to unified auditing
-

High Availability

This chapter explains how to design high availability into the database and database applications.

Topics:

- [Transparent Application Failover \(TAF\)](#) (page 6-1)
- [Fast Application Notification \(FAN\) and Fast Connection Failover \(FCF\)](#) (page 6-3)
- [Application Continuity and Transaction Guard](#) (page 6-5)
- [Service and Load Management for Database Clouds](#) (page 6-7)

6.1 Transparent Application Failover (TAF)

This section describes what Transparent Application Failover (TAF) is, how to configure TAF, and using TAF callbacks to notify the application of events as they are generated.

Topics:

- [About Transparent Application Failover](#) (page 6-1)
- [Configuring Transparent Application Failover](#) (page 6-2)
- [Using Transparent Application Failover Callbacks](#) (page 6-2)

6.1.1 About Transparent Application Failover

Transparent Application Failover (TAF) is a client-side feature of OCI, OCCI, Java Database Connectivity (JDBC) OCI driver, and ODP.NET designed to minimize disruptions to end-user applications that occur when database connectivity fails because of instance or network failure. TAF can be implemented on a variety of system configurations including Oracle Real Application Clusters (Oracle RAC), Oracle Data Guard physical standby databases, and on a single instance system after it restarts (for example, when repairs are made).

TAF enables client applications to automatically (transparently) reconnect to a preconfigured secondary instance, creating a fresh connection, but identical to the connection that was established on the first original instance. That is, the connection properties are the same as that of the earlier connection, regardless of how the connection was lost. In this case, the active transactions roll back. Also, all statements that an application attempts to use after a failure attempt also failover.

See Also:

- *Oracle Call Interface Programmer's Guide* for more information about OCI TAF
 - *Oracle C++ Call Interface Programmer's Guide* for more information about OCCI TAF
 - *Oracle Database JDBC Developer's Guide* for more information about JDBC TAF
 - *Oracle Data Provider for .NET Developer's Guide for Microsoft Windows* for more information about ODP.NET TAF
 - *Oracle Database Net Services Reference* for more information about client-side configuration of TAF (Connect Data Section)
 - *Oracle Database PL/SQL Packages and Types Reference* for more information about the server-side configuration of TAF (DBMS_SERVICE)
-

6.1.2 Configuring Transparent Application Failover

TAF can be configured on both the client side and server side with the server side taking precedence if both client and server sides are configured. On the client side, you configure TAF by including the `FAILOVER_MODE` parameter in the `CONNECT_DATA` portion of a connect descriptor. On the server side, you configure TAF by modifying the target service with the `DBMS_SERVICE.MODIFY_SERVICE` packaged procedure.

See the references in [About Transparent Application Failover](#) (page 6-1) for more configuration information.

6.1.3 Using Transparent Application Failover Callbacks

TAF callbacks are callbacks that are registered in case of failover and called during failover to notify the application of events as they are generated. They are called several times while reestablishing the user's session.

As the application developer you may want to inform the user that failover is in progress because there is a slight delay as failover proceeds. The first call to the callback carries out that function. Also, when failover is successful and the connection is reestablished, you may want to inform the user that failover has happened and then you may want to replay `ALTER SESSION` commands because these commands are not automatically replayed on the second instance. A subsequent call to the callback performs that function. Also, if failover is unsuccessful, then you want to inform the application that failover cannot occur. A third call to the callback performs this function as well.

Using TAF callbacks makes possible:

- Notifying users of the status of failover throughout the failover process; when failover is underway, when failover is successful, and when failover is unsuccessful
- Replaying of `ALTER SESSION` commands when that is needed
- Reauthenticating a user handle besides the primary handle for each time a session begins on the new connection. Because each user handle represents a server-side

session, the client may want to replay `ALTER SESSION` commands for that session.

See the references in [Configuring Transparent Application Failover](#) (page 6-2) for specific callback registration information for each interface; such as, the structure and parameters of the callback for each interface, and for failover callback examples.

6.2 Fast Application Notification (FAN) and Fast Connection Failover (FCF)

This section describes what Fast Application Notification (FAN) and Fast Connection Failover (FCF) are and how applications can respond to FAN events in a high availability environment and use FCF to relocate connections after a failover.

Topics:

- [About Fast Application Notification \(FAN\)](#) (page 6-3)
- [About Receiving FAN Event Notifications](#) (page 6-4)
- [About Fast Connection Failover \(FCF\)](#) (page 6-4)

6.2.1 About Fast Application Notification (FAN)

An important component of high availability is a notification mechanism called Fast Application Notification (FAN). FAN notifies other processes about configuration and service level information that includes service status changes, such as UP or DOWN events. Applications can respond to FAN events and take immediate action. FAN UP and DOWN events can apply to instances, services, and nodes.

FAN provides the ability to immediately terminate an active transaction when an instance or server fails. FAN integrated Oracle clients receive the events and respond. Applications can respond either by propagating the error to the user or by resubmitting the transactions and masking the error from the application user. When a DOWN event occurs, FAN integrated clients immediately clean up connections to the terminated database. When an UP event occurs, the FAN integrated clients create new connections to the new primary database instance.

Oracle has integrated FAN with many of the common Oracle client drivers. Therefore, the easiest way to use FAN is to use one of the following integrated Oracle clients:

- OCI session pools
- Universal Connection Pool for Java
- Thin JDBC Driver (12.2 and later)
- ODP.NET managed and un-managed providers
- All WebLogic server data sources, and Oracle Tuxedo

The overall goal is to enable applications to consistently obtain connections to the available primary database at anytime.

FAN events are published using Oracle Notification Service. The publication mechanisms are automatically configured as part of an Oracle RAC installation. Here, an Oracle RAC installation means any installation of Oracle Clusterware with Oracle RAC, Oracle RAC One Node, Oracle Data Guard (fast-start-failover), or Oracle Data Guard single instance with Oracle Clusterware). Beginning with Oracle Database 12c

Release 1 (12.1), ONS is the primary notification mechanism for a new client (Oracle Database 12c Release 1 (12.1)) and a new server (Oracle Database 12c Release 1 (12.1)), while the AQ HA notification feature is deprecated and maintained only for backward compatibility when there is an older OCI or ODP.NET unmanaged client (pre-Oracle Database 12c Release 1 (12.1)) or old server (pre-Oracle Database 12c Release 1 (12.1)).

When you use JDBC or Oracle Database 12c Release 1 (12.1.0.1) OCI or ODP.NET clients, the Oracle Notification Service is automatically configured using your TNS. When you use OCI-based clients, set HA notifications (`-notification = TRUE`) for your services and set EVENTS in `oraccess.xml`.

See Also:

- *Oracle Real Application Clusters Administration and Deployment Guide* for more information about FAN
- *Oracle Database Administrator's Guide* for information about enabling FAN events in an Oracle Restart environment
- *Oracle Call Interface Programmer's Guide* for more information about receiving runtime connection load balancing advisory FAN events to balance application session requests in an Oracle RAC environment with Oracle Clusterware set up and enabled
- *Oracle C++ Call Interface Programmer's Guide* for more information about runtime load balancing of the stateless connection pool by use of service metrics distributed by the Oracle RAC load-balancing advisory
- *Oracle Database JDBC Developer's Guide* for more information about fast connection failover

6.2.2 About Receiving FAN Event Notifications

Starting from Oracle Database 12c Release 2 (12.2), the Oracle RAC FAN APIs provide an alternative for taking advantage of the high-availability (HA) features of Oracle Database, if you do not use Universal Connection Pool or Oracle WebLogic Server with Active Grid Link (AGL). This feature depends on the Oracle Notification System (ONS) message transport mechanism.

This feature requires configuring your system, servers, and clients to use ONS. For using Oracle RAC Fast Application Notification, the `simplefan.jar` file must be present in the CLASSPATH, and either the `ons.jar` file must be present in the CLASSPATH or an Oracle Notification Services (ONS) client must be installed and running in the client system.

See Also:

Oracle Database JDBC Developer's Guide for more information about Oracle RAC FAN APIs.

6.2.3 About Fast Connection Failover (FCF)

In a configuration with a standby database, after you have added Oracle Notification Services (ONS) to your Oracle Restart configurations and enabled Oracle Advanced

Queuing (AQ) HA notifications for your services, you can enable clients for Fast Connection Failover (FCF). The clients then receive FAN events and can relocate connections to the current primary database after an Oracle Data Guard failover. Beginning with Oracle Database 12c Release 1 (12.1), ONS is the primary notification mechanism for a new client (Oracle Database 12c Release 1 (12.1)) and a new server (Oracle Database 12c Release 1 (12.1)), while the AQ HA notification feature is deprecated and maintained only for backward compatibility when there is an old client (pre-Oracle Database 12c Release 1 (12.1)) or old server (pre-Oracle Database 12c Release 1 (12.1)).

For databases with no standby database configured, you can still configure the client FAN events. When there is an outage (planned or unplanned), you can configure the client to retry the connection to the database. Because Oracle Restart restarts the failed database, the client can reconnect when the database restarts.

You must enable FAN events to provide FAN integrated clients support for FCF in an Oracle Data Guard or standalone environment with no standby database.

FCF offers a driver-independent way for your Java Database Connectivity (JDBC) application to take advantage of the connection failover facilities offered by Oracle Database. FCF is integrated with implicit connection cache and Oracle RAC to provide high availability event notification.

OCI clients can enable FCF by registering to receive notifications about Oracle Restart high availability FAN events and respond when events occur. This improves the session failover response time in OCI and removes terminated connections from connection and session pools. This feature works on OCI applications, including those that use Transparent Application Failover (TAF), connection pools, or session pools.

See Also:

- *Oracle C++ Call Interface Programmer's Guide* for more information about runtime load balancing of the stateless connection pool by use of service metrics distributed by the Oracle RAC load-balancing advisory
 - *Oracle Database JDBC Developer's Guide* for more information about fast connection failover
 - *Oracle Universal Connection Pool for JDBC Java API Reference*
 - *Oracle Database Administrator's Guide* for information about enabling FCF for JDBC clients
 - *Oracle Database Administrator's Guide* for information about enabling FCF for OCI clients
 - *Oracle Database Administrator's Guide* for information about enabling FCF for ODP.NET clients
-

6.3 Application Continuity and Transaction Guard

Application Continuity is a DBA feature for failover. Transaction Guard is a developer feature for coding failover yourself.

In Oracle high availability framework, JDBC clients, OCI clients, and ODP.NET clients support fast application notification (FAN) messages. FAN is designed to quickly notify an application of outages at the node, database, instance, service, and public

network levels. After being notified of the failure, an application can reestablish the failed connection on a surviving instance.

Application Continuity is transparent to the application. This functionality is provided by the Oracle Database 12c and the Oracle drivers. It is enabled by setting attributes on the database service.

See Also:

- *Oracle Real Application Clusters Administration and Deployment Guide* for more information about Application Continuity
 - [Using Transaction Guard](#) (page 28-1) for more information about Transaction Guard
 - *Oracle Call Interface Programmer's Guide* for more information about OCI, Transaction Guard, and Application Continuity
 - *Oracle Database JDBC Developer's Guide* for more information about JDBC, Transaction Guard, and Application Continuity
-

6.3.1 Overview of Application Continuity

Application Continuity masks planned or unplanned outages (that cause database session unavailability) by attempting to rebuild the database session transactional and non-transactional states, so the outage appears to the user as no more than a delayed execution.

Application Continuity works with the Oracle Database 12c and later server to determine if the database session can be replayed. When a recoverable error occurs that makes the database session unavailable, an error message is sent back to the application. A driver receives the FAN message (down or interrupt) and aborts the dead session.

If the last submission has replay enabled, the 12c driver prepares to replay the submission and replays the saved statements for the request. Application Continuity prepares replay by using Transaction Guard to determine the outcome of the last operation submitted by the session that received the error. If the submission committed and completed, the new session returns this result to the application and continues with the nontransactional state established if the `SESSION_STATE_CONSISTENCY` mode is `STATIC`, or exits if the `SESSION_STATE_CONSISTENCY` mode is `DYNAMIC`. `DYNAMIC` session state consistency is appropriate for most applications.

If `FAILOVER_RESTORE` is `LEVEL1` or a callback has been set, the client (JDBC replay driver, ODP.NET or OCI) initializes the connection to restore initial nontransactional session state (NTSS). When replaying, preserved mutable data are restored if permission has been granted. Validation is performed at the server to ensure that the client-visible results are identical to the original submission. When replay is complete, the application proceeds with its application logic returning to runtime mode as if all that occurred was a delay in execution similar to that which happens under load.

In some cases, replay cannot restore the data that the client potentially made decisions upon. The replay then returns the original error to the application and appears like a delayed error.

Application Continuity supports recovering any outage that is due to database unavailability against a copy of a database with the same DBID (forward in time) or within an Active Data Guard farm. This may be Oracle RAC One, Oracle Real Application Clusters, within an Active Data Guard, Multitenant using PDB relocate with a RAC or across RACs or across to Active Data Guard (ADG).

See Also:

- *Oracle Real Application Clusters Administration and Deployment Guide* for more information about Application Continuity
-

6.3.2 Overview of Transaction Guard

Transaction Guard is a reliable protocol and interface that returns the commit outcome of the current in-flight transaction when an error, or a time-out is returned to the client. Applications can leverage the Transaction Guard interface to code graceful recoverable error handling. Providing unambiguous message during an outage greatly improves the user experience.

Transaction Guard introduces the concept of *at-most-once transaction semantics*, also referred to as transaction idempotence. When an application opens a connection to the database using this service, the logical transaction ID (LTXID) is generated at authentication and stored in the session handle at the database and a copy at the client driver. This is a globally unique ID that identifies the database transaction from the application perspective. Applications use the Transaction Guard interface to obtain a known commit outcome following a recoverable error.

When there is an outage, an application using Transaction Guard can retrieve the LTXID from the previous failed session's handle and use it to determine the outcome of the transaction that was active prior to the session failure. If the LTXID is determined to be `UNCOMMITTED`, then the application can return the `UNCOMMITTED` outcome to the user to decide what action to take, or optionally, the application can replay an uncommitted transaction. If the LTXID is determined to be `COMMITTED`, then the transaction is committed and the application can return this outcome to the end user and might be able to take a new connection and continue. Transaction Guard also reports whether the last user call not only `COMMITTED`, but also whether it completed changing needed non-transactional states - see `USER_CALL_COMPLETED`. See [Using Transaction Guard](#) (page 28-1) for more information about Transaction Guard.

6.4 Service and Load Management for Database Clouds

Topics:

[About Service and Load Management for Database Clouds](#) (page 6-7)

6.4.1 About Service and Load Management for Database Clouds

The database cloud is a self-contained system of databases integrated by the service and load management framework that ensures high performance, availability and optimal utilization of resources. This framework provides effective balancing of processing workload across distributed databases that maintain multiple synchronized replicas both locally and in geographically disparate regional data centers. Replicas may be instances in an Oracle RAC environment, or single instances interconnected using Oracle Data Guard, Oracle Golden Gate, or any combination that

supports replication technology. Thus, the service and load management framework provides dynamic load balancing, failover, and centralized service management for these replicated databases.

A global service is a database service provided by multiple databases synchronized through some form of data replication that satisfies quality of service requirements for the service. This allows a client request for a service to be forwarded to any database that provides that service.

A database pool within a database cloud consists of all databases that provide the same global service that belong to the same administrative domain. The database cloud is partitioned into multiple database pools to simplify service management and to provide higher levels of security by allowing each pool to be administered by a different administrator.

A global service manager (GSM) is a software component that provides service-level load balancing and centralized management of services within the database cloud. Load balancing is done at connection and runtime. Other capabilities provided by GSM include creation, configuration, starting, stopping, and relocation of services and maintaining global service properties such as cardinality and region locality. A region is a logical boundary known as a data center that contains database clients and servers that are considered close enough to each other so as to reduce network latency to levels required by applications accessing these data centers.

The GSM can run on a separate host, or can be colocated with a database instance. Every region must have at least one GSM instance running. For high availability, Oracle recommends that you deploy multiple GSM instances in a region. A GSM instance belongs to only one particular region; however, it manages global services in all database pools associated with this region.

From an application developer's perspective, a client program connects to a regional global service manager (GSM) and requests a connection to a global service. The client need not specify which database or instance it requires. GSM forwards the client's request to the optimal instance within a database pool in the database cloud that offers the service.

Beginning with Oracle Database 12c Release 1 (12.1.0.1), the DBA can configure client-side connect strings for database services in a Global Data Services (GDS) framework using an Oracle Net string.

Introduced in Oracle Database 12c Release 1 (12.1.0.1), the logical transaction ID (LTXID) is initially generated at authentication and stored in the session handle and used to identify a database transaction from the application perspective. The logical transaction ID is globally unique and identifies the transaction within a highly available (HA) infrastructure.

Using the HA Framework, a client application (JDBC, OCI, and ODP.NET) supports fast application notification (FAN) messages. FAN is designed to quickly notify an application of outages at the node, database, instance, service, and public network levels. After being notified of the outage, an application can reestablish the failed connection on a surviving instance.

Beginning with Oracle Database 12c Release 1 (12.1.0.1), the DBA can configure server-side settings for the database services used by the applications to support Application Continuity for Java and Transaction Guard.

See Also:

- *Oracle Database Concepts* for an overview of global service management and description of the physical and logical components of the service and load management framework
 - *Oracle Database Global Data Services Concepts and Administration Guide* for more information about global service management in a database cloud
 - *Oracle Database Global Data Services Concepts and Administration Guide* for more information about configuring database clients for connectivity to the Global Data Services (GDS) framework.
 - *Oracle Call Interface Programmer's Guide* for more information about OCI, Application Continuity, and Transaction Guard
 - *Oracle Database JDBC Developer's Guide* for more information about JDBC, Application Continuity, and Transaction Guard
-

Advanced PL/SQL Features

This chapter introduces the advanced PL/SQL features and refers to other chapters or documents for more information.

Topics:

- [PL/SQL Data Types](#) (page 7-1)
- [Dynamic SQL](#) (page 7-1)
- [PL/SQL Optimize Level](#) (page 7-2)
- [Compiling PL/SQL Units for Native Execution](#) (page 7-2)
- [Exception Handling](#) (page 7-2)
- [Conditional Compilation](#) (page 7-2)
- [Bulk Binding](#) (page 7-2)

See Also:

- [PL/SQL for Application Developers](#) (page 1)
 - *Oracle Database PL/SQL Language Reference* for a complete description of PL/SQL
-
-

7.1 PL/SQL Data Types

The PL/SQL data types include the SQL data types, additional scalar data types, and composite data types. You define the composite data types. You can also define subtypes of the scalar data types. For more information, see [PL/SQL Data Types](#) (page 13-8).

7.2 Dynamic SQL

Dynamic SQL is a programming methodology for generating and running SQL statements at runtime. It is useful when writing general-purpose and flexible programs like dynamic query systems, when writing programs that must run database definition language (DDL) statements, or when you do not know at compile time the full text of a SQL statement or the number or data types of its input and output variables. For more information, see [PL/SQL Dynamic SQL](#) (page 13-19).

7.3 PL/SQL Optimize Level

The PL/SQL optimize level determines how much the PL/SQL optimizer can rearrange code for better performance. This level is set with the compilation parameter `PLSQL_OPTIMIZE_LEVEL`, which is described in *Oracle Database Reference*. For more information, see [PLSQL_OPTIMIZE_LEVEL Compilation Parameter](#) (page 13-4).

7.4 Compiling PL/SQL Units for Native Execution

You can usually speed up PL/SQL units by compiling them into native code (processor-dependent system code), which is stored in the SYSTEM tablespace. For more information about compiling PL/SQL units for native execution, see [Compiling PL/SQL Units for Native Execution](#) (page 13-21).

7.5 Exception Handling

Exceptions (PL/SQL runtime errors) can arise from design faults, coding mistakes, hardware failures, and many other sources. You cannot anticipate all possible exceptions, but you can write exception handlers that let your program to continue to operate in their presence. For more information, see *Oracle Database PL/SQL Language Reference*.

7.6 Conditional Compilation

Conditional compilation lets you customize the functionality of a PL/SQL application without removing source text. For example, you can:

- Use new features with the latest database release and disable them when running the application in an older database release.
- Activate debugging or tracing statements in the development environment and hide them when running the application at a production site.

However:

- Oracle recommends against using conditional compilation to change the attribute structure of a type, which can cause dependent objects to "go out of sync" or dependent tables to become inaccessible.

To change the attribute structure of a type, Oracle recommends using the `ALTER TYPE` statement (described in *Oracle Database SQL Language Reference*), which propagates changes to dependent objects.

- Conditional compilation is subject to restrictions.

For more information about conditional compilation, see *Oracle Database PL/SQL Language Reference*.

7.7 Bulk Binding

Bulk binding minimizes the performance overhead of the communication between PL/SQL and SQL, which can greatly improve performance. For more information, see [Overview of Bulk Binding](#) (page 13-16).

Part II

SQL for Application Developers

This part presents information that application developers need about Structured Query Language (SQL), which is used to manage information in an Oracle Database.

Chapters:

- [SQL Processing for Application Developers](#) (page 8-1)
- [Using SQL Data Types in Database Applications](#) (page 9-1)
- [Using Regular Expressions in Database Applications](#) (page 10-1)
- [Using Indexes in Database Applications](#) (page 11-1)
- [Maintaining Data Integrity in Database Applications](#) (page 12-1)

See Also:

Oracle Database SQL Language Reference for a complete description of SQL

SQL Processing for Application Developers

This chapter explains what application developers must know about how Oracle Database processes SQL statements. Before reading this chapter, read the basic information about SQL statements and SQL processing in *Oracle Database Concepts*.

Topics:

- [Description of SQL Statement Processing](#) (page 8-1)
- [Grouping Operations into Transactions](#) (page 8-4)
- [Ensuring Repeatable Reads with Read-Only Transactions](#) (page 8-13)
- [Locking Tables Explicitly](#) (page 8-14)
- [Using Oracle Lock Management Services \(User Locks\)](#) (page 8-27)
- [Using Serializable Transactions for Concurrency Control](#) (page 8-29)
- [Nonblocking and Blocking DDL Statements](#) (page 8-37)
- [Autonomous Transactions](#) (page 8-38)
- [Resuming Execution After Storage Allocation Errors](#) (page 8-45)

8.1 Description of SQL Statement Processing

This topic explains what happens during each stage of processing the execution of a SQL statement, using a data manipulation language (DML) statement as an example.

Assume that you are using a Pro*C program to increase the salary for all employees in a department. The program has connected to Oracle Database and you are connected to the HR schema, which owns the `employees` table. You can embed this SQL statement in your program:

```
EXEC SQL UPDATE employees SET salary = 1.10 * salary
      WHERE department_id = :department_id;
```

The program provides a value for the bind variable placeholder `:department_id`, which the SQL statement uses when it runs.

Topics:

- [Stages of SQL Statement Processing](#) (page 8-2)
- [Shared SQL Areas](#) (page 8-4)

8.1.1 Stages of SQL Statement Processing

Note:

DML statements use all stages. Transaction management, session management, and system management SQL statements use only stages [2](#) (page 8-2) and [8](#) (page 8-3).

1. Open or create a cursor.

A program interface call opens or creates a cursor, in expectation of a SQL statement. Most applications create the cursor implicitly (automatically). Precompiler programs can create the cursor either implicitly or explicitly.

2. Parse the statement.

The user process passes the SQL statement to Oracle Database, which loads a parsed representation of the statement into the shared SQL area. Oracle Database can catch many errors during parsing.

Note:

For a data definition language (DDL) statement, parsing includes data dictionary lookup and execution.

See Also:

- *Oracle Database Concepts* for information about parsing
 - [Shared SQL Areas](#) (page 8-4)
-
-

3. Determine if the statement is a query.**4. If the statement is a query, describe its results.**

Note:

This stage is necessary only if the characteristics of the result are unknown; for example, when a user enters the query interactively.

Oracle Database determines the characteristics (data types, lengths, and names) of the result.

5. If the statement is a query, define its output.

You specify the location, size, and data type of variables defined to receive each fetched value. These variables are called **define variables**. Oracle Database performs data type conversion if necessary.

See Also:

Oracle Database Concepts for information about the DEFINE stage

6. Bind any variables.

Oracle Database has determined the meaning of the SQL statement but does not have enough information to run it. Oracle Database needs values for any bind variable placeholders in the statement. In the example, Oracle Database needs a value for :department_id. The process of obtaining these values is called **binding variables**.

A program must specify the location (memory address) of the value. End users of applications may be unaware that they are specifying values for bind variable placeholders, because the Oracle Database utility can prompt them for the values.

Because the program specifies the location of the value (that is, binds by reference), it need not rebind the variable before rerunning the statement, even if the value changes. Each time Oracle Database runs the statement, it gets the value of the variable from its address.

You must also specify a data type and length for each value (unless they are implied or defaulted) if Oracle Database must perform data type conversion.

See Also:

For more information about specifying a data type and length for a value:

- *Oracle Call Interface Programmer's Guide*
 - *Pro*C/C++ Programmer's Guide*
-
-

7. (Optional) Parallelize the statement.

Oracle Database can parallelize queries and some data definition language (DDL) operations (for example, index creation, creating a table with a subquery, and operations on partitions). Parallelization causes multiple server processes to perform the work of the SQL statement so that it can complete faster.

8. Run the statement.

Oracle Database runs the statement. If the statement is a query or an INSERT statement, the database locks no rows, because no data is changing. If the statement is an UPDATE or DELETE statement, the database locks all rows that the statement affects, until the next COMMIT, ROLLBACK, or SAVEPOINT for the transaction, thereby ensuring data integrity.

For some statements, you can specify multiple executions to be performed. This is called **array processing**. Given n number of executions, the bind and define locations are assumed to be the beginning of an array of size n .

9. If the statement is a query, fetch its rows.

Oracle Database selects rows and, if the query has an ORDER BY clause, orders the rows. Each successive fetch retrieves another row of the result set, until the last row has been fetched.

10. Close the cursor.

Oracle Database closes the cursor.

Note:

To rerun a transaction management, session management, or system management SQL statement, use another `EXECUTE` statement.

8.1.2 Shared SQL Areas

Oracle Database automatically detects when applications send similar SQL statements to the database. The SQL area used to process the first occurrence of the statement is *shared*—that is, used for processing subsequent occurrences of that same statement. Therefore, only one shared SQL area exists for a unique statement. Because shared SQL areas are shared memory areas, any Oracle Database process can use a shared SQL area. The sharing of SQL areas reduces memory use on the database server, thereby increasing system throughput.

In determining whether statements are similar or identical, Oracle Database compares both SQL statements issued directly by users and applications and recursive SQL statements issued internally by DDL statements.

See Also:

- *Oracle Database Concepts* for more information about shared SQL areas
 - *Oracle Database SQL Tuning Guide* for more information about shared SQL
-
-

8.2 Grouping Operations into Transactions

Topics:

- [Deciding How to Group Operations in Transactions](#) (page 8-4)
- [Improving Transaction Performance](#) (page 8-5)
- [Managing Commit Redo Action](#) (page 8-6)
- [Determining Transaction Outcome After a Recoverable Outage](#) (page 8-8)

See Also:

Oracle Database Concepts for basic information about transactions

8.2.1 Deciding How to Group Operations in Transactions

Typically, deciding how to group operations in transactions is the concern of application developers who use programming interfaces to Oracle Database. When deciding how to group transactions:

- Define transactions such that work is accomplished in logical units and data remains consistent.

- Ensure that data in all referenced tables is in a consistent state before the transaction begins and after it ends.
- Ensure that each transaction consists only of the SQL statements or PL/SQL blocks that comprise one consistent change to the data.

For example, suppose that you write a web application that lets users transfer funds between accounts. The transaction must include the debit to one account, executed by one SQL statement, and the credit to another account, executed by another SQL statement. Both statements must fail or succeed as a unit of work; one statement must not be committed without the other. Do not include unrelated actions, such as a deposit to one account, in the transaction.

8.2.2 Improving Transaction Performance

As an application developer, you must try to improve performance. Consider using these performance enhancement techniques when designing and writing your application:

- For each transaction:
 1. If you can use a single SQL statement, then do so.
 2. If you cannot use a single SQL statement but you can use PL/SQL, then use as little PL/SQL as possible.

For information about PL/SQL, see [PL/SQL for Application Developers](#) (page 1).

3. If you cannot use PL/SQL (because it cannot do what you must do; for example, read a directory), then use Java.
4. If you cannot use Java (for example, if it is too slow) or you have existing third-generation language (3GL) code, then use an external C subprogram.

For information about using Java and C in your application, see [Developing Applications with Multiple Programming Languages](#) (page 21-1).

- Establish standards for writing SQL statements so that you can take advantage of shared SQL areas.

Oracle Database recognizes identical SQL statements and lets them share memory areas, reducing memory usage on the database server and increasing system throughput.

- Collect statistics that Oracle Database can use to implement a cost-based approach to SQL statement optimization, and use additional hints to the optimizer as needed.

To collect most statistics, use the `DBMS_STATS` package, which lets you collect statistics in parallel, collect global statistics for partitioned objects, and tune your statistics collection in other ways. For more information about this package, see *Oracle Database PL/SQL Packages and Types Reference*.

To collect statistics unrelated to the cost-based optimizer (such as information about free list blocks), use the SQL statement `ANALYZE`. For more information about this statement, see *Oracle Database SQL Language Reference*.

For more information about hints, see *Oracle Database SQL Language Reference*.

- Before beginning a transaction, invoke `DBMS_APPLICATION_INFO` procedures to record the name of the transaction in the database for later use when tracking its performance with Oracle Trace and the SQL trace facility. For information about the `DBMS_APPLICATION_INFO` package, see *Oracle Database PL/SQL Packages and Types Reference*.
- Increase user productivity and query efficiency by including user-written PL/SQL functions in SQL expressions. For details, see [Invoking Stored PL/SQL Functions from SQL Statements](#) (page 13-28).

See Also:

Oracle Database Concepts for more information about transaction management

8.2.3 Managing Commit Redo Action

When a transaction updates Oracle Database, it generates a corresponding redo entry. Oracle Database buffers the redo entry to the redo log until the transaction completes. When the transaction commits, the log writer process (LGWR) writes redo records to disk for the buffered redo entries of all changes in the transaction. By default, Oracle Database writes the redo entries to disk before the call returns to the client. This action causes a latency in the commit, because the application must wait for the redo entries to be persistent on disk.

Oracle Database lets you change the handling of commit redo to fit the needs of your application. If your application requires very high transaction throughput and you are willing to trade commit durability for lower commit latency, then you can change the default `COMMIT` options so that the application need not wait for the database to write data to the online redo logs.

[Table 8-1](#) (page 8-6) describes the `COMMIT` options.

Caution:

With the `NOWAIT` option, a failure that occurs after the commit message is received, but before the redo log records are written, can falsely indicate to a transaction that its changes are persistent.

Table 8-1 COMMIT Statement Options

Option	Effect
<code>WAIT</code> (default)	Ensures that the <code>COMMIT</code> statement returns only after the corresponding redo information is persistent in the online redo log. When the client receives a successful return from this <code>COMMIT</code> statement, the transaction has been committed to durable media. A failure that occurs after a successful write to the log might prevent the success message from returning to the client, in which case the client cannot tell whether the transaction committed.
<code>NOWAIT</code> (alternative to <code>WAIT</code>)	The <code>COMMIT</code> statement returns to the client regardless of whether the write to the redo log has completed. This behavior can increase transaction throughput.

Table 8-1 (Cont.) COMMIT Statement Options

Option	Effect
BATCH (alternative to IMMEDIATE)	Buffers the redo information to the redo log with concurrently running transactions. After collecting sufficient redo information, initiates a disk write to the redo log. This behavior is called group commit , because it writes redo information for multiple transactions to the log in a single I/O operation.
IMMEDIATE (default)	LGWR writes the transaction redo information to the log. Because this operation forces a disk I/O, it can reduce transaction throughput.

To change the COMMIT options, use either the COMMIT statement (described in *Oracle Database SQL Language Reference*) or the appropriate initialization parameter. For information about initialization parameters, see *Oracle Database Reference*.

Note:

You cannot change the default IMMEDIATE and WAIT action for distributed transactions.

If your application uses Oracle Call Interface (OCI), then you can modify redo action by setting these flags in the OCITransCommit function in your application:

- OCI_TRANS_WRITEWAIT
- OCI_TRANS_WRITENOWAIT
- OCI_TRANS_WRITEBATCH
- OCI_TRANS_WRITEIMMED

Caution:

OCI_TRANS_WRITENOWAIT can cause silent transaction loss with shutdown termination, startup force, and any instance or node failure. On an Oracle RAC system, asynchronously committed changes might not be immediately available to read on other instances.

See Also:

Oracle Call Interface Programmer's Guide for information about the OCITransCommit function

The specification of the NOWAIT and BATCH options has a small window of vulnerability in which Oracle Database can roll back a transaction that your application views as committed. Your application must be able to tolerate these scenarios:

- The database host fails, which causes the database to lose redo entries that were buffered but not yet written to the online redo logs.

- A file I/O problem prevents LGWR from writing buffered redo entries to disk. If the redo logs are not multiplexed, then the commit is lost.

8.2.4 Determining Transaction Outcome After a Recoverable Outage

A **recoverable outage** is a system, hardware, communication, or storage failure that breaks the connection between your application (the client) and Oracle Database (the server). After an outage, your application receives a disconnection error message. The transaction that was running when the connection broke is the **in-flight transaction**, which may or may not have been committed or run to completion.

To recover from the outage, your application must determine the outcome of the in-flight transaction—whether it was committed and whether it made its intended session state changes. If the transaction was not committed, then the application can either resubmit the transaction or return the uncommitted status to the end user. If the transaction was committed, then the application can return the committed status, rather than the disconnection error, to the end user. If the transaction was both committed and completed, then the application may be able to continue by taking a new session and re-establishing the session state.

The Oracle Database feature that provides your application with the outcome of the in-flight transaction and can be used to ensure that it is not duplicated is Transaction Guard, and its application program interface (API) is the PL/SQL procedure `DBMS_APP_CONT.GET_LTXID_OUTCOME`.

Topics:

- [Understanding Transaction Guard](#) (page 8-8)
- [Understanding DBMS_APP_CONT.GET_LTXID_OUTCOME](#) (page 8-10)
- [Using Transaction Guard](#) (page 8-12)

8.2.4.1 Understanding Transaction Guard

Transaction Guard is an Oracle Database tool that you can use to provide your application with the outcome of the in-flight transaction after an outage. The application can use Transaction Guard to provide the end user with a known outcome after an outage—committed or not committed—and, optionally, to replay the transaction if it did not commit and the states are correct.

Transaction Guard provides the transaction outcome through its API, the PL/SQL procedure `DBMS_APP_CONT.GET_LTXID_OUTCOME`, described in [Understanding DBMS_APP_CONT.GET_LTXID_OUTCOME](#) (page 8-10).

Transaction Guard relies on the **logical transaction identifier (LTXID)**, a globally unique identifier that identifies the last in-flight transaction on a session that failed. The database records the LTXID when the transaction is committed, and returns a new LTXID to the client with the commit message (for each client round trip). The client driver always holds the LTXID that will be used at the next `COMMIT`.

Note:

- Use Transaction Guard only to find the outcome of a session that failed due to a recoverable error, to replace the communication error with the real outcome.
- Do not use Transaction Guard on your own session.
- Do not use Transaction Guard on a live session.

To stop a live session, use `ALTER SYSTEM KILL SESSION IMMEDIATE` at the local or remote instance.

8.2.4.1.1 How Transaction Guard Uses the LTXID

Transaction Guard uses the LTXID as follows:

- While a transaction is running, both Oracle Database (the server) and your application (the client) hold the LTXID to be used at the next `COMMIT`.
- When the transaction is committed, Oracle Database records the LTXID with the transaction. If the LTXID has already been committed or has been blocked, then the database raises error, preventing duplication of the transaction.
- The LTXID persists in Oracle Database for the time specified by the `RETENTION_TIMEOUT` parameter. The default is 24 hours. To change this value:
 - When running Real Application Clusters, use Server Control Utility (SRVCTL), described in *Oracle Real Application Clusters Administration and Deployment Guide*.
 - When not using Real Application Clusters, use the `DBMS_SERVICE` package, described in *Oracle Database PL/SQL Packages and Types Reference*.

If the transaction is remote or distributed, then its LTXID persists in the local database.

The LTXID is transferred to Data Guard and Active Data Guard in the standard redo apply.

- After a recoverable error:
 - If the transaction has not been committed, then Oracle Database blocks its LTXID to ensure that an earlier in-flight transaction with the same LTXID cannot be committed.

This behavior allows the application to return the uncommitted result to the user, who can then decide what to do, and also allows the application to safely replay the application if desirable.
 - If the transaction has been committed, then the application can return this result to the end user, and if the state is correct, the application may be able to continue.
- If the transaction is rolled back, then Oracle Database reuses its LTXID.

See Also:

- [Transaction Guard Coverage](#) (page 28-5), for a list of the sources whose commits Transaction Guard supports
- [Transaction Guard Exclusions](#) (page 28-6), for a list of the sources whose commits Transaction Guard does not support

8.2.4.2 Understanding DBMS_APP_CONT.GET_LTXID_OUTCOME

The PL/SQL procedure `DBMS_APP_CONT.GET_LTXID_OUTCOME` is the API of Transaction Guard. After an outage, your application can reconnect to Oracle Database and then invoke this procedure to determine the outcome of the in-flight transaction.

`DBMS_APP_CONT.GET_LTXID_OUTCOME` has these parameters:

Parameter Name	Data Type	Parameter Mode	Value
<code>CLIENT_LTXID</code>	RAW	IN	LTXID of the in-flight transaction
<code>COMMITTED</code>	BOOLEAN	OUT	TRUE if the in-flight transaction was committed, FALSE otherwise
<code>USER_CALL_COMPLETED</code>	BOOLEAN	OUT	TRUE if the in-flight transaction completed, FALSE otherwise

Topics:

- [CLIENT_LTXID Parameter](#) (page 8-10)
- [COMMITTED Parameter](#) (page 8-11)
- [USER_CALL_COMPLETED Parameter](#) (page 8-11)
- [Exceptions](#) (page 8-12)

See Also:

Oracle Database PL/SQL Packages and Types Reference for more information about `DBMS_APP_CONT.GET_LTXID_OUTCOME`

8.2.4.2.1 CLIENT_LTXID Parameter

Before your application (the client) can invoke `DBMS_APP_CONT.GET_LTXID_OUTCOME` with the LTXID of the in-flight transaction, it must get the last LTXID in use at the client driver by using a client driver. The client driver holds the LTXID of the transaction next to be committed. In this case, the LTXID is for the in-flight transaction at the time of the outage. Use `getLTXID` for JDBC-Thin driver, `LogicalTransactionId` for ODP.NET, and `OCI_ATTR_GET` with LTXID for OCI and OCCI.

The JDBC-Thin driver also provides a callback that is triggered each time the LTXID at the client driver changes. The callback can be used to maintain the current LTXID to be

used. The callback is particularly useful for application servers and applications that must block repeated executions.

Note:

Your application must get the LTXID immediately before passing it to `DBMS_APP_CONT.GET_LTXID_OUTCOME`. Getting the LTXID in advance could lead to passing an earlier LTXID to `DBMS_APP_CONT.GET_LTXID_OUTCOME`, causing the request to be rejected.

For information about the client driver for your client driver, see the documentation. For example:

- For JDBC type 2 and type 4 drivers, see *Oracle Database JDBC Developer's Guide*.
- For the OCI driver (including OCCI), see *Oracle Call Interface Programmer's Guide*.
- For the ODP.NET driver, see *Oracle Data Provider for .NET Developer's Guide for Microsoft Windows*.

8.2.4.2 COMMITTED Parameter

After `DBMS_APP_CONT.GET_LTXID_OUTCOME` returns control to your application, your application can check the value of the actual parameter that corresponds to the formal parameter `COMMITTED` to determine whether the in-flight transaction was committed.

If the value of the actual parameter is `TRUE`, then the transaction was committed.

If the value of the actual parameter is `FALSE`, then the transaction was not committed. Therefore, it is safe for the application to return the code `UNCOMMITTED` to the end user or use it to replay the transaction.

To ensure that an earlier session does not commit the transaction after the application returns `UNCOMMITTED`, `DBMS_APP_CONT.GET_LTXID_OUTCOME` blocks the LTXID. Blocking the LTXID allows the end user to make a decision based on the uncommitted status, or the application to replay the transaction, and prevents duplicate transactions.

8.2.4.3 USER_CALL_COMPLETED Parameter

Some transactions return information upon completion. For example: A transaction that uses commit on success (auto-commit) might return the number of affected rows, or for a `SELECT` statement, the rows themselves; a transaction that invokes a PL/SQL subprogram that has `OUT` parameters returns the values of those parameters; and a transaction that invokes a PL/SQL function returns the function value. Also, a transaction that invokes a PL/SQL subprogram might execute a `COMMIT` statement and then do more work.

If your application needs information that the in-flight transaction returns upon completion, or session state changes that the transaction does after committing its database changes, then your application must determine whether the in-flight transaction completed, which it can do by checking the value of the actual parameter that corresponds to the formal parameter `USER_CALL_COMPLETED`.

If the value of the actual parameter is `TRUE`, then the transaction completed, and your application has the information and work that it must continue.

If the value of the actual parameter is `FALSE`, then the call from the client may not have completed. Therefore, your application might not have the information and work that it must continue.

8.2.4.2.4 Exceptions

If your application (the client) and Oracle Database (the server) are no longer synchronized, then the `DBMS_APP_CONT.GET_LTXID_OUTCOME` procedure raises one of these exceptions:

Exception	Explanation
ORA-14950 - SERVER_AHEAD	The server is ahead of the client; that is, the LTXID that your application passed to <code>DBMS_APP_CONT.GET_LTXID_OUTCOME</code> identifies a transaction that is older than the in-flight transaction. Your application must get the LTXID immediately before passing it to <code>DBMS_APP_CONT.GET_LTXID_OUTCOME</code> .
ORA-14951 - CLIENT_AHEAD	The client is ahead of the server. Either the server was "flashed back" to an earlier state (see Using Oracle Flashback Technology (page 19-1)), was recovered using media recovery, or is a standby database that was opened earlier and has lost data (for information about media recovery and standby databases, see <i>Oracle Data Guard Concepts and Administration</i>).
ORA-14906 - SAME_SESSION	Executing <code>GET_LTXID_OUTCOME</code> is not supported on the session that owns the LTXID, because the execution would block further processing on that session.
ORA-14909 - COMMIT_BLOCKED	Your session has been blocked from committing by another user with the same username using <code>GET_LTXID_OUTCOME</code> . <code>GET_LTXID_OUTCOME</code> should be called only on dead sessions. Blocking a live session is better achieved using <code>ALTER SYSTEM KILL SESSION IMMEDIATE</code> . For help, contact your application administrator.
ORA-14952 GENERAL_ERROR	<code>DBMS_APP_CONT.GET_LTXID_OUTCOME</code> cannot determine the outcome of the in-flight transaction. An error occurred during transaction processing, and the error stack shows the error detail.

8.2.4.3 Using Transaction Guard

After your application (the client) receives an error message, it must follow these steps to use Transaction Guard:

1. Determine if the error is due to an outage (**recoverable**).
For instructions, see the documentation for your client driver—`OCI_ATTRIBUTE` for OCI, `OCCI`, and `ODP.NET`; `isRecoverable` for JDBC.
2. If the error is recoverable, then use the API of the client driver to get the logical transaction identifier (LTXID) of the in-flight transaction.
For instructions, see the documentation for your client driver.
3. Reconnect to the database.
The session that your application acquires can be either new or pooled.
4. Invoke `DBMS_APP_CONT.GET_LTXID_OUTCOME` with the LTXID from step 2 (page 8-12).

5. Check the value of the actual parameter that corresponds to the formal parameter COMMITTED.

If the value is `TRUE`, then tell the application that the in-flight transaction was committed. The application can return this result to the user, or continue if the state is correct.

If the value is `FALSE`, then the application can return `UNCOMMITTED` or a similar message to the user so that the user can choose the next step. Optionally, the application can replay the transaction for the user. For example:

- a. If necessary, clean up state changes on the client side.
- b. Resubmit the in-flight transaction.

If you do not resubmit the in-flight transaction, and the application needs neither information that the in-flight transaction returns upon completion nor work that the transaction does after committing its database changes, then continue. Otherwise, check the value of the actual parameter that corresponds to the formal parameter `USER_CALL_COMPLETED`.

If the value is `TRUE`, then continue.

If the value is `FALSE`, then tell the application user that the application cannot continue.

8.3 Ensuring Repeatable Reads with Read-Only Transactions

By default, Oracle Database guarantees statement-level read consistency, but not transaction-level read consistency. With **statement-level read consistency**, queries in a statement produce consistent data for the duration of the statement, not reflecting changes by other statements. With **transaction-level read consistency (repeatable reads)**, queries in the transaction produce consistent data for the duration of the transaction, not reflecting changes by other transactions.

To ensure transaction-level read consistency for a transaction that does not include DML statements, specify that the transaction is read-only. The queries in a read-only transaction see only changes committed before the transaction began, so query results are consistent for the duration of the transaction.

A read-only transaction provides transaction-level read consistency without acquiring additional data locks. Therefore, while the read-only transaction is querying data, other transactions can query and update the same data.

A read-only transaction begins with this statement:

```
SET TRANSACTION READ ONLY [ NAME string ];
```

Only DDL statements can precede the `SET TRANSACTION READ ONLY` statement. After the `SET TRANSACTION READ ONLY` statement successfully runs, the transaction can include only `SELECT` (without `FOR UPDATE`), `COMMIT`, `ROLLBACK`, or non-DML statements (such as `SET ROLE`, `ALTER SYSTEM`, and `LOCK TABLE`). A `COMMIT`, `ROLLBACK`, or DDL statement ends the read-only transaction.

See Also:

Oracle Database SQL Language Reference for more information about the `SET TRANSACTION` statement

Long-running queries sometimes fail because undo information required for consistent read (CR) operations is no longer available. This situation occurs when active transactions overwrite committed undo blocks.

Automatic undo management lets your database administrator (DBA) explicitly control how long the database retains undo information, using the parameter `UNDO_RETENTION`. For example, if `UNDO_RETENTION` is 30 minutes, then the database retains all committed undo information for at least 30 minutes, ensuring that all queries running for 30 minutes or less do not encounter the OER error "snapshot too old."

See Also:

- *Oracle Database Concepts* for more information about read consistency
 - *Oracle Database Administrator's Guide* for information about long-running queries and resumable space allocation
-
-

8.4 Locking Tables Explicitly

Oracle Database has default locking mechanisms that ensure data concurrency, data integrity, and statement-level read consistency (for information about these, see *Oracle Database Concepts*). However, you can override these mechanisms by locking tables explicitly. Locking tables explicitly is useful in situations such as these:

- A transaction in your application needs exclusive access to a resource, so that the transaction does not have to wait for other transactions to complete.
- Your application needs transaction-level read consistency (repeatable reads).

For other ways to ensure transaction-level read consistency, see [Ensuring Repeatable Reads with Read-Only Transactions](#) (page 8-13), and [Using Serializable Transactions for Concurrency Control](#) (page 8-29).

To override default locking at the transaction level, use any of these SQL statements:

- `LOCK TABLE` (described in *Oracle Database SQL Language Reference*)
- `SELECT` with the `FOR UPDATE` clause (described in *Oracle Database SQL Language Reference*)
- `SET TRANSACTION` with the `READ ONLY` or `ISOLATION LEVEL SERIALIZABLE` option (described in *Oracle Database SQL Language Reference*)

Locks acquired by these statements are released after the transaction is committed or rolled back.

See Also:

Oracle Database SQL Language Reference for information about the `ISOLATION_LEVEL` parameter of the `ALTER SESSION` statement

The initialization parameter `DML_LOCKS` (described in *Oracle Database Reference*) determines the maximum number of DML locks. Although its default value is usually enough, you might need to increase it if you use explicit locks.

Note:

If you override the default locking of Oracle Database at any level, ensure that data integrity is guaranteed, data concurrency is acceptable, and deadlocks are either impossible or appropriately handled.

Topics:

- [Privileges Required to Acquire Table Locks](#) (page 8-15)
- [Choosing a Locking Strategy](#) (page 8-15)
- [Letting Oracle Database Control Table Locking](#) (page 8-18)
- [Explicitly Acquiring Row Locks](#) (page 8-18)
- [Examples of Concurrency Under Explicit Locking](#) (page 8-19)

8.4.1 Privileges Required to Acquire Table Locks

No special privileges are required to acquire any type of table lock on a table in your own schema. To acquire a table lock on a table in another schema, you must have either the `LOCK ANY TABLE` system privilege or any object privilege (for example, `SELECT` or `UPDATE`) for the table.

8.4.2 Choosing a Locking Strategy

A transaction explicitly acquires the specified table locks when a `LOCK TABLE` statement is executed. A `LOCK TABLE` statement explicitly overrides default locking. When a `LOCK TABLE` statement is issued on a view, the underlying base tables are locked. This statement acquires exclusive table locks for the `employees` and `departments` tables on behalf of the containing transaction:

```
LOCK TABLE employees, departments IN EXCLUSIVE MODE NOWAIT;
```

You can specify several tables or views to lock in the same mode; however, only a single lock mode can be specified for each `LOCK TABLE` statement.

Note:

When a table is locked, all rows of the table are locked. No other user can modify the table. For information about locking individual rows, see [Explicitly Acquiring Row Locks](#) (page 8-18).

In the `LOCK TABLE` statement, you can also indicate how long you want to wait for the table lock:

- If you do not want to wait, specify either `NOWAIT` or `WAIT 0`.
You acquire the table lock only if it is immediately available; otherwise, an error notifies you that the lock is unavailable now.
- To wait up to n seconds to acquire the table lock, specify `WAIT n`, where n is greater than 0 and less than or equal to 100000.

If the table lock is still unavailable after *n* seconds, an error notifies you that the lock is unavailable now.

- To wait indefinitely to acquire the lock, specify neither `NOWAIT` nor `WAIT`.

The database waits indefinitely until the table is available, locks it, and returns control to you. When the database is running DDL statements concurrently with DML statements, a timeout or deadlock can sometimes result. The database detects such timeouts and deadlocks and returns an error.

Topics:

- [When to Lock with ROW SHARE MODE and ROW EXCLUSIVE MODE](#) (page 8-16)
- [When to Lock with SHARE MODE](#) (page 8-16)
- [When to Lock with SHARE ROW EXCLUSIVE MODE](#) (page 8-17)
- [When to Lock with EXCLUSIVE MODE](#) (page 8-18)

See Also:

Oracle Database SQL Language Reference for `LOCK TABLE` statement syntax

8.4.2.1 When to Lock with ROW SHARE MODE and ROW EXCLUSIVE MODE

`ROW SHARE MODE` and `ROW EXCLUSIVE MODE` table locks offer the highest degree of concurrency. You might use these locks if:

- Your transaction must prevent another transaction from acquiring an intervening share, share row, or exclusive table lock for a table before your transaction can update that table.

If another transaction acquires an intervening share, share row, or exclusive table lock, no other transactions can update the table until the locking transaction commits or rolls back.
- Your transaction must prevent a table from being altered or dropped before your transaction can modify that table.

8.4.2.2 When to Lock with SHARE MODE

`SHARE MODE` table locks are rather restrictive data locks. You might use these locks if:

- Your transaction only queries the table, and requires a consistent set of the table data for the duration of the transaction.
- You can hold up other transactions that try to update the locked table, until all transactions that hold `SHARE MODE` locks on the table either commit or roll back.
- Other transactions might acquire concurrent `SHARE MODE` table locks on the same table, also giving them the option of transaction-level read consistency.

Caution:

Your transaction might not update the table later in the same transaction. However, if multiple transactions concurrently hold share table locks for the same table, no transaction can update the table (even if row locks are held as the result of a `SELECT FOR UPDATE` statement). Therefore, if concurrent share table locks on the same table are common, updates cannot proceed and deadlocks are common. In this case, use share row exclusive or exclusive table locks instead.

Scenario: Tables `employees` and `budget_tab` require a consistent set of data in a third table, `departments`. For a given department number, you want to update the information in `employees` and `budget_tab`, and ensure that no members are added to the department between these two transactions.

Solution: Lock the `departments` table in `SHARE MODE`, as shown in [Example 8-1](#) (page 8-17). Because the `departments` table is rarely updated, locking it probably does not cause many other transactions to wait long.

Example 8-1 LOCK TABLE with SHARE MODE

```
-- Create and populate table:

DROP TABLE budget_tab;
CREATE TABLE budget_tab (
  sal      NUMBER(8,2),
  deptno   NUMBER(4)
);

INSERT INTO budget_tab (sal, deptno)
  SELECT salary, department_id
  FROM employees;

-- Lock departments and update employees and budget_tab:

LOCK TABLE departments IN SHARE MODE;

UPDATE employees
  SET salary = salary * 1.1
  WHERE department_id IN
    (SELECT department_id FROM departments WHERE location_id = 1700);

UPDATE budget_tab
  SET sal = sal * 1.1
  WHERE deptno IN
    (SELECT department_id FROM departments WHERE location_id = 1700);

COMMIT; -- COMMIT releases lock
```

8.4.2.3 When to Lock with SHARE ROW EXCLUSIVE MODE

You might use a `SHARE ROW EXCLUSIVE MODE` table lock if:

- Your transaction requires both transaction-level read consistency for the specified table and the ability to update the locked table.
- You do not care if other transactions acquire explicit row locks (using `SELECT FOR UPDATE`), which might make `UPDATE` and `INSERT` statements in the locking transaction wait and might cause deadlocks.

- You want only a single transaction to have this action.

8.4.2.4 When to Lock with EXCLUSIVE MODE

You might use an `EXCLUSIVE MODE` table if:

- Your transaction requires immediate update access to the locked table. When your transaction holds an exclusive table lock, other transactions cannot lock specific rows in the locked table.
- Your transaction also ensures transaction-level read consistency for the locked table until the transaction is committed or rolled back.
- You are not concerned about low levels of data concurrency, making transactions that request exclusive table locks wait in line to update the table sequentially.

8.4.3 Letting Oracle Database Control Table Locking

If you let Oracle Database control table locking, your application needs less programming logic, but also has less control than if you manage the table locks yourself.

Issuing the statement `SET TRANSACTION ISOLATION LEVEL SERIALIZABLE` or `ALTER SESSION ISOLATION LEVEL SERIALIZABLE` preserves ANSI serializability without changing the underlying locking protocol. This technique gives concurrent access to the table while providing ANSI serializability. Getting table locks greatly reduces concurrency.

See Also:

- *Oracle Database SQL Language Reference* for information about the `SET TRANSACTION` statement
 - *Oracle Database SQL Language Reference* for information about the `ALTER SESSION` statements
-
-

Change the settings for these parameters only when an instance is shut down. If multiple instances are accessing a single database, then all instances must use the same setting for these parameters.

8.4.4 Explicitly Acquiring Row Locks

You can override default locking with a `SELECT` statement that includes the `FOR UPDATE` clause. This statement acquires exclusive row locks for selected rows (as an `UPDATE` statement does), in anticipation of updating the selected rows in a subsequent statement.

You can use a `SELECT FOR UPDATE` statement to lock a row without changing it. For example, several triggers in *Oracle Database PL/SQL Language Reference* show how to implement referential integrity. In the `EMP_DEPT_CHECK` trigger, the row that contains the referenced parent key value is locked to guarantee that it remains for the duration of the transaction; if the parent key is updated or deleted, referential integrity is violated.

`SELECT FOR UPDATE` statements are often used by interactive programs that let a user modify fields of one or more specific rows (which might take some time); row locks

are acquired so that only a single interactive program user is updating the rows at any given time.

If a `SELECT FOR UPDATE` statement is used when defining a cursor, the rows in the return set are locked when the cursor is opened (before the first fetch) rather than being locked as they are fetched from the cursor. Locks are released only when the transaction that opened the cursor is committed or rolled back, not when the cursor is closed.

Each row in the return set of a `SELECT FOR UPDATE` statement is locked individually; the `SELECT FOR UPDATE` statement waits until the other transaction releases the conflicting row lock. If a `SELECT FOR UPDATE` statement locks many rows in a table, and if the table experiences much update activity, it might be faster to acquire an `EXCLUSIVE` table lock instead.

Note:

The return set for a `SELECT FOR UPDATE` might change while the query is running; for example, if columns selected by the query are updated or rows are deleted after the query started. When this happens, `SELECT FOR UPDATE` acquires locks on the rows that did not change, gets a read-consistent snapshot of the table using these locks, and then restarts the query to acquire the remaining locks.

If your application uses the `SELECT FOR UPDATE` statement and cannot guarantee that a conflicting locking request will not result in user-caused deadlocks—for example, through ensuring that concurrent DML statements on a table never affect the return set of the query of a `SELECT FOR UPDATE` statement—then code the application always to handle such a deadlock (ORA-00060) in an appropriate manner.

By default, the `SELECT FOR UPDATE` statement waits until the requested row lock is acquired. To change this behavior, use the `NOWAIT`, `WAIT`, or `SKIP LOCKED` clause of the `SELECT FOR UPDATE` statement. For information about these clauses, see *Oracle Database SQL Language Reference*.

8.4.5 Examples of Concurrency Under Explicit Locking

[Table 8-2](#) (page 8-20) shows how Oracle Database maintains data concurrency, integrity, and consistency when the `LOCK TABLE` statement and the `SELECT` statement with the `FOR UPDATE` clause are used. For brevity, the message text for ORA-00054 ("resource busy and acquire with `NOWAIT` specified") is not included. User-entered text is **bold**.

Note:

In tables compressed with Hybrid Columnar Compression (HCC), DML statements lock compression units rather than rows. HCC, a feature of certain Oracle storage systems, is described in *Oracle Database Concepts*.

Table 8-2 Examples of Concurrency Under Explicit Locking

Time Point	Transaction 1	Transaction 2
1	<pre>LOCK TABLE hr.departments IN ROW SHARE MODE;</pre> <p>Statement processed.</p>	
2		<pre>DROP TABLE hr.departments;</pre> <pre>DROP TABLE hr.departments *</pre> <p>ORA-00054</p> <p>(Exclusive DDL lock not possible because Transaction 1 has table locked.)</p>
3		<pre>LOCK TABLE hr.departments IN EXCLUSIVE MODE NOWAIT;</pre> <p>ORA-00054</p>
4		<pre>SELECT location_id FROM hr.departments WHERE department_id = 20 FOR UPDATE OF location_id;</pre> <pre>LOCATION_ID ----- DALLAS</pre> <p>1 row selected.</p>
5	<pre>UPDATE hr.departments SET location_id = 'NEW YORK' WHERE department_id = 20;</pre> <p>(Waits because Transaction 2 locked same rows.)</p>	
6		<pre>ROLLBACK;</pre> <p>(Releases row locks.)</p>
7	<p>1 row processed.</p> <pre>ROLLBACK;</pre>	

Table 8-2 (Cont.) Examples of Concurrency Under Explicit Locking

Time Point	Transaction 1	Transaction 2
8	<pre>LOCK TABLE hr.departments IN ROW EXCLUSIVE MODE; Statement processed.</pre>	
9		<pre>LOCK TABLE hr.departments IN EXCLUSIVE MODE NOWAIT; ORA-00054</pre>
10		<pre>LOCK TABLE hr.departments IN SHARE ROW EXCLUSIVE MODE NOWAIT; ORA-00054</pre>
11		<pre>LOCK TABLE hr.departments IN SHARE ROW EXCLUSIVE MODE NOWAIT; ORA-00054</pre>
12		<pre>UPDATE hr.departments SET location_id = 'NEW YORK' WHERE department_id = 20; 1 row processed.</pre>
13		<pre>ROLLBACK;</pre>
14	<pre>SELECT location_id FROM hr.departments WHERE department_id = 20 FOR UPDATE OF location_id; LOCATION_ID ----- DALLAS 1 row selected.</pre>	

Table 8-2 (Cont.) Examples of Concurrency Under Explicit Locking

Time Point	Transaction 1	Transaction 2
15		<pre>UPDATE hr.departments SET location_id = 'NEW YORK' WHERE department_id = 20;</pre> <p>1 row processed.</p> <p>(Waits because Transaction 1 locked same rows.)</p>
16	<pre>ROLLBACK;</pre>	
17		<p>1 row processed.</p> <p>(Conflicting locks were released.)</p> <pre>ROLLBACK;</pre>
18	<pre>LOCK TABLE hr.departments IN ROW SHARE MODE</pre> <p>Statement processed.</p>	
19		<pre>LOCK TABLE hr.departments IN EXCLUSIVE MODE NOWAIT;</pre> <p>ORA-00054</p>
20		<pre>LOCK TABLE hr.departments IN SHARE ROW EXCLUSIVE MODE NOWAIT;</pre> <p>ORA-00054</p>
21		<pre>LOCK TABLE hr.departments IN SHARE MODE;</pre> <p>Statement processed.</p>

Table 8-2 (Cont.) Examples of Concurrency Under Explicit Locking

Time Point	Transaction 1	Transaction 2
22		<pre>SELECT location_id FROM hr.departments WHERE department_id = 20;</pre> <p>LOCATION_ID ----- DALLAS</p> <p>1 row selected.</p>
23		<pre>SELECT location_id FROM hr.departments WHERE department_id = 20 FOR UPDATE OF location_id;</pre> <p>LOCATION_ID ----- DALLAS</p> <p>1 row selected.</p>
24		<pre>UPDATE hr.departments SET location_id = 'NEW YORK' WHERE department_id = 20;</pre> <p>(Waits because Transaction 1 has conflicting table lock.)</p>
25	<pre>ROLLBACK;</pre>	
26		<p>1 row processed.</p> <p>(Conflicting table lock released.)</p> <pre>ROLLBACK;</pre>
27	<pre>LOCK TABLE hr.departments IN SHARE ROW EXCLUSIVE MODE;</pre> <p>Statement processed.</p>	
28		<pre>LOCK TABLE hr.departments IN EXCLUSIVE MODE NOWAIT;</pre> <p>ORA-00054</p>

Table 8-2 (Cont.) Examples of Concurrency Under Explicit Locking

Time Point	Transaction 1	Transaction 2
29		<pre>LOCK TABLE hr.departments IN SHARE ROW EXCLUSIVE MODE NOWAIT; ORA-00054</pre>
30		<pre>LOCK TABLE hr.departments IN SHARE MODE NOWAIT; ORA-00054</pre>
31		<pre>LOCK TABLE hr.departments IN ROW EXCLUSIVE MODE NOWAIT; ORA-00054</pre>
32		<pre>LOCK TABLE hr.departments IN SHARE MODE NOWAIT; ORA-00054</pre>
33		<pre>SELECT location_id FROM hr.departments WHERE department_id = 20; LOCATION_ID ----- DALLAS 1 row selected.</pre>
34		<pre>SELECT location_id FROM hr.departments WHERE department_id = 20 FOR UPDATE OF location_id; LOCATION_ID ----- DALLAS 1 row selected.</pre>

Table 8-2 (Cont.) Examples of Concurrency Under Explicit Locking

Time Point	Transaction 1	Transaction 2
35		<pre>UPDATE hr.departments SET location_id = 'NEW YORK' WHERE department_id = 20;</pre> <p>(Waits because Transaction 1 has conflicting table lock.)</p>
36	<pre>UPDATE hr.departments SET location_id = 'NEW YORK' WHERE department_id = 20;</pre> <p>(Waits because Transaction 2 locked same rows.)</p>	<p>(Deadlock.)</p>
37	<p>Cancel operation.</p> <pre>ROLLBACK;</pre>	
38		<p>1 row processed.</p>
39	<pre>LOCK TABLE hr.departments IN EXCLUSIVE MODE;</pre>	
40		<pre>LOCK TABLE hr.departments IN EXCLUSIVE MODE;</pre> <p>ORA-00054</p>
41		<pre>LOCK TABLE hr.departments IN ROW EXCLUSIVE MODE NOWAIT;</pre> <p>ORA-00054</p>
42		<pre>LOCK TABLE hr.departments IN SHARE MODE;</pre> <p>ORA-00054</p>
43		<pre>LOCK TABLE hr.departments IN ROW EXCLUSIVE MODE NOWAIT;</pre> <p>ORA-00054</p>

Table 8-2 (Cont.) Examples of Concurrency Under Explicit Locking

Time Point	Transaction 1	Transaction 2
44		<pre>LOCK TABLE hr.departments IN ROW SHARE MODE NOWAIT;</pre> <p>ORA-00054</p>
45		<pre>SELECT location_id FROM hr.departments WHERE department_id = 20;</pre> <p>LOCATION_ID ----- DALLAS</p> <p>1 row selected.</p>
46		<pre>SELECT location_id FROM hr.departments WHERE department_id = 20 FOR UPDATE OF location_id;</pre> <p>(Waits because Transaction 1 has conflicting table lock.)</p>
47	<pre>UPDATE hr.departments SET department_id = 30 WHERE department_id = 20;</pre> <p>1 row processed.</p>	
48	<pre>COMMIT;</pre>	
49		<p>0 rows selected.</p> <p>(Transaction 1 released conflicting lock.)</p>
50	<pre>SET TRANSACTION READ ONLY;</pre>	
51	<pre>SELECT location_id FROM hr.departments WHERE department_id = 10;</pre> <p>LOCATION_ID ----- BOSTON</p>	

Table 8-2 (Cont.) Examples of Concurrency Under Explicit Locking

Time Point	Transaction 1	Transaction 2
52		<pre>UPDATE hr.departments SET location_id = 'NEW YORK' WHERE department_id = 10;</pre> <p>1 row processed.</p>
53	<pre>SELECT location_id FROM hr.departments WHERE department_id = 10;</pre> <p>LOCATION_ID ----- BOSTON</p> <p>(Transaction 1 does not see uncommitted data.)</p>	
54		COMMIT;
55	<pre>SELECT location_id FROM hr.departments WHERE department_id = 10;</pre> <p>LOCATION_ID ----- BOSTON</p> <p>(Same result even after Transaction 2 commits.)</p>	
56	COMMIT;	
57	<pre>SELECT location_id FROM hr.departments WHERE department_id = 10;</pre> <p>LOCATION_ID ----- NEW YORK</p> <p>(Sees committed data.)</p>	

8.5 Using Oracle Lock Management Services (User Locks)

Your applications can use Oracle Lock Management services (user locks) by invoking subprograms the `DBMS_LOCK` package. An application can request a lock of a specific mode, give it a unique name (recognizable in another subprogram in the same or another instance), change the lock mode, and release it. Because a reserved user lock is an Oracle Database lock, it has all the features of a database lock, such as deadlock

detection. Ensure that any user locks used in distributed transactions are released upon COMMIT, otherwise an undetected deadlock can occur.

See Also:

Oracle Database PL/SQL Packages and Types Reference for detailed information about the DBMS_LOCK package

Topics:

- [When to Use User Locks](#) (page 8-28)
- [Viewing and Monitoring Locks](#) (page 8-29)

8.5.1 When to Use User Locks

User locks can help:

- Provide exclusive access to a device, such as a terminal
- Provide application-level enforcement of read locks
- Detect when a lock is released and clean up after the application
- Synchronize applications and enforce sequential processing

[Example 8-2](#) (page 8-28) shows how the Pro*COBOL precompiler uses locks to ensure that there are no conflicts when multiple people must access a single device.

Example 8-2 How the Pro*COBOL Precompiler Uses Locks

```
*****
* Print Check *
* Any cashier may issue a refund to a customer returning goods. *
* Refunds under $50 are given in cash, more than $50 by check. *
* This code prints the check. One printer is opened by all *
* the cashiers to avoid the overhead of opening and closing it *
* for every check, meaning that lines of output from multiple *
* cashiers can become interleaved if you do not ensure exclusive *
* access to the printer. The DBMS_LOCK package is used to *
* ensure exclusive access. *
*****
CHECK-PRINT
*   Get the lock "handle" for the printer lock.
  MOVE "CHECKPRINT" TO LOCKNAME-ARR.
  MOVE 10 TO LOCKNAME-LEN.
  EXEC SQL EXECUTE
    BEGIN DBMS_LOCK.ALLOCATE_UNIQUE ( :LOCKNAME, :LOCKHANDLE );
    END; END-EXEC.
*   Lock the printer in exclusive mode (default mode).
  EXEC SQL EXECUTE
    BEGIN DBMS_LOCK.REQUEST ( :LOCKHANDLE );
    END; END-EXEC.
*   You now have exclusive use of the printer, print the check.
  ...
*   Unlock the printer so other people can use it
  EXEC SQL EXECUTE
    BEGIN DBMS_LOCK.RELEASE ( :LOCKHANDLE );
    END; END-EXEC.
```

8.5.2 Viewing and Monitoring Locks

Table 8-3 (page 8-29) describes the Oracle Database facilities that display locking information for ongoing transactions within an instance.

Table 8-3 Ways to Display Locking Information

Tool	Description
Performance Monitoring Data Dictionary Views	See <i>Oracle Database Administrator's Guide</i> .
UTLLOCKT.SQL	The UTLLOCKT.SQL script displays a simple character lock wait-for graph in tree structured fashion. Using any SQL tool (such as SQL*Plus) to run the script, it prints the sessions in the system that are waiting for locks and the corresponding blocking locks. The location of this script file is operating system dependent. (You must have run the CATBLOCK.SQL script before using UTLLOCKT.SQL.)

8.6 Using Serializable Transactions for Concurrency Control

By default, Oracle Database permits concurrently running transactions to modify, add, or delete rows in the same table, and in the same data block. When transaction A changes a table, the changes are invisible to concurrently running transactions until transaction A commits them. If transaction A tries to update or delete a row that transaction B has locked (by issuing a DML or `SELECT FOR UPDATE` statement), then the DML statement that A issued waits until B either commits or rolls back the transaction. This concurrency model, which provides higher concurrency and thus better performance, is appropriate for most applications.

However, some rare applications require serializable transactions. **Serializable transactions** run concurrently in serialized mode. In **serialized mode**, concurrent transactions can make only the database changes that they could make if they were running serially (that is, one at a time). If a serialized transaction tries to change data that another transaction changed after the serialized transaction began, then error ORA-08177 occurs.

When a serializable transaction fails with ORA-08177, the application can take any of these actions:

- Commit the work executed to that point.
- Run additional, different, statements, perhaps after rolling back to a prior savepoint in the transaction.
- Roll back the transaction and then rerun it.

The transaction gets a transaction snapshot and the operation is likely to succeed.

Tip:

To minimize the performance overhead of rolling back and re running transactions, put DML statements that might conflict with concurrent transactions near the beginning of the transaction.

Note:

Serializable transactions do not work with deferred segment creation or interval partitioning. Trying to insert data into an empty table with no segment created, or into a partition of an interval partitioned table that does not yet have a segment, causes an error.

Topics:

- [Transaction Interaction and Isolation Level](#) (page 8-30)
- [Setting Isolation Levels](#) (page 8-32)
- [Serializable Transactions and Referential Integrity](#) (page 8-33)
- [READ COMMITTED and SERIALIZABLE Isolation Levels](#) (page 8-35)

8.6.1 Transaction Interaction and Isolation Level

The ANSI/ISO SQL standard defines three kinds of transaction interaction:

Transaction Interaction	Definition
Dirty read	Transaction A reads uncommitted changes made by transaction B.
Unrepeatable read	Transaction A reads data, transaction B changes the data and commits the changes, and transaction A rereads the data and sees the changes.
Phantom read	Transaction A runs a query, transaction B inserts new rows and commits the change, and transaction A repeats the query and sees the new rows.

The kinds of interactions that a transaction can have is determined by its isolation level. The ANSI/ISO SQL standard defines four transaction isolation levels. [Table 8-4](#) (page 8-30) shows what kind of interactions are possible at each isolation level.

Table 8-4 ANSI/ISO SQL Isolation Levels and Possible Transaction Interactions

Isolation Level	Dirty Read	Unrepeatable Read	Phantom Read
READ UNCOMMITTED	Possible	Possible	Possible
READ COMMITTED	Not possible	Possible	Possible
REPEATABLE READ	Not possible	Not possible	Possible
SERIALIZABLE	Not possible	Not possible	Not possible

[Table 8-5](#) (page 8-31) shows which ANSI/ISO SQL transaction isolation levels Oracle Database provides.

Table 8-5 ANSI/ISO SQL Isolation Levels Provided by Oracle Database

Isolation Level	Provided by Oracle Database
READ UNCOMMITTED	No. Oracle Database never permits "dirty reads." Some other database products use this undesirable technique to improve throughput, but it is not required for high throughput with Oracle Database.
READ COMMITTED	Yes, by default. In fact, because an Oracle Database query sees only data that was committed at the beginning of the query (the snapshot time), Oracle Database offers more consistency than the ANSI/ISO SQL standard for READ COMMITTED isolation requires.
REPEATABLE READ	Yes, if you set the transaction isolation level to SERIALIZABLE.
SERIALIZABLE	Yes, if you set the transaction isolation level to SERIALIZABLE.

[Figure 8-1](#) (page 8-32) shows how an arbitrary transaction (that is, one that is either SERIALIZABLE or READ COMMITTED) interacts with a serializable transaction.

Figure 8-1 Interaction Between Serializable Transaction and Another Transaction

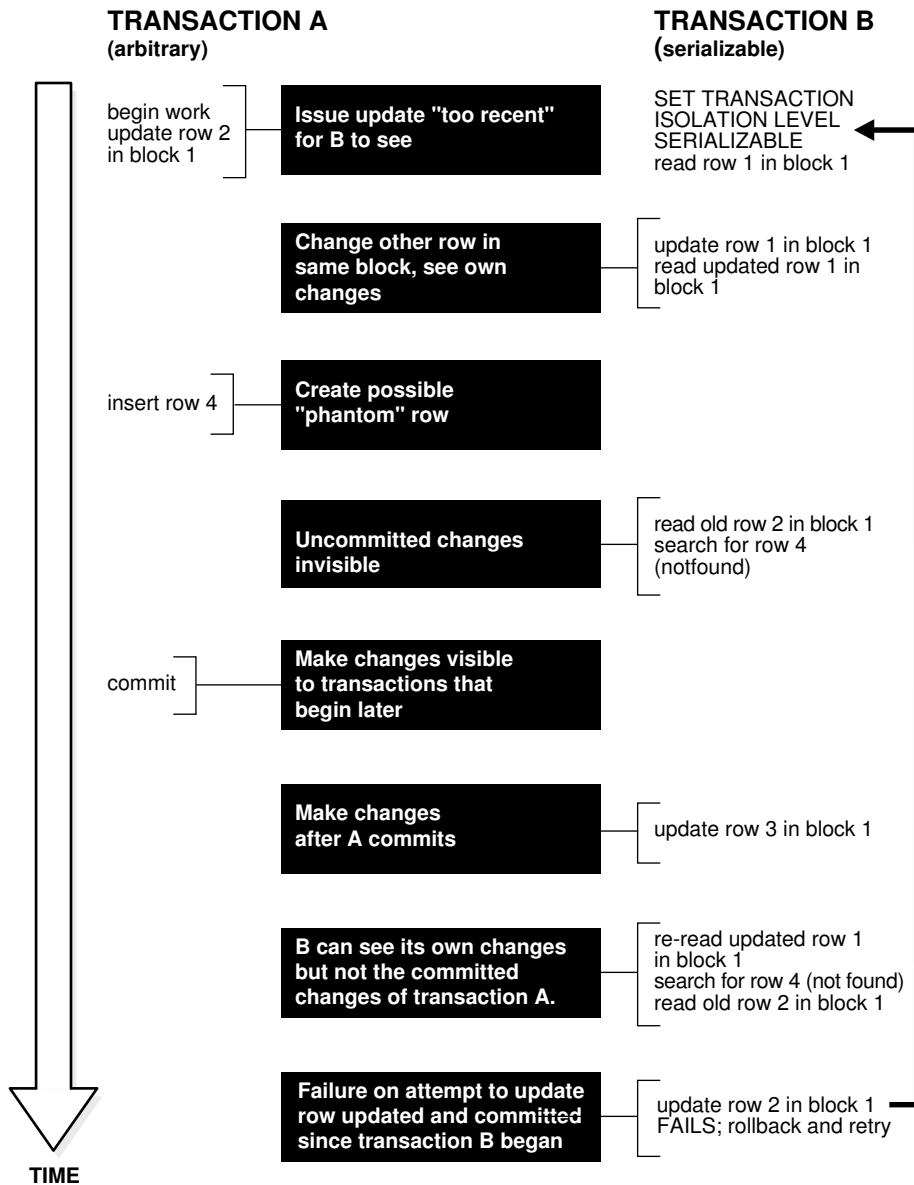

8.6.2 Setting Isolation Levels

To set the transaction isolation level for every transaction in your session, use the ALTER SESSION statement, described in *Oracle Database SQL Language Reference*.

To set the transaction isolation level for a specific transaction, use the ISOLATION LEVEL clause of the SET TRANSACTION statement. The SET TRANSACTION statement, described in *Oracle Database SQL Language Reference*, must be the first statement in the transaction.

Note:

If you set the transaction isolation level to `SERIALIZABLE`, then you must use the `ALTER TABLE` statement to set the `INITRANS` parameter to at least 3. Use higher values for tables for which many transactions update the same blocks. For more information about `INITRANS`, see *Oracle Database SQL Language Reference*.

8.6.3 Serializable Transactions and Referential Integrity

Because Oracle Database does not use read locks, even in `SERIALIZABLE` transactions, data read by one transaction can be overwritten by another. Therefore, transactions that perform database consistency checks at the application level must not assume that the data they read does not change during the transaction (even though such changes are invisible to the transaction). Code your application-level consistency checks carefully, even when using `SERIALIZABLE` transactions.

In [Figure 8-2](#) (page 8-33), transactions A and B (which are either `READ COMMITTED` or `SERIALIZABLE`) perform application-level checks to maintain the referential integrity of the parent/child relationship between two tables. Transaction A queries the parent table to check that it has a row with a specific primary key value before inserting corresponding child rows into the child table. Transaction B queries the child table to check that no child rows exist for a specific primary key value before deleting the corresponding parent row from the parent table. Both transactions assume (but do not ensure) that the data they read does not change before the transaction completes.

Figure 8-2 Referential Integrity Check

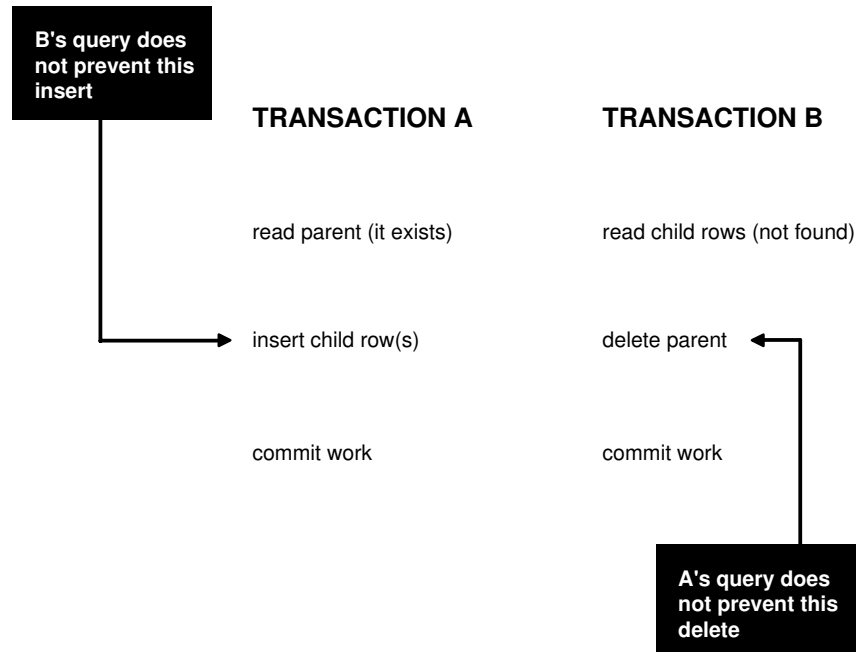

The query by transaction A does not prevent transaction B from deleting the parent row, and the query by transaction B does not prevent transaction A from inserting child rows. Therefore, this can happen:

1. Transaction A queries the parent table and finds the specified parent row.

2. Transaction B queries the child table and finds no child rows for the specified parent row.
3. Having found the specified parent row, transaction A inserts the corresponding child rows into the child table.
4. Having found no child rows for the specified parent row, transaction B deletes the specified parent row from the parent table.

Now the child rows that transaction A inserted in step 3 (page 8-34) have no parent row.

The preceding result can occur even if both A and B are `SERIALIZABLE` transactions, because neither transaction prevents the other from changing the data that it reads to check consistency.

Ensuring that data queried by one transaction is not concurrently changed or deleted by another requires more transaction isolation than the ANSI/ISO SQL standard `SERIALIZABLE` isolation level provides. However, in Oracle Database:

- Transaction A can use a `SELECT FOR UPDATE` statement to query and lock the parent row, thereby preventing transaction B from deleting it.

For information about the `FOR UPDATE` clause of the `SELECT` statement, see *Oracle Database SQL Language Reference*.

- Transaction B can prevent transaction A from finding the parent row (thereby preventing A from inserting the child rows) by reversing the order of its processing steps. That is, transaction B can:
 1. Delete the parent row.
 2. Query the child table.
 3. If the deleted parent row has child rows in the child table, then roll back the deletion of the parent row.

Alternatively, you can enforce referential integrity with a trigger. Instead of having transaction A query the parent table, define on the child table a row-level `BEFORE INSERT` trigger that does this:

- Queries the parent table with a `SELECT FOR UPDATE` statement, thereby ensuring that if the parent row exists, then it remains in the database for the duration of the transaction that inserts the child rows.
- Rejects the insertion of the child rows if the parent row does not exist.

See Also:

Oracle Database PL/SQL Language Reference for more information about using triggers to maintain referential integrity between parent and child tables

A trigger runs SQL statements in the context of the triggering statement (that is, the triggering and triggered statements see the database in the same state). Therefore, if a `READ COMMITTED` transaction runs the triggering statement, then the triggered statements see the database as it was when the triggering statement began to execute. If a `SERIALIZABLE` transaction runs the triggering statement, then the triggered

statements see the database as it was at the beginning of the transaction. In either case, using `SELECT FOR UPDATE` in the trigger correctly enforces referential integrity.

8.6.4 READ COMMITTED and SERIALIZABLE Isolation Levels

Oracle Database provides two transaction isolation levels, `READ COMMITTED` and `SERIALIZABLE`. Both levels provide a high degree of consistency and concurrency, reduce contention, and are designed for real-world applications. This topic compares them and explains how to choose between them.

Topics:

- [Transaction Set Consistency Differences](#) (page 8-35)
- [Choosing Transaction Isolation Levels](#) (page 8-36)

8.6.4.1 Transaction Set Consistency Differences

An operation (query or transaction) is **transaction set consistent** if all of its read operations return data written by the same set of committed transactions. When an operation is not transaction set consistent, some of its read operations reflect the changes of one set of transactions and others reflect the changes of other sets of transactions; that is, the operation sees the database in a state that reflects no single set of committed transactions.

Topics:

- [Oracle Database](#) (page 8-35)
- [Other Database Systems](#) (page 8-35)

8.6.4.1.1 Oracle Database

Oracle Database transactions with `READ COMMITTED` isolation level are transaction set consistent on an individual-statement basis, because all rows that a query reads must be committed before the query begins.

Oracle Database transactions with `SERIALIZABLE` isolation level are transaction set consistent on an individual-transaction basis, because all statements in a `SERIALIZABLE` transaction run on an image of the database as it was at the beginning of the transaction.

8.6.4.1.2 Other Database Systems

In other database systems, a single query with `READ UNCOMMITTED` isolation level is not transaction set consistent, because it might see only a subset of the changes made by another transaction. For example, a join of a master table with a detail table can see a master record inserted by another transaction, but not the corresponding details inserted by that transaction (or the reverse). `READ COMMITTED` isolation level avoids this problem, providing more consistency than read-locking systems do.

In read-locking systems, at the cost of preventing concurrent updates, the `REPEATABLE READ` isolation level provides transaction set consistency at the statement level, but not at the transaction level. Due to the absence of phantom read protection, two queries in the same transaction can see data committed by different sets of transactions. In these systems, only the throughput-limiting and deadlock-susceptible `SERIALIZABLE` isolation level provides transaction set consistency at the transaction level.

8.6.4.2 Choosing Transaction Isolation Levels

The choice of transaction isolation level depends on performance and consistency needs and application coding requirements. There is a trade-off between concurrency (transaction throughput) and consistency. Consider the application and workload when choosing isolation levels for its transactions. Different transactions can have different isolation levels.

For environments with many concurrent users rapidly submitting transactions, consider expected transaction arrival rate, response time demands, and required degree of consistency.

READ COMMITTED isolation can provide considerably more concurrency with a somewhat increased risk of inconsistent results (from unrepeatable and phantom reads) for some transactions.

SERIALIZABLE isolation provides somewhat more consistency (by protecting against phantoms and unrepeatable reads), which might be important where a read/write transaction runs a query more than once. However, SERIALIZABLE isolation requires applications to check for the "cannot serialize access" error, and this checking can significantly reduce throughput in an environment with many concurrent transactions accessing the same data for update.

As explained in [Serializable Transactions and Referential Integrity](#) (page 8-33) reads do not block writes in either READ COMMITTED or SERIALIZABLE transactions.

[Table 8-6](#) (page 8-36) summarizes the similarities and differences between READ COMMITTED and SERIALIZABLE transactions.

Table 8-6 Comparison of READ COMMITTED and SERIALIZABLE Transactions

Operation	READ COMMITTED	SERIALIZABLE
Dirty write	Not Possible	Not Possible
Dirty read	Not Possible	Not Possible
Unrepeatable read	Possible	Not Possible
Phantom read	Possible	Not Possible
Compliant with ANSI/ISO SQL 92	Yes	Yes
Read snapshot time	Statement	Transaction
Transaction set consistency	Statement level	Transaction level
Row-level locking	Yes	Yes
Readers block writers	No	No
Writers block readers	No	No
Different-row writers block writers	No	No
Same-row writers block writers	Yes	Yes
Waits for blocking transaction	Yes	Yes

Table 8-6 (Cont.) Comparison of READ COMMITTED and SERIALIZABLE Transactions

Operation	READ COMMITTED	SERIALIZABLE
Subject to "cannot serialize access" error	No	Yes
Error after blocking transaction terminates	No	No
Error after blocking transaction commits	No	Yes

8.7 Nonblocking and Blocking DDL Statements

The distinction between nonblocking and blocking DDL statements matters only for DDL statements that change either tables or indexes (which depend on tables).

When a session issues a DDL statement that affects object X, the session waits until every concurrent DML statement that references X is either committed or rolled back.

While the session waits, concurrent sessions might issue new DML statements. If the DDL statement is nonblocking, then the new DML statements execute immediately. If the DDL statement is blocking, then the new DML statements execute after the DDL statement completes, either successfully or with an error.

The `DDL_LOCK_TIMEOUT` parameter affects blocking DDL statements (but not nonblocking DDL statements). Therefore, a blocking DDL statement can complete with error `ORA-00054` (resource busy and acquire with `NOWAIT` specified or timeout expired). For information about the `DDL_LOCK_TIMEOUT` parameter, see *Oracle Database Reference*.

A DDL statement that applies to a partition of a table is blocking for that partition but nonblocking for other partitions of the same table.

For a list of nonblocking DDL statements, see *Oracle Database SQL Language Reference*.

Note:

If supplemental logging is enabled at database level (for a multitenant container database or pluggable database), then the database treats nonblocking DDL statements like blocking DDL statements. For information about enabling and disabling supplemental logging, see *Oracle Database SQL Language Reference*.

Caution:

Do not issue a nonblocking DDL statement in an autonomous transaction. For information about autonomous transactions, see "[Autonomous Transactions](#) (page 8-38)."

8.8 Autonomous Transactions

Caution:

Do not issue a nonblocking DDL statement in an autonomous transaction. For information about nonblocking DDL statements, see "[Nonblocking and Blocking DDL Statements](#) (page 8-37)."

An **autonomous transaction** (AT) is an independent transaction started by another transaction, the **main transaction** (MT). An autonomous transaction lets you suspend the main transaction, do SQL operations, commit or roll back those operations, and then resume the main transaction.

For example, in a stock purchase transaction, you might want to commit customer information regardless of whether the purchase succeeds. Or, you might want to log error messages to a debug table even if the transaction rolls back. Autonomous transactions let you do such tasks.

An autonomous transaction runs within an **autonomous scope**; that is, within the scope of an **autonomous routine**—a routine that you mark with the `AUTONOMOUS_TRANSACTION` pragma. In this context, a **routine** is one of these:

- Schema-level (not nested) anonymous PL/SQL block
- Standalone, package, or nested subprogram
- Method of an ADT
- Noncompound trigger

An autonomous routine can commit multiple autonomous transactions.

[Figure 8-3](#) (page 8-38) shows how control flows from the main transaction (`proc1`) to an autonomous routine (`proc2`) and back again. The autonomous routine commits two transactions (AT1 and AT2) before control returns to the main transaction.

Figure 8-3 Transaction Control Flow

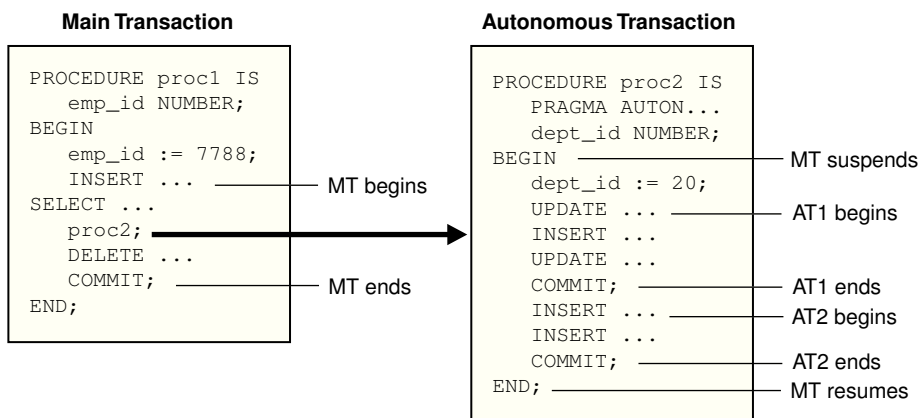

When you enter the executable section of an autonomous transaction, the main transaction suspends. When you exit the transaction, the main transaction resumes. `COMMIT` and `ROLLBACK` end the active autonomous transaction but do not exit the

autonomous transaction. As [Figure 8-3](#) (page 8-38) shows, when one transaction ends, the next SQL statement begins another transaction.

More characteristics of autonomous transactions:

- The changes an autonomous transaction effects do not depend on the state or the eventual disposition of the main transaction. For example:
 - An autonomous transaction does not see changes made by the main transaction.
 - When an autonomous transaction commits or rolls back, it does not affect the outcome of the main transaction.
- The changes an autonomous transaction effects are visible to other transactions as soon as that autonomous transaction commits. Therefore, users can access the updated information without having to wait for the main transaction to commit.
- Autonomous transactions can start other autonomous transactions.

[Figure 8-4](#) (page 8-40) shows some possible sequences that autonomous transactions can follow.

Figure 8-4 Possible Sequences of Autonomous Transactions

A main transaction scope (MT Scope) begins the main transaction, MTx. MTx invokes the first autonomous transaction scope (AT Scope1). MTx suspends. AT Scope 1 begins the transaction Tx1.1.

At Scope 1 commits or rolls back Tx1.1, then ends. MTx resumes.

MTx invokes AT Scope 2. MTx suspends, passing control to AT Scope 2 which, initially, is performing queries.

AT Scope 2 then begins Tx2.1 by, say, doing an update. AT Scope 2 commits or rolls back Tx2.1.

Later, AT Scope 2 begins a second transaction, Tx2.2, then commits or rolls it back.

AT Scope 2 performs a few queries, then ends, passing control back to MTx.

MTx invokes AT Scope 3. MTx suspends, AT Scope 3 begins.

AT Scope 3 begins Tx3.1 which, in turn, invokes AT Scope 4. Tx3.1 suspends, AT Scope 4 begins.

AT Scope 4 begins Tx4.1, commits or rolls it back, then ends. AT Scope 3 resumes.

AT Scope 3 commits or rolls back Tx3.1, then ends. MTx resumes.

Finally, MT Scope commits or rolls back MTx, then ends.

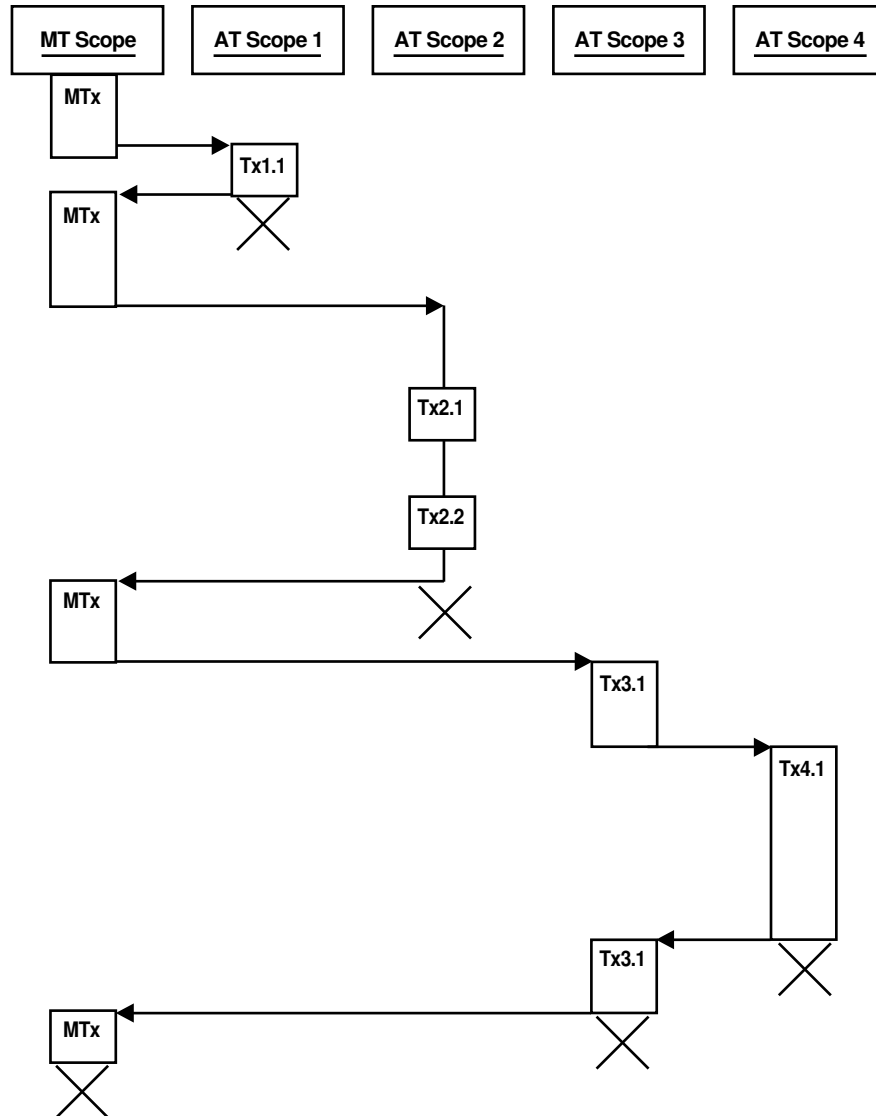

Topics:

- [Examples of Autonomous Transactions](#) (page 8-40)
- [Declaring Autonomous Routines](#) (page 8-44)

See Also:

Oracle Database PL/SQL Language Reference for detailed information about autonomous transactions

8.8.1 Examples of Autonomous Transactions

This section shows examples of autonomous transactions.

Topics:

- [Ordering a Product](#) (page 8-41)
- [Withdrawing Money from a Bank Account](#) (page 8-41)

As these examples show, there are four possible outcomes when you use autonomous and main transactions (see [Table 8-7](#) (page 8-41)). There is no dependency between the outcome of an autonomous transaction and that of a main transaction.

Table 8-7 Possible Transaction Outcomes

Autonomous Transaction	Main Transaction
Commits	Commits
Commits	Rolls back
Rolls back	Commits
Rolls back	Rolls back

8.8.1.1 Ordering a Product

[Figure 8-5](#) (page 8-41) shows an example of a customer ordering a product. The customer information (such as name, address, phone) is committed to a customer information table—even though the sale does not go through.

Figure 8-5 Example: A Buy Order

MT Scope begins the main transaction, MTx inserts the buy order into a table.

MTx invokes the autonomous transaction scope (AT Scope). When AT Scope begins, MT Scope suspends.

ATx, updates the audit table with customer information.

MTx seeks to validate the order, finds that the selected item is unavailable, and therefore rolls back the main transaction.

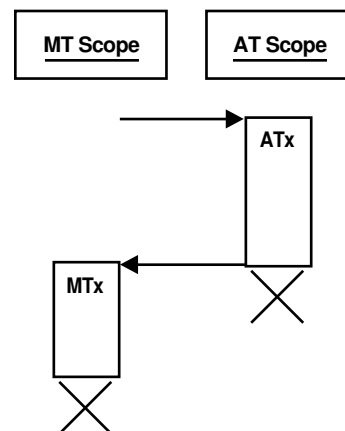
**8.8.1.2 Withdrawing Money from a Bank Account**

In this example, a customer tries to withdraw money from a bank account. In the process, a main transaction invokes one of two autonomous transaction scopes (AT Scope 1 or AT Scope 2).

The possible scenarios for this transaction are:

- [Scenario 1: Sufficient Funds](#) (page 8-42)
- [Scenario 2: Insufficient Funds with Overdraft Protection](#) (page 8-42)
- [Scenario 3: Insufficient Funds Without Overdraft Protection](#) (page 8-43)

8.8.1.2.1 Scenario 1: Sufficient Funds

There are sufficient funds to cover the withdrawal, so the bank releases the funds (see [Figure 8-6](#) (page 8-42)).

Figure 8-6 Bank Withdrawal—Sufficient Funds

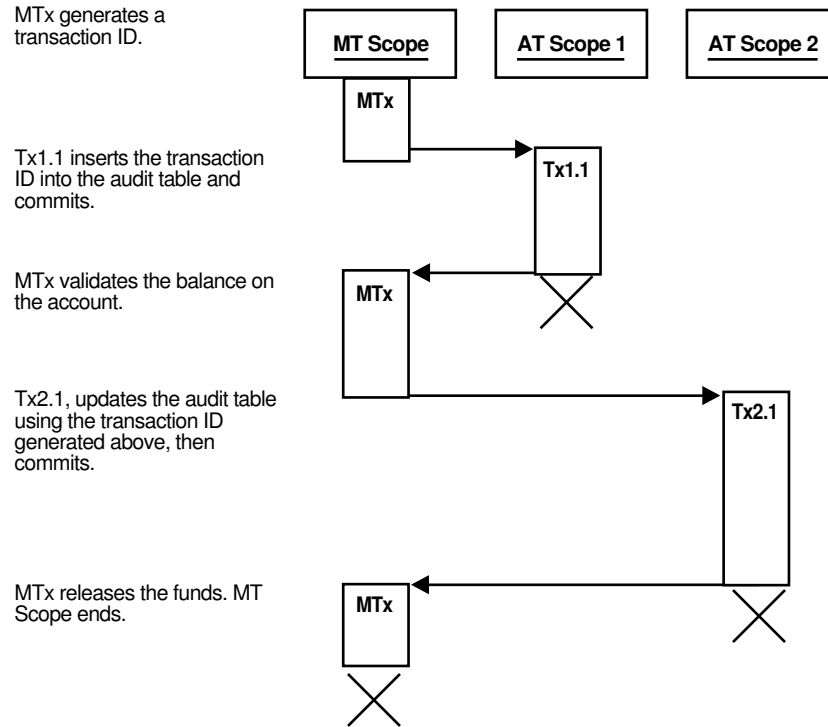

8.8.1.2.2 Scenario 2: Insufficient Funds with Overdraft Protection

There are insufficient funds to cover the withdrawal, but the customer has overdraft protection, so the bank releases the funds (see [Figure 8-7](#) (page 8-43)).

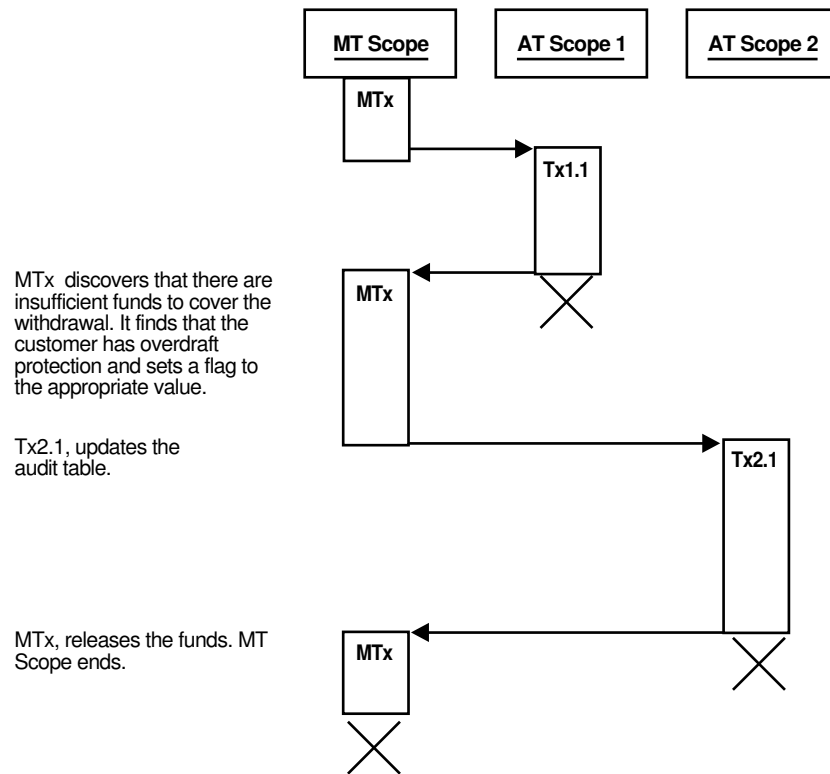
Figure 8-7 Bank Withdrawal—Insufficient Funds with Overdraft Protection**8.8.1.2.3 Scenario 3: Insufficient Funds Without Overdraft Protection**

There are insufficient funds to cover the withdrawal and the customer does not have overdraft protection, so the bank withholds the requested funds (see [Figure 8-8](#) (page 8-44)).

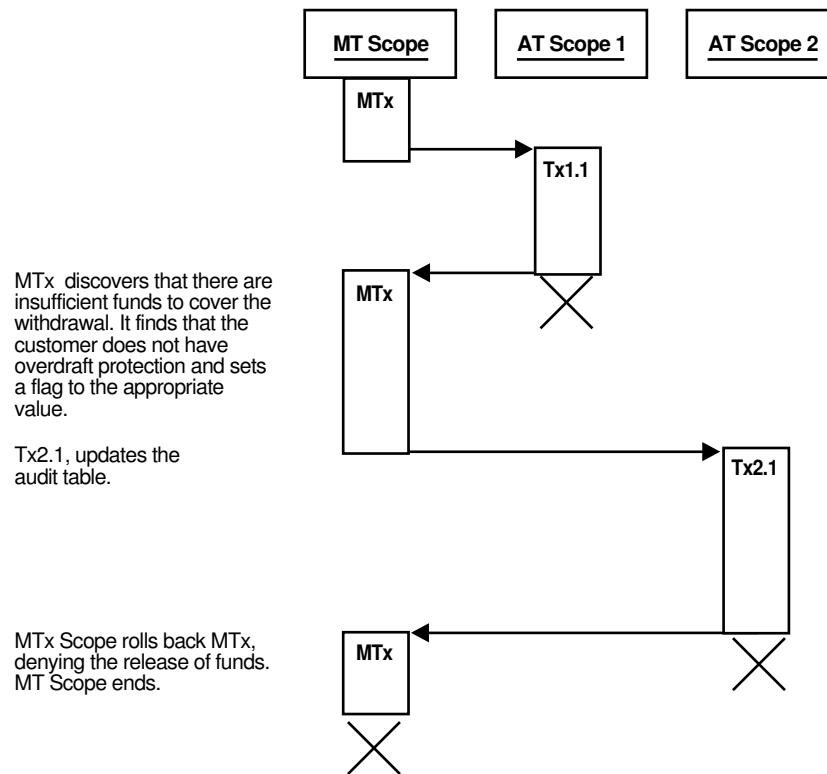
Figure 8-8 Bank Withdrawal—Insufficient Funds Without Overdraft Protection

8.8.2 Declaring Autonomous Routines

To declare an autonomous routine, use `PRAGMA AUTONOMOUS_TRANSACTION`, which instructs the PL/SQL compiler to mark the routine as autonomous.

See Also:

Oracle Database PL/SQL Language Reference for more information about `PRAGMA AUTONOMOUS_TRANSACTION`

In [Example 8-3](#) (page 8-44), the function `balance` is autonomous.

Example 8-3 Marking a Package Subprogram as Autonomous

```
-- Create table for package to use:

DROP TABLE accounts;
CREATE TABLE accounts (account INTEGER, balance REAL);

-- Create package:

CREATE OR REPLACE PACKAGE banking AS
  FUNCTION balance (acct_id INTEGER) RETURN REAL;
  -- Additional functions and packages
END banking;
/
CREATE OR REPLACE PACKAGE BODY banking AS
  FUNCTION balance (acct_id INTEGER) RETURN REAL IS
    PRAGMA AUTONOMOUS_TRANSACTION;
    my_bal REAL;
```

```

BEGIN
  SELECT balance INTO my_bal FROM accounts WHERE account=acct_id;
  RETURN my_bal;
END;
-- Additional functions and packages
END banking;
/

```

8.9 Resuming Execution After Storage Allocation Errors

When a long-running transaction is interrupted by a storage allocation error, the application can suspend the statement that encountered the problem, correct the problem, and then resume executing the statement. This capability, called **resumable storage allocation**, avoids time-consuming rollbacks. It also makes it unnecessary to split the operation into smaller pieces and write code to track its progress.

See Also:

Oracle Database Administrator's Guide for more information about resumable storage allocation

Topics:

- [What Operations Have Resumable Storage Allocation?](#) (page 8-45)
- [Handling Suspended Storage Allocation](#) (page 8-45)

8.9.1 What Operations Have Resumable Storage Allocation?

Queries, DML statements, and some DDL statements have resumable storage allocation after these kinds of errors:

- Out-of-space errors, such as ORA-01653.
- Space-limit errors, such as ORA-01628.
- Space-quota errors, such as ORA-01536.

Resumable storage allocation is possible whether the operation is performed directly by a SQL statement or within SQL*Loader, a stored subprogram, an anonymous PL/SQL block, or an OCI call such as `OCIStmtExecute`.

In dictionary-managed tablespaces, you cannot resume an index- or table-creating operation that encounters the limit for rollback segments or the maximum number of extents. You must use locally managed tablespaces and automatic undo management in combination with resumable storage allocation.

8.9.2 Handling Suspended Storage Allocation

When a statement in an application is suspended because of a storage allocation error, the application does not receive an error code. Therefore, either the application must use an `AFTER SUSPEND` trigger or the DBA must periodically check for suspended statements.

After the problem is corrected (usually by the DBA), the suspended statement automatically resumes execution. If the timeout period expires before the problem is corrected, then the statement raises a `SERVERERROR` exception.

Topics:

- [Using an AFTER SUSPEND Trigger in the Application](#) (page 8-46)
- [Checking for Suspended Statements](#) (page 8-47)

8.9.2.1 Using an AFTER SUSPEND Trigger in the Application

In the application, an AFTER SUSPEND trigger can get information about the problem by invoking subprograms in the DBMS_RESUMABLE package (described in *Oracle Database PL/SQL Packages and Types Reference*). Then the trigger can send the information to an operator, using email (for example).

To reduce the chance of out-of-space errors within the trigger itself, declare the trigger as an autonomous transaction. As an autonomous transaction, the trigger uses a rollback segment in the SYSTEM tablespace. If the trigger encounters a deadlock condition because of locks held by the suspended statement, then the trigger terminates and the application receives the original error code, as if the statement were never suspended. If the trigger encounters an out-of-space condition, then both the trigger and the suspended statement are rolled back. To prevent rollback, use an exception handler in the trigger to wait for the statement to resume.

For general information about triggers, see *Oracle Database PL/SQL Language Reference*.

The trigger in [Example 8-4](#) (page 8-46) handles storage errors within the database. For some kinds of errors, the trigger terminates the statement and alerts the DBA, using e-mail. For other errors, which might be temporary, the trigger specifies that the statement waits for eight hours before resuming, expecting the storage problem to be fixed by then. To run this example, you must connect to the database as SYSDBA.

Example 8-4 AFTER SUSPEND Trigger Handles Suspended Storage Allocation

```
-- Create table used by trigger body

DROP TABLE rbs_error;
CREATE TABLE rbs_error (
  SQL_TEXT VARCHAR2(64),
  ERROR_MSG VARCHAR2(64),
  SUSPEND_TIME VARCHAR2(64)
);

-- Resumable Storage Allocation

CREATE OR REPLACE TRIGGER suspend_example
  AFTER SUSPEND
  ON DATABASE
DECLARE
  cur_sid          NUMBER;
  cur_inst        NUMBER;
  err_type        VARCHAR2(64);
  object_owner    VARCHAR2(64);
  object_type     VARCHAR2(64);
  table_space_name VARCHAR2(64);
  object_name     VARCHAR2(64);
  sub_object_name VARCHAR2(64);
  msg_body        VARCHAR2(64);
  ret_value       BOOLEAN;
  error_txt       VARCHAR2(64);
  mail_conn       UTL_SMTP.CONNECTION;
BEGIN
  SELECT DISTINCT(SID) INTO cur_sid FROM V$MYSTAT;
```

```

cur_inst := USERENV('instance');
ret_value := DBMS_RESUMABLE.SPACE_ERROR_INFO
             (err_type,
              object_owner,
              object_type,
              table_space_name,
              object_name,
              sub_object_name);
IF object_type = 'ROLLBACK SEGMENT' THEN
  INSERT INTO rbs_error
    (SELECT SQL_TEXT, ERROR_MSG, SUSPEND_TIME
     FROM DBA_RESUMABLE
     WHERE SESSION_ID = cur_sid
     AND INSTANCE_ID = cur_inst);

  SELECT ERROR_MSG INTO error_txt
  FROM DBA_RESUMABLE
  WHERE SESSION_ID = cur_sid
  AND INSTANCE_ID = cur_inst;

  msg_body :=
    'Space error occurred: Space limit reached for rollback segment '
    || object_name || ' on ' || to_char(SYSDATE, 'Month dd, YYYY, HH:MIam')
    || '. Error message was: ' || error_txt;

  mail_conn := UTL_SMTP.OPEN_CONNECTION('localhost', 25);
  UTL_SMTP.HELO(mail_conn, 'localhost');
  UTL_SMTP.MAIL(mail_conn, 'sender@localhost');
  UTL_SMTP.RCPT(mail_conn, 'recipient@localhost');
  UTL_SMTP.DATA(mail_conn, msg_body);
  UTL_SMTP.QUIT(mail_conn);
  DBMS_RESUMABLE.ABORT(cur_sid);
ELSE
  DBMS_RESUMABLE.SET_TIMEOUT(3600*8);
END IF;
COMMIT;
END;
/

```

8.9.2.2 Checking for Suspended Statements

If the application does not use an AFTER SUSPEND trigger, then the DBA must periodically check for suspended statements, using the static data dictionary view DBA_RESUMABLE (described in *Oracle Database Reference*).

The DBA can get additional information from the dynamic performance view V\$_SESSION_WAIT (described in *Oracle Database Reference*).

Using SQL Data Types in Database Applications

This chapter explains how to choose the correct SQL data types for database columns that you create for your database applications. For syntactic and semantic information about SQL data types, see *Oracle Database SQL Language Reference*.

Topics:

- [Using the Correct and Most Specific Data Type](#) (page 9-1)
- [Representing Character Data](#) (page 9-5)
- [Representing Numeric Data](#) (page 9-7)
- [Representing Date and Time Data](#) (page 9-13)
- [Representing Specialized Data](#) (page 9-20)
- [Identifying Rows by Address](#) (page 9-24)
- [Displaying Metadata for SQL Operators and Functions](#) (page 9-26)

See Also:

- *Oracle Database SQL Language Reference* for information about data type conversion
- [PL/SQL Data Types](#) (page 13-8)

Note:

Oracle precompilers recognize, in embedded SQL programs, data types other than SQL and PL/SQL data types. These **external data types** are associated with host variables. For information about Oracle precompilers, see [Overview of Precompilers](#) (page 20-15).

9.1 Using the Correct and Most Specific Data Type

Using the correct and most specific data type for each database column that you create for your database application increases data integrity, decreases storage requirements, and improves performance.

Topics:

- [How the Correct Data Type Increases Data Integrity](#) (page 9-2)
- [How the Most Specific Data Type Decreases Storage Requirements](#) (page 9-2)
- [How the Correct Data Type Improves Performance](#) (page 9-3)

9.1.1 How the Correct Data Type Increases Data Integrity

The correct data type increases data integrity by acting as a constraint. For example, if you use a datetime data type for a column of dates, then only dates can be stored in that column. However, if you use a character or numeric data type for the column, then eventually someone will store a character or numeric value that does not represent a date. You could write code to prevent this problem, but it is more efficient to use the correct data type. Therefore, store characters in character data types, numbers in numeric data types, and dates and times in datetime data types.

See Also:

[Maintaining Data Integrity in Database Applications](#) (page 12-1), for information about data integrity and constraints

9.1.2 How the Most Specific Data Type Decreases Storage Requirements

In addition to using the correct data type, use the most specific length or precision; for example:

- When creating a VARCHAR2 column intended for strings of at most n characters, specify VARCHAR2(n).
- When creating a column intended for integers, use the data type NUMBER(38) rather than NUMBER.

Besides acting as constraints and thereby increasing data integrity, length and precision affect storage requirements.

If you give every column the maximum length or precision for its data type, then your application needlessly allocates many megabytes of RAM. For example, suppose that a query selects 10 VARCHAR2(4000) columns and a bulk fetch operation returns 100 rows. The RAM that your application must allocate is $10 \times 4,000 \times 100$ —almost 4 MB. In contrast, if the column length is 80, the RAM that your application must allocate is $10 \times 80 \times 100$ —about 78 KB. This difference is significant for a single query, and your application will process many queries concurrently. Therefore, your application must allocate the 4 MB or 78 KB of RAM *for each connection*.

Therefore, do not give a column the maximum length or precision for its data type only because you might need to increase that property later. If you must change a column after creating it, then use the ALTER TABLE statement (described in *Oracle Database SQL Language Reference*). For example, to increase the length of a column, use:

```
ALTER TABLE table_name MODIFY column_name VARCHAR2(larger_number)
```

Note:

The maximum length of the VARCHAR2, NVARCHAR2, and RAW data types is 32,767 bytes if the MAX_STRING_SIZE initialization parameter is EXTENDED. For more information about extended data types, see *Oracle Database SQL Language Reference*.

9.1.3 How the Correct Data Type Improves Performance

The correct data type improves performance because the incorrect data type can result in the incorrect execution plan. (For information about the execution plan, see [EXPLAIN PLAN Statement](#) (page 3-7).)

Example 9-1 (page 9-3) performs the same conceptual operation—selecting rows whose dates are between December 31, 2000 and January 1, 2001—for three columns with different data types and shows the execution plan for each query. In the three execution plans, compare Rows (cardinality), Cost, and Operation.

Example 9-1 Performance Comparison of Three Data Types

Create a table that stores the same dates in three columns: `str_date`, with data type VARCHAR2; `date_date`, with data type DATE, and `number_date`, with data type NUMBER:

```
CREATE TABLE t (str_date, date_date, number_date, data)
AS
SELECT TO_CHAR(dt+rownum, 'yyyymmdd')           str_date,   -- VARCHAR2
       dt+rownum                               date_date,  -- DATE
       TO_NUMBER(TO_CHAR(dt+rownum, 'yyyymmdd')) number_date, -- NUMBER
       RPAD('*',45, '*')                       data
FROM (SELECT TO_DATE('01-jan-1995', 'dd-mm-yyyy') dt
      FROM all_objects)
ORDER BY DBMS_RANDOM.VALUE
/
```

Create an index on each column:

```
CREATE INDEX t_str_date_idx ON t(str_date);
CREATE INDEX t_date_date_idx ON t(date_date);
CREATE INDEX t_number_date_idx ON t(number_date);
```

Gather statistics for the table:

```
BEGIN
  DBMS_STATS.GATHER_TABLE_STATS (
    'HR',
    'T',
    method_opt => 'for all indexed columns size 254',
    cascade => TRUE
  );
END;
/
```

Show the execution plans of subsequent SQL statements (SQL*Plus command):

```
SET AUTOTRACE ON EXPLAIN
```

Select the rows for which the dates in `str_date` are between December 31, 2000 and January 1, 2001:

```
SELECT * FROM t WHERE str_date BETWEEN '20001231' AND '20010101'
ORDER BY str_date;
```

Result and execution plan:

```
STR_DATE DATE_DATE NUMBER_DATE DATA
-----
20001231 31-DEC-00    20001231 *****
20010101 01-JAN-01    20010101 *****
```

2 rows selected.

Execution Plan

Plan hash value: 948745535

Id	Operation	Name	Rows	Bytes	Cost (%CPU)	Time
0	SELECT STATEMENT		236	11092	216 (8)	00:00:01
1	SORT ORDER BY		236	11092	216 (8)	00:00:01
* 2	TABLE ACCESS FULL	T	236	11092	215 (8)	00:00:01

Predicate Information (identified by operation id):

```
2 - filter("STR_DATE"<='20010101' AND "STR_DATE">='20001231')
```

Select the rows for which the dates in number_date are between December 31, 2000 and January 1, 2001:

```
SELECT * FROM t WHERE number_date BETWEEN 20001231 AND 20010101;
ORDER BY str_date;
```

Result and execution plan:

```
STR_DATE DATE_DATE NUMBER_DATE DATA
-----
20001231 31-DEC-00    20001231 *****
20010101 01-JAN-01    20010101 *****
```

2 rows selected.

Execution Plan

Plan hash value: 948745535

Id	Operation	Name	Rows	Bytes	Cost (%CPU)	Time
0	SELECT STATEMENT		234	10998	219 (10)	00:00:01
1	SORT ORDER BY		234	10998	219 (10)	00:00:01
* 2	TABLE ACCESS FULL	T	234	10998	218 (9)	00:00:01

Predicate Information (identified by operation id):

```
2 - filter("NUMBER_DATE"<=20010101 AND "NUMBER_DATE">=20001231)
```

Select the rows for which the dates in `date_date` are between December 31, 2000 and January 1, 2001:

```
SELECT * FROM t WHERE date_date
   BETWEEN TO_DATE('20001231','yyyymmdd')
   AND     TO_DATE('20010101','yyyymmdd');
ORDER BY str_date;
```

Result and execution plan (reformatted to fit the page):

```
STR_DATE DATE_DATE NUMBER_DATE DATA
-----
20001231 31-DEC-00    20001231 *****
20010101 01-JAN-01    20010101 *****
```

2 rows selected.

Execution Plan

Plan hash value: 2411593187

Id	Operation	Name	Rows	Bytes
1	SORT ORDER BY		1	47
2	TABLE ACCESS BY INDEX ROWID BATCHED	T	1	47
* 3	INDEX RANGE SCAN	T_DATE_DATE_IDX	1	
0	SELECT STATEMENT		1	47

Cost (%CPU)	Time
4 (25)	00:00:01
4 (25)	00:00:01
3 (0)	00:00:01
2 (0)	00:00:01

Predicate Information (identified by operation id):

```
3 - access("DATE_DATE">=TO_DATE(' 2000-12-31 00:00:00',
'syyyy-mm-dd hh24:mi:ss') AND
"DATE_DATE"<=TO_DATE(' 2001-01-01 00:00:00', 'syyyy-mm-dd hh24:mi:ss'))
```

Performance improved for the final query because, for the `DATE` data type, the optimizer could determine that there was only one day between December 31, 2000 and January 1, 2001. Therefore, it performed an index range scan, which is faster than a full table scan. (For information about full table scans, see *Oracle Database SQL Tuning Guide*. For information about index range scans, see *Oracle Database SQL Tuning Guide*.)

9.2 Representing Character Data

Table 9-1 (page 9-6) summarizes the SQL data types that store character data.

Table 9-1 SQL Character Data Types

Data Types	Values Stored
CHAR	Fixed-length character literals
VARCHAR2	Variable-length character literals
NCHAR	Fixed-length Unicode character literals
NVARCHAR2	Variable-length Unicode character literals
CLOB	Single-byte and multibyte character strings of up to (4 gigabytes - 1) * (the value obtained from DBMS_LOB.GETCHUNKSIZE)
NCLOB	Single-byte and multibyte Unicode character strings of up to (4 gigabytes - 1) * (the value obtained from DBMS_LOB.GETCHUNKSIZE)
LONG	Variable-length character data of up to 2 gigabytes - 1. Provided only for backward compatibility.

Note:

Do not use the VARCHAR data type. Use the VARCHAR2 data type instead. Although the VARCHAR data type is currently synonymous with VARCHAR2, the VARCHAR data type is scheduled to be redefined as a separate data type used for variable-length character strings compared with different comparison semantics.

When choosing between CHAR and VARCHAR2, consider:

- Space usage
Oracle Database blank-pads values stored in CHAR columns but not values stored in VARCHAR2 columns. Therefore, VARCHAR2 columns use space more efficiently than CHAR columns.
- Performance
Because of the blank-padding difference, a full table scan on a large table containing VARCHAR2 columns might read fewer data blocks than a full table scan on a table containing the same data stored in CHAR columns. If your application often performs full table scans on large tables containing character data, then you might be able to improve performance by storing data in VARCHAR2 columns rather than in CHAR columns.
- Comparison semantics
When you need ANSI compatibility in comparison semantics, use the CHAR data type. When trailing blanks are important in string comparisons, use the VARCHAR2 data type.

See Also:

Oracle Database SQL Language Reference for more information about comparison semantics for these data types

For a client/server application, if the character set on the client side differs from the character set on the server side, then Oracle Database converts CHAR, VARCHAR2, and LONG data from the database character set (determined by the NLS_LANGUAGE parameter) to the character set defined for the user session.

See Also:

- *Oracle Database SQL Language Reference* for more information about CHAR, VARCHAR2, NCHAR, and NVARCHAR2 data types
 - [Large Objects \(LOBs\)](#) (page 9-20), for more information about CLOB and NCLOB data types
 - [LONG and LONG RAW Data Types](#) (page 9-21), for more information about LONG data type
-

9.3 Representing Numeric Data

The SQL data types that store numeric data are NUMBER, BINARY_FLOAT, and BINARY_DOUBLE.

The NUMBER data type stores real numbers in either a fixed-point or floating-point format. NUMBER offers up to 38 decimal digits of precision. In a NUMBER column, you can store positive and negative numbers of magnitude 1×10^{-130} through 9.99×10^{125} , and 0. All Oracle Database platforms support NUMBER values.

The BINARY_FLOAT and BINARY_DOUBLE data types store floating-point numbers in the single-precision (32-bit) IEEE 754 format and the double-precision (64-bit) IEEE 754 format, respectively. High-precision values use less space when stored as BINARY_FLOAT and BINARY_DOUBLE than when stored as NUMBER. Arithmetic operations on floating-point numbers are usually faster for BINARY_FLOAT and BINARY_DOUBLE values than for NUMBER values.

In client interfaces that Oracle Database supports, arithmetic operations on BINARY_FLOAT and BINARY_DOUBLE values are performed by the native instruction set that the hardware vendor supplies. The term **native floating-point data type** includes BINARY_FLOAT and BINARY_DOUBLE data types and all implementations of these types in supported client interfaces.

Native floating-point data types conform substantially with the Institute of Electrical and Electronics Engineers (IEEE) Standard for Binary Floating-Point Arithmetic, IEEE Standard 754-1985 (IEEE754). For details, see *Oracle Database SQL Language Reference*.

Note:

Oracle recommends using BINARY_FLOAT and BINARY_DOUBLE instead of FLOAT, a subtype of NUMBER described in *Oracle Database SQL Language Reference*.

Topics:

- [Floating-Point Number Components](#) (page 9-8)
- [Floating-Point Number Formats](#) (page 9-8)
- [Representing Special Values with Native Floating-Point Data Types](#) (page 9-10)
- [Comparing Native Floating-Point Values](#) (page 9-11)
- [Arithmetic Operations with Native Floating-Point Data Types](#) (page 9-11)
- [Conversion Functions for Native Floating-Point Data Types](#) (page 9-12)
- [Client Interfaces for Native Floating-Point Data Types](#) (page 9-13)

See Also:

- *Oracle Database SQL Language Reference* for more information about the NUMBER data type
 - *Oracle Database SQL Language Reference* for more information about the BINARY_FLOAT and BINARY_DOUBLE data types
-
-

9.3.1 Floating-Point Number Components

The formula for a floating-point value is:

$$(-1)^{\text{sign}}.\text{significand}.\text{base}^{\text{exponent}}$$

For example, the floating-point value 4.31 is represented:

$$(-1)^0.431.10^{-2}$$

The components of the preceding representation are:

Component Name	Component Value
Sign	0
Significand	431
Base	10
Exponent	-2

9.3.2 Floating-Point Number Formats

A floating-point number format specifies how the components of a floating-point number are represented, thereby determining the range and precision of the values that the format can represent. The **range** is the interval bounded by the smallest and largest values and the **precision** is the number of significant digits. Both range and precision are finite. If a floating-point number is too precise for a given format, then the number is rounded.

How the number is rounded depends on the base of its format, which can be either decimal or binary. A number stored in decimal format is rounded to the nearest

decimal place (for example, 1000, 10, or 0.01). A number stored in binary format is rounded to the nearest binary place (for example, 1024, 512, or 1/64).

NUMBER values are stored in decimal format. For calculations that need decimal rounding, use the NUMBER data type.

Native floating-point values are stored in binary format.

Table 9-2 (page 9-9) shows the range and precision of the IEEE 754 single- and double-precision formats and Oracle Database NUMBER. Range limits are expressed as positive numbers, but they also apply to absolute values of negative numbers. (The notation "number e exponent" means $number * 10^{\text{exponent}}$.)

Table 9-2 Range and Precision of Floating-Point Data Types

Range and Precision	Single-precision 32-bit ¹	Double-precision 64-bit ¹	Oracle Database NUMBER Data Type
Maximum positive normal number	3.40282347e+38	1.7976931348623157e+308	< 1.0e126
Minimum positive normal number	1.17549435e-38	2.2250738585072014e-308	1.0e-130
Maximum positive subnormal number	1.17549421e-38	2.2250738585072009e-308	not applicable
Minimum positive subnormal number	1.40129846e-45	4.9406564584124654e-324	not applicable
Precision (decimal digits)	6 - 9	15 - 17	38 - 40

¹ These numbers are from the *IEEE Numerical Computation Guide*.

9.3.2.1 Binary Floating-Point Formats

This formula determines the value of a floating-point number that uses a binary format:

$$(-1)^{\text{sign}} 2^E (\text{bit}_0 \text{ bit}_1 \text{ bit}_2 \dots \text{bit}_{p-1})$$

Table 9-3 (page 9-9) describes the components of the preceding formula.

Table 9-3 Binary Floating-Point Format Components

Component	Component Value
sign	0 or 1
E (exponent)	For single-precision (32-bit) data type, an integer from -126 through 127. For double-precision (64-bit) data type, an integer from -1022 through 1023.
bit _i	0 or 1. (The bit sequence represents a number in base 2.)
p (precision)	For single-precision data type, 24. For double-precision data type, 53.

The leading bit of the significand, b_0 , must be set (1), except for subnormal numbers (explained later). Therefore, the leading bit is not stored, and a binary format provides n bits of precision while storing only $n-1$ bits. The IEEE 754 standard defines the in-memory formats for single-precision and double-precision data types, as [Table 9-4](#) (page 9-10) shows.

Table 9-4 Summary of Binary Format Storage Parameters

Data Type	Sign Bit	Exponent Bits	Significand Bits	Total Bits
Single-precision	1	8	24 (23 stored)	32
Double-precision	1	11	53 (52 stored)	64

Note:

Oracle Database does not support the extended single- and double-precision formats that the IEEE 754 standard defines.

A significand whose leading bit is set is called **normalized**. The IEEE 754 standard defines **subnormal numbers** (also called **denormal numbers**) that are too small to represent with normalized significands. If the significand of a subnormal number were normalized, then its exponent would be too large. Subnormal numbers preserve this property: If $x-y=0.0$ (using floating-point subtraction), then $x==y$.

9.3.3 Representing Special Values with Native Floating-Point Data Types

The IEEE 754 standard supports the special values shown in [Table 9-5](#) (page 9-10).

Table 9-5 Special Values for Native Floating-Point Formats

Value	Meaning
+INF	Positive infinity
-INF	Negative infinity
+0	Positive zero
-0	Negative zero
NaN	Not a number

Each value in [Table 9-5](#) (page 9-10) is represented by a specific bit pattern, except NaN. NaN, the result of any undefined operation, is represented by many bit patterns. Some of these bits patterns have the sign bit set and some do not, but the sign bit has no meaning.

The IEEE 754 standard distinguishes between quiet NaNs (which do not raise additional exceptions as they propagate through most operations) and signaling NaNs (which do). The IEEE 754 standard specifies action for when exceptions are enabled and action for when they are disabled.

In Oracle Database, exceptions cannot be enabled. Oracle Database acts as the IEEE 754 standard specifies for when exceptions are disabled. In particular, Oracle Database

does not distinguish between quiet and signaling NaNs. You can use Oracle Call Interface (OCI) to retrieve NaN values from Oracle Database, but whether a retrieved NaN value is signaling or quiet depends on the client platform and is beyond the control of Oracle Database.

The IEEE 754 standard defines these classes of special values:

- Zero
- Subnormal
- Normal
- Infinity
- NaN

The values in each class in the preceding list are larger than the values in the classes that precede it in the list (ignoring signs), except NaN. NaN is unordered with other classes of special values and with itself.

In Oracle Database:

- All NaNs are quiet.
- Any non-NaN value < NaN
- Any NaN == any other NaN
- All NaNs are converted to the same bit pattern.
- -0 is converted to +0.
- IEEE 754 exceptions are not raised.

See Also:

Oracle Database SQL Language Reference for information about floating-point conditions, which let you determine whether an expression is infinite or is the undefined result of an operation (is not a number or NaN).

9.3.4 Comparing Native Floating-Point Values

When comparing numeric expressions, Oracle Database uses numeric precedence to determine whether the condition compares NUMBER, BINARY_FLOAT, or BINARY_DOUBLE values. For information about numeric precedence, see *Oracle Database SQL Language Reference*. For general information about comparing numeric expressions, see *Oracle Database SQL Language Reference*.

Comparisons ignore the sign of zero (-0 equals +0).

9.3.5 Arithmetic Operations with Native Floating-Point Data Types

IEEE 754 does not require floating-point arithmetic to be exactly reproducible. Therefore, results of operations can be delivered to a destination that uses a range greater than the range that the operands of the operation use.

You can compute the result of a double-precision multiplication at an extended double-precision destination, but the result must be rounded as if the destination were

single-precision or double-precision. The range of the result (that is, the number of bits used for the exponent) can use the range supported by the wider (extended double-precision) destination; however, this might cause a double-rounding error in which the least significant bit of the result is incorrect.

This situation can occur only for double-precision multiplication and division on hardware that implements the IA-32 and IA-64 instruction set architecture. Therefore, except for this case, arithmetic for these data types is reproducible across platforms. When the result of a computation is NaN, all platforms produce a value for which `IS_NAN` is true. However, all platforms do not have to use the same bit pattern.

See Also:

Oracle Database SQL Language Reference for general information about arithmetic operations

9.3.6 Conversion Functions for Native Floating-Point Data Types

Oracle Database defines functions that convert between floating-point and other data types, including string formats that use decimal precision (but precision might be lost during the conversion). For example:

- `TO_BINARY_DOUBLE`, described in *Oracle Database SQL Language Reference*
- `TO_BINARY_FLOAT`, described in *Oracle Database SQL Language Reference*
- `TO_CHAR`, described in *Oracle Database SQL Language Reference*
- `TO_NUMBER`, described in *Oracle Database SQL Language Reference*

Oracle Database can raise exceptions during conversion. The IEEE 754 standard defines these exceptions:

- Invalid
- Inexact
- Divide by zero
- Underflow
- Overflow

However, Oracle Database does not raise these exceptions for native floating-point data types. Generally, operations that raise exceptions produce the values described in [Table 9-6](#) (page 9-12).

Table 9-6 Values Resulting from Exceptions

Exception	Value
Underflow	0
Overflow	-INF, +INF
Invalid Operation	NaN
Divide by Zero	-INF, +INF, NaN

Table 9-6 (Cont.) Values Resulting from Exceptions

Exception	Value
Inexact	Any value – rounding was performed

9.3.7 Client Interfaces for Native Floating-Point Data Types

Oracle Database supports native floating-point data types in these client interfaces:

- SQL and PL/SQL
Support for `BINARY_FLOAT` and `BINARY_DOUBLE` includes their use as attributes of Abstract Data Types (ADTs), which you create with the SQL statement `CREATE TYPE` (fully described in *Oracle Database PL/SQL Language Reference*).
- Oracle Call Interface (OCI)
For information about using `BINARY_FLOAT` and `BINARY_DOUBLE` with OCI, see *Oracle Call Interface Programmer's Guide*.
- Oracle C++ Call Interface (OCCI)
For information about using `BINARY_FLOAT` with OCCI, see *Oracle C++ Call Interface Programmer's Guide*.
For information about using `BINARY_DOUBLE` with OCCI, see *Oracle C++ Call Interface Programmer's Guide*.
- Pro*C/C++ precompiler
To use `BINARY_FLOAT` and `BINARY_DOUBLE`, set the Pro*C/C++ precompiler command line option `NATIVE_TYPES` to `YES` when you compile your application. For information about the `NATIVE_TYPES` option, see *Pro*C/C++ Programmer's Guide*.
- Oracle JDBC
For information about using `BINARY_FLOAT` and `BINARY_DOUBLE` with Oracle JDBC, see *Oracle Database JDBC Developer's Guide*.

9.4 Representing Date and Time Data

Oracle Database stores `DATE` and `TIMESTAMP` (**datetime**) data in a binary format that represents the century, year, month, day, hour, minute, second, and optionally, fractional seconds and timezones.

[Table 9-7](#) (page 9-13) summarizes the SQL datetime data types. For more information about these data types, see *Oracle Database SQL Language Reference*.

Table 9-7 SQL Datetime Data Types

Date Type	Usage
<code>DATE</code>	For storing datetime values in a table—for example, dates of jobs.

Table 9-7 (Cont.) SQL Datetime Data Types

Date Type	Usage
TIMESTAMP	For storing datetime values that are precise to fractional seconds—for example, times of events that must be compared to determine the order in which they occurred.
TIMESTAMP WITH TIME ZONE	For storing datetime values that must be gathered or coordinated across geographic regions.
TIMESTAMP WITH LOCAL TIME ZONE	<p>For storing datetime values when the time zone is insignificant—for example, in an application that schedules teleconferences, where participants see the start and end times for their own time zone.</p> <p>Appropriate for two-tier applications in which you want to display dates and times that use the time zone of the client system. Usually inappropriate for three-tier applications, because data displayed in a web browser is formatted according to the time zone of the web server, not the time zone of the browser. The web server is the database client, so its local time is used.</p>
INTERVAL YEAR TO MONTH	For storing the difference between two datetime values, where only the year and month are significant—for example, to set a reminder for a date 18 months in the future, or check whether 6 months have elapsed since a particular date.
INTERVAL DAY TO SECOND	For storing the precise difference between two datetime values—for example, to set a reminder for a time 36 hours in the future or to record the time between the start and end of a race. To represent long spans of time with high precision, use a large number of days.

Topics:

- [Displaying Current Date and Time](#) (page 9-15)
- [Inserting and Displaying Dates](#) (page 9-16)
- [Inserting and Displaying Times](#) (page 9-17)
- [Arithmetic Operations with Datetime Data Types](#) (page 9-18)
- [Conversion Functions for Datetime Data Types](#) (page 9-18)
- [Importing_ Exporting_ and Comparing Datetime Types](#) (page 9-19)

See Also:

Oracle Call Interface Programmer's Guide for more information about Oracle Database internal date types

9.4.1 Displaying Current Date and Time

The simplest way to display the current date and time is:

```
SELECT TO_CHAR(SYSDATE, format_model) FROM DUAL
```

The default format model depends on the initialization parameter `NLS_DATE_FORMAT`.

The standard Oracle Database default date format is `DD-MON-RR`. The `RR` datetime format element lets you store 20th century dates in the 21st century by specifying only the last two digits of the year. For example, in the datetime format `DD-MON-YY`, `13-NOV-54` refers to the year 1954 in a query issued between 1950 and 2049, but to the year 2054 in a query issued between 2050 and 2149.

Note:

For program correctness and to avoid problems with SQL injection and dynamic SQL, Oracle recommends specifying a format model for every datetime value.

The simplest way to display the current date and time using a format model is:

```
SELECT TO_CHAR(SYSDATE, format_model) FROM DUAL
```

[Example 9-2](#) (page 9-15) uses `TO_CHAR` with a format model to display `SYSDATE` in a format with the qualifier `BC` or `AD`. (By default, `SYSDATE` is displayed without this qualifier.)

Example 9-2 *Displaying Current Date and Time*

```
SELECT TO_CHAR(SYSDATE, 'DD-MON-YYYY BC') NOW FROM DUAL;
```

Result:

```
NOW
-----
18-MAR-2009 AD

1 row selected.
```

Tip:

When testing code that uses `SYSDATE`, it can be helpful to set `SYSDATE` to a constant. Do this with the initialization parameter `FIXED_DATE`, described in *Oracle Database Reference*.

See Also:

- *Oracle Database SQL Language Reference* for more information about SYSDATE
 - *Oracle Database Globalization Support Guide* for information about NLS_DATE_FORMAT
 - *Oracle Database SQL Language Reference* for more information about TO_CHAR
 - *Oracle Database SQL Language Reference* for information about datetime format models
 - *Oracle Database SQL Language Reference* for more information about the RR datetime format element
-

9.4.2 Inserting and Displaying Dates

When you display and insert dates, Oracle recommends using the TO_CHAR and TO_DATE functions, respectively, with datetime format models.

[Example 9-3](#) (page 9-16) creates a table with a DATE column and inserts a date into it, specifying a format model. Then the example displays the date with and without specifying a format model.

Example 9-3 *Inserting and Displaying Dates*

Create table:

```
DROP TABLE dates;  
CREATE TABLE dates (d DATE);
```

Insert date specified into table, specifying a format model:

```
INSERT INTO dates VALUES (TO_DATE('OCT 27, 1998', 'MON DD, YYYY'));
```

Display date without specifying a format model:

```
SELECT d FROM dates;
```

Result:

```
D  
-----  
27-OCT-98
```

1 row selected.

Display date, specifying a format model:

```
SELECT TO_CHAR(d, 'YYYY-MON-DD') D FROM dates;
```

Result:

```
D  
-----  
1998-OCT-27
```

1 row selected.

Caution:

Be careful when using the YY datetime format element, which indicates the year in the current century. For example, in the 21st century, the format DD-MON-YY, 31-DEC-92 is December 31, 2092 (not December 31, 1992, as you might expect). To store 20th century dates in the 21st century by specifying only the last two digits of the year, use the RR datetime format element (the default).

See Also:

- *Oracle Database Globalization Support Guide* for information about NLS_DATE_FORMAT
 - *Oracle Database SQL Language Reference* for more information about TO_CHAR
 - *Oracle Database SQL Language Reference* for more information about TO_DATE
 - *Oracle Database SQL Language Reference* for information about datetime format models
 - *Oracle Database SQL Language Reference* for more information about the RR datetime format element
-
-

9.4.3 Inserting and Displaying Times

When you display and insert times, Oracle recommends using the TO_CHAR and TO_DATE functions, respectively, with datetime format models.

In a DATE column:

- The default time is 12:00:00 A.M. (midnight).
The default time applies to any value in the column that has no time portion, either because none was specified or because the value was truncated.
- The default day is the first day of the current month.
The default date applies to any value in the column that has no date portion, because none was specified.

[Example 9-4](#) (page 9-17) creates a table with a DATE column and inserts three dates into it, specifying a different format model for each date. The first format model has both date and time portions, the second has no time portion, and the third has no date portion. Then the example displays the three dates, specifying a format model that includes both date and time portions.

Example 9-4 Inserting and Displaying Dates and Times

Create table:

```
DROP TABLE birthdays;
CREATE TABLE birthdays (name VARCHAR2(20), day DATE);
```

Insert three dates, specifying a different format model for each date:

```
INSERT INTO birthdays (name, day)
VALUES ('Annie',
       TO_DATE('13-NOV-92 10:56 A.M.', 'DD-MON-RR HH:MI A.M. ')
       );

INSERT INTO birthdays (name, day)
VALUES ('Bobby',
       TO_DATE('5-APR-02', 'DD-MON-RR')
       );

INSERT INTO birthdays (name, day)
VALUES ('Cindy',
       TO_DATE('8:25 P.M.', 'HH:MI A.M. ')
       );
```

Display both date and time portions of stored datetime values:

```
SELECT name,
       TO_CHAR(day, 'Mon DD, RRRR') DAY,
       TO_CHAR(day, 'HH:MI A.M.') TIME
FROM birthdays;
```

Result:

NAME	DAY	TIME
-----	-----	-----
Annie	Nov 13, 1992	10:56 A.M.
Bobby	Apr 05, 2002	12:00 A.M.
Cindy	Nov 01, 2010	08:25 P.M.

3 rows selected.

9.4.4 Arithmetic Operations with Datetime Data Types

The results of arithmetic operations on datetime values are determined by the rules in *Oracle Database SQL Language Reference*.

SQL has many datetime functions that you can use in datetime expressions. For example, the function `ADD_MONTHS` returns the date that is a specified number of months from a specified date. For the complete list of datetime functions, see *Oracle Database SQL Language Reference*.

9.4.5 Conversion Functions for Datetime Data Types

[Table 9-8](#) (page 9-19) summarizes the SQL functions that convert to or from datetime data types. For more information about these functions, see *Oracle Database SQL Language Reference*.

Table 9-8 SQL Conversion Functions for Datetime Data Types

Function	Converts ...	To ...
NUMTODSINTERVAL	NUMBER	INTERVAL DAY TO SECOND
NUMTOYMINTERVAL	NUMBER	INTERVAL DAY TO MONTH
TO_CHAR	DATE TIMESTAMP TIMESTAMP WITH TIME ZONE TIMESTAMP WITH LOCAL TIME ZONE INTERVAL DAY TO SECOND INTERVAL YEAR TO MONTH	VARCHAR2
TO_DATE	CHAR VARCHAR2 NCHAR NVARCHAR2	DATE
TO_DSINTERVAL	CHAR VARCHAR2 NCHAR NVARCHAR2	INTERVAL DAY TO SECOND
TO_TIMESTAMP	CHAR VARCHAR2 NCHAR NVARCHAR2	TIMESTAMP
TO_TIMESTAMP_TZ	CHAR VARCHAR2 NCHAR NVARCHAR2	TIMESTAMP WITH TIME ZONE
TO_YMINTERVAL	CHAR VARCHAR2 NCHAR NVARCHAR2	INTERVAL DAY TO MONTH

9.4.6 Importing, Exporting, and Comparing Datetime Types

You can import, export, and compare `TIMESTAMP WITH TIME ZONE` and `TIMESTAMP WITH LOCAL TIME ZONE` values without worrying about time zone offsets, because the database stores these values in normalized format.

When importing, exporting, and comparing `DATE` and `TIMESTAMP` values, you must adjust them to account for any time zone differences between source and target databases, because the database does not store their time zones.

9.5 Representing Specialized Data

Topics:

- [Representing Spatial Data](#) (page 9-20)
- [Representing Multimedia Data](#) (page 9-20)
- [Representing Large Amounts of Data](#) (page 9-20)
- [Representing Searchable Text](#) (page 9-22)
- [Representing XML Data](#) (page 9-22)
- [Representing Dynamically Typed Data](#) (page 9-22)
- [Representing ANSI_DB2_ and SQL/DS Data](#) (page 9-24)

9.5.1 Representing Spatial Data

Spatial data is used by location-enabled applications, geographic information system (GIS) applications, and geoimaging applications. For information about representing spatial data in Oracle Database, see *Oracle Database SQL Language Reference*.

9.5.2 Representing Multimedia Data

Oracle Multimedia lets Oracle Database store, manage, and retrieve images, audio, video, or other heterogeneous media data. For information about representing multimedia data in Oracle Database, see *Oracle Database SQL Language Reference*.

9.5.3 Representing Large Amounts of Data

For representing large amounts of data, Oracle Database provides:

- [Large Objects \(LOBs\)](#) (page 9-20)
- [LONG and LONG RAW Data Types](#) (page 9-21) (for backward compatibility)

9.5.3.1 Large Objects (LOBs)

Large Objects (LOBs) are data types that are designed to store large amounts of data in a way that lets your application access and manipulate it efficiently.

[Table 9-9](#) (page 9-20) summarizes the LOBs. For more information about these functions, see *Oracle Database SQL Language Reference*.

Table 9-9 Large Objects (LOBs)

Data Type	Description
BLOB	Binary large object Stores any kind of data in binary format. Typically used for multimedia data such as images, audio, and video.

Table 9-9 (Cont.) Large Objects (LOBs)

Data Type	Description
CLOB	<p>Character large object</p> <p>Stores string data in the database character set format.</p> <p>Used for large strings or documents that use the database character set exclusively.</p>
NCLOB	<p>National character large object</p> <p>Stores string data in National Character Set format.</p> <p>Used for large strings or documents in the National Character Set.</p>
BFILE	<p>External large object</p> <p>Stores a binary file outside the database in the host operating system file system. Applications have read-only access to BFILES.</p> <p>Used for static data that applications do not manipulate, such as image data.</p> <p>Any kind of data (that is, any operating system file) can be stored in a BFILE. For example, you can store character data in a BFILE and then load the BFILE data into a CLOB, specifying the character set when loading.</p>

An instance of type BLOB, CLOB, or NCLOB can be either **temporary** (declared in the scope of your application) or **persistent** (created and stored in the database).

See Also:

Oracle Database SecureFiles and Large Objects Developer's Guide for information about using LOBs in application development

9.5.3.2 LONG and LONG RAW Data Types

Note:

Oracle supports the LONG and LONG RAW data types for backward compatibility, but strongly recommends that you convert LONG columns to LOB columns and LONG RAW columns to BLOB columns.

LONG columns store variable-length character strings containing up to 2 gigabytes - 1 bytes. For more information about the LONG data type, including its many restrictions, see *Oracle Database SQL Language Reference*.

The LONG RAW (and RAW) data types store data that is not to be explicitly converted by Oracle Database when moving data between different systems. These data types are intended for binary data or byte strings. For more information about the RAW and LONG RAW data types, see *Oracle Database SQL Language Reference*.

9.5.4 Representing Searchable Text

Rather than writing low-level code to do full-text searches, you can use Oracle Text. Oracle Text provides indexing, word and theme searching, and viewing capabilities for text in query applications and document classification applications. You can also use Oracle Text to search XML data.

See Also:

Oracle Text Application Developer's Guide for more information about Oracle Text

9.5.5 Representing XML Data

If you have information stored as files in XML format, or want to store an ADT in XML format, then you can use the Oracle-supplied type `XMLType`, described in *Oracle Database SQL Language Reference*.

With `XMLType` values, you can use:

- `XMLType` member functions (see *Oracle XML DB Developer's Guide*).
- SQL XML functions (see *Oracle Database SQL Language Reference*)
- PL/SQL `DBMS_XML` packages (see *Oracle Database PL/SQL Packages and Types Reference*)

See Also:

- *Oracle XML DB Developer's Guide* for information about Oracle XML DB and how you can use it to store, generate, manipulate, manage, and query XML data in the database
 - *Oracle XML Developer's Kit Programmer's Guide*
-
-

9.5.6 Representing Dynamically Typed Data

Some languages allow data types to change at runtime, and some let a program check the type of a variable. For example, C has the `union` keyword and the `void *` pointer, and Java has the `typeof` operator and wrapper types such as `Number`.

In Oracle Database, you can create variables and columns that can hold data of any type and test their values to determine their underlying representation. For example, a single table column can have a numeric value in one row, a string value in another row, and an object in another row.

You can use the Oracle-supplied ADT `SYS.ANYDATA` to represent values of any scalar type or ADT. `SYS.ANYDATA` has methods that accept scalar values of any type, and turn them back into scalars or objects. Similarly, you can use the Oracle-supplied ADT `SYS.ANYDATASET` to represent values of any collection type. For more information about these ADTs, see *Oracle Database Object-Relational Developer's Guide*.

To check and manipulate type information, use the `DBMS_TYPES` package (described in *Oracle Database PL/SQL Packages and Types Reference*), as in [Example 9-5](#) (page 9-23).

With OCI, use the `OCIAnyData` and `OCIAnyDataSet` interfaces, described in *Oracle Call Interface Programmer's Guide*.

Example 9-5 Accessing Information in a `SYS.ANYDATA` Column

```

CREATE OR REPLACE TYPE employee_type AS
  OBJECT (empno NUMBER, ename VARCHAR2(10));
/

DROP TABLE mytab;
CREATE TABLE mytab (id NUMBER, data SYS.ANYDATA);

INSERT INTO mytab (id, data)
VALUES (1, SYS.ANYDATA.ConvertNumber(5));

INSERT INTO mytab (id, data)
VALUES (2, SYS.ANYDATA.ConvertObject(Employee_type(5555, 'john')));

CREATE OR REPLACE PROCEDURE p IS
  CURSOR cur IS SELECT id, data FROM mytab;
  v_id          mytab.id%TYPE;
  v_data        mytab.data%TYPE;
  v_type        SYS.ANYTYPE;
  v_typecode    PLS_INTEGER;
  v_typename    VARCHAR2(60);
  v_dummy       PLS_INTEGER;
  v_n           NUMBER;
  v_employee    employee_type;
  non_null_anytype_for_NUMBER exception;
  unknown_typename    exception;
BEGIN
  FOR x IN cur LOOP
    FETCH cur INTO v_id, v_data;
    EXIT WHEN cur%NOTFOUND;

    /* typecode signifies type represented by v_data.
       GetType also produces a value of type SYS.ANYTYPE with methods you
       can call to find precision and scale of a number, length of a
       string, and so on. */

    v_typecode := v_data.GetType (v_type /* OUT */);

    /* Compare typecode to DBMS_TYPES constants to determine type of data
       and decide how to display it. */

    CASE v_typecode
      WHEN DBMS_TYPES.TYPECODE_NUMBER THEN
        IF v_type IS NOT NULL THEN -- This condition should never happen.
          RAISE non_null_anytype_for_NUMBER;
        END IF;

        -- For each type, there is a Get method.
        v_dummy := v_data.GetNUMBER (v_n /* OUT */);
        DBMS_OUTPUT.PUT_LINE
          (TO_CHAR(v_id) || ': NUMBER = ' || TO_CHAR(v_n) );

      WHEN DBMS_TYPES.TYPECODE_OBJECT THEN
        v_typename := v_data.GetTypeName();
        IF v_typename NOT IN ('HR.EMPLOYEE_TYPE') THEN
          RAISE unknown_typename;
        END IF;
        v_dummy := v_data.GetObject (v_employee /* OUT */);
    END CASE;
  END LOOP;
END;

```

```

        DBMS_OUTPUT.PUT_LINE
        (TO_CHAR(v_id) || ': user-defined type = ' || v_typename ||
        ' ( ' || v_employee.empno || ', ' || v_employee.ename || ' ) ');
    END CASE;
END LOOP;
EXCEPTION
    WHEN non_null_anytype_for_NUMBER THEN
        RAISE_Application_Error (-20000,
        'Paradox: the return AnyType instance FROM GetType ' ||
        'should be NULL for all but user-defined types');
    WHEN unknown_typename THEN
        RAISE_Application_Error( -20000, 'Unknown user-defined type ' ||
        v_typename || ' - program written to handle only HR.EMPLOYEE_TYPE');
END;
/

SELECT t.data.gettypename() AS "Type Name" FROM mytab t;

```

Result:

```

Type Name
-----
SYS.NUMBER
HR.EMPLOYEE_TYPE

2 rows selected.

```

9.5.7 Representing ANSI, DB2, and SQL/DS Data

SQL statements that create tables and clusters can use ANSI data types and data types from the IBM products SQL/DS and DB2 (except those noted after this paragraph). Oracle Database converts the ANSI or IBM data type to the equivalent Oracle data type, records the Oracle data type as the name of the column data type, and stores the column data in the Oracle data type. For conversion details, see *Oracle Database SQL Language Reference*.

Note:

SQL statements cannot use the SQL/DS and DB2 data types TIME, GRAPHIC, VARGRAPHIC, and LONG VARGRAPHIC, because they have no equivalent Oracle data types.

9.6 Identifying Rows by Address

The fastest way to access the row of a database table is by its address, or **rowid**, which uniquely identifies it. Different rows in the same data block can have the same rowid only if they are in different clustered tables. If a row is larger than one data block, then its rowid identifies its initial row piece.

To see rowids, query the ROWID pseudocolumn. Each value in the ROWID pseudocolumn is a string that represents the address of a row. The data type of the string is either ROWID or UROWID.

See Also:

- *Oracle Database Concepts* for an overview of the ROWID pseudocolumn
 - *Oracle Database Concepts* for an overview of rowid data types
 - *Oracle Database SQL Language Reference* for more information about the ROWID pseudocolumn
 - *Oracle Database SQL Language Reference* for more information about the ROWID data type
 - *Oracle Database SQL Language Reference* for more information about the UROWID data type
 - *Oracle Call Interface Programmer's Guide* for information about using the ROWID data type in C
 - *Pro*C/C++ Programmer's Guide* for information about using the ROWID data type with the Pro*C/C++ precompiler
 - *Oracle Database JDBC Developer's Guide* for information about using the ROWID data type in Java
-
-

Note:

When you update a row in a table compressed with Hybrid Columnar Compression (HCC), the ROWID of the row changes. HCC, a feature of certain Oracle storage systems, is described in *Oracle Database Concepts*.

[Example 9-6](#) (page 9-25) creates a table with a column of the data type ROWID, populates it with rowids by querying the ROWID pseudocolumn inside an INSERT statement, and then displays it. The rowids of the table rows show how they are stored.

Note:

Merely creating a column of the type ROWID (like `col1` in [Example 9-6](#) (page 9-25)) does not guarantee that its values will be valid rowids.

Example 9-6 Querying the ROWID Pseudocolumn

```
DROP TABLE t_tab; -- in case it exists
CREATE TABLE t_tab (col1 ROWID);

INSERT INTO t_tab (col1)
SELECT ROWID
FROM employees
WHERE employee_id > 199;
```

Query:

```
SELECT employee_id, rowid
FROM employees
```

```
WHERE employee_id > 199;
```

ROWID varies, but result is similar to:

```
EMPLOYEE_ID ROWID
-----
200 AAAPeSAAFAAAAABTAAC
201 AAAPeSAAFAAAAABTAAD
202 AAAPeSAAFAAAAABTAAE
203 AAAPeSAAFAAAAABTAAF
204 AAAPeSAAFAAAAABTAAG
205 AAAPeSAAFAAAAABTAAH
206 AAAPeSAAFAAAAABTAAI
```

7 rows selected.

Query:

```
SELECT * FROM t_tab;
```

COL1 varies, but result is similar to:

```
COL1
-----
AAAPeSAAFAAAAABTAAC
AAAPeSAAFAAAAABTAAD
AAAPeSAAFAAAAABTAAE
AAAPeSAAFAAAAABTAAF
AAAPeSAAFAAAAABTAAG
AAAPeSAAFAAAAABTAAH
AAAPeSAAFAAAAABTAAI
```

7 rows selected.

9.7 Displaying Metadata for SQL Operators and Functions

The dynamic performance view `V$SQLFN_METADATA` displays metadata about SQL operators and functions. For every function that `V$SQLFN_METADATA` displays, the dynamic performance view `V$SQLFN_ARG_METADATA` has one row of metadata about each function argument. If a function argument can be repeated (as in the functions `LEAST` and `GREATEST`), then `V$SQLFN_ARG_METADATA` has only one row for each repeating argument. You can join the views `V$SQLFN_METADATA` and `V$SQLFN_ARG_METADATA` on the column `FUNC_ID`.

These views let third-party tools leverage SQL functions without maintaining their metadata in the application layer.

Topics:

- [ARGn Data Type](#) (page 9-27)
- [DISP_TYPE Data Type](#) (page 9-27)
- [SQL Data Type Families](#) (page 9-27)

See Also:

- *Oracle Database Reference* for more information about V\$SQLFN_METADATA
 - *Oracle Database Reference* for more information about V\$SQLFN_ARG_METADATA
-
-

9.7.1 ARGn Data Type

In the view V\$SQLFN_METADATA, the column DATATYPE is the data type of the function (that is, the data type that the function returns). This data type can be an Oracle data type, data type family (see [SQL Data Type Families](#) (page 9-27)), or ARGn. ARGn is the data type of the nth argument of the function. For example:

- The MAX function (described in *Oracle Database SQL Language Reference*) returns a value that has the data type of its first argument, so the MAX function has return data type ARG1.
- The DECODE function (described in *Oracle Database SQL Language Reference*) returns a value that has the data type of its third argument, so the DECODE function has data type ARG3.

9.7.2 DISP_TYPE Data Type

In the view V\$SQLFN_METADATA, the column DISP_TYPE is the data type of an argument that can be any expression. An expression is either a single value or a combination of values and SQL functions that has a single value.

Table 9-10 Display Types of SQL Functions

Display Type	Description	Example
NORMAL	FUNC(A, B, . . .)	LEAST(A, B, C)
ARITHMETIC	A FUNC B)	A+B
PARENTHESIS	FUNC()	SYS_GUID()
RELOP	A FUNC B	A IN B
CASE_LIKE	CASE statement or DECODE decode	
NOPAREN	FUNC	SYSDATE

9.7.3 SQL Data Type Families

Often, a SQL function argument can have any data type in a data type family. [Table 9-11](#) (page 9-28) shows the SQL data type families and their member data types.

Table 9-11 SQL Data Type Families

Family	Data Types
STRING	<ul style="list-style-type: none"> • CHARACTER • VARCHAR2 • CLOB • NCHAR • NVARCHAR2 • NCLOB • LONG
NUMERIC	<ul style="list-style-type: none"> • NUMBER • BINARY_FLOAT • BINARY_DOUBLE
DATETYPE	<ul style="list-style-type: none"> • DATE • TIMESTAMP • TIMESTAMP WITH TIME ZONE • TIMESTAMP WITH LOCAL TIME ZONE • INTERVAL YEAR TO MONTH • INTERVAL DAY TO SECOND
BINARY	<ul style="list-style-type: none"> • BLOB • RAW • LONG RAW

Using Regular Expressions in Database Applications

This chapter describes regular expressions and explains how to use them in database applications.

Topics:

- [Overview of Regular Expressions](#) (page 10-1)
- [Oracle SQL Support for Regular Expressions](#) (page 10-2)
- [Oracle SQL and POSIX Regular Expression Standard](#) (page 10-4)
- [Operators in Oracle SQL Regular Expressions](#) (page 10-5)
- [Using Regular Expressions in SQL Statements: Scenarios](#) (page 10-11)

See Also:

- *Oracle Database Globalization Support Guide* for information about using SQL regular expression functions in a multilingual environment
 - *Oracle Regular Expressions Pocket Reference* by Jonathan Gennick, O'Reilly & Associates
 - *Mastering Regular Expressions* by Jeffrey E. F. Friedl, O'Reilly & Associates
-

10.1 Overview of Regular Expressions

A regular expression specifies a search pattern, using **metacharacters** (which are, or belong to, **operators**) and **character literals** (described in *Oracle Database SQL Language Reference*).

The search pattern can be complex. For example, this regular expression matches any string that begins with either `f` or `ht`, followed by `tp`, optionally followed by `s`, followed by the colon (`:`):

```
(f|ht)tps?:
```

The metacharacters (which are also operators) in the preceding example are the parentheses, the pipe symbol (`|`), and the question mark (`?`). The character literals are `f`, `ht`, `tp`, `s`, and the colon (`:`).

Parentheses group multiple pattern elements into a single element. The pipe symbol (`|`) indicates a choice between the elements on either side of it, `f` and `ht`. The question

mark (?) indicates that the preceding element, *s*, is optional. Thus, the preceding regular expression matches these strings:

- http:
- https:
- ftp:
- ftps:

Regular expressions are a powerful text-processing component of the programming languages Java and PERL. For example, a PERL script can read the contents of each HTML file in a directory into a single string variable and then use a regular expression to search that string for URLs. This robust pattern-matching functionality is one reason that many application developers use PERL.

10.2 Oracle SQL Support for Regular Expressions

Oracle SQL support for regular expressions lets application developers implement complex pattern-matching logic in the database, which is useful for these reasons:

- By centralizing pattern-matching logic in the database, you avoid intensive string processing of SQL results sets by middle-tier applications.

For example, life science customers often rely on PERL to do pattern analysis on bioinformatics data stored in huge databases of DNA and proteins. Previously, finding a match for a protein sequence such as `[AG].{4}GK[ST]` was handled in the middle tier. The SQL regular expression functions move the processing logic closer to the data, thereby providing a more efficient solution.

- By using server-side regular expressions to enforce constraints, you avoid duplicating validation logic on multiple clients.

Oracle SQL supports regular expressions with the pattern-matching condition and functions summarized in [Table 10-1](#) (page 10-2). Each pattern matcher searches a given string for a given pattern (described with a regular expression), and each has the pattern-matching options described in [Table 10-2](#) (page 10-3). The functions have additional options (for example, the character position at which to start searching the string for the pattern). For details, see *Oracle Database SQL Language Reference*.

Table 10-1 Oracle SQL Pattern-Matching Condition and Functions

Name	Description
REGEXP_LIKE	<p>Condition that can appear in the WHERE clause of a query, causing the query to return rows that match the given pattern.</p> <p>Example: This WHERE clause identifies employees with the first name of Steven or Stephen:</p> <pre>WHERE REGEXP_LIKE(hr.employees.first_name, '^Ste(v ph)en\$')</pre>

Table 10-1 (Cont.) Oracle SQL Pattern-Matching Condition and Functions

Name	Description
REGEXP_COUNT	<p>Function that returns the number of times the given pattern appears in the given string.</p> <p>Example: This function invocation returns the number of times that e (but not E) appears in the string 'Albert Einstein', starting at character position 7:</p> <pre>REGEXP_COUNT('Albert Einstein', 'e', 7, 'c')</pre> <p>(The returned value is 1, because the c option specifies case-sensitive matching.)</p>
REGEXP_INSTR	<p>Function that returns an integer that indicates the starting position of the given pattern in the given string. Alternatively, the integer can indicate the position immediately following the end of the pattern.</p> <p>Example: This function invocation returns the starting position of the first valid email address in the column hr.employees.email:</p> <pre>REGEXP_INSTR(hr.employees.email, '\w+@\w+(\.\w+)+')</pre> <p>If the returned value is greater than zero, then the column contains a valid email address.</p>
REGEXP_REPLACE	<p>Function that returns the string that results from replacing occurrences of the given pattern in the given string with a replacement string.</p> <p>Example: This function invocation puts a space after each character in the column hr.countries.country_name:</p> <pre>REGEXP_REPLACE(hr.countries.country_name, '(.)', '\1 ')</pre>
REGEXP_SUBSTR	<p>Function that is like REGEXP_INSTR except that instead of returning the starting position of the given pattern in the given string, it returns the matching substring itself.</p> <p>Example: This function invocation returns 'Oracle' because the x option ignores the spaces in the pattern:</p> <pre>REGEXP_SUBSTR('Oracle 2010', 'O r a c l e', 1, 1, 'x')</pre>

Table 10-2 (page 10-3) describes the pattern-matching options that are available to each pattern matcher in Table 10-1 (page 10-2).

Table 10-2 Oracle SQL Pattern-Matching Options for Condition and Functions

Pattern-Matching Option	Description	Example
i	Specifies case-insensitive matching.	<p>This function invocation returns 3:</p> <pre>REGEXP_COUNT('Albert Einstein', 'e', 'i')</pre>

Table 10-2 (Cont.) Oracle SQL Pattern-Matching Options for Condition and Functions

Pattern-Matching Option	Description	Example
c	Specifies case-sensitive matching.	This function invocation returns 2: REGEXP_COUNT('Albert Einstein', 'e', 'c')
n	Allows the Dot operator (.) to match the newline character, which is not the default (see Table 10-3 (page 10-5)).	In this function invocation, the string and search pattern match only because the n option is specified: REGEXP_SUBSTR('a' CHR(10) 'd', 'a.d', 1, 1, 'n')
m	Specifies multiline mode , where a newline character inside a string terminates a line. The string can contain multiple lines. Multiline mode affects POSIX operators Beginning-of-Line Anchor (^) and End-of-Line Anchor (\$) (described in Table 10-3 (page 10-5)) but not PERL-influenced operators \A, \Z, and \z (described in Table 10-5 (page 10-10)).	This function invocation returns ac: REGEXP_SUBSTR('ab' CHR(10) 'ac', '^a.', 1, 2, 'm')
x	Ignores whitespace characters in the search pattern. By default, whitespace characters match themselves.	This function invocation returns abcd: REGEXP_SUBSTR('abcd', 'a b c d', 1, 1, 'x')

10.3 Oracle SQL and POSIX Regular Expression Standard

Oracle SQL implementation of regular expressions conforms to these standards:

- IEEE Portable Operating System Interface (POSIX) standard draft 1003.2/D11.2

Oracle SQL follows exactly the syntax and matching semantics for regular expression operators as defined in the POSIX standard for matching ASCII (English language) data. You can find the POSIX standard draft at this URL:

<http://pubs.opengroup.org/onlinepubs/007908799/xbd/re.html>

For more information, see "POSIX Operators in Oracle SQL Regular Expressions (page 10-5)".

- Unicode Regular Expression Guidelines of the Unicode Consortium

Oracle SQL extends regular expression support beyond the POSIX standard in these ways:

- Extends the matching capabilities for multilingual data

For details, see [Oracle SQL Multilingual Extensions to POSIX Standard](#) (page 10-8).

- Supports some commonly used PERL regular expression operators that are not included in the POSIX standard but do not conflict with it (for example, character class shortcuts and the nongreedy modifier (?))

For details, see [Oracle SQL PERL-Influenced Extensions to POSIX Standard](#) (page 10-9).

10.4 Operators in Oracle SQL Regular Expressions

Oracle SQL supports a set of common operators (composed of metacharacters) used in regular expressions.

Caution:

The interpretation of metacharacters differs between tools that support regular expressions. If you are porting regular expressions from another environment to Oracle Database, ensure that Oracle SQL supports their syntax and interprets them as you expect.

Topics:

- [POSIX Operators in Oracle SQL Regular Expressions](#) (page 10-5)
- [Oracle SQL Multilingual Extensions to POSIX Standard](#) (page 10-8)
- [Oracle SQL PERL-Influenced Extensions to POSIX Standard](#) (page 10-9)

10.4.1 POSIX Operators in Oracle SQL Regular Expressions

[Table 10-3](#) (page 10-5) summarizes the POSIX operators defined in the POSIX standard Extended Regular Expression (ERE) syntax. Oracle SQL follows the exact syntax and matching semantics for these operators as defined in the POSIX standard for matching ASCII (English language) data. Any differences in action between Oracle SQL and the POSIX standard are noted in the Description column.

Table 10-3 *POSIX Operators in Oracle SQL Regular Expressions*

Operator Syntax	Names	Description	Examples
.	Any Character Dot	Matches any character in the database character set, including the newline character if you specify matching option n (see Table 10-2 (page 10-3)). The Linux, UNIX, and Windows platforms recognize the newline character as the linefeed character (\x0a). The Macintosh platforms recognize the newline character as the carriage return character (\x0d). Note: In the POSIX standard, this operator matches any English character except NULL and the newline character.	The expression a.b matches the strings abb , acb , and adb , but does not match acc .

Table 10-3 (Cont.) POSIX Operators in Oracle SQL Regular Expressions

Operator Syntax	Names	Description	Examples
+	One or More Plus Quantifier	Matches one or more occurrences of the preceding subexpression (greedy ¹).	The expression a+ matches the strings a, aa, and aaa, but does not match ba or ab.
*	Zero or More Star Quantifier	Matches zero or more occurrences of the preceding subexpression (greedy ¹).	The expression ab*c matches the strings ac, abc, and abbc, but does not match abb or bbc.
?	Zero or One Question Mark Quantifier	Matches zero or one occurrences of the preceding subexpression (greedy ¹).	The expression ab?c matches the strings abc and ac, but does not match abbc or adc.
{ <i>m</i> }	Interval Exact Count	Matches exactly <i>m</i> occurrences of the preceding subexpression.	The expression a{3} matches the string aaa, but does not match aa.
{ <i>m</i> , }	Interval At-Least Count	Matches at least <i>m</i> occurrences of the preceding subexpression (greedy ¹).	The expression a{3,} matches the strings aaa and aaaa, but does not match aa.
{ <i>m</i> , <i>n</i> }	Interval Between Count	Matches at least <i>m</i> but not more than <i>n</i> occurrences of the preceding subexpression (greedy ¹).	The expression a{3,5} matches the strings aaa, aaaa, and aaaaa, but does not match aa or aaaaaa.
[<i>char</i> ...]	Matching Character List	Matches any single character in the list within the brackets. In the list, all operators except these are treated as literals: <ul style="list-style-type: none"> • Range operator: - • POSIX character class: [: :] • POSIX collation element: [. .] • POSIX character equivalence class: [= =] <p>A dash (-) is a literal when it occurs first or last in the list, or as an ending range point in a range expression, as in [#--]. A right bracket (]) is treated as a literal if it occurs first in the list.</p> <p>Note: In the POSIX standard, a range includes all collation elements between the start and end of the range in the linguistic definition of the current locale. Thus, ranges are linguistic rather than byte value ranges; the semantics of the range expression are independent of the character set. In Oracle Database, the linguistic range is determined by the NLS_SORT initialization parameter.</p>	The expression [abc] matches the first character in the strings all, bill, and cold, but does not match any characters in doll.

Table 10-3 (Cont.) POSIX Operators in Oracle SQL Regular Expressions

Operator Syntax	Names	Description	Examples
[<i>^char...</i>]	Nonmatching Character List	Matches any single character <i>not</i> in the list within the brackets. For information about operators and ranges in the character list, see the description of the Matching Character List operator.	The expression [^abc]def matches the string xdef, but not adef, bdef, or cdef. The expression [^a-i]x matches the string jx, but does not match ax, fx, or ix.
[<i>alt1 alt2</i>]	Or	Matches either alternative.	The expression a b matches the character a or b.
(<i>expr</i>)	Subexpression Grouping	Treats the expression within the parentheses as a unit. The expression can be a string or a complex expression containing operators. You can refer to a subexpression in a back reference.	The expression (abc)?def matches the strings abcdef and def, but does not match abcdefg or xdef.
\ <i>n</i>	Back Reference	Matches the <i>n</i> th preceding subexpression, where <i>n</i> is an integer from 1 through 9. A back reference counts subexpressions from left to right, starting with the opening parenthesis of each preceding subexpression. The expression is invalid if fewer than <i>n</i> subexpressions precede \ <i>n</i> . A back reference lets you search for a repeated string without knowing what it is. For the REGEXP_REPLACE function, Oracle SQL supports back references in both the regular expression pattern and the replacement string.	The expression (abc def)xy \1 matches the strings abcxyabc and defxydef, but does not match abcxydef or abcxy. The expression ^(.*)\1\$ matches a line consisting of two adjacent instances of the same string.
\	Escape Character	Treats the subsequent character as a literal. A backslash (\) lets you search for a character that would otherwise be treated as a metacharacter. Use consecutive backslashes (\\) to match the backslash literal itself.	The expression abc\+def matches the string abc+def, but does not match abcdef or abccdef.
^	Beginning-of-Line Anchor	Default mode: Matches the beginning of a string. Multiline mode: ² Matches the beginning of any line the source string.	The expression ^def matches the substring def in the string defghi but not in the string abcdef.
\$	End-of-Line Anchor	Default mode: Matches the end of a string. Multiline mode: ² Matches the end of any line the source string.	The expression def\$ matches the substring def in the string abcdef but not in the string defghi.

Table 10-3 (Cont.) POSIX Operators in Oracle SQL Regular Expressions

Operator Syntax	Names	Description	Examples
[:class:]	POSIX Character Class	Matches any character in the specified POSIX character class (such as uppercase characters, digits, or punctuation characters). Note: In English regular expressions, range expressions often indicate a character class. For example, [a-z] indicates any lowercase character. This convention is not useful in multilingual environments, where the first and last character of a given character class might not be the same in all languages.	The expression [:upper:]+, which specifies one or more consecutive uppercase characters, matches the substring DEF in the string abcDEFghi, but does not match any substring in abcdefghi.
[.element.]	POSIX Collating Element Operator	Specifies a collating element defined in the current locale. The NLS_SORT initialization parameter determines the supported collation elements. This syntax lets you use a multicharacter collating element where otherwise only single-character collating elements are allowed. For example, you can ensure that the collating element ch, when defined in a locale such as Traditional Spanish, is treated as one character in operations that depend on the ordering of characters.	The expression [.ch.], which specifies the collating element ch, matches ch in the string chabc, but does not match any substring in cdefg. The expression [a-[.ch.]] specifies the range from a through ch.
[=char=]	POSIX Character Equivalence Class	Matches all characters that belong to the same POSIX character equivalence class as the specified character, in the current locale. This syntax must appear within a character list; that is, it must be nested within the brackets for a character list. Character equivalents depend on how canonical rules are defined for your database locale. For details, see <i>Oracle Database Globalization Support Guide</i> .	The expression [[=n=]], which specifies characters equivalent to n in a Spanish locale, matches both N and ñ in the string El Niño.

¹ A **greedy** operator matches as many occurrences as possible while allowing the rest of the match to succeed. To make the operator nongreedy, follow it with the nongreedy modifier (?) (see [Table 10-5](#) (page 10-10)).

² Specify multiline mode with the pattern-matching option m, described in [Table 10-2](#) (page 10-3).

10.4.2 Oracle SQL Multilingual Extensions to POSIX Standard

When applied to multilingual data, Oracle SQL POSIX operators extend beyond the matching capabilities specified in the POSIX standard.

[Table 10-4](#) (page 10-9) shows, for each POSIX operator, which POSIX standards define its syntax and whether Oracle SQL extends its semantics for handling multilingual data. The POSIX standards are Basic Regular Expression (BRE) and Extended Regular Expression (ERE).

Table 10-4 *POSIX Operators and Multilingual Operator Relationships*

Operator	POSIX BRE Syntax	POSIX ERE Syntax	Multilingual Enhancement
\	Yes	Yes	--
*	Yes	Yes	--
+	--	Yes	--
?	--	Yes	--
	--	Yes	--
^	Yes	Yes	Yes
\$	Yes	Yes	Yes
.	Yes	Yes	Yes
[]	Yes	Yes	Yes
()	Yes	Yes	--
{m}	Yes	Yes	--
{m, }	Yes	Yes	--
{m, n}	Yes	Yes	--
\n	Yes	Yes	Yes
[. .]	Yes	Yes	Yes
[: :]	Yes	Yes	Yes
[= =]	Yes	Yes	Yes

Multilingual data might have multibyte characters. Oracle Database lets you enter multibyte characters directly (if you have a direct input method) or use functions to compose them. You cannot use the Unicode hexadecimal encoding value of the form \xxxx. Oracle Database evaluates the characters based on the byte values used to encode the character, not the graphical representation of the character.

10.4.3 Oracle SQL PERL-Influenced Extensions to POSIX Standard

Oracle SQL supports some commonly used PERL regular expression operators that are not included in the POSIX standard but do not conflict with it.

[Table 10-5](#) (page 10-10) summarizes the PERL-influenced operators that Oracle SQL supports.

Caution:

PERL character class matching is based on the locale model of the operating system, whereas Oracle SQL regular expressions are based on the language-specific data of the database. In general, you cannot expect a regular expression involving locale data to produce the same results in PERL and Oracle SQL.

Table 10-5 PERL-Influenced Operators in Oracle SQL Regular Expressions

Operator Syntax	Description	Examples
\d	Matches a digit character. Equivalent to POSIX expression <code>[[:digit:]]</code> .	The expression <code>^\(\d{3}\)\ \d{3}-\d{4}\$</code> matches <code>(650) 555-0100</code> but does not match <code>650-555-0100</code> .
\D	Matches a nondigit character. Equivalent to POSIX expression <code>[^[:digit:]]</code> .	The expression <code>\w\d\D</code> matches <code>b2b</code> and <code>b2_</code> but does not match <code>b22</code> .
\w	Matches a word character (that is, an alphanumeric or underscore (<code>_</code>) character). Equivalent to POSIX expression <code>[[:alnum:]_]</code> .	The expression <code>\w+@\w+(\.\w+)+</code> matches the string <code>jdoe@company.co.uk</code> but does not match <code>jdoe@company</code> .
\W	Matches a nonword character. Equivalent to POSIX expression <code>[^[:alnum:]_]</code> .	The expression <code>\w+\W\s\w+</code> matches the string <code>to:bill</code> but does not match <code>to bill</code> .
\s	Matches a whitespace character. Equivalent to POSIX expression <code>[[:space:]]</code> .	The expression <code>\(\w\s\w\s\)</code> matches the string <code>(a b)</code> but does not match <code>(ab)</code> or <code>(a,b.)</code> .
\S	Matches a nonwhitespace character. Equivalent to POSIX expression <code>[^[:space:]]</code> .	The expression <code>\(\w\S\w\S\)</code> matches the strings <code>(abde)</code> and <code>(a,b.)</code> but does not match <code>(a b d e)</code> .
\A	Matches the beginning of a string, in either single-line or multiline mode. Not equivalent to POSIX operator <code>^</code> .	The expression <code>\AL</code> matches only the first <code>L</code> in the string <code>Line1\nLine2\n</code> (where <code>\n</code> is the newline character), in either single-line or multiline mode.
\Z	Matches the end of a string, in either single-line or multiline mode. Not equivalent to POSIX operator <code>\$</code> .	The expression <code>\s\Z</code> matches the last space in the string <code>L i n e \n</code> (where <code>\n</code> is the newline character), in either single-line or multiline mode.
\z	Matches the end of a string, in either single-line or multiline mode. Not equivalent to POSIX operator <code>\$</code> .	The expression <code>\s\z</code> matches the newline character (<code>\n</code>) in the string <code>L i n e \n</code> , in either single-line or multiline mode.
+?	Matches one or more occurrences of the preceding subexpression (nongreedy ¹).	The expression <code>\w+?x\w</code> matches <code>abxc</code> in the string <code>abxcxd</code> (and the greedy expression <code>\w+x\w</code> matches <code>abxcxd</code>).

Table 10-5 (Cont.) PERL-Influenced Operators in Oracle SQL Regular Expressions

Operator Syntax	Description	Examples
?	Matches zero or more occurrences of the preceding subexpression (nongreedy ¹). Matches the empty string whenever possible.	The expression <code>\w?x\w</code> matches <code>xa</code> in the string <code>xaxbxc</code> (and the greedy expression <code>\w*x\w</code> matches <code>xaxbxc</code>).
??	Matches zero or one occurrences of the preceding subexpression (nongreedy ¹). Matches the empty string whenever possible.	The expression <code>a??aa</code> matches <code>aa</code> in the string <code>aaaa</code> (and the greedy expression <code>a?aa</code> matches <code>aaa</code>).
{m}?	Matches exactly <code>m</code> occurrences of the preceding subexpression (nongreedy ¹).	The expression <code>(a aa){2}?</code> matches <code>aa</code> in the string <code>aaaa</code> (and the greedy expression <code>(a aa){2}</code> matches <code>aaaa</code>). Both the expression <code>b{2}?</code> and the greedy expression <code>b{2}</code> match <code>bb</code> in the string <code>bbbb</code> .
{m, }?	Matches at least <code>m</code> occurrences of the preceding subexpression (nongreedy ¹).	The expression <code>a{2, }?</code> matches <code>aa</code> in the string <code>aaaaa</code> (and the greedy expression <code>a{2, }</code> matches <code>aaaaa</code>).
{m, n}?	Matches at least <code>m</code> but not more than <code>n</code> occurrences of the preceding subexpression (nongreedy ¹). <code>{0, n}?</code> matches the empty string whenever possible.	The expression <code>a{2, 4}?</code> matches <code>aa</code> in the string <code>aaaaa</code> (and the greedy expression <code>a{2, 4}</code> matches <code>aaaa</code>).

¹ A **nongreedy** operator matches as few occurrences as possible while allowing the rest of the match to succeed. To make the operator greedy, omit the nongreedy modifier (?).

10.5 Using Regular Expressions in SQL Statements: Scenarios

Scenarios:

- [Using a Constraint to Enforce a Phone Number Format](#) (page 10-11)
- [Example: Enforcing a Phone Number Format with Regular Expressions](#) (page 10-12)
- [Example: Inserting Phone Numbers in Correct and Incorrect Formats](#) (page 10-12)
- [Using Back References to Reposition Characters](#) (page 10-13)

10.5.1 Using a Constraint to Enforce a Phone Number Format

Regular expressions are useful for enforcing constraints—for example, to ensure that phone numbers are entered into the database in a standard format.

[Table 10-6](#) (page 10-12) explains the elements of the regular expression in [Example: Enforcing a Phone Number Format with Regular Expressions](#) (page 10-12).

Table 10-6 Explanation of the Regular Expression Elements

Regular Expression Element	Matches . . .
<code>^</code>	The beginning of the string.
<code>\(</code>	A left parenthesis. The backslash (<code>\</code>) is an escape character that indicates that the left parenthesis after it is a literal rather than a subexpression delimiter.
<code>\d{3}</code>	Exactly three digits.
<code>\)</code>	A right parenthesis. The backslash (<code>\</code>) is an escape character that indicates that the right parenthesis after it is a literal rather than a subexpression delimiter.
space character	A space character.
<code>\d{3}</code>	Exactly three digits.
<code>-</code>	A hyphen.
<code>\d{4}</code>	Exactly four digits.
<code>\$</code>	The end of the string.

10.5.2 Example: Enforcing a Phone Number Format with Regular Expressions

When you create a table, you can enforce formats with regular expressions.

[Example 10-1](#) (page 10-12) creates a `contacts` table and adds a `CHECK` constraint to the `p_number` column to enforce this format model:

```
(XXX) XXX-XXXX
```

Example 10-1 Enforcing a Phone Number Format with Regular Expressions

```
DROP TABLE contacts;
CREATE TABLE contacts (
  l_name   VARCHAR2(30),
  p_number VARCHAR2(30)
  CONSTRAINT c_contacts_pnf
  CHECK (REGEXP_LIKE (p_number, '^(\d{3}\) \d{3}-\d{4}$'))
);
```

10.5.3 Example: Inserting Phone Numbers in Correct and Incorrect Formats

The `INSERT INTO SQL` statement can be used to test how correct and incorrect formats work.

[Example 10-2](#) (page 10-12) shows some statements that correctly and incorrectly insert phone numbers into the `contacts` table.

Example 10-2 Inserting Phone Numbers in Correct and Incorrect Formats

These are correct:

```
INSERT INTO contacts (p_number) VALUES('(650) 555-0100');
INSERT INTO contacts (p_number) VALUES('(215) 555-0100');
```

These generate CHECK constraint errors:

```
INSERT INTO contacts (p_number) VALUES('650 555-0100');
INSERT INTO contacts (p_number) VALUES('650 555 0100');
INSERT INTO contacts (p_number) VALUES('650-555-0100');
INSERT INTO contacts (p_number) VALUES('(650)555-0100');
INSERT INTO contacts (p_number) VALUES(' (650) 555-0100');
```

10.5.4 Using Back References to Reposition Characters

A back reference (described in [Table 10-3](#) (page 10-5)) stores the referenced subexpression in a temporary buffer. Therefore, you can use back references to reposition characters, as in [Example 10-3](#) (page 10-13). For an explanation of the elements of the regular expression in [Example 10-3](#) (page 10-13), see [Table 10-7](#) (page 10-13).

[Table 10-7](#) (page 10-13) explains the elements of the regular expression in [Example 10-3](#) (page 10-13).

Table 10-7 Explanation of the Regular Expression Elements

Regular Expression Element	Description
^	Matches the beginning of the string.
\$	Matches the end of the string.
(\S+)	Matches one or more nonspace characters. The parentheses are not escaped so they function as a grouping expression.
\s	Matches a whitespace character.
\1	Substitutes the first subexpression, that is, the first group of parentheses in the matching pattern.
\2	Substitutes the second subexpression, that is, the second group of parentheses in the matching pattern.
\3	Substitutes the third subexpression, that is, the third group of parentheses in the matching pattern.
,	Inserts a comma character.

Example 10-3 Using Back References to Reposition Characters

Create table and populate it with names in different formats:

```
DROP TABLE famous_people;
CREATE TABLE famous_people (names VARCHAR2(20));
INSERT INTO famous_people (names) VALUES ('John Quincy Adams');
INSERT INTO famous_people (names) VALUES ('Harry S. Truman');
INSERT INTO famous_people (names) VALUES ('John Adams');
INSERT INTO famous_people (names) VALUES (' John Quincy Adams');
INSERT INTO famous_people (names) VALUES ('John_Quincy_Adams');
```

SQL*Plus formatting command:

```
COLUMN "names after regexp" FORMAT A20
```

For each name in the table whose format is "first middle last", use back references to reposition characters so that the format becomes "last, first middle":

```
SELECT names "names",  
       REGEXP_REPLACE(names, '^(\\S+)\\s(\\S+)\\s(\\S+)$', '\\3, \\1 \\2')  
       AS "names after regexp"  
FROM famous_people  
ORDER BY "names";
```

Result:

names	names after regexp
John Quincy Adams	John Quincy Adams
Harry S. Truman	Truman, Harry S.
John Adams	John Adams
John Quincy Adams	Adams, John Quincy
John_Quincy_Adams	John_Quincy_Adams

5 rows selected.

Using Indexes in Database Applications

Indexes are optional structures, associated with tables and clusters, which allow SQL queries to execute more quickly. Just as the index in this guide helps you locate information faster than if there were no index, an Oracle Database index provides a faster access path to table data. You can use indexes without rewriting any queries. Your results are the same, but you see them more quickly.

This chapter supplements this information:

- The explanation of indexes and index-organized tables in *Oracle Database Concepts*
- The information about managing indexes in *Oracle Database Administrator's Guide*
- The explanation of how indexes and clusters can enhance or degrade performance in *Oracle Database SQL Tuning Guide*

Topics:

- [Guidelines for Managing Indexes](#) (page 11-1)
- [Managing Indexes](#) (page 11-2)
- [When to Use Domain Indexes](#) (page 11-2)
- [When to Use Function-Based Indexes](#) (page 11-2)

11.1 Guidelines for Managing Indexes

Here is a summary of the guidelines for managing indexes. For details, see *Oracle Database Administrator's Guide*:

- Create indexes after inserting table data
- Index the correct tables and columns
- Order index columns for performance
- Limit the number of indexes for each table
- Drop indexes that are no longer needed
- Understand deferred segment creation
- Estimate index size and set storage parameters
- Specify the tablespace for each index
- Consider parallelizing index creation
- Consider creating indexes with `NOLOGGING`

- Understand when to use unusable or invisible indexes
- Consider costs and benefits of coalescing or rebuilding indexes
- Consider cost before disabling or dropping constraints

11.2 Managing Indexes

Oracle Database Administrator's Guide has this information about managing indexes:

- Creating indexes
- Altering indexes
- Monitoring space use of indexes
- Dropping indexes
- Data dictionary views that display information about indexes

See Also:

[Creating Indexes for Use with Constraints](#) (page 12-4)

11.3 When to Use Domain Indexes

A **domain index** (also called an **application domain index**) is a customized index specific to an application that was implemented using a data cartridge (for example, a search engine or geographic information system). For information about domain indexes, see *Oracle Database Concepts*.

See Also:

Oracle Database Data Cartridge Developer's Guide for conceptual background to help you decide when to build domain indexes

11.4 When to Use Function-Based Indexes

A **function-based index** computes the value of an expression that involves one or more columns and stores it in the index. The index expression can be an arithmetic expression or an expression that contains a SQL function, PL/SQL function, package function, or C callout. Function-based indexes also support linguistic sorts based on collation keys, efficient linguistic collation of SQL statements, and case-insensitive sorts.

A function-based index improves the performance of queries that use the index expression (especially if the expression is computationally intensive). However:

- The database must also evaluate the index expression to process statements that do not use it.
- Function-based indexes on columns that are frequently modified are expensive for the database to maintain.

The optimizer can use function-based indexes only for cost-based optimization, while it can use indexes on columns for both cost-based and rule-based optimization.

Note:

- A function-based index cannot contain the value `NULL`. Therefore, either ensure that no column involved in the index expression can contain `NULL` or use the `NVL` function in the index expression to substitute another value for `NULL`. (For information about `NVL`, see *Oracle Database SQL Language Reference*.)
 - Oracle Database treats descending indexes as if they were function-based indexes (for more information, see *Oracle Database SQL Language Reference*).
-
-

Topics:

- [Advantages of Function-Based Indexes](#) (page 11-3)
 - [Disadvantages of Function-Based Indexes](#) (page 11-4)
 - [Example: Function-Based Index for Precomputing Arithmetic Expression](#) (page 11-5)
 - [Example: Function-Based Indexes on Object Column](#) (page 11-6)
 - [Example: Function-Based Index for Faster Case-Insensitive Searches](#) (page 11-7)
 - [Example: Function-Based Index for Language-Dependent Sorting](#) (page 11-8)
-
-

See Also:

- *Oracle Database Concepts* for additional conceptual information about function-based indexes
 - *Oracle Database Administrator's Guide* for information about creating function-based indexes
 - *Oracle Database Globalization Support Guide* for information about function-based linguistic indexes
 - *Oracle Database Concepts* for more information about how the optimizer uses function-based indexes
 - *Oracle Database SQL Tuning Guide* for information about using function-based indexes for performance
-
-

11.4.1 Advantages of Function-Based Indexes

A function-based index has these advantages:

- A function-based index increases the number of situations where the database can perform an index range scan (described in *Oracle Database Concepts*) instead of a full index scan (described in *Oracle Database Concepts*).

An index range scan typically has a fast response time when the `WHERE` clause selects fewer than 15% of the rows of a large table. The optimizer can more accurately estimate how many rows an expression selects if the expression is materialized in a function-based index.

Oracle Database represents the index expression as a virtual column, on which the `ANALYZE` statement (described in *Oracle Database SQL Language Reference*) can build a histogram.

- A function-based index precomputes and stores the value of an expression.

Queries can get the value of the expression from the index instead of computing it. The more queries that need the value, and the more computationally intensive the index expression, the more the index improves application performance. (See [Example: Function-Based Index for Precomputing Arithmetic Expression](#) (page 11-5).)

- You can create a function-based index on an object column or `REF` column.

The index expression can be the invocation of a method that returns an object type. For more information, see *Oracle Database Object-Relational Developer's Guide*. (See [Example: Function-Based Indexes on Object Column](#) (page 11-6) and the example in *Oracle Database SQL Language Reference*.)

- A function-based index lets you perform more powerful sorts.

The index expression can invoke the SQL functions `UPPER` and `LOWER` for case-insensitive sorts (as in [Example 11-3](#) (page 11-7)) and the SQL function `NLSSORT` for linguistic-based sorts (as in [Example: Function-Based Index for Language-Dependent Sorting](#) (page 11-8)).

11.4.2 Disadvantages of Function-Based Indexes

A function-based index has these disadvantages:

- The optimizer can use a function-based index only for cost-based optimization, not for rule-based optimization.

The cost-based optimizer uses statistics stored in the dictionary. To gather statistics for a function-based index, invoke either `DBMS_STATS.GATHER_TABLE_STATS` (described in *Oracle Database PL/SQL Packages and Types Reference*) or `DBMS_STATS.GATHER_SCHEMA_STATS` (described in *Oracle Database PL/SQL Packages and Types Reference*).

- The database does not use a function-based index until you analyze the index itself and the table on which it is defined.

To analyze the index and the table on which the index is defined, invoke either `DBMS_STATS.GATHER_TABLE_STATS` or `DBMS_STATS.GATHER_SCHEMA_STATS`.

- The database does not use function-based indexes when doing `OR` expansion.
- You must ensure that any schema-level or package-level PL/SQL function that the index expression invokes is deterministic (that is, that the function always return the same result for the same input).

You must declare the function as `DETERMINISTIC`, but because Oracle Database does not check this assertion, you must ensure that the function really is deterministic.

If you change the semantics of a DETERMINISTIC function and recompile it, then you must manually rebuild any dependent function-based indexes and materialized views. Otherwise, they report results for the prior version of the function.

- If the index expression is a function invocation, then the function return type cannot be constrained.

Because you cannot constrain the function return type with NOT NULL, you must ensure that the query that uses the index cannot fetch NULL values. Otherwise, the database performs a full table scan.

- The index expression cannot invoke an aggregate function (described in *Oracle Database SQL Language Reference*).
- A bitmapped function-based index cannot be a descending index (see *Oracle Database SQL Language Reference*).
- The data type of the index expression cannot be VARCHAR2, RAW, LONGRAW, or a PL/SQL data type of unknown length.

That is, you cannot index an expression of unknown length. However, you can index a known-length substring of that expression. For example:

```
CREATE OR REPLACE FUNCTION initials (
    name IN VARCHAR2
) RETURN VARCHAR2
    DETERMINISTIC
IS
BEGIN
    RETURN('A. J. ');
END;
/

/* Invoke SUBSTR both when creating index and when referencing
   function in queries. */

CREATE INDEX func_substr_index ON
EMPLOYEES(SUBSTR(initials(FIRST_NAME),1,10));

SELECT SUBSTR(initials(FIRST_NAME),1,10) FROM EMPLOYEES;
```

See Also:

- *Oracle Database SQL Language Reference* for notes on function-based indexes
 - *Oracle Database SQL Language Reference* for restrictions on function-based indexes
 - *Oracle Database PL/SQL Language Reference* for information about the CREATE FUNCTION statement, including restrictions
-

11.4.3 Example: Function-Based Index for Precomputing Arithmetic Expression

You can create composite indexes to computer arithmetic expressions.

[Example 11-1](#) (page 11-6) creates a table with columns a, b, and c; creates an index on the table, and then queries the table. The index is a composite index on three

columns: a virtual column that represents the expression $a+b*(c-1)$, column a, and column b. The query uses the indexed expression in its WHERE clause; therefore, it can use an index range scan instead of a full index scan.

Example 11-1 Function-Based Index for Precomputing Arithmetic Expression

Create table on which to create index:

```
DROP TABLE Fbi_tab;
CREATE TABLE Fbi_tab (
  a INTEGER,
  b INTEGER,
  c INTEGER
);
```

Create index:

```
CREATE INDEX Idx ON Fbi_tab (a+b*(c-1), a, b);
```

This query can use an index range scan instead of a full index scan:

```
SELECT a FROM Fbi_tab WHERE a+b*(c-1) < 100;
```

See Also:

Oracle Database Concepts for information about fast full index scans

Note:

This example uses composite indexes (indexes on multiple table columns), described in *Oracle Database Concepts*.

11.4.4 Example: Function-Based Indexes on Object Column

In [Example 11-2](#) (page 11-6), assume that the object type `Reg_obj` has been defined, and that it stores information about a city. The example creates a table whose first column has type `Reg_obj`, a deterministic function with a parameter of type `Reg_obj`, and two function-based indexes that invoke the function. The first query uses the first index to quickly find cities further than 1000 miles from the equator. The second query uses the second index (which is composite) to quickly find cities where the temperature delta is less than 20 and the maximum temperature is greater than 75. (The table is not populated for the example, so the queries return no rows.)

Example 11-2 Function-Based Indexes on Object Column

Create table with object column:

```
DROP TABLE Weatherdata_tab;
CREATE TABLE Weatherdata_tab (
  Reg_obj INTEGER,
  Maxtemp INTEGER,
  Mintemp INTEGER
);
```

Create deterministic function with parameter of type `Reg_obj`:

```

CREATE OR REPLACE FUNCTION Distance_from_equator (
  Reg_obj IN INTEGER
) RETURN INTEGER
  DETERMINISTIC
IS
BEGIN
  RETURN(3000);
END;
/

```

Create first function-based index:

```

CREATE INDEX Distance_index
ON Weatherdata_tab (Distance_from_equator (Reg_obj));

```

Use index expression in query:

```

SELECT * FROM Weatherdata_tab
WHERE (Distance_from_equator (Reg_Obj)) > '1000';

```

Result:

no rows selected

Create second function-based (and composite) index:

```

CREATE INDEX Compare_index
ON Weatherdata_tab ((Maxtemp - Mintemp) DESC, Maxtemp);

```

Use index expression and indexed column in query:

```

SELECT * FROM Weatherdata_tab
WHERE ((Maxtemp - Mintemp) < '20' AND Maxtemp > '75');

```

Result:

no rows selected

11.4.5 Example: Function-Based Index for Faster Case-Insensitive Searches

[Example 11-3](#) (page 11-7) creates an index that allows faster case-insensitive searches in the EMPLOYEES table and then uses the index expression in a query.

Example 11-3 Function-Based Index for Faster Case-Insensitive Searches

Create index:

```

CREATE INDEX emp_lastname ON EMPLOYEES (UPPER(LAST_NAME));

```

Use index expression in query:

```

SELECT first_name, last_name
FROM EMPLOYEES
WHERE UPPER(LAST_NAME) LIKE 'J%S_N';

```

Result:

```
FIRST_NAME      LAST_NAME
-----
Charles         Johnson

1 row selected.
```

11.4.6 Example: Function-Based Index for Language-Dependent Sorting

You can use the NLSSORT API for language-dependent sorting.

Example 11-4 (page 11-8) creates a table with one column, `NAME`, and a function-based index to sort that column using the collation sequence `GERMAN`, and then selects all columns of the table, ordering them by `NAME`. Because the query can use the index, the query is faster. (Assume that the query is run in a German session, where `NLS_SORT` is `GERMAN` and `NLS_COMP` is `ANSI`. Otherwise, the query would have to specify the values of these Globalization Support parameters.)

Example 11-4 *Function-Based Index for Language-Dependent Sorting*

Create table on which to create index:

```
DROP TABLE nls_tab;
CREATE TABLE nls_tab (NAME VARCHAR2(80));
```

Create index:

```
CREATE INDEX nls_index
  ON nls_tab (NLSSORT(NAME, 'NLS_SORT = GERMAN'));
```

Select all table columns, ordered by `NAME`:

```
SELECT * FROM nls_tab
WHERE NAME IS NOT NULL
ORDER BY NAME;
```

Maintaining Data Integrity in Database Applications

In a database application, **maintaining data integrity** means ensuring that the data in the tables that the application manipulates conform to the appropriate business rules. A **business rule** specifies a condition or relationship that must always be true or must always be false. For example, a business rule might be that no employee can have a salary over \$100,000 or that every employee in the `EMPLOYEES` table must belong to a department in the `DEPARTMENTS` table. Business rules vary from company to company, because each company defines its own policies about salaries, employee numbers, inventory tracking, and so on.

As explained in *Oracle Database Concepts*, there are several ways to ensure data integrity, and the one to use whenever possible is the **integrity constraint** (or **constraint**).

This chapter supplements this information:

- The explanation of data integrity and constraints in *Oracle Database Concepts*
- The information about managing constraints in *Oracle Database Administrator's Guide*
- The syntactic and semantic information about constraints in *Oracle Database SQL Language Reference*

Note:

This chapter applies to only to constraints on tables. Constraints on views do not help maintain data integrity or have associated indexes. Instead, they enable query rewrites on queries involving views, thereby improving performance when using materialized views and other data warehousing features.

For more information about constraints on views, see *Oracle Database SQL Language Reference*.

For information about using constraints in data warehouses, see *Oracle Database Data Warehousing Guide*.

Topics:

- [Enforcing Business Rules with Constraints](#) (page 12-2)
- [Enforcing Business Rules with Both Constraints and Application Code](#) (page 12-3)
- [Creating Indexes for Use with Constraints](#) (page 12-4)

- [When to Use NOT NULL Constraints](#) (page 12-5)
- [When to Use Default Column Values](#) (page 12-6)
- [Choosing a Primary Key for a Table \(PRIMARY KEY Constraint\)](#) (page 12-7)
- [When to Use UNIQUE Constraints](#) (page 12-7)
- [Enforcing Referential Integrity with FOREIGN KEY Constraints](#) (page 12-8)
- [Minimizing Space and Time Overhead for Indexes Associated with Constraints](#) (page 12-14)
- [Guidelines for Indexing Foreign Keys](#) (page 12-14)
- [Referential Integrity in a Distributed Database](#) (page 12-14)
- [When to Use CHECK Constraints](#) (page 12-15)
- [Examples of Defining Constraints](#) (page 12-17)
- [Enabling and Disabling Constraints](#) (page 12-19)
- [Modifying Constraints](#) (page 12-22)
- [Renaming Constraints](#) (page 12-23)
- [Dropping Constraints](#) (page 12-24)
- [Managing FOREIGN KEY Constraints](#) (page 12-25)
- [Viewing Information About Constraints](#) (page 12-27)

See Also:

[How the Correct Data Type Increases Data Integrity](#) (page 9-2), for information about the role that data type plays in data integrity

12.1 Enforcing Business Rules with Constraints

Whenever possible, enforce business rules with constraints. In addition to the advantages explained in *Oracle Database Concepts*, constraints have the advantage of speed: Oracle Database can check that all the data in a table obeys a constraint faster than application code can do the equivalent checking.

[Example 12-1](#) (page 12-2) creates a table of departments, a table of employees, a constraint to enforce the rule that all values in the department table are unique, and a constraint to enforce the rule that every employee must work for a valid department.

Example 12-1 Enforcing Business Rules with Constraints

Create table of departments:

```
DROP TABLE dept_tab;
CREATE TABLE dept_tab (
    deptname VARCHAR2(20),
    deptno    INTEGER
);
```

Create table of employees:

```
DROP TABLE emp_tab;
CREATE TABLE emp_tab (
    empname VARCHAR2(80),
    empno    INTEGER,
    deptno   INTEGER
);
```

Create constraint to enforce rule that all values in department table are unique:

```
ALTER TABLE dept_tab ADD PRIMARY KEY (deptno);
```

Create constraint to enforce rule that every employee must work for a valid department:

```
ALTER TABLE emp_tab ADD FOREIGN KEY (deptno) REFERENCES dept_tab(deptno);
```

Now, whenever you insert an employee record into `emp_tab`, Oracle Database checks that its `deptno` value appears in `dept_tab`.

Suppose that instead of using a constraint to enforce the rule that every employee must work for a valid department, you use a trigger that queries `dept_tab` to check that it contains the `deptno` value of the employee record to be inserted into `emp_tab`. Because the query uses consistent read (CR), it might miss uncommitted changes from other transactions. For more information about using triggers to enforce business rules, see *Oracle Database Concepts*.

See Also:

Oracle Database SQL Language Reference for syntactic and semantic information about constraints

12.2 Enforcing Business Rules with Both Constraints and Application Code

Enforcing business rules with both constraints and application code is recommended when application code can determine that data values are invalid without querying tables. The application code can provide immediate feedback to the user and reduce the load on the database by preventing attempts to insert invalid data into tables.

For [Example 12-2](#) (page 12-3), assume that [Example 12-1](#) (page 12-2) was run and then this column was added to the table `emp_tab`:

```
empgender VARCHAR2(1)
```

The only valid values for `empgender` are 'M' and 'F'. When someone tries to insert a row into `emp_tab` or update the value of `emp_tab.empgender`, application code can determine whether the new value for `emp_tab.empgender` is valid without querying a table. If the value is invalid, the application code can notify the user instead of trying to insert the invalid value, as in [Example 12-2](#) (page 12-3).

Example 12-2 Enforcing Business Rules with Both Constraints and Application Code

```
CREATE OR REPLACE PROCEDURE add_employee (
    e_name emp_tab.empname%TYPE,
    e_gender emp_tab.empgender%TYPE,
```

```
    e_number emp_tab.empno%TYPE,
    e_dept   emp_tab.deptno%TYPE
) AUTHID DEFINER IS
BEGIN
    IF UPPER(e_gender) IN ('M','F') THEN
        INSERT INTO emp_tab VALUES (e_name, e_gender, e_number, e_dept);
    ELSE
        DBMS_OUTPUT.PUT_LINE('Gender must be M or F.');
```

```
    END IF;
END;
/

BEGIN
    add_employee ('Smith', 'H', 356, 20);
END;
/
```

Result:

Gender must be M or F.

12.3 Creating Indexes for Use with Constraints

When a unique or primary key constraint is enabled, Oracle Database creates an index automatically, but Oracle recommends that you create these indexes explicitly. If you want to use an index with a foreign key constraint, then you must create the index explicitly. For information about creating indexes explicitly, see *Oracle Database Administrator's Guide* or *Oracle Database SQL Language Reference*.

When a constraint can use an existing index, Oracle Database does not create an index for that constraint. Note that:

- A unique or primary key constraint can use either a unique index, an entire nonunique index, or the first few columns of a nonunique index.
- If a unique or primary key constraint uses a nonunique index, then no other unique or primary key constraint can use that nonunique index.
- The column order in the constraint and index need not match.
- The object number of the index used by a unique or primary key constraint is stored in `CDEF$.ENABLED` for that constraint. No static data dictionary view or dynamic performance view shows this information.

If an enabled unique or primary key constraint is using an index, you cannot drop only the index. To drop the index, you must either drop the constraint itself or disable the constraint and then drop the index. For information about disabling and dropping constraints, see *Oracle Database Administrator's Guide*.

See Also:

- *Oracle Database Administrator's Guide* for more information about indexes associated with constraints
 - [Using Indexes in Database Applications](#) (page 11-1)
-
-

12.4 When to Use NOT NULL Constraints

By default, a column can contain a NULL value. To ensure that the column never contains a NULL value, use the NOT NULL constraint (described in *Oracle Database SQL Language Reference*).

Use a NOT NULL constraint in both of these situations:

- A column must contain a non-NULL value.
For example, in the table HR.EMPLOYEES, each employee must have an employee ID. Therefore, the column HR.EMPLOYEES.EMPLOYEE_ID has a NOT NULL constraint, and nobody can insert a new employee record into HR.EMPLOYEES without specifying a non-NULL value for EMPLOYEE_ID. You *can* insert a new employee record into HR.EMPLOYEES without specifying a salary; therefore, the column HR.EMPLOYEES.SALARY does *not* have a NOT NULL constraint.
- You want to allow index scans of the table, or allow an operation that requires indexing all rows.

Oracle Database indexes do not store keys whose values are all NULL. Therefore, for the preceding kinds of operations, at least one indexed column must have a NOT NULL constraint.

[Example 12-3](#) (page 12-5) uses the SQL*Plus command DESCRIBE to show which columns of the DEPARTMENTS table have NOT NULL constraints, and then shows what happens if you try to insert NULL values in columns that have NOT NULL constraints.

Example 12-3 Inserting NULL Values into Columns with NOT NULL Constraints

```
DESCRIBE DEPARTMENTS;
```

Result:

Name	Null?	Type
DEPARTMENT_ID	NOT NULL	NUMBER(4)
DEPARTMENT_NAME	NOT NULL	VARCHAR2(30)
MANAGER_ID		NUMBER(6)
LOCATION_ID		NUMBER(4)

Try to insert NULL into DEPARTMENT_ID column:

```
INSERT INTO DEPARTMENTS (
  DEPARTMENT_ID, DEPARTMENT_NAME, MANAGER_ID, LOCATION_ID
)
VALUES (NULL, 'Sales', 200, 1700);
```

Result:

```
VALUES (NULL, 'Sales', 200, 1700)
*
ERROR at line 4:
ORA-01400: cannot insert NULL into ("HR"."DEPARTMENTS"."DEPARTMENT_ID")
```

Omitting a value for a column that cannot be NULL is the same as assigning it the value NULL:

```
INSERT INTO DEPARTMENTS (
  DEPARTMENT_NAME, MANAGER_ID, LOCATION_ID
```

```
)  
VALUES ('Sales', 200, 1700);
```

Result:

```
INSERT INTO DEPARTMENTS (  
*  
ERROR at line 1:  
ORA-01400: cannot insert NULL into ("HR"."DEPARTMENTS"."DEPARTMENT_ID")
```

You can prevent the preceding error by giving `DEPARTMENT_ID` a non-NULL default value. For more information, see [When to Use Default Column Values](#) (page 12-6).

You can combine `NOT NULL` constraints with other constraints to further restrict the values allowed in specific columns. For example, the combination of `NOT NULL` and `UNIQUE` constraints forces the input of values in the `UNIQUE` key, eliminating the possibility that data in a new conflicts with data in an existing row. For more information, see "[UNIQUE and NOT NULL Constraints on the Foreign Key](#) (page 12-11)".

12.5 When to Use Default Column Values

When an `INSERT` statement (described in *Oracle Database SQL Language Reference*) does not specify a value for a specific column, that column receives its default value. By default, that default value is `NULL`. You can change the default value when you define the column (with the `CREATE TABLE` statement, described in *Oracle Database SQL Language Reference*) or when you alter the column (with the `ALTER TABLE` statement, described in *Oracle Database SQL Language Reference*).

Note:

Giving a column a non-NULL default value does not ensure that the value of the column will never have the value `NULL`, as the `NOT NULL` constraint does. For information about the `NOT NULL` constraint, see [When to Use NOT NULL Constraints](#) (page 12-5).

Use a default column value in these situations:

- The column has a `NOT NULL` constraint.

Giving the column a non-NULL default value prevents the error that would occur if someone inserted a row without specifying a value for the column.

- There is a most common value for the column.

For example, if most departments in the company are in New York, then set the default value of the column `DEPARTMENTS.LOCATION` to `'NEW YORK'`.

- There is a non-NULL value that signifies no entry.

For example, if the value zero in the column `EMPLOYEES.SALARY` means that the salary has not yet been determined, then set the default value of that column to zero.

A default column value that signifies no entry can simplify testing. For example, it lets you change this test:

```
IF (employees.salary IS NOT NULL) AND (employees.salary < 50000)
```

To this test:

```
IF employees.salary < 50000
```

- You want to automatically record the names of users who modify a table.

For example, suppose that you allow users to insert rows into a table through a view. You give the base table a column named `inserter` (which need not be included in the definition of the view), to store the name of the user who inserted the row. To record the user name automatically, define a default value that invokes the `USER` function. For example:

```
CREATE TABLE audit_trail (
  value1  NUMBER,
  value2  VARCHAR2(32),
  inserter VARCHAR2(30) DEFAULT USER);
```

12.6 Choosing a Primary Key for a Table (PRIMARY KEY Constraint)

The primary key of a table uniquely identifies each row and ensures that no duplicate rows exist (and typically, this is its only purpose). Therefore, a primary key value cannot be `NULL`.

A table can have at most one primary key, but that key can have multiple columns (that is, it can be a composite key). To designate a primary key, use the `PRIMARY KEY` constraint.

Whenever practical, choose as the primary key a single column whose values are generated by a sequence. For information about sequences, see *Oracle Database SQL Language Reference*.

The second-best choice for a primary key is a single column whose values are all of the following:

- Unique
- Never changed
- Never `NULL`
- Short and numeric (and therefore easy to type)

Minimize your use of composite primary keys, whose values are long and cannot be generated by a sequence.

See Also:

- *Oracle Database Concepts* for general information about primary key constraints
 - *Oracle Database SQL Language Reference* for complete information about primary key constraints, including restrictions
-
-

12.7 When to Use UNIQUE Constraints

Use a `UNIQUE` constraint (which designates a unique key) on any column or combination of columns (except the primary key) where duplicate non-`NULL` values are not allowed. For example:

Unique Key	Primary Key
Employee Social Security Number	Employee number
Truck license plate number	Truck number
Customer phone number (country code column, area code column, and local phone number column)	Customer number
Department name column and location column	Department number

Figure 12-1 (page 12-8) shows a table with a UNIQUE constraint, a row that violates the constraint, and a row that satisfies it.

Figure 12-1 Rows That Violate and Satisfy a UNIQUE Constraint

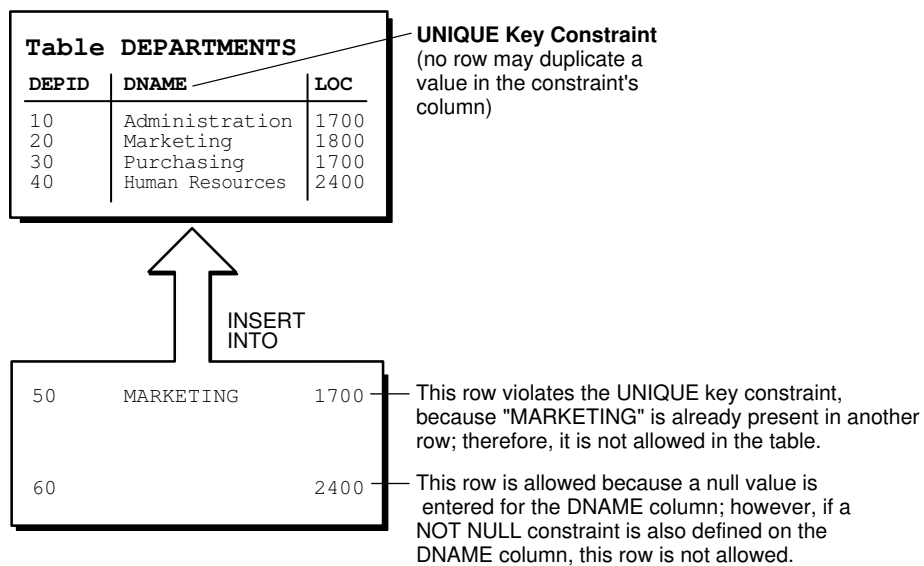

See Also:

- *Oracle Database Concepts* for general information about UNIQUE constraints
- *Oracle Database SQL Language Reference* for complete information about UNIQUE constraints, including restrictions

12.8 Enforcing Referential Integrity with FOREIGN KEY Constraints

When two tables share one or more columns, you can use a FOREIGN KEY constraint to enforce referential integrity—that is, to ensure that the shared columns always have the same values in both tables.

Note:

A FOREIGN KEY constraint is also called a **referential integrity constraint**, and its CONSTRAINT_TYPE is R in the static data dictionary views *_CONSTRAINTS.

Designate one table as the **referenced or parent table** and the other as the **dependent or child table**. In the parent table, define either a PRIMARY KEY or UNIQUE constraint on the shared columns. In the child table, define a FOREIGN KEY constraint on the shared columns. The shared columns now comprise a **foreign key**. Defining additional constraints on the foreign key affects the parent-child relationship—for details, see [Defining Relationships Between Parent and Child Tables](#) (page 12-10).

[Figure 12-2](#) (page 12-9) shows a foreign key defined on the department number. It guarantees that every value in this column must match a value in the primary key of the department table. This constraint prevents erroneous department numbers from getting into the employee table.

[Figure 12-2](#) (page 12-9) shows parent and child tables that share one column, a row that violates the FOREIGN KEY constraint, and a row that satisfies it.

Figure 12-2 Rows That Violate and Satisfy a FOREIGN KEY Constraint

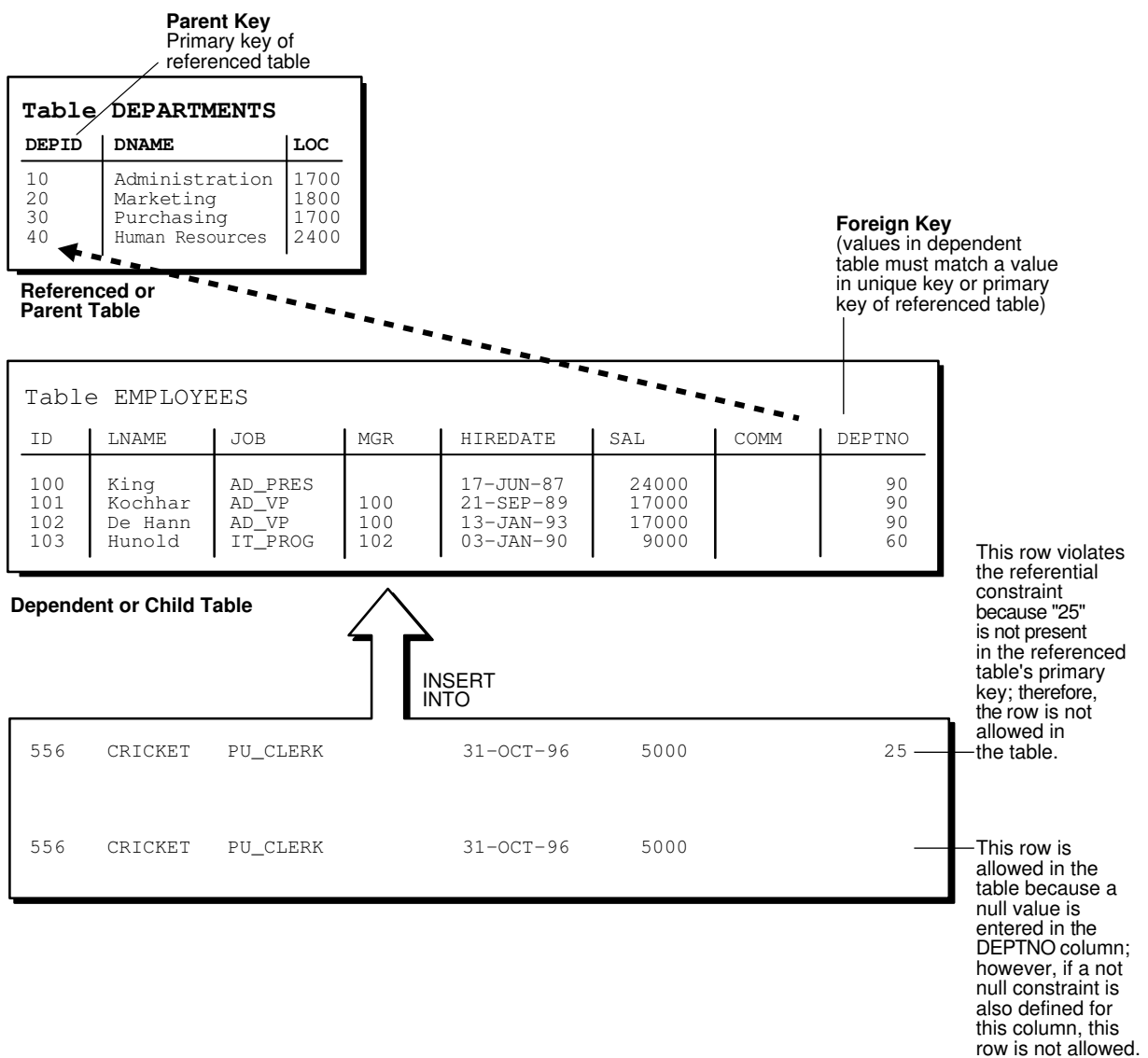

Topics:

- [FOREIGN KEY Constraints and NULL Values](#) (page 12-10)

- [Defining Relationships Between Parent and Child Tables](#) (page 12-10)
- [Rules for Multiple FOREIGN KEY Constraints](#) (page 12-11)
- [Deferring Constraint Checks](#) (page 12-11)

See Also:

- *Oracle Database Concepts* for general information about foreign key constraints
 - *Oracle Database SQL Language Reference* for complete information about foreign key constraints, including restrictions
-

12.8.1 FOREIGN KEY Constraints and NULL Values

Foreign keys allow key values that are all NULL, even if there are no matching PRIMARY or UNIQUE keys.

- By default (without any NOT NULL or CHECK clauses), the FOREIGN KEY constraint enforces the **match none** rule for composite foreign keys in the ANSI/ISO standard.
- To enforce the **match full** rule for NULL values in composite foreign keys, which requires that all components of the key be NULL or all be non-NULL, define a CHECK constraint that allows only all NULL or all non-NULL values in the composite foreign key. For example, with a composite key comprised of columns A, B, and C:

```
CHECK ((A IS NULL AND B IS NULL AND C IS NULL) OR  
       (A IS NOT NULL AND B IS NOT NULL AND C IS NOT NULL))
```

- In general, it is not possible to use declarative referential integrity to enforce the **match partial** rule for NULL values in composite foreign keys, which requires the non-NULL portions of the key to appear in the corresponding portions in the primary or unique key of a single row in the referenced table. You can often use triggers to handle this case, as described in *Oracle Database PL/SQL Language Reference*.

12.8.2 Defining Relationships Between Parent and Child Tables

Several relationships between parent and child tables can be determined by the other types of constraints defined on the foreign key in the child table.

No Constraints on the Foreign Key

When no other constraints are defined on the foreign key, any number of rows in the child table can reference the same parent key value. This model allows nulls in the foreign key.

This model establishes a one-to-many relationship between the parent and foreign keys that allows undetermined values (nulls) in the foreign key. An example of such a relationship is shown in [Figure 12-2](#) (page 12-9) between the `employee` and `department` tables. Each department (parent key) has many employees (foreign key), and some employees might not be in a department (nulls in the foreign key).

NOT NULL Constraint on the Foreign Key

When nulls are not allowed in a foreign key, each row in the child table must explicitly reference a value in the parent key because nulls are not allowed in the foreign key.

Any number of rows in the child table can reference the same parent key value, so this model establishes a one-to-many relationship between the parent and foreign keys. However, each row in the child table must have a reference to a parent key value; the absence of a value (a null) in the foreign key is not allowed. The same example in the previous section illustrates such a relationship. However, in this case, employees must have a reference to a specific department.

UNIQUE Constraint on the Foreign Key

When a `UNIQUE` constraint is defined on the foreign key, only one row in the child table can reference a given parent key value. This model allows nulls in the foreign key.

This model establishes a one-to-one relationship between the parent and foreign keys that allows undetermined values (nulls) in the foreign key. For example, assume that the employee table had a column named `MEMBERNO`, referring to an employee membership number in the company insurance plan. Also, a table named `INSURANCE` has a primary key named `MEMBERNO`, and other columns of the table keep respective information relating to an employee insurance policy. The `MEMBERNO` in the employee table must be both a foreign key and a unique key:

- To enforce referential integrity rules between the `EMP_TAB` and `INSURANCE` tables (the `FOREIGN KEY` constraint)
- To guarantee that each employee has a unique membership number (the `UNIQUE` key constraint)

UNIQUE and NOT NULL Constraints on the Foreign Key

When both `UNIQUE` and `NOT NULL` constraints are defined on the foreign key, only one row in the child table can reference a given parent key value, and because `NULL` values are not allowed in the foreign key, each row in the child table must explicitly reference a value in the parent key.

This model establishes a one-to-one relationship between the parent and foreign keys that does not allow undetermined values (nulls) in the foreign key. If you expand the previous example by adding a `NOT NULL` constraint on the `MEMBERNO` column of the employee table, in addition to guaranteeing that each employee has a unique membership number, you also ensure that no undetermined values (nulls) are allowed in the `MEMBERNO` column of the employee table.

12.8.3 Rules for Multiple FOREIGN KEY Constraints

Oracle Database allows a column to be referenced by multiple `FOREIGN KEY` constraints; there is no limit on the number of dependent keys. This situation might be present if a single column is part of two different composite foreign keys.

12.8.4 Deferring Constraint Checks

When Oracle Database checks a constraint, it signals an error if the constraint is not satisfied. To defer checking constraints until the end of the current transaction, use the `SET CONSTRAINTS` statement.

Note:

You cannot use the SET CONSTRAINTS statement inside a trigger.

When deferring constraint checks:

- Select appropriate data.
You might want to defer constraint checks on UNIQUE and FOREIGN keys if the data you are working with has any of these characteristics:

- Tables are snapshots.
- Some tables contain a large amount of data being manipulated by another application, which might not return the data in the same order.

- Update cascade operations on foreign keys.
- Ensure that constraints are deferrable.

After identifying the appropriate tables, ensure that their FOREIGN, UNIQUE and PRIMARY key constraints are created DEFERRABLE.

- Within the application that manipulates the data, set all constraints deferred before you begin processing any data, as follows:

```
SET CONSTRAINTS ALL DEFERRED;
```

- (Optional) Check for constraint violations immediately before committing the transaction.

Immediately before the COMMIT statement, run the SET CONSTRAINTS ALL IMMEDIATE statement. If there are any problems with a constraint, this statement fails, and identifies the constraint that caused the error. If you commit while constraints are violated, the transaction rolls back and you get an error message.

In [Example 12-4](#) (page 12-12), the PRIMARY and FOREIGN keys of the table emp are created DEFERRABLE and then deferred.

Example 12-4 Deferring Constraint Checks

```
DROP TABLE dept;
CREATE TABLE dept (
  deptno NUMBER PRIMARY KEY,
  dname VARCHAR2 (30)
);

DROP TABLE emp;
CREATE TABLE emp (
  empno NUMBER,
  ename VARCHAR2(30),
  deptno NUMBER,
  CONSTRAINT pk_emp_empno PRIMARY KEY (empno) DEFERRABLE,
  CONSTRAINT fk_emp_deptno FOREIGN KEY (deptno)
  REFERENCES dept(deptno) DEFERRABLE);

INSERT INTO dept (deptno, dname) VALUES (10, 'Accounting');
INSERT INTO dept (deptno, dname) VALUES (20, 'SALES');

INSERT INTO emp (empno, ename, deptno) VALUES (1, 'Corleone', 10);
INSERT INTO emp (empno, ename, deptno) VALUES (2, 'Costanza', 20);
COMMIT;

SET CONSTRAINTS ALL DEFERRED;
```

```
UPDATE dept
SET deptno = deptno + 10
WHERE deptno = 20;
```

Query:

```
SELECT * from dept
ORDER BY deptno;
```

Result:

```
DEPTNO DNAME
-----
      10 Accounting
      30 SALES
```

2 rows selected.

Update:

```
UPDATE emp
SET deptno = deptno + 10
WHERE deptno = 20;
```

Result:

1 row updated.

Query:

```
SELECT * from emp
ORDER BY deptno;
```

Result:

```
EMPNO ENAME DEPTNO
-----
      1 Corleone      10
      2 Costanza      30
```

2 rows selected.

The `SET CONSTRAINTS` applies only to the current transaction, and its setting lasts for the duration of the transaction, or until another `SET CONSTRAINTS` statement resets the mode. The `ALTER SESSION SET CONSTRAINTS` statement applies only for the current session. The defaults specified when you create a constraint remain while the constraint exists.

See Also:

Oracle Database SQL Language Reference for more information about the `SET CONSTRAINTS` statement

12.9 Minimizing Space and Time Overhead for Indexes Associated with Constraints

When you create a `UNIQUE` or `PRIMARY` key, Oracle Database checks to see if an existing index enforces uniqueness for the constraint. If there is no such index, the database creates one.

When Oracle Database uses a unique index to enforce a constraint, and constraints associated with the unique index are dropped or disabled, the index is dropped. To preserve the statistics associated with the index (which would take a long time to re-create), specify the `KEEP INDEX` clause on the `DROP CONSTRAINT` statement.

While enabled foreign keys reference a `PRIMARY` or `UNIQUE` key, you cannot disable or drop the `PRIMARY` or `UNIQUE` key constraint or the index.

Note:

`UNIQUE` and `PRIMARY` keys with deferrable constraints must all use nonunique indexes.

To use existing indexes when creating unique and primary key constraints, include `USING INDEX` in the `CONSTRAINT` clause. For details and examples, see *Oracle Database SQL Language Reference*.

12.10 Guidelines for Indexing Foreign Keys

Index foreign keys unless the matching unique or primary key is never updated or deleted.

See Also:

Oracle Database Concepts for more information about indexing foreign keys

12.11 Referential Integrity in a Distributed Database

The declaration of a referential constraint cannot specify a foreign key that references a primary or unique key of a remote table.

However, you can maintain parent/child table relationships across nodes using triggers.

See Also:

Oracle Database PL/SQL Language Reference for more information about triggers that enforce referential integrity

Note:

If you decide to define referential integrity across the nodes of a distributed database using triggers, be aware that network failures can make both the parent table and the child table inaccessible.

For example, assume that the child table is in the SALES database, and the parent table is in the HQ database.

If the network connection between the two databases fails, then some data manipulation language (DML) statements against the child table (those that insert rows or update a foreign key value) cannot proceed, because the referential integrity triggers must have access to the parent table in the HQ database.

12.12 When to Use CHECK Constraints

Use CHECK constraints when you must enforce integrity rules based on logical expressions, such as comparisons. Never use CHECK constraints when any of the other types of constraints can provide the necessary checking.

See Also:

[Choosing Between CHECK and NOT NULL Constraints](#) (page 12-16)

Examples of CHECK constraints include:

- A CHECK constraint on employee salaries so that no salary value is greater than 10000.
- A CHECK constraint on department locations so that only the locations "BOSTON", "NEW YORK", and "DALLAS" are allowed.
- A CHECK constraint on the salary and commissions columns to prevent the commission from being larger than the salary.

12.12.1 Restrictions on CHECK Constraints

A CHECK constraint requires that a condition be true or unknown for every row of the table. If a statement causes the condition to evaluate to false, then the statement is rolled back. The condition of a CHECK constraint has these limitations:

- The condition must be a Boolean expression that can be evaluated using the values in the row being inserted or updated.
- The condition cannot contain subqueries or sequences.
- The condition cannot include the SYSDATE, UID, USER, or USERENV SQL functions.
- The condition cannot contain the pseudocolumns LEVEL or ROWNUM.
- The condition cannot contain the PRIOR operator.
- The condition cannot contain a user-defined function.

See Also:

- *Oracle Database SQL Language Reference* for information about the LEVEL pseudocolumn
 - *Oracle Database SQL Language Reference* for information about the ROWNUM pseudocolumn
 - *Oracle Database SQL Language Reference* for information about the PRIOR operator (used in hierarchical queries)
-

12.12.2 Designing CHECK Constraints

When using CHECK constraints, remember that a CHECK constraint is violated only if the condition evaluates to false; true and unknown values (such as comparisons with nulls) do not violate a check condition. Ensure that any CHECK constraint that you define is specific enough to enforce the rule.

For example, consider this CHECK constraint:

```
CHECK (Sal > 0 OR Comm >= 0)
```

At first glance, this rule may be interpreted as "do not allow a row in the employee table unless the employee salary is greater than zero or the employee commission is greater than or equal to zero." But if a row is inserted with a null salary, that row does not violate the CHECK constraint, regardless of whether the commission value is valid, because the entire check condition is evaluated as unknown. In this case, you can prevent such violations by placing NOT NULL constraints on both the SAL and COMM columns.

Note:

If you are not sure when unknown values result in NULL conditions, review the truth tables for the logical conditions in *Oracle Database SQL Language Reference*

12.12.3 Rules for Multiple CHECK Constraints

A single column can have multiple CHECK constraints that reference the column in its definition. There is no limit to the number of CHECK constraints that can be defined that reference a column.

The order in which the constraints are evaluated is not defined, so be careful not to rely on the order or to define multiple constraints that conflict with each other.

12.12.4 Choosing Between CHECK and NOT NULL Constraints

According to the ANSI/ISO standard, a NOT NULL constraint is an example of a CHECK constraint, where the condition is:

```
CHECK (column_name IS NOT NULL)
```

Therefore, you can write NOT NULL constraints for a single column using either a NOT NULL constraint or a CHECK constraint. The NOT NULL constraint is easier to use than the CHECK constraint.

In the case where a composite key can allow only all NULL or all non-NULL values, you must use a CHECK constraint. For example, this CHECK constraint allows a key value in the composite key made up of columns C1 and C2 to contain either all nulls or all values:

```
CHECK ((C1 IS NULL AND C2 IS NULL) OR (C1 IS NOT NULL AND C2 IS NOT NULL))
```

12.13 Examples of Defining Constraints

[Example 12-5](#) (page 12-17) and [Example 12-6](#) (page 12-17) show how to create simple constraints during the prototype phase of your database design. In these examples, each constraint is given a name. Naming the constraints prevents the database from creating multiple copies of the same constraint, with different system-generated names, if the data definition language (DDL) statement runs multiple times.

[Example 12-5](#) (page 12-17) creates tables and their constraints at the same time, using the CREATE TABLE statement.

Example 12-5 Defining Constraints with the CREATE TABLE Statement

```
DROP TABLE DeptTab;
CREATE TABLE DeptTab (
    Deptno NUMBER(3) CONSTRAINT pk_DeptTab_Deptno PRIMARY KEY,
    Dname VARCHAR2(15),
    Loc VARCHAR2(15),
    CONSTRAINT u_DeptTab_Dname_Loc UNIQUE (Dname, Loc),
    CONSTRAINT c_DeptTab_Loc
        CHECK (Loc IN ('NEW YORK', 'BOSTON', 'CHICAGO')));

DROP TABLE EmpTab;
CREATE TABLE EmpTab (
    Empno NUMBER(5) CONSTRAINT pk_EmpTab_Empno PRIMARY KEY,
    Ename VARCHAR2(15) NOT NULL,
    Job VARCHAR2(10),
    Mgr NUMBER(5) CONSTRAINT r_EmpTab_Mgr REFERENCES EmpTab,
    Hiredate DATE,
    Sal NUMBER(7,2),
    Comm NUMBER(5,2),
    Deptno NUMBER(3) NOT NULL
    CONSTRAINT r_EmpTab_DeptTab REFERENCES DeptTab ON DELETE CASCADE);
```

[Example 12-6](#) (page 12-17) creates constraints for existing tables, using the ALTER TABLE statement.

You cannot create a validated constraint on a table if the table contains rows that violate the constraint.

Example 12-6 Defining Constraints with the ALTER TABLE Statement

```
-- Create tables without constraints:
```

```
DROP TABLE DeptTab;
CREATE TABLE DeptTab (
    Deptno NUMBER(3),
    Dname VARCHAR2(15),
    Loc VARCHAR2(15)
);

DROP TABLE EmpTab;
CREATE TABLE EmpTab (
    Empno NUMBER(5),
    Ename VARCHAR2(15),
```

```
Job      VARCHAR2(10),
Mgr      NUMBER(5),
Hiredate DATE,
Sal      NUMBER(7,2),
Comm     NUMBER(5,2),
Deptno   NUMBER(3)
);

--Define constraints with the ALTER TABLE statement:

ALTER TABLE DeptTab
ADD CONSTRAINT pk_DeptTab_Deptno PRIMARY KEY (Deptno);

ALTER TABLE EmpTab
ADD CONSTRAINT fk_DeptTab_Deptno
FOREIGN KEY (Deptno) REFERENCES DeptTab;

ALTER TABLE EmpTab MODIFY (Ename VARCHAR2(15) NOT NULL);
```

See Also:

Oracle Database Administrator's Guide for information about creating and maintaining constraints for a large production database

12.13.1 Privileges Needed to Define Constraints

If you have the `CREATE TABLE` or `CREATE ANY TABLE` system privilege, then you can define constraints on the tables that you create.

If you have the `ALTER ANY TABLE` system privilege, then you can define constraints on any existing table.

If you have the `ALTER` object privilege for a specific table, then you can define constraints on that table.

`UNIQUE` and `PRIMARY KEY` constraints require that the table owner has either the `UNLIMITED TABLESPACE` system privilege or a quota for the tablespace that contains the associated index.

You can define `FOREIGN KEY` constraints if the parent table or view is in your schema or you have the `REFERENCES` privilege on the columns of the referenced key in the parent table or view. For more information, see [Privileges Required to Create FOREIGN KEY Constraints](#) (page 12-26).

12.13.2 Naming Constraints

Assign names to constraints `NOT NULL`, `UNIQUE`, `PRIMARY KEY`, `FOREIGN KEY`, and `CHECK` using the `CONSTRAINT` option of the constraint clause. This name must be unique among the constraints that you own. If you do not specify a constraint name, one is assigned automatically by Oracle Database.

Choosing your own name makes error messages for constraint violations more understandable, and prevents the creation of duplicate constraints with different names if the SQL statements are run more than once.

See the previous examples of the `CREATE TABLE` and `ALTER TABLE` statements for examples of the `CONSTRAINT` option of the constraint clause. The name of each constraint is included with other information about the constraint in the data dictionary.

See Also:

["Viewing Information About Constraints \(page 12-27\)"](#) for examples of static data dictionary views

12.14 Enabling and Disabling Constraints

This section explains the mechanisms and procedures for manually enabling and disabling constraints.

enabled constraint. When a constraint is enabled, the corresponding rule is enforced on the data values in the associated columns. The definition of the constraint is stored in the data dictionary.

disabled constraint. When a constraint is disabled, the corresponding rule is not enforced. The definition of the constraint is still stored in the data dictionary.

An integrity constraint represents an assertion about the data in a database. This assertion is always true when the constraint is enabled. The assertion might not be true when the constraint is disabled, because data that violates the integrity constraint can be in the database.

Topics:

- [Why Disable Constraints?](#) (page 12-19)
- [Creating Enabled Constraints \(Default\)](#) (page 12-19)
- [Creating Disabled Constraints](#) (page 12-20)
- [Enabling Existing Constraints](#) (page 12-21)
- [Disabling Existing Constraints](#) (page 12-21)
- [Guidelines for Enabling and Disabling Key Constraints](#) (page 12-22)
- [Fixing Constraint Exceptions](#) (page 12-22)

12.14.1 Why Disable Constraints?

During day-to-day operations, keep constraints enabled. In certain situations, temporarily disabling the constraints of a table makes sense for performance reasons. For example:

- When loading large amounts of data into a table using SQL*Loader
- When performing batch operations that make massive changes to a table (such as changing each employee number by adding 1000 to the existing number)
- When importing or exporting one table at a time

Temporarily turning off constraints can speed up these operations.

12.14.2 Creating Enabled Constraints (Default)

When you define an integrity constraint (using either `CREATE TABLE` or `ALTER TABLE`), Oracle Database enables the constraint by default. For code clarity, you can

explicitly enable the constraint by including the `ENABLE` clause in its definition, as in [Example 12-7](#) (page 12-20).

Example 12-7 Creating Enabled Constraints

```
/* Use CREATE TABLE statement to create enabled constraint
   (ENABLE keyword is optional): */

DROP TABLE t1;
CREATE TABLE t1 (Empno NUMBER(5) PRIMARY KEY ENABLE);

/* Create table without constraint
   and then use ALTER TABLE statement to add enabled constraint
   (ENABLE keyword is optional): */

DROP TABLE t2;
CREATE TABLE t2 (Empno NUMBER(5));

ALTER TABLE t2 ADD PRIMARY KEY (Empno) ENABLE;
```

Include the `ENABLE` clause when defining a constraint for a table to be populated a row at a time by individual transactions. This ensures that data is always consistent, and reduces the performance overhead of each DML statement.

An `ALTER TABLE` statement that tries to enable an integrity constraint fails if an existing row of the table violates the integrity constraint. The statement rolls back and the constraint definition is neither stored nor enabled.

See Also:

[Fixing Constraint Exceptions](#) (page 12-22), for more information about rows that violate constraints

12.14.3 Creating Disabled Constraints

You define and disable an integrity constraint (using either `CREATE TABLE` or `ALTER TABLE`), by including the `DISABLE` clause in its definition, as in [Example 12-8](#) (page 12-20).

Example 12-8 Creating Disabled Constraints

```
/* Use CREATE TABLE statement to create disabled constraint */

DROP TABLE t1;
CREATE TABLE t1 (Empno NUMBER(5) PRIMARY KEY DISABLE);

/* Create table without constraint
   and then use ALTER TABLE statement to add disabled constraint */

DROP TABLE t2;
CREATE TABLE t2 (Empno NUMBER(5));

ALTER TABLE t2 ADD PRIMARY KEY (Empno) DISABLE;
```

Include the `DISABLE` clause when defining a constraint for a table to have large amounts of data inserted before anybody else accesses it, particularly if you must cleanse data after inserting it, or must fill empty columns with sequence numbers or parent/child relationships.

An ALTER TABLE statement that defines and disables a constraint never fails, because its rule is not enforced.

12.14.4 Enabling Existing Constraints

After you have cleansed the data and filled the empty columns, you can enable constraints that were disabled during data insertion.

To enable an existing constraint, use the ALTER TABLE statement with the ENABLE clause, as in [Example 12-9](#) (page 12-21).

Example 12-9 Enabling Existing Constraints

```
-- Create table with disabled constraints:

DROP TABLE DeptTab;
CREATE TABLE DeptTab (
  Deptno NUMBER(3) PRIMARY KEY DISABLE,
  Dname  VARCHAR2(15),
  Loc    VARCHAR2(15),
  CONSTRAINT uk_DeptTab_Dname_Loc UNIQUE (Dname, Loc) DISABLE,
  CONSTRAINT c_DeptTab_Loc
  CHECK (Loc IN ('NEW YORK', 'BOSTON', 'CHICAGO')) DISABLE
);

-- Enable constraints:

ALTER TABLE DeptTab
ENABLE PRIMARY KEY
ENABLE CONSTRAINT uk_DeptTab_Dname_Loc
ENABLE CONSTRAINT c_DeptTab_Loc;
```

An ALTER TABLE statement that attempts to enable an integrity constraint fails if any of the table rows violate the integrity constraint. The statement is rolled back and the constraint is not enabled.

See Also:

[Fixing Constraint Exceptions](#) (page 12-22), for more information about rows that violate constraints

12.14.5 Disabling Existing Constraints

If you must perform a large insert or update when a table contains data, you can temporarily disable constraints to improve performance of the bulk operation.

To disable an existing constraint, use the ALTER TABLE statement with the DISABLE clause, as in [Example 12-10](#) (page 12-21).

Example 12-10 Disabling Existing Constraints

```
-- Create table with enabled constraints:

DROP TABLE DeptTab;
CREATE TABLE DeptTab (
  Deptno NUMBER(3) PRIMARY KEY ENABLE,
  Dname  VARCHAR2(15),
  Loc    VARCHAR2(15),
  CONSTRAINT uk_DeptTab_Dname_Loc UNIQUE (Dname, Loc) ENABLE,
  CONSTRAINT c_DeptTab_Loc
```

```
CHECK (Loc IN ('NEW YORK', 'BOSTON', 'CHICAGO')) ENABLE
);
```

```
-- Disable constraints:
```

```
ALTER TABLE DeptTab
DISABLE PRIMARY KEY
DISABLE CONSTRAINT uk_DeptTab_Dname_Loc
DISABLE CONSTRAINT c_DeptTab_Loc;
```

12.14.6 Guidelines for Enabling and Disabling Key Constraints

When enabling or disabling UNIQUE, PRIMARY KEY, and FOREIGN KEY constraints, be aware of several important issues and prerequisites. UNIQUE key and PRIMARY KEY constraints are usually managed by the database administrator.

See Also:

Oracle Database Administrator's Guide and [Managing FOREIGN KEY Constraints](#) (page 12-25)

12.14.7 Fixing Constraint Exceptions

If a row of a table disobeys an integrity constraint, then this row is in violation of the constraint and is called an **exception** to the constraint. If any exceptions exist, then the constraint cannot be enabled. The rows that violate the constraint must be updated or deleted before the constraint can be enabled.

You can identify exceptions for a specific integrity constraint as you try to enable the constraint.

See Also:

[Fixing Constraint Exceptions](#) (page 12-22), for more information about this procedure

When you try to create or enable a constraint, and the statement fails because integrity constraint exceptions exist, the statement is rolled back. You cannot enable the constraint until all exceptions are either updated or deleted. To determine which rows violate the integrity constraint, include the EXCEPTIONS option in the ENABLE clause of a CREATE TABLE or ALTER TABLE statement.

See Also:

Oracle Database Administrator's Guide for more information about responding to constraint exceptions

12.15 Modifying Constraints

Starting with Oracle8i, you can modify an existing constraint with the MODIFY CONSTRAINT clause, as in [Example 12-11](#) (page 12-23).

See Also:

Oracle Database SQL Language Reference for information about the parameters you can modify

Example 12-11 Modifying Constraints

```

/* Create & then modify a CHECK constraint: */

DROP TABLE X1Tab;
CREATE TABLE X1Tab (
  a1 NUMBER
  CONSTRAINT c_X1Tab_a1 CHECK (a1>3)
  DEFERRABLE DISABLE
);

ALTER TABLE X1Tab
MODIFY CONSTRAINT c_X1Tab_a1 ENABLE;

ALTER TABLE X1Tab
MODIFY CONSTRAINT c_X1Tab_a1 RELY;

ALTER TABLE X1Tab
MODIFY CONSTRAINT c_X1Tab_a1 INITIALLY DEFERRED;

ALTER TABLE X1Tab
MODIFY CONSTRAINT c_X1Tab_a1 ENABLE NOVALIDATE;

/* Create & then modify a PRIMARY KEY constraint: */

DROP TABLE t1;
CREATE TABLE t1 (a1 INT, b1 INT);

ALTER TABLE t1
ADD CONSTRAINT pk_t1_a1 PRIMARY KEY(a1) DISABLE;

ALTER TABLE t1
MODIFY PRIMARY KEY INITIALLY IMMEDIATE
USING INDEX PCTFREE = 30 ENABLE NOVALIDATE;

ALTER TABLE t1
MODIFY PRIMARY KEY ENABLE NOVALIDATE;

```

12.16 Renaming Constraints

One property of a constraint that you can modify is its name. Situations in which you would rename a constraint include:

- You want to clone a table and its constraints.

Constraint names must be unique, even across multiple schemas. Therefore, the constraints in the original table cannot have the same names as those in the cloned table.

- You created a constraint with a default system-generated name, and now you want to give it a name that is easy to remember, so that you can easily enable and disable it.

[Example 12-12](#) (page 12-24) shows how to find the system-generated name of a constraint and change it.

Example 12-12 Renaming a Constraint

```
DROP TABLE T;
CREATE TABLE T (
  C1 NUMBER PRIMARY KEY,
  C2 NUMBER
);
```

Query:

```
SELECT CONSTRAINT_NAME FROM USER_CONSTRAINTS
WHERE TABLE_NAME = 'T'
AND CONSTRAINT_TYPE = 'P';
```

Result (system-generated name of constraint name varies):

```
CONSTRAINT_NAME
-----
SYS_C0013059

1 row selected.
```

Rename constraint from name reported in preceding query to T_C1_PK:

```
ALTER TABLE T
RENAME CONSTRAINT SYS_C0013059
TO T_C1_PK;
```

Query:

```
SELECT CONSTRAINT_NAME FROM USER_CONSTRAINTS
WHERE TABLE_NAME = 'T'
AND CONSTRAINT_TYPE = 'P';
```

Result:

```
CONSTRAINT_NAME
-----
T_C1_PK

1 row selected.
```

12.17 Dropping Constraints

You can drop a constraint using the `DROP` clause of the `ALTER TABLE` statement. Situations in which you would drop a constraint include:

- The constraint enforces a rule that is no longer true.
- The constraint is no longer needed.

To drop a constraint and all other integrity constraints that depend on it, specify `CASCADE`.

Example 12-13 Dropping Constraints

```
-- Create table with constraints:

DROP TABLE DeptTab;
CREATE TABLE DeptTab (
  Deptno NUMBER(3) PRIMARY KEY,
  Dname  VARCHAR2(15),
  Loc    VARCHAR2(15),
  CONSTRAINT uk_DeptTab_Dname_Loc UNIQUE (Dname, Loc),
  CONSTRAINT c_DeptTab_Loc
  CHECK (Loc IN ('NEW YORK', 'BOSTON', 'CHICAGO'))
);

-- Drop constraints:

ALTER TABLE DeptTab
DROP PRIMARY KEY
DROP CONSTRAINT uk_DeptTab_Dname_Loc
DROP CONSTRAINT c_DeptTab_Loc;
```

When dropping UNIQUE, PRIMARY KEY, and FOREIGN KEY constraints, be aware of several important issues and prerequisites. UNIQUE and PRIMARY KEY constraints are usually managed by the database administrator.

See Also:

- *Oracle Database SQL Language Reference* for more information about the DROP clause of the ALTER TABLE statement.
- *Oracle Database Administrator's Guide* for more information about dropping constraints.
- *Oracle Database SQL Language Reference* for information about the CASCADE CONSTRAINTS clause of the DROP TABLE statement, which drops all referential integrity constraints that refer to primary and unique keys in the dropped table

12.18 Managing FOREIGN KEY Constraints

FOREIGN KEY constraints enforce relationships between columns in different tables. Therefore, they cannot be enabled if the constraint of the referenced primary or unique key is not present or not enabled.

12.18.1 Data Types and Names for Foreign Key Columns

You must use the same data type for corresponding columns in the dependent and referenced tables. The column names need not match.

12.18.2 Limit on Columns in Composite Foreign Keys

Because foreign keys reference primary and unique keys of the parent table, and PRIMARY KEY and UNIQUE key constraints are enforced using indexes, composite foreign keys are limited to 32 columns.

12.18.3 Foreign Key References Primary Key by Default

If the column list is not included in the `REFERENCES` option when defining a `FOREIGN KEY` constraint (single column or composite), then Oracle Database assumes that you intend to reference the primary key of the specified table. Alternatively, you can explicitly specify the column(s) to reference in the parent table within parentheses. Oracle Database automatically checks to verify that this column list references a primary or unique key of the parent table. If it does not, then an informative error is returned.

12.18.4 Privileges Required to Create FOREIGN KEY Constraints

To create a `FOREIGN KEY` constraint, the creator of the constraint must have privileged access to the parent and child tables.

- **Parent Table** The creator of the referential integrity constraint must own the parent table or have `REFERENCES` object privileges on the columns that constitute the parent key of the parent table.
- **Child Table** The creator of the referential integrity constraint must have the ability to create tables (that is, the `CREATE TABLE` or `CREATE ANY TABLE` system privilege) or the ability to alter the child table (that is, the `ALTER` object privilege for the child table or the `ALTER ANY TABLE` system privilege).

In both cases, necessary privileges cannot be obtained through a role; they must be explicitly granted to the creator of the constraint.

These restrictions allow:

- The owner of the child table to explicitly decide which constraints are enforced and which other users can create constraints
- The owner of the parent table to explicitly decide if foreign keys can depend on the primary and unique keys in her tables

12.18.5 Choosing How Foreign Keys Enforce Referential Integrity

Oracle Database allows different types of referential integrity actions to be enforced, as specified with the definition of a `FOREIGN KEY` constraint:

- **Prevent Delete or Update of Parent Key** The default setting prevents the deletion or update of a parent key if there is a row in the child table that references the key. For example:

```
CREATE TABLE Emp_tab (  
FOREIGN KEY (Deptno) REFERENCES Dept_tab);
```

- **Delete Child Rows When Parent Key Deleted** The `ON DELETE CASCADE` action allows parent key data that is referenced from the child table to be deleted, but not updated. When data in the parent key is deleted, all rows in the child table that depend on the deleted parent key values are also deleted. To specify this referential action, include the `ON DELETE CASCADE` option in the definition of the `FOREIGN KEY` constraint. For example:

```
CREATE TABLE Emp_tab (  
FOREIGN KEY (Deptno) REFERENCES Dept_tab  
ON DELETE CASCADE);
```

- Set Foreign Keys to Null When Parent Key Deleted** The ON DELETE SET NULL action allows data that references the parent key to be deleted, but not updated. When referenced data in the parent key is deleted, all rows in the child table that depend on those parent key values have their foreign keys set to NULL. To specify this referential action, include the ON DELETE SET NULL option in the definition of the FOREIGN KEY constraint. For example:

```
CREATE TABLE Emp_tab (
  FOREIGN KEY (Deptno) REFERENCES Dept_tab
  ON DELETE SET NULL);
```

12.19 Viewing Information About Constraints

To find the names of constraints, what columns they affect, and other information to help you manage them, query the static data dictionary views *_CONSTRAINTS and *_CONS_COLUMNS, as in [Example 12-14](#) (page 12-27).

See Also:

Oracle Database Reference for information about *_CONSTRAINTS and *_CONS_COLUMNS

Example 12-14 Viewing Information About Constraints

```
DROP TABLE DeptTab;
CREATE TABLE DeptTab (
  Deptno NUMBER(3) PRIMARY KEY,
  Dname  VARCHAR2(15),
  Loc    VARCHAR2(15),
  CONSTRAINT uk_DeptTab_Dname_Loc UNIQUE (Dname, Loc),
  CONSTRAINT c_DeptTab_Loc
  CHECK (Loc IN ('NEW YORK', 'BOSTON', 'CHICAGO'))
);

DROP TABLE EmpTab;
CREATE TABLE EmpTab (
  Empno  NUMBER(5) PRIMARY KEY,
  Ename  VARCHAR2(15) NOT NULL,
  Job    VARCHAR2(10),
  Mgr    NUMBER(5) CONSTRAINT r_EmpTab_Mgr
        REFERENCES EmpTab ON DELETE CASCADE,
  Hiredate DATE,
  Sal    NUMBER(7,2),
  Comm   NUMBER(5,2),
  Deptno NUMBER(3) NOT NULL
  CONSTRAINT r_EmpTab_Deptno REFERENCES DeptTab
);

-- Format columns (optional):

COLUMN CONSTRAINT_NAME  FORMAT A20;
COLUMN CONSTRAINT_TYPE  FORMAT A4 HEADING 'TYPE';
COLUMN TABLE_NAME     FORMAT A10;
COLUMN R_CONSTRAINT_NAME FORMAT A17;
COLUMN SEARCH_CONDITION FORMAT A40;
COLUMN COLUMN_NAME     FORMAT A12;
```

List accessible constraints in DeptTab and EmpTab:

```

SELECT CONSTRAINT_NAME, CONSTRAINT_TYPE, TABLE_NAME, R_CONSTRAINT_NAME
FROM USER_CONSTRAINTS
WHERE (TABLE_NAME = 'DEPTTAB' OR TABLE_NAME = 'EMPTAB')
ORDER BY CONSTRAINT_NAME;

```

Result:

CONSTRAINT_NAME	TYPE	TABLE_NAME	R_CONSTRAINT_NAME
C_DEPTTAB_LOC	C	DEPTTAB	
R_EMPTAB_DEPTNO	R	EMPTAB	SYS_C006286
R_EMPTAB_MGR	R	EMPTAB	SYS_C006290
SYS_C006286	P	DEPTTAB	
SYS_C006288	C	EMPTAB	
SYS_C006289	C	EMPTAB	
SYS_C006290	P	EMPTAB	
UK_DEPTTAB_DNAME_LOC	U	DEPTTAB	

8 rows selected.

Distinguish between NOT NULL and CHECK constraints in DeptTab and EmpTab:

```

SELECT CONSTRAINT_NAME, SEARCH_CONDITION
FROM USER_CONSTRAINTS
WHERE (TABLE_NAME = 'DEPTTAB' OR TABLE_NAME = 'EMPTAB')
AND CONSTRAINT_TYPE = 'C'
ORDER BY CONSTRAINT_NAME;

```

Result:

CONSTRAINT_NAME	SEARCH_CONDITION
C_DEPTTAB_LOC	Loc IN ('NEW YORK', 'BOSTON', 'CHICAGO')
SYS_C006288	"ENAME" IS NOT NULL
SYS_C006289	"DEPTNO" IS NOT NULL

3 rows selected.

For DeptTab and EmpTab, list columns that constitute constraints:

```

SELECT CONSTRAINT_NAME, TABLE_NAME, COLUMN_NAME
FROM USER_CONS_COLUMNS
WHERE (TABLE_NAME = 'DEPTTAB' OR TABLE_NAME = 'EMPTAB')
ORDER BY CONSTRAINT_NAME;

```

Result:

CONSTRAINT_NAME	TABLE_NAME	COLUMN_NAME
C_DEPTTAB_LOC	DEPTTAB	LOC
R_EMPTAB_DEPTNO	EMPTAB	DEPTNO
R_EMPTAB_MGR	EMPTAB	MGR
SYS_C006286	DEPTTAB	DEPTNO
SYS_C006288	EMPTAB	ENAME
SYS_C006289	EMPTAB	DEPTNO
SYS_C006290	EMPTAB	EMPNO
UK_DEPTTAB_DNAME_LOC	DEPTTAB	LOC

```
UK_DEPTTAB_DNAME_LOC DEPTTAB DNAME
```

```
9 rows selected.
```

Note that:

- Some constraint names are user specified (such as UK_DEPTTAB_DNAME_LOC), while others are system specified (such as SYS_C006290).
- Each constraint type is denoted with a different character in the CONSTRAINT_TYPE column. This table summarizes the characters used for each constraint type:

Constraint Type	Character
PRIMARY KEY	P
UNIQUE KEY	U
FOREIGN KEY	R
CHECK, NOT NULL	C

Note:

An additional constraint type is indicated by the character "V" in the CONSTRAINT_TYPE column. This constraint type corresponds to constraints created using the WITH CHECK OPTION for views.

These constraints are explicitly listed in the SEARCH_CONDITION column:

- NOT NULL constraints
- The conditions for user-defined CHECK constraints

Part III

PL/SQL for Application Developers

This part presents information that application developers need about PL/SQL, the Oracle procedural extension of SQL.

Chapters:

- [Coding PL/SQL Subprograms and Packages](#) (page 13-1)
- [Using PL/Scope](#) (page 14-1)
- [Using the PL/SQL Hierarchical Profiler](#) (page 15-1)
- [Developing PL/SQL Web Applications](#) (page 17-1)
- [Using Continuous Query Notification \(CQN\)](#) (page 18-1)

See Also:

Oracle Database PL/SQL Language Reference for a complete description of PL/SQL

Coding PL/SQL Subprograms and Packages

PL/SQL subprograms and packages are the building blocks of Oracle Database applications. Oracle recommends that you implement your application as a package, for the reasons given in *Oracle Database PL/SQL Language Reference*.

Topics:

- [Overview of PL/SQL Subprograms](#) (page 13-2)
- [Overview of PL/SQL Packages](#) (page 13-2)
- [Overview of PL/SQL Units](#) (page 13-4)
- [Creating PL/SQL Subprograms and Packages](#) (page 13-6)
- [Altering PL/SQL Subprograms and Packages](#) (page 13-20)
- [Deprecating Packages, Subprograms, and Types](#) (page 13-20)
- [Dropping PL/SQL Subprograms and Packages](#) (page 13-20)
- [Compiling PL/SQL Units for Native Execution](#) (page 13-21)
- [Invoking Stored PL/SQL Subprograms](#) (page 13-21)
- [Invoking Stored PL/SQL Functions from SQL Statements](#) (page 13-28)
- [Debugging Stored Subprograms](#) (page 13-36)
- [Package Invalidations and Session State](#) (page 13-38)

See Also:

- *Oracle Database PL/SQL Language Reference* for information about handling errors in PL/SQL subprograms and packages
 - *Oracle Database Data Cartridge Developer's Guide* for information about creating aggregate functions for complex data types such as multimedia data stored using object types, opaque types, and LOBs
 - *Oracle Database SQL Tuning Guide* for information about application tracing tools, which can help you find problems in PL/SQL code
-

13.1 Overview of PL/SQL Subprograms

The basic unit of a PL/SQL source program is the **block**, which groups related declarations and statements. A block has an optional declarative part, a required executable part, and an optional exception-handling part. A block can be either anonymous or named. (For more information about PL/SQL blocks, see *Oracle Database PL/SQL Language Reference*.)

A PL/SQL **subprogram** is a named block that can be invoked repeatedly. If the subprogram has parameters, then their values can differ for each invocation. For the reasons to use subprograms, see *Oracle Database PL/SQL Language Reference*.

A subprogram is either a procedure or a function. Typically, you use a **procedure** to perform an action and a **function** to compute and return a value.

A subprogram is also either a **nested subprogram** (created inside a PL/SQL block, which can be another subprogram), a **package subprogram** (declared in a package specification and defined in the package body), or a **standalone subprogram** (created at schema level). Package subprograms and standalone programs are **stored subprograms**. A stored subprogram is compiled and stored in the database, where many applications can invoke it.

Stored subprograms are affected by the `AUTHID` and `ACCESSIBLE BY` clauses. The **AUTHID clause** affects the name resolution and privilege checking of SQL statements that the subprogram issues at runtime. The **ACCESSIBLE BY clause** specifies a white list of PL/SQL units that can access the subprogram. For information about PL/SQL units, see [Overview of PL/SQL Units](#) (page 13-4).

A PL/SQL subprogram running on an Oracle Database instance can invoke an **external subprogram** written in a third-generation language (3GL). The 3GL subprogram runs in a separate address space from that of the database. For information about external subprograms, see [Developing Applications with Multiple Programming Languages](#) (page 21-1).

PL/SQL lets you overload nested subprograms, package subprograms, and type methods. **Overloaded subprograms** have the same name but their formal parameters differ in either name, number, order, or data type family. For more information about overloaded subprograms, see *Oracle Database PL/SQL Language Reference*.

Like a stored procedure, a **trigger** is a named PL/SQL unit that is stored in the database and can be invoked repeatedly. Unlike a stored procedure, you can enable and disable a trigger, but you cannot explicitly invoke it. While a trigger is enabled, the database automatically invokes it—that is, the trigger fires—whenever its triggering event occurs. While a trigger is disabled, it does not fire. For more information about triggers, see *Oracle Database PL/SQL Language Reference*.

See Also:

Oracle Database PL/SQL Language Reference for complete information about PL/SQL subprograms

13.2 Overview of PL/SQL Packages

A PL/SQL **package** is a schema object that groups logically related PL/SQL types, variables, constants, subprograms, cursors, and exceptions. A package is compiled and

stored in the database, where many applications can share its contents. For the reasons to use packages, see *Oracle Database PL/SQL Language Reference*.

A package always has a **specification**, which declares the **public items** that can be referenced from outside the package. Public items can be used or invoked by external users who have the EXECUTE privilege for the package or the EXECUTE ANY PROCEDURE privilege.

If the public items include cursors or subprograms, then the package must also have a **body**. The body must define queries for public cursors and code for public subprograms. The body can also declare and define **private items** that cannot be referenced from outside the package, but are necessary for the internal workings of the package. Finally, the body can have an **initialization part**, whose statements initialize variables and do other one-time setup steps, and an exception-handling part. You can change the body without changing the specification or the references to the public items; therefore, you can think of the package body as a black box.

In either the package specification or package body, you can map a package subprogram to an external Java or C subprogram by using a **call specification**, which maps the external subprogram name, parameter types, and return type to their SQL counterparts.

The **AUTHID clause** of the package specification determines whether the subprograms and cursors in the package run with the privileges of their definer (the default) or invoker, and whether their unqualified references to schema objects are resolved in the schema of the definer or invoker.

The **ACCESSIBLE BY clause** of the package specification lets you specify a white list" of PL/SQL units that can access the package. You use this clause in situations like these:

- You implement a PL/SQL application as several packages—one package that provides the application programming interface (API) and helper packages to do the work. You want clients to have access to the API, but not to the helper packages. Therefore, you omit the ACCESSIBLE BY clause from the API package specification and include it in each helper package specification, where you specify that only the API package can access the helper package.
- You create a utility package to provide services to some, but not all, PL/SQL units in the same schema. To restrict use of the package to the intended units, you list them in the ACCESSIBLE BY clause in the package specification.

For information about PL/SQL units, see [Overview of PL/SQL Units](#) (page 13-4).

Note:

Before you create your own package, check *Oracle Database PL/SQL Packages and Types Reference* to see if Oracle supplies a package with the functionality that you need.

See Also:

Oracle Database PL/SQL Language Reference for complete information about PL/SQL packages

13.3 Overview of PL/SQL Units

A PL/SQL unit is one of these:

- PL/SQL anonymous block
- FUNCTION
- LIBRARY
- PACKAGE
- PACKAGE BODY
- PROCEDURE
- TRIGGER
- TYPE
- TYPE BODY

PL/SQL units are affected by PL/SQL compilation parameters (a category of database initialization parameters). Different PL/SQL units—for example, a package specification and its body—can have different compilation parameter settings. For more information about PL/SQL units and compilation parameters, see *Oracle Database PL/SQL Language Reference*.

The AUTHID property of a PL/SQL unit affects the name resolution and privilege checking of SQL statements that the unit issues at runtime. For details, see *Oracle Database PL/SQL Language Reference*.

13.3.1 PLSQL_OPTIMIZE_LEVEL Compilation Parameter

The PL/SQL optimize level determines how much the PL/SQL optimizer can rearrange code for better performance. This level is set with the compilation parameter `PLSQL_OPTIMIZE_LEVEL` (whose default value is 2).

To change the PL/SQL optimize level for your session, use the SQL command `ALTER SESSION`. Changing the level for your session affects only subsequently created PL/SQL units. To change the level for an existing PL/SQL unit, use an `ALTER` command with the `COMPILE` clause.

To display the current value of `PLSQL_OPTIMIZE_LEVEL` for one or more PL/SQL units, use the static data dictionary view `ALL_PLSQL_OBJECT_SETTINGS`.

Example 13-1 (page 13-5) creates two procedures, displays their optimize levels, changes the optimize level for the session, creates a third procedure, and displays the optimize levels of all three procedures. Only the third procedure has the new optimize level. Then the example changes the optimize level for only one procedure and displays the optimize levels of all three procedures again.

See Also:

- *Oracle Database PL/SQL Language Reference* for information about the PL/SQL optimizer
- *Oracle Database Reference* for more information about PLSQL_OPTIMIZE_LEVEL
- *Oracle Database SQL Language Reference* for more information about ALTER SESSION
- *Oracle Database PL/SQL Language Reference* for information about the ALTER commands for PL/SQL units
- *Oracle Database Reference* for more information about ALL_PLSQL_OBJECT_SETTINGS

Example 13-1 Changing PLSQL_OPTIMIZE_LEVEL

Create two procedures:

```
CREATE OR REPLACE PROCEDURE p1 AUTHID DEFINER AS
BEGIN
  NULL;
END;
/
CREATE OR REPLACE PROCEDURE p2 AUTHID DEFINER AS
BEGIN
  NULL;
END;
/
```

Display the optimization levels of the two procedures:

```
SELECT NAME, PLSQL_OPTIMIZE_LEVEL
FROM USER_PLSQL_OBJECT_SETTINGS
WHERE NAME LIKE 'P%' AND TYPE='PROCEDURE'
ORDER BY NAME;
```

Result:

NAME	PLSQL_OPTIMIZE_LEVEL
P1	2
P2	2

2 rows selected.

Change the optimization level for the session and create a third procedure:

```
ALTER SESSION SET PLSQL_OPTIMIZE_LEVEL=1;

CREATE OR REPLACE PROCEDURE p3 AUTHID DEFINER AS
BEGIN
  NULL;
END;
/
```

Display the optimization levels of the three procedures:

```
SELECT NAME, PLSQL_OPTIMIZE_LEVEL
FROM USER_PLSQL_OBJECT_SETTINGS
WHERE NAME LIKE 'P%' AND TYPE='PROCEDURE'
ORDER BY NAME;
```

Result:

NAME	PLSQL_OPTIMIZE_LEVEL
P1	2
P2	2
P3	1

3 rows selected.

Change the optimization level of procedure p1 to 3:

```
ALTER PROCEDURE p1 COMPILE PLSQL_OPTIMIZE_LEVEL=3;
```

Display the optimization levels of the three procedures:

```
SELECT NAME, PLSQL_OPTIMIZE_LEVEL
FROM USER_PLSQL_OBJECT_SETTINGS
WHERE NAME LIKE 'P%' AND TYPE='PROCEDURE'
ORDER BY NAME;
```

Result:

NAME	PLSQL_OPTIMIZE_LEVEL
P1	3
P2	2
P3	1

3 rows selected.

13.4 Creating PL/SQL Subprograms and Packages

Topics:

- [Privileges Needed to Create Subprograms and Packages](#) (page 13-7)
- [Creating Subprograms and Packages](#) (page 13-7)
- [PL/SQL Object Size Limits](#) (page 13-8)
- [PL/SQL Data Types](#) (page 13-8)
- [Returning Result Sets to Clients](#) (page 13-11)
- [Returning Large Amounts of Data from a Function](#) (page 13-16)
- [PL/SQL Function Result Cache](#) (page 13-16)
- [Overview of Bulk Binding](#) (page 13-16)
- [PL/SQL Dynamic SQL](#) (page 13-19)

13.4.1 Privileges Needed to Create Subprograms and Packages

To create a standalone subprogram or package in your own schema, you must have the `CREATE PROCEDURE` system privilege. To create a standalone subprogram or package in another schema, you must have the `CREATE ANY PROCEDURE` system privilege.

If the subprogram or package that you create references schema objects, then you must have the necessary object privileges for those objects. These privileges must be granted to you explicitly, not through roles.

If the privileges of the owner of a subprogram or package change, then the subprogram or package must be reauthenticated before it is run. If a necessary object privilege for a referenced object is revoked from the owner of the subprogram or package, then the subprogram cannot run.

Granting the `EXECUTE` privilege on a subprogram lets users run that subprogram under the security domain of the subprogram owner, so that the user need not be granted privileges to the objects that the subprogram references. The `EXECUTE` privilege allows more disciplined and efficient security strategies for database applications and their users. Furthermore, it allows subprograms and packages to be stored in the data dictionary (in the `SYSTEM` tablespace), where no quota controls the amount of space available to a user who creates subprograms and packages.

See Also:

- *Oracle Database SQL Language Reference* for information about system and object privileges
 - [Invoking Stored PL/SQL Subprograms](#) (page 13-21)
-
-

13.4.2 Creating Subprograms and Packages

This topic explains how to create standalone subprograms and packages, using SQL Data Definition Language (DDL) statements.

The DDL statements for creating standalone subprograms and packages are:

- `CREATE FUNCTION`, described in *Oracle Database PL/SQL Language Reference*
- `CREATE PROCEDURE`, described in *Oracle Database PL/SQL Language Reference*
- `CREATE PACKAGE`, described in *Oracle Database PL/SQL Language Reference*
- `CREATE PACKAGE BODY`, described in *Oracle Database PL/SQL Language Reference*

The name of a package and the names of its public objects must be unique within the package schema. The package specification and body must have the same name. Package constructs must have unique names within the scope of the package, except for overloaded subprograms.

Each of the preceding `CREATE` statements has an optional `OR REPLACE` clause. Specify `OR REPLACE` to re-create an existing PL/SQL unit—that is, to change its declaration or definition without dropping it, re-creating it, and regranteeing object privileges previously granted on it. If you redefine a PL/SQL unit, the database recompiles it.

Caution:

A `CREATE OR REPLACE` statement does not issue a warning before replacing the existing PL/SQL unit.

Using any text editor, create a text file that contains DDL statements for creating any number of subprograms and packages.

To run the DDL statements, use an interactive tool such as SQL*Plus. The SQL*Plus command `START` or `@` runs a script. For example, this SQL*Plus command runs the script `my_app.sql`:

```
@my_app
```

(For information about running scripts in SQL*Plus, see *SQL*Plus User's Guide and Reference*.)

Alternatively, you can create and run the DDL statements using SQL Developer. For information about SQL Developer, see *Oracle SQL Developer User's Guide*.

13.4.3 PL/SQL Object Size Limits

The size limit for PL/SQL stored database objects such as subprograms, triggers, and packages is the size of the Descriptive Intermediate Attributed Notation for Ada (DIANA) code in the shared pool in bytes. The Linux and UNIX limit on the size of the flattened DIANA/code size is 64K but the limit might be 32K on desktop platforms.

The most closely related number that a user can access is `PARSED_SIZE`, a column in the static data dictionary view `*_OBJECT_SIZE`. The column `PARSED_SIZE` gives the size of the DIANA in bytes as stored in the `SYS.IDL_XXX$` tables. This is not the size in the shared pool. The size of the DIANA part of PL/SQL code (used during compilation) is significantly larger in the shared pool than it is in the system table.

See Also:

- *Oracle Database PL/SQL Language Reference* for more information about PL/SQL program limits and `PARSED_SIZE`
 - *Oracle Database Reference* for information about `*_OBJECT_SIZE`
-

13.4.4 PL/SQL Data Types

This topic introduces the PL/SQL data types and refers to other chapters or documents for more information.

Use the correct and most specific PL/SQL data type for each PL/SQL variable in your database application. For the reasons, see [Using the Correct and Most Specific Data Type](#) (page 9-1).

Topics:

- [PL/SQL Scalar Data Types](#) (page 13-9)
- [PL/SQL Composite Data Types](#) (page 13-10)
- [Abstract Data Types](#) (page 13-11)

13.4.4.1 PL/SQL Scalar Data Types

Scalar data types store values that have no internal components.

A scalar data type can have subtypes. A **subtype** is a data type that is a subset of another data type, which is its **base type**. A subtype has the same valid operations as its base type. A data type and its subtypes comprise a **data type family**.

PL/SQL predefines many types and subtypes in the package `STANDARD` and lets you define your own subtypes.

Topics:

- [SQL Data Types](#) (page 13-9)
- [BOOLEAN Data Type](#) (page 13-9)
- [PLS_INTEGER and BINARY_INTEGER Data Types](#) (page 13-9)
- [REF CURSOR Data Type](#) (page 13-10)
- [User-Defined PL/SQL Subtypes](#) (page 13-10)

See Also:

- *Oracle Database PL/SQL Language Reference* for a complete description of scalar PL/SQL data types
 - *Oracle Database PL/SQL Language Reference* for the predefined PL/SQL data types and subtypes, grouped by data type family
-
-

13.4.4.1.1 SQL Data Types

The PL/SQL data types include the SQL data types. For general information about the SQL data types, see *Oracle Database SQL Language Reference*—all information there about data types and subtypes, data type comparison rules, data conversion, literals, and format models applies to both SQL and PL/SQL, except as noted in *Oracle Database PL/SQL Language Reference*.

For information about how to use the SQL data types in database applications, see [Using SQL Data Types in Database Applications](#) (page 9-1).

13.4.4.1.2 BOOLEAN Data Type

The `BOOLEAN` data type stores **logical values**, which are the Boolean values `TRUE` and `FALSE` and the value `NULL`. `NULL` represents an unknown value. For more information about the `BOOLEAN` data type, see *Oracle Database PL/SQL Language Reference*.

13.4.4.1.3 PLS_INTEGER and BINARY_INTEGER Data Types

The PL/SQL data types `PLS_INTEGER` and `BINARY_INTEGER` are identical. For simplicity, this guide uses `PLS_INTEGER` to mean both `PLS_INTEGER` and `BINARY_INTEGER`.

The `PLS_INTEGER` data type stores signed integers in the range -2,147,483,648 through 2,147,483,647, represented in 32 bits.

The `PLS_INTEGER` data type has these advantages over the `NUMBER` data type and `NUMBER` subtypes:

- PLS_INTEGER values require less storage.
- PLS_INTEGER operations use hardware arithmetic, so they are faster than NUMBER operations, which use library arithmetic.

For efficiency, use PLS_INTEGER values for all calculations in its range.

For more information about the PLS_INTEGER data type, see *Oracle Database PL/SQL Language Reference*.

13.4.4.1.4 REF CURSOR Data Type

REF CURSOR is the data type of a cursor variable.

A **cursor variable** is like an explicit cursor, except that:

- It is not limited to one query.
You can open a cursor variable for a query, process the result set, and then use the cursor variable for another query.
- You can assign a value to it.
- You can use it in an expression.
- It can be a subprogram parameter.
You can use cursor variables to pass query result sets between subprograms.
- It can be a host variable.
You can use cursor variables to pass query result sets between PL/SQL stored subprograms and their clients.
- It cannot accept parameters.
You cannot pass parameters to a cursor variable, but you can pass whole queries to it.

A cursor variable has this flexibility because it is a pointer; that is, its value is the address of an item, not the item itself.

For more information about the REF CURSOR data type and cursor variables, see *Oracle Database PL/SQL Language Reference*.

13.4.4.1.5 User-Defined PL/SQL Subtypes

PL/SQL lets you define your own subtypes. The base type can be any scalar PL/SQL type, including a previously defined user-defined subtype.

Subtypes can:

- Provide compatibility with ANSI/ISO data types
- Show the intended use of data items of that type
- Detect out-of-range values

For more information about user-defined PL/SQL subtypes, see *Oracle Database PL/SQL Language Reference*.

13.4.4.2 PL/SQL Composite Data Types

Composite data types have internal components. The PL/SQL composite data types are collections and records.

In a **collection**, the internal components always have the same data type, and are called **elements**. You can access each element of a collection variable by its unique index. PL/SQL has three collection types—associative array, *VARRAY* (variable-size array), and nested table.

In a **record**, the internal components can have different data types, and are called **fields**. You can access each field of a record variable by its name.

You can create a collection of records, and a record that contains collections.

For more information about PL/SQL composite data types, see *Oracle Database PL/SQL Language Reference*.

13.4.4.3 Abstract Data Types

An Abstract Data Type (ADT) consists of a data structure and subprograms that manipulate the data. In the static data dictionary view **_OBJECTS*, the *OBJECT_TYPE* of an ADT is *TYPE*. In the static data dictionary view **_TYPES*, the *TYPECODE* of an ADT is *OBJECT*.

For more information about ADTs, see *Oracle Database PL/SQL Language Reference*.

13.4.5 Returning Result Sets to Clients

In PL/SQL, as in traditional database programming, you use cursors to process query result sets. A **cursor** is a pointer to a private SQL area that stores information about processing a specific *SELECT* or DML statement.

Note:

The cursors that this section discusses are session cursors. A **session cursor** lives in session memory until the session ends, when it ceases to exist. Session cursors are different from the cursors in the private SQL area of the program global area (PGA), which are explained in *Oracle Database Concepts*.

A cursor that is constructed and managed by PL/SQL is an **implicit cursor**. A cursor that you construct and manage is an **explicit cursor**. The only advantage of an explicit cursor over an implicit cursor is that with an explicit cursor, you can limit the number of fetched rows (for details, see *Oracle Database PL/SQL Language Reference*). For general information about cursors, see *Oracle Database PL/SQL Language Reference*. For information about query set result processing with implicit and explicit cursors, see *Oracle Database PL/SQL Language Reference*.

A **cursor variable** is a pointer to a cursor. That is, its value is the address of a cursor, not the cursor itself. Therefore, a cursor variable has more flexibility than an explicit cursor. However, a cursor variable also has costs that an explicit cursor does not.

Topics:

- [Advantages of Cursor Variables](#) (page 13-12)
- [Disadvantages of Cursor Variables](#) (page 13-13)
- [Returning Query Results Implicitly](#) (page 13-15)

See Also:

- *Oracle Database PL/SQL Language Reference* for general information about cursor variables
 - *Oracle Call Interface Programmer's Guide* for information about using cursor variables in OCI
 - *Pro*C/C++ Programmer's Guide* for information about using cursor variables in Pro*C/C++
 - *Pro*COBOL Programmer's Guide* for information about using cursor variables in Pro*COBOL
 - *Oracle Database JDBC Developer's Guide* for information about using cursor variables in JDBC
 - [Returning Large Amounts of Data from a Function](#) (page 13-16)
-
-

13.4.5.1 Advantages of Cursor Variables

A cursor variable is like an explicit cursor except that:

- It is not limited to one query.
You can open a cursor variable for a query, process the result set, and then use the cursor variable for another query.
- You can assign a value to it.
- You can use it in an expression.
- It can be a subprogram parameter.
You can use cursor variables to pass query result sets between subprograms.
- It can be a host variable.
You can use cursor variables to pass query result sets between PL/SQL stored subprograms and their clients.
- It cannot accept parameters.
You cannot pass parameters to a cursor variable, but you can pass whole queries to it. The queries can include variables.

The preceding characteristics give cursor variables these advantages:

- Encapsulation
Queries are centralized in the stored subprogram that opens the cursor variable.
- Easy maintenance
If you must change the cursor, then you must change only the stored subprogram, not every application that invokes the stored subprogram.
- Convenient security

The application connects to the server with the user name of the application user. The application user must have EXECUTE permission on the stored subprogram that opens the cursor, but need not have READ permission on the queried tables.

13.4.5.2 Disadvantages of Cursor Variables

If you need not use a cursor variable, then use an implicit or explicit cursor, for both better performance and ease of programming.

Topics:

- [Parsing Penalty for Cursor Variable](#) (page 13-13)
- [Multiple-Row-Fetching Penalty for Cursor Variable](#) (page 13-14)

Note:

The examples in these topics include TKPROF reports. For instructions for producing TKPROF reports, see *Oracle Database SQL Tuning Guide*.

13.4.5.2.1 Parsing Penalty for Cursor Variable

When you close an explicit cursor, the cursor closes from your perspective—that is, you cannot use it where an open cursor is required—but PL/SQL caches the explicit cursor in an open state. If you reexecute the statement associated with the cursor, then PL/SQL uses the cached cursor, thereby avoiding a parse.

Avoiding a parse can significantly reduce CPU use, and the caching of explicit cursors is transparent to you; it does not affect your programming. PL/SQL does not reduce your supply of available open cursors. If your program must open another cursor but doing so would exceed the init.ora setting of OPEN_CURSORS, then PL/SQL closes cached cursors.

PL/SQL cannot cache a cursor variable in an open state. Therefore, a cursor variable has a parsing penalty.

In [Example 13-2](#) (page 13-13), the procedure opens, fetches from, and closes an explicit cursor and then does the same with a cursor variable. The anonymous block calls the procedure 10 times. The TKPROF report shows that both queries were run 10 times, but the query associated with the explicit cursor was parsed only once, while the query associated with the cursor variable was parsed 10 times.

Example 13-2 Parsing Penalty for Cursor Variable

```
CREATE OR REPLACE PROCEDURE p AUTHID DEFINER IS
  CURSOR e_c IS SELECT * FROM DUAL d1; -- explicit cursor
  c_v SYS_REFCURSOR;                -- cursor variable
  rec DUAL%ROWTYPE;
BEGIN
  OPEN e_c;                          -- explicit cursor
  FETCH e_c INTO rec;
  CLOSE e_c;

  OPEN c_v FOR SELECT * FROM DUAL d2; -- cursor variable
  FETCH c_v INTO rec;
  CLOSE c_v;
END;
/
BEGIN
  FOR i IN 1..10 LOOP
    -- execute p 10 times
```

```

        p;
    END LOOP;

```

TKPROF report is similar to:

```

SELECT * FROM DUAL D1;

```

```

call      count
-----
Parse          1
Execute       10
Fetch         10
-----
total         21
*****

```

```

SELECT * FROM DUAL D2;

```

```

call      count
-----
Parse       10
Execute     10
Fetch       10
-----
total       30

```

13.4.5.2.2 Multiple-Row-Fetching Penalty for Cursor Variable

[Example 13-3](#) (page 13-14) creates a table that has more than 7,000 rows and fetches all of those rows twice, first with an implicit cursor (fetching arrays) and then with a cursor variable (fetching individual rows). The code for the implicit cursor is simpler than the code for the cursor variable, and the TKPROF report shows that it also performs better.

Although you could use the cursor variable to fetch arrays, you would need much more code. Specifically, you would need code to do the following:

- Define the types of the collections into which you will fetch the arrays
- Explicitly bulk collect into the collections
- Loop through the collections to process the fetched data
- Close the explicitly opened cursor variable

Example 13-3 Array Fetching Penalty for Cursor Variable

Create table to query and display its number of rows:

```

CREATE TABLE t AS
  SELECT * FROM ALL_OBJECTS;

SELECT COUNT(*) FROM t;

```

Result is similar to:

```

COUNT(*)
-----
70788

```

Perform equivalent operations with an implicit cursor and a cursor variable:

```

DECLARE
  c_v SYS_REFCURSOR;
  rec t%ROWTYPE;
BEGIN
  FOR x IN (SELECT * FROM t exp_cur) LOOP -- implicit cursor
    NULL;
  END LOOP;

  OPEN c_v FOR SELECT * FROM t cur_var; -- cursor variable

  LOOP
    FETCH c_v INTO rec;
    EXIT WHEN c_v%NOTFOUND;
  END LOOP;

  CLOSE c_v;
END;
/

```

TKPROF report is similar to:

```
SELECT * FROM T EXP_CUR
```

call	count	cpu	elapsed	disk	query	current	rows
Parse	1	0.00	0.00	0	0	0	0
Execute	1	0.00	0.00	0	0	0	0
Fetch	722	0.23	0.23	0	1748	0	72198
total	724	0.23	0.23	0	1748	0	72198

```
*****
SELECT * FROM T CUR_VAR
```

call	count	cpu	elapsed	disk	query	current	rows
Parse	1	0.00	0.00	0	0	0	0
Execute	1	0.00	0.00	0	0	0	0
Fetch	72199	0.40	0.42	0	72203	0	72198
total	72201	0.40	0.42	0	72203	0	72198

13.4.5.3 Returning Query Results Implicitly

A stored subprogram can return a query result implicitly to either the client program or the subprogram's immediate caller by invoking the `DBMS_SQL.RETURN_RESULT` procedure. After `DBMS_SQL.RETURN_RESULT` returns the result, only the recipient can access it. For details, see *Oracle Database PL/SQL Language Reference*.

Note:

To return implicitly the result of a query executed with dynamic SQL, the subprogram must execute the query with `DBMS_SQL` procedures, not the `EXECUTE IMMEDIATE` statement. The reason is that the cursors that the `EXECUTE IMMEDIATE` statement returns to the subprogram are closed when the `EXECUTE IMMEDIATE` statement completes. For information about using `DBMS_SQL` procedures for dynamic SQL, see *Oracle Database PL/SQL Language Reference*.

13.4.6 Returning Large Amounts of Data from a Function

In a data warehousing environment, you might use PL/SQL functions to transform large amounts of data. You might pass the data through a series of transformations, each performed by a different function. PL/SQL table functions let you perform such transformations without significant memory overhead or the need to store the data in tables between each transformation stage. These functions can accept and return multiple rows, can return rows as they are ready rather than all at once, and can be parallelized.

See Also:

Oracle Database PL/SQL Language Reference for more information about performing multiple transformations with pipelined table functions

13.4.7 PL/SQL Function Result Cache

Using the PL/SQL function result cache can save significant space and time. Each time a result-cached PL/SQL function is invoked with different parameter values, those parameters and their result are stored in the cache. Subsequently, when the same function is invoked with the same parameter values, the result is retrieved from the cache, instead of being recomputed. Because the cache is stored in a shared global area (SGA), it is available to any session that runs your application.

If a database object that was used to compute a cached result is updated, the cached result becomes invalid and must be recomputed.

The best candidates for result-caching are functions that are invoked frequently but depend on information that changes infrequently or never.

For more information about the PL/SQL function result cache, see *Oracle Database PL/SQL Language Reference*.

13.4.8 Overview of Bulk Binding

Oracle Database uses two engines to run PL/SQL units. The PL/SQL engine runs the procedural statements and the SQL engine runs the SQL statements. Every SQL statement causes a context switch between the two engines. You can greatly improve the performance of your database application by minimizing the number of context switches for each PL/SQL unit.

When a SQL statement runs inside a loop that uses collection elements as bind variables, the large number of context switches required can cause poor performance. Collections include:

- Associative arrays
- Variable-size arrays
- Nested tables
- Host arrays

Binding is the assignment of values to PL/SQL variables in SQL statements. **Bulk binding** is binding an entire collection at once. Bulk binds pass the entire collection between the two engines in a single operation.

Typically, bulk binding improves performance for SQL statements that affect four or more database rows. The more rows affected by a SQL statement, the greater the performance gain from bulk binding. Consider using bulk binding to improve the performance of DML and `SELECT INTO` statements that reference collections and `FOR` loops that reference collections and return DML.

Note:

Parallel DML statements are disabled with bulk binding. For information about parallel DML statements, see *Oracle Database PL/SQL Language Reference*.

Topics:

- [DML Statements that Reference Collections](#) (page 13-17)
- [SELECT Statements that Reference Collections](#) (page 13-18)
- [FOR Loops that Reference Collections and Return DML](#) (page 13-19)

See Also:

Oracle Database PL/SQL Language Reference for more information about bulk binding, including how to handle exceptions that occur during bulk binding operations

13.4.8.1 DML Statements that Reference Collections

A bulk bind, which uses the `FORALL` keyword, can improve the performance of `INSERT`, `UPDATE`, or `DELETE` statements that reference collection elements.

The PL/SQL block in [Example 13-4](#) (page 13-17) increases the salary for employees whose manager's ID number is 7902, 7698, or 7839, with and without bulk binds. Without bulk bind, PL/SQL sends a SQL statement to the SQL engine for each updated employee, leading to context switches that slow performance.

See Also:

Oracle Database PL/SQL Language Reference for more information about the `FORALL` statement

Example 13-4 DML Statements that Reference Collections

```

DECLARE
  TYPE numlist IS VARRAY (100) OF NUMBER;
  id NUMLIST := NUMLIST(7902, 7698, 7839);
BEGIN
  -- Efficient method, using bulk bind:

  FORALL i IN id.FIRST..id.LAST
    UPDATE EMPLOYEES
      SET SALARY = 1.1 * SALARY
      WHERE MANAGER_ID = id(i);

  -- slower method:

```

```

FOR i IN id.FIRST..id.LAST LOOP
    UPDATE EMPLOYEES
        SET SALARY = 1.1 * SALARY
        WHERE MANAGER_ID = id(i);
END LOOP;
END;
/

```

13.4.8.2 SELECT Statements that Reference Collections

The BULK COLLECT clause can improve the performance of queries that reference collections. You can use BULK COLLECT with tables of scalar values, or tables of %TYPE values.

See Also:

Oracle Database PL/SQL Language Reference for more information about the BULK COLLECT clause

The PL/SQL block in [Example 13-5](#) (page 13-18) queries multiple values into PL/SQL tables, with and without bulk binds. Without bulk bind, PL/SQL sends a SQL statement to the SQL engine for each selected employee, leading to context switches that slow performance.

Example 13-5 *SELECT Statements that Reference Collections*

```

DECLARE
    TYPE var_tab IS TABLE OF VARCHAR2(20)
        INDEX BY PLS_INTEGER;

    empno    VAR_TAB;
    ename    VAR_TAB;
    counter  NUMBER;

    CURSOR c IS
        SELECT EMPLOYEE_ID, LAST_NAME
        FROM EMPLOYEES
        WHERE MANAGER_ID = 7698;
BEGIN
    -- Efficient method, using bulk bind:

    SELECT EMPLOYEE_ID, LAST_NAME BULK COLLECT
    INTO empno, ename
    FROM EMPLOYEES
    WHERE MANAGER_ID = 7698;

    -- Slower method:

    counter := 1;

    FOR rec IN c LOOP
        empno(counter) := rec.EMPLOYEE_ID;
        ename(counter) := rec.LAST_NAME;
        counter := counter + 1;
    END LOOP;
END;
/

```

13.4.8.3 FOR Loops that Reference Collections and Return DML

You can use the `FORALL` keyword with the `BULK COLLECT` keywords to improve the performance of `FOR` loops that reference collections and return DML.

See Also:

Oracle Database PL/SQL Language Reference for more information about use the `BULK COLLECT` clause with the `RETURNING INTO` clause

The PL/SQL block in [Example 13-6](#) (page 13-19) updates the `EMPLOYEES` table by computing bonuses for a collection of employees. Then it returns the bonuses in a column called `bonus_list_inst`. The actions are performed with and without bulk binds. Without bulk bind, PL/SQL sends a SQL statement to the SQL engine for each updated employee, leading to context switches that slow performance.

Example 13-6 FOR Loops that Reference Collections and Return DML

```

DECLARE
    TYPE emp_list IS VARRAY(100) OF EMPLOYEES.EMPLOYEE_ID%TYPE;
    empids emp_list := emp_list(182, 187, 193, 200, 204, 206);

    TYPE bonus_list IS TABLE OF EMPLOYEES.SALARY%TYPE;
    bonus_list_inst bonus_list;

BEGIN
    -- Efficient method, using bulk bind:

    FORALL i IN empids.FIRST..empids.LAST
    UPDATE EMPLOYEES
    SET SALARY = 0.1 * SALARY
    WHERE EMPLOYEE_ID = empids(i)
    RETURNING SALARY BULK COLLECT INTO bonus_list_inst;

    -- Slower method:

    FOR i IN empids.FIRST..empids.LAST LOOP
        UPDATE EMPLOYEES
        SET SALARY = 0.1 * SALARY
        WHERE EMPLOYEE_ID = empids(i)
        RETURNING SALARY INTO bonus_list_inst(i);
    END LOOP;
END;
/

```

13.4.9 PL/SQL Dynamic SQL

Dynamic SQL is a programming methodology for generating and running SQL statements at runtime. It is useful when writing general-purpose and flexible programs like dynamic query systems, when writing programs that must run database definition language (DDL) statements, or when you do not know at compile time the full text of a SQL statement or the number or data types of its input and output variables.

If you do not need dynamic SQL, then use static SQL, which has these advantages:

- Successful compilation verifies that static SQL statements reference valid database objects and that the necessary privileges are in place to access those objects.

- Successful compilation creates schema object dependencies.

For information about schema object dependency, see [Understanding Schema Object Dependency](#) (page 26-1).

For information about dynamic SQL, see *Oracle Database PL/SQL Language Reference*.

For information about static SQL, see *Oracle Database PL/SQL Language Reference*.

13.5 Altering PL/SQL Subprograms and Packages

To alter the name of a stored standalone subprogram or package, you must drop it (as instructed in [Dropping PL/SQL Subprograms and Packages](#) (page 13-20)) and then create it with the new name. For example:

```
CREATE PROCEDURE p IS BEGIN NULL; END;
/
DROP PROCEDURE p
/
CREATE PROCEDURE p1 IS BEGIN NULL; END;
/
```

To alter a stored standalone subprogram or package without changing its name, you can replace it with a new version with the same name by including `OR REPLACE` in the `CREATE` statement. For example:

```
CREATE OR REPLACE PROCEDURE p1 IS
BEGIN
    DBMS_OUTPUT.PUT_LINE('Hello, world!');
END;
/
```

Note:

`ALTER` statements (such as `ALTER FUNCTION`, `ALTER PROCEDURE`, and `ALTER PACKAGE`) do not alter the declarations or definitions of existing PL/SQL units, they recompile only the units. For information about `ALTER` statements, see *Oracle Database PL/SQL Language Reference*.

13.6 Deprecating Packages, Subprograms, and Types

As of Oracle Database 12c Release 2 (12.2), you can use the `DEPRECATE` pragma to communicate that a package, subprogram, or type has been deprecated or superseded by a new interface. When a unit is compiled that makes a reference to a deprecated element, a compilation warning is issued. To mark a PL/SQL unit as deprecated, use the `DEPRECATE` pragma described in *Oracle Database PL/SQL Language Reference*.

13.7 Dropping PL/SQL Subprograms and Packages

To drop stored standalone subprograms, use these statements:

- `DROP FUNCTION`, described in *Oracle Database PL/SQL Language Reference*
- `DROP PROCEDURE`, described in *Oracle Database PL/SQL Language Reference*

To drop a package (specification and body) or only its body, use the statement `DROP PACKAGE`, described in *Oracle Database PL/SQL Language Reference*.

13.8 Compiling PL/SQL Units for Native Execution

You can usually speed up PL/SQL units—your own and those that Oracle supplies—by compiling them into native code (processor-dependent system code), which is stored in the SYSTEM tablespace.

PL/SQL units compiled into native code run in all server environments, including the shared server configuration (formerly called "multithreaded server") and Oracle Real Application Clusters (Oracle RAC).

Whether to compile a PL/SQL unit into native code depends on where you are in the development cycle and what the PL/SQL unit does.

For more information about compiling PL/SQL units for native execution, see *Oracle Database PL/SQL Language Reference*.

Note:

To compile Java packages and classes for native execution, use the `ncomp` tool. For more information, see *Oracle Database Java Developer's Guide*.

13.9 Invoking Stored PL/SQL Subprograms

Stored PL/SQL subprograms can be invoked from many different environments. For example:

- Interactively, using an Oracle Database tool
- From the body of another subprogram
- From the body of a trigger
- From within an application (such as a SQL*Forms or a precompiler)

Stored PL/SQL functions (but not procedures) can also be invoked from within SQL statements. For details, see [Invoking Stored PL/SQL Functions from SQL Statements](#) (page 13-28).

When you invoke a subprogram owned by another user:

- You must include the name of the owner in the invocation. For example:

```
EXECUTE jdoe.Fire_emp (1043);
EXECUTE jdoe.Hire_fire.Fire_emp (1043);
```

- The `AUTHID` property of the subprogram affects the name resolution and privilege checking of SQL statements that the subprogram issues at runtime. For details, see *Oracle Database PL/SQL Language Reference*.

Topics:

- [Privileges Required to Invoke a Stored Subprogram](#) (page 13-22)
- [Invoking a Subprogram Interactively from Oracle Tools](#) (page 13-22)
- [Invoking a Subprogram from Another Subprogram](#) (page 13-24)
- [Invoking a Remote Subprogram](#) (page 13-25)

See Also:

- *Oracle Database PL/SQL Language Reference* for information about subprogram invocation, parameters, and definer's and invoker's rights
 - *Oracle Database PL/SQL Language Reference* for information about coding the body of a trigger
 - [Invoking Stored PL/SQL Functions from SQL Statements](#) (page 13-28)
 - *Oracle Call Interface Programmer's Guide* for information about invoking PL/SQL subprograms from OCI applications
 - *Pro*C/C++ Programmer's Guide* for information about invoking PL/SQL subprograms from Pro*C/C++
 - *Pro*COBOL Programmer's Guide* for information about invoking PL/SQL subprograms from Pro*COBOL
 - *Oracle Database JDBC Developer's Guide* for information about invoking PL/SQL subprograms from JDBC applications
-
-

13.9.1 Privileges Required to Invoke a Stored Subprogram

You do not need privileges to invoke:

- Standalone subprograms that you own
- Subprograms in packages that you own
- Public standalone subprograms
- Subprograms in public packages

To invoke a stored subprogram owned by another user, you must have the EXECUTE privilege for the standalone subprogram or for the package containing the package subprogram, or you must have the EXECUTE ANY PROCEDURE system privilege. If the subprogram is remote, then you must be granted the EXECUTE privilege or EXECUTE ANY PROCEDURE system privilege directly, not through a role.

See Also:

Oracle Database SQL Language Reference for information about system and object privileges

13.9.2 Invoking a Subprogram Interactively from Oracle Tools

You can invoke a subprogram interactively from an Oracle Database tool, such as SQL*Plus.

See Also:

- *SQL*Plus User's Guide and Reference* for information about the EXECUTE command
- Your tools documentation for information about performing similar operations using your development tool

[Example 13-7](#) (page 13-23) uses SQL*Plus to create a procedure and then invokes it in two different ways.

Some interactive tools allow you to create session variables, which you can use for the duration of the session. Using SQL*Plus, [Example 13-8](#) (page 13-23) creates, uses, and prints a session variable.

Example 13-7 Invoking a Subprogram Interactively with SQL*Plus

```
CREATE OR REPLACE PROCEDURE salary_raise (
  employee EMPLOYEES.EMPLOYEE_ID%TYPE,
  increase EMPLOYEES.SALARY%TYPE
)
IS
BEGIN
  UPDATE EMPLOYEES
  SET SALARY = SALARY + increase
  WHERE EMPLOYEE_ID = employee;
END;
/
```

Invoke procedure from within anonymous block:

```
BEGIN
  salary_raise(205, 200);
END;
/
```

Result:

PL/SQL procedure successfully completed.

Invoke procedure with EXECUTE statement:

```
EXECUTE salary_raise(205, 200);
```

Result:

PL/SQL procedure successfully completed.

Example 13-8 Creating and Using a Session Variable with SQL*Plus

```
-- Create function for later use:
```

```
CREATE OR REPLACE FUNCTION get_job_id (
  emp_id EMPLOYEES.EMPLOYEE_ID%TYPE
) RETURN EMPLOYEES.JOB_ID%TYPE
IS
  job_id EMPLOYEES.JOB_ID%TYPE;
```

```

BEGIN
  SELECT JOB_ID INTO job_id
  FROM EMPLOYEES
  WHERE EMPLOYEE_ID = emp_id;

  RETURN job_id;
END;
/
-- Create session variable:

VARIABLE job VARCHAR2(10);

-- Run function and store returned value in session variable:

EXECUTE :job := get_job_id(204);

PL/SQL procedure successfully completed.

```

SQL*Plus command:

```
PRINT job;
```

Result:

```

JOB
-----
PR_REP

```

13.9.3 Invoking a Subprogram from Another Subprogram

A subprogram or a trigger can invoke another stored subprogram. In [Example 13-9](#) (page 13-24), the procedure `print_mgr_name` invokes the procedure `print_emp_name`.

Recursive subprogram invocations are allowed (that is, a subprogram can invoke itself).

Example 13-9 Invoking a Subprogram from Within Another Subprogram

```
-- Create procedure that takes employee's ID and prints employee's name:
```

```

CREATE OR REPLACE PROCEDURE print_emp_name (
  emp_id EMPLOYEES.EMPLOYEE_ID%TYPE
)
IS
  fname EMPLOYEES.FIRST_NAME%TYPE;
  lname EMPLOYEES.LAST_NAME%TYPE;
BEGIN
  SELECT FIRST_NAME, LAST_NAME
  INTO fname, lname
  FROM EMPLOYEES
  WHERE EMPLOYEE_ID = emp_id;

  DBMS_OUTPUT.PUT_LINE (
    'Employee #' || emp_id || ': ' || fname || ' ' || lname
  );
END;
/

```

```
-- Create procedure that takes employee's ID and prints manager's name:
```



```

CREATE OR REPLACE PROCEDURE print_mgr_name (
    emp_id EMPLOYEES.EMPLOYEE_ID%TYPE
)
IS
    mgr_id EMPLOYEES.MANAGER_ID%TYPE;
BEGIN
    SELECT MANAGER_ID
    INTO mgr_id
    FROM EMPLOYEES
    WHERE EMPLOYEE_ID = emp_id;

    DBMS_OUTPUT.PUT_LINE (
        'Manager of employee #' || emp_id || ' is: '
    );

    print_emp_name(mgr_id);
END;
/

```

Invoke procedures:

```

BEGIN
    print_emp_name(200);
    print_mgr_name(200);
END;
/

```

Result:

```

Employee #200: Jennifer Whalen
Manager of employee #200 is:
Employee #101: Neena Kochhar

```

13.9.4 Invoking a Remote Subprogram

A **remote subprogram** is stored on a different database from its invoker. A remote subprogram invocation must include the subprogram name, a database link to the database on which the subprogram is stored, and an actual parameter for every formal parameter (even if the formal parameter has a default value).

For example, this SQL*Plus statement invokes the stored standalone procedure `fire_emp1`, which is referenced by the local database link named `boston_server`:

```
EXECUTE fire_emp1@boston_server(1043);
```

Note:

Although you can invoke remote package subprograms, you cannot directly access remote package variables and constants.

Caution:

- Remote subprogram invocations use runtime binding. The user account to which you connect depends on the database link. (Stored subprograms use compile-time binding.)
 - If a local subprogram invokes a remote subprogram, and a time-stamp mismatch is found during execution of the local subprogram, then the remote subprogram is not run, and the local subprogram is invalidated. For more information, see [Dependencies Among Local and Remote Database Procedures](#) (page 26-12).
-

Topics:

- [Synonyms for Remote Subprograms](#) (page 13-26)
 - [Transactions That Invoke Remote Subprograms](#) (page 13-27)
-

See Also:

- [Dependencies Among Local and Remote Database Procedures](#) (page 26-12)
 - *Oracle Database PL/SQL Language Reference* for information about handling errors in subprograms
-

13.9.4.1 Synonyms for Remote Subprograms

A **synonym** is an alias for a schema object. You can create a synonym for a remote subprogram name and database link, and then use the synonym to invoke the subprogram. For example:

```
CREATE SYNONYM synonym1 for fire_emp1@boston_server;  
EXECUTE synonym1(1043);
```

Note:

You cannot create a synonym for a package subprogram, because it is not a schema object (its package is a schema object).

Synonyms provide both data independence and location transparency. Using the synonym, a user can invoke the subprogram without knowing who owns it or where it is. However, a synonym is not a substitute for privileges—to use the synonym to invoke the subprogram, the user still needs the necessary privileges for the subprogram.

Granting a privilege on a synonym is equivalent to granting the privilege on the base object. Similarly, granting a privilege on a base object is equivalent to granting the privilege on all synonyms for the object.

You can create both private and public synonyms. A private synonym is in your schema and you control its availability to others. A public synonym belongs to the user group PUBLIC and is available to every database user.

Use public synonyms sparingly because they make database consolidation more difficult (for an example, see *Oracle Database Concepts*).

If you do not want to use a synonym, you can create a local subprogram to invoke the remote subprogram. For example:

```
CREATE OR REPLACE PROCEDURE local_procedure
  (arg IN NUMBER)
AS
BEGIN
  fire_empl@boston_server(arg);
END;
/
DECLARE
  arg NUMBER;
BEGIN
  local_procedure(arg);
END;
/
```

See Also:

- *Oracle Database Concepts* for general information about synonyms
 - *Oracle Database SQL Language Reference* for information about the CREATE SYNONYM statement
 - *Oracle Database SQL Language Reference* for information about the GRANT statement
-

13.9.4.2 Transactions That Invoke Remote Subprograms

A remote subprogram invocation is assumed to update a database. Therefore, a transaction that invokes a remote subprogram requires a two-phase commit (even if the remote subprogram does not update a database). If the transaction is rolled back, then the work done by the remote subprogram is also rolled back.

With respect to the statements COMMIT, ROLLBACK, and SAVEPOINT, a remote subprogram differs from a local subprogram in these ways:

- If the transaction starts on a database that is not an Oracle database, then the remote subprogram cannot run these statements.

This situation can occur in Oracle XA applications, which are not recommended. For details, see [Developing Applications with Oracle XA](#) (page 22-1).

- After running one of these statements, the remote subprogram cannot start its own distributed transactions.

A **distributed transaction** updates two or more databases. Statements in the transaction are sent to the different databases, and the transaction succeeds or fails as a unit. If the transaction fails on any database, then it must be rolled back (either to a savepoint or completely) on all databases. Consider this when creating subprograms that perform distributed updates.

- If the remote subprogram does not commit or roll back its work, then the work is implicitly committed when the database link is closed. Until then, the remote subprogram is considered to be performing a transaction. Therefore, further invocations to the remote subprogram are not allowed.

13.10 Invoking Stored PL/SQL Functions from SQL Statements

Caution:

Because SQL is a declarative language, rather than an imperative (or procedural) one, you cannot know how many times a function invoked by a SQL statement will run—even if the function is written in PL/SQL, an imperative language.

If your application requires that a function be executed a certain number of times, do not invoke that function from a SQL statement. Use a cursor instead.

For example, if your application requires that a function be called for each selected row, then open a cursor, select rows from the cursor, and call the function for each row. This technique guarantees that the number of calls to the function is the number of rows fetched from the cursor.

For general information about cursors, see *Oracle Database PL/SQL Language Reference*.

These SQL statements can invoke PL/SQL stored functions:

- INSERT
- UPDATE
- DELETE
- SELECT

(SELECT can also invoke a PL/SQL function declared and defined in its WITH clause. For more information, see *Oracle Database SQL Language Reference*.)

- CALL

(CALL can also invoke a PL/SQL stored procedure.)

To invoke a PL/SQL function from a SQL statement, you must either own or have the EXECUTE privilege on the function. To select from a view defined with a PL/SQL function, you must have READ or SELECT privilege on the view. No separate EXECUTE privileges are needed to select from the view.

Note:

The AUTHID property of the PL/SQL function can also affect the privileges that you need to invoke the function from a SQL statement, because AUTHID affects the name resolution and privilege checking of SQL statements that the unit issues at runtime. For details, see *Oracle Database PL/SQL Language Reference*.

For general information about invoking subprograms, including passing parameters, see *Oracle Database PL/SQL Language Reference*.

Topics:

- [Why Invoke PL/SQL Functions from SQL Statements?](#) (page 13-29)
- [Where PL/SQL Functions Can Appear in SQL Statements](#) (page 13-29)
- [When PL/SQL Functions Can Appear in SQL Expressions](#) (page 13-30)
- [Controlling Side Effects of PL/SQL Functions Invoked from SQL Statements](#) (page 13-30)

13.10.1 Why Invoke PL/SQL Functions from SQL Statements?

Invoking PL/SQL functions in SQL statements can:

- Increase user productivity by extending SQL
Expressiveness of the SQL statement increases where activities are too complex, too awkward, or unavailable with SQL.
- Increase query efficiency
Functions in the `WHERE` clause of a query can filter data using criteria that must otherwise be evaluated by the application.
- Manipulate character strings to represent special data types (for example, latitude, longitude, or temperature)
- Provide parallel query execution
If the query is parallelized, then SQL statements in your PL/SQL subprogram might also run in parallel (using the parallel query option).

13.10.2 Where PL/SQL Functions Can Appear in SQL Statements

A PL/SQL function can appear in a SQL statement wherever a SQL function or an expression can appear in a SQL statement. For example:

- Select list of the `SELECT` statement
- Condition of the `WHERE` or `HAVING` clause
- `CONNECT BY`, `START WITH`, `ORDER BY`, or `GROUP BY` clause
- `VALUES` clause of the `INSERT` statement
- `SET` clause of the `UPDATE` statement

A PL/SQL table function (which returns a collection of rows) can appear in a `SELECT` statement instead of:

- Column name in the `SELECT` list
- Table name in the `FROM` clause

A PL/SQL function cannot appear in these contexts, which require unchanging definitions:

- `CHECK` constraint clause of a `CREATE` or `ALTER TABLE` statement
- Default value specification for a column

13.10.3 When PL/SQL Functions Can Appear in SQL Expressions

To be invoked from a SQL expression, a PL/SQL function must satisfy these requirements:

- It must be either a user-defined aggregate function or a row function.
- Its formal parameters must be IN parameters, not OUT or IN OUT parameters.

The function in [Example 13-10](#) (page 13-30) satisfies the preceding requirements.

Example 13-10 PL/SQL Function in SQL Expression (Follows Rules)

```
DROP TABLE payroll; -- in case it exists
CREATE TABLE payroll (
  srate NUMBER,
  orate NUMBER,
  acctno NUMBER
);

CREATE OR REPLACE FUNCTION gross_pay (
  emp_id IN NUMBER,
  st_hrs IN NUMBER := 40,
  ot_hrs IN NUMBER := 0
) RETURN NUMBER
IS
  st_rate NUMBER;
  ot_rate NUMBER;
BEGIN
  SELECT srate, orate
  INTO st_rate, ot_rate
  FROM payroll
  WHERE acctno = emp_id;

  RETURN st_hrs * st_rate + ot_hrs * ot_rate;
END gross_pay;
/
```

13.10.4 Controlling Side Effects of PL/SQL Functions Invoked from SQL Statements

A subprogram has **side effects** if it changes anything except the values of its own local variables. For example, a subprogram that changes any of the following has side effects:

- Its own OUT or IN OUT parameter
- A global variable
- A public variable in a package
- A database table
- The database
- The external state (by invoking DBMS_OUTPUT or sending e-mail, for example)

Side effects can prevent the parallelization of a query, yield order-dependent (and therefore, indeterminate) results, or require that package state be maintained across user sessions.

Some side effects are not allowed in a function invoked from a SQL query or DML statement.

Before Oracle Database 8g Release 1 (8.1), application developers used `PRAGMA RESTRICT_REFERENCES` to assert the **purity** (freedom from side effects) of a function. This pragma remains available for backward compatibility, but do not use it in new applications. Instead, specify the optimizer hints `DETERMINISTIC` and `PARALLEL_ENABLE` when you create the function. For information about `DETERMINISTIC` and `PARALLEL_ENABLE`, see *Oracle Database PL/SQL Language Reference*.

Topics:

- [Restrictions on Functions Invoked from SQL Statements](#) (page 13-31)
- [PL/SQL Functions Invoked from Parallelized SQL Statements](#) (page 13-32)
- [PRAGMA RESTRICT_REFERENCES](#) (page 13-32) (deprecated)

13.10.4.1 Restrictions on Functions Invoked from SQL Statements

Note:

The restrictions on functions invoked from SQL statements also apply to triggers fired by SQL statements.

If a SQL statement invokes a function, and the function runs a new SQL statement, then the execution of the new statement is logically embedded in the context of the statement that invoked the function. To ensure that the new statement is safe in this context, Oracle Database enforces these restrictions on the function:

- If the SQL statement that invokes the function is a query or DML statement, then the function cannot end the current transaction, create or rollback to a savepoint, or `ALTER` the system or session.
- If the SQL statement that invokes the function is a query or parallelized DML statement, then the function cannot run a DML statement or otherwise modify the database.
- If the SQL statement that invokes the function is a DML statement, then the function can neither read nor modify the table being modified by the SQL statement that invoked the function.

The restrictions apply regardless of how the function runs the new SQL statement. For example, they apply to new SQL statements that the function:

- Invokes from PL/SQL, whether embedded directly in the function body, run using the `EXECUTE IMMEDIATE` statement, or run using the `DBMS_SQL` package
- Runs using JDBC
- Runs with OCI using the callback context from within an external C function

To avoid these restrictions, ensure that the execution of the new SQL statement is not logically embedded in the context of the SQL statement that invokes the function. For example, put the new SQL statement in an autonomous transaction or, in OCI, create a new connection for the external C function rather than using the handle provided by

the `OCIExtProcContext` argument. For information about autonomous transactions, see [Autonomous Transactions](#) (page 8-38).

13.10.4.2 PL/SQL Functions Invoked from Parallelized SQL Statements

When Oracle Database runs a **parallelized** SQL statement, multiple processes work simultaneously to run the single SQL statement. When a parallelized SQL statement invokes a function, each process might invoke its own copy of the function, for only the subset of rows that the process handles.

Each process has its own copy of package variables. When parallel execution begins, the package variables are initialized for each process as if a user were logging into the system; the package variable values are not copied from the original login session. Changes that one process makes to package variables do not automatically propagate to the other processes or to the original login session. Java `STATIC` class attributes are similarly initialized and modified independently in each process. A function can use package and Java `STATIC` variables to accumulate a value across the various rows that it encounters. Therefore, Oracle Database does not parallelize the execution of user-defined functions by default.

Before Oracle Database 8g Release 1 (8.1):

- If a parallelized query invoked a user-defined function, then the execution of the function could be parallelized if `PRAGMA RESTRICT_REFERENCES` asserted both `RNPS` and `WNPS` for the function—that is, that the function neither referenced package variables nor changed their values.

Without this assertion, the execution of a standalone PL/SQL function (but not a C or Java function) could be parallelized if Oracle Database determined that the function neither referenced package variables nor changed their values.

- If a parallelized DML statement invoked a user-defined function, then the execution of the function could be parallelized if `PRAGMA RESTRICT_REFERENCES` asserted `RNDS`, `WNDS`, `RNPS` and `WNPS` for the function—that is, that the function neither referenced nor changed the values of either package variables or database tables.

Without this assertion, the execution of a standalone PL/SQL function (but not a C or Java function) could be parallelized if Oracle Database determined that the function neither referenced nor changed the values of either package variables or database tables.

As of Oracle Database 8g Release 1 (8.1), if a parallelized SQL statement invokes a user-defined function, then the execution of a function can be parallelized in these situations:

- The function was created with `PARALLEL_ENABLE`.
- Before Oracle Database 8g Release 1 (8.1), the database recognized the function as parallelizable.

13.10.4.3 PRAGMA RESTRICT_REFERENCES

Note:

`PRAGMA RESTRICT_REFERENCES` is deprecated. In new applications, Oracle recommends using `DETERMINISTIC` and `PARALLEL_ENABLE` (explained in *Oracle Database SQL Language Reference*) instead of `RESTRICT_REFERENCES`.

In existing PL/SQL applications, you can either remove `PRAGMA RESTRICT_REFERENCES` or continue to use it, even with new functionality, to ease integration with the existing code. For example:

- When it is impossible or impractical to completely remove `PRAGMA RESTRICT_REFERENCES` from existing code.
For example, if subprogram S1 depends on subprogram S2, and you do not remove the pragma from S1, then you might need the pragma in S2 to compile S1.
- When replacing `PRAGMA RESTRICT_REFERENCES` with `PARALLEL_ENABLE` and `DETERMINISTIC` in existing code would negatively affect the action of new, dependent code.

To use `PRAGMA RESTRICT_REFERENCES` to assert the purity of a function: In the package specification (not the package body), anywhere after the function declaration, use this syntax:

```
PRAGMA RESTRICT_REFERENCES (function_name, assertion [, assertion]... );
```

Where *assertion* is one of the following:

Assertion	Meaning
RNPS	The function reads no package state (does not reference the values of package variables)
WNPS	The function writes no package state (does not change the values of package variables).
RNDS	The function reads no database state (does not query database tables).
WNDS	The function writes no database state (does not modify database tables).
TRUST	Trust that no SQL statement in the function body violates any assertion made for the function. For more information, see Specifying the Assertion TRUST (page 13-34).

If you do not specify `TRUST`, and a SQL statement in the function body violates an assertion that you do specify, then the PL/SQL compiler issues an error message when it parses a violating statement.

Assert the highest purity level (the most assertions) that the function allows, so that the PL/SQL compiler never rejects the function unnecessarily.

Note:

If the function invokes subprograms, then either specify `PRAGMA RESTRICT_REFERENCES` for those subprograms also or specify `TRUST` in either the invoking function or the invoked subprograms.

See Also:

Oracle Database PL/SQL Language Reference for more information about `PRAGMA RESTRICT_REFERENCES`

Topics:

- [Specifying the Assertion TRUST](#) (page 13-34)
- [Differences between Static and Dynamic SQL Statements](#) (page 13-35)

13.10.4.3.1 Example: PRAGMA RESTRICT_REFERENCES

You can use the `PRAGMA RESTRICT_REFERENCES` clause when you create a PL/SQL package.

[Example 13-11](#) (page 13-34) creates a function that neither reads nor writes database or package state, and asserts that it has the maximum purity level.

Example 13-11 PRAGMA RESTRICT_REFERENCES

```

DROP TABLE accounts; -- in case it exists
CREATE TABLE accounts (
  acctno  INTEGER,
  balance NUMBER
);

INSERT INTO accounts (acctno, balance)
VALUES (12345, 1000.00);

CREATE OR REPLACE PACKAGE finance AS
  FUNCTION compound_ (
    years  IN NUMBER,
    amount IN NUMBER,
    rate   IN NUMBER
  ) RETURN NUMBER;
  PRAGMA RESTRICT_REFERENCES (compound_, WNDS, WNPS, RNDS, RNPS);
END finance;
/
CREATE PACKAGE BODY finance AS
  FUNCTION compound_ (
    years  IN NUMBER,
    amount IN NUMBER,
    rate   IN NUMBER
  ) RETURN NUMBER
  IS
  BEGIN
    RETURN amount * POWER((rate / 100) + 1, years);
  END compound_;
  -- No pragma in package body
END finance;
/
DECLARE
  interest NUMBER;
BEGIN
  SELECT finance.compound_(5, 1000, 6)
  INTO interest
  FROM accounts
  WHERE acctno = 12345;
END;
/

```

13.10.4.3.2 Specifying the Assertion TRUST

When `PRAGMA RESTRICT_REFERENCES` specifies `TRUST`, the PL/SQL compiler does not check the subprogram body for violations.

TRUST makes it easier for a subprogram that uses PRAGMA RESTRICT REFERENCES to invoke subprograms that do not use it.

If your PL/SQL subprogram invokes a C or Java subprogram, then you must specify TRUST for either the PL/SQL subprogram (as in [Example 13-12](#) (page 13-35)) or the C or Java subprogram (as in [Example 13-13](#) (page 13-35)), because the PL/SQL compiler cannot check a C or Java subprogram for violations at runtime.

Example 13-12 PRAGMA RESTRICT REFERENCES with TRUST on Invoker

```
CREATE OR REPLACE PACKAGE p IS
  PROCEDURE java_sleep (milli_seconds IN NUMBER)
  AS LANGUAGE JAVA NAME 'java.lang.Thread.sleep(long)';

  FUNCTION f (n NUMBER) RETURN NUMBER;
  PRAGMA RESTRICT_REFERENCES(f,WNDS,TRUST);
END p;
/
CREATE OR REPLACE PACKAGE BODY p IS
  FUNCTION f (
    n NUMBER
  ) RETURN NUMBER
  IS
  BEGIN
    java_sleep(n);
    RETURN n;
  END f;
END p;
/
```

Example 13-13 PRAGMA RESTRICT REFERENCES with TRUST on Invokee

```
CREATE OR REPLACE PACKAGE p IS
  PROCEDURE java_sleep (milli_seconds IN NUMBER)
  AS LANGUAGE JAVA NAME 'java.lang.Thread.sleep(long)';
  PRAGMA RESTRICT_REFERENCES(java_sleep,WNDS,TRUST);

  FUNCTION f (n NUMBER) RETURN NUMBER;
END p;
/
CREATE OR REPLACE PACKAGE BODY p IS
  FUNCTION f (
    n NUMBER
  ) RETURN NUMBER
  IS
  BEGIN
    java_sleep(n);
    RETURN n;
  END f;
END p;
/
```

13.10.4.3.3 Differences Between Static and Dynamic SQL Statements

A static INSERT, UPDATE, or DELETE statement does not violate RNDS if it does not explicitly read a database state (such as a table column). A dynamic INSERT, UPDATE, or DELETE statement always violate RNDS, regardless of whether it explicitly reads a database state.

The following INSERT statement violates RNDS if it is executed dynamically, but not if it is executed statically:

```
INSERT INTO my_table values(3, 'BOB');
```

The following UPDATE statement always violates RNDS, whether it is executed statically or dynamically, because it explicitly reads the column name of my_table:

```
UPDATE my_table SET id=777 WHERE name='BOB';
```

13.11 Analyzing and Debugging Stored Subprograms

To compile a stored subprogram, you must fix any syntax errors in the code. To ensure that the subprogram works correctly, performs well, and recovers from errors, you might need to do additional debugging. Such debugging might involve:

- Adding extra output statements to verify execution progress and check data values at certain points within the subprogram.

To output the value of variables and expressions, use the `PUT` and `PUT_LINE` subprograms in the Oracle package `DBMS_OUTPUT`, described in *Oracle Database PL/SQL Packages and Types Reference*.

- Analyzing the program and its execution in greater detail by running `PL/Scope`, the PL/SQL hierarchical profiler, or a debugger

Topics:

- [PL/Scope](#) (page 13-36)
- [PL/SQL Hierarchical Profiler](#) (page 13-36)
- [Debugging PL/SQL and Java](#) (page 13-37)

See Also:

- *Oracle Database PL/SQL Language Reference* for information about handling errors in PL/SQL subprograms and packages
-
-

13.11.1 PL/Scope

PL/Scope lets you develop powerful and effective PL/Scope source code tools that increase PL/SQL developer productivity by minimizing time spent browsing and understanding source code.

For more information about PL/Scope, see [Using PL/Scope](#) (page 14-1).

13.11.2 PL/SQL Hierarchical Profiler

The PL/SQL hierarchical profiler reports the dynamic execution profile of your PL/SQL program, organized by subprogram calls. It accounts for SQL and PL/SQL execution times separately. Each subprogram-level summary in the dynamic execution profile includes information such as number of calls to the subprogram, time spent in the subprogram itself, time spent in the subprogram subtree (that is, in its descendent subprograms), and detailed parent-children information.

You can browse the generated HTML reports in any browser. The browser's navigational capabilities, combined with well chosen links, provide a powerful way to analyze performance of large applications, improve application performance, and lower development costs.

For a detailed description of PL/SQL hierarchical profiler, see [Using the PL/SQL Hierarchical Profiler](#) (page 15-1).

13.11.3 Debugging PL/SQL and Java

PL/SQL and Java code in the database can be debugged using Oracle SQL Developer, Oracle JDeveloper, and various third-party tools. The DBMS_DEBUG_JDWP package is used to establish connections between a database session and these debugger programs.

It is possible to investigate a problem occurring in a long running test, or in a production environment by connecting to the session to debug from another session. While debugging a session, it is possible to inspect the state of in-scope variables and to examine the database state as the session being debugged sees it during an uncommitted transaction. When stopped at a breakpoint, it is possible for the debugging user to issue SQL commands, and run PL/SQL code invoking stored PL/SQL subprograms in an anonymous block if necessary.

See Also:

- *Oracle SQL Developer User's Guide* for more information about running and debugging functions and procedures
 - *Oracle Database Java Developer's Guide* for information about using the Java Debug Wire Protocol (JDWP) PL/SQL Debugger
 - *Oracle Database PL/SQL Packages and Types Reference* for information about the DBMS_DEBUG_JDWP package
 - *Oracle Database Reference* for information about the `V $PLSQL_DEBUGGABLE_SESSIONS` view
-
-

13.11.3.1 Compiling Code for Debugging

A debugger can stop on individual code lines and access variables only in code compiled with debug information generated.

To compile a PL/SQL unit with debug information generated, set the compilation parameter `PLSQL_OPTIMIZE_LEVEL` to 1 (the default value is 2). For more information about `PLSQL_OPTIMIZE_LEVEL`, see *Oracle Database Reference*. For information about PL/SQL units, see [Overview of PL/SQL Units](#) (page 13-4).

Note:

The PL/SQL compiler never generates debug information for code hidden with the PL/SQL `wrap` utility. For information about the `wrap` utility, see *Oracle Database PL/SQL Language Reference*.

13.11.3.2 Privileges for Debugging PL/SQL and Java Stored Subprograms

For a session to connect to a debugger, the effective user at the time of the connect operation must have the `DEBUG CONNECT SESSION`, `DEBUG CONNECT ANY`, or appropriate `DEBUG CONNECT ON USER` privilege. The effective user might be the owner of a DR subprogram involved in making the connect call.

When a session connects to a debugger, the session login user and the enabled session-level roles are fixed as the privilege environment for that debugging connection. The privileges needed for debugging must be granted to that combination of user and roles on the relevant code. The privileges are:

- To display and change variables declared in a PL/SQL package specification or Java public variables: either EXECUTE or DEBUG.
- To display and change private variables, or to breakpoint and run code lines step by step: DEBUG

Caution:

The DEBUG privilege allows a debugging session to do anything that the subprogram being debugged could have done if that action had been included in its code.

Granting the DEBUG ANY PROCEDURE system privilege is equivalent to granting the DEBUG privilege on all objects in the database. Objects owned by SYS are included if the value of the O7_DICTIONARY_ACCESSIBILITY parameter is TRUE.

Caution:

Granting the DEBUG ANY PROCEDURE privilege, or granting the DEBUG privilege on any object owned by SYS, grants complete rights to the database.

See Also:

- *Oracle Database SQL Language Reference* for information about system and object privileges
 - *Oracle Database Java Developer's Guide* for information about privileges for debugging Java subprograms
 - *Oracle Database PL/SQL Packages and Types Reference* for information about the DBMS_DEBUG_JDWP package security model
-
-

13.12 Package Invalidations and Session State

Each session that references a package object has its own instance of the corresponding package, including persistent state for any public and private variables, cursors, and constants. If any of the session's instantiated packages (specification or body) are invalidated, then all package instances in the session are invalidated and recompiled. Therefore, the session state is lost for all package instances in the session.

When a package in a given session is invalidated, the session receives ORA-04068 the first time it tries to use any object of the invalid package instance. The second time a session makes such a package call, the package is reinstantiated for the session without error. However, if you handle this error in your application, be aware of the following:

- For optimal performance, Oracle Database returns this error message only when the package state is discarded. When a subprogram in one package invokes a subprogram in another package, the session state is lost for both packages.
- If a server session traps ORA-04068, then ORA-04068 is not raised for the client session. Therefore, when the client session tries to use an object in the package, the package is not reinstantiated. To restantiate the package, the client session must either reconnect to the database or recompile the package.

In most production environments, DDL operations that can cause invalidations are usually performed during inactive working hours; therefore, this situation might not be a problem for end-user applications. However, if package invalidations are common in your system during working hours, then you might want to code your applications to handle this error when package calls are made.

13.13 Example: Raising an ORA-04068 Error

You can use the `RAISE` clause to raise exceptions.

In [Example 13-14](#) (page 13-39), the `RAISE` statement raises the current exception, ORA-04068, which is the cause of the exception being handled, ORA-06508. ORA-04068 is not trapped.

Example 13-14 Raising ORA-04068

```
PROCEDURE p IS
  package_exception EXCEPTION;
  PRAGMA EXCEPTION_INIT (package_exception, -6508);
BEGIN
  ...
EXCEPTION
  WHEN package_exception THEN
    RAISE;
END;
/
```

13.14 Example: Trapping ORA-04068

You can use the `RAISE` statement in a package definition to trap errors.

In [Example 13-15](#) (page 13-39), the `RAISE` statement raises the exception ORA-20001 in response to ORA-06508, instead of the current exception, ORA-04068. ORA-04068 is trapped. When this happens, the ORA-04068 error is masked, which stops the package from being reinstantiated.

Example 13-15 Trapping ORA-04068

```
PROCEDURE p IS
  package_exception EXCEPTION;
  other_exception EXCEPTION;
  PRAGMA EXCEPTION_INIT (package_exception, -6508);
  PRAGMA EXCEPTION_INIT (other_exception, -20001);
BEGIN
  ...
EXCEPTION
  WHEN package_exception THEN
    ...
    RAISE other_exception;
END;
/
```

Using PL/Scope

PL/Scope lets you develop powerful and effective PL/Scope source code tools that increase PL/SQL developer productivity by minimizing time spent browsing and understanding source code.

PL/Scope is intended for application developers, and is typically used in a development database environment.

Note:

PL/Scope cannot collect data for a PL/SQL unit whose source code is wrapped. For information about wrapping PL/SQL source code, see *Oracle Database PL/SQL Language Reference*.

Topics:

- [Overview of PL/Scope](#) (page 14-1)
- [Privileges Required for Using PL/Scope](#) (page 14-2)
- [Specifying Identifier and Statement Collection](#) (page 14-2)
- [How Much Space is PL/Scope Data Using?](#) (page 14-3)
- [Viewing PL/Scope Data](#) (page 14-4)
- [Overview of Data Dictionary Views Useful to Manage PL/SQL Code](#) (page 14-16)
- [Sample PL/Scope Session](#) (page 14-17)

14.1 Overview of PL/Scope

PL/Scope is a compiler-driven tool that collects PL/SQL and SQL identifiers as well as SQL statements usage in PL/SQL source code.

PL/Scope collects PL/SQL identifiers, SQL identifiers, and SQL statements metadata at program-unit compilation time and makes it available in static data dictionary views. The collected data includes information about identifier types, usages (DECLARATION, DEFINITION, REFERENCE, CALL, ASSIGNMENT) and the location of each usage in the source code.

Starting with Oracle Database 12c Release 2 (12.2), PL/Scope has been enhanced to report on the occurrences of static SQL, and dynamic SQL call sites in PL/SQL units. The call site of the native dynamic SQL (EXECUTE IMMEDIATE, OPEN CURSOR FOR) and DBMS_SQL calls are collected. Dynamic SQL statements are generated at execution time, so only the call sites can be collected at compilation time. The collected data in the new DBA_STATEMENTS view can be queried along with the other data

dictionary views to help answer questions about the scope of changes required for programming projects, and performing code analysis. It is also useful to identify the source of SQL statement not performing well. PL/Scope provides insight into dependencies between tables, views and the PL/SQL units. This level of details can be used as a migration assessment tool to determine the extent of changes required.

PL/Scope can help you answer questions such as :

- Where and how a column x in table y is used in the PL/SQL code?
- Is the SQL in my application PL/SQL code compatible with TimesTen?
- What are the constants, variables and exceptions in my application that are declared but never used?
- Is my code at risk for SQL injection?
- What are the SQL statements with an optimizer hint coded in the application?
- Which SQL has a BULK COLLECT clause ? Where is the SQL called from ?

14.2 Privileges Required for Using PL/Scope

By default, PUBLIC has SELECT privileges on various system tables and views, and EXECUTE privileges on various PL/SQL objects.

The PL/Scope data is available in the DBA_IDENTIFIERS and DBA_STATEMENTS data dictionary views. The user must have the privileges to query data in these views.

The following privileges have been granted on these relevant views.

View Name	Privilege Granted to Role
USER_IDENTIFIERS	READ to PUBLIC
ALL_IDENTIFIERS	READ to PUBLIC
DBA_IDENTIFIERS	SELECT to SELECT_CATALOG_ROLE
USER_STATEMENTS	READ to PUBLIC
ALL_STATEMENTS	READ to PUBLIC
DBA_STATEMENTS	SELECT to SELECT_CATALOG_ROLE

A database administrator can verify the list of privileges on these views by using a query similar to the following:

```
SELECT *
FROM   SYS.DBA_TAB_PRIVS
WHERE  GRANTEE = 'PUBLIC'
AND   TABLE_NAME IN
      ('ALL_IDENTIFIERS', 'USER_IDENTIFIERS', 'ALL_STATEMENTS', 'USER_STATEMENTS');
```

14.3 Specifying Identifier and Statement Collection

By default, PL/Scope does not collect data for identifiers and statements in the PL/SQL source program. To enable and control what is collected, set the PL/SQL compilation parameter PLScope_SETTINGS.

Starting with Oracle Database 12c Release 2 (12.2), the PLScope_SETTINGS has a new syntax that offers more controls and options to collect identifiers and SQL statements

metadata. The metadata is collected in the static data dictionary views `DBA_IDENTIFIERS` and `DBA_STATEMENTS`.

To collect PL/Scope data for all identifiers in the PL/SQL source program, including identifiers in package bodies, set the PL/SQL compilation parameter `PLSCOPE_SETTINGS` to `'IDENTIFIERS:ALL'`. The possible values for the `IDENTIFIERS` clause are `:ALL`, `NONE` (default), `PUBLIC`, `SQL`, and `PLSQL`. New SQL identifiers are introduced for `:ALIAS`, `COLUMN`, `MATERIALIZED VIEW`, `OPERATOR`, `TABLE`, and `VIEW`. The enhanced metadata collection enables the generation of reports useful for understanding the applications. PL/Scope can now be used as a tool to estimate the complexity of PL/SQL applications coding projects with a finer granularity than previously possible.

To collect PL/Scope data for all SQL statements used in PL/SQL source program, set the PL/SQL compilation parameter `PLSCOPE_SETTINGS` to `'STATEMENTS:ALL'`. The default value is `NONE`.

Note:

Collecting all identifiers and statements might generate large amounts of data and slow compile time.

PL/Scope stores the data that it collects in the `SYSAUX` tablespace. If the PL/Scope collection is enabled and `SYSAUX` tablespace is unavailable during compilation of a program unit, PL/Scope does not collect data for the compiled object. The compiler does not issue a warning, but it saves a warning in `USER_ERRORS`.

See Also:

- *Oracle Database Reference* for information about `PLSCOPE_SETTINGS`
 - *Oracle Database PL/SQL Language Reference* for information about PL/SQL compilation parameters
-
-

14.4 How Much Space is PL/Scope Data Using?

PL/Scope stores its data in the `SYSAUX` tablespace. If you are logged on as `SYSDBA`, you can use the query in [Example 14-1](#) (page 14-3) to display the amount of space that PL/Scope data is using.

For information about managing the `SYSAUX` tablespace, see *Oracle Database Administrator's Guide*.

Example 14-1 How Much Space is PL/Scope Data Using?

Query:

```
SELECT SPACE_USAGE_KBYTES
FROM V$SYSAUX_OCCUPANTS
WHERE OCCUPANT_NAME='PL/SCOPE';
```

Result:

```
SPACE_USAGE_KBYTES
-----
```

1920

1 row selected.

14.5 Viewing PL/Scope Data

To view the data that PL/Scope has collected, you can use either:

- [Static Data Dictionary Views for PL/SQL and SQL Identifiers](#) (page 14-4)
- [Static Data Dictionary Views for SQL Statements](#) (page 14-12)
- [SQL Developer](#) (page 14-16)

14.5.1 Static Data Dictionary Views for PL/SQL and SQL Identifiers

The DBA_IDENTIFIERS static data dictionary view family display information about PL/Scope identifiers, including their types and usages.

Topics:

- [PL/SQL and SQL Identifier Types that PL/Scope Collects](#) (page 14-4)
- [About Identifiers Usages](#) (page 14-6)
- [Identifiers Usage Unique Keys](#) (page 14-8)
- [About Identifiers Usage Context](#) (page 14-9)
- [About Identifiers Signature](#) (page 14-11)

See Also: *Oracle Database Reference* for more information about the dictionary view DBA_IDENTIFIERS view

14.5.1.1 PL/SQL and SQL Identifier Types that PL/Scope Collects

[Table 14-1](#) (page 14-5) shows the identifier types that PL/Scope collects, in alphabetical order. The identifier types in [Table 14-1](#) (page 14-5) appear in the TYPE column of the DBA_IDENTIFIERS static data dictionary views family, which is described in *Oracle Database Reference*.

Note:

Identifiers declared in compilation units that were not compiled with `PLSCOPE_SETTINGS= ' IDENTIFIERS:ALL '` do not appear in DBA_IDENTIFIERS static data dictionary views family.

Pseudocolumns, such as ROWNUM, are not supported since they are not user defined identifiers.

PL/Scope ignores column names that are literal strings.

Table 14-1 Identifier Types that PL/Scope Collects

TYPE Column Value	Comment
ALIAS	New SQL identifier introduced in Oracle Database 12c Release 2 (12.2).
ASSOCIATIVE ARRAY	
COLUMN	New SQL identifier introduced in Oracle Database 12c Release 2 (12.2).
CONSTANT	
CURSOR	
BFILE DATATYPE	Each DATATYPE is a base type declared in package STANDARD.
BLOB DATATYPE	
BOOLEAN DATATYPE	
CHARACTER DATATYPE	
CLOB DATATYPE	
DATE DATATYPE	
INTERVAL DATATYPE	
NUMBER DATATYPE	
TIME DATATYPE	
TIMESTAMP DATATYPE	
EXCEPTION	
FORMAL IN	
FORMAL IN OUT	
FORMAL OUT	
FUNCTION	
INDEX TABLE	
ITERATOR	An iterator is the index of a FOR loop.
LABEL	A label declaration also acts as a context.
LIBRARY	
MATERIALIZED VIEW	New SQL identifier introduced in Oracle Database 12c Release 2 (12.2).
NESTED TABLE	
OBJECT	
OPAQUE	Examples of internal opaque types are ANYDATA and XMLType.
OPERATOR	New SQL identifier introduced in Oracle Database 12c Release 2 (12.2).
PACKAGE	

Table 14-1 (Cont.) Identifier Types that PL/Scope Collects

TYPE Column Value	Comment
PROCEDURE	
RECORD	
REFCURSOR	
SEQUENCE	New SQL identifier introduced in Oracle Database 12c Release 2 (12.2).
SUBTYPE	
SYNONYM	PL/Scope does not resolve the base object name of a synonym. To find the base object name of a synonym, query *_SYNONYMS.
TABLE	New SQL identifier introduced in Oracle Database 12c Release 2 (12.2).
TRIGGER	
UROWID	
VARIABLE	Can be object attribute, local variable, package variable, or record field.
VARRAY	
VIEW	This type is used for editioning views. New SQL identifier introduced in Oracle Database 12c Release 2 (12.2).

14.5.1.2 About Identifiers Usages

PL/Scope usages are the verbs that describe actions performed on behalf of the identifier.

[Table 14-2](#) (page 14-7) shows the usages that PL/Scope reports, in alphabetical order. The identifier actions in [Table 14-2](#) (page 14-7) appear in the `USAGE` column of the `DBA_IDENTIFIERS` static data dictionary views family, which is described in *Oracle Database Reference*.

Table 14-2 Usages that PL/Scope Reports

USAGE Column Value	Description
ASSIGNMENT	<p>An assignment can be made only to an identifier that can have a value, such as a VARIABLE.</p> <p>Examples of assignments are:</p> <ul style="list-style-type: none"> • Using an identifier to the left of an assignment operator • Using an identifier in the INTO clause of a FETCH statement • Passing an identifier to a subprogram by reference (OUT mode) • Using an identifier as the bind variable in the USING clause of an EXECUTE IMMEDIATE statement in either OUT or IN OUT mode <p>An identifier that is passed to a subprogram in IN OUT mode has both a REFERENCE usage (corresponding to IN) and an ASSIGNMENT usage (corresponding to OUT).</p> <p>Expressions and nested subqueries are not supported as assignment sources.</p>
CALL	<p>In the context of PL/Scope, a CALL is an operation that pushes a call onto the call stack; that is:</p> <ul style="list-style-type: none"> • A call to a FUNCTION or PROCEDURE • Running or fetching a cursor identifier (a logical call to SQL) <p>A GOTO statement, or a raise of an exception, is not a CALL, because neither pushes a call onto the call stack.</p>
DECLARATION	<p>A DECLARATION tells the compiler that an identifier exists, and each identifier has exactly one DECLARATION. Each DECLARATION can have an associated data type.</p> <p>For a loop index declaration, LINE and COL (in *_IDENTIFIERS views) are the line and column of the FOR clause that implicitly declares the loop index.</p> <p>For a label declaration, LINE and COL are the line and column on which the label appears (and is implicitly declared) within the delimiters << and >>.</p>
DEFINITION	<p>A DEFINITION tells the compiler how to implement or use a previously declared identifier.</p> <p>Each of these types of identifiers has a DEFINITION:</p> <ul style="list-style-type: none"> • EXCEPTION (can have multiple definitions) • FUNCTION • OBJECT • PACKAGE • PROCEDURE • TRIGGER <p>For a top-level identifier only, the DEFINITION and DECLARATION are in the same place.</p>

Table 14-2 (Cont.) Usages that PL/Scope Reports

USAGE Column Value	Description
REFERENCE	<p>A REFERENCE uses an identifier without changing its value.</p> <p>Examples of references are:</p> <ul style="list-style-type: none"> • Raising an exception identifier • Using a type identifier in the declaration of a variable or formal parameter • Using a variable identifier whose type contains fields to access a field. For example, in <code>myrecordvar.myfield := 1</code>, a reference is made to <code>myrecordvar</code>, and an assignment is made to <code>myfield</code>. • Using a cursor for any purpose except <code>FETCH</code> • Passing an identifier to a subprogram by value (<code>IN</code> mode) • Using an identifier as the bind variable in the <code>USING</code> clause of an <code>EXECUTE IMMEDIATE</code> statement in either <code>IN</code> or <code>IN OUT</code> mode <p>An identifier that is passed to a subprogram in <code>IN OUT</code> mode has both a REFERENCE usage (corresponding to <code>IN</code>) and an ASSIGNMENT usage (corresponding to <code>OUT</code>).</p>

14.5.1.3 Identifiers Usage Unique Keys

Every identifier usage is given a numeric ID that is unique within the code unit. This is the `USAGE_ID` of the identifier.

Each row of a `*_IDENTIFIERS` view represents a unique usage of an identifier in the PL/SQL unit. In each of these views, these are equivalent unique keys within a compilation unit:

- `LINE`, `COL`, and `USAGE`
- `USAGE_ID`

For the usages in the `*_IDENTIFIERS` views, see [About Identifiers Usages](#) (page 14-6).

Note:

An identifier that is passed to a subprogram in `IN OUT` mode has two rows in `*_IDENTIFIERS`: a REFERENCE usage (corresponding to `IN`) and an ASSIGNMENT usage (corresponding to `OUT`).

This example shows the `USAGE_ID` generated for PROCEDURE p1.

```
CREATE OR REPLACE PROCEDURE p1 (a OUT VARCHAR2)
IS
  b VARCHAR2(100) := 'hello FROM p1';
BEGIN
  a := b;
END;
/

SELECT USAGE_ID, USAGE, NAME
FROM ALL_IDENTIFIERS
```



```

WHERE OBJECT_NAME = 'P1'
ORDER BY USAGE_ID;

          1 DECLARATION P1
          2 DEFINITION  P1
          3 DECLARATION A
          4 REFERENCE   VARCHAR2
          5 DECLARATION B
          6 REFERENCE   VARCHAR2
          7 ASSIGNMENT  B
          8 ASSIGNMENT  A
          9 REFERENCE   B

```

14.5.1.4 About Identifiers Usage Context

Identifier usages can be contexts for other identifier usages. This creates a one to many parent-child relationship among the usages. The `USAGE_ID` of the parent context usage is the `USAGE_CONTEXT_ID` for the child usages.

Context is useful for discovering relationships between usages. Except for top-level schema object declarations and definitions, every usage of an identifier happens within the context of another usage.

The default top-level context, which contains all top level objects, is identified by a `USAGE_CONTEXT_ID` of 0.

For example:

- A local variable declaration happens within the context of a top-level procedure declaration.
- If an identifier is declared as a variable, such as `x VARCHAR2(10)`, the `USAGE_CONTEXT_ID` of the `VARCHAR2` type reference contains the `USAGE_ID` of the `x` declaration, allowing you to associate the variable declaration with its type.

In other words, `USAGE_CONTEXT_ID` is a reflexive foreign key to `USAGE_ID`, as [Example 14-2](#) (page 14-9) shows.

Example 14-2 *USAGE_CONTEXT_ID and USAGE_ID*

```

ALTER SESSION SET PLScope_SETTINGS = 'IDENTIFIERS:ALL';

CREATE OR REPLACE PROCEDURE a (p1 IN BOOLEAN) AUTHID DEFINER IS
  v PLS_INTEGER;
BEGIN
  v := 42;
  DBMS_OUTPUT.PUT_LINE(v);
  RAISE_APPLICATION_ERROR (-20000, 'Bad');
EXCEPTION
  WHEN Program_Error THEN NULL;
END a;
/
CREATE OR REPLACE PROCEDURE b (
  p2 OUT PLS_INTEGER,
  p3 IN OUT VARCHAR2
) AUTHID DEFINER
IS
  n NUMBER;
  q BOOLEAN := TRUE;
BEGIN
  FOR j IN 1..5 LOOP
    a(q); a(TRUE); a(TRUE);

```

```

        IF j > 2 THEN
            GOTO z;
        END IF;
    END LOOP;
<<z>> DECLARE
    d CONSTANT CHAR(1) := 'X';
    BEGIN
        SELECT COUNT(*) INTO n FROM Dual WHERE Dummy = d;
    END z;
END b;
/
WITH v AS (
    SELECT    Line,
            Col,
            INITCAP(NAME) Name,
            LOWER(TYPE)   Type,
            LOWER(USAGE)  Usage,
            USAGE_ID,
            USAGE_CONTEXT_ID
    FROM USER_IDENTIFIERS
        WHERE Object_Name = 'B'
           AND Object_Type = 'PROCEDURE'
)
SELECT RPAD(LPAD(' ', 2*(Level-1)) ||
           Name, 20, '.') || ' ' ||
       RPAD(Type, 20) ||
       RPAD(Usage, 20)
       IDENTIFIER_USAGE_CONTEXTS

FROM v
START WITH USAGE_CONTEXT_ID = 0
CONNECT BY PRIOR USAGE_ID = USAGE_CONTEXT_ID
ORDER SIBLINGS BY Line, Col
/

```

Result:

```

IDENTIFIER_USAGE_CONTEXTS
-----
B..... procedure          declaration
B..... procedure          definition
P2..... formal out       declaration
  Pls_Integer... subtype  reference
P3..... formal in out    declaration
  Varchar2..... character datatype reference
N..... variable          declaration
  Number..... number datatype reference
Q..... variable          declaration
  Q..... variable          assignment
  Boolean..... boolean datatype reference
J..... iterator          declaration
  A..... procedure        call
    Q..... variable        reference
  A..... procedure        call
  A..... procedure        call
  J..... iterator          reference
  Z..... label            reference
Z..... label            declaration
  D..... constant         declaration
    D..... constant         assignment
    Char..... subtype      reference

```

14.5.1.5 About Identifiers Signature

The signature of an identifier is unique within and across program units. That is, the signature distinguishes the identifier from other identifiers with the same name, whether they are defined in the same program unit or different program units.

For the program unit in [Example 14-3](#) (page 14-11), which has two identifiers named p5, the static data dictionary view USER_IDENTIFIERS has several rows in which NAME is p5, but in these rows, SIGNATURE varies. The rows associated with the outer procedure p5 have one signature, and the rows associated with the inner procedure p5 have another signature. If program unit q calls procedure p5, the USER_IDENTIFIERS view for q has a row in which NAME is p5 and SIGNATURE is the signature of the outer procedure p5.

Example 14-3 Program Unit with Two Identifiers Named p5

This example shows a program unit with two identifiers named p5 to demonstrate the uniqueness of the signature.

```
CREATE OR REPLACE PROCEDURE p5 AUTHID DEFINER IS
  PROCEDURE p5 IS
  BEGIN
    DBMS_OUTPUT.PUT_LINE('Inner p5');
  END p5;
BEGIN
  DBMS_OUTPUT.PUT_LINE('Outer p5');
  p5();
END p5;
/
```

```
SELECT LINE || ' > ' || TEXT
FROM   ALL_SOURCE
WHERE  NAME = 'P5'
       AND TYPE = 'PROCEDURE'
ORDER BY LINE;
```

```
1 > PROCEDURE p5 AUTHID DEFINER IS
2 >   PROCEDURE p5 IS
3 >   BEGIN
4 >     DBMS_OUTPUT.PUT_LINE('Inner p5');
5 >   END p5;
6 > BEGIN
7 >   DBMS_OUTPUT.PUT_LINE('Outer p5');
8 >   p5();
9 > END p5;
```

The following query shows the SIGNATURE for the PL/SQL unit is the same for its DECLARATION and DEFINITION of the inner and outer p5.

```
SELECT SIGNATURE, USAGE, LINE, COL, USAGE_ID, USAGE_CONTEXT_ID
FROM   ALL_IDENTIFIERS
WHERE  OBJECT_NAME = 'P5'
ORDER BY LINE, COL, USAGE_ID;
```

75CD5986BA2EE5C61ACEED8C7162528F	DECLARATION	1	11	1	0
75CD5986BA2EE5C61ACEED8C7162528F	DEFINITION	1	11	2	1
33FB9F948F526C4B0634C0F35DFA91F6	DECLARATION	2	13	3	2
33FB9F948F526C4B0634C0F35DFA91F6	DEFINITION	2	13	4	3
33FB9F948F526C4B0634C0F35DFA91F6	CALL	8	3	7	2

```

CREATE OR REPLACE PROCEDURE q AUTHID DEFINER IS
BEGIN
  p5();
END q;
/

EXEC q;
Outer p5
Inner p5

SELECT SIGNATURE, USAGE, LINE, COL, USAGE_ID, USAGE_CONTEXT_ID
FROM ALL_IDENTIFIERS
WHERE OBJECT_NAME = 'Q'
AND NAME = 'P5'
ORDER BY LINE, COL, USAGE_ID;

75CD5986BA2EE5C61ACEED8C7162528F CALL          3          3          3          2

```

Example 14-4 Find All Usages of VARCHAR2

Identifier signatures are globally unique. This is useful to find all usages of an identifier in all units in the database. This example shows a query to find all usages of VARCHAR2.

```

SELECT UNIQUE OBJECT_NAME uses_varchar2
FROM ALL_IDENTIFIERS
WHERE SIGNATURE = (SELECT SIGNATURE
                   FROM ALL_IDENTIFIERS
                   WHERE OBJECT_NAME = 'STANDARD'
                   AND OWNER = 'SYS'
                   AND USAGE = 'DECLARATION'
                   AND NAME = 'VARCHAR2')
ORDER BY OBJECT_NAME;

```

14.5.2 Static Data Dictionary Views for SQL Statements

The DBA_STATEMENTS static dictionary views family describes the SQL statements collected by PL/Scope.

Starting with Oracle Database 12c Release 2 (12.2.0.1), a new view, DBA_STATEMENTS, reports on the occurrences of static SQL in PL/SQL units. It provides information about the SQL_ID, the canonical statement text, the statement type, useful statement usage attributes, its signature, and location in the PL/SQL code. Each row represents a SQL statement instance in the PL/SQL code.

Topics:

- [SQL Statement Types that PL/Scope Collects](#) (page 14-13)
- [Statements Location Unique Keys](#) (page 14-13)
- [About SQL Statement Usage Context](#) (page 14-14)
- [About SQL Statements Signature](#) (page 14-15)

See Also: *Oracle Database Reference* for more information about the DBA_STATEMENTS view

14.5.2.1 SQL Statement Types that PL/Scope Collects

PL/Scope statement types represent the SQL statements used in PL/SQL.

SQL Statement types correspond to statements that can be used in PL/SQL to execute or otherwise interact with SQL. The statement type appear in the TYPE column of the DBA_STATEMENTS static data dictionary views family.

You must compile the PL/SQL units with the `PLSCOPE_SETTINGS='STATEMENTS:ALL'` to collect this metadata.

SQL statement types that PL/Scope collects:

- SELECT
- UPDATE
- INSERT
- DELETE
- MERGE
- EXECUTE IMMEDIATE
- SET TRANSACTION
- LOCK TABLE
- COMMIT
- SAVEPOINT
- ROLLBACK
- OPEN
- CLOSE
- FETCH

14.5.2.2 Statements Location Unique Keys

Each row in the DBA_STATEMENTS view represents a unique location of a SQL statement in the PL/SQL unit. This is equivalent to unique keys within a compilation unit.

These following columns are used to determine the location of a statement in the PL/SQL code:

- OWNER, OBJECT_NAME, OBJECT_TYPE, LINE, COL
- USAGE_ID

The USAGE_ID is uniquely defined within a PL/SQL unit. Unlike identifiers, SQL statements do not have different usages, such as DECLARATION, ASSIGNMENT, or REFERENCE. All statements are considered an implicit CALL to the sql engine, therefore, the DBA_STATEMENTS view does not have the USAGE column, but it does use the USAGE_ID.

Example 14-5 Using the USAGE_ID Column to Query SQL Identifiers and Statements

```

PROCEDURE p1 (p_cust_id  NUMBER,
              p_cust_name OUT VARCHAR2)
IS
BEGIN
    SELECT (SELECT CUST_FIRST_NAME
           FROM CUSTOMERS)
    INTO   p_cust_name
    FROM   CUSTOMERS
    WHERE  CUSTOMER_ID = p_cust_id;
END;

SELECT USAGE_ID, TYPE, NAME, USAGE, LINE, COL
FROM ( SELECT USAGE_ID, TYPE, NAME, USAGE, LINE, COL
      FROM ALL_IDENTIFIERS
      WHERE OBJECT_NAME = 'P1'
      UNION
      SELECT USAGE_ID, TYPE, 'SQL STATEMENT', " ", LINE, COL
      FROM ALL_STATEMENTS
      WHERE OBJECT_NAME = 'P1')
ORDER BY USAGE_ID;

```

USAGE_ID	TYPE	NAME	USAGE	LINE	COL
1	PROCEDURE	P1	DECLARATION	1	11
2	PROCEDURE	P1	DEFINITION	1	11
3	FORMAL IN	P_CUST_ID	DECLARATION	1	15
4	NUMBER DATATYPE	NUMBER	REFERENCE	1	25
5	FORMAL OUT	P_CUST_NAME	DECLARATION	1	33
6	CHARACTER DATATYPE	VARCHAR2	REFERENCE	1	49
7	SQL STATEMENT	SELECT		3	3
8	TABLE	CUSTOMERS	REFERENCE	4	10
9	FORMAL IN	P_CUST_ID	REFERENCE	4	38
10	COLUMN	CUSTOMER_ID	REFERENCE	4	26
11	FORMAL OUT	P_CUST_NAME	ASSIGNMENT	3	31
12	COLUMN	CUST_FIRST_NAME	REFERENCE	3	10

14.5.2.3 About SQL Statement Usage Context

Statements can act as a context for other statements or identifiers. Statements can also be in the context of other statements or identifiers.

The USAGE_CONTEXT_ID column is used to determine the context of the statement. All identifiers appearing within a statement will be in the context of that statement.

Expressions and nested subqueries are not supported as assignment sources.

Example 14-6 Using DBA_STATEMENTS USAGE_CONTEXT_ID to Query Identifiers

This example shows how to retrieve the identifiers in the context of the SELECT statement using the USAGE_CONTEXT_ID column.

```

PROCEDURE p1 (p_cust_id  NUMBER,
              p_cust_name OUT VARCHAR2)
IS
BEGIN
    SELECT (SELECT CUST_FIRST_NAME
           FROM CUSTOMERS)
    INTO   p_cust_name
    FROM   CUSTOMERS
    WHERE  CUSTOMER_ID = p_cust_id;

```

```

END;

SELECT USAGE_ID, LPAD(' ', 2*(level-1)) || TO_CHAR(USAGE) || ' ' || NAME usages,
LINE, COL
FROM ( SELECT OBJECT_NAME, USAGE, USAGE_ID, USAGE_CONTEXT_ID, NAME, LINE, COL
      FROM ALL_IDENTIFIERS
      WHERE OBJECT_NAME = 'P1'
      UNION
      SELECT OBJECT_NAME, TYPE usage, USAGE_ID, USAGE_CONTEXT_ID, 'Statement' name,
LINE, COL
      FROM ALL_STATEMENTS
      WHERE OBJECT_NAME = 'P1'
      )
START WITH USAGE_CONTEXT_ID = 0 AND OBJECT_NAME = 'P1'
CONNECT BY PRIOR USAGE_ID = USAGE_CONTEXT_ID AND OBJECT_NAME = 'P1';

```

USAGE_ID	USAGES	LINE	COL
1	DECLARATION P1	1	11
2	DEFINITION P1	1	11
3	DECLARATION P_CUST_ID	1	15
4	REFERENCE NUMBER	1	27
5	DECLARATION P_CUST_NAME	2	33
6	REFERENCE VARCHAR2	2	49
7	SELECT STATEMENT	5	5
8	REFERENCE CUSTOMERS	8	12
9	REFERENCE P_CUST_ID	9	26
10	REFERENCE CUSTOMER_ID	9	12
11	REFERENCE CUSTOMERS	6	20
12	REFERENCE CUST_FIRST_NAME	5	20
13	ASSIGNMENT P_CUST_NAME	7	12

14.5.2.4 About SQL Statements Signature

Every SQL statement has a unique PL/Scope signature that identifies that instance of the statement in all the PL/SQL units.

The SQL statement signature distinguishes the call from a PL/SQL unit for the SQL with the same SQL_ID from another call from a different PL/SQL unit.

Nested subqueries are not individual SQL statements in ALL_STATEMENTS.

Example 14-7 Distinct SQL Signatures for the Same SQL Statement when Called from Different PL/SQL Units

This example shows two distinct signatures for the same SQL statement when it is called from PROCEDURE p1 and p2. You can observe the nested subquery is not assigned a distinct SQL_ID, therefore is not an individual SQL statements in ALL_STATEMENTS.

```

CREATE OR REPLACE PROCEDURE p1 (p_cust_id NUMBER,
                               p_cust_name OUT VARCHAR2)
IS
BEGIN
    SELECT (SELECT CUST_FIRST_NAME
          FROM CUSTOMERS)
    INTO   p_cust_name
    FROM   CUSTOMERS
    WHERE  CUSTOMER_ID = p_cust_id;
END;
/
CREATE OR REPLACE PROCEDURE p2 (p_cust_id NUMBER,

```

```

                                p_cust_name OUT VARCHAR2)
IS
BEGIN
    SELECT (SELECT CUST_FIRST_NAME
           FROM CUSTOMERS)
    INTO   p_cust_name
    FROM   CUSTOMERS
    WHERE  CUSTOMER_ID = p_cust_id;
END;
/

```

```
ACCEPT nam CHAR PROMPT "Enter OBJECT_NAME : "
```

```

SELECT *
FROM   ALL_STATEMENTS
WHERE  OBJECT_NAME = '&&nam'
ORDER BY LINE, COL;

```

Select ALL_STATEMENTS for P1 and P2 to observe the different SQL signatures for the same SQL_ID.

```

new 3: WHERE OBJECT_NAME = 'P1'
OE
138835D3A2EBBA76A7A064E4DC14B466 SELECT
P1
PROCEDURE          7          5          5          2 c02b6yppqb46p NO NO
NO NO NO NO
YES SELECT (SELECT CUST_FIRST_NAME FROM CUSTOMERS) FROM CUSTOMERS WHERE
CUSTOMER_ID      = :B1
SELECT (SELECT CUST_FIRST_NAME FROM CUSTOMERS) FROM CUSTOMERS WHERE CUSTOMER_ID
0

```

```

new 3: WHERE OBJECT_NAME = 'P2'
OE
E6A5E27E5E90997A169C5C25393FAB35 SELECT
P2
PROCEDURE          7          5          5          2 c02b6yppqb46p NO NO
NO NO NO NO
YES SELECT (SELECT CUST_FIRST_NAME FROM CUSTOMERS) FROM CUSTOMERS WHERE
CUSTOMER_ID      = :B1
SELECT (SELECT CUST_FIRST_NAME FROM CUSTOMERS) FROM CUSTOMERS WHERE CUSTOMER_ID
0

```

14.5.3 SQL Developer

PL/Scope is a feature of SQL Developer. For information about using PL/Scope from SQL Developer, see the *Oracle SQL Developer User's Guide* or the SQL Developer online help.

14.6 Overview of Data Dictionary Views Useful to Manage PL/SQL Code

In addition to the PL/Scope data dictionary views, the following static dictionary views are most useful for PL/SQL programmers and are most often referenced in queries related to PL/SQL code management reports. This is not an exhaustive list of all static data dictionary views.

Summary of the Data Dictionary Views Useful to Manage PL/SQL Code

View Name	Description
ALL_ARGUMENTS	Lists the arguments of the functions and procedures that are accessible to the current user
ALL_DEPENDENCIES	Describes dependencies between procedures, packages, functions, package bodies, and triggers accessible to the current user
ALL_ERRORS	Describes the current errors on the stored objects accessible to the current user
ALL_IDENTIFIERS	Displays information about the identifiers in the stored objects accessible to the current user
USER_OBJECT_SIZE	Describes the size, in bytes, of PL/SQL objects owned by the current user. Although this information is meant to be used by the compiler and runtime engine, you can use it to identify the large programs in your environment.
ALL_OBJECTS	Describes all objects accessible to the current user
ALL_PLSQL_OBJECT_SETTINGS	Displays information about the compiler settings for the stored objects accessible to the current user
ALL_PROCEDURES	Describes all PL/SQL functions and procedures, along with associated properties, that are accessible to the current user
ALL_SEQUENCES	Describes the sequences accessible to the current user
ALL_SOURCE	Describes the text source of the stored objects accessible to the current user
ALL_STATEMENTS	Describes all SQL statements in stored PL/SQL objects accessible to the user
ALL_STORED_SETTINGS	Describes the persistent parameter settings for stored PL/SQL units for which the current user has execute privileges
ALL_SYNONYMS	Describes the synonyms accessible to the current user
ALL_TAB_COLUMNS	Describes the columns of the tables, views, and clusters accessible to the current user
ALL_TABLES	Describes the relational tables accessible to the current user
ALL_TRIGGERS	Describes the triggers on tables accessible to the current user
ALL_VIEWS	Describes the views accessible to the current user

14.7 Sample PL/Scope Session

In this sample session, assume that you are logged in as HR.

1. Set the session parameter:

```
ALTER SESSION SET PLScope_SETTINGS='IDENTIFIERS:ALL';
```

2. Create this package:

```

CREATE OR REPLACE PACKAGE pack1 AUTHID DEFINER IS
  TYPE r1 IS RECORD (rfl VARCHAR2(10));
  FUNCTION f1(fp1 NUMBER) RETURN NUMBER;
  PROCEDURE p1(pp1 VARCHAR2);
END PACK1;
/
CREATE OR REPLACE PACKAGE BODY pack1 IS
  FUNCTION f1(fp1 NUMBER) RETURN NUMBER IS
    a NUMBER := 10;
  BEGIN
    RETURN a;
  END f1;
  PROCEDURE p1(pp1 VARCHAR2) IS
    pr1 r1;
  BEGIN
    pr1.rfl := pp1;
  END;
END pack1;
/

```

3. Verify that PL/Scope collected all identifiers for the package body:

```

SELECT PLScope_SETTINGS
FROM USER_PLSQL_OBJECT_SETTINGS
WHERE NAME='PACK1' AND TYPE='PACKAGE BODY'

```

Result:

```
PLSCOPE_SETTINGS
```

```
-----
IDENTIFIERS:ALL
```

4. Display unique identifiers in HR by querying for all DECLARATION usages. For example, to see all unique identifiers with name like %1, use these SQL*Plus formatting commands and this query:

```

COLUMN NAME FORMAT A6
COLUMN SIGNATURE FORMAT A32
COLUMN TYPE FORMAT A9

SELECT NAME, SIGNATURE, TYPE
FROM USER_IDENTIFIERS
WHERE NAME LIKE '%1' AND USAGE='DECLARATION'
ORDER BY OBJECT_TYPE, USAGE_ID;

```

Result is similar to:

NAME	SIGNATURE	TYPE
PACK1	41820FA4D5EF6BE707895178D0C5C4EF	PACKAGE
R1	EEBB6849DEE31BC77BF186EBAE5D4E2D	RECORD
RF1	41D70040337349634A7F547BC83517C7	VARIABLE
F1	D51E825FF334817C977174423E3D0765	FUNCTION
FP1	CAC3474C112DBEC67AB926978D9A16C1	FORMAL IN
P1	B7C0576BA4D00C33A65CC0C64CADAB89	PROCEDURE
PP1	6B74CF95A5B7377A735925DFAA280266	FORMAL IN
FP1	98EB63B8A4AFEB5EF94D50A20165D6CC	FORMAL IN
PP1	62D8463A314BE1F996794723402278CF	FORMAL IN
PR1	BDB1CB26C97562CCC20CD1F32D341D7C	VARIABLE

10 rows selected.

The *_IDENTIFIERS static data dictionary views display only basic type names; for example, the TYPE of a local variable or record field is VARIABLE. To determine the exact type of a VARIABLE, you must use its USAGE_CONTEXT_ID.

5. Find all local variables:

```
COLUMN VARIABLE_NAME FORMAT A13
COLUMN CONTEXT_NAME FORMAT A12

SELECT a.NAME variable_name,
       b.NAME context_name,
       a.SIGNATURE
FROM USER_IDENTIFIERS a, USER_IDENTIFIERS b
WHERE a.USAGE_CONTEXT_ID = b.USAGE_ID
AND a.TYPE = 'VARIABLE'
AND a.USAGE = 'DECLARATION'
AND a.OBJECT_NAME = 'PACK1'
AND a.OBJECT_NAME = b.OBJECT_NAME
AND a.OBJECT_TYPE = b.OBJECT_TYPE
AND (b.TYPE = 'FUNCTION' or b.TYPE = 'PROCEDURE')
ORDER BY a.OBJECT_TYPE, a.USAGE_ID;
```

Result is similar to:

```
VARIABLE_NAME CONTEXT_NAME SIGNATURE
-----
A             F1             1691C6B3C951FCAA2CBEEB47F85CF128
PR1          P1             BDB1CB26C97562CCC20CD1F32D341D7C
```

2 rows selected.

6. Find all usages performed on the local variable A:

```
COLUMN USAGE FORMAT A11
COLUMN USAGE_ID FORMAT 999
COLUMN OBJECT_NAME FORMAT A11
COLUMN OBJECT_TYPE FORMAT A12

SELECT USAGE, USAGE_ID, OBJECT_NAME, OBJECT_TYPE
FROM USER_IDENTIFIERS
WHERE SIGNATURE='1691C6B3C951FCAA2CBEEB47F85CF128' -- signature of A
ORDER BY OBJECT_TYPE, USAGE_ID;
```

Result:

```
USAGE      USAGE_ID OBJECT_NAME OBJECT_TYPE
-----
DECLARATION      6 PACK1      PACKAGE BODY
ASSIGNMENT       8 PACK1      PACKAGE BODY
REFERENCE        9 PACK1      PACKAGE BODY
```

3 rows selected.

The usages performed on the local identifier A are the identifier declaration (USAGE_ID 6), an assignment (USAGE_ID 8), and a reference (USAGE_ID 9).

7. From the declaration of the local identifier A, find its type:

```
COLUMN NAME FORMAT A6
COLUMN TYPE FORMAT A15

SELECT a.NAME, a.TYPE
```

```

FROM USER_IDENTIFIERS a, USER_IDENTIFIERS b
WHERE a.USAGE = 'REFERENCE'
AND a.USAGE_CONTEXT_ID = b.USAGE_ID
AND b.USAGE = 'DECLARATION'
AND b.SIGNATURE = 'D51E825FF334817C977174423E3D0765' -- signature of F1
AND a.OBJECT_TYPE = b.OBJECT_TYPE
AND a.OBJECT_NAME = b.OBJECT_NAME;

```

Result:

```

NAME      TYPE
-----  -
NUMBER NUMBER DATATYPE

```

1 row selected.

8. Find out where the assignment to local identifier A occurred:

```

SELECT LINE, COL, OBJECT_NAME, OBJECT_TYPE
FROM USER_IDENTIFIERS
WHERE SIGNATURE='1691C6B3C951FCAA2CBEEB47F85CF128' -- signature of A
AND USAGE='ASSIGNMENT';

```

Result:

```

      LINE      COL OBJECT_NAME OBJECT_TYPE
-----  -
          3          5 PACK1      PACKAGE BODY

```

1 row selected.

Using the PL/SQL Hierarchical Profiler

You can use the PL/SQL hierarchical profiler to identify bottlenecks and performance-tuning opportunities in PL/SQL applications.

The profiler reports the dynamic execution profile of a PL/SQL program organized by function calls, and accounts for SQL and PL/SQL execution times separately. No special source or compile-time preparation is required; any PL/SQL program can be profiled.

This chapter describes the PL/SQL hierarchical profiler and explains how to use it to collect and analyze profile data for a PL/SQL program.

Topics:

- [Overview of PL/SQL Hierarchical Profiler](#) (page 15-1)
- [Collecting Profile Data](#) (page 15-2)
- [Understanding Raw Profiler Output](#) (page 15-4)
- [Analyzing Profile Data](#) (page 15-7)
- [plshprof Utility](#) (page 15-15)

15.1 Overview of PL/SQL Hierarchical Profiler

Nonhierarchical (**flat**) profilers record the time that a program spends within each subprogram—the **function time** or **self time** of each subprogram. Function time is helpful, but often inadequate. For example, it is helpful to know that a program spends 40% of its time in the subprogram `INSERT_ORDER`, but it is more helpful to know which subprograms call `INSERT_ORDER` often and the total time the program spends under `INSERT_ORDER` (including its descendant subprograms). Hierarchical profilers provide such information.

The PL/SQL hierarchical profiler:

- Reports the dynamic execution profile of your PL/SQL program, organized by subprogram calls
- Accounts for SQL and PL/SQL execution times separately
- Requires no special source or compile-time preparation
- Stores results in database tables (**hierarchical profiler tables**) for custom report generation by integrated development environment (IDE) tools (such as SQL Developer and third-party tools)
- Provides subprogram-level execution summary information, such as:

- Number of calls to the subprogram
- Time spent in the subprogram itself (**function time** or **self time**)
- Time spent in the subprogram itself and in its descendent subprograms (**subtree time**)
- Detailed parent-children information, for example:
 - All callers of a given subprogram (parents)
 - All subprograms that a given subprogram called (children)
 - How much time was spent in subprogram *x* when called from *y*
 - How many calls to subprogram *x* were from *y*

The PL/SQL hierarchical profiler is implemented by the `DBMS_HPROF` package and has two components:

- Data collection

The data collection component is an intrinsic part of the PL/SQL Virtual Machine. The `DBMS_HPROF` package provides APIs to turn hierarchical profiling on and off and write the **raw profiler output** to a file.

- Analyzer

The analyzer component processes the raw profiler output and stores the results in hierarchical profiler tables.

Note:

To generate simple HTML reports directly from raw profiler output, without using the Analyzer, you can use the `plshprof` command-line utility.

15.2 Collecting Profile Data

To collect profile data from your PL/SQL program for the PL/SQL hierarchical profiler, follow these steps:

1. Ensure that you have these privileges:
 - EXECUTE privilege on the `DBMS_HPROF` package
 - WRITE privilege on the directory that you specify when you call `DBMS_HPROF.START_PROFILING`
2. Use the `DBMS_HPROF.START_PROFILING` PL/SQL API to start hierarchical profiler data collection in a session.

3. Run your PL/SQL program long enough to get adequate code coverage.

To get the most accurate measurements of elapsed time, avoid unrelated activity on the system on which your PL/SQL program is running.

4. Use the `DBMS_HPROF.STOP_PROFILING` PL/SQL API to stop hierarchical profiler data collection.

Example 15-1 Profiling a PL/SQL Procedure

```

BEGIN
  /* Start profiling.
     Write raw profiler output to file test.trc in a directory
     that is mapped to directory object PLSHPROF_DIR
     (see note after example). */

  DBMS_HPROF.START_PROFILING('PLSHPROF_DIR', 'test.trc');
END;
/
-- Run procedure to be profiled
BEGIN
  test;
END;
/
BEGIN
  -- Stop profiling
  DBMS_HPROF.STOP_PROFILING;
END;
/

```

For more information about `DBMS_HPROF.START_PROFILING` and `DBMS_HPROF.STOP_PROFILING`, see *Oracle Database PL/SQL Packages and Types Reference*.

Consider this PL/SQL procedure, `test`:

```

CREATE OR REPLACE PROCEDURE test AUTHID DEFINER IS
  n NUMBER;

  PROCEDURE foo IS
  BEGIN
    SELECT COUNT(*) INTO n FROM EMPLOYEES;
  END foo;

BEGIN -- test
  FOR i IN 1..3 LOOP
    foo;
  END LOOP;
END test;
/

```

The SQL script in [Example 15-1](#) (page 15-3) profiles the execution of the PL/SQL procedure `test`.

Note:

A directory object is an alias for a file system path name. For example, if you are connected to the database AS SYSDBA, this CREATE DIRECTORY statement creates the directory object PLSHPROF_DIR and maps it to the file system directory /private/plshprof/results:

```
CREATE DIRECTORY PLSHPROF_DIR as '/private/plshprof/results';
```

To run the SQL script in [Example 15-1](#) (page 15-3), you must have READ and WRITE privileges on both PLSHPROF_DIR and the directory to which it is mapped. If you are connected to the database AS SYSDBA, this GRANT statement grants READ and WRITE privileges on PLSHPROF_DIR to HR:

```
GRANT READ, WRITE ON DIRECTORY PLSHPROF_DIR TO HR;
```

For more information about using directory objects, see *Oracle Database SecureFiles and Large Objects Developer's Guide*.

15.3 Understanding Raw Profiler Output

Raw profiler output is intended to be processed by the analyzer component of the PL/SQL hierarchical profiler. However, even without such processing, it provides a simple function-level trace of the program. This topic explains how to understand raw profiler output.

Note:

The raw profiler format shown in this chapter is intended only to illustrate conceptual features of raw profiler output. Format specifics are subject to change at each Oracle Database release.

The SQL script in [Example 15-1](#) (page 15-3) wrote this raw profiler output to the file test.trc:

```
P#V PLSHPROF Internal Version 1.0
P#! PL/SQL Timer Started
P#C PLSQL."."."__plsqli_vm"
P#X 4
P#C PLSQL."."."__anonymous_block"
P#X 77
P#C PLSQL."HR"."TEST"::7."TEST"#980980e97e42f8ec #1
P#X 4
P#C PLSQL."HR"."TEST"::7."TEST.FOO"#980980e97e42f8ec #4
P#X 47
P#C SQL."HR"."TEST"::7."__static_sql_exec_line6" #6."3r6qf2qhr3cm1"
P#! SELECT COUNT(*) FROM EMPLOYEES
P#X 279
P#R
P#X 58
P#R
P#X 3
P#C PLSQL."HR"."TEST"::7."TEST.FOO"#980980e97e42f8ec #4
P#X 4
P#C SQL."HR"."TEST"::7."__static_sql_exec_line6" #6."3r6qf2qhr3cm1"
```



```

P#! SELECT COUNT(*) FROM EMPLOYEES
P#X 121
P#R
P#X 5
P#R
P#X 2
P#C PLSQL."HR"."TEST"::7."TEST.FOO"#980980e97e42f8ec #4
P#X 3
P#C SQL."HR"."TEST"::7."__static_sql_exec_line6" #6."3r6qf2qhr3cm1"
P#! SELECT COUNT(*) FROM EMPLOYEES
P#X 117
P#R
P#X 4
P#R
P#X 2
P#R
P#X 2
P#R
P#X 3
P#R
P#C PLSQL."."."."__plsqli_vm"
P#X 3
P#C PLSQL."."."."__anonymous_block"
P#X 86
P#C PLSQL."SYS"."DBMS_HPROF"::11."STOP_PROFILING"#980980e97e42f8ec #453
P#R
P#R
P#R
P#! PL/SQL Timer Stopped

```

Table 15-1 Raw Profiler Output File Indicators

Indicator	Meaning
P#V	PLSHPROF banner with version number
P#C	Call to a subprogram (call event)
P#R	Return from a subprogram (return event)
P#X	Elapsed time between preceding and following events
P#!	Comment

Call events (P#C) and return events (P#R) are properly nested (like matched parentheses). If an unhandled exception causes a called subprogram to exit, the profiler still reports a matching return event.

Each call event (P#C) entry in the raw profiler output includes this information:

- **Namespace** to which the called subprogram belongs (see [Namespaces of Tracked Subprograms](#) (page 15-6))
- **Name of the PL/SQL module** in which the called subprogram is defined
- **Type of the PL/SQL module** in which the called subprogram is defined
- **Name of the called subprogram**

This name might be one of the special function names in [Special Function Names](#) (page 15-7).

- Hexadecimal value that represents an MD5 hash of the **signature** of the called subprogram

The DBMS_HPROF.analyze PL/SQL API (described in [Analyzing Profile Data](#) (page 15-7)) stores the hash value in a hierarchical profiler table, which allows both you and DBMS_HPROF.analyze to distinguish between **overloaded subprograms** (subprograms with the same name).

- Line number** at which the called subprogram is defined in the PL/SQL module
 PL/SQL hierarchical profiler does not measure time spent at individual lines within modules, but you can use line numbers to identify the source locations of subprograms in the module (as IDE/Tools do) and to distinguish between overloaded subprograms.

For example, consider this entry in the preceding example of raw profiler output:

```
P#C PLSQL."HR"."TEST"::7."TEST.FOO"#980980e97e42f8ec #4
```

The components of the preceding entry have these meanings:

Component	Meaning
PLSQL	PLSQL is the namespace to which the called subprogram belongs.
"HR"."TEST"	HR.TEST is the name of the PL/SQL module in which the called subprogram is defined.
7	7 is the internal enumerator for the module type of HR.TEST. Examples of module types are procedure, package, and package body.
"TEST.FOO"	TEST.FOO is the name of the called subprogram .
#980980e97e42f8ec	#980980e97e42f8ec is a hexadecimal value that represents an MD5 hash of the signature of TEST.FOO.
#4	4 is the line number in the PL/SQL module HR.TEST at which TEST.FOO is defined.

Note:

When a subprogram is inlined, it is not reported in the profiler output. For information about subprogram inlining, see *Oracle Database PL/SQL Language Reference*.

When a call to a DETERMINISTIC function is "optimized away," it is not reported in the profiler output. For information about DETERMINISTIC functions, see *Oracle Database PL/SQL Language Reference*.

15.3.1 Namespaces of Tracked Subprograms

The subprograms that the PL/SQL hierarchical profiler tracks are classified into the namespaces PLSQL and SQL, as follows:

- Namespace PLSQL includes:
 - PL/SQL subprogram calls

- PL/SQL triggers
- PL/SQL anonymous blocks
- Remote subprogram calls
- Package initialization blocks
- Namespace SQL includes SQL statements executed from PL/SQL, such as queries, data manipulation language (DML) statements, data definition language (DDL) statements, and native dynamic SQL statements

15.3.2 Special Function Names

PL/SQL hierarchical profiler tracks certain operations as if they were functions with the names and namespaces shown in [Table 15-2](#) (page 15-7).

Table 15-2 *Function Names of Operations that the PL/SQL Hierarchical Profiler Tracks*

Tracked Operation	Function Name	Namespace
Call to PL/SQL Virtual Machine	__plssql_vm	PL/SQL
PL/SQL anonymous block	__anonymous_block	PL/SQL
Package initialization block	__pkg_init	PL/SQL
Static SQL statement at line <i>line#</i>	__static_sql_exec_line <i>line#</i>	SQL
Dynamic SQL statement at line <i>line#</i>	__dyn_sql_exec_line <i>line#</i>	SQL
SQL FETCH statement at line <i>line#</i>	__sql_fetch_line <i>line#</i>	SQL

15.4 Analyzing Profile Data

The analyzer component of the PL/SQL hierarchical profiler, `DBMS_HPROF.analyze`, processes the raw profiler output and stores the results in the **hierarchical database tables** described in [Table 15-3](#) (page 15-7).

Table 15-3 *PL/SQL Hierarchical Profiler Database Tables*

Table	Description
DBMSHP_RUNS	Top-level information for this run of <code>DBMS_HPROF.analyze</code> . For column descriptions, see Table 15-4 (page 15-9).
DBMSHP_FUNCTION_INFO	Information for each subprogram profiled in this run of <code>DBMS_HPROF.analyze</code> . For column descriptions, see Table 15-5 (page 15-10).
DBMSHP_PARENT_CHILD_INFO	Parent-child information for each subprogram profiled in this run of <code>DBMS_HPROF.analyze</code> . For column descriptions, see Table 15-6 (page 15-11).

Topics:

- [Creating Hierarchical Profiler Tables](#) (page 15-8)
- [Understanding Hierarchical Profiler Tables](#) (page 15-9)

Note:

To generate simple HTML reports directly from raw profiler output, without using the Analyzer, you can use the `plshprof` command-line utility. For details, see [plshprof Utility](#) (page 15-15).

15.4.1 Creating Hierarchical Profiler Tables

To create the hierarchical profiler tables in [Table 15-3](#) (page 15-7) and the other data structures required for persistently storing profile data, follow these steps:

1. Run the script `dbmshptab.sql` (located in the directory `rdbms/admin`).

This script creates both the hierarchical profiler tables in [Table 15-3](#) (page 15-7) and the other data structures required for persistently storing profile data.

Note:

Running the script `dbmshptab.sql` drops any previously created hierarchical profiler tables.

2. Ensure that you have these privileges:
 - EXECUTE privilege on the `DBMS_HPROF` package
 - READ privilege on the directory that `DBMS_HPROF.analyze` specifies
3. Use the PL/SQL API `DBMS_HPROF.analyze` to analyze a single raw profiler output file and store the results in hierarchical profiler tables.

(For an example of a raw profiler output file, see `test.trc` in [Understanding Raw Profiler Output](#) (page 15-4).)

For more information about `DBMS_HPROF.analyze`, see *Oracle Database PL/SQL Packages and Types Reference*.

4. Use the hierarchical profiler tables to generate custom reports.

Example 15-2 Invoking `DBMS_HPROF.analyze`

```
DECLARE
  runid NUMBER;
BEGIN
  runid := DBMS_HPROF.analyze(LOCATION=>'PLSHPROF_DIR',
                             FILENAME=>'test.trc');
  DBMS_OUTPUT.PUT_LINE('runid = ' || runid);
END;
/
```

The anonymous block in [Example 15-2](#) (page 15-8):

- Invokes the function `DBMS_HPROF.analyze` function, which:
 - Analyzes the profile data in the raw profiler output file `test.trc` (from [Understanding Raw Profiler Output](#) (page 15-4)), which is in the directory that is mapped to the directory object `PLSHPROF_DIR`, and stores the data in the hierarchical profiler tables in [Table 15-3](#) (page 15-7).
 - Returns a unique identifier that you can use to query the hierarchical profiler tables in [Table 15-3](#) (page 15-7). (By querying these hierarchical profiler tables, you can produce customized reports.)
- Stores the unique identifier in the variable `runid`, which it prints.

15.4.2 Understanding Hierarchical Profiler Tables

These topics explain how to use the hierarchical profiler tables in [Table 15-3](#) (page 15-7):

- [Hierarchical Profiler Database Table Columns](#) (page 15-9)
- [Distinguishing Between Overloaded Subprograms](#) (page 15-11)
- [Hierarchical Profiler Tables for Sample PL/SQL Procedure](#) (page 15-12)
- [Examples of Calls to DBMS_HPROF.analyze with Options](#) (page 15-13)

15.4.2.1 Hierarchical Profiler Database Table Columns

[Table 15-4](#) (page 15-9) describes the columns of the hierarchical profiler table `DBMSHP_RUNS`, which contains one row of top-level information for each run of `DBMS_HPROF.analyze`.

The primary key for the hierarchical profiler table `DBMSHP_RUNS` is `RUNID`.

Table 15-4 *DBMSHP_RUNS Table Columns*

Column Name	Column Data Type	Column Contents
<code>RUNID</code>	<code>NUMBER</code>	Unique identifier for this run of <code>DBMS_HPROF.analyze</code> , generated from <code>DBMSHP_RUNNUMBER</code> sequence.
<code>RUN_TIMESTAMP</code>	<code>TIMESTAMP (6)</code>	Time stamp for this run of <code>DBMS_HPROF.analyze</code> .
<code>RUN_COMMENT</code>	<code>VARCHAR2 (2047)</code>	Comment that you provided for this run of <code>DBMS_HPROF.analyze</code> .
<code>TOTAL_ELAPSED_TIME</code>	<code>NUMBER (38)</code>	Total elapsed time for this run of <code>DBMS_HPROF.analyze</code> .

[Table 15-5](#) (page 15-10) describes the columns of the hierarchical profiler table `DBMSHP_FUNCTION_INFO`, which contains one row of information for each subprogram profiled in this run of `DBMS_HPROF.analyze`. If a subprogram is overloaded, [Table 15-5](#) (page 15-10) has a row for each variation of that subprogram. Each variation has its own `LINE#` and `HASH` (see [Distinguishing Between Overloaded Subprograms](#) (page 15-11).)

The primary key for the hierarchical profiler table `DBMSHP_FUNCTION_INFO` is `RUNID`, `SYMBOLID`.

Table 15-5 DBMSHP_FUNCTION_INFO Table Columns

Column Name	Column Data Type	Column Contents
RUNID	NUMBER	References RUNID column of DBMSHP_RUNS table. For a description of that column, see Table 15-4 (page 15-9).
SYMBOLID	NUMBER	Symbol identifier for subprogram (unique for this run of DBMS_HPROF.analyze).
OWNER	VARCHAR2 (128)	Owner of module in which each subprogram is defined (for example, SYS or HR).
MODULE	VARCHAR2 (128)	Module in which subprogram is defined (for example, DBMS_LOB, UTL_HTTP, or MY_PACKAGE).
TYPE	VARCHAR2 (32)	Type of module in which subprogram is defined (for example, PACKAGE, PACKAGE_BODY, or PROCEDURE).
FUNCTION	VARCHAR2 (4000)	Name of subprogram (not necessarily a function) (for example, INSERT_ORDER, PROCESS_ITEMS, or TEST). This name might be one of the special function names in Special Function Names (page 15-7). For subprogram B defined within subprogram A, this name is A.B. A recursive call to function X is denoted X@n, where n is the recursion depth. For example, X@1 is the first recursive call to X.
LINE#	NUMBER	Line number in OWNER.MODULE at which FUNCTION is defined.
HASH	RAW (32)	Hash code for signature of subprogram (unique for this run of DBMS_HPROF.analyze).
NAMESPACE	VARCHAR2 (32)	Namespace of subprogram. For details, see Namespaces of Tracked Subprograms (page 15-6).
SUBTREE_ELAPSED_TIME	NUMBER (38)	Elapsed time, in microseconds, for subprogram, including time spent in descendant subprograms.
FUNCTION_ELAPSED_TIME	NUMBER (38)	Elapsed time, in microseconds, for subprogram, excluding time spent in descendant subprograms.
CALLS	NUMBER (38)	Number of calls to subprogram.

Table 15-5 (Cont.) DBMSHP_FUNCTION_INFO Table Columns

Column Name	Column Data Type	Column Contents
SQL_ID	VARCHAR2 (13)	SQL Identifier of the SQL statement.
SQL_TEXT	VARCHAR2 (4000)	First 50 characters of the SQL statement.

[Table 15-6](#) (page 15-11) describes the columns of the hierarchical profiler table `DBMSHP_PARENT_CHILD_INFO`, which contains one row of parent-child information for each unique parent-child subprogram combination profiled in this run of `DBMS_HPROF.analyze`.

Table 15-6 DBMSHP_PARENT_CHILD_INFO Table Columns

Column Name	Column Data Type	Column Contents
RUNID	NUMBER	References RUNID column of <code>DBMSHP_FUNCTION_INFO</code> table. For a description of that column, see Table 15-5 (page 15-10).
PARENTSYMID	NUMBER	Parent symbol ID. RUNID, PARENTSYMID references <code>DBMSHP_FUNCTION_INFO (RUNID, SYMBOLID)</code> .
CHILDSYMID	NUMBER	Child symbol ID. RUNID, CHILDSYMID references <code>DBMSHP_FUNCTION_INFO (RUNID, SYMBOLID)</code> .
SUBTREE_ELAPSED_TIME	NUMBER (38)	Elapsed time, in microseconds, for RUNID, CHILDSYMID when called from RUNID, PARENTSYMID, including time spent in descendant subprograms.
FUNCTION_ELAPSED_TIME	NUMBER (38)	Elapsed time, in microseconds, for RUNID, CHILDSYMID when called from RUNID, PARENTSYMID, excluding time spent in descendant subprograms.
CALLS	NUMBER (38)	Number of calls to RUNID, CHILDSYMID from RUNID, PARENTSYMID.

15.4.2.2 Distinguishing Between Overloaded Subprograms

Overloaded subprograms are different subprograms with the same name (see *Oracle Database PL/SQL Language Reference*).

Suppose that a program declares three subprograms named `compute`—the first at line 50, the second at line 76, and the third at line 100. In the `DBMSHP_FUNCTION_INFO` table, each of these subprograms has `compute` in the `FUNCTION` column. To distinguish between the three subprograms, use either the `LINE#` column (which has

50 for the first subprogram, 76 for the second, and 100 for the third) or the HASH column (which has a unique value for each subprogram).

In the profile data for two different runs, the LINE# and HASH values for a function might differ. The LINE# value of a function changes if you insert or delete lines before the function definition. The HASH value changes only if the signature of the function changes; for example, if you change the parameter list.

15.4.2.3 Hierarchical Profiler Tables for Sample PL/SQL Procedure

The hierarchical profiler tables for the PL/SQL procedure test in [Collecting Profile Data](#) (page 15-2) are shown in [Example 15-3](#) (page 15-12) through [Example 15-5](#) (page 15-13).

Consider the third row of the table DBMSHP_PARENT_CHILD_INFO ([Example 15-5](#) (page 15-13)). The RUNID column shows that this row corresponds to the third run. The columns PARENTSYMID and CHILDSYMID show that the symbol IDs of the parent (caller) and child (called subprogram) are 2 and 1, respectively. The table DBMSHP_FUNCTION_INFO ([Example 15-4](#) (page 15-12)) shows that for the third run, the symbol IDs 2 and 1 correspond to procedures __plsqli_vm and __anonymous_block, respectively. Therefore, the information in this row is about calls from the procedure __plsqli_vm to the __anonymous_block (defined within __plsqli_vm) in the module HR.TEST. This row shows that, when called from the procedure __plsqli_vm, the function time for the procedure __anonymous_block is 44 microseconds, and the time spent in the __anonymous_block subtree (including descendants) is 121 microseconds.

Example 15-3 DBMSHP_RUNS Table for Sample PL/SQL Procedure

RUNID	RUN_TIMESTAMP	TOTAL_ELAPSED_TIME	RUN_COMMENT
1	20-DEC-12 11.37.26.688381 AM		7
2	20-DEC-12 11.37.26.700523 AM		9
3	20-DEC-12 11.37.26.706824 AM		123

Example 15-4 DBMSHP_FUNCTION_INFO Table for Sample PL/SQL Procedure

RUNID	SYMBOLID	OWNER	MODULE	TYPE	FUNCTION
1	1	HR	PKG	PACKAGE BODY	MYPROC
2	1	HR	PKG	PACKAGE BODY	MYFUNC
2	2	HR	PKG	PACKAGE BODY	MYPROC
3	1				__anonymous_block
3	2				__plsqli_vm
3	3	HR	PKG	PACKAGE BODY	MYFUNC
3	4	HR	PKG	PACKAGE BODY	MYPROC
3	5	HR	TEST2	PROCEDURE	TEST2

LINE#	CALLS	HASH	NAMESPACE
2	1	9689BA467A19CD19	PLSQL
7	1	28DC3402BAEB2B0D	PLSQL
2	1	9689BA467A19CD19	PLSQL
0	1		PLSQL
0	1		PLSQL
7	1	28DC3402BAEB2B0D	PLSQL
2	2	9689BA467A19CD19	PLSQL
1	1	980980E97E42F8EC	PLSQL

NAMESPACE	SUBTREE_ELAPSED_TIME	FUNCTION_ELAPSED_TIME

PLSQL	7	7
PLSQL	9	8
PLSQL	1	1
PLSQL	121	44
PLSQL	123	2
PLSQL	9	8
PLSQL	8	8
PLSQL	77	61

Example 15-5 DBMSHP_PARENT_CHILD_INFO Table for Sample PL/SQL Procedure

RUNID	PARENTSYMID	CHILDSYMID	SUBTREE_ELAPSED_TIME	FUNCTION_ELAPSED_TIME	CALLS
2	1	2	1	1	1
3	1	5	77	61	1
3	2	1	121	44	1
3	3	4	1	1	1
3	5	3	9	8	1
3	5	4	7	7	1

15.4.2.4 Examples of Calls to DBMS_HPROF.analyze with Options

For an example of a call to DBMS_HPROF.analyze without options, see [Example 15-2](#) (page 15-8).

[Example 15-6](#) (page 15-13) creates a package, creates a procedure that invokes subprograms in the package, profiles the procedure, and uses DBMS_HPROF.analyze to analyze the raw profiler output file. The raw profiler output file is in the directory corresponding to the PLSHPROF_DIR directory object.

Example 15-6 Invoking DBMS_HPROF.analyze with Options

```
-- Create package

CREATE OR REPLACE PACKAGE pkg AUTHID DEFINER IS
  PROCEDURE myproc (n IN out NUMBER);
  FUNCTION myfunc (v VARCHAR2) RETURN VARCHAR2;
  FUNCTION myfunc (n PLS_INTEGER) RETURN PLS_INTEGER;
END pkg;
/

CREATE OR REPLACE PACKAGE BODY pkg IS
  PROCEDURE myproc (n IN OUT NUMBER) IS
  BEGIN
    n := n + 5;
  END;

  FUNCTION myfunc (v VARCHAR2) RETURN VARCHAR2 IS
    n NUMBER;
  BEGIN
    n := LENGTH(v);
    myproc(n);
    IF n > 20 THEN
      RETURN SUBSTR(v, 1, 20);
    ELSE
      RETURN v || '...';
    END IF;
  END;

  FUNCTION myfunc (n PLS_INTEGER) RETURN PLS_INTEGER IS
    i PLS_INTEGER;
  PROCEDURE myproc (n IN out PLS_INTEGER) IS
  BEGIN
```

```
        n := n + 1;
    END;
BEGIN
    i := n;
    myproc(i);
    RETURN i;
END;
END pkg;
/

-- Create procedure that invokes package subprograms

CREATE OR REPLACE PROCEDURE test2 AUTHID DEFINER IS
    x NUMBER := 5;
    y VARCHAR2(32767);
BEGIN
    pkg.myproc(x);
    y := pkg.myfunc('hello');
END;

-- Profile test2

BEGIN
    DBMS_HPROF.START_PROFILING('PLSHPROF_DIR', 'test2.trc');
END;
/
BEGIN
    test2;
END;
/
BEGIN
    DBMS_HPROF.STOP_PROFILING;
END;
/

-- If not done, create hierarchical profiler tables (see Creating Hierarchical Profiler Tables
(page 15-8)).

-- Call DBMS_HPROF.analyze with options

DECLARE
    runid NUMBER;
BEGIN
    -- Analyze only subtrees rooted at trace entry "HR"."PKG"."MYPROC"

    runid := DBMS_HPROF.analyze('PLSHPROF_DIR', 'test2.trc',
                               trace => 'HR"."PKG"."MYPROC');

    -- Analyze up to 20 calls to subtrees rooted at trace entry
    -- "HR"."PKG"."MYFUNC". Because "HR"."PKG"."MYFUNC" is overloaded,
    -- both overloads are considered for analysis.

    runid := DBMS_HPROF.analyze('PLSHPROF_DIR', 'test2.trc',
                               collect => 20,
                               trace => 'HR"."PKG"."MYFUNC');

    -- Analyze second call to PL/SQL virtual machine

    runid := DBMS_HPROF.analyze('PLSHPROF_DIR', 'test2.trc',
                               skip => 1, collect => 1,
                               trace => '""."".""__plsql_vm');

```

```
END;
/
```

15.5 plshprof Utility

The `plshprof` command-line utility (located in the directory `$ORACLE_HOME/bin/`) generates simple HTML reports from either one or two raw profiler output files. (For an example of a raw profiler output file, see `test.trc` in [Collecting Profile Data](#) (page 15-2).)

You can browse the generated HTML reports in any browser. The browser's navigational capabilities, combined with well chosen links, provide a powerful way to analyze performance of large applications, improve application performance, and lower development costs.

Topics:

- [plshprof Options](#) (page 15-15)
- [HTML Report from a Single Raw Profiler Output File](#) (page 15-15)
- [HTML Difference Report from Two Raw Profiler Output Files](#) (page 15-21)

15.5.1 plshprof Options

The command to run the `plshprof` utility is:

```
plshprof [option...] profiler_output_filename_1 profiler_output_filename_2
```

Each *option* is one of these:

Option	Description	Default
<code>-skip count</code>	Skips first <i>count</i> calls. Use only with <code>-trace symbol</code> .	0
<code>-collect count</code>	Collects information for <i>count</i> calls. Use only with <code>-trace symbol</code> .	1
<code>-output filename</code>	Specifies name of output file	<i>symbol.html</i> or <i>tracefile1.html</i>
<code>-summary</code>	Prints only elapsed time	None
<code>-trace symbol</code>	Specifies function name of tree root	Not applicable

Suppose that your raw profiler output file, `test.trc`, is in the current directory. You want to analyze and generate HTML reports, and you want the root file of the HTML report to be named `report.html`. Use this command (% is the prompt):

```
% plshprof -output report test.trc
```

15.5.2 HTML Report from a Single Raw Profiler Output File

To generate a PL/SQL hierarchical profiler HTML report from a single raw profiler output file, use these commands:

```
% cd target_directory
% plshprof -output html_root_filename profiler_output_filename
```

target_directory is the directory in which you want the HTML files to be created.

html_root_filename is the name of the root HTML file to be created.

profiler_output_filename is the name of a raw profiler output file.

The preceding `plshprof` command generates a set of HTML files. Start browsing them from *html_root_filename.html*.

Topics:

- [First Page of Report](#) (page 15-16)
- [Function-Level Reports](#) (page 15-17)
- [Understanding PL/SQL Hierarchical Profiler SQL-Level Reports](#) (page 15-21)
- [Module-Level Reports](#) (page 15-18)
- [Namespace-Level Reports](#) (page 15-19)
- [Parents and Children Report for a Function](#) (page 15-19)

15.5.2.1 First Page of Report

The first page of an HTML report from a single raw profiler output file includes summary information and hyperlinks to other pages of the report.

Sample First Page

PL/SQL Elapsed Time (microsecs) Analysis

824 microsecs (elapsed time) & 12 function calls

The PL/SQL Hierarchical Profiler produces a collection of reports that present information derived from the profiler output log in a variety of formats. These reports have been found to be the most generally useful as starting points for browsing:

- Function Elapsed Time (microsecs) Data sorted by Total Subtree Elapsed Time (microsecs)
- Function Elapsed Time (microsecs) Data sorted by Total Function Elapsed Time (microsecs)
- SQL ID Elapsed Time (microsecs) Data sorted by SQL ID

In addition, the following reports are also available:

- Function Elapsed Time (microsecs) Data sorted by Function Name
- Function Elapsed Time (microsecs) Data sorted by Total Descendants Elapsed Time (microsecs)
- Function Elapsed Time (microsecs) Data sorted by Total Function Call Count
- Function Elapsed Time (microsecs) Data sorted by Mean Subtree Elapsed Time (microsecs)
- Function Elapsed Time (microsecs) Data sorted by Mean Function Elapsed Time (microsecs)
- Function Elapsed Time (microsecs) Data sorted by Mean Descendants Elapsed Time (microsecs)

- Module Elapsed Time (microsecs) Data sorted by Total Function Elapsed Time (microsecs)
- Module Elapsed Time (microsecs) Data sorted by Module Name
- Module Elapsed Time (microsecs) Data sorted by Total Function Call Count
- Namespace Elapsed Time (microsecs) Data sorted by Total Function Elapsed Time (microsecs)
- Namespace Elapsed Time (microsecs) Data sorted by Namespace
- Namespace Elapsed Time (microsecs) Data sorted by Total Function Call Count
- Parents and Children Elapsed Time (microsecs) Data

15.5.2.2 Function-Level Reports

The function-level reports provide a flat view of the profile information. Each function-level report includes this information for each function:

- Function time (time spent in the function itself, also called "self time")
- Descendants time (time spent in the descendants of the function)
- Subtree time (time spent in the subtree of the function—function time plus descendants time)
- Number of calls to the function
- Function name
The function name is hyperlinked to the Parents and Children Report for the function.
- SQL ID
- SQL Text (First 50 characters of the SQL text).

Each function-level report is sorted on a particular attribute; for example, function time or subtree time.

This sample report is sorted in descending order of the total subtree elapsed time for the function, which is why information in the Subtree and Ind% columns is in **bold type**:

Sample Report

Function Elapsed Time (microsecs) Data sorted by Total Subtree Elapsed Time (microsecs)

824 microsecs (elapsed time) & 12 function calls

Subtree	Ind %	Function	Descendant	Ind %	Calls	Ind %	Function Name	SQL ID	SQL TEXT
824	100%	10	814	98.8%	2	16.7%	__plsq_vm		
814	98.8%	165	649	78.8%	2	16.7%	__anonymous_block		

Subtree	Ind %	Function	Descendant	Ind %	Calls	Ind %	Function Name	SQL ID	SQL TEXT
649	78.8%	11	638	77.4%	1	8.3%	HR.TEST.TEST (Line 1)		
638	77.4%	121	517	62.7%	3	25.0%	HR.TEST.TEST.FO O (Line 4)		
517	62.7%	517	0	0.0%	3	25.0%	HR.TEST.__static_s ql_exec_line5 (Line 6)	3r6qf2qhr 3cm1	SELECT COUNT(*) FROM EMPLOY EES
0	0.0%	0	0	0.0%	1	8.3%	SYS.DBMS_HPROF .STOP_PROFILING (Line 453)		

15.5.2.3 Module-Level Reports

Each module-level report includes this information for each module (for example, package or type):

- Module time (time spent in the module—sum of the function times of all functions in the module)
- Number of calls to functions in the module

Each module-level report is sorted on a particular attribute; for example, module time or module name.

This sample report is sorted by module time, which is why information in the Module, Ind%, and Cum% columns is in **bold type**:

Sample Report

Module Elapsed Time (microsecs) Data sorted by Total Function Elapsed Time (microsecs)

166878 microsecs (elapsed time) & 1099 function calls

Module	Ind%	Cum%	Calls	Ind%	Module Name
84932	50.9%	50.9%	6	0.5%	HR.P
67749	40.6%	91.5%	216	19.7%	SYS.DBMS_LOB
13340	8.0%	99.5%	660	60.1%	SYS.UTL_FILE
839	0.5%	100%	214	19.5%	SYS.UTL_RAW
18	0.0%	100%	2	0.2%	HR.UTILS
0	0.0%	100%	1	0.1%	SYS.DBMS_HPROF

15.5.2.4 Namespace-Level Reports

Each namespace-level report includes this information for each namespace:

- Namespace time (time spent in the namespace—sum of the function times of all functions in the namespace)
- Number of calls to functions in the namespace

Each namespace-level report is sorted on a particular attribute; for example, namespace time or number of calls to functions in the namespace.

This sample report is sorted by function time, which is why information in the Function, Ind%, and Cum% columns is in **bold type**:

Sample Report

Namespace Elapsed Time (microsecs) Data sorted by Total Function Elapsed Time (microsecs)

166878 microsecs (elapsed time) & 1099 function calls

Function	Ind%	Cum%	Calls	Ind%	Namespace
93659	56.1%	56.1%	1095	99.6%	PLSQL
73219	43.9%	100%	4	0.4%	SQL

15.5.2.5 Parents and Children Report for a Function

For each function tracked by the profiler, the Parents and Children Report provides information about parents (functions that call it) and children (functions that it calls). For each parent, the report gives the function's execution profile (subtree time, function time, descendants time, and number of calls). For each child, the report gives the execution profile for the child when called from this function (but not when called from other functions).

The execution profile for a function includes the same information for that function as a function-level report includes for each function (for details, see [Function-Level Reports](#) (page 15-17)).

This [Sample Report](#) (page 15-20) is a fragment of a Parents and Children Report that corresponds to a function named HR.P.UPLOAD. The first row has this summary information:

- There are two calls to the function HR.P.UPLOAD.
- The total subtree time for the function is 166,860 microseconds—11,713 microseconds (7.0%) in the function itself and 155,147 microseconds (93.0%) in its descendants.

After the row "Parents" are the execution profile rows for the two parents of HR.P.UPLOAD, which are HR.UTILS.COPY_IMAGE and HR.UTILS.COPY_FILE.

The first parent execution profile row, for HR.UTILS.COPY_IMAGE, shows:

- HR.UTILS.COPY_IMAGE calls HR.P.UPLOAD once, which is 50% of the number of calls to HR.P.UPLOAD.

- The subtree time for HR.P.UPLOAD when called from HR.UTILS.COPY_IMAGE is 106,325 microseconds, which is 63.7% of the total subtree time for HR.P.UPLOAD.
- The function time for HR.P.UPLOAD when called from HR.UTILS.COPY_IMAGE is 6,434 microseconds, which is 54.9% of the total function time for HR.P.UPLOAD.

After the row "Children" are the execution profile rows for the children of HR.P.UPLOAD when called from HR.P.UPLOAD.

The third child execution profile row, for SYS.UTL_FILE.GET_RAW, shows:

- HR.P.UPLOAD calls SYS.UTL_FILE.GET_RAW 216 times.
- The subtree time, function time and descendants time for SYS.UTL_FILE.GET_RAW when called from HR.P.UPLOAD are 12,487 microseconds, 3,969 microseconds, and 8,518 microseconds, respectively.
- Of the total descendants time for HR.P.UPLOAD (155,147 microseconds), the child SYS.UTL_FILE.GET_RAW is responsible for 12,487 microsecs (8.0%).

Sample Report

HR.P.UPLOAD (Line 3)

Subtree	Ind%	Function	Ind%	Descendant	Ind%	Calls	Ind%	Function Name
166860	100%	11713	7.0%	155147	93.0%	2	0.2%	HR.P.UPLOAD (Line 3)
Parents:								
106325	63.7%	6434	54.9%	99891	64.4%	1	50.0%	HR.UTILS.COPY_IMAGE (Line 3)
60535	36.3%	5279	45.1%	55256	35.6%	1	50.0%	HR.UTILS.COPY_FILE (Line 8)
Children:								
71818	46.3%	71818	100%	0	N/A	2	100%	HR.P.__static_sql_exec_line38 (Line 38)
67649	43.6%	67649	100%	0	N/A	214	100%	SYS.DBMS_LOB.WRITEAPPEND (Line 926)
12487	8.0%	3969	100%	8518	100%	216	100%	SYS.UTL_FILE.GET_RAW (Line 1089)
1401	0.9%	1401	100%	0	N/A	2	100%	HR.P.__static_sql_exec_line39 (Line 39)
839	0.5%	839	100%	0	N/A	214	100%	SYS.UTL_FILE.GET_RAW (Line 246)
740	0.5%	73	100%	667	100%	2	100%	SYS.UTL_FILE.FOPEN (Line 422)

Subtree	Ind%	Function	Ind%	Descendant	Ind%	Calls	Ind%	Function Name
113	0.1%	11	100%	102	100%	2	100%	SYS.UTL_FILE.FCL OSE (Line 585)
100	0.1%	100	100%	0	N/A	2	100%	SYS.DBMS_LOB.CR EATETEMPORARY (Line 536)

15.5.2.6 Understanding PL/SQL Hierarchical Profiler SQL-Level Reports

Understanding DBMS_HPROF.ANALYZE SQL-level reports.

The PL/SQL Hierarchical Profiler SQL-level report provides the list of all the SQLs collected during profiling, along with the abbreviated SQL text, and the elapsed time (microsecs) sorted by SQL ID. The SQL ID is useful if other SQL statistics must be retrieved in other tables, for example, for SQL tuning purpose. The first 50 characters of the SQL text is included in the report. You can use the Function-Level reports to get the details surrounding where the SQL is called, and its location in the source code if needed.

Sample Report

SQL ID Elapsed Time (microsecs) Data sorted by SQL ID

824 microsecs (elapsed time) & 12 function calls

SQL ID	SQL TEXT	Function	Ind%	Calls	Ind%
3r6qf2qhr3c m1	SELECT COUNT(*) FROM EMPLOYEES	679	82.4%	3	25.0%

15.5.3 HTML Difference Report from Two Raw Profiler Output Files

To generate a PL/SQL hierarchical profiler HTML difference report from two raw profiler output files, use these commands:

```
% cd target_directory
% plshprof -output html_root_filename profiler_output_filename_1 profiler_output_filename_2
```

target_directory is the directory in which you want the HTML files to be created.

html_root_filename is the name of the root HTML file to be created.

profiler_output_filename_1 and *profiler_output_filename_2* are the names of raw profiler output files.

The preceding `plshprof` command generates a set of HTML files. Start browsing them from *html_root_filename.html*.

Topics:

- [Difference Report Conventions](#) (page 15-22)
- [First Page of Difference Report](#) (page 15-22)
- [Function-Level Difference Reports](#) (page 15-23)

- [Module-Level Difference Reports](#) (page 15-25)
- [Namespace-Level Difference Reports](#) (page 15-25)
- [Parents and Children Difference Report for a Function](#) (page 15-26)

15.5.3.1 Difference Report Conventions

Difference reports use these conventions:

- In a report title, **Delta** means **difference**, or **change**.
- A **positive value** indicates that the number increased (**regressed**) from the first run to the second run.
- A **negative value** for a difference indicates that the number decreased (**improved**) from the first run to the second run.
- The symbol **#** after a function name means that the function was called in only one run.

15.5.3.2 First Page of Difference Report

The first page of an HTML difference report from two raw profiler output files includes summary information and hyperlinks to other pages of the report.

Sample First Page

PL/SQL Elapsed Time (microsecs) Analysis – Summary Page

This analysis finds a net **regression** of **2709589** microsecs (elapsed time) or **80%** (**3393719** versus **6103308**). Here is a summary of the 7 most important individual function regressions and improvements:

Regressions: 3399382 microsecs (elapsed time)

Function	Rel%	Ind%	Calls	Rel%	Function Name
2075627	+941%	61.1%	0		HR.P.G (Line 35)
1101384	+54.6%	32.4%	5	+55.6%	HR.P.H (Line 18)
222371		6.5%	1		HR.P.J (Line 10)

Improvements: 689793 microsecs (elapsed time)

Function	Rel%	Ind%	Calls	Rel%	Function Name
-467051	-50.0%	67.7%	-2	-50.0%	HR.P.F (Line 25)
-222737		32.3%	-1		HR.P.I (Line 2)#
-5	-21.7%	0.0%	0		HR.P.TEST (Line 46)

The PL/SQL Timing Analyzer produces a collection of reports that present information derived from the profiler's output logs in a variety of formats. The following reports have been found to be the most generally useful as starting points for browsing:

- Function Elapsed Time (microsecs) Data for Performance Regressions
- Function Elapsed Time (microsecs) Data for Performance Improvements

Also, the following reports are also available:

- Function Elapsed Time (microsecs) Data sorted by Function Name
- Function Elapsed Time (microsecs) Data sorted by Total Subtree Elapsed Time (microsecs) Delta
- Function Elapsed Time (microsecs) Data sorted by Total Function Elapsed Time (microsecs) Delta
- Function Elapsed Time (microsecs) Data sorted by Total Descendants Elapsed Time (microsecs) Delta
- Function Elapsed Time (microsecs) Data sorted by Total Function Call Count Delta
- Module Elapsed Time (microsecs) Data sorted by Module Name
- Module Elapsed Time (microsecs) Data sorted by Total Function Elapsed Time (microsecs) Delta
- Module Elapsed Time (microsecs) Data sorted by Total Function Call Count Delta
- Namespace Elapsed Time (microsecs) Data sorted by Namespace
- Namespace Elapsed Time (microsecs) Data sorted by Total Function Elapsed Time (microsecs)
- Namespace Elapsed Time (microsecs) Data sorted by Total Function Call Count
- File Elapsed Time (microsecs) Data Comparison with Parents and Children

15.5.3.3 Function-Level Difference Reports

Each function-level difference report includes, for each function, the change in these values from the first run to the second run:

- Function time (time spent in the function itself, also called "self time")
- Descendants time (time spent in the descendants of the function)
- Subtree time (time spent in the subtree of the function—function time plus descendants time)
- Number of calls to the function
- Mean function time

The mean function time is the function time divided by number of calls to the function.

- Function name

The function name is hyperlinked to the Parents and Children Difference Report for the function.

The report in [Sample Report 1](#) (page 15-24) shows the difference information for all functions that performed better in the first run than they did in the second run. Note that:

- For HR.P.G, the function time increased by 2,075,627 microseconds (941%), which accounts for 61.1% of all regressions.
- For HR.P.H, the function time and number of calls increased by 1,101,384 microseconds (54.6%) and 5 (55.6%), respectively, but the mean function time improved by 1,346 microseconds (-0.6%).
- HR.P.J was called in only one run.

Sample Report 1

Function Elapsed Time (microsecs) Data for Performance Regressions

Subtree	Function	Rel%	Ind %	Cum %	Descendant	Calls	Rel%	Mean Function	Rel%	Function Name
4075787	2075627	+941%	61.1%	61.1%	2000160	0		2075627	+941%	HR.P.G (Line 35)
1101384	1101384	+54.6%	32.4%	93.5%	0	5	+55.6%	-1346	-0.6%	HR.P.H (Line 18)
222371	222371		6.5%	100%	0	1				HR.P.J (Line 10)#

The report in [Sample Report 2](#) (page 15-24) shows the difference information for all functions that performed better in the second run than they did in the first run.

Sample Report 2

Function Elapsed Time (microsecs) Data for Performance Improvements

Subtree	Function	Rel%	Ind %	Cum %	Descendant	Calls	Rel%	Mean Function	Rel%	Function Name
-1365827	-467051	-50.0%	67.7%	67.7%	-898776	-2	-50.0%	-32	0.0%	HR.P.F (Line 25)
-222737	-222737		32.3%	100%	0	-1				HR.P.I (Line 2)
2709589	-5	-21.7%	0.0%	100%	2709594	0		-5	-20.8%	HR.P.TEST (Line 46)#

The report in [Sample Report 3](#) (page 15-24) summarizes the difference information for all functions.

Sample Report 3

Function Elapsed Time (microsecs) Data sorted by Total Function Call Count Delta

Subtree	Function	Rel%	Ind %	Descendant	Calls	Rel%	Mean Function	Rel%	Function Name
1101384	1101384	+54.6%	32.4%	0	5	+55.6%	-1346	-0.6%	HR.P.H (Line 18)
-1365827	-467051	+50.0%	67.7%	-898776	-2	-50.0%	-32	-0.0%	HR.P.F (Line 25)
-222377	-222377		32.3%	0	-1				HR.P.I (Line 2)#
222371	222371		6.5%	0	1				HR.P.J(Line 10)#
4075787	2075627	+941%	61.1%	2000160	0		2075627	+941%	HR.P.G (Line 35)
2709589	-5	-21.7%	0.0%	2709594	0		-5	-20.8%	HR.P.TEST (Line 46)
0	0			0	0				SYS.DBMS_HPROF.STOP_PROFILING (Line 53)

15.5.3.4 Module-Level Difference Reports

Each module-level report includes, for each module, the change in these values from the first run to the second run:

- Module time (time spent in the module—sum of the function times of all functions in the module)
- Number of calls to functions in the module

Sample Report

Module Elapsed Time (microsecs) Data sorted by Total Function Elapsed Time (microsecs) Delta

Module	Calls	Module Name
2709589	3	HR.P
0	0	SYS.DBMS_HPROF

15.5.3.5 Namespace-Level Difference Reports

Each namespace-level report includes, for each namespace, the change in these values from the first run to the second run:

- Namespace time (time spent in the namespace—sum of the function times of all functions in the namespace)
- Number of calls to functions in the namespace

Sample Report**Namespace Elapsed Time (microsecs) Data sorted by Namespace**

Function	Call	Namespaces
2709589	3	PLSQL

15.5.3.6 Parents and Children Difference Report for a Function

The Parents and Children Difference Report for a function shows changes in the execution profiles of these from the first run to the second run:

- Parents (functions that call the function)
 - Children (functions that the function calls)
- Execution profiles for children include only information from when this function calls them, not for when other functions call them.

The execution profile for a function includes this information:

- Function time (time spent in the function itself, also called "self time")
- Descendants time (time spent in the descendants of the function)
- Subtree time (time spent in the subtree of the function—function time plus descendants time)
- Number of calls to the function
- Function name

The sample report is a fragment of a Parents and Children Difference Report that corresponds to a function named HR.P.X.

The first row, a summary of the difference between the first and second runs, shows regression: function time increased by 1,094,099 microseconds (probably because the function was called five more times).

The "Parents" rows show that HR.P.G called HR.P.X nine more times in the second run than it did in the first run, while HR.P.F called it four fewer times.

The "Children" rows show that HR.P.X called each child five more times in the second run than it did in the first run.

Sample Report**HR.P.X (Line 11)**

Subtree	Function	Descendant	Calls	Function Name
3322196	1094099	2228097	5	HR.P.X (Line 11)
Parents:				
6037490	1993169	4044321	9	HR.P.G (Line 38)
-2715294	-899070	-1816224	-4	HR.P.F (Line 28)

Subtree	Function	Descendant	Calls	Function Name
Children				
:				
1125489	1125489	0	5	HR.P.J (Line 10)
1102608	1102608	0	5	HR.P.I (Line 2)

The Parents and Children Difference Report for a function is accompanied by a Function Comparison Report, which shows the execution profile of the function for the first and second runs and the difference between them. This example is the Function Comparison Report for the function HR.P.X:

Sample Report

Elapsed Time (microsecs) for HR.P.X (Line 11) (20.1% of total regression)

HR.P.X (Line 11)	First Trace	Ind%	Second Trace	Ind%	Diff	Diff%
Function Elapsed Time (microsecs)	1999509	26.9%	3093608	24.9%	1094099	+54.7%
Descendants Elapsed Time (microsecs)	4095943	55.1%	6324040	50.9%	2228097	+54.4%
Subtree Elapsed Time (microsecs)	6095452	81.9%	9417648	75.7%	3322196	+54.5%
Function Calls	9	25.0%	14	28.6%	5	+55.6%
Mean Function Elapsed Time (microsecs)	222167.7		220972.0		-1195.7	-0.5%
Mean Descendants Elapsed Time (microsecs)	455104.8		451717.1		-3387.6	-0.7%
Mean Subtree Elapsed Time (microsecs)	677272.4		672689.1		-4583.3	-0.7%

Using PL/SQL Basic Block Coverage to Maintain Quality

The PL/SQL basic block coverage interface helps you ensure some quality, predictability and consistency, by assessing how well your tests exercise your code.

The code coverage measurement tests are typically executed on a test environment, not on a production database. The goal is to maintain or improve the regression tests suite quality over the lifecycle of multiple PL/SQL code releases. PL/SQL code coverage can help you answer questions such as:

- Is your testing suites development keeping up with the development of your new code?
- Do you need more tests?

The PL/SQL basic block coverage interface collects coverage data for PL/SQL units exercised in a test run.

Topics:

- [Overview of PL/SQL Basic Block Coverage](#) (page 16-1)
- [Collecting PL/SQL Code Coverage Data](#) (page 16-2)
- [PL/SQL Code Coverage Tables Description](#) (page 16-2)

See Also:

- *Oracle Database PL/SQL Language Reference* for the `COVERAGE PRAGMA` syntax and semantics
 - *Oracle Database PL/SQL Packages and Types Reference* for more information about using the `DBMS_PLSQL_CODE_COVERAGE` package
 - *Oracle Database PL/SQL Language Reference* for more information about the `PLSQL_OPTIMIZE_LEVEL` compilation parameter
-

16.1 Overview of PL/SQL Basic Block Coverage

The `DBMS_PLSQL_CODE_COVERAGE` package enables you to collect data at the basic block level. PL/SQL developers and testing engineers use code coverage testing results as part of their standard quality assurance metric.

Code coverage is a measure of the percentage of code which is covered by automated tests. A program with high code coverage has less chance of containing bugs than a program with low code coverage. The most important is the percent of basic blocks

executed by a test suite. A basic block is a linear segment of code with no branches. A basic block has a single entry point (no code within a basic block is the destination of a jump instruction) and a single exit point (only the last instruction, or an exception, can move the point of execution to a different basic block). Basic block boundaries cannot be predicted by visual inspection of the code. The compiler generates the blocks that are executed at runtime.

Coverage information at the unit level can be derived accurately by collecting coverage at the basic block level. Utilities can be produced to report and visualize the test coverage results and help identify code that is covered, partially covered, or not covered by tests.

It is not always feasible to write test cases to exercise some basic blocks. It is possible to exclude these blocks from the coverage calculation by marking them using the `COVERAGE` pragma. The source code can be marked as not feasible for coverage either a single basic block, or a range of basic blocks.

16.2 Collecting PL/SQL Code Coverage Data

This example shows you the basic steps to collect and analyze PL/SQL basic block code coverage data using the `DBMS_PLSQL_CODE_COVERAGE` package.

By default, coverage data for all units except wrapped units is collected.

Follow these steps to collect and analyze PL/SQL basic block code coverage data using the `DBMS_PLSQL_CODE_COVERAGE` package.

1. Run the procedure `CREATE_COVERAGE_TABLES` to create the tables required by the package to store the coverage data. You only need to run this step once as part of setup.

```
EXECUTE DBMS_PLSQL_CODE_COVERAGE.CREATE_COVERAGE_TABLES;
```

2. Start the coverage run.

```
DECLARE    testsuite_run NUMBER;
BEGIN
    testsuite_run := DBMS_PLSQL_CODE_COVERAGE.START_COVERAGE(RUN_COMMENT => 'Test
Suite ABC');
END;
/
```

3. Run the tests.
4. Stop the coverage collection and write the data to the collection tables.

```
EXECUTE DBMS_PLSQL_CODE_COVERAGE.STOP_COVERAGE;
```

5. Query the coverage tables to inspect results.

16.3 PL/SQL Code Coverage Tables Description

The following tables are created by the `PLSQL_CODE_COVERAGE.CREATE_COVERAGE_TABLES` procedure to collect code coverage data.

The `DBMS_PCC_RUNS` table contains one row for each execution of the `DBMS_PLSQL_CODE_COVERAGE.START_COVERAGE` function. The primary key is the `RUN_ID`.

Table 16-1 DBMSPCC_RUNS Table Columns

Column Name	Column Data Type	Description
RUN_ID	NUMBER (38)	Unique identifier automatically generated for this run of DBMS_PLSQL_CODE_COVERAGE . START_COVERAGE
RUN_COMMENT	VARCHAR2 (4000)	User comment to identify the run
RUN_OWNER	VARCHAR2 (128)	User who started the run
RUN_TIMESTAMP	DATE	Date timestamp when the run started

The DBMSPCC_UNITS table contains the PL/SQL units information exercised in a run. The primary key is RUN_ID, and OBJECT_ID. The OBJECT_ID and LAST_DDL_TIME allows you to determine if a unit has been modified since the run started by comparing to the object LAST_DDL_TIME in the static data dictionary view ALL_OBJECTS.

Table 16-2 DBMSPCC_UNITS Table Columns

Column Name	Column Data Type	Description
RUN_ID	NUMBER	References the RUN_ID column in the DBMSPCC_RUNS table
OBJECT_ID	NUMBER	Unique identifier for the unit
OWNER	VARCHAR2 (128)	Owner of the unit
NAME	VARCHAR2 (128)	Unit name
TYPE	VARCHAR2 (12)	Unit type
LAST_DDL_TIME	DATE	Date timestamp for the last modification of the unit resulting from a DDL statement captured at run time

The DBMSPCC_BLOCKS table identifies all the blocks in a unit. The block location is indicated by its starting position in the source code (LINE , COL). The primary key is RUN_ID, OBJECT_ID and BLOCK. It is implicit that one block ends at the character position immediately before that of the start of the next. More than one block can start at the same location. If a unit has not been modified since the run started, the source code lines can be extracted from the static data dictionary view ALL_SOURCE.

Table 16-3 DBMSPCC_BLOCKS Table Columns

Column Name	Column Data Type	Description
RUN_ID	NUMBER (38)	References the RUN_ID column in the DBMSPCC_UNITS table
OBJECT_ID	NUMBER (38)	References the OBJECT_ID in the DBMSPCC_UNITS table
BLOCK	NUMBER (38)	Basic block number
LINE	NUMBER (38)	Starting line number of the basic block
COL	NUMBER (38)	Starting column number of basic block
COVERED	NUMBER (1)	Set to 1 if a basic block is covered, or to 0 otherwise
NOT_FEASIBLE	NUMBER (1)	Set to 1 if a basic block is marked as NOT_FEASIBLE, or to 0 otherwise

Developing PL/SQL Web Applications

Note:

The use of the technologies described in this chapter is suitable for applications that require tight control of the HTTP communication and HTML generation. For others applications, you are encouraged to use Oracle Application Express, which provides more features and a convenient graphical interface to ease application development.

For information about using Oracle Application Express, see *Oracle Database 2 Day + Application Express Developer's Guide*.

This chapter explains how to develop PL/SQL web applications, which let you make your database available on the intranet.

Topics:

- [Overview of PL/SQL Web Applications](#) (page 17-1)
- [Implementing PL/SQL Web Applications](#) (page 17-2)
- [Using mod_plsql Gateway to Map Client Requests to a PL/SQL Web Application](#) (page 17-4)
- [Using Embedded PL/SQL Gateway](#) (page 17-5)
- [Generating HTML Output with PL/SQL](#) (page 17-22)
- [Passing Parameters to PL/SQL Web Applications](#) (page 17-22)
- [Performing Network Operations in PL/SQL Subprograms](#) (page 17-28)

17.1 Overview of PL/SQL Web Applications

Typically, a web application written in PL/SQL is a set of stored subprograms that interact with web browsers through HTTP. A set of interlinked, dynamically generated HTML pages forms the user interface of a web application.

The program flow of a PL/SQL web application is similar to that in a CGI PERL script. Developers often use CGI scripts to produce web pages dynamically, but such scripts are often not optimal for accessing the database. Delivering web content with PL/SQL stored subprograms provides the power and flexibility of database processing. For example, you can use data manipulation language (DML) statements, dynamic SQL statements, and cursors. You also eliminate the process overhead of forking a new CGI process to handle each HTTP request.

[Figure 17-1](#) (page 17-2) illustrates the generic process for a PL/SQL web application.

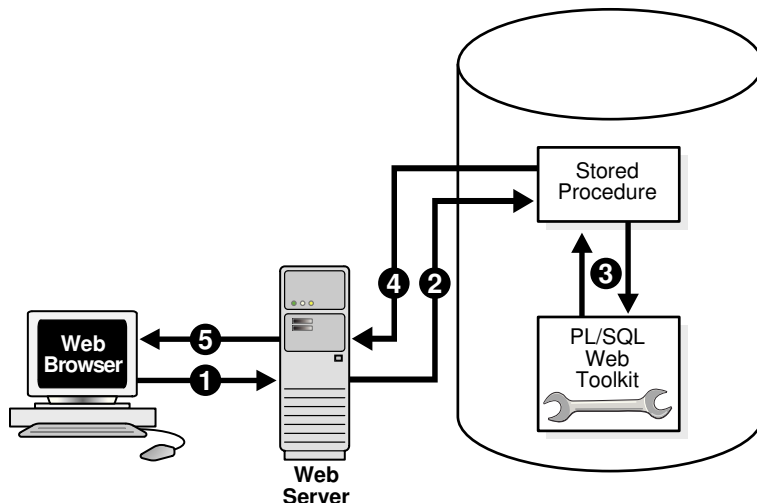
Figure 17-1 PL/SQL Web Application

17.2 Implementing PL/SQL Web Applications

You can implement a web browser-based application entirely in PL/SQL with PL/SQL Gateway or with PL/SQL Web Toolkit.

Topics:

- [PL/SQL Gateway](#) (page 17-2)
- [PL/SQL Web Toolkit](#) (page 17-3)

17.2.1 PL/SQL Gateway

The PL/SQL gateway enables a web browser to invoke a PL/SQL stored subprogram through an HTTP listener. The gateway is a platform on which PL/SQL users develop and deploy PL/SQL web applications.

17.2.1.1 mod_plsql

`mod_plsql` is one implementation of the PL/SQL gateway. The module is a plug-in of Oracle HTTP Server and enables web browsers to invoke PL/SQL stored subprograms. Oracle HTTP Server is a component of both Oracle Application Server and the database.

The `mod_plsql` plug-in enables you to use PL/SQL stored subprograms to process HTTP requests and generate responses. In this context, an HTTP request is a URL that includes parameter values to be passed to a stored subprogram. PL/SQL gateway translates the URL, invokes the stored subprogram with the parameters, and returns output (typically HTML) to the client.

Some advantages of using `mod_plsql` over the embedded form of the PL/SQL gateway are:

- You can run it in a firewall environment in which the Oracle HTTP Server runs on a firewall-facing host while the database is hosted behind a firewall. You cannot use this configuration with the embedded gateway.
- The embedded gateway does not support `mod_plsql` features such as dynamic HTML caching, system monitoring, and logging in the Common Log Format.

17.2.1.2 Embedded PL/SQL Gateway

You can use an embedded version of the PL/SQL gateway that runs in the XML DB HTTP Listener in the database. It provides the core features of `mod_plsql` in the database but does not require the Oracle HTTP Server. You configure the embedded PL/SQL gateway with the `DBMS_EPG` package in the PL/SQL Web Toolkit.

Some advantages of using the embedded gateway instead of `mod_plsql` are:

- You can invoke PL/SQL web applications like Application Express without installing Oracle HTTP Server, thereby simplifying installation, configuration, and administration of PL/SQL based web applications.
- You use the same configuration approach that is used to deliver content from Oracle XML DB in response to FTP and HTTP requests.

17.2.2 PL/SQL Web Toolkit

This set of PL/SQL packages is a generic interface that enables you to use stored subprograms invoked by `mod_plsql` at run time.

In response to a browser request, a PL/SQL subprogram updates or retrieves data from Oracle Database according to the user input. It then generates an HTTP response to the browser, typically in the form of a file download or HTML to be displayed. The PL/SQL Web Toolkit API enables stored subprograms to perform actions such as:

- Obtain information about an HTTP request
- Generate HTTP headers such as content-type and mime-type
- Set browser cookies
- Generate HTML pages

Table 17-1 (page 17-3) describes commonly used PL/SQL Web Toolkit packages.

Table 17-1 Commonly Used Packages in the PL/SQL Web Toolkit

Package	Description of Contents
HTF	Function versions of the subprograms in the <code>http</code> package. The function versions do not directly generate output in a web page. Instead, they pass their output as return values to the statements that invoke them. Use these functions when you must nest function calls.
HTP	Subprograms that generate HTML tags. For example, the procedure <code>http.anchor</code> generates the HTML anchor tag, <code><A></code> .
OWA_CACHE	Subprograms that enable the PL/SQL gateway cache feature to improve performance of your PL/SQL web application. You can use this package to enable expires-based and validation-based caching with the PL/SQL gateway file system.
OWA_COOKIE	Subprograms that send and retrieve HTTP cookies to and from a client web browser. Cookies are strings a browser uses to maintain state between HTTP calls. State can be maintained throughout a client session or longer if a cookie expiration date is included.
OWA_CUSTOM	The authorize function used by cookies.

Table 17-1 (Cont.) Commonly Used Packages in the PL/SQL Web Toolkit

Package	Description of Contents
OWA_IMAGE	Subprograms that obtain the coordinates where a user clicked an image. Use this package when you have an image map whose destination links invoke a PL/SQL gateway.
OWA_OPT_LOCK	Subprograms that impose database optimistic locking strategies to prevent lost updates. Lost updates can otherwise occur if a user selects, and then attempts to update, a row whose values were changed in the meantime by another user.
OWA_PATTERN	Subprograms that perform string matching and string manipulation with regular expressions.
OWA_SEC	Subprograms used by the PL/SQL gateway for authenticating requests.
OWA_TEXT	Subprograms used by package OWA_PATTERN for manipulating strings. You can also use them directly.
OWA_UTIL	These types of utility subprograms: <ul style="list-style-type: none"> • Dynamic SQL utilities to produce pages with dynamically generated SQL code. • HTML utilities to retrieve the values of CGI environment variables and perform URL redirects. • Date utilities for correct date-handling. Date values are simple strings in HTML, but must be properly treated as an Oracle Database data type.
WPG_DOCLOAD	Subprograms that download documents from a document repository that you define using the DAD configuration.

See Also:

Oracle Database PL/SQL Packages and Types Reference for syntax, descriptions, and examples for the PL/SQL Web Toolkit packages

17.3 Using mod_plsql Gateway to Map Client Requests to a PL/SQL Web Application

As explained in detail in the *Oracle HTTP Server mod_plsql User's Guide*, mod_plsql maps web client requests to PL/SQL stored subprograms over HTTP. See this documentation for instructions.

See Also:

- *Oracle HTTP Server mod_plsql User's Guide* to learn how to configure and use mod_plsql
- *Oracle Fusion Middleware Administrator's Guide for Oracle HTTP Server* for information about the mod_plsql module

17.4 Using Embedded PL/SQL Gateway

The embedded gateway functions very similar to the `mod_plsql` gateway. Before using the embedded version of the gateway, familiarize yourself with the *Oracle HTTP Server mod_plsql User's Guide*. Much of the information is the same or similar.

Topics:

- [How Embedded PL/SQL Gateway Processes Client Requests](#) (page 17-5)
- [Installing Embedded PL/SQL Gateway](#) (page 17-6)
- [Configuring Embedded PL/SQL Gateway](#) (page 17-6)
- [Invoking PL/SQL Stored Subprograms Through Embedded PL/SQL Gateway](#) (page 17-19)
- [Securing Application Access with Embedded PL/SQL Gateway](#) (page 17-19)
- [Restrictions in Embedded PL/SQL Gateway](#) (page 17-19)
- [Using Embedded PL/SQL Gateway: Scenario](#) (page 17-20)

17.4.1 How Embedded PL/SQL Gateway Processes Client Requests

Figure 17-2 (page 17-5) illustrates the process by which the embedded gateway handles client HTTP requests.

Figure 17-2 Processing Client Requests with Embedded PL/SQL Gateway

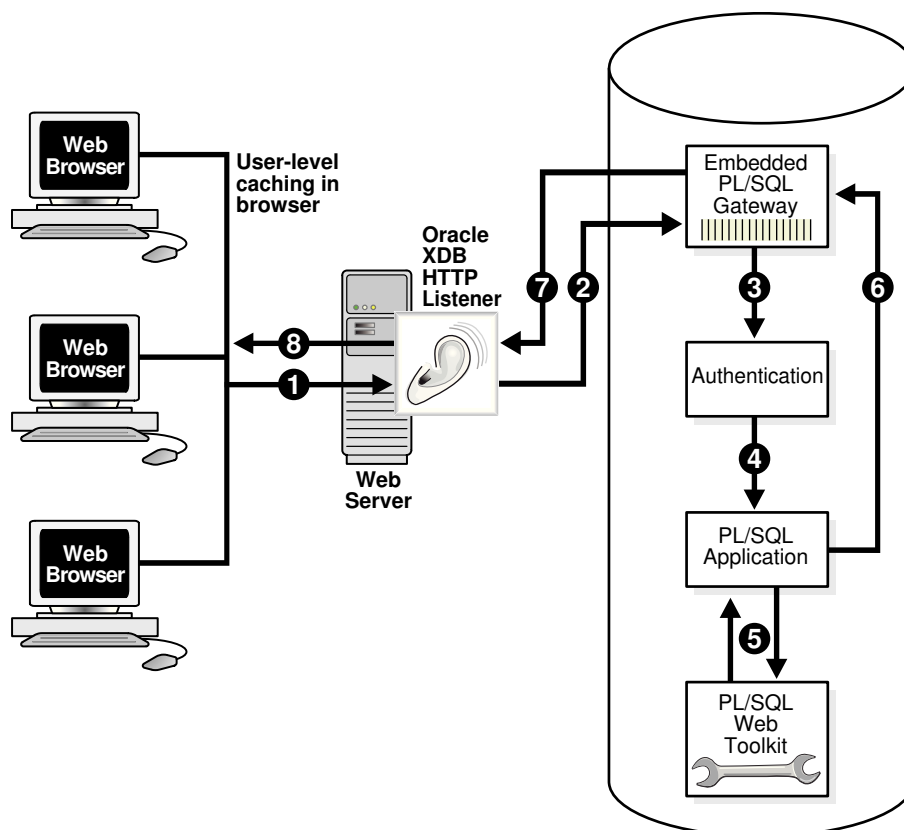

The explanation of the steps in [Figure 17-2](#) (page 17-5) is as follows:

1. The Oracle XML DB HTTP Listener receives a request from a client browser to request to invoke a PL/SQL subprogram. The subprogram can either be written directly in PL/SQL or indirectly generated when a PL/SQL Server Page is uploaded to the database and compiled.
2. The XML DB HTTP Listener routes the request to the embedded PL/SQL gateway as specified in its virtual-path mapping configuration.
3. The embedded gateway uses the HTTP request information and the gateway configuration to determine which database account to use for authentication.
4. The embedded gateway prepares the call parameters and invokes the PL/SQL subprogram in the application.
5. The PL/SQL subprogram generates an HTML page out of relational data and the PL/SQL Web Toolkit accessed from the database.
6. The application sends the page to the embedded gateway.
7. The embedded gateway sends the page to the XML DB HTTP Listener.
8. The XML DB HTTP Listener sends the page to the client browser.

Unlike `mod_plsql`, the embedded gateway processes HTTP requests with the Oracle XML DB Listener. This listener is the same server-side process as the Oracle Net Listener and supports Oracle Net Services, HTTP, and FTP.

Configure general HTTP listener settings through the XML DB interface (for instructions, see *Oracle XML DB Developer's Guide*). Configure the HTTP listener either by using Oracle Enterprise Manager Cloud Control (Cloud Control) or by editing the `xdbconfig.xml` file. Use the `DBMS_EPG` package for all embedded PL/SQL gateway configuration, for example, creating or setting attributes for a DAD.

17.4.2 Installing Embedded PL/SQL Gateway

The embedded gateway requires these components:

- XML DB HTTP Listener
- PL/SQL Web Toolkit

The embedded PL/SQL gateway is installed as part of Oracle XML DB. If you are using a preconfigured database created during an installation or by the Database Configuration Assistant (DBCA), then Oracle XML DB is installed and configured. For information about manually adding Oracle XML DB to an existing database, see *Oracle XML DB Developer's Guide*.

The PL/SQL Web Toolkit is part of the standard installation of the database, so no supplementary installation is necessary.

17.4.3 Configuring Embedded PL/SQL Gateway

You configure `mod_plsql` by editing the Oracle HTTP Server configuration files. Because the embedded gateway is installed as part of the Oracle XML DB HTTP Listener, you manage the embedded gateway as a servlet through the Oracle XML DB servlet management interface.

The configuration interface to the embedded gateway is the PL/SQL package `DBMS_EPG`. This package modifies the underlying `xdbconfig.xml` configuration file that XML DB uses. The default values of the embedded gateway configuration parameters are sufficient for most users.

Topics:

- [Configuring Embedded PL/SQL Gateway: Overview](#) (page 17-7)
- [Configuring User Authentication for Embedded PL/SQL Gateway](#) (page 17-10)

17.4.3.1 Configuring Embedded PL/SQL Gateway: Overview

As in `mod_plsql`, each request for a PL/SQL stored subprogram is associated with a **Database Access Descriptor (DAD)**. A DAD is a set of configuration values used for database access. A DAD specifies information such as:

- The database account to use for authentication
- The subprogram to use for uploading and downloading documents

In the embedded PL/SQL gateway, a DAD is represented as a servlet in the XML DB HTTP Listener configuration. Each DAD attribute maps to an XML element in the configuration file `xdbconfig.xml`. The value of the DAD attribute corresponds to the element content. For example, the `database-username` DAD attribute corresponds to the `<database-username>` XML element; if the value of the DAD attribute is `HR` it corresponds to `<database-username>HR<database-username>`. DAD attribute names are case-sensitive.

Use the `DBMS_EPG` package to perform these embedded PL/SQL gateway configurations:

1. Create a DAD with the `DBMS_EPG.CREATE_DAD` procedure.
2. Set DAD attributes with the `DBMS_EPG.SET_DAD_ATTRIBUTE` procedure.

All DAD attributes are optional. If you do not specify an attribute, it has its initial value.

[Table 17-2](#) (page 17-7) lists the embedded PL/SQL gateway attributes and the corresponding `mod_plsql` DAD parameters. Enumeration values in the "Legal Values" column are case-sensitive.

Table 17-2 Mapping Between `mod_plsql` and Embedded PL/SQL Gateway DAD Attributes

<code>mod_plsql</code> DAD Attribute	Embedded PL/SQL Gateway DAD Attribute	Multiple Occurrences	Legal Values
<code>PlsqlAfterProcedure</code>	<code>after-procedure</code>	No	String
<code>PlsqlAlwaysDescribeProcedure</code>	<code>always-describe-procedure</code>	No	Enumeration of On, Off
<code>PlsqlAuthenticationMode</code>	<code>authentication-mode</code>	No	Enumeration of Basic, SingleSignOn, GlobalOwa, CustomOwa, PerPackageOwa

Table 17-2 (Cont.) Mapping Between mod_plsql and Embedded PL/SQL Gateway DAD Attributes

mod_plsql DAD Attribute	Embedded PL/SQL Gateway DAD Attribute	Multiple Occurrences	Legal Values
PlsqlBeforeProcedure	before-procedure	No	String
PlsqlBindBucketLengths	bind-bucket-lengths	Yes	Unsigned integer
PlsqlBindBucketWidths	bind-bucket-widths	Yes	Unsigned integer
PlsqlCGIEnvironmentList	cgi-environment-list	Yes	String
PlsqlCompatibilityMode	compatibility-mode	No	Unsigned integer
PlsqlDatabaseUsername	database-username	No	String
PlsqlDefaultPage	default-page	No	String
PlsqlDocumentPath	document-path	No	String
PlsqlDocumentProcedure	document-procedure	No	String
PlsqlDocumentTablename	document-table-name	No	String
PlsqlErrorStyle	error-style	No	Enumeration of ApacheStyle, ModplsqlStyle, DebugStyle
PlsqlExclusionList	exclusion-list	Yes	String
PlsqlFetchBufferSize	fetch-buffer-size	No	Unsigned integer
PlsqlInfoLogging	info-logging	No	Enumeration of InfoDebug
PlsqlInputFilterEnable	input-filter-enable	No	String
PlsqlMaxRequestsPerSession	max-requests-per-session	No	Unsigned integer
PlsqlNLSLanguage	nls-language	No	String
PlsqlOWADebugEnable	owa-debug-enable	No	Enumeration of On, Off
PlsqlPathAlias	path-alias	No	String
PlsqlPathAliasProcedure	path-alias-procedure	No	String
PlsqlRequestValidationFunction	request-validation-function	No	String
PlsqlSessionCookieName	session-cookie-name	No	String

Table 17-2 (Cont.) Mapping Between mod_plsql and Embedded PL/SQL Gateway DAD Attributes

mod_plsql DAD Attribute	Embedded PL/SQL Gateway DAD Attribute	Multiple Occurrences	Legal Values
PlsqlSessionStateManagement	session-state-management	No	Enumeration of StatelessWithResetPackageState, StatelessWithFastRestPackageState, StatelessWithPreservePackageState
PlsqlTransferMode	transfer-mode	No	Enumeration of Char, Raw
PlsqlUploadAsLongRaw	upload-as-long-raw	No	String

The default values of the DAD attributes are sufficient for most users of the embedded gateway. mod_plsql users do not need these attributes:

- PlsqlDatabasePassword
- PlsqlDatabaseConnectionString (because the embedded gateway does not support logon to external databases)

Like the DAD attributes, the global configuration parameters are optional. [Table 17-3](#) (page 17-9) describes the DBMS_EPG global attributes and the corresponding mod_plsql global parameters.

Table 17-3 Mapping Between mod_plsql and Embedded PL/SQL Gateway Global Attributes

mod_plsql DAD Attribute	Embedded PL/SQL Gateway DAD Attribute	Multiple Occurrences	Legal Values
PlsqlLogLevel	log-level	No	Unsigned integer
PlsqlMaxParameters	max-parameters	No	Unsigned integer

See Also:

- *Oracle Fusion Middleware Administrator's Guide for Oracle HTTP Server* for detailed descriptions of the mod_plsql DAD attributes. See this documentation for default values and usage notes.
 - *Oracle Database PL/SQL Packages and Types Reference* to learn about the DBMS_EPG package
 - *Oracle XML DB Developer's Guide* for an account of the xdbconfig.xml file
-
-

17.4.3.2 Configuring User Authentication for Embedded PL/SQL Gateway

Because it uses the XML DB authentication schemes, the embedded gateway handles database authentication differently from `mod_plsql`. In particular, it does not store database passwords in a DAD.

Note:

To serve a PL/SQL web application on the Internet but maintain the database behind a firewall, do not use the embedded PL/SQL gateway to run the application; use `mod_plsql`.

Use the `DBMS_EPG` package to configure database authentication.

Topics:

- [Configuring Static Authentication with DBMS_EPG](#) (page 17-10)
- [Configuring Dynamic Authentication with DBMS_EPG](#) (page 17-11)
- [Configuring Anonymous Authentication with DBMS_EPG](#) (page 17-12)
- [Determining the Authentication Mode of a DAD](#) (page 17-12)
- [Examples: Creating and Configuring DADs](#) (page 17-13)
- [Example: Determining the Authentication Mode for a DAD](#) (page 17-15)
- [Example: Determining the Authentication Mode for All DADs](#) (page 17-16)
- [Example: Showing DAD Authorizations that Are Not in Effect](#) (page 17-16)
- [Examining Embedded PL/SQL Gateway Configuration](#) (page 17-17)

17.4.3.2.1 Configuring Static Authentication with DBMS_EPG

Static authentication is for the `mod_plsql` user who stores database user names and passwords in the DAD so that the browser user is not required to enter database authentication information.

To configure static authentication, follow these steps:

1. Log on to the database as an XML DB administrator (that is, a user with the `XDBADMIN` role assigned).
2. Create the DAD. For example, this procedure creates a DAD invoked `HR_DAD` and maps the virtual path to `/hrweb/`:

```
EXEC DBMS_EPG.CREATE_DAD('HR_DAD', '/hrweb/*');
```

3. For this step, you need the `ALTER ANY USER` system privilege. Set the DAD attribute `database-username` to the database account whose privileges must be used by the DAD. For example, this procedure specifies that the DAD named `HR_DAD` has the privileges of the `HR` account:

```
EXEC DBMS_EPG.SET_DAD_ATTRIBUTE('HR_DAD', 'database-username', 'HR');
```

The DAD attribute `database-username` is case-sensitive.

4. Assign the DAD the privileges of the database user specified in the previous step. This authorization enables end users to invoke procedures and access document tables through the embedded PL/SQL gateway with the privileges of the authorized account. For example:

```
EXEC DBMS_EPG.AUTHORIZE_DAD('HR_DAD', 'HR');
```

Alternatively, you can log off as the user with XDBADMIN privileges, log on as the database user whose privileges must be used by the DAD, and then use this command to assign these privileges to the DAD:

```
EXEC DBMS_EPG.AUTHORIZE_DAD('HR_DAD');
```

Note:

Multiple users can authorize the same DAD. The `database-username` attribute setting of the DAD determines which user's privileges to use.

Unlike `mod_plsql`, the embedded gateway connects to the database as the special user `ANONYMOUS`, but accesses database objects with the user privileges assigned to the DAD. The database rejects access if the browser user attempts to connect explicitly with the HTTP Authorization header.

Note:

The account `ANONYMOUS` is locked after XML DB installation. To use static authentication with the embedded PL/SQL gateway, first unlock this account.

17.4.3.2.2 Configuring Dynamic Authentication with DBMS_EPG

Dynamic authentication is for the `mod_plsql` user who does not store database user names and passwords in the DAD.

In dynamic authentication, a database user does not have to authorize the embedded gateway to use its privileges to access database objects. Instead, browser users must supply the database authentication information through the HTTP Basic Authentication scheme.

The action of the embedded gateway depends on whether the `database-username` attribute is set for the DAD. If the attribute is not set, then the embedded gateway connects to the database as the user supplied by the browser client. If the attribute is set, then the database restricts access to the user specified in the `database-username` attribute.

To set up dynamic authentication, follow these steps:

1. Log on to the database as a an XML DB administrator (that is, a user with the XDBADMIN role).
2. Create the DAD. For example, this procedure creates a DAD invoked `DYNAMIC_DAD` and maps the virtual path to `/hrweb/`:

```
EXEC DBMS_EPG.CREATE_DAD('DYNAMIC_DAD', '/hrweb/*');
```

3. Optionally, set the DAD attribute `database-username` to the database account whose privileges must be used by the DAD. The browser prompts the user to enter the username and password for this account when accessing the DAD. For

example, this procedure specifies that the DAD named `DYNAMIC_DAD` has the privileges of the HR account:

```
EXEC DBMS_EPG.SET_DAD_ATTRIBUTE('DYNAMIC_DAD', 'database-username', 'HR');
```

The attribute `database-username` is case-sensitive.

WARNING:

Passwords sent through the HTTP Basic Authentication scheme are not encrypted. Configure the embedded gateway to use the HTTPS protocol to protect the passwords sent by the browser clients.

17.4.3.2.3 Configuring Anonymous Authentication with DBMS_EPG

Anonymous authentication is for the `mod_plsql` user who creates a special DAD database user for database logon, but stores the application procedures and document tables in a different schema and grants access to the procedures and document tables to `PUBLIC`.

To set up anonymous authentication, follow these steps:

1. Log on to the database as an XML DB administrator, that is, a user with the `XDBADMIN` role assigned.
2. Create the DAD. For example, this procedure creates a DAD invoked `HR_DAD` and maps the virtual path to `/hrweb/`:

```
EXEC DBMS_EPG.CREATE_DAD('HR_DAD', '/hrweb/*');
```

3. Set the DAD attribute `database-username` to `ANONYMOUS`. For example:

```
EXEC DBMS_EPG.SET_DAD_ATTRIBUTE('HR_DAD', 'database-username', 'ANONYMOUS');
```

Both `database-username` and `ANONYMOUS` are case-sensitive.

You need not authorize the embedded gateway to use `ANONYMOUS` privileges to access database objects, because `ANONYMOUS` has no system privileges and owns no database objects.

17.4.3.2.4 Determining the Authentication Mode of a DAD

If you know the name of a DAD, then the authentication mode for this DAD depends on these factors:

- Does the DAD exist?
- Is the `database-username` attribute for the DAD set?
- Is the DAD authorized to use the privilege of the `database-username` user?
- Is the `database-username` attribute the one that the user authorized to use the DAD?

[Table 17-4](#) (page 17-13) shows how the answers to the preceding questions determine the authentication mode.

Table 17-4 Authentication Possibilities for a DAD

DAD Exists?	database-username set?	User authorized?	Mode
Yes	Yes	Yes	Static
Yes	Yes	No	Dynamic restricted
Yes	No	Does not matter	Dynamic
Yes	Yes (to ANONYMOUS)	Does not matter	Anonymous
No			N/A

For example, assume that you create a DAD named MY_DAD. If the database-username attribute for MY_DAD is set to HR, but the HR user does not authorize MY_DAD, then the authentication mode for MY_DAD is dynamic and restricted. A browser user who attempts to run a PL/SQL subprogram through MY_DAD is prompted to enter the HR database username and password.

The DBA_EPG_DAD_AUTHORIZATION view shows which users have authorized use of a DAD. The DAD_NAME column displays the name of the DAD; the USERNAME column displays the user whose privileges are assigned to the DAD. The DAD authorized might not exist.

See Also:

Oracle Database Reference for more information about the DBA_EPG_DAD_AUTHORIZATION view

17.4.3.2.5 Examples: Creating and Configuring DADs

[Example 17-1](#) (page 17-14) does this:

- Creates a DAD with static authentication for database user HR and assigns it the privileges of the HR account, which then authorizes it.
- Creates a DAD with dynamic authentication that is not restricted to any user.
- Creates a DAD with dynamic authentication that is restricted to the HR account.

The creation and authorization of a DAD are independent; therefore you can:

- Authorize a DAD that does not exist (it can be created later)
- Authorize a DAD for which you are not the user (however, the authorization does not take effect until the DAD database-user attribute is changed to your username)

[Example 17-2](#) (page 17-14) creates a DAD with static authentication for database user HR and assigns it the privileges of the HR account. Then:

- Instead of authorizing that DAD, the database user HR authorizes a nonexistent DAD.

Although the user might have done this by mistake, no error occurs, because the nonexistent DAD might be created later.

- The database user OE authorizes the DAD (whose database-user attribute is set to HR).

No error occurs, but the authorization does not take effect until the DAD database-user attribute is changed to OE.

Example 17-1 Creating and Configuring DADs

```
-----
--- DAD with static authentication
-----
```

```
CONNECT SYSTEM AS SYSDBA
PASSWORD: password
EXEC DBMS_EPG.CREATE_DAD('Static_Auth_DAD', '/static/*');
EXEC DBMS_EPG.SET_DAD_ATTRIBUTE('Static_Auth_DAD', 'database-username', 'HR');
GRANT EXECUTE ON DBMS_EPG TO HR;
```

```
-- Authorization
CONNECT HR
PASSWORD: password
EXEC DBMS_EPG.AUTHORIZE_DAD('Static_Auth_DAD');
```

```
-----
-- DAD with dynamic authentication
-----
```

```
CONNECT SYSTEM AS SYSDBA
PASSWORD: password
EXEC DBMS_EPG.CREATE_DAD('Dynamic_Auth_DAD', '/dynamic/*');
```

```
-----
-- DAD with dynamic authentication restricted
-----
```

```
EXEC DBMS_EPG.CREATE_DAD('Dynamic_Auth_DAD_Restricted', '/dynamic/*');
EXEC DBMS_EPG.SET_DAD_ATTRIBUTE
  ('Dynamic_Auth_DAD_Restricted', 'database-username', 'HR');
```

Example 17-2 Authorizing DADs to be Created or Changed Later

```
REM Create DAD with static authentication for database user HR
```

```
CONNECT SYSTEM AS SYSDBA
PASSWORD: password
EXEC DBMS_EPG.CREATE_DAD('Static_Auth_DAD', '/static/*');
EXEC DBMS_EPG.SET_DAD_ATTRIBUTE('Static_Auth_DAD', 'database-username', 'HR');
GRANT EXECUTE ON DBMS_EPG TO HR;
```

```
REM Database user HR authorizes DAD that does not exist
```

```
CONNECT HR
PASSWORD: password
EXEC DBMS_EPG.AUTHORIZE_DAD('Static_Auth_DAD_Typo');
```

```
REM Database user OE authorizes DAD with database-username 'HR'
```

```
CONNECT OE
PASSWORD: password
EXEC DBMS_EPG.AUTHORIZE_DAD('Static_Auth_DAD');
```

17.4.3.2.6 Example: Determining the Authentication Mode for a DAD

[Example 17-3](#) (page 17-15) creates a PL/SQL procedure, `show_dad_auth_status`, which accepts the name of a DAD and reports its authentication mode. If the specified DAD does not exist, the procedure exits with an error.

Assume that you have run the script in [Example 17-1](#) (page 17-14) to create and configure various DADs. The output is:

```
SET SERVEROUTPUT ON;
BEGIN
  show_dad_auth_status('Static_Auth_DAD');
END;
/
'Static_Auth_DAD' is set up for static authentication for user 'HR'.
```

Example 17-3 Determining the Authentication Mode for a DAD

```
CREATE OR REPLACE PROCEDURE show_dad_auth_status (p_dadname VARCHAR2) IS
  v_daduser VARCHAR2(128);
  v_cnt      PLS_INTEGER;
BEGIN
  -- Determine DAD user
  v_daduser := DBMS_EPG.GET_DAD_ATTRIBUTE(p_dadname, 'database-username');

  -- Determine whether DAD authorization exists for DAD user
  SELECT COUNT(*)
  INTO v_cnt
  FROM DBA_EPG_DAD_AUTHORIZATION da
  WHERE da.DAD_NAME = p_dadname
  AND da.USERNAME = v_daduser;

  -- If DAD authorization exists for DAD user, authentication mode is static
  IF (v_cnt > 0) THEN
    DBMS_OUTPUT.PUT_LINE (
      ''' || p_dadname ||
      ''' is set up for static authentication for user ''' ||
      v_daduser || '''.');
    RETURN;
  END IF;

  -- If no DAD authorization exists for DAD user, authentication mode is dynamic

  -- Determine whether dynamic authentication is restricted to particular user
  IF (v_daduser IS NOT NULL) THEN
    DBMS_OUTPUT.PUT_LINE (
      ''' || p_dadname ||
      ''' is set up for dynamic authentication for user ''' ||
      v_daduser || ''' only.'');
  ELSE
    DBMS_OUTPUT.PUT_LINE (
      ''' || p_dadname ||
      ''' is set up for dynamic authentication for any user.'');
  END IF;
END;
/
```

17.4.3.2.7 Example: Determining the Authentication Mode for All DADs

The anonymous block in [Example 17-4](#) (page 17-16) reports the authentication modes of all registered DADs. It invokes the `show_dad_auth_status` procedure from [Example 17-3](#) (page 17-15).

If you have run the script in [Example 17-1](#) (page 17-14) to create and configure various DADs, the output of [Example 17-4](#) (page 17-16) is:

```
----- Authorization Status for All DADs -----
'Static_Auth_DAD' is set up for static auth for user 'HR'.
'Dynamic_Auth_DAD' is set up for dynamic auth for any user.
'Dynamic_Auth_DAD_Restricted' is set up for dynamic auth for user 'HR' only.
```

Example 17-4 Showing the Authentication Mode for All DADs

```
DECLARE
  v_dad_names DBMS_EPG.VARCHAR2_TABLE;
BEGIN
  DBMS_OUTPUT.PUT_LINE
    ('----- Authorization Status for All DADs -----');
  DBMS_EPG.GET_DAD_LIST(v_dad_names);

  FOR i IN 1..v_dad_names.count LOOP
    show_dad_auth_status(v_dad_names(i));
  END LOOP;
END;
/
```

17.4.3.2.8 Example: Showing DAD Authorizations that Are Not in Effect

The anonymous block in [Example 17-5](#) (page 17-16) reports DAD authorizations that are *not* in effect. A DAD authorization is not in effect in either of these situations:

- The user who authorizes the DAD is not the user specified by the database-username attribute of the DAD
- The user authorizes a DAD that does not exist

If you have run the script in [Example 17-2](#) (page 17-14) to create and configure various DADs, the output of [Example 17-5](#) (page 17-16) (reformatted to fit on the page) is:

```
----- DAD Authorizations Not in Effect -----
DAD authorization of 'Static_Auth_DAD' by user 'OE' is not in effect
  because DAD user is 'HR'.
DAD authorization of 'Static_Auth_DAD_Typo' by user 'HR' is not in effect
  because DAD does not exist.
```

Example 17-5 Showing DAD Authorizations that Are Not in Effect

```
DECLARE
  v_dad_names DBMS_EPG.VARCHAR2_TABLE;
  v_dad_user  VARCHAR2(128);
  v_dad_found BOOLEAN;
BEGIN
  DBMS_OUTPUT.PUT_LINE
    ('----- DAD Authorizations Not in Effect -----');
  DBMS_EPG.GET_DAD_LIST(v_dad_names);

  FOR r IN (SELECT * FROM DBA_EPG_DAD_AUTHORIZATION) LOOP -- Outer loop
    v_dad_found := FALSE;
    FOR i IN 1..v_dad_names.count LOOP -- Inner loop
```

```

IF (r.DAD_NAME = v_dad_names(i)) THEN
  v_dad_user :=
    DBMS_EPG.GET_DAD_ATTRIBUTE(r.DAD_NAME, 'database-username');

  -- Is database-username the user for whom DAD is authorized?
  IF (r.USERNAME <> v_dad_user) THEN
    DBMS_OUTPUT.PUT_LINE (
      'DAD authorization of ''' || r.dad_name ||
      ''' by user ''' || r.username || ''' ' ||
      'is not in effect because DAD user is ' ||
      ''' || v_dad_user || '''.');
    END IF;
    v_dad_found := TRUE;
    EXIT; -- Inner loop
  END IF;
END LOOP; -- Inner loop

-- Does DAD exist?
IF (NOT v_dad_found) THEN
  DBMS_OUTPUT.PUT_LINE (
    'DAD authorization of ''' || r.dad_name ||
    ''' by user ''' || r.username ||
    ''' is not in effect because the DAD does not exist.');
```

17.4.3.2.9 Examining Embedded PL/SQL Gateway Configuration

When you are connected to the database as a user with system privileges, this script helps you examine the configuration of the embedded PL/SQL gateway:

```
$ORACLE_HOME/rdbms/admin/epgstat.sql
```

[Example 17-6](#) (page 17-17) shows the output of the `epgstat.sql` script for [Example 17-1](#) (page 17-14) when the ANONYMOUS account is locked.

Example 17-6 *epgstat.sql* Script Output for [Example 17-1](#) (page 17-14)

Command to run script:

```
@$ORACLE_HOME/rdbms/admin/epgstat.sql
```

Result:

```

+-----+
| XDB protocol ports: |
| XDB is listening for the protocol |
| when the protocol port is nonzero. |
+-----+
```

```
HTTP Port FTP Port
```

```
-----
          0          0
```

1 row selected.

```

+-----+
| DAD virtual-path mappings |
+-----+
```

```
Virtual Path          DAD Name
```

```

-----
/dynamic/*                Dynamic_Auth_DAD_Restricted
/static/*                 Static_Auth_DAD

```

2 rows selected.

```

+-----+
| DAD attributes |
+-----+

```

DAD Name	DAD Param	DAD Value
Dynamic_Auth_DAD_Restricted	database-username	HR
Static_Auth_DAD	database-username	HR

2 rows selected.

```

+-----+
| DAD authorization: |
| To use static authentication of a user in a DAD, |
| the DAD must be authorized for the user. |
+-----+

```

DAD Name	User Name
Static_Auth_DAD	HR
Static_Auth_DAD_Typo	OE
	HR

3 rows selected.

```

+-----+
| DAD authentication schemes |
+-----+

```

DAD Name	User Name	Auth Scheme
Dynamic_Auth_DAD		Dynamic
Dynamic_Auth_DAD_Restricted	HR	Dynamic Restricted
Static_Auth_DAD	HR	Static

3 rows selected.

```

+-----+
| ANONYMOUS user status: |
| To use static or anonymous authentication in any DAD, |
| the ANONYMOUS account must be unlocked. |
+-----+

```

Database User	Status
ANONYMOUS	EXPIRED & LOCKED

1 row selected.

```

+-----+
| ANONYMOUS access to XDB repository:          |
| To allow public access to XDB repository without authentication, |
| ANONYMOUS access to the repository must be allowed.              |
+-----+

Allow repository anonymous access?
-----
false

1 row selected.

```

17.4.4 Invoking PL/SQL Stored Subprograms Through Embedded PL/SQL Gateway

The basic steps for invoking PL/SQL subprograms through the embedded PL/SQL gateway are the same as for the `mod_plsql` gateway. See *Oracle HTTP Server mod_plsql User's Guide* for instructions. You must adapt the `mod_plsql` instructions slightly for use with the embedded gateway. For example, invoke the embedded gateway in a browser by entering the URL in this format:

```
protocol://hostname[:port]/virt-path/[!][schema.][package.]proc_name[?query_str]
```

The placeholder `virt-path` stands for the virtual path that you configured in `DBMS_EPG.CREATE_DAD`. The `mod_plsql` documentation uses `DAD_location` instead of `virt-path`.

These topics documented in *Oracle HTTP Server mod_plsql User's Guide* apply equally to the embedded gateway:

- Transaction mode
- Supported data types
- Parameter-passing scheme
- File upload and download support
- Path-aliasing
- Common Gateway Interface (CGI) environment variables

17.4.5 Securing Application Access with Embedded PL/SQL Gateway

The embedded gateway shares the same protection mechanism with `mod_plsql`. See *Oracle HTTP Server mod_plsql User's Guide* for instructions.

17.4.6 Restrictions in Embedded PL/SQL Gateway

The `mod_plsql` restrictions documented in the first chapter of *Oracle HTTP Server mod_plsql User's Guide* apply equally to the embedded gateway. Also, the embedded version of the gateway does not support these features:

- Dynamic HTML caching
- System monitoring
- Authentication modes other than Basic

For information about authentication modes, see *Oracle HTTP Server mod_plsql User's Guide*.

17.4.7 Using Embedded PL/SQL Gateway: Scenario

This section illustrates how to write a simple application that queries the `hr.employees` table and delivers HTML output to a web browser through the PL/SQL gateway. It assumes that you have both XML DB and the sample schemas installed.

To write and run the program follow these steps:

1. Log on to the database as a user with ALTER USER privileges and ensure that the database account ANONYMOUS is unlocked. The ANONYMOUS account, which is locked by default, is required for static authentication. If the account is locked, then use this SQL statement to unlock it:

```
ALTER USER anonymous ACCOUNT UNLOCK;
```

2. Log on to the database as an XML DB administrator, that is, a user with the XDBADMIN role.

To determine which users and roles were granted the XDADMIN role, query the data dictionary:

```
SELECT *
FROM DBA_ROLE_PRIVS
WHERE GRANTED_ROLE = 'XDBADMIN';
```

3. Create the DAD. For example, this procedure creates a DAD invoked HR_DAD and maps the virtual path to `/plsqli/`:

```
EXEC DBMS_EPG.CREATE_DAD('HR_DAD', '/plsqli/*');
```

4. Set the DAD attribute `database-username` to the database user whose privileges must be used by the DAD. For example, this procedure specifies that the DAD HR_DAD accesses database objects with the privileges of user HR:

```
EXEC DBMS_EPG.SET_DAD_ATTRIBUTE('HR_DAD', 'database-username', 'HR');
```

The attribute `database-username` is case-sensitive.

5. Grant EXECUTE privilege to the database user whose privileges must be used by the DAD (so that he or she can authorize the DAD). For example:

```
GRANT EXECUTE ON DBMS_EPG TO HR;
```

6. Log off as the XML DB administrator and log on to the database as the database user whose privileges must be used by the DAD (for example, HR).

7. Authorize the embedded PL/SQL gateway to invoke procedures and access document tables through the DAD. For example:

```
EXEC DBMS_EPG.AUTHORIZE_DAD('HR_DAD');
```

8. Create a sample PL/SQL stored procedure invoked `print_employees`. This program creates an HTML page that includes the result set of a query of `hr.employees`:

```
CREATE OR REPLACE PROCEDURE print_employees IS
  CURSOR emp_cursor IS
```



```

SELECT last_name, first_name
FROM hr.employees
ORDER BY last_name;
BEGIN
HTP.PRINT('<html>');
HTP.PRINT('<head>');
HTP.PRINT('<meta http-equiv="Content-Type" content="text/html">');
HTP.PRINT('<title>List of Employees</title>');
HTP.PRINT('</head>');
HTP.PRINT('<body TEXT="#000000" BGCOLOR="#FFFFFF">');
HTP.PRINT('<h1>List of Employees</h1>');
HTP.PRINT('<table width="40%" border="1">');
HTP.PRINT('<tr>');
HTP.PRINT('<th align="left">Last Name</th>');
HTP.PRINT('<th align="left">First Name</th>');
HTP.PRINT('</tr>');
FOR emp_record IN emp_cursor LOOP
HTP.PRINT('<tr>');
HTP.PRINT('<td>' || emp_record.last_name || '</td>');
HTP.PRINT('<td>' || emp_record.first_name || '</td>');
END LOOP;
HTP.PRINT('</table>');
HTP.PRINT('</body>');
HTP.PRINT('</html>');
END;
/

```

9. Ensure that the Oracle Net listener can accept HTTP requests. You can determine the status of the listener on Linux and UNIX by running this command at the system prompt:

```
lsnrctl status | grep HTTP
```

Output (reformatted from a single line to multiple lines from page size constraints):

```
(DESCRIPTION=
  (ADDRESS=(PROTOCOL=tcp)(HOST=example.com)(PORT=8080))
  (Presentation=HTTP)
  (Session=RAW)
)
```

If you do not see the HTTP service started, then you can add these lines to your initialization parameter file (replacing *listener_name* with the name of your Oracle Net local listener), then restart the database and the listener:

```
dispatchers="(PROTOCOL=TCP)"
local_listener=listener_name
```

10. Run the `print_employees` program from your web browser. For example, you can use this URL, replacing *host* with the name of your host computer and *port* with the value of the PORT parameter in the previous step:

```
http://host:port/plsql/print_employees
```

For example, if your host is `test.com` and your HTTP port is 8080, then enter:

```
http://example.com:8080/plsql/print_employees
```

The web browser returns an HTML page with a table that includes the first and last name of every employee in the `hr.employees` table.

17.5 Generating HTML Output with PL/SQL

Traditionally, PL/SQL web applications use function calls to generate each HTML tag for output. These functions are part of the PL/SQL Web Toolkit packages that come with Oracle Database. [Example 17-7](#) (page 17-22) shows how to generate a simple HTML page by calling the HTP functions that correspond to each HTML tag.

An alternative to making function calls that correspond to each tag is to use the HTP.PRINT function to print both text and tags. [Example 17-8](#) (page 17-22) illustrates this technique.

Example 17-7 Using HTP Functions to Generate HTML Tags

```
CREATE OR REPLACE PROCEDURE html_page IS
BEGIN
    HTP.HTMLOPEN;                -- generates <HTML>
    HTP.HEADOPEN;               -- generates <HEAD>
    HTP.TITLE('Title');        -- generates <TITLE>Hello</TITLE>
    HTP.HEADCLOSE;             -- generates </HEAD>

    -- generates <BODY TEXT="#000000" BGCOLOR="#FFFFFF">
    HTP.BODYOPEN( cattributes => 'TEXT="#000000" BGCOLOR="#FFFFFF"');

    -- generates <H1>Heading in the HTML File</H1>
    HTP.HEADER(1, 'Heading in the HTML File');

    HTP.PARA;                   -- generates <P>
    HTP.PRINT('Some text in the HTML file.');
```

Example 17-8 Using HTP.PRINT to Generate HTML Tags

```
CREATE OR REPLACE PROCEDURE html_page2 IS
BEGIN
    HTP.PRINT('<html>');
    HTP.PRINT('<head>');
    HTP.PRINT('<meta http-equiv="Content-Type" content="text/html">');
    HTP.PRINT('<title>Title of the HTML File</title>');
    HTP.PRINT('</head>');
    HTP.PRINT('<body TEXT="#000000" BGCOLOR="#FFFFFF">');
    HTP.PRINT('<h1>Heading in the HTML File</h1>');
    HTP.PRINT('<p>Some text in the HTML file.');
```

17.6 Passing Parameters to PL/SQL Web Applications

To be useful in a wide variety of situations, a web application must be interactive enough to allow user choices. To keep the attention of impatient web surfers, streamline the interaction so that users can specify these choices very simply, without excessive decision-making or data entry.

The main methods of passing parameters to PL/SQL web applications are:

- Using HTML form tags. The user fills in a form on one web page, and all the data and choices are transmitted to a stored subprogram when the user clicks the `Submit` button on the page.
- Hard-coded in the URL. The user clicks on a link, and a set of predefined parameters are transmitted to a stored subprogram. Typically, you include separate links on your web page for all the choices that the user might want.

Topics:

- [Passing List and Dropdown-List Parameters from an HTML Form](#) (page 17-23)
- [Passing Option and Check Box Parameters from an HTML Form](#) (page 17-24)
- [Passing Entry-Field Parameters from an HTML Form](#) (page 17-24)
- [Passing Hidden Parameters from an HTML Form](#) (page 17-26)
- [Uploading a File from an HTML Form](#) (page 17-26)
- [Submitting a Completed HTML Form](#) (page 17-26)
- [Handling Missing Input from an HTML Form](#) (page 17-27)
- [Maintaining State Information Between Web Pages](#) (page 17-27)

17.6.1 Passing List and Dropdown-List Parameters from an HTML Form

List boxes and drop-down lists are implemented with the HTML tag `<SELECT>`.

Use a list box for a large number of choices or to allow multiple selections. List boxes are good for showing items in alphabetical order so that users can find an item quickly without reading all the choices.

Use a drop-down list in these situations:

- There are a small number of choices
- Screen space is limited.
- Choices are in an unusual order.

The drop-down captures the attention of first-time users and makes them read the items. If you keep the choices and order consistent, then users can memorize the motion of selecting an item from the drop-down list, allowing them to make selections quickly as they gain experience.

[Example 17-9](#) (page 17-23) shows a simple drop-down list.

Example 17-9 HTML Drop-Down List

```
<form>
<select name="seasons">
<option value="winter">Winter
<option value="spring">Spring
<option value="summer">Summer
<option value="fall">Fall
</select>
```

17.6.2 Passing Option and Check Box Parameters from an HTML Form

Options pass either a null value (if none of the options in a group is checked), or the value specified on the option that is checked.

To specify a default value for a set of options, you can include the `CHECKED` attribute in an `INPUT` tag, or include a `DEFAULT` clause on the parameter within the stored subprogram. When setting up a group of options, be sure to include a choice that indicates "no preference", because after selecting an option, the user can select a different one, but cannot clear the selection completely. For example, include a "Don't Care" or "Don't Know" selection along with "Yes" and "No" choices, in case someone makes a selection and then realizes it was wrong.

Check boxes need special handling, because your stored subprogram might receive a null value, a single value, or multiple values:

All the check boxes with the same `NAME` attribute comprise a check box group. If none of the check boxes in a group is checked, the stored subprogram receives a null value for the corresponding parameter.

If one check box in a group is checked, the stored subprogram receives a single `VARCHAR2` parameter.

If multiple check boxes in a group are checked, the stored subprogram receives a parameter with the PL/SQL type `TABLE OF VARCHAR2`. You must declare a type like `TABLE OF VARCHAR2`, or use a predefined one like `OWA_UTIL.IDENT_ARR`. To retrieve the values, use a loop:

```
CREATE OR REPLACE PROCEDURE handle_checkboxes (  
    checkboxes owa_util.ident_arr  
) AS  
BEGIN  
    FOR i IN 1..checkboxes.count  
    LOOP  
        http.print('<p>Check Box value: ' || checkboxes(i));  
    END LOOP;  
END;  
/
```

17.6.3 Passing Entry-Field Parameters from an HTML Form

Entry fields require the most validation, because a user might enter data in the wrong format, out of range, and so on. If possible, validate the data on the client side using a client-side JavaScript function, and format it correctly for the user or prompt them to enter it again.

For example:

- You might prevent the user from entering alphabetic characters in a numeric entry field, or from entering characters after reaching a length limit.
- You might silently remove spaces and dashes from a credit card number if the stored subprogram expects the value in that format.
- You might inform the user immediately when they type a number that is too large, so that they can retype it.

Because you cannot rely on such validation to succeed, code the stored subprograms to deal with these cases anyway. Rather than forcing the user to use the Back button

when they enter wrong data, display a single page with an error message and the original form with all the other values filled in.

For sensitive information such as passwords, a special form of the entry field, `<INPUT TYPE=PASSWORD>`, hides the text as it is typed in.

The procedure in [Example 17-10](#) (page 17-25) accepts two strings as input. The first time the procedure is invoked, the user sees a simple form prompting for the input values. When the user submits the information, the same procedure is invoked again to check if the input is correct. If the input is OK, the procedure processes it. If not, the procedure prompts for input, filling in the original values for the user.

Example 17-10 Passing Entry-Field Parameters from an HTML Form

```
DROP TABLE name_zip_table;
CREATE TABLE name_zip_table (
  name   VARCHAR2(100),
  zipcode NUMBER
);

-- Store a name and associated zip code in the database.

CREATE OR REPLACE PROCEDURE associate_name_with_zipcode
  (name VARCHAR2 := NULL,
   zip  VARCHAR2 := NULL)
AS
BEGIN
  -- Each entry field must contain a value. Zip code must be 6 characters.
  -- (In a real program you perform more extensive checking.)

  IF name IS NOT NULL AND zip IS NOT NULL AND length(zip) = 6 THEN
    INSERT INTO name_zip_table (name, zipcode) VALUES (name, zip);

    HTP.PRINT('<p>The person ' || HTP.ESCAPE_SC(name) ||
              ' has the zip code ' || HTP.ESCAPE_SC(zip) || '.');

    -- If input was OK, stop here. User does not see form again.
    RETURN;
  END IF;

  -- If user entered incomplete or incorrect data, show error message.

  IF (name IS NULL AND zip IS NOT NULL)
    OR (name IS NOT NULL AND zip IS NULL)
    OR (zip IS NOT NULL AND length(zip) != 6)
  THEN
    HTP.PRINT('<p><b>Please reenter data. Fill all fields,
              and use 6-digit zip code.</b>');
  END IF;

  -- If user entered no data or incorrect data, show error message
  -- & make form invoke same procedure to check input values.

  HTP.FORMOPEN('HR.associate_name_with_zipcode', 'GET');
  HTP.PRINT('<p>Enter your name:</td>');

  HTP.PRINT('<td valign=center><input type=text name=name value="' ||
            HTP.ESCAPE_SC(name) || '">');

  HTP.PRINT('<p>Enter your zip code:</td>');

  HTP.PRINT('<td valign=center><input type=text name=zip value="' ||
```

```
        HTP.ESCAPE_SC(zip) || '>');

    HTP.FORMSUBMIT(NULL, 'Submit');
    HTP.FORMCLOSE;
END;
/
```

17.6.4 Passing Hidden Parameters from an HTML Form

One technique for passing information through a sequence of stored subprograms, without requiring the user to specify the same choices each time, is to include hidden parameters in the form that invokes a stored subprogram. The first stored subprogram places information, such as a user name, into the HTML form that it generates. The value of the hidden parameter is passed to the next stored subprogram, as if the user had entered it through a option or entry field.

Other techniques for passing information from one stored subprogram to another include:

- Sending a "cookie" containing the persistent information to the browser. The browser then sends this same information back to the server when accessing other web pages from the same site. Cookies are set and retrieved through the HTTP headers that are transferred between the browser and the web server before the HTML text of each web page.
- Storing the information in the database itself, where later stored subprograms can retrieve it. This technique involves some extra overhead on the database server, and you must still find a way to keep track of each user as multiple users access the server at the same time.

17.6.5 Uploading a File from an HTML Form

You can use an HTML form to choose a file on a client system, and transfer it to the server. A stored subprogram can insert the file into the database as a CLOB, BLOB, or other type that can hold large amounts of data.

The PL/SQL Web Toolkit and the PL/SQL gateway have the notion of a "document table" that holds uploaded files.

See Also:

mod_plsql User's Guide

17.6.6 Submitting a Completed HTML Form

By default, an HTML form must have a `Submit` button, which transmits the data from the form to a stored subprogram or CGI program. You can label this button with text of your choice, such as "Search", "Register", and so on.

You can have multiple forms on the same page, each with its own form elements and `Submit` button. You can even have forms consisting entirely of hidden parameters, where the user makes no choice other than clicking the button.

Using JavaScript or other scripting languages, you can eliminate the `Submit` button and have the form submitted in response to some other action, such as selecting from a drop-down list. This technique is best when the user makes a single selection, and the confirmation step of the `Submit` button is not essential.

17.6.7 Handling Missing Input from an HTML Form

When an HTML form is submitted, your stored subprogram receives null parameters for any form elements that are not filled in. For example, null parameters can result from an empty entry field, a set of check boxes, options, or list items with none checked, or a `VALUE` parameter of "" (empty quotation marks).

Regardless of any validation you do on the client side, use code stored subprograms to handle the possibility that some parameters are null:

- Specify an initial value in all parameter declarations, to prevent an exception when the stored subprogram is invoked with a missing form parameter. You can set the initial value to zero for numeric values (when that makes sense), and to `NULL` when you want to check whether the user specifies a value.
- Before using an input parameter value that has the initial value `NULL`, check if it is null.
- Make the subprogram generate sensible results even when not all input parameters are specified. You might leave some sections out of a report, or display a text string or image in a report to indicate where parameters were not specified.
- Provide a way to fill in the missing values and run the stored subprogram again, directly from the results page. For example, include a link that invokes the same stored subprogram with an additional parameter, or display the original form with its values filled in as part of the output.

17.6.8 Maintaining State Information Between Web Pages

Web applications are particularly concerned with the idea of **state**, the set of data that is current at a particular moment in time. It is easy to lose state information when switching from one web page to another, which might result in asking the user to make the same choices repeatedly.

You can pass state information between dynamic web pages using HTML forms. The information is passed as a set of name-value pairs, which are turned into stored subprogram parameters for you.

If the user has to make multiple selections, or one selection from many choices, or it is important to avoid an accidental selection, use an HTML form. After the user makes and reviews all the choices, they confirm the choices with the `Submit` button. Subsequent pages can use forms with hidden parameters (`<INPUT TYPE=HIDDEN>` tags) to pass these choices from one page to the next.

If the user is considering one or two choices, or the decision points are scattered throughout the web page, you can save the user from hunting around for the `Submit` button by representing actions as hyperlinks and including any necessary name-value pairs in the query string (the part after the `?` within a URL).

An alternative way to main state information is to use Oracle Application Server and its `mod_ose` module. This approach lets you store state information in package variables that remain available as a user moves around a website.

See Also:

The Oracle Application Server documentation set at:

<http://www.oracle.com/technetwork/indexes/documentation/index.html>

17.7 Performing Network Operations in PL/SQL Subprograms

Oracle provides packages that allow PL/SQL subprograms to perform a set of network operations using PL/SQL: sending email, getting a host name or address, using TCP/IP connections, retrieving HTTP URL contents, and using table, image maps, cookies, and CGI variables.

Topics:

- [Internet Protocol Version 6 \(IPv6\) Support](#) (page 17-28)
- [Sending E-Mail from PL/SQL](#) (page 17-28)
- [Getting a Host Name or Address from PL/SQL](#) (page 17-29)
- [Using TCP/IP Connections from PL/SQL](#) (page 17-29)
- [Retrieving HTTP URL Contents from PL/SQL](#) (page 17-30)
- [Using Tables_ Image Maps_ Cookies_ and CGI Variables from PL/SQL](#) (page 17-32)

17.7.1 Internet Protocol Version 6 (IPv6) Support

As of Oracle Database 11g Release 2 (11.2.0.1), PL/SQL network utility packages support IPv6 addresses.

The package interfaces have not changed: Any interface parameter that expects a network host accepts an IPv6 address in string form, and any interface that returns an IP address can return an IPv6 address.

However, applications that use network addresses might need small changes, and recompilation, to accommodate IPv6 addresses. An IPv6 address has 128 bits, while an IPv4 address has 32 bits. In a URL, an IPv6 address must be enclosed in brackets. For example:

```
http://[2001:0db8:85a3:08d3:1319:8a2e:0370:7344]/
```

See Also:

- *Oracle Database Net Services Administrator's Guide* for detailed information about IPv6 support in Oracle Database
 - *Oracle Database PL/SQL Packages and Types Reference* for information about IPv6 support in specific PL/SQL network utility packages
-

17.7.2 Sending E-Mail from PL/SQL

Using the UTL_SMTP package, a PL/SQL subprogram can send e-mail, as in [Example 17-11](#) (page 17-29).

See Also:

Oracle Database PL/SQL Packages and Types Reference for detailed information about the UTL_SMTP package

Example 17-11 Sending E-Mail from PL/SQL

```

CREATE OR REPLACE PROCEDURE send_test_message
IS
    mailhost  VARCHAR2(64) := 'mailhost.example.com';
    sender    VARCHAR2(64) := 'me@example.com';
    recipient VARCHAR2(64) := 'you@example.com';
    mail_conn UTL_SMTP.CONNECTION;
BEGIN
    mail_conn := UTL_SMTP.OPEN_CONNECTION(mailhost, 25); -- 25 is the port
    UTL_SMTP.HELO(mail_conn, mailhost);
    UTL_SMTP.MAIL(mail_conn, sender);
    UTL_SMTP.RCPT(mail_conn, recipient);

    UTL_SMTP.OPEN_DATA(mail_conn);
    UTL_SMTP.WRITE_DATA(mail_conn, 'This is a test message.' || chr(13));
    UTL_SMTP.WRITE_DATA(mail_conn, 'This is line 2.' || chr(13));
    UTL_SMTP.CLOSE_DATA(mail_conn);

    /* If message were in single string, open_data(), write_data(),
       and close_data() could be in a single call to data(). */

    UTL_SMTP.QUIT(mail_conn);
EXCEPTION
    WHEN OTHERS THEN
        -- Insert error-handling code here
        RAISE;
END;
/

```

17.7.3 Getting a Host Name or Address from PL/SQL

Using the UTL_INADDR package, a PL/SQL subprogram can determine the host name of the local system or the IP address of a given host name.

See Also:

Oracle Database PL/SQL Packages and Types Reference for detailed information about the UTL_INADDR package

17.7.4 Using TCP/IP Connections from PL/SQL

Using the UTL_TCP package, a PL/SQL subprogram can open TCP/IP connections to systems on the network, and read or write to the corresponding sockets.

See Also:

Oracle Database PL/SQL Packages and Types Reference for detailed information about the UTL_TCP package

17.7.5 Retrieving HTTP URL Contents from PL/SQL

Using the UTL_HTTP package, a PL/SQL subprogram can:

- Retrieve the contents of an HTTP URL
The contents are usually in the form of HTML-tagged text, but might be any kind of file that can be downloaded from a web server (for example, plain text or a JPEG image).
- Control HTTP session details (such as headers, cookies, redirects, proxy servers, IDs and passwords for protected sites, and CGI parameters)
- Speed up multiple accesses to the same website, using HTTP 1.1 persistent connections

A PL/SQL subprogram can construct and interpret URLs for use with the UTL_HTTP package by using the functions UTL_URL.ESCAPE and UTL_URL.UNESCAPE.

The PL/SQL procedure in [Example 17-12](#) (page 17-30) uses the UTL_HTTP package to retrieve the contents of an HTTP URL.

This block shows examples of calls to the procedure in [Example 17-12](#) (page 17-30), but the URLs are for nonexistent pages. Substitute URLs from your own web server.

```
BEGIN
  show_url('http://www.oracle.com/no-such-page.html');
  show_url('http://www.oracle.com/protected-page.html');
  show_url
    ('http://www.oracle.com/protected-page.html', 'username', 'password');
END;
/
```

See Also:

- *Oracle Database PL/SQL Packages and Types Reference* for detailed information about the UTL_HTTP package
 - *Oracle Database PL/SQL Packages and Types Reference* for detailed information about UTL_URL.ESCAPE and UTL_URL.UNESCAPE
-
-

Example 17-12 Retrieving HTTP URL Contents from PL/SQL

```
CREATE OR REPLACE PROCEDURE show_url
  (url      IN VARCHAR2,
   username IN VARCHAR2 := NULL,
   password IN VARCHAR2 := NULL)
AS
  req      UTL_HTTP.REQ;
  resp     UTL_HTTP.RESP;
  name_    VARCHAR2(256);
  value_   VARCHAR2(1024);
  data_    VARCHAR2(255);
  my_scheme VARCHAR2(256);
  my_realm VARCHAR2(256);
  my_proxy  BOOLEAN;
BEGIN
  -- When going through a firewall, pass requests through this host.
  -- Specify sites inside the firewall that do not need the proxy host.
```

```

UTL_HTTP.SET_PROXY('proxy.example.com', 'corp.example.com');

-- Ask UTL_HTTP not to raise an exception for 4xx and 5xx status codes,
-- rather than just returning the text of the error page.

UTL_HTTP.SET_RESPONSE_ERROR_CHECK(FALSE);

-- Begin retrieving this web page.
req := UTL_HTTP.BEGIN_REQUEST(url);

-- Identify yourself.
-- Some sites serve special pages for particular browsers.
UTL_HTTP.SET_HEADER(req, 'User-Agent', 'Mozilla/4.0');

-- Specify user ID and password for pages that require them.
IF (username IS NOT NULL) THEN
  UTL_HTTP.SET_AUTHENTICATION(req, username, password);
END IF;

-- Start receiving the HTML text.
resp := UTL_HTTP.GET_RESPONSE(req);

-- Show status codes and reason phrase of response.
DBMS_OUTPUT.PUT_LINE('HTTP response status code: ' || resp.status_code);
DBMS_OUTPUT.PUT_LINE
  ( 'HTTP response reason phrase: ' || resp.reason_phrase);

-- Look for client-side error and report it.
IF (resp.status_code >= 400) AND (resp.status_code <= 499) THEN

-- Detect whether page is password protected
-- and you didn't supply the right authorization.

IF (resp.status_code = UTL_HTTP.HTTP_UNAUTHORIZED) THEN
UTL_HTTP.GET_AUTHENTICATION(resp, my_scheme, my_realm, my_proxy);
IF (my_proxy) THEN
  DBMS_OUTPUT.PUT_LINE('Web proxy server is protected.');
  DBMS_OUTPUT.PUT('Please supply the required ' || my_scheme ||
    ' authentication username for realm ' || my_realm ||
    ' for the proxy server.');
ELSE
  DBMS_OUTPUT.PUT_LINE('Web page ' || url || ' is protected.');
  DBMS_OUTPUT.PUT('Please supplied the required ' || my_scheme ||
    ' authentication username for realm ' || my_realm ||
    ' for the web page.');
END IF;
ELSE
  DBMS_OUTPUT.PUT_LINE('Check the URL.');
END IF;

UTL_HTTP.END_RESPONSE(resp);
  RETURN;

-- Look for server-side error and report it.
ELSIF (resp.status_code >= 500) AND (resp.status_code <= 599) THEN
  DBMS_OUTPUT.PUT_LINE('Check if the website is up.');
  UTL_HTTP.END_RESPONSE(resp);
  RETURN;
END IF;

```

```

-- HTTP header lines contain information about cookies, character sets,
-- and other data that client and server can use to customize each
-- session.

FOR i IN 1..UTL_HTTP.GET_HEADER_COUNT(resp) LOOP
    UTL_HTTP.GET_HEADER(resp, i, name_, value_);
    DBMS_OUTPUT.PUT_LINE(name_ || ': ' || value_);
END LOOP;

-- Read lines until none are left and an exception is raised.
LOOP
    UTL_HTTP.READ_LINE(resp, value_);
    DBMS_OUTPUT.PUT_LINE(value_);
END LOOP;
EXCEPTION
    WHEN UTL_HTTP.END_OF_BODY THEN
        UTL_HTTP.END_RESPONSE(resp);
END;
/

```

17.7.6 Using Tables, Image Maps, Cookies, and CGI Variables from PL/SQL

Using packages supplied by Oracle, and the `mod_plsql` plug-in of Oracle HTTP Server (OHS), a PL/SQL subprogram can format the results of a query in an HTML table, produce an image map, set and get HTTP cookies, check the values of CGI variables, and perform other typical web operations.

Documentation for these packages is not part of the database documentation library. The location of the documentation depends on your application server. To get started with these packages, look at their subprogram names and parameters using the SQL*Plus `DESCRIBE` statement:

```

DESCRIBE HTP;
DESCRIBE HTF;
DESCRIBE OWA_UTIL;

```

Using Continuous Query Notification (CQN)

Continuous Query Notification (CQN) lets an application register queries with the database for either object change notification (the default) or query result change notification. An object referenced by a registered query is a **registered object**.

If a query is registered for **object change notification (OCN)**, the database notifies the application whenever a transaction changes an object that the query references and commits, regardless of whether the query result changed.

If a query is registered for **query result change notification (QRCN)**, the database notifies the application whenever a transaction changes the result of the query and commits.

A **CQN registration** associates a list of one or more queries with a notification type (OCN or QRCN) and a notification handler. To create a CQN registration, you can use either the PL/SQL interface or Oracle Call Interface (OCI). If you use the PL/SQL interface, the notification handler is a server-side PL/SQL stored procedure; if you use OCI, the notification handler is a client-side C callback procedure.

This chapter explains general CQN concepts and explains how to use the PL/SQL CQN interface. For information about using OCI for CQN, see *Oracle Call Interface Programmer's Guide*.

Topics:

- [About Object Change Notification \(OCN\)](#) (page 18-2)
- [About Query Result Change Notification \(QRCN\)](#) (page 18-2)
- [Events that Generate Notifications](#) (page 18-5)
- [Notification Contents](#) (page 18-7)
- [Good Candidates for CQN](#) (page 18-8)
- [Creating CQN Registrations](#) (page 18-10)
- [Using PL/SQL to Create CQN Registrations](#) (page 18-10)
- [Using OCI to Create CQN Registrations](#) (page 18-31)
- [Querying CQN Registrations](#) (page 18-47)
- [Interpreting Notifications](#) (page 18-47)

Note:

The terms **OCN** and **QRCN** refer to both the notification type and the notification itself: An application registers a query *for* OCN, and the database sends the application *an* OCN; an application registers a query *for* QRCN, and the database sends the application *a* QRCN.

18.1 About Object Change Notification (OCN)

If an application registers a query for object change notification (OCN), the database sends the application an OCN whenever a transaction changes an object associated with the query and commits, regardless of whether the result of the query changed.

For example, if an application registers the query in [Example 18-1](#) (page 18-2) for OCN, and a user commits a transaction that changes the `EMPLOYEES` table, the database sends the application an OCN, even if the changed row or rows did not satisfy the query predicate (for example, if `DEPARTMENT_ID = 5`).

Example 18-1 Query to be Registered for Change Notification

```
SELECT EMPLOYEE_ID, SALARY
FROM EMPLOYEES
WHERE DEPARTMENT_ID = 10;
```

18.2 About Query Result Change Notification (QRCN)

Note:

For QRCN support, the `COMPATIBLE` initialization parameter of the database must be at least 11.0.0, and Automatic Undo Management (AUM) must be enabled (as it is by default).

For information about the `COMPATIBLE` initialization parameter, see *Oracle Database Administrator's Guide*.

For information about AUM, see *Oracle Database Administrator's Guide*.

If an application registers a query for query result change notification (QRCN), the database sends the application a QRCN whenever a transaction changes the result of the query and commits.

For example, if an application registers the query in [Example 18-1](#) (page 18-2) for QRCN, the database sends the application a QRCN only if the query result set changes; that is, if one of these data manipulation language (DML) statements commits:

- An `INSERT` or `DELETE` of a row that satisfies the query predicate (`DEPARTMENT_ID = 10`).
- An `UPDATE` to the `EMPLOYEE_ID` or `SALARY` column of a row that satisfied the query predicate (`DEPARTMENT_ID = 10`).
- An `UPDATE` to the `DEPARTMENT_ID` column of a row that changed its value from 10 to a value other than 10, causing the row to be deleted from the result set.

- An UPDATE to the DEPARTMENT_ID column of a row that changed its value to 10 from a value other than 10, causing the row to be added to the result set.

The default notification type is OCN. For QRCN, specify QOS_QUERY in the QOSFLAGS attribute of the CQ_NOTIFICATION\$_REG_INFO object.

With QRCN, you have a choice of guaranteed mode (the default) or best-effort mode.

Topics:

- [Guaranteed Mode](#) (page 18-3)
- [Best-Effort Mode](#) (page 18-3)

18.2.1 Guaranteed Mode

In guaranteed mode, there are no false positives: the database sends the application a QRCN only when the query result set is guaranteed to have changed.

For example, suppose that an application registered the query in [Example 18-1](#) (page 18-2) for QRCN, that employee 201 is in department 10, and that these statements are executed:

```
UPDATE EMPLOYEES
SET SALARY = SALARY + 10
WHERE EMPLOYEE_ID = 201;
```

```
UPDATE EMPLOYEES
SET SALARY = SALARY - 10
WHERE EMPLOYEE_ID = 201;
```

```
COMMIT;
```

Each UPDATE statement in the preceding transaction changes the query result set, but together they have no effect on the query result set; therefore, the database does not send the application a QRCN for the transaction.

For guaranteed mode, specify QOS_QUERY, but not QOS_BEST_EFFORT, in the QOSFLAGS attribute of the CQ_NOTIFICATION\$_REG_INFO object.

Some queries are too complex for QRCN in guaranteed mode. For the characteristics of queries that can be registered in guaranteed mode, see [Queries that Can Be Registered for QRCN in Guaranteed Mode](#) (page 18-17).

18.2.2 Best-Effort Mode

Some queries that are too complex for guaranteed mode can be registered for QRCN in best-effort mode, in which CQN creates and registers simpler versions of them.

The following two examples demonstrate how this works:

- [Example: Query Too Complex for QRCN in Guaranteed Mode](#) (page 18-3)
- [Example: Query Whose Simplified Version Invalidates Objects](#) (page 18-4)

18.2.2.1 Example: Query Too Complex for QRCN in Guaranteed Mode

The query in [Example 18-2](#) (page 18-4) is too complex for QRCN in guaranteed mode because it contains the aggregate function SUM.

Example 18-2 Query Too Complex for QRCN in Guaranteed Mode

```
SELECT SUM(SALARY)
FROM EMPLOYEES
WHERE DEPARTMENT_ID = 20;
```

In best-effort mode, CQN registers this simpler version of the query in this example:

```
SELECT SALARY
FROM EMPLOYEES
WHERE DEPARTMENT_ID = 20;
```

Whenever the result of the original query changes, the result of its simpler version also changes; therefore, no notifications are lost from the simplification. However, the simplification might cause false positives, because the result of the simpler version can change when the result of the original query does not.

In best-effort mode, the database:

- Minimizes the OLTP response overhead that is from notification-related processing, as follows:
 - For a single-table query, the database determines whether the query result has changed by which columns changed and which predicates the changed rows satisfied.
 - For a multiple-table query (a join), the database uses the primary-key/foreign-key constraint relationships between the tables to determine whether the query result has changed.
- Sends the application a QRCN whenever a DML statement changes the query result set, even if a subsequent DML statement nullifies the change made by the first DML statement.

The overhead minimization of best-effort mode infrequently causes false positives, even for queries that CQN does not simplify. For example, consider the query in this example and the transaction in [Guaranteed Mode](#) (page 18-3). In best-effort mode, CQN does not simplify the query, but the transaction generates a false positive.

18.2.2.2 Example: Query Whose Simplified Version Invalidates Objects

Some types of queries are so simplified that invalidations are generated at object level; that is, whenever any object referenced in those queries changes. Examples of such queries are those that use unsupported column types or include subqueries. The solution to this problem is to rewrite the original queries.

For example, the query in [Example 18-3](#) (page 18-4) is too complex for QRCN in guaranteed mode because it includes a subquery.

Example 18-3 Query Whose Simplified Version Invalidates Objects

```
SELECT SALARY
FROM EMPLOYEES
WHERE DEPARTMENT_ID IN (
  SELECT DEPARTMENT_ID
  FROM DEPARTMENTS
  WHERE LOCATION_ID = 1700
);
```

In best-effort mode, CQN simplifies the query in this example to this:

```
SELECT * FROM EMPLOYEES, DEPARTMENTS;
```

The simplified query can cause objects to be invalidated. However, if you rewrite the original query as follows, you can register it in either guaranteed mode or best-effort mode:

```
SELECT SALARY
FROM EMPLOYEES, DEPARTMENTS
WHERE EMPLOYEES.DEPARTMENT_ID = DEPARTMENTS.DEPARTMENT_ID
      AND DEPARTMENTS.LOCATION_ID = 1700;
```

Queries that can be registered only in best-effort mode are described in [Queries that Can Be Registered for QRCN Only in Best-Effort Mode](#) (page 18-18).

The default for QRCN mode is guaranteed mode. For best-effort mode, specify `QOS_BEST_EFFORT` in the `QOSFLAGS` attribute of the `CQ_NOTIFICATION$_REG_INFO` object.

18.3 Events that Generate Notifications

These events generate notifications:

- [Committed DML Transactions](#) (page 18-5)
- [Committed DDL Statements](#) (page 18-5)
- [Deregistration](#) (page 18-6)
- [Global Events](#) (page 18-7)

18.3.1 Committed DML Transactions

When the notification type is OCN, any DML transaction that changes one or more registered objects generates one notification for each object when it commits.

When the notification type is QRCN, any DML transaction that changes the result of one or more registered queries generates a notification when it commits. The notification includes the query IDs of the queries whose results changed.

For either notification type, the notification includes:

- Name of each changed table
- Operation type (INSERT, UPDATE, or DELETE)
- ROWID of each changed row, if the registration was created with the ROWID option and the number of modified rows was not too large. For more information, see [ROWID Option](#) (page 18-12).

18.3.2 Committed DDL Statements

For both OCN and QRCN, these data definition language (DDL) statements, when committed, generate notifications:

- ALTER TABLE
- TRUNCATE TABLE
- FLASHBACK TABLE
- DROP TABLE

Note:

When the notification type is OCN, a committed `DROP TABLE` statement generates a `DROP NOTIFICATION`.

Any OCN registrations of queries on the dropped table become disassociated from that table (which no longer exists), but the registrations themselves continue to exist. If any of these registrations are associated with objects other than the dropped table, committed changes to those other objects continue to generate notifications. Registrations associated only with the dropped table also continue to exist, and their creator can add queries (and their referenced objects) to them.

An OCN registration is based on the version and definition of an object at the time the query was registered. If an object is dropped, registrations on that object are disassociated from it forever. If an object is created with the same name, and in the same schema, as the dropped object, the created object is not associated with OCN registrations that were associated with the dropped object.

When the notification type is QRCN:

- The notification includes:
 - Query IDs of the queries whose results have changed
 - Name of the modified table
 - Type of DDL operation
- Some DDL operations that invalidate registered queries can cause those queries to be deregistered.

For example, suppose that this query is registered for QRCN:

```
SELECT COL1 FROM TEST_TABLE
WHERE COL2 = 1;
```

Suppose that `TEST_TABLE` has this schema:

```
(COL1 NUMBER, COL2 NUMBER, COL3 NUMBER)
```

This DDL statement, when committed, invalidates the query and causes it to be removed from the registration:

```
ALTER TABLE DROP COLUMN COL2;
```

18.3.3 Deregistration

For both OCN and QRCN, deregistration—removal of a registration from the database—generates a notification. The reasons that the database removes a registration are:

- Timeout

If `TIMEOUT` is specified with a nonzero value when the queries are registered, the database purges the registration after the specified time interval.

If `QOS_DEREG_NFY` is specified when the queries are registered, the database purges the registration after it generates its first notification.

- Loss of privileges

If privileges are lost on an object associated with a registered query, and the notification type is OCN, the database purges the registration. (When the notification type is QRCN, the database removes that query from the registration, but does not purge the registration.)

For privileges needed to register queries, see [Prerequisites for Creating CQN Registrations](#) (page 18-16).

A notification is not generated when a client application performs an explicit deregistration.

18.3.4 Global Events

The global events `EVENT_STARTUP` and `EVENT_SHUTDOWN` generate notifications.

In an Oracle RAC environment, these events generate notifications:

- `EVENT_STARTUP` when the first instance of the database starts
- `EVENT_SHUTDOWN` when the last instance of the database shuts down
- `EVENT_SHUTDOWN_ANY` when any instance of the database shuts down

The preceding global events are constants defined in the `DBMS_CQ_NOTIFICATION` package.

See Also:

Oracle Database PL/SQL Packages and Types Reference for more information about the `DBMS_CQ_NOTIFICATION` package

18.4 Notification Contents

A notification contains some or all of this information:

- Type of event, which is one of:
 - Startup
 - Object change
 - Query result change
 - Deregistration
 - Shutdown
- Registration ID of affected registration
- Names of changed objects
- If `ROWID` option was specified, `ROWIDs` of changed rows
- If the notification type is `QRCN`: Query IDs of queries whose results changed
- If notification resulted from a `DML` or `DDL` statement:
 - Array of names of modified tables

- Operation type (for example, INSERT or UPDATE)

A notification does not contain the changed data itself. For example, the notification does not say that a monthly salary increased from 5000 to 6000. To obtain more recent values for the changed objects or rows or query results, the application must query the database.

18.5 Good Candidates for CQN

Good candidates for CQN are applications that cache the result sets of queries on infrequently changed objects in the middle tier, to avoid network round trips to the database. These applications can use CQN to register the queries to be cached. When such an application receives a notification, it can refresh its cache by rerunning the registered queries.

An example of such an application is a web forum. Because its users need not view content as soon as it is inserted into the database, this application can cache information in the middle tier and have CQN tell it when it when to refresh the cache.

Figure 18-1 (page 18-8) illustrates a typical scenario in which the database serves data that is cached in the middle tier and then accessed over the Internet.

Figure 18-1 Middle-Tier Caching

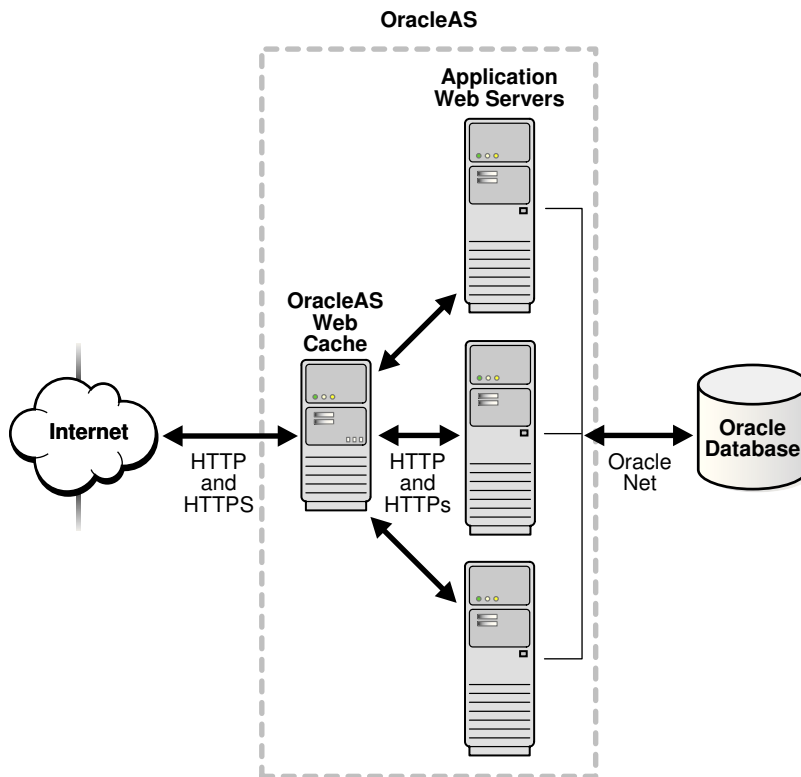

Applications in the middle tier require rapid access to cached copies of database objects while keeping the cache as current as possible in relation to the database. Cached data becomes obsolete when a transaction modifies the data and commits, thereby putting the application at risk of accessing incorrect results. If the application uses CQN, the database can publish a notification when a change occurs to registered objects with details on what changed. In response to the notification, the application can refresh cached data by fetching it from the back-end database.

Figure 18-2 (page 18-9) illustrates the process by which middle-tier web clients receive and process notifications.

Figure 18-2 Basic Process of Continuous Query Notification (CQN)

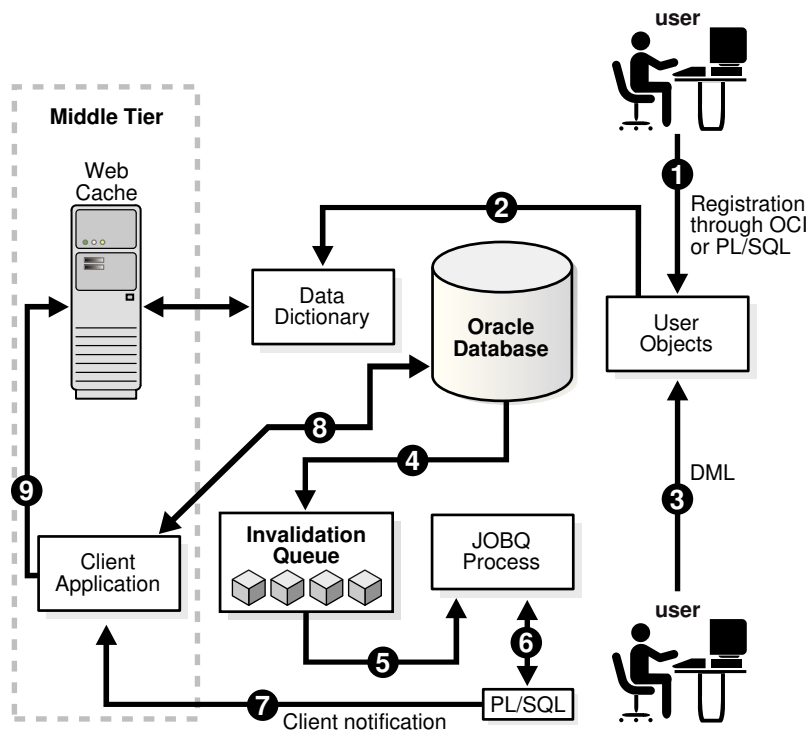

Explanation of steps in Figure 18-2 (page 18-9) (if registrations are created using PL/SQL and that the application has cached the result set of a query on HR.EMPLOYEES):

1. The developer uses PL/SQL to create a CQN registration for the query, which consists of creating a stored PL/SQL procedure to process notifications and then using the PL/SQL CQN interface to create a registration for the query, specifying the PL/SQL procedure as the notification handler.
2. The database populates the registration information in the data dictionary.
3. A user updates a row in the HR.EMPLOYEES table in the back-end database and commits the update, causing the query result to change. The data for HR.EMPLOYEES cached in the middle tier is now outdated.
4. The database adds a message that describes the change to an internal queue.
5. The database notifies a JOBQ background process of a notification message.
6. The JOBQ process runs the stored procedure specified by the client application. In this example, JOBQ passes the data to a server-side PL/SQL procedure. The implementation of the PL/SQL notification handler determines how the notification is handled.
7. Inside the server-side PL/SQL procedure, the developer can implement logic to notify the middle-tier client application of the changes to the registered objects. For example, it notifies the application of the ROWID of the changed row in HR.EMPLOYEES.

8. The client application in the middle tier queries the back-end database to retrieve the data in the changed row.
9. The client application updates the cache with the data.

18.6 Creating CQN Registrations

A **CQN registration** associates a list of one or more queries with a notification type and a notification handler.

The notification type is either OCN or QRCN. For information about these types, see [About Object Change Notification \(OCN\)](#) (page 18-2) and [About Query Result Change Notification \(QRCN\)](#) (page 18-2).

To create a CQN registration, you can use one of two interfaces:

- **PL/SQL interface**
If you use the PL/SQL interface, the notification handler is a server-side PL/SQL stored procedure. See [Using PL/SQL to Create CQN Registrations](#) (page 18-10).
- **Oracle Call Interface (OCI)**
If you use OCI, the notification handler is a client-side C callback procedure. See [Using OCI to Create CQN Registrations](#) (page 18-31).

After being created, a registration is stored in the database. In an Oracle RAC environment, it is visible to all database instances. Transactions that change the query results in any database instance generate notifications.

By default, a registration survives until the application that created it explicitly deregisters it or until the database implicitly purges it (from loss of privileges, for example).

18.7 Using PL/SQL to Create CQN Registrations

This section describes using PL/SQL to create CQN registrations. When you use the PL/SQL interface, the notification handler is a server-side PL/SQL stored procedure.

Topics:

- [PL/SQL CQN Registration Interface](#) (page 18-11)
- [CQN Registration Options](#) (page 18-11)
- [Prerequisites for Creating CQN Registrations](#) (page 18-16)
- [Queries that Can Be Registered for Object Change Notification \(OCN\)](#) (page 18-16)
- [Queries that Can Be Registered for Query Result Change Notification \(QRCN\)](#) (page 18-16)
- [Using PL/SQL to Register Queries for CQN](#) (page 18-19)
- [Best Practices for CQN Registrations](#) (page 18-25)
- [Troubleshooting CQN Registrations](#) (page 18-25)
- [Deleting Registrations](#) (page 18-26)

- [Configuring CQN: Scenario](#) (page 18-26)

18.7.1 PL/SQL CQN Registration Interface

The PL/SQL CQN registration interface is implemented with the `DBMS_CQ_NOTIFICATION` package. You use the `DBMS_CQ_NOTIFICATION.NEW_REG_START` function to open a registration block. You specify the registration details, including the notification type and notification handler, as part of the `CQ_NOTIFICATION$_REG_INFO` object, which is passed as an argument to the `NEW_REG_START` procedure. Every query that you run while the registration block is open is registered with CQN. If you specified notification type QRCN, the database assigns a query ID to each query. You can retrieve these query IDs with the `DBMS_CQ_NOTIFICATION.CQ_NOTIFICATION_QUERYID` function. To close the registration block, you use the `DBMS_CQ_NOTIFICATION.REG_END` function.

For step-by-step instructions, see [Using PL/SQL to Register Queries for CQN](#) (page 18-19).

See Also:

Oracle Database PL/SQL Packages and Types Reference for more information about the `DBMS_CQ_NOTIFICATION` package

18.7.2 CQN Registration Options

You can change the CQN registration defaults with the options summarized in [Table 18-1](#) (page 18-11).

Table 18-1 Continuous Query Notification Registration Options

Option	Description
Notification Type	Specifies QRCN (the default is OCN).
QRCN Mode ¹	Specifies best-effort mode (the default is guaranteed mode).
ROWID	Includes the value of the ROWID pseudocolumn for each changed row in the notification.
Operations Filter ²	Publishes the notification only if the operation type matches the specified filter condition.
Transaction Lag ²	Deprecated. Use Notification Grouping instead.
Notification Grouping	Specifies how notifications are grouped.
Reliable	Stores notifications in a persistent database queue (instead of in shared memory, the default).
Purge on Notify	Purges the registration after the first notification.
Timeout	Purges the registration after a specified time interval.

¹ Applies only when notification type is QRCN.

² Applies only when notification type is OCN.

Topics:

- [Notification Type Option](#) (page 18-12)
- [QRCN Mode \(QRCN Notification Type Only\)](#) (page 18-12)
- [ROWID Option](#) (page 18-12)
- [Operations Filter Option \(OCN Notification Type Only\)](#) (page 18-13)
- [Transaction Lag Option \(OCN Notification Type Only\)](#) (page 18-14)
- [Notification Grouping Options](#) (page 18-14)
- [Reliable Option](#) (page 18-15)
- [Purge-on-Notify and Timeout Options](#) (page 18-15)

18.7.2.1 Notification Type Option

The notification types are OCN (described in [About Object Change Notification \(OCN\)](#) (page 18-2)) and QRCN (described in [About Query Result Change Notification \(QRCN\)](#) (page 18-2)).

18.7.2.2 QRCN Mode (QRCN Notification Type Only)

The QRCN mode option applies only when the notification type is QRCN. Instructions for setting the notification type to QRCN are in [Notification Type Option](#) (page 18-12).

The QRCN modes are guaranteed (described in [Guaranteed Mode](#) (page 18-3)) and best-effort (described in [Best-Effort Mode](#) (page 18-3)).

The default is guaranteed mode. For best-effort mode, specify QOS_BEST_EFFORT in the QOSFLAGS attribute of the CQ_NOTIFICATION\$_REG_INFO object.

18.7.2.3 ROWID Option

The ROWID option includes the value of the ROWID pseudocolumn (the rowid of the row) for each changed row in the notification. To include the ROWID option of each changed row in the notification, specify QOS_ROWIDS in the QOSFLAGS attribute of the CQ_NOTIFICATION\$_REG_INFO object.

Note:

When you update a row in a table compressed with Hybrid Columnar Compression (HCC), the ROWID of the row changes. HCC, a feature of certain Oracle storage systems, is described in *Oracle Database Concepts*.

From the ROWID information in the notification, the application can retrieve the contents of the changed rows by performing queries of this form:

```
SELECT * FROM table_name_from_notification
WHERE ROWID = rowid_from_notification;
```

ROWIDs are published in the external string format. For a regular heap table, the length of a ROWID is 18 character bytes. For an Index Organized Table (IOT), the length of the ROWID depends on the size of the primary key, and might exceed 18 bytes.

If the server does not have enough memory for the ROWIDs, the notification might be "rolled up" into a FULL-TABLE-NOTIFICATION, indicated by a special flag in the notification descriptor. Possible reasons for a FULL-TABLE-NOTIFICATION are:

- Total shared memory consumption from ROWIDs exceeds 1% of the dynamic shared pool size.
- Too many rows were changed in a single registered object within a transaction (the upper limit is approximately 80).
- Total length of the logical ROWIDs of modified rows for an IOT is too large (the upper limit is approximately 1800 bytes).
- You specified the Notification Grouping option NTFN_GROUPING_TYPE with the value DBMS_CQ_NOTIFICATION.NTFN_GROUPING_TYPE_SUMMARY, described in [Notification Grouping Options](#) (page 18-14).

Because a FULL-TABLE-NOTIFICATION does not include ROWIDs, the application that receives it must assume that the entire table (that is, all rows) might have changed.

18.7.2.4 Operations Filter Option (OCN Notification Type Only)

The Operations Filter option applies only when the notification type is OCN.

The Operations Filter option enables you to specify the types of operations that generate notifications.

The default is all operations. To specify that only some operations generate notifications, use the OPERATIONS_FILTER attribute of the CQ_NOTIFICATION\$_REG_INFO object. With the OPERATIONS_FILTER attribute, specify the type of operation with the constant that represents it, which is defined in the DBMS_CQ_NOTIFICATION package, as follows:

Operation	Constant
INSERT	DBMS_CQ_NOTIFICATION.INSERTOP
UPDATE	DBMS_CQ_NOTIFICATION.UPDATEOP
DELETE	DBMS_CQ_NOTIFICATION.DELETEOP
ALTEROP	DBMS_CQ_NOTIFICATION.ALTEROP
DROPOP	DBMS_CQ_NOTIFICATION.DROPOP
UNKNOWNOP	DBMS_CQ_NOTIFICATION.UNKNOWNOP
All (default)	DBMS_CQ_NOTIFICATION.ALL_OPERATIONS

To specify multiple operations, use bitwise OR. For example:

```
DBMS_CQ_NOTIFICATION.INSERTOP + DBMS_CQ_NOTIFICATION.DELETEOP
```

OPERATIONS_FILTER has no effect if you also specify QOS_QUERY in the QOSFLAGS attribute, because QOS_QUERY specifies notification type QRCN.

See Also:

Oracle Database PL/SQL Packages and Types Reference for more information about the `DBMS_CQ_NOTIFICATION` package

18.7.2.5 Transaction Lag Option (OCN Notification Type Only)

The Transaction Lag option applies only when the notification type is OCN.

Note:

This option is deprecated. To implement flow-of-control notifications, use [Notification Grouping Options](#) (page 18-14).

The Transaction Lag option specifies the number of transactions by which the client application can lag behind the database. If the number is 0, every transaction that changes a registered object results in a notification. If the number is 5, every fifth transaction that changes a registered object results in a notification. The database tracks intervening changes at object granularity and includes them in the notification, so that the client does not lose them.

A transaction lag greater than 0 is useful only if an application implements flow-of-control notifications. Ensure that the application generates notifications frequently enough to satisfy the lag, so that they are not deferred indefinitely.

If you specify `TRANSACTION_LAG`, then notifications do not include ROWIDs, even if you also specified `QOS_ROWIDS`.

18.7.2.6 Notification Grouping Options

By default, notifications are generated immediately after the event that causes them.

Notification Grouping options, which are attributes of the `CQ_NOTIFICATION$_REG_INFO` object, are:

Attribute	Description
<code>NTFN_GROUPING_CLASS</code>	Specifies the class by which to group notifications. The only allowed values are <code>DBMS_CQ_NOTIFICATION.NTFN_GROUPING_CLASS_TIME</code> , which groups notifications by time, and zero, which is the default (notifications are generated immediately after the event that causes them).
<code>NTFN_GROUPING_VALUE</code>	Specifies the time interval that defines the group, in seconds. For example, if this value is 900, notifications generated in the same 15-minute interval are grouped.

Attribute	Description
NTFN_GROUPING_TYPE	<p>Specifies the type of grouping, which is either of:</p> <ul style="list-style-type: none"> DBMS_CQ_NOTIFICATION.NTFN_GROUPING_TYPE_SUMMARY: All notifications in the group are summarized into a single notification. Note: The single notification does not include ROWIDs, even if you specified the ROWID option. DBMS_CQ_NOTIFICATION.NTFN_GROUPING_TYPE_LAST: Only the last notification in the group is published and the earlier ones discarded.
NTFN_GROUPING_START_TIME	<p>Specifies when to start generating notifications. If specified as NULL, it defaults to the current system-generated time.</p>
NTFN_GROUPING_REPEAT_COUNT	<p>Specifies how many times to repeat the notification. Set to DBMS_CQ_NOTIFICATION.NTFN_GROUPING_FOREVER to receive notifications for the life of the registration. To receive at most <i>n</i> notifications during the life of the registration, set to <i>n</i>.</p>

Note:

Notifications generated by timeouts, loss of privileges, and global events might be published before the specified grouping interval expires. If they are, any pending grouped notifications are also published before the interval expires.

18.7.2.7 Reliable Option

By default, a CQN registration is stored in shared memory. To store it in a persistent database queue instead—that is, to generate **reliable notifications**—specify QOS_RELIABLE in the QOSFLAGS attribute of the CQ_NOTIFICATION\$_REG_INFO object.

The advantage of reliable notifications is that if the database fails after generating them, it can still deliver them after it restarts. In an Oracle RAC environment, a surviving database instance can deliver them.

The disadvantage of reliable notifications is that they have higher CPU and I/O costs than default notifications do.

18.7.2.8 Purge-on-Notify and Timeout Options

By default, a CQN registration survives until the application that created it explicitly deregisters it or until the database implicitly purges it (from loss of privileges, for example).

To purge the registration after it generates its first notification, specify QOS_DEREG_NFY in the QOSFLAGS attribute of the CQ_NOTIFICATION\$_REG_INFO object.

To purge the registration after *n* seconds, specify *n* in the TIMEOUT attribute of the CQ_NOTIFICATION\$_REG_INFO object.

You can use the Purge-on-Notify and Timeout options together.

18.7.3 Prerequisites for Creating CQN Registrations

These are prerequisites for creating CQN registrations:

- You must have these privileges:
 - EXECUTE privilege on the DBMS_CQ_NOTIFICATION package, whose subprograms you use to create a registration
 - CHANGE NOTIFICATION system privilege
 - READ or SELECT privilege on each object to be registered

Loss of privileges on an object associated with a registered query generates a notification—see [Deregistration](#) (page 18-6).

- You must be connected as a non-SYS user.
- You must not be in the middle of an uncommitted transaction.
- The `dml_locks_init.ora` parameter must have a nonzero value (as its default value does).

(This is also a prerequisite for receiving notifications.)

Note:

For QRCN support, the `COMPATIBLE` setting of the database must be at least 11.0.0.

18.7.4 Queries that Can Be Registered for Object Change Notification (OCN)

Most queries can be registered for OCN, including those executed as part of stored procedures and REF cursors.

Queries that cannot be registered for OCN are:

- Queries on fixed tables or fixed views
- Queries on user views
- Queries that contain database links (dblinks)
- Queries over materialized views

Note:

You can use synonyms in OCN registrations, but not in QRCN registrations.

18.7.5 Queries that Can Be Registered for Query Result Change Notification (QRCN)

Some queries can be registered for QRCN in guaranteed mode, some can be registered for QRCN only in best-effort mode, and some cannot be registered for QRCN in either mode. (For information about modes, see [Guaranteed Mode](#) (page 18-3) and [Best-Effort Mode](#) (page 18-3).)

Topics:

- [Queries that Can Be Registered for QRCN in Guaranteed Mode](#) (page 18-17)
- [Queries that Can Be Registered for QRCN Only in Best-Effort Mode](#) (page 18-18)
- [Queries that Cannot Be Registered for QRCN in Either Mode](#) (page 18-19)

18.7.5.1 Queries that Can Be Registered for QRCN in Guaranteed Mode

To be registered for QRCN in guaranteed mode, a query must conform to these rules:

- Every column that it references is either a NUMBER data type or a VARCHAR2 data type.
- Arithmetic operators in column expressions are limited to these binary operators, and their operands are columns with numeric data types:
 - + (addition)
 - - (subtraction, not unary minus)
 - * (multiplication)
 - / (division)
- Comparison operators in the predicate are limited to:
 - < (less than)
 - <= (less than or equal to)
 - = (equal to)
 - >= (greater than or equal to)
 - > (greater than)
 - <> or != (not equal to)
 - IS NULL
 - IS NOT NULL
- Boolean operators in the predicate are limited to AND, OR, and NOT.
- The query contains no aggregate functions (such as SUM, COUNT, AVERAGE, MIN, and MAX).

For a list of SQL aggregate functions, see *Oracle Database SQL Language Reference*.

Guaranteed mode supports most queries on single tables and some inner equijoins, such as:

```
SELECT SALARY FROM EMPLOYEES, DEPARTMENTS
WHERE EMPLOYEES.DEPARTMENT_ID = DEPARTMENTS.DEPARTMENT_ID
AND DEPARTMENTS.LOCATION_ID = 1700;
```

Note:

- Sometimes the query optimizer uses an execution plan that makes a query incompatible for guaranteed mode (for example, OR-expansion). For information about the query optimizer, see *Oracle Database SQL Tuning Guide*.
- Queries that can be registered in guaranteed mode can also be registered in best-effort mode, but results might differ, because best-effort mode can cause false positives even for queries that CQN does not simplify. For details, see [Best-Effort Mode](#) (page 18-3).

18.7.5.2 Queries that Can Be Registered for QRCN Only in Best-Effort Mode

A query that does any of the following can be registered for QRCN only in best-effort mode, and its simplified version generates notifications at object granularity:

- Refers to columns that have encryption enabled
- Has more than 10 items of the same type in the SELECT list
- Has expressions that include any of these:
 - String functions (such as SUBSTR, LTRIM, and RTRIM)
 - Arithmetic functions (such as TRUNC, ABS, and SQRT)

For a list of SQL functions, see *Oracle Database SQL Language Reference*.

 - Pattern-matching conditions LIKE and REGEXP_LIKE
 - EXISTS or NOT EXISTS condition
- Has disjunctions involving predicates defined on columns from different tables. For example:

```
SELECT EMPLOYEE_ID, DEPARTMENT_ID
   FROM EMPLOYEES, DEPARTMENTS
   WHERE EMPLOYEES.EMPLOYEE_ID = 10
      OR DEPARTMENTS.DEPARTMENT_ID = 'IT';
```

- Has user rowid access. For example:

```
SELECT DEPARTMENT_ID
   FROM DEPARTMENTS
   WHERE ROWID = 'AAANKdAABAAALinAAF';
```
- Has any join other than an inner join
- Has an execution plan that involves any of these:
 - Bitmap join, domain, or function-based indexes
 - UNION ALL or CONCATENATION

(Either in the query itself, or as the result of an OR-expansion execution plan chosen by the query optimizer.)

 - ORDER BY or GROUP BY

(Either in the query itself, or as the result of a SORT operation with an ORDER BY option in the execution plan chosen by the query optimizer.)

- Partitioned index-organized table (IOT) with overflow segment
- Clustered objects
- Parallel execution

18.7.5.3 Queries that Cannot Be Registered for QRCN in Either Mode

A query that refers to any of the following cannot be registered for QRCN in either guaranteed or best-effort mode:

- Views
- Tables that are fixed, remote, or have Virtual Private Database (VPD) policies enabled
- DUAL (in the SELECT list)
- Synonyms
- Calls to user-defined PL/SQL subprograms
- Operators not listed in [Queries that Can Be Registered for QRCN in Guaranteed Mode](#) (page 18-17)
- The aggregate function COUNT
(Other aggregate functions are allowed in best-effort mode, but not in guaranteed mode.)
- Application contexts; for example:

```
SELECT SALARY FROM EMPLOYEES
WHERE USER = SYS_CONTEXT('USERENV', 'SESSION_USER');
```
- SYSDATE, SYSTIMESTAMP, or CURRENT_TIMESTAMP

Also, a query that the query optimizer has rewritten using a materialized view cannot be registered for QRCN. For information about the query optimizer, see *Oracle Database SQL Tuning Guide*.

18.7.6 Using PL/SQL to Register Queries for CQN

To use PL/SQL to create a CQN registration, follow these steps:

1. Create a stored PL/SQL procedure to serve as the notification handler.
See [Creating a PL/SQL Notification Handler](#) (page 18-20).
2. Create a CQ_NOTIFICATION\$_REG_INFO object that specifies the name of the notification handler, the notification type, and other attributes of the registration.
See [Creating a CQ_NOTIFICATION\\$_REG_INFO Object](#) (page 18-20).
3. In your client application, use the DBMS_CQ_NOTIFICATION.NEW_REG_START function to open a registration block.

See *Oracle Database PL/SQL Packages and Types Reference* for more information about the `CQ_NOTIFICATION$_REG_INFO` object and the functions `NEW_REG_START` and `REG_END`, all of which are defined in the `DBMS_CQ_NOTIFICATION` package.

4. Run the queries to register. (Do not run DML or DDL operations.)

See the following topics for more information:

- [Identifying Individual Queries in a Notification](#) (page 18-24)
- [Adding Queries to an Existing Registration](#) (page 18-24)

5. Close the registration block, using the `DBMS_CQ_NOTIFICATION.REG_END` function.

18.7.6.1 Creating a PL/SQL Notification Handler

The PL/SQL stored procedure that you create to serve as the notification handler must have this signature:

```
PROCEDURE schema_name.proc_name(ntfnds IN CQ_NOTIFICATION$_DESCRIPTOR)
```

In the preceding signature, *schema_name* is the name of the database schema, *proc_name* is the name of the stored procedure, and *ntfnds* is the notification descriptor.

The notification descriptor is a `CQ_NOTIFICATION$_DESCRIPTOR` object, whose attributes describe the details of the change (transaction ID, type of change, queries affected, tables modified, and so on).

The `JOBQ` process passes the notification descriptor, *ntfnds*, to the notification handler, *proc_name*, which handles the notification according to its application requirements. (This is step 6 (page 18-9) in [Figure 18-2](#) (page 18-9).)

Note:

The notification handler runs inside a job queue process. The `JOB_QUEUE_PROCESSES` initialization parameter specifies the maximum number of processes that can be created for the execution of jobs. You must set `JOB_QUEUE_PROCESSES` to a nonzero value to receive PL/SQL notifications.

18.7.6.2 Creating a `CQ_NOTIFICATION$_REG_INFO` Object

An object of type `CQ_NOTIFICATION$_REG_INFO` specifies the notification handler that the database runs when a registered objects changes. In SQL*Plus, you can view its type attributes by running this statement:

```
DESC CQ_NOTIFICATION$_REG_INFO
```

[Table 18-2](#) (page 18-21) describes the attributes of `SYS.CQ_NOTIFICATION$_REG_INFO`.

Table 18-2 Attributes of CQ_NOTIFICATION\$_REG_INFO

Attribute	Description
CALLBACK	Specifies the name of the PL/SQL procedure to be executed when a notification is generated (a notification handler). You must specify the name in the form <i>schema_name.procedure_name</i> , for example, <i>hr.dcn_callback</i> .
QOSFLAGS	<p>Specifies one or more quality-of-service flags, which are constants in the DBMS_CQ_NOTIFICATION package. For their names and descriptions, see Table 18-3 (page 18-23).</p> <p>To specify multiple quality-of-service flags, use bitwise OR. For example:</p> <pre>DBMS_CQ_NOTIFICATION.QOS_RELIABLE + DBMS_CQ_NOTIFICATION.QOS_ROWIDS</pre>
TIMEOUT	<p>Specifies the timeout period for registrations. If set to a nonzero value, it specifies the time in seconds after which the database purges the registration. If 0 or NULL, then the registration persists until the client explicitly deregisters it.</p> <p>Can be combined with the QOSFLAGS attribute with its QOS_DEREG_NFY flag.</p>
OPERATIONS_FILTER	<p>Applies only to OCN (described in About Object Change Notification (OCN) (page 18-2)). Has no effect if you specify the QOS_FLAGS attribute with its QOS_QUERY flag.</p> <p>Filters messages based on types of SQL statement. You can specify these constants in the DBMS_CQ_NOTIFICATION package:</p> <ul style="list-style-type: none"> • ALL_OPERATIONS notifies on all changes • INSERTOP notifies on inserts • UPDATEOP notifies on updates • DELETEOP notifies on deletes • ALTEROP notifies on ALTER TABLE operations • DROPOP notifies on DROP TABLE operations • UNKNOWNOP notifies on unknown operations <p>You can specify a combination of operations with a bitwise OR. For example:</p> <pre>DBMS_CQ_NOTIFICATION.INSERTOP + DBMS_CQ_NOTIFICATION.DELETEOP.</pre>

Table 18-2 (Cont.) Attributes of CQ_NOTIFICATION\$REG_INFO

Attribute	Description
TRANSACTION_LAG	<p>Deprecated. To implement flow-of-control notifications, use the NTFN_GROUPING_* attributes.</p> <p>Applies only to OCN (described in About Object Change Notification (OCN) (page 18-2)). Has no effect if you specify the QOS_FLAGS attribute with its QOS_QUERY flag.</p> <p>Specifies the number of transactions or database changes by which the client can lag behind the database. If 0, then the client receives an invalidation message as soon as it is generated. If 5, then every fifth transaction that changes a registered object results in a notification. The database tracks intervening changes at an object granularity and bundles the changes along with the notification. Thus, the client does not lose intervening changes.</p> <p>Most applications that must be notified of changes to an object on transaction commit without further deferral are expected to chose 0 transaction lag. A nonzero transaction lag is useful only if an application implements flow control on notifications. When using nonzero transaction lag, Oracle recommends that the application workload has the property that notifications are generated at a reasonable frequency. Otherwise, notifications might be deferred indefinitely till the lag is satisfied.</p> <p>If you specify TRANSACTION_LAG, then the ROWID level granularity is unavailable in the notification messages even if you specified QOS_ROWIDS during registration.</p>
NTFN_GROUPING_CLASS	<p>Specifies the class by which to group notifications. The only allowed value is</p> <p>DBMS_CQ_NOTIFICATION.NTFN_GROUPING_CLASS_TIME, which groups notifications by time.</p>
NTFN_GROUPING_VALUE	<p>Specifies the time interval that defines the group, in seconds. For example, if this value is 900, notifications generated in the same 15-minute interval are grouped.</p>
NTFN_GROUPING_TYPE	<p>Specifies either of these types of grouping:</p> <ul style="list-style-type: none"> • DBMS_CQ_NOTIFICATION.NTFN_GROUPING_TYPE_SUMMARY: All notifications in the group are summarized into a single notification. • DBMS_CQ_NOTIFICATION.NTFN_GROUPING_TYPE_LAST: Only the last notification in the group is published and the earlier ones discarded.
NTFN_GROUPING_START_TIME	<p>Specifies when to start generating notifications. If specified as NULL, it defaults to the current system-generated time.</p>

Table 18-2 (Cont.) Attributes of CQ_NOTIFICATION\$_REG_INFO

Attribute	Description
NTFN_GROUPING_REPEAT_COUNT	Specifies how many times to repeat the notification. Set to DBMS_CQ_NOTIFICATION.NTFN_GROUPING_FOREVER to receive notifications for the life of the registration. To receive at most <i>n</i> notifications during the life of the registration, set to <i>n</i> .

The quality-of-service flags in [Table 18-3](#) (page 18-23) are constants in the DBMS_CQ_NOTIFICATION package. You can specify them with the QOS_FLAGS attribute of CQ_NOTIFICATION\$_REG_INFO (see [Table 18-2](#) (page 18-21)).

Table 18-3 Quality-of-Service Flags

Flag	Description
QOS_DEREG_NFY	Purges the registration after the first notification.
QOS_RELIABLE	Stores notifications in a persistent database queue. In an Oracle RAC environment, if a database instance fails, surviving database instances can deliver any queued notification messages. Default: Notifications are stored in shared memory, which performs more efficiently.
QOS_ROWIDS	Includes the ROWID of each changed row in the notification.
QOS_QUERY	Registers queries for QRCN, described in About Query Result Change Notification (QRCN) (page 18-2). If a query cannot be registered for QRCN, an error is generated at registration time, unless you also specify QOS_BEST_EFFORT. Default: Queries are registered for OCN, described in About Object Change Notification (OCN) (page 18-2)
QOS_BEST_EFFORT	Used with QOS_QUERY. Registers simplified versions of queries that are too complex for query result change evaluation; in other words, registers queries for QRCN in best-effort mode, described in Best-Effort Mode (page 18-3). To see which queries were simplified, query the static data dictionary view DBA_CQ_NOTIFICATION_QUERIES or USER_CQ_NOTIFICATION_QUERIES. These views give the QUERYID and the text of each registered query. Default: Queries are registered for QRCN in guaranteed mode, described in Guaranteed Mode (page 18-3)

Suppose that you must invoke the procedure HR.dcn_callback whenever a registered object changes. In [Example 18-4](#) (page 18-24), you create a CQ_NOTIFICATION\$_REG_INFO object that specifies that HR.dcn_callback receives notifications. To create the object you must have EXECUTE privileges on the DBMS_CQ_NOTIFICATION package.

Example 18-4 Creating a CQ_NOTIFICATION\$_REG_INFO Object

```

DECLARE
  v_cn_addr CQ_NOTIFICATION$_REG_INFO;

BEGIN
  -- Create object:

  v_cn_addr := CQ_NOTIFICATION$_REG_INFO (
    'HR.dcn_callback',          -- PL/SQL notification handler
    DBMS_CQ_NOTIFICATION.QOS_QUERY    -- notification type QRCN
  + DBMS_CQ_NOTIFICATION.QOS_ROWIDS, -- include rowids of changed objects
    0,                             -- registration persists until unregistered
    0,                             -- notify on all operations
    0                               -- notify immediately
  );

  -- Register queries: ...
END;
/

```

18.7.6.3 Identifying Individual Queries in a Notification

Any query in a registered list of queries can cause a continuous query notification. To know when a certain query causes a notification, use the `DBMS_CQ_NOTIFICATION.CQ_NOTIFICATION_QUERYID` function in the `SELECT` list of that query. For example:

```

SELECT EMPLOYEE_ID, SALARY, DBMS_CQ_NOTIFICATION.CQ_NOTIFICATION_QUERYID
FROM EMPLOYEES
WHERE DEPARTMENT_ID = 10;

```

Result:

EMPLOYEE_ID	SALARY	CQ_NOTIFICATION_QUERYID
200	2800	0

1 row selected.

When that query causes a notification, the notification includes the query ID.

18.7.6.4 Adding Queries to an Existing Registration

To add queries to an existing registration, follow these steps:

1. Retrieve the registration ID of the existing registration.
You can retrieve it from either saved output or a query of `*_CHANGE_NOTIFICATION_REGS`.
2. Open the existing registration by calling the procedure `DBMS_CQ_NOTIFICATION.ENABLE_REG` with the registration ID as the parameter.
3. Run the queries to register. (Do not run DML or DDL operations.)
4. Close the registration, using the `DBMS_CQ_NOTIFICATION.REG_END` function.

[Example 18-5](#) (page 18-25) adds a query to an existing registration whose registration ID is 21.

Example 18-5 Adding a Query to an Existing Registration

```

DECLARE
  v_cursor SYS_REFCURSOR;

BEGIN
  -- Open existing registration
  DBMS_CQ_NOTIFICATION.ENABLE_REG(21);
  OPEN v_cursor FOR
    -- Run query to be registered
    SELECT DEPARTMENT_ID
      FROM HR.DEPARTMENTS; -- register this query
  CLOSE v_cursor;
  -- Close registration
  DBMS_CQ_NOTIFICATION.REG_END;
END;
/

```

18.7.7 Best Practices for CQN Registrations

For best CQN performance, follow these registration guidelines:

- Register few queries—preferably those that reference objects that rarely change. Extremely volatile registered objects cause numerous notifications, whose overhead slows OLTP throughput.
- Minimize the number of duplicate registrations of any given object, to avoid replicating a notification message for multiple recipients.

18.7.8 Troubleshooting CQN Registrations

If you are unable to create a registration, or if you have created a registration but are not receiving the notifications that you expected, the problem might be one of these:

- The `JOB_QUEUE_PROCESSES` parameter is not set to a nonzero value. This prevents you from receiving PL/SQL notifications through the notification handler.
- You were connected as a SYS user when you created the registrations. You must be connected as a non-SYS user to create CQN registrations.
- You changed a registered object, but did not commit the transaction. Notifications are generated only when the transaction commits.
- The registrations were not successfully created in the database. To check, query the static data dictionary view `*_CHANGE_NOTIFICATION_REGS`. For example, this statement displays all registrations and registered objects for the current user:

```
SELECT REGID, TABLE_NAME FROM USER_CHANGE_NOTIFICATION_REGS;
```
- Runtime errors occurred during the execution of the notification handler. If so, they were logged to the trace file of the `JOBQ` process that tried to run the procedure. The name of the trace file usually has this form:

```
ORACLE_SID_jnumber_PID.trc
```

For example, if the ORACLE_SID is dbs1 and the process ID (PID) of the JOBQ process is 12483, the name of the trace file is usually dbs1_j000_12483.trc.

Suppose that a registration is created with 'chnf_callback' as the notification handler and registration ID 100. Suppose that 'chnf_callback' was not defined in the database. Then the JOBQ trace file might contain a message of the form:

```
*****
Runtime error during execution of PL/SQL cbk chnf_callback for reg CHNF100.
Error in PLSQL notification of msgid:
Queue :
Consumer Name :
PLSQL function :chnf_callback
Exception Occured, Error msg:
ORA-00604: error occurred at recursive SQL level 2
ORA-06550: line 1, column 7:
PLS-00201: identifier 'CHNF_CALLBACK' must be declared
ORA-06550: line 1, column 7:
PL/SQL: Statement ignored
*****
```

If runtime errors occurred during the execution of the notification handler, create a very simple version of the notification handler to verify that you are receiving notifications, and then gradually add application logic.

An example of a very simple notification handler is:

```
REM Create table in HR schema to hold count of notifications received.
CREATE TABLE nfcnt(cnt NUMBER);
INSERT INTO nfcnt (cnt) VALUES(0);
COMMIT;
CREATE OR REPLACE PROCEDURE chnf_callback
  (ntfnds IN CQ_NOTIFICATION$_DESCRIPTOR)
IS
BEGIN
  UPDATE nfcnt SET cnt = cnt+1;
  COMMIT;
END;
/
```

- There is a time lag between the commit of a transaction and the notification received by the end user.

18.7.9 Deleting Registrations

To delete a registration, call the procedure DBMS_CQ_NOTIFICATION.DEREGISTER with the registration ID as the parameter. For example, this statement deregisters the registration whose registration ID is 21:

```
DBMS_CQ_NOTIFICATION.DEREGISTER(21);
```

Only the user who created the registration or the SYS user can deregister it.

18.7.10 Configuring CQN: Scenario

In this scenario, you are a developer who manages a web application that provides employee data: name, location, phone number, and so on. The application, which runs on Oracle Application Server, is heavily used and processes frequent queries of the HR.EMPLOYEES and HR.DEPARTMENTS tables in the back-end database. Because these tables change relatively infrequently, the application can improve performance by

caching the query results. Caching avoids a round trip to the back-end database and server-side execution latency.

You can use the `DBMS_CQ_NOTIFICATION` package to register queries based on `HR.EMPLOYEES` and `HR.DEPARTMENTS` tables. To configure CQN, you follow these steps:

1. Create a server-side PL/SQL stored procedure to process the notifications, as instructed in [Creating a PL/SQL Notification Handler](#) (page 18-27).
2. Register the queries on the `HR.EMPLOYEES` and `HR.DEPARTMENTS` tables for QRCN, as instructed in [Registering the Queries](#) (page 18-29).

After you complete these steps, any committed change to the result of a query registered in step 2 (page 18-27) causes the notification handler created in step 1 (page 18-27) to notify the web application of the change, whereupon the web application refreshes the cache by querying the back-end database.

18.7.10.1 Creating a PL/SQL Notification Handler

Create a server-side stored PL/SQL procedure to process notifications as follows:

1. Connect to the database AS SYSDBA.
2. Grant the required privileges to HR:

```
GRANT EXECUTE ON DBMS_CQ_NOTIFICATION TO HR;
GRANT CHANGE NOTIFICATION TO HR;
```
3. Enable the `JOB_QUEUE_PROCESSES` parameter to receive notifications:

```
ALTER SYSTEM SET "JOB_QUEUE_PROCESSES"=4;
```
4. Connect to the database as a non-SYS user (such as HR).
5. Create database tables to hold records of notification events received:

```
-- Create table to record notification events.
DROP TABLE nfevents;
CREATE TABLE nfevents (
  regid      NUMBER,
  event_type NUMBER
);

-- Create table to record notification queries:
DROP TABLE nfqueries;
CREATE TABLE nfqueries (
  qid NUMBER,
  qop NUMBER
);

-- Create table to record changes to registered tables:
DROP TABLE nftablechanges;
CREATE TABLE nftablechanges (
  qid          NUMBER,
  table_name   VARCHAR2(100),
  table_operation NUMBER
);

-- Create table to record ROWIDs of changed rows:
DROP TABLE nfrowchanges;
CREATE TABLE nfrowchanges (
```

```

        qid          NUMBER,
        table_name  VARCHAR2(100),
        row_id      VARCHAR2(2000)
    );

```

6. Create the procedure HR.chnf_callback, as shown in [Example 18-6](#) (page 18-28).

Example 18-6 Creating Server-Side PL/SQL Notification Handler

```

CREATE OR REPLACE PROCEDURE chnf_callback (
    ntfnds IN CQ_NOTIFICATION$_DESCRIPTOR
)
IS
    regid          NUMBER;
    tbname         VARCHAR2(60);
    event_type     NUMBER;
    numtables      NUMBER;
    operation_type NUMBER;
    numrows        NUMBER;
    row_id         VARCHAR2(2000);
    numqueries     NUMBER;
    qid            NUMBER;
    qop            NUMBER;

BEGIN
    regid := ntfnds.registration_id;
    event_type := ntfnds.event_type;

    INSERT INTO nfevents (regid, event_type)
    VALUES (chnf_callback.regid, chnf_callback.event_type);

    numqueries := 0;

    IF (event_type = DBMS_CQ_NOTIFICATION.EVENT_QUERYCHANGE) THEN
        numqueries := ntfnds.query_desc_array.count;

        FOR i IN 1..numqueries LOOP -- loop over queries
            qid := ntfnds.query_desc_array(i).queryid;
            qop := ntfnds.query_desc_array(i).queryop;

            INSERT INTO nfqueries (qid, qop)
            VALUES(chnf_callback.qid, chnf_callback.qop);

            numtables := 0;
            numtables := ntfnds.query_desc_array(i).table_desc_array.count;

            FOR j IN 1..numtables LOOP -- loop over tables
                tbname :=
                    ntfnds.query_desc_array(i).table_desc_array(j).table_name;
                operation_type :=
                    ntfnds.query_desc_array(i).table_desc_array(j).Opflags;

                INSERT INTO nftablechanges (qid, table_name, table_operation)
                VALUES (
                    chnf_callback.qid,
                    tbname,
                    operation_type
                );

                IF (bitand(operation_type, DBMS_CQ_NOTIFICATION.ALL_ROWS) = 0) THEN

```



```

        numrows := ntfnds.query_desc_array(i).table_desc_array(j).numrows;
ELSE
    numrows :=0; -- ROWID info not available
END IF;

-- Body of loop does not run when numrows is zero.
FOR k IN 1..numrows LOOP -- loop over rows
    Row_id :=
ntfnds.query_desc_array(i).table_desc_array(j).row_desc_array(k).row_id;

        INSERT INTO nfrowchanges (qid, table_name, row_id)
        VALUES (chnf_callback.qid, tbname, chnf_callback.Row_id);

    END LOOP; -- loop over rows
END LOOP; -- loop over tables
END LOOP; -- loop over queries
END IF;
COMMIT;
END;
/

```

18.7.10.2 Registering the Queries

After creating the notification handler, you register the queries for which you want to receive notifications, specifying HR.chnf_callback as the notification handler, as in [Example 18-7](#) (page 18-29).

Example 18-7 Registering a Query

```

DECLARE
    reginfo    CQ_NOTIFICATION$_REG_INFO;
    mgr_id     NUMBER;
    dept_id    NUMBER;
    v_cursor   SYS_REFCURSOR;
    regid      NUMBER;

BEGIN
    /* Register two queries for QRNC: */
    /* 1. Construct registration information.
       chnf_callback is name of notification handler.
       QOS_QUERY specifies result-set-change notifications. */

    reginfo := cq_notification$_reg_info (
        'chnf_callback',
        DBMS_CQ_NOTIFICATION.QOS_QUERY,
        0, 0, 0
    );

    /* 2. Create registration. */

    regid := DBMS_CQ_NOTIFICATION.new_reg_start(reginfo);

    OPEN v_cursor FOR
        SELECT dbms_cq_notification.CQ_NOTIFICATION_QUERYID, manager_id
        FROM HR.EMPLOYEES
        WHERE employee_id = 7902;
    CLOSE v_cursor;

    OPEN v_cursor FOR
        SELECT dbms_cq_notification.CQ_NOTIFICATION_QUERYID, department_id
        FROM HR.departments
        WHERE department_name = 'IT';

```

```

CLOSE v_cursor;

    DBMS_CQ_NOTIFICATION.reg_end;
END;
/

```

View the newly created registration:

```

SELECT queryid, regid, TO_CHAR(querytext)
FROM user_cq_notification_queries;

```

Result is similar to:

```

QUERYID REGID                                TO_CHAR(QUERYTEXT)
-----
22      41  SELECT HR.DEPARTMENTS.DEPARTMENT_ID
          FROM HR.DEPARTMENTS
          WHERE HR.DEPARTMENTS.DEPARTMENT_NAME = 'IT'

21      41  SELECT HR.EMPLOYEES.MANAGER_ID
          FROM HR.EMPLOYEES
          WHERE HR.EMPLOYEES.EMPLOYEE_ID = 7902

```

Run this transaction, which changes the result of the query with QUERYID 22:

```

UPDATE DEPARTMENTS
SET DEPARTMENT_NAME = 'FINANCE'
WHERE department_name = 'IT';

```

The notification procedure `chnf_callback` (which you created in [Example 18-6](#) (page 18-28)) runs.

Query the table in which notification events are recorded:

```

SELECT * FROM nfevents;

```

Result is similar to:

```

REGID EVENT_TYPE
-----
61      7

```

EVENT_TYPE 7 corresponds to EVENT_QUERYCHANGE (query result change).

Query the table in which changes to registered tables are recorded:

```

SELECT * FROM nftablechanges;

```

Result is similar to:

```

REGID    TABLE_NAME TABLE_OPERATION
-----
42 HR.DEPARTMENTS      4

```

TABLE_OPERATION 4 corresponds to UPDATEOP (update operation).

Query the table in which ROWIDs of changed rows are recorded:

```

SELECT * FROM nfrowchanges;

```

Result is similar to:

REGID	TABLE_NAME	ROWID
61	HR.DEPARTMENTS	AAANkdAABAAALinAAF

18.8 Using OCI to Create CQN Registrations

This section describes using OCI to create CQN registrations. When you use OCI, the notification handler is a client-side C callback procedure.

Topics

- [Using OCI for Query Result Set Notifications](#) (page 18-31)
- [Using OCI to Register a Continuous Query Notification](#) (page 18-32)
- [Using OCI Subscription Handle Attributes for Continuous Query Notification](#) (page 18-33)
- [OCI_ATTR_CQ_QUERYID Attribute](#) (page 18-35)
- [Using OCI Continuous Query Notification Descriptors](#) (page 18-35)
- [Demonstrating Continuous Query Notification in an OCI Sample Program](#) (page 18-37)

See Also:

Oracle Call Interface Programmer's Guide for more information about publish-subscribe notification in OCI

18.8.1 Using OCI for Query Result Set Notifications

To record QOS (quality of service flags) specific to continuous query (CQ) notifications, set the attribute `OCI_ATTR_SUBSCR_CQ_QOSFLAGS` on the subscription handle `OCI_HTYPE_SUBSCR`. To request that the registration is at query granularity, as opposed to object granularity, set the `OCI_SUBSCR_CQ_QOS_QUERY` flag bit on the attribute `OCI_ATTR_SUBSCR_CQ_QOSFLAGS`.

The pseudocolumn `CQ_NOTIFICATION_QUERY_ID` can be optionally specified to retrieve the query ID of a registered query. This does not automatically convert the granularity to query level. The value of the pseudocolumn on return is set to the unique query ID assigned to the query. The query ID pseudocolumn can be omitted for OCI-based registrations, in which case the query ID is returned as a READ attribute of the statement handle. (This attribute is called `OCI_ATTR_CQ_QUERYID`).

During notifications, the client-specified callback is invoked and the top-level notification descriptor is passed as an argument.

Information about the query IDs of the changed queries is conveyed through a special descriptor type called `OCI_DTYPE_CQDES`. A collection (`OCI_O11`) of query descriptors is embedded inside the top-level notification descriptor. Each descriptor is of type `OCI_DTYPE_CQDES`. The query descriptor has the following attributes:

- `OCI_ATTR_CQDES_OPERATION` - can be one of `OCI_EVENT_QUERYCHANGE` or `OCI_EVENT_DEREG`.
- `OCI_ATTR_CQDES_QUERYID` - query ID of the changed query.

- `OCI_ATTR_CODES_TABLE_CHANGES` - array of table descriptors describing DML operations on tables that led to the query result set change. Each table descriptor is of the type `OCI_DTYPE_TABLE_CHDES`.

See Also:

[OCI_DTYPE_CHDES](#) (page 18-35)

18.8.2 Using OCI to Register a Continuous Query Notification

The calling session must have the `CHANGE NOTIFICATION` system privilege and `SELECT` privileges on all objects that it attempts to register. A registration is a persistent entity that is recorded in the database, and is visible to all instances of Oracle RAC. If the registration was at query granularity, transactions that cause the query result set to change and commit in any instance of Oracle RAC generate notification. If the registration was at object granularity, transactions that modify registered objects in any instance of Oracle RAC generate notification.

Queries involving materialized views or nonmaterialized views are *not* supported.

The registration interface employs a callback to respond to changes in underlying objects of a query and uses a namespace extension (`DBCHANGE`) to AQ.

The steps in writing the registration are:

1. Create the environment in `OCI_EVENTS` and `OCI_OBJECT` mode.
2. Set the subscription handle attribute `OCI_ATTR_SUBSCR_NAMESPACE` to namespace `OCI_SUBSCR_NAMESPACE_DBCHANGE`.
3. Set the subscription handle attribute `OCI_ATTR_SUBSCR_CALLBACK` to store the OCI callback associated with the query handle. The callback has the following prototype:

```
void notification_callback (void *ctx, OCISubscription *subscrhp,
                           void *payload, ub4 paylen, void *desc, ub4 mode);
```

The parameters are described in "Notification Callback in OCI" in *Oracle Call Interface Programmer's Guide*.

4. Optionally associate a client-specific context using `OCI_ATTR_SUBSCR_CTX` attribute.
5. Set the `OCI_ATTR_SUBSCR_TIMEOUT` attribute to specify a `ub4` timeout interval in seconds. If it is not set, there is no timeout.
6. Set the `OCI_ATTR_SUBSCR_QOSFLAGS` attribute, the QOS (quality of service) levels, with the following values:
 - The `OCI_SUBSCR_QOS_PURGE_ON_NTFN` flag allows the registration to be purged on the first notification.
 - The `OCI_SUBSCR_QOS_RELIABLE` flag allows notifications to be persistent. You can use surviving instances of Oracle RAC to send and retrieve continuous query notification messages, even after a node failure, because invalidations associated with this registration are queued persistently into the database. If `FALSE`, then invalidations are enqueued into a fast in-memory queue. This option describes the persistence of notifications and not the

persistence of registrations. Registrations are automatically persistent by default.

7. Call `OCISubscriptionRegister()` to create a new registration in the `DBCHANGE` namespace.
8. Associate multiple query statements with the subscription handle by setting the attribute `OCI_ATTR_CHNF_REGHANDLE` of the statement handle, `OCI_HTYPE_STMT`. The registration is completed when the query is executed.

See Also:

Oracle Call Interface Programmer's Guide for more information about `OCI_ATTR_CHNF_REGHANDLE`

9. Optionally unregister a subscription. The client can call the `OCISubscriptionRegister()` function with the subscription handle as a parameter.

A binding of a statement handle to a subscription handle is valid only for only the first execution of a query. If the application must use the same OCI statement handle for subsequent executions, it must repopulate the registration handle attribute of the statement handle. A binding of a subscription handle to a statement handle is permitted only when the statement is a query (determined at execute time). If a DML statement is executed as part of the execution, then an exception is issued.

18.8.3 Using OCI Subscription Handle Attributes for Continuous Query Notification

The subscription handle attributes for continuous query notification can be divided into generic attributes (common to all subscriptions) and namespace-specific attributes (particular to continuous query notification).

The `WRITE` attributes on the statement handle can be modified only before the registration is created.

Generic Attributes - Common to All Subscriptions

`OCI_ATTR_SUBSCR_NAMESPACE` (`WRITE`) - Set this attribute to `OCI_SUBSCR_NAMESPACE_DBCHANGE` for subscription handles.

`OCI_ATTR_SUBSCR_CALLBACK` (`WRITE`) - Use this attribute to store the callback associated with the subscription handle. The callback is executed when a notification is received.

When a new continuous query notification message becomes available, the callback is invoked in the listener thread with `desc` pointing to a descriptor of type `OCI_DTYPE_CHDES` that contains detailed information about the invalidation.

`OCI_ATTR_SUBSCR_QOSFLAGS` - This attribute is a generic flag with the following values:

```
#define OCI_SUBSCR_QOS_RELIABLE          0x01          /* reliable */
#define OCI_SUBSCR_QOS_PURGE_ON_NTFN    0x10          /* purge on first ntfn */
```

- `OCI_SUBSCR_QOS_RELIABLE` - Set this bit to allow notifications to be persistent. Therefore, you can use surviving instances of an Oracle RAC cluster to send and retrieve invalidation messages, even after a node failure, because invalidations associated with this registration ID are queued persistently into the database. If this bit is `FALSE`, then invalidations are enqueued in to a fast in-memory queue.

This option describes the persistence of notifications and not the persistence of registrations. Registrations are automatically persistent by default.

- `OCI_SUBSCR_QOS_PURGE_ON_NTFN` - Set this bit to allow the registration to be purged on the first notification.

A parallel example is presented in *Oracle Call Interface Programmer's Guide* in publish-subscribe registration functions in OCI.

`OCI_ATTR_SUBSCR_CQ_QOSFLAGS` - This attribute describes the continuous query notification-specific QOS flags (mode is `WRITE`, data type is `ub4`), which are:

- `0x1 OCI_SUBSCR_CQ_QOS_QUERY` - Set this flag to indicate that query-level granularity is required. Generate notification only if the query result set changes. By default, this level of QOS has no false positives.
- `0x2 OCI_SUBSCR_CQ_QOS_BEST_EFFORT` - Set this flag to indicate that best effort filtering is acceptable. It can be used by caching applications. The database can use heuristics based on cost of evaluation and avoid full pruning in some cases.

`OCI_ATTR_SUBSCR_TIMEOUT` - Use this attribute to specify a `ub4` timeout value defined in seconds. If the timeout value is 0 or not specified, then the registration is active until explicitly unregistered.

Namespace- Specific or Feature-Specific Attributes

The following attributes are namespace-specific or feature-specific to the continuous query notification feature.

`OCI_ATTR_CHNF_TABLENAMES` (data type is `(OCIColl *)`) - These attributes are provided to retrieve the list of table names that were registered. These attributes are available from the subscription handle, after the query is executed.

`OCI_ATTR_CHNF_ROWIDS` - A Boolean attribute (default `FALSE`). If `TRUE`, then the continuous query notification message includes row-level details such as operation type and `ROWID`.

`OCI_ATTR_CHNF_OPERATIONS` - Use this `ub4` flag to selectively filter notifications based on operation type. This option is ignored if the registration is of query-level granularity. Flags stored are:

- `OCI_OPCODE_ALL` - All operations
- `OCI_OPCODE_INSERT` - Insert operations on the table
- `OCI_OPCODE_UPDATE` - Update operations on the table
- `OCI_OPCODE_DELETE` - Delete operations on the table

`OCI_ATTR_CHNF_CHANGELAG` - The client can use this `ub4` value to specify the number of transactions by which the client is willing to lag behind. The client can also use this option as a throttling mechanism for continuous query notification messages. When you choose this option, `ROWID`-level granularity of information is unavailable in the notifications, even if `OCI_ATTR_CHNF_ROWIDS` was `TRUE`. This option is ignored if the registration is of query-level granularity.

After the `OCISubscriptionRegister()` call is invoked, none of the preceding attributes (generic, name-specific, or feature-specific) can be modified on the registration already created. Any attempt to modify those attributes is not reflected on the registration

already created, but it does take effect on newly created registrations that use the same registration handle.

See Also:

Oracle Call Interface Programmer's Guide for more information about continuous query notification descriptor attributes

Notifications can be spaced out by using the grouping NTFN option. The relevant generic notification attributes are:

```
OCI_ATTR_SUBSCR_NTFN_GROUPING_VALUE
OCI_ATTR_SUBSCR_NTFN_GROUPING_TYPE
OCI_ATTR_SUBSCR_NTFN_GROUPING_START_TIME
OCI_ATTR_SUBSCR_NTFN_GROUPING_REPEAT_COUNT
```

See Also:

Oracle Call Interface Programmer's Guide for more details about these attributes in publish-subscribe register directly to the database

18.8.4 OCI_ATTR_CQ_QUERYID Attribute

The attribute `OCI_ATTR_CQ_QUERYID` on the statement handle, `OCI_HTYPE_STMT`, obtains the query ID of a registered query after registration is made by the call to `OCIStmtExecute()`.

See Also:

Oracle Call Interface Programmer's Guide for more information about `OCI_ATTR_CQ_QUERYID`

18.8.5 Using OCI Continuous Query Notification Descriptors

The continuous query notification descriptor is passed into the `desc` parameter of the notification callback specified by the application. The following attributes are specific to continuous query notification. The OCI type constant of the continuous query notification descriptor is `OCI_DTYPE_CHDES`.

The notification callback receives the top-level notification descriptor, `OCI_DTYPE_CHDES`, as an argument. This descriptor in turn includes either a collection of `OCI_DTYPE_CQDES` or `OCI_DTYPE_TABLE_CHDES` descriptors based on whether the event type was `OCI_EVENT_QUERYCHANGE` or `OCI_EVENT_OBJCHANGE`. An array of table continuous query descriptors is embedded inside the continuous query descriptor for notifications of type `OCI_EVENT_QUERYCHANGE`. If ROWID level granularity of information was requested, each `OCI_DTYPE_TABLE_CHDES` contains an array of row-level continuous query descriptors (`OCI_DTYPE_ROW_CHDES`) corresponding to each modified ROWID.

18.8.5.1 OCI_DTYPE_CHDES

This is the top-level continuous query notification descriptor type.

OCI_ATTR_CHDES_DBNAME (oratext *) - Name of the database (source of the continuous query notification)

OCI_ATTR_CHDES_XID (RAW(8)) - Message ID of the message

OCI_ATTR_CHDES_NFYTYPE - Flags describing the notification type:

- 0x0 OCI_EVENT_NONE - No further information about the continuous query notification
- 0x1 OCI_EVENT_STARTUP - Instance startup
- 0x2 OCI_EVENT_SHUTDOWN - Instance shutdown
- 0x3 OCI_EVENT_SHUTDOWN_ANY - Any instance shutdown - Oracle Real Application Clusters (Oracle RAC)
- 0x5 OCI_EVENT_DEREG - Unregistered or timed out
- 0x6 OCI_EVENT_OBJCHANGE - Object change notification
- 0x7 OCI_EVENT_QUERYCHANGE - Query change notification

OCI_ATTR_CHDES_TABLE_CHANGES - A collection type describing operations on tables of data type (OCIColl *). This attribute is present only if the OCI_ATTR_CHDES_NFYTYPE attribute was of type OCI_EVENT_OBJCHANGE; otherwise, it is NULL. Each element of the collection is a table of continuous query descriptors of type OCI_DTYPE_TABLE_CHDES.

OCI_ATTR_CHDES_QUERIES - A collection type describing the queries that were invalidated. Each member of the collection is of type OCI_DTYPE_CQDES. This attribute is present only if the attribute OCI_ATTR_CHDES_NFYTYPE was of type OCI_EVENT_QUERYCHANGE; otherwise, it is NULL.

18.8.5.1.1 OCI_DTYPE_CQDES

This notification descriptor describes a query that was invalidated, usually in response to the commit of a DML or a DDL transaction. It has the following attributes:

- OCI_ATTR_CQDES_OPERATION (ub4, READ) - Operation that occurred on the query. It can be one of these values:
 - OCI_EVENT_QUERYCHANGE - Query result set change
 - OCI_EVENT_DEREG - Query unregistered
- OCI_ATTR_CQDES_TABLE_CHANGES (OCIColl *, READ) - A collection of table continuous query descriptors describing DML or DDL operations on tables that caused the query result set change. Each element of the collection is of type OCI_DTYPE_TABLE_CHDES.
- OCI_ATTR_CQDES_QUERYID (ub8, READ) - Query ID of the query that was invalidated.

18.8.5.1.2 OCI_DTYPE_TABLE_CHDES

This notification descriptor conveys information about changes to a table involved in a registered query. It has the following attributes:

- OCI_ATTR_CHDES_TABLE_NAME (oratext *) - Schema annotated table name.

- OCI_ATTR_CHDES_TABLE_OPFLAGS (ub4) - Flag field describing the operations on the table. Each of the following flag fields is in a separate bit position in the attribute:
 - 0x1 OCI_OPCODE_ALLROWS - The table is completely invalidated.
 - 0x2 OCI_OPCODE_INSERT - Insert operations on the table.
 - 0x4 OCI_OPCODE_UPDATE - Update operations on the table.
 - 0x8 OCI_OPCODE_DELETE - Delete operations on the table.
 - 0x10 OCI_OPCODE_ALTER - Table altered (schema change). This includes DDL statements and internal operations that cause row migration.
 - 0x20 OCI_OPCODE_DROP - Table dropped.
- OCI_ATTR_CHDES_TABLE_ROW_CHANGES - This is an embedded collection describing the changes to the rows within the table. Each element of the collection is a row continuous query descriptor of type OCI_DTYPE_ROW_CHDES that has the following attributes:
 - OCI_ATTR_CHDES_ROW_ROWID (OraText *) - String representation of a ROWID.
 - OCI_ATTR_CHDES_ROW_OPFLAGS - Reflects the operation type: INSERT, UPDATE, DELETE, or OTHER.

See Also:

Oracle Call Interface Programmer's Guide for more information about continuous query notification descriptor attributes

18.8.6 Demonstrating Continuous Query Notification in an OCI Sample Program

[Example 18-8](#) (page 18-37) is a simple OCI program, `demoquery.c`. See the comments in the listing. The calling session must have the `CHANGE NOTIFICATION` system privilege and `SELECT` privileges on all objects that it attempts to register.

Example 18-8 Program Listing That Demonstrates Continuous Query Notification

```

/* Copyright (c) 2010, Oracle. All rights reserved. */

#ifdef S_ORACLE
# include <oratypes.h>
#endif

/*****
 *This is a DEMO program. To test, compile the file to generate the executable
 *demoquery. Then demoquery can be invoked from a command prompt.
 *It will have the following output:

Initializing OCI Process
Registering query : select last_name, employees.department_id, department_name
                   from employees, departments
                   where employee_id = 200
                   and employees.department_id = departments.department_id

Query Id 23
Waiting for Notifications

```

*Then from another session, log in as HR/HR and perform the following
* DML transactions. It will cause two notifications to be generated.

```
update departments set department_name = 'Global Admin' where department_id=10;
commit;
update departments set department_name = 'Administration' where department_id=10;
commit;
```

*The demoquery program will now show the following output corresponding
*to the notifications received.

```
Query 23 is changed
Table changed is HR.DEPARTMENTS table_op 4
Row changed is AAAMBoAABAAAKX2AAA row_op 4
Query 23 is changed
Table changed is HR.DEPARTMENTS table_op 4
Row changed is AAAMBoAABAAAKX2AAA row_op 4
```

*The demo program waits for exactly 10 notifications to be received before
*logging off and unregistering the subscription.

```
*****/
/*-----
PRIVATE TYPES AND CONSTANTS
-----*/
/*-----
STATIC FUNCTION DECLARATIONS
-----*/

#include <stdio.h>
#include <stdlib.h>
#include <string.h>
#include <oci.h>

#define MAXSTRENGTH 1024
#define bit(a,b) ((a)&(b))

static int notifications_processed = 0;
static OCISubscription *subhandle1 = (OCISubscription *)0;
static OCISubscription *subhandle2 = (OCISubscription *)0;
static void checker(/*_ OCIError *errhp, sword status _*/);
static void registerQuery(/*_ OCISvcCtx *svchp, OCIError *errhp, OCISstmt *stmthp,
OCIEnv *envhp _*/);
static void myCallback (/*_ dvoid *ctx, OCISubscription *subscrhp,
dvoid *payload, ub4 *payl, dvoid *descriptor,
ub4 mode _*/);
static int NotificationDriver(/*_ int argc, char *argv[] _*/);
static sword status;
static boolean logged_on = FALSE;
static void processRowChanges(OCIEnv *envhp, OCIError *errhp, OCISstmt *stmthp,
OCIColl *row_changes);
static void processTableChanges(OCIEnv *envhp, OCIError *errhp,
OCISstmt *stmthp, OCIColl *table_changes);
static void processQueryChanges(OCIEnv *envhp, OCIError *errhp, OCISstmt *stmthp,
OCIColl *query_changes);
static int nonractests2(/*_ int argc, char *argv[] _*/);
```

```

int main(int argc, char **argv)
{
    NotificationDriver(argc, argv);
    return 0;
}

int NotificationDriver(argc, argv)
int argc;
char *argv[];
{
    OCIEnv *envhp;
    OCISvcCtx *svchp, *svchp2;
    OCIError *errhp, *errhp2;
    OCISession *authp, *authp2;
    OCISstmt *stmthp, *stmthp2;
    OCIDuration dur, dur2;
    int i;
    dvoid *tmp;
    OCISession *usrhp;
    OCIServer *srvhp;

    printf("Initializing OCI Process\n");
    /* Initialize the environment. The environment must be initialized
       with OCI_EVENTS and OCI_OBJECT to create a continuous query notification
       registration and receive notifications.
    */
    OCIEnvCreate( (OCIEnv **) &envhp, OCI_EVENTS|OCI_OBJECT, (dvoid *)0,
                 (dvoid * (*)(dvoid *, size_t)) 0,
                 (dvoid * (*)(dvoid *, dvoid *, size_t))0,
                 (void (*)(dvoid *, dvoid *)) 0,
                 (size_t) 0, (dvoid **) 0 );

    OCIHandleAlloc( (dvoid *) envhp, (dvoid **) &errhp, OCI_HTYPE_ERROR,
                   (size_t) 0, (dvoid **) 0);
    /* server contexts */
    OCIHandleAlloc((dvoid *) envhp, (dvoid **) &srvhp, OCI_HTYPE_SERVER,
                  (size_t) 0, (dvoid **) 0);
    OCIHandleAlloc((dvoid *) envhp, (dvoid **) &svchp, OCI_HTYPE_SVCCTX,
                  (size_t) 0, (dvoid **) 0);
    checker(errhp, OCIServerAttach(srvhp, errhp, (text *) 0, (sb4) 0,
                                   (ub4) OCI_DEFAULT));
    /* set attribute server context in the service context */
    OCIAttrSet( (dvoid *) svchp, (ub4) OCI_HTYPE_SVCCTX, (dvoid *)srvhp,
                (ub4) 0, (ub4) OCI_ATTR_SERVER, (OCIError *) errhp);

    /* allocate a user context handle */
    OCIHandleAlloc((dvoid *)envhp, (dvoid **)&usrhp, (ub4) OCI_HTYPE_SESSION,
                  (size_t) 0, (dvoid **) 0);

    OCIAttrSet((dvoid *)usrhp, (ub4)OCI_HTYPE_SESSION,
                (dvoid *)((text *)"HR"), (ub4)strlen((char *)"HR"),
                OCI_ATTR_USERNAME, errhp);

    OCIAttrSet((dvoid *)usrhp, (ub4)OCI_HTYPE_SESSION,
                (dvoid *)((text *)"HR"), (ub4)strlen((char *)"HR"),
                OCI_ATTR_PASSWORD, errhp);
    checker(errhp, OCISessionBegin (svchp, errhp, usrhp, OCI_CRED_RDBMS,

```

```

        OCI_DEFAULT));
    /* Allocate a statement handle */
    OCIHandleAlloc( (dvoid *) envhp, (dvoid **) &stmthp,
                   (ub4) OCI_HTYPE_STMT, 52, (dvoid **) &tmp);

    OCIAttrSet((dvoid *)svchp, (ub4)OCI_HTYPE_SVCCTX, (dvoid *)usrhp, (ub4)0,
              OCI_ATTR_SESSION, errhp);

    registerQuery(svchp, errhp, stmthp, envhp);
    printf("Waiting for Notifications\n");
    while (notifications_processed !=10)
    {
        sleep(1);
    }
    printf ("Going to unregister HR\n");
    fflush(stdout);
    /* Unregister HR */
    checker(errhp,
           OCISubscriptionUnRegister(svchp, subhandle1, errhp, OCI_DEFAULT));
    checker(errhp, OCISessionEnd(svchp, errhp, usrhp, (ub4) 0));
    printf("HR Logged off.\n");

    if (subhandle1)
        OCIHandleFree((dvoid *)subhandle1, OCI_HTYPE_SUBSCRIPTION);
    if (stmthp)
        OCIHandleFree((dvoid *)stmthp, OCI_HTYPE_STMT);
    if (srvhp)
        OCIHandleFree((dvoid *) srvhp, (ub4) OCI_HTYPE_SERVER);
    if (svchp)
        OCIHandleFree((dvoid *) svchp, (ub4) OCI_HTYPE_SVCCTX);
    if (authp)
        OCIHandleFree((dvoid *) usrhp, (ub4) OCI_HTYPE_SESSION);
    if (errhp)
        OCIHandleFree((dvoid *) errhp, (ub4) OCI_HTYPE_ERROR);
    if (envhp)
        OCIHandleFree((dvoid *) envhp, (ub4) OCI_HTYPE_ENV);

    return 0;
}

void checker(errhp, status)
OCIError *errhp;
sword status;
{
    text errbuf[512];
    sb4 errcode = 0;
    int retval = 1;

    switch (status)
    {
    case OCI_SUCCESS:
        retval = 0;
        break;
    case OCI_SUCCESS_WITH_INFO:
        (void) printf("Error - OCI_SUCCESS_WITH_INFO\n");
        break;
    case OCI_NEED_DATA:
        (void) printf("Error - OCI_NEED_DATA\n");
        break;
    }
}

```

```

case OCI_NO_DATA:
    (void) printf("Error - OCI_NODATA\n");
    break;
case OCI_ERROR:
    (void) OCIErrorGet((dvoid *)errhp, (ub4) 1, (text *) NULL, &errcode,
        errbuf, (ub4) sizeof(errbuf), OCI_HTYPE_ERROR);
    (void) printf("Error - %.*s\n", 512, errbuf);
    break;
case OCI_INVALID_HANDLE:
    (void) printf("Error - OCI_INVALID_HANDLE\n");
    break;
case OCI_STILL_EXECUTING:
    (void) printf("Error - OCI_STILL_EXECUTE\n");
    break;
case OCI_CONTINUE:
    (void) printf("Error - OCI_CONTINUE\n");
    break;
default:
    break;
}
if (retval)
{
    exit(1);
}
}

void processRowChanges(OCIEnv *envhp, OCIError *errhp, OCIStmt *stmthp,
    OCIColl *row_changes)
{
    dvoid **row_descp;
    dvoid *row_desc;
    boolean exist;
    ub2 i, j;
    dvoid *elemind = (dvoid *)0;
    oratext *row_id;
    ub4 row_op;

    sb4 num_rows;
    if (!row_changes) return;
    checker(errhp, OCICollSize(envhp, errhp,
        (CONST OCIColl *) row_changes, &num_rows));
    for (i=0; i<num_rows; i++)
    {
        checker(errhp, OCICollGetElem(envhp,
            errhp, (OCIColl *) row_changes,
            i, &exist, &row_descp, &elemind));

        row_desc = *row_descp;
        checker(errhp, OCIAttrGet (row_desc,
            OCI_DTYPE_ROW_CHDES, (dvoid *)&row_id,
            NULL, OCI_ATTR_CHDES_ROW_ROWID, errhp));
        checker(errhp, OCIAttrGet (row_desc,
            OCI_DTYPE_ROW_CHDES, (dvoid *)&row_op,
            NULL, OCI_ATTR_CHDES_ROW_OPFLAGS, errhp));

        printf ("Row changed is %s row_op %d\n", row_id, row_op);
        fflush(stdout);
    }
}

```

```

void processTableChanges(OCIEnv *envhp, OCIError *errhp, OCIStmt *stmthp,
                        OCIColl *table_changes)
{
    dvoid **table_descp;
    dvoid *table_desc;
    dvoid **row_descp;
    dvoid *row_desc;
    OCIColl *row_changes = (OCIColl *)0;
    boolean exist;
    ub2 i, j;
    dvoid *elemind = (dvoid *)0;
    oratext *table_name;
    ub4 table_op;

    sb4 num_tables;
    if (!table_changes) return;
    checker(errhp, OCICollSize(envhp, errhp,
                              (CONST OCIColl *) table_changes, &num_tables));
    for (i=0; i<num_tables; i++)
    {
        checker(errhp, OCICollGetElem(envhp,
                                      errhp, (OCIColl *) table_changes,
                                      i, &exist, &table_descp, &elemind));

        table_desc = *table_descp;
        checker(errhp, OCIAttrGet (table_desc,
                                  OCI_DTYPE_TABLE_CHDES, (dvoid *)&table_name,
                                  NULL, OCI_ATTR_CHDES_TABLE_NAME, errhp));
        checker(errhp, OCIAttrGet (table_desc,
                                  OCI_DTYPE_TABLE_CHDES, (dvoid *)&table_op,
                                  NULL, OCI_ATTR_CHDES_TABLE_OPFLAGS, errhp));
        checker(errhp, OCIAttrGet (table_desc,
                                  OCI_DTYPE_TABLE_CHDES, (dvoid *)&row_changes,
                                  NULL, OCI_ATTR_CHDES_TABLE_ROW_CHANGES, errhp));

        printf ("Table changed is %s table_op %d\n", table_name, table_op);
        fflush(stdout);
        if (!bit(table_op, OCI_OPCODE_ALLROWS))
            processRowChanges(envhp, errhp, stmthp, row_changes);
    }
}

void processQueryChanges(OCIEnv *envhp, OCIError *errhp, OCIStmt *stmthp,
                        OCIColl *query_changes)
{
    sb4 num_queries;
    ub8 queryid;
    OCINumber qidnum;
    ub4 queryop;
    dvoid *elemind = (dvoid *)0;
    dvoid *query_desc;
    dvoid **query_descp;
    ub2 i;
    boolean exist;
    OCIColl *table_changes = (OCIColl *)0;

    if (!query_changes) return;
    checker(errhp, OCICollSize(envhp, errhp,
                              (CONST OCIColl *) query_changes, &num_queries));

```

```

for (i=0; i < num_queries; i++)
{
    checker(errhp, OCICollGetElem(envhp,
        errhp, (OCIColl *) query_changes,
        i, &exist, &query_descp, &elemind));

    query_desc = *query_descp;
    checker(errhp, OCIAttrGet (query_desc,
        OCI_DTYPE_CQDES, (dvoid *)&queryid,
        NULL, OCI_ATTR_CQDES_QUERYID, errhp));
    checker(errhp, OCIAttrGet (query_desc,
        OCI_DTYPE_CQDES, (dvoid *)&queryop,
        NULL, OCI_ATTR_CQDES_OPERATION, errhp));
    printf(" Query %d is changed\n", queryid);
    if (queryop == OCI_EVENT_DEREG)
        printf("Query Deregistered\n");
    checker(errhp, OCIAttrGet (query_desc,
        OCI_DTYPE_CQDES, (dvoid *)&table_changes,
        NULL, OCI_ATTR_CQDES_TABLE_CHANGES, errhp));
    processTableChanges(envhp, errhp, stmthp, table_changes);

}
}

void myCallback (ctx, subscrhp, payload, payl, descriptor, mode)
dvoid *ctx;
OCISubscription *subscrhp;
dvoid *payload;
ub4 *payl;
dvoid *descriptor;
ub4 mode;
{
    OCIColl *table_changes = (OCIColl *)0;
    OCIColl *row_changes = (OCIColl *)0;
    dvoid *change_descriptor = descriptor;
    ub4 notify_type;
    ub2 i, j;
    OCIEnv *envhp;
    OCIError *errhp;
    OCIColl *query_changes = (OCIColl *)0;
    OCIServer *srvhp;
    OCISvcCtx *svchp;
    OCISession *usrhp;
    dvoid *tmp;
    OCISmt *stmthp;

(void)OCIEnvInit( (OCIEnv **) &envhp, OCI_DEFAULT, (size_t)0, (dvoid **)0 );

(void) OCIHandleAlloc( (dvoid *) envhp, (dvoid **) &errhp, OCI_HTYPE_ERROR,
    (size_t) 0, (dvoid **) 0);
/* server contexts */
(void) OCIHandleAlloc( (dvoid *) envhp, (dvoid **) &srvhp, OCI_HTYPE_SERVER,
    (size_t) 0, (dvoid **) 0);

(void) OCIHandleAlloc( (dvoid *) envhp, (dvoid **) &svchp, OCI_HTYPE_SVCCTX,
    (size_t) 0, (dvoid **) 0);

OCIAttrGet (change_descriptor, OCI_DTYPE_CHDES, (dvoid *) &notify_type,
    NULL, OCI_ATTR_CHDES_NFYTYPE, errhp);

```

```

fflush(stdout);
if (notify_type == OCI_EVENT_SHUTDOWN ||
    notify_type == OCI_EVENT_SHUTDOWN_ANY)
{
    printf("SHUTDOWN NOTIFICATION RECEIVED\n");
    fflush(stdout);
    notifications_processed++;
    return;
}
if (notify_type == OCI_EVENT_STARTUP)
{
    printf("STARTUP NOTIFICATION RECEIVED\n");
    fflush(stdout);
    notifications_processed++;
    return;
}

notifications_processed++;
checker(errhp, OCIServerAttach( srvhp, errhp, (text *) 0, (sb4) 0,
                               (ub4) OCI_DEFAULT));

OCIHandleAlloc( (dvoid *) envhp, (dvoid **) &svchp, (ub4) OCI_HTYPE_SVCCTX,
                52, (dvoid **) &tmp);
/* set attribute server context in the service context */
OCIAttrSet( (dvoid *) svchp, (ub4) OCI_HTYPE_SVCCTX, (dvoid *)srvhp,
            (ub4) 0, (ub4) OCI_ATTR_SERVER, (OCIError *) errhp);

/* allocate a user context handle */
OCIHandleAlloc((dvoid *)envhp, (dvoid **)&usrhp, (ub4) OCI_HTYPE_SESSION,
               (size_t) 0, (dvoid **) 0);

OCIAttrSet((dvoid *)usrhp, (ub4)OCI_HTYPE_SESSION,
            (dvoid *)"HR", (ub4)strlen("HR"), OCI_ATTR_USERNAME, errhp);

OCIAttrSet((dvoid *)usrhp, (ub4)OCI_HTYPE_SESSION,
            (dvoid *)"HR", (ub4)strlen("HR"),
            OCI_ATTR_PASSWORD, errhp);

checker(errhp, OCISessionBegin (svchp, errhp, usrhp, OCI_CRED_RDBMS,
                               OCI_DEFAULT));

OCIAttrSet((dvoid *)svchp, (ub4)OCI_HTYPE_SVCCTX,
            (dvoid *)usrhp, (ub4)0, OCI_ATTR_SESSION, errhp);

/* Allocate a statement handle */
OCIHandleAlloc( (dvoid *) envhp, (dvoid **) &stmthp,
                (ub4) OCI_HTYPE_STMT, 52, (dvoid **) &tmp);

if (notify_type == OCI_EVENT_OBJCHANGE)
{
    checker(errhp, OCIAttrGet (change_descriptor,
                              OCI_DTYPE_CHDES, &table_changes, NULL,
                              OCI_ATTR_CHDES_TABLE_CHANGES, errhp));
    processTableChanges(envhp, errhp, stmthp, table_changes);
}
else if (notify_type == OCI_EVENT_QUERYCHANGE)
{
    checker(errhp, OCIAttrGet (change_descriptor,
                              OCI_DTYPE_CHDES, &query_changes, NULL,
                              OCI_ATTR_CHDES_QUERIES, errhp));
    processQueryChanges(envhp, errhp, stmthp, query_changes);
}

```



```

    }
    checker(errhp, OCISessionEnd(svchp, errhp, usrhp, OCI_DEFAULT));
    checker(errhp, OCIserverDetach(srvhp, errhp, OCI_DEFAULT));
if (stmthp)
    OCIHandleFree((dvoid *)stmthp, OCI_HTYPE_STMT);
if (errhp)
    OCIHandleFree((dvoid *)errhp, OCI_HTYPE_ERROR);
if (srvhp)
    OCIHandleFree((dvoid *)srvhp, OCI_HTYPE_SERVER);
if (svchp)
    OCIHandleFree((dvoid *)svchp, OCI_HTYPE_SVCCTX);
if (usrhp)
    OCIHandleFree((dvoid *)usrhp, OCI_HTYPE_SESSION);
if (envhp)
    OCIHandleFree((dvoid *)envhp, OCI_HTYPE_ENV);
}

void registerQuery(svchp, errhp, stmthp, envhp)
OCISvcCtx *svchp;
OCIError *errhp;
OCIStmt *stmthp;
OCIEnv *envhp;
{
    OCISubscription *subscrhp;
    ub4 namespace = OCI_SUBSCR_NAMESPACE_DBCHANGE;
    ub4 timeout = 60;
    OCIDefine *defnp1 = (OCIDefine *)0;
    OCIDefine *defnp2 = (OCIDefine *)0;
    OCIDefine *defnp3 = (OCIDefine *)0;
    OCIDefine *defnp4 = (OCIDefine *)0;
    OCIDefine *defnp5 = (OCIDefine *)0;
    int mgr_id =0;
text query_text1[] = "select last_name, employees.department_id, department_name \
from employees,departments where employee_id = 200 and employees.department_id =\
departments.department_id";

    ub4 num_prefetch_rows = 0;
    ub4 num_reg_tables;
    OCIColl *table_names;
    ub2 i;
    boolean rowids = TRUE;
    ub4 qosflags = OCI_SUBSCR_CQ_QOS_QUERY ;
    int empno=0;
    OCINumber qidnum;
    ub8 qid;
    char outstr[MAXSTRLLENGTH], dname[MAXSTRLLENGTH];
    int q3out;

    fflush(stdout);
    /* allocate subscription handle */
    OCIHandleAlloc ((dvoid *) envhp, (dvoid **) &subscrhp,
                    OCI_HTYPE_SUBSCRIPTION, (size_t) 0, (dvoid **) 0);

    /* set the namespace to DBCHANGE */
    checker(errhp, OCIAttrSet (subscrhp, OCI_HTYPE_SUBSCRIPTION,
                              (dvoid *) &namespace, sizeof(ub4),
                              OCI_ATTR_SUBSCR_NAMESPACE, errhp));

    /* Associate a notification callback with the subscription */
    checker(errhp, OCIAttrSet (subscrhp, OCI_HTYPE_SUBSCRIPTION,

```

```

        (void *)myCallback, 0, OCI_ATTR_SUBSCR_CALLBACK, errhp));
/* Allow extraction of rowid information */
checker(errhp, OCIAttrSet (subscrhp, OCI_HTYPE_SUBSCRIPTION,
    (dvoid *)&rowids, sizeof(ub4),
    OCI_ATTR_CHNF_ROWIDS, errhp));

    checker(errhp, OCIAttrSet (subscrhp, OCI_HTYPE_SUBSCRIPTION,
        (dvoid *)&qosflags, sizeof(ub4),
        OCI_ATTR_SUBSCR_CQ_QOSFLAGS, errhp));

/* Create a new registration in the DBCHANGE namespace */
checker(errhp,
    OCISubscriptionRegister(svchp, &subscrhp, 1, errhp, OCI_DEFAULT));

/* Multiple queries can now be associated with the subscription */

    subhandle1 = subscrhp;

    printf("Registering query : %s\n", (const signed char *)query_text1);
/* Prepare the statement */
checker(errhp, OCIStmtPrepare (stmthp, errhp, query_text1,
    (ub4)strlen((const signed char *)query_text1), OCI_V7_SYNTAX,
    OCI_DEFAULT));

    checker(errhp,
        OCIDefineByPos(stmthp, &defnp1,
            errhp, 1, (dvoid *)outstr, MAXSTRLength * sizeof(char),
            SQLT_STR, (dvoid *)0, (ub2 *)0, (ub2 *)0, OCI_DEFAULT));
    checker(errhp,
        OCIDefineByPos(stmthp, &defnp2,
            errhp, 2, (dvoid *)&empno, sizeof(empno),
            SQLT_INT, (dvoid *)0, (ub2 *)0, (ub2 *)0, OCI_DEFAULT));
    checker(errhp,
        OCIDefineByPos(stmthp, &defnp3,
            errhp, 3, (dvoid *)&dname, sizeof(dname),
            SQLT_STR, (dvoid *)0, (ub2 *)0, (ub2 *)0, OCI_DEFAULT));

/* Associate the statement with the subscription handle */
OCIAttrSet (stmthp, OCI_HTYPE_STMT, subscrhp, 0,
    OCI_ATTR_CHNF_REGHANDLE, errhp);

/* Execute the statement, the execution performs object registration */
checker(errhp, OCIStmtExecute (svchp, stmthp, errhp, (ub4) 1, (ub4) 0,
    (CONST OCISnapshot *) NULL, (OCISnapshot *) NULL,
    OCI_DEFAULT));
fflush(stdout);

OCIAttrGet(stmthp, OCI_HTYPE_STMT, &qid, (ub4 *)0,
    OCI_ATTR_CQ_QUERYID, errhp);
printf("Query Id %d\n", qid);

/* commit */
checker(errhp, OCITransCommit(svchp, errhp, (ub4) 0));
}

static void cleanup(envhp, svchp, srvhp, errhp, usrhp)
OCIEnv *envhp;
OCISvcCtx *svchp;
OCIServer *srvhp;

```

```

OCIError *errhp;
OCISession *usrhp;
{
    /* detach from the server */
    checker(errhp, OCISessionEnd(svchp, errhp, usrhp, OCI_DEFAULT));
    checker(errhp, OCIserverDetach(srvhp, errhp, (ub4)OCI_DEFAULT));

    if (usrhp)
        (void) OCIHandleFree((dvoid *) usrhp, (ub4) OCI_HTYPE_SESSION);
    if (svchp)
        (void) OCIHandleFree((dvoid *) svchp, (ub4) OCI_HTYPE_SVCCTX);
    if (srvhp)
        (void) OCIHandleFree((dvoid *) srvhp, (ub4) OCI_HTYPE_SERVER);
    if (errhp)
        (void) OCIHandleFree((dvoid *) errhp, (ub4) OCI_HTYPE_ERROR);
    if (envhp)
        (void) OCIHandleFree((dvoid *) envhp, (ub4) OCI_HTYPE_ENV);
}

```

18.9 Querying CQN Registrations

To see top-level information about all registrations, including their QOS options, query the static data dictionary view `*_CHANGE_NOTIFICATION_REGS`.

For example, you can obtain the registration ID for a client and the list of objects for which it receives notifications. To view registration IDs and table names for HR, use this query:

```
SELECT regid, table_name FROM USER_CHANGE_NOTIFICATION_REGS;
```

To see which queries are registered for QRCN, query the static data dictionary view `USER_CQ_NOTIFICATION_QUERIES` or `DBA_CQ_NOTIFICATION_QUERIES`. These views include information about any bind values that the queries use. In these views, bind values in the original query are included in the query text as constants. The query text is equivalent, but maybe not identical, to the original query that was registered.

See Also:

Oracle Database Reference for more information about the static data dictionary views `USER_CHANGE_NOTIFICATION_REGS` and `DBA_CQ_NOTIFICATION_QUERIES`

18.10 Interpreting Notifications

When a transaction commits, the database determines whether registered objects were modified in the transaction. If so, it runs the notification handler specified in the registration.

Topics:

- [Interpreting a CQ_NOTIFICATION\\$_DESCRIPTOR Object](#) (page 18-48)
- [Interpreting a CQ_NOTIFICATION\\$_TABLE Object](#) (page 18-49)
- [Interpreting a CQ_NOTIFICATION\\$_QUERY Object](#) (page 18-50)

- [Interpreting a CQ_NOTIFICATION\\$_ROW Object](#) (page 18-50)

18.10.1 Interpreting a CQ_NOTIFICATION\$_DESCRIPTOR Object

When a CQN registration generates a notification, the database passes a CQ_NOTIFICATION\$_DESCRIPTOR object to the notification handler. The notification handler can find the details of the database change in the attributes of the CQ_NOTIFICATION\$_DESCRIPTOR object.

In SQL*Plus, you can list these attributes by connecting as SYS and running this statement:

```
DESC CQ_NOTIFICATION$_DESCRIPTOR
```

[Table 18-4](#) (page 18-48) summarizes the attributes of CQ_NOTIFICATION\$_DESCRIPTOR.

Table 18-4 Attributes of CQ_NOTIFICATION\$_DESCRIPTOR

Attribute	Description
REGISTRATION_ID	The registration ID that was returned during registration.
TRANSACTION_ID	The ID for the transaction that made the change.
DBNAME	The name of the database in which the notification was generated.
EVENT_TYPE	The database event that triggers a notification. For example, the attribute can contain these constants, which correspond to different database events: <ul style="list-style-type: none"> • EVENT_NONE • EVENT_STARTUP (Instance startup) • EVENT_SHUTDOWN (Instance shutdown - last instance shutdown for Oracle RAC) • EVENT_SHUTDOWN_ANY (Any instance shutdown for Oracle RAC) • EVENT_DEREG (Registration was removed) • EVENT_OBJCHANGE (Change to a registered table) • EVENT_QUERYCHANGE (Change to a registered result set)
NUMTABLES	The number of tables that were modified.
TABLE_DESC_ARRAY	This field is present only for OCN registrations. For QRCN registrations, it is NULL. If EVENT_TYPE is EVENT_OBJCHANGE]: a VARRAY of table change descriptors of type CQ_NOTIFICATION\$_TABLE, each of which corresponds to a changed table. For attributes of CQ_NOTIFICATION\$_TABLE, see Table 18-5 (page 18-49). Otherwise: NULL.

Table 18-4 (Cont.) Attributes of CQ_NOTIFICATION\$_DESCRIPTOR

Attribute	Description
QUERY_DESC_ARRAY	This field is present only for QRCN registrations. For OCN registrations, it is NULL. If EVENT_TYPE is EVENT_QUERYCHANGE]: a VARRAY of result set change descriptors of type CQ_NOTIFICATION\$_QUERY, each of which corresponds to a changed result set. For attributes of CQ_NOTIFICATION\$_QUERY, see Table 18-6 (page 18-50). Otherwise: NULL.

18.10.2 Interpreting a CQ_NOTIFICATION\$_TABLE Object

The CQ_NOTIFICATION\$_DESCRIPTOR type contains an attribute called TABLE_DESC_ARRAY, which holds a VARRAY of table descriptors of type CQ_NOTIFICATION\$_TABLE.

In SQL*Plus, you can list these attributes by connecting as SYS and running this statement:

```
DESC CQ_NOTIFICATION$_TABLE
```

[Table 18-5](#) (page 18-49) summarizes the attributes of CQ_NOTIFICATION\$_TABLE.

Table 18-5 Attributes of CQ_NOTIFICATION\$_TABLE

Attribute	Specifies . . .
OPFLAGS	The type of operation performed on the modified table. For example, the attribute can contain these constants, which correspond to different database operations: <ul style="list-style-type: none"> • ALL_ROWS signifies that either the entire table is modified, as in a DELETE *, or row-level granularity of information is not requested or unavailable in the notification, and the recipient must assume that the entire table has changed • UPDATEOP signifies an update • DELETEOP signifies a deletion • ALTEROP signifies an ALTER TABLE • DROPOP signifies a DROP TABLE • UNKNOWNOP signifies an unknown operation
TABLE_NAME	The name of the modified table.
NUMROWS	The number of modified rows.
ROW_DESC_ARRAY	A VARRAY of row descriptors of type CQ_NOTIFICATION\$_ROW, which Table 18-7 (page 18-50) describes. If ALL_ROWS was set in the opflags, then the ROW_DESC_ARRAY member is NULL.

18.10.3 Interpreting a CQ_NOTIFICATION\$_QUERY Object

The CQ_NOTIFICATION\$_DESCRIPTOR type contains an attribute called QUERY_DESC_ARRAY, which holds a VARRAY of result set change descriptors of type CQ_NOTIFICATION\$_QUERY.

In SQL*Plus, you can list these attributes by connecting as SYS and running this statement:

```
DESC CQ_NOTIFICATION$_QUERY
```

[Table 18-6](#) (page 18-50) summarizes the attributes of CQ_NOTIFICATION\$_QUERY.

Table 18-6 Attributes of CQ_NOTIFICATION\$_QUERY

Attribute	Specifies . . .
QUERYID	Query ID of the changed query.
QUERYOP	Operation that changed the query (either EVENT_QUERYCHANGE or EVENT_DEREG).
TABLE_DESC_ARRAY	A VARRAY of table change descriptors of type CQ_NOTIFICATION\$_TABLE, each of which corresponds to a changed table that caused a change in the result set. For attributes of CQ_NOTIFICATION\$_TABLE, see Table 18-5 (page 18-49).

18.10.4 Interpreting a CQ_NOTIFICATION\$_ROW Object

If the ROWID option was specified during registration, the CQ_NOTIFICATION\$_TABLE type has a ROW_DESC_ARRAY attribute, a VARRAY of type CQ_NOTIFICATION\$_ROW that contains the ROWIDs for the changed rows. If ALL_ROWS was set in the OPFLAGS field of the CQ_NOTIFICATION\$_TABLE object, then ROWID information is unavailable.

[Table 18-7](#) (page 18-50) summarizes the attributes of CQ_NOTIFICATION\$_ROW.

Table 18-7 Attributes of CQ_NOTIFICATION\$_ROW

Attribute	Specifies . . .
OPFLAGS	The type of operation performed on the modified table. See the description of OPFLAGS in Table 18-5 (page 18-49).
ROW_ID	The ROWID of the changed row.

Part IV

Advanced Topics for Application Developers

This part presents application development information that either involves sophisticated technology or is used by a small minority of developers.

Chapters:

- [Using Oracle Flashback Technology](#) (page 19-1)
- [Choosing a Programming Environment](#) (page 20-1)
- [Developing Applications with Multiple Programming Languages](#) (page 21-1)
- [Developing Applications with Oracle XA](#) (page 22-1)
- [Developing Applications with the Publish-Subscribe Model](#) (page 23-1)
- [Using the Oracle ODBC Driver](#) (page 24-1)
- [Using the Identity Code Package](#) (page 25-1)
- [Understanding Schema Object Dependency](#) (page 26-1)
- [Using Edition-Based Redefinition](#) (page 27-1)
- [Using Transaction Guard](#) (page 28-1)

See Also:

Oracle Database Performance Tuning Guide and *Oracle Database SQL Tuning Guide* for performance issues to consider when developing applications

Using Oracle Flashback Technology

This chapter explains how to use Oracle Flashback Technology in database applications.

Topics:

- [Overview of Oracle Flashback Technology](#) (page 19-1)
- [Configuring Your Database for Oracle Flashback Technology](#) (page 19-4)
- [Using Oracle Flashback Query \(SELECT AS OF\)](#) (page 19-7)
- [Using Oracle Flashback Version Query](#) (page 19-9)
- [Using Oracle Flashback Transaction Query](#) (page 19-11)
- [Using Oracle Flashback Transaction Query with Oracle Flashback Version Query](#) (page 19-12)
- [Using DBMS_FLASHBACK Package](#) (page 19-14)
- [Using Flashback Transaction](#) (page 19-15)
- [Using Flashback Data Archive](#) (page 19-18)
- [General Guidelines for Oracle Flashback Technology](#) (page 19-27)
- [Performance Guidelines for Oracle Flashback Technology](#) (page 19-29)
- [Multitenant Container Database Restrictions for Oracle Flashback Technology](#) (page 19-29)

19.1 Overview of Oracle Flashback Technology

Oracle Flashback Technology is a group of Oracle Database features that let you view past states of database objects or to return database objects to a previous state without using point-in-time media recovery.

With flashback features, you can:

- Perform queries that return past data
- Perform queries that return metadata that shows a detailed history of changes to the database
- Recover tables or rows to a previous point in time
- Automatically track and archive transactional data changes

- Roll back a transaction and its dependent transactions while the database remains online

Oracle Flashback features use the Automatic Undo Management (AUM) system to obtain metadata and historical data for transactions. They rely on **undo data**, which are records of the effects of individual transactions. For example, if a user runs an UPDATE statement to change a salary from 1000 to 1100, then Oracle Database stores the value 1000 in the undo data.

Undo data is persistent and survives a database shutdown. It is retained for the time specified by `undo_retention`, or up to the tuned undo retention in the presence of Automatic Undo Management (AUM). By using flashback features, you can use undo data to query past data or recover from logical damage. Besides using it in flashback features, Oracle Database uses undo data to perform these actions:

- Roll back active transactions
- Recover terminated transactions by using database or process recovery
- Provide read consistency for SQL queries

Note:

After executing a CREATE TABLE statement, wait at least 15 seconds to commit any transactions, to ensure that Oracle Flashback features (especially Oracle Flashback Version Query) reflect those transactions.

Note:

Oracle Database recommends to avoid the usage of `versions_starttime`, `versions_endtime` or `scn_to_timestamp` columns in VERSIONS queries (including CTAS queries) to improve the performance.

Topics:

- [Application Development Features](#) (page 19-2)
- [Database Administration Features](#) (page 19-3)

For additional general information about flashback features, see *Oracle Database Concepts*

19.1.1 Application Development Features

In application development, you can use these flashback features to report historical data or undo erroneous changes. (You can also use these features interactively as a database user or administrator.)

Oracle Flashback Query

Use this feature to retrieve data for an earlier time that you specify with the AS OF clause of the SELECT statement. For more information, see [Using Oracle Flashback Query \(SELECT AS OF\)](#) (page 19-7).

Oracle Flashback Version Query

Use this feature to retrieve metadata and historical data for a specific time interval (for example, to view all the rows of a table that ever existed during a given time interval). Metadata for each row version includes start and end time, type of change operation, and identity of the transaction that created the row version. To create an Oracle Flashback Version Query, use the `VERSIONS BETWEEN` clause of the `SELECT` statement. For more information, see [Using Oracle Flashback Version Query](#) (page 19-9).

Oracle Flashback Transaction Query

Use this feature to retrieve metadata and historical data for a given transaction or for all transactions in a given time interval. To perform an Oracle Flashback Transaction Query, select from the static data dictionary view `FLASHBACK_TRANSACTION_QUERY`. For more information, see [Using Oracle Flashback Transaction Query](#) (page 19-11).

Typically, you use Oracle Flashback Transaction Query with an Oracle Flashback Version Query that provides the transaction IDs for the rows of interest (see [Using Oracle Flashback Transaction Query with Oracle Flashback Version Query](#) (page 19-12).)

DBMS_FLASHBACK Package

Use this feature to set the internal Oracle Database clock to an earlier time so that you can examine data that was current at that time, or to roll back a transaction and its dependent transactions while the database remains online (see [Flashback Transaction](#) (page 19-3)). For more information, see [Using DBMS_FLASHBACK Package](#) (page 19-14).

Flashback Transaction

Use Flashback Transaction to roll back a transaction and its dependent transactions while the database remains online. This recovery operation uses undo data to create and run the corresponding compensating transactions that return the affected data to its original state. (Flashback Transaction is part of `DBMS_FLASHBACK` package.) For more information, see [Using DBMS_FLASHBACK Package](#) (page 19-14).

Flashback Data Archive

Use Flashback Data Archive to automatically track and archive historical versions of changes to tables enabled for flashback archive, ensuring SQL-level access to the versions of database objects without getting a snapshot-too-old error. For more information, see [Using Flashback Data Archive](#) (page 19-18).

19.1.2 Database Administration Features

These flashback features are primarily for data recovery. Typically, you use these features only as a database administrator.

This chapter focuses on the [Application Development Features](#) (page 19-2). For more information about the database administration features, see *Oracle Database Administrator's Guide* and the *Oracle Database Backup and Recovery User's Guide*.

Oracle Flashback Table

Use this feature to restore a table to its state at a previous point in time. You can restore a table while the database is on line, undoing changes to only the specified table.

Oracle Flashback Drop

Use this feature to recover a dropped table. This feature reverses the effects of a `DROP TABLE` statement.

Oracle Flashback Database

Use this feature to quickly return the database to an earlier point in time, by using the recovery area. This is fast, because you do not have to restore database backups.

19.2 Configuring Your Database for Oracle Flashback Technology

Before you can use flashback features in your application, you or your database administrator must perform the configuration tasks described in these topics:

Topics:

- [Configuring Your Database for Automatic Undo Management](#) (page 19-4)
- [Configuring Your Database for Oracle Flashback Transaction Query](#) (page 19-5)
- [Configuring Your Database for Flashback Transaction](#) (page 19-5)
- [Enabling Oracle Flashback Operations on Specific LOB Columns](#) (page 19-5)
- [Granting Necessary Privileges](#) (page 19-6)

19.2.1 Configuring Your Database for Automatic Undo Management

To configure your database for Automatic Undo Management (AUM), you or your database administrator must:

- Create an undo tablespace with enough space to keep the required data for flashback operations.

The more often users update the data, the more space is required. The database administrator usually calculates the space requirement.
- Enable AUM, as explained in *Oracle Database Administrator's Guide*. Set these database initialization parameters:

- `UNDO_MANAGEMENT`
- `UNDO_TABLESPACE`
- `UNDO_RETENTION`

For a fixed-size undo tablespace, Oracle Database automatically tunes the system to give the undo tablespace the best possible undo retention.

For an automatically extensible undo tablespace, Oracle Database retains undo data longer than the longest query duration and the low threshold of undo retention specified by the `UNDO_RETENTION` parameter.

Note:

You can query `V$UNDOSTAT.TUNED_UNDORETENTION` to determine the amount of time for which undo is retained for the current undo tablespace. For more information about `V$UNDOSTAT`, see *Oracle Database Reference*.

Setting `UNDO_RETENTION` does not guarantee that unexpired undo data is not discarded. If the system needs more space, Oracle Database can overwrite unexpired undo with more recently generated undo data.

- Specify the `RETENTION GUARANTEE` clause for the undo tablespace to ensure that unexpired undo data is not discarded.

See Also:

Oracle Database Administrator's Guide for more information about creating an undo tablespace and enabling AUM

19.2.2 Configuring Your Database for Oracle Flashback Transaction Query

To configure your database for the Oracle Flashback Transaction Query feature, you or your database administrator must:

- Ensure that Oracle Database is running with version 10.0 compatibility.
- Enable supplemental logging:

```
ALTER DATABASE ADD SUPPLEMENTAL LOG DATA;
```

19.2.3 Configuring Your Database for Flashback Transaction

To configure your database for the Flashback Transaction feature, you or your database administrator must:

- With the database mounted but not open, enable `ARCHIVELOG`:

```
ALTER DATABASE ARCHIVELOG;
```

- Open at least one archive log:

```
ALTER SYSTEM ARCHIVE LOG CURRENT;
```

- If not done, enable minimal and primary key supplemental logging:

```
ALTER DATABASE ADD SUPPLEMENTAL LOG DATA;
ALTER DATABASE ADD SUPPLEMENTAL LOG DATA (PRIMARY KEY) COLUMNS;
```

- If you want to track foreign key dependencies, enable foreign key supplemental logging:

```
ALTER DATABASE ADD SUPPLEMENTAL LOG DATA (FOREIGN KEY) COLUMNS;
```

Note:

If you have very many foreign key constraints, enabling foreign key supplemental logging might not be worth the performance penalty.

19.2.4 Enabling Oracle Flashback Operations on Specific LOB Columns

To enable flashback operations on specific LOB columns of a table, use the `ALTER TABLE` statement with the `RETENTION` option.

Because undo data for LOB columns can be voluminous, you must define which LOB columns to use with flashback operations.

See Also:

Oracle Database SecureFiles and Large Objects Developer's Guide to learn about LOB storage and the `RETENTION` parameter

19.2.5 Granting Necessary Privileges

You or your database administrator must grant privileges to users, roles, or applications that must use these flashback features. For information about the `GRANT` statement, see *Oracle Database SQL Language Reference*.

For Oracle Flashback Query and Oracle Flashback Version Query

To allow access to specific objects during queries, grant `FLASHBACK` and either `READ` or `SELECT` privileges on those objects.

To allow queries on all tables, grant the `FLASHBACK ANY TABLE` privilege.

For Oracle Flashback Transaction Query

Grant the `SELECT ANY TRANSACTION` privilege.

To allow execution of undo SQL code retrieved by an Oracle Flashback Transaction Query, grant `SELECT`, `UPDATE`, `DELETE`, and `INSERT` privileges for specific tables.

For DBMS_FLASHBACK Package

To allow access to the features in the `DBMS_FLASHBACK` package, grant the `EXECUTE` privilege on `DBMS_FLASHBACK`.

For Flashback Data Archive

To allow a specific user to enable Flashback Data Archive on tables, using a specific Flashback Data Archive, grant the `FLASHBACK ARCHIVE` object privilege on that Flashback Data Archive to that user. To grant the `FLASHBACK ARCHIVE` object privilege, you must either be logged on as `SYSDBA` or have `FLASHBACK ARCHIVE ADMINISTER` system privilege.

To allow execution of these statements, grant the `FLASHBACK ARCHIVE ADMINISTER` system privilege:

- `CREATE FLASHBACK ARCHIVE`
- `ALTER FLASHBACK ARCHIVE`
- `DROP FLASHBACK ARCHIVE`

To grant the `FLASHBACK ARCHIVE ADMINISTER` system privilege, you must be logged on as `SYSDBA`.

To create a default Flashback Data Archive, using either the `CREATE FLASHBACK ARCHIVE` or `ALTER FLASHBACK ARCHIVE` statement, you must be logged on as `SYSDBA`.

To disable Flashback Data Archive for a table that has been enabled for Flashback Data Archive, you must either be logged on as `SYSDBA` or have the `FLASHBACK ARCHIVE ADMINISTER` system privilege.

19.3 Using Oracle Flashback Query (SELECT AS OF)

To use Oracle Flashback Query, use a `SELECT` statement with an `AS OF` clause. Oracle Flashback Query retrieves data as it existed at an earlier time. The query explicitly references a past time through a time stamp or System Change Number (SCN). It returns committed data that was current at that point in time.

Uses of Oracle Flashback Query include:

- Recovering lost data or undoing incorrect, committed changes.
For example, if you mistakenly delete or update rows, and then commit them, you can immediately undo the mistake.
- Comparing current data with the corresponding data at an earlier time.
For example, you can run a daily report that shows the change in data from yesterday. You can compare individual rows of table data or find intersections or unions of sets of rows.
- Checking the state of transactional data at a particular time.
For example, you can verify the account balance of a certain day.
- Selecting data that was valid at a particular time or at any time within a user-defined valid time period.
For example, you can find employees with valid employee information as of a particular timestamp or between a specified start and end time in the specified valid time period. (For more information, see [Temporal Validity Support](#) (page 1-11).)
- Simplifying application design by removing the need to store some kinds of temporal data.
Oracle Flashback Query lets you retrieve past data directly from the database.
- Applying packaged applications, such as report generation tools, to past data.
- Providing self-service error correction for an application, thereby enabling users to undo and correct their errors.

Topics:

- [Example: Examining and Restoring Past Data](#) (page 19-7)
- [Guidelines for Oracle Flashback Query](#) (page 19-8)

For more information about the `SELECT AS OF` statement, see *Oracle Database SQL Language Reference*.

19.3.1 Example: Examining and Restoring Past Data

Suppose that you discover at 12:30 PM that the row for employee Chung was deleted from the `employees` table, and you know that at 9:30AM the data for Chung was correctly stored in the database. You can use Oracle Flashback Query to examine the contents of the table at 9:30 AM to find out what data was lost. If appropriate, you can restore the lost data.

[Example 19-1](#) (page 19-8) retrieves the state of the record for Chung at 9:30AM, April 4, 2004:

Example 19-1 Retrieving a Lost Row with Oracle Flashback Query

```
SELECT * FROM employees
AS OF TIMESTAMP
TO_TIMESTAMP('2004-04-04 09:30:00', 'YYYY-MM-DD HH:MI:SS')
WHERE last_name = 'Chung';
```

[Example 19-2](#) (page 19-8) restores Chung's information to the employees table:

Example 19-2 Restoring a Lost Row After Oracle Flashback Query

```
INSERT INTO employees (
  SELECT * FROM employees
  AS OF TIMESTAMP
  TO_TIMESTAMP('2004-04-04 09:30:00', 'YYYY-MM-DD HH:MI:SS')
  WHERE last_name = 'Chung'
);
```

19.3.2 Guidelines for Oracle Flashback Query

- You can specify or omit the AS OF clause for each table and specify different times for different tables.

Note:

If a table is a Flashback Data Archive and you specify a time for it that is earlier than its creation time, the query returns zero rows for that table, rather than causing an error. (For information about Flashback Data Archives, see [Using Flashback Data Archive](#) (page 19-18).)

- You can use the AS OF clause in queries to perform data definition language (DDL) operations (such as creating and truncating tables) or data manipulation language (DML) statements (such as INSERT and DELETE) in the same session as Oracle Flashback Query.
- To use the result of Oracle Flashback Query in a DDL or DML statement that affects the current state of the database, use an AS OF clause inside an INSERT or CREATE TABLE AS SELECT statement.
- If a possible 3-second error (maximum) is important to Oracle Flashback Query in your application, use an SCN instead of a time stamp. See [General Guidelines for Oracle Flashback Technology](#) (page 19-27).
- You can create a view that refers to past data by using the AS OF clause in the SELECT statement that defines the view.

If you specify a relative time by subtracting from the current time on the database host, the past time is recalculated for each query. For example:

```
CREATE VIEW hour_ago AS
  SELECT * FROM employees
  AS OF TIMESTAMP (SYSTIMESTAMP - INTERVAL '60' MINUTE);
```

SYSTIMESTAMP refers to the time zone of the database host environment.

- You can use the AS OF clause in self-joins, or in set operations such as INTERSECT and MINUS, to extract or compare data from two different times.

You can store the results by preceding Oracle Flashback Query with a CREATE TABLE AS SELECT or INSERT INTO TABLE SELECT statement. For example, this query reinserts into table employees the rows that existed an hour ago:

```
INSERT INTO employees
  (SELECT * FROM employees
   AS OF TIMESTAMP (SYSTIMESTAMP - INTERVAL '60' MINUTE)
  MINUS SELECT * FROM employees;
```

SYSTIMESTAMP refers to the time zone of the database host environment.

- You can use the AS OF clause in queries to check for data that was valid at a particular time. See [Temporal Validity Support](#) (page 1-11).

19.4 Using Oracle Flashback Version Query

Use Oracle Flashback Version Query to retrieve the different versions of specific rows that existed during a given time interval. A row version is created whenever a COMMIT statement is executed.

Note:

After executing a CREATE TABLE statement, wait at least 15 seconds to commit any transactions, to ensure that Oracle Flashback Version Query reflects those transactions.

Specify Oracle Flashback Version Query using the VERSIONS BETWEEN clause of the SELECT statement. The syntax is either:

```
VERSIONS BETWEEN { SCN | TIMESTAMP } start AND end
```

where *start* and *end* are expressions representing the start and end, respectively, of the time interval to be queried. The time interval includes (*start* and *end*).

or:

```
VERSIONS PERIOD FOR user_valid_time [ BETWEEN TIMESTAMP start AND end ]
```

where *user_valid_time* refers to the user-specified valid time period, as explained in [Temporal Validity Support](#) (page 1-11).

Oracle Flashback Version Query returns a table with a row for each version of the row that existed at any time during the specified time interval. Each row in the table includes pseudocolumns of metadata about the row version, which can reveal when and how a particular change (perhaps erroneous) occurred to your database.

[Table 19-1](#) (page 19-10) describes the pseudocolumns of metadata about the row version. The VERSIONS_* pseudocolumns have values only for transaction-time Flashback Version Queries (that is, queries with the clause BETWEEN TIMESTAMP *start* AND *end*).

Table 19-1 Oracle Flashback Version Query Row Data Pseudocolumns

Pseudocolumn Name	Description
VERSIONS_STARTSCN	Starting System Change Number (SCN) or <code>TIMESTAMP</code> when the row version was created. This pseudocolumn identifies the time when the data first had the values reflected in the row version. Use this pseudocolumn to identify the past target time for Oracle Flashback Table or Oracle Flashback Query.
VERSIONS_STARTTIME	If this pseudocolumn is <code>NULL</code> , then the row version was created before <i>start</i> .
VERSIONS_ENDSCN	SCN or <code>TIMESTAMP</code> when the row version expired.
VERSIONS_ENDTIME	If this pseudocolumn is <code>NULL</code> , then either the row version was current at the time of the query or the row corresponds to a <code>DELETE</code> operation.
VERSIONS_XID	Identifier of the transaction that created the row version.
VERSIONS_OPERATION	Operation performed by the transaction: <code>I</code> for insertion, <code>D</code> for deletion, or <code>U</code> for update. The version is that of the row that was inserted, deleted, or updated; that is, the row after an <code>INSERT</code> operation, the row before a <code>DELETE</code> operation, or the row affected by an <code>UPDATE</code> operation. For user updates of an index key, Oracle Flashback Version Query might treat an <code>UPDATE</code> operation as two operations, <code>DELETE</code> plus <code>INSERT</code> , represented as two version rows with a <code>D</code> followed by an <code>I</code> <code>VERSIONS_OPERATION</code> .

A given row version is valid starting at its time `VERSIONS_START*` up to, but not including, its time `VERSIONS_END*`. That is, it is valid for any time t such that $VERSIONS_START* \leq t < VERSIONS_END*$. For example, this output indicates that the salary was 10243 from September 9, 2002, included, to November 25, 2003, excluded.

VERSIONS_START_TIME	VERSIONS_END_TIME	SALARY
-----	-----	-----
09-SEP-2003	25-NOV-2003	10243

Here is a typical use of Oracle Flashback Version Query:

```
SELECT versions_startscn, versions_starttime,
       versions_endscn, versions_endtime,
       versions_xid, versions_operation,
       last_name, salary
FROM employees
VERSIONS BETWEEN TIMESTAMP
   TO_TIMESTAMP('2008-12-18 14:00:00', 'YYYY-MM-DD HH24:MI:SS')
 AND TO_TIMESTAMP('2008-12-18 17:00:00', 'YYYY-MM-DD HH24:MI:SS')
WHERE first_name = 'John';
```

You can use `VERSIONS_XID` with Oracle Flashback Transaction Query to locate this transaction's metadata, including the SQL required to undo the row change and the user responsible for the change—see [Using Oracle Flashback Transaction Query](#) (page 19-11).

Flashback Version Query allows index-only access only with IOTs (index-organized tables), but index fast full scan is not allowed.

See Also:

Oracle Database SQL Language Reference for information about Oracle Flashback Version Query pseudocolumns and the syntax of the `VERSIONS` clause

19.5 Using Oracle Flashback Transaction Query

Use Oracle Flashback Transaction Query to retrieve metadata and historical data for a given transaction or for all transactions in a given time interval. Oracle Flashback Transaction Query queries the static data dictionary view `FLASHBACK_TRANSACTION_QUERY`, whose columns are described in *Oracle Database Reference*.

The column `UNDO_SQL` shows the SQL code that is the logical opposite of the DML operation performed by the transaction. You can usually use this code to reverse the logical steps taken during the transaction. However, there are cases where the `UNDO_SQL` code is not the exact opposite of the original transaction. For example, a `UNDO_SQL INSERT` operation might not insert a row back in a table at the same `ROWID` from which it was deleted.

This statement queries the `FLASHBACK_TRANSACTION_QUERY` view for transaction information, including the transaction ID, the operation, the operation start and end SCNs, the user responsible for the operation, and the SQL code that shows the logical opposite of the operation:

```
SELECT xid, operation, start_scn, commit_scn, logon_user, undo_sql
FROM flashback_transaction_query
WHERE xid = HEXTORAW('000200030000002D');
```

This statement uses Oracle Flashback Version Query as a subquery to associate each row version with the `LOGON_USER` responsible for the row data change:

```
SELECT xid, logon_user
FROM flashback_transaction_query
WHERE xid IN (
    SELECT versions_xid FROM employees VERSIONS BETWEEN TIMESTAMP
    TO_TIMESTAMP('2003-07-18 14:00:00', 'YYYY-MM-DD HH24:MI:SS') AND
    TO_TIMESTAMP('2003-07-18 17:00:00', 'YYYY-MM-DD HH24:MI:SS')
);
```

Note:

If you query `FLASHBACK_TRANSACTION_QUERY` without specifying `XID` in the `WHERE` clause, the query scans many unrelated rows, degrading performance.

See Also:

- *Oracle Database Backup and Recovery User's Guide*. for information about how a database administrator can use Flashback Table to restore an entire table, rather than individual rows
 - *Oracle Database Administrator's Guide* for information about how a database administrator can use Flashback Table to restore an entire table, rather than individual rows
-

19.6 Using Oracle Flashback Transaction Query with Oracle Flashback Version Query

In this example, a database administrator does this:

```
DROP TABLE emp;
CREATE TABLE emp (
  empno  NUMBER PRIMARY KEY,
  empname VARCHAR2(16),
  salary NUMBER
);
INSERT INTO emp (empno, empname, salary) VALUES (111, 'Mike', 555);
COMMIT;

DROP TABLE dept;
CREATE TABLE dept (
  deptno  NUMBER,
  deptname VARCHAR2(32)
);
INSERT INTO dept (deptno, deptname) VALUES (10, 'Accounting');
COMMIT;
```

Now `emp` and `dept` have one row each. In terms of row versions, each table has one version of one row. Suppose that an erroneous transaction deletes `empno 111` from table `emp`:

```
UPDATE emp SET salary = salary + 100 WHERE empno = 111;
INSERT INTO dept (deptno, deptname) VALUES (20, 'Finance');
DELETE FROM emp WHERE empno = 111;
COMMIT;
```

Next, a transaction reinserts `empno 111` into the `emp` table with a new employee name:

```
INSERT INTO emp (empno, empname, salary) VALUES (111, 'Tom', 777);
UPDATE emp SET salary = salary + 100 WHERE empno = 111;
UPDATE emp SET salary = salary + 50 WHERE empno = 111;
COMMIT;
```

The database administrator detects the application error and must diagnose the problem. The database administrator issues this query to retrieve versions of the rows in the `emp` table that correspond to `empno 111`. The query uses Oracle Flashback Version Query pseudocolumns:

```
SELECT versions_xid XID, versions_startscn START_SCN,
       versions_endscn END_SCN, versions_operation OPERATION,
       empname, salary
FROM emp
```

```
VERSIONS BETWEEN SCN MINVALUE AND MAXVALUE
WHERE empno = 111;
```

Results are similar to:

XID	START_SCN	END_SCN	O	EMPNAME	SALARY
09001100B2200000	10093466			I Tom	927
030002002B210000	10093459			D Mike	555
0800120096200000	10093375	10093459	I	Mike	555

3 rows selected.

The results table rows are in descending chronological order. The third row corresponds to the version of the row in the table `emp` that was inserted in the table when the table was created. The second row corresponds to the row in `emp` that the erroneous transaction deleted. The first row corresponds to the version of the row in `emp` that was reinserted with a new employee name.

The database administrator identifies transaction 030002002B210000 as the erroneous transaction and uses Oracle Flashback Transaction Query to audit all changes made by this transaction:

```
SELECT xid, start_scn, commit_scn, operation, logon_user, undo_sql
FROM flashback_transaction_query
WHERE xid = HEXTORAW('000200030000002D');
```

Results are similar to:

XID	START_SCN	COMMIT_SCN	OPERATION	LOGON_USER	UNDO_SQL
030002002B210000	10093452	10093459	DELETE	HR	insert into "HR"."EMP"("EMPNO", "EMPNAME", "SALARY") values ('111', 'Mike', '655');
030002002B210000	10093452	10093459	INSERT	HR	delete from "HR"."DEPT" where ROWID = 'AAATjuAAEAAAAJrAAB';
030002002B210000	10093452	10093459	UPDATE	HR	update "HR"."EMP" set "SALARY" = '555' where ROWID = 'AAATjsAAEAAAAJ7AAA';
030002002B210000	10093452	10093459	BEGIN	HR	

4 rows selected.

To make the result of the next query easier to read, the database administrator uses these SQL*Plus commands:

```
COLUMN operation FORMAT A9
COLUMN table_name FORMAT A10
COLUMN table_owner FORMAT A11
```

To see the details of the erroneous transaction and all subsequent transactions, the database administrator performs this query:

```
SELECT xid, start_scn, commit_scn, operation, table_name, table_owner
FROM flashback_transaction_query
WHERE table_owner = 'HR'
```

```
AND start_timestamp >=
  TO_TIMESTAMP ('2002-04-16 11:00:00', 'YYYY-MM-DD HH:MI:SS');
```

Results are similar to:

XID	START_SCN	COMMIT_SCN	OPERATION	TABLE_NAME	TABLE_OWNER
02000E0074200000	10093435	10093446	INSERT	DEPT	HR
030002002B210000	10093452	10093459	DELETE	EMP	HR
030002002B210000	10093452	10093459	INSERT	DEPT	HR
030002002B210000	10093452	10093459	UPDATE	EMP	HR
0800120096200000	10093374	10093375	INSERT	EMP	HR
09001100B2200000	10093462	10093466	UPDATE	EMP	HR
09001100B2200000	10093462	10093466	UPDATE	EMP	HR
09001100B2200000	10093462	10093466	INSERT	EMP	HR

8 rows selected.

Note:

Because the preceding query does not specify the XID in the WHERE clause, it scans many unrelated rows, degrading performance.

19.7 Using DBMS_FLASHBACK Package

The DBMS_FLASHBACK package provides the same functionality as Oracle Flashback Query, but Oracle Flashback Query is sometimes more convenient.

The DBMS_FLASHBACK package acts as a time machine: you can turn back the clock, perform normal queries as if you were at that earlier time, and then return to the present. Because you can use the DBMS_FLASHBACK package to perform queries on past data without special clauses such as AS OF or VERSIONS BETWEEN, you can reuse existing PL/SQL code to query the database at earlier times.

You must have the EXECUTE privilege on the DBMS_FLASHBACK package.

To use the DBMS_FLASHBACK package in your PL/SQL code:

1. Specify a past time by invoking either DBMS_FLASHBACK.ENABLE_AT_TIME or DBMS_FLASHBACK.ENABLE_AT_SYSTEM_CHANGE_NUMBER.
2. Perform regular queries (that is, queries without special flashback-feature syntax such as AS OF). Do not perform DDL or DML operations.

The database is queried at the specified past time.

3. Return to the present by invoking DBMS_FLASHBACK.DISABLE.

You must invoke DBMS_FLASHBACK.DISABLE before invoking DBMS_FLASHBACK.ENABLE_AT_TIME or DBMS_FLASHBACK.ENABLE_AT_SYSTEM_CHANGE_NUMBER again. You cannot nest enable/disable pairs.

To use a cursor to store the results of queries, open the cursor before invoking DBMS_FLASHBACK.DISABLE. After storing the results and invoking DBMS_FLASHBACK.DISABLE, you can:

- Perform INSERT or UPDATE operations to modify the current database state by using the stored results from the past.

- Compare current data with the past data. After invoking `DBMS_FLASHBACK.DISABLE`, open a second cursor. Fetch from the first cursor to retrieve past data; fetch from the second cursor to retrieve current data. You can store the past data in a temporary table and then use set operators such as `MINUS` or `UNION` to contrast or combine the past and current data.

You can invoke `DBMS_FLASHBACK.GET_SYSTEM_CHANGE_NUMBER` at any time to get the current System Change Number (SCN).

`DBMS_FLASHBACK.GET_SYSTEM_CHANGE_NUMBER` returns the current SCN regardless of previous invocations of `DBMS_FLASHBACK.ENABLE`.

See Also:

- *Oracle Database PL/SQL Packages and Types Reference* for details of the `DBMS_FLASHBACK` package
-
-

19.8 Using Flashback Transaction

The `DBMS_FLASHBACK.TRANSACTION_BACKOUT` procedure rolls back a transaction and its dependent transactions while the database remains online. This recovery operation uses undo data to create and run the **compensating transactions** that return the affected data to its original state.

The transactions being rolled back are subject to these restrictions:

- They cannot have performed DDL operations that changed the logical structure of database tables.
- They cannot use Large Object (LOB) Data Types:
 - `BFILE`
 - `BLOB`
 - `CLOB`
 - `NCLOB`
- They cannot use features that LogMiner does not support.

The features that LogMiner supports depends on the value of the `COMPATIBLE` initialization parameter for the database that is rolling back the transaction. The default value is the release number of the most recent major release.

Flashback Transaction inherits SQL data type support from LogMiner. Therefore, if LogMiner fails due to an unsupported SQL data type in a the transaction, Flashback Transaction fails too.

Some data types, though supported by LogMiner, do not generate undo information as part of operations that modify columns of such types. Therefore, Flashback Transaction does not support tables containing these data types. These include tables with `BLOB`, `CLOB` and `XML` type.

See Also:

- *Oracle Data Guard Concepts and Administration* for information about data type and DDL support on a logical standby database
 - *Oracle Database SQL Language Reference* for information about LOB data types
 - *Oracle Database Utilities* for information about LogMiner
 - *Oracle Database Administrator's Guide* for information about the COMPATIBLE initialization parameter
-

Topics:

- [Dependent Transactions](#) (page 19-16)
- [TRANSACTION_BACKOUT Parameters](#) (page 19-16)
- [TRANSACTION_BACKOUT Reports](#) (page 19-17)

19.8.1 Dependent Transactions

In the context of Flashback Transaction, transaction 2 can depend on transaction 1 in any of these ways:

- **Write-after-write dependency**
Transaction 1 changes a row of a table, and later transaction 2 changes the same row.
- **Primary key dependency**
A table has a primary key constraint on column c. In a row of the table, column c has the value v. Transaction 1 deletes that row, and later transaction 2 inserts a row into the same table, assigning the value v to column c.
- **Foreign key dependency**
In table b, column b1 has a foreign key constraint on column a1 of table a. Transaction 1 changes a value in a1, and later transaction 2 changes a value in b1.

19.8.2 TRANSACTION_BACKOUT Parameters

The parameters of the TRANSACTION_BACKOUT procedure are:

- Number of transactions to be backed out
- List of transactions to be backed out, identified either by name or by XID
- Time hint, if you identify transactions by name
Specify a time that is earlier than any transaction started.
- Backout option from [Table 19-2](#) (page 19-17)

For the syntax of the TRANSACTION_BACKOUT procedure and detailed parameter descriptions, see *Oracle Database PL/SQL Packages and Types Reference*.

Table 19-2 Flashback TRANSACTION_BACKOUT Options

Option	Description
CASCADE	Backs out specified transactions and all dependent transactions in a post-order fashion (that is, children are backed out before parents are backed out). Without CASCADE, if any dependent transaction is not specified, an error occurs.
NOCASCADE	Default. Backs out specified transactions, which are expected to have no dependent transactions. First dependent transactions causes an error and appears in *_FLASHBACK_TXN_REPORT.
NOCASCADE_FORCE	Backs out specified transactions, ignoring dependent transactions. Server runs undo SQL statements for specified transactions in reverse order of commit times. If no constraints break and you are satisfied with the result, you can commit the changes; otherwise, you can roll them back.
NONCONFLICT_ONLY	Backs out changes to nonconflicting rows of the specified transactions. Database remains consistent, but transaction atomicity is lost.

TRANSACTION_BACKOUT analyzes the transactional dependencies, performs DML operations, and generates reports. TRANSACTION_BACKOUT does not commit the DML operations that it performs as part of transaction backout, but it holds all the required locks on rows and tables in the right form, preventing other dependencies from entering the system. To make the transaction backout permanent, you must explicitly commit the transaction.

19.8.3 TRANSACTION_BACKOUT Reports

To see the reports that TRANSACTION_BACKOUT generates, query the static data dictionary views *_FLASHBACK_TXN_STATE and *_FLASHBACK_TXN_REPORT.

19.8.3.1 *_FLASHBACK_TXN_STATE

The static data dictionary view *_FLASHBACK_TXN_STATE shows whether a transaction is active or backed out. If a transaction appears in this view, it is backed out.

*_FLASHBACK_TXN_STATE is maintained atomically for compensating transactions. If a compensating transaction is backed out, all changes that it made are also backed out, and *_FLASHBACK_TXN_STATE reflects this. For example, if compensating transaction ct backs out transactions t1 and t2, then t1 and t2 appear in *_FLASHBACK_TXN_STATE. If ct itself is later backed out, the effects of t1 and t2 are reinstated, and t1 and t2 disappear from *_FLASHBACK_TXN_STATE.

See Also:

Oracle Database Reference for more information about
*_FLASHBACK_TXN_STATE

19.8.3.2 * _FLASHBACK_TXN_REPORT

The static data dictionary view *_FLASHBACK_TXN_REPORT provides a detailed report for each backed-out transaction.

See Also:

Oracle Database Reference for more information about
*_FLASHBACK_TXN_REPORT

19.9 Using Flashback Data Archive

A Flashback Data Archive provides the ability to track and store transactional changes to a table over its lifetime. A Flashback Data Archive is useful for compliance with record stage policies and audit reports.

A Flashback Data Archive consists of one or more tablespaces or parts thereof. You can have multiple Flashback Data Archives. If you are logged on as SYSDBA, you can specify a default Flashback Data Archive for the system. A Flashback Data Archive is configured with retention time. Data archived in the Flashback Data Archive is retained for the retention time specified when the Flashback Data Archive was created.

By default, Flashback Data Archive is not enabled for any tables. You can enable Flashback Data Archive for a table if all of these conditions are true:

- You have the FLASHBACK ARCHIVE object privilege on the Flashback Data Archive to use for that table.
- The table is not nested, temporary, remote, or external.
- The table contains neither LONG nor nested columns.
- The table does not use any of these Flashback Data Archive reserved words as column names:

- STARTSCN
- ENDSCN
- RID
- XID
- OP
- OPERATION

You cannot enable Flashback Data Archive on a nested table, temporary table, external table, materialized view, Advanced Query (AQ) table, or non-table object.

After Flashback Data Archive is enabled for a table, you can disable it only if you either have the FLASHBACK ARCHIVE ADMINISTER system privilege or you are logged on as SYSDBA.

When choosing a Flashback Data Archive for a specific table, consider the data retention requirements for the table and the retention times of the Flashback Data Archives on which you have the FLASHBACK ARCHIVE object privilege.

Effective with Oracle Database 12c Release 1 (12.1.0.1), Flashback Data Archive is enhanced to include the following:

- **User context tracking.** The metadata information for tracking transactions can include (if the feature is enabled) the user context, which makes it easier to determine which user made which changes to a table.

To set the user context level (determining how much user context is to be saved), use the `DBMS_FLASHBACK_ARCHIVE.SET_CONTEXT_LEVEL` procedure. To access the context information, use the `DBMS_FLASHBACK_ARCHIVE.GET_SYS_CONTEXT` function. (The `DBMS_FLASHBACK_ARCHIVE` package is described in *Oracle Database PL/SQL Packages and Types Reference*.)

- **Database hardening.** This feature enables you to associate a set of tables together in an "application", and then enable Flashback Data Archive on all those tables with a single command. Also, database hardening enables you to lock all the tables with a single command, preventing any DML on those tables until they are subsequently unlocked. Database hardening is designed to make it easier to use Flashback Data Archive to track and protect the security-sensitive tables for an application.

To register an application for database hardening, use the `DBMS_FLASHBACK_ARCHIVE.REGISTER_APPLICATION` procedure, which is described in *Oracle Database PL/SQL Packages and Types Reference*.

Topics:

- [Creating a Flashback Data Archive](#) (page 19-19)
- [Altering a Flashback Data Archive](#) (page 19-20)
- [Dropping a Flashback Data Archive](#) (page 19-21)
- [Specifying the Default Flashback Data Archive](#) (page 19-21)
- [Enabling and Disabling Flashback Data Archive](#) (page 19-22)
- [DDL Statements on Tables Enabled for Flashback Data Archive](#) (page 19-23)
- [Viewing Flashback Data Archive Data](#) (page 19-24)
- [Flashback Data Archive Scenarios](#) (page 19-25)

19.9.1 Creating a Flashback Data Archive

Create a Flashback Data Archive with the `CREATE FLASHBACK ARCHIVE` statement, specifying:

- Name of the Flashback Data Archive
- Name of the first tablespace of the Flashback Data Archive
- (Optional) Maximum amount of space that the Flashback Data Archive can use in the first tablespace

The default is unlimited. Unless your space quota on the first tablespace is also unlimited, you must specify this value; otherwise, error ORA-55621 occurs.

- Retention time (number of days that Flashback Data Archive data for the table is guaranteed to be stored)
- (Optional) Whether to optimize the storage of data in the history tables maintained in the Flashback Data Archive, using `[NO] OPTIMIZE DATA`.

The default is `NO OPTIMIZE DATA`.

If you are logged on as `SYSDBA`, you can also specify that this is the default Flashback Data Archive for the system. If you omit this option, you can still make this Flashback Data Archive the default later (see [Specifying the Default Flashback Data Archive](#) (page 19-21)).

Oracle recommends that all users who must use Flashback Data Archive have unlimited quota on the Flashback Data Archive tablespace; however, if this is not the case, you must grant sufficient quota on that tablespace to those users.

Examples

- Create a default Flashback Data Archive named `fla1` that uses up to 10 G of tablespace `tbs1`, whose data are retained for one year:

```
CREATE FLASHBACK ARCHIVE DEFAULT fla1 TABLESPACE tbs1
  QUOTA 10G RETENTION 1 YEAR;
```
- Create a Flashback Data Archive named `fla2` that uses tablespace `tbs2`, whose data are retained for two years:

```
CREATE FLASHBACK ARCHIVE fla2 TABLESPACE tbs2 RETENTION 2 YEAR;
```

For more information about the `CREATE FLASHBACK ARCHIVE` statement, see *Oracle Database SQL Language Reference*.

19.9.2 Altering a Flashback Data Archive

With the `ALTER FLASHBACK ARCHIVE` statement, you can:

- Change the retention time of a Flashback Data Archive
- Purge some or all of its data
- Add, modify, and remove tablespaces

Note:

Removing all tablespaces of a Flashback Data Archive causes an error.

If you are logged on as `SYSDBA`, you can also use the `ALTER FLASHBACK ARCHIVE` statement to make a specific file the default Flashback Data Archive for the system.

Examples

- Make Flashback Data Archive `fla1` the default Flashback Data Archive:

```
ALTER FLASHBACK ARCHIVE fla1 SET DEFAULT;
```
- To Flashback Data Archive `fla1`, add up to 5 G of tablespace `tbs3`:

```
ALTER FLASHBACK ARCHIVE fla1 ADD TABLESPACE tbs3 QUOTA 5G;
```

- To Flashback Data Archive `fla1`, add as much of tablespace `tbs4` as needed:

```
ALTER FLASHBACK ARCHIVE fla1 ADD TABLESPACE tbs4;
```
- Change the maximum space that Flashback Data Archive `fla1` can use in tablespace `tbs3` to 20 G:

```
ALTER FLASHBACK ARCHIVE fla1 MODIFY TABLESPACE tbs3 QUOTA 20G;
```
- Allow Flashback Data Archive `fla1` to use as much of tablespace `tbs1` as needed:

```
ALTER FLASHBACK ARCHIVE fla1 MODIFY TABLESPACE tbs1;
```
- Change the retention time for Flashback Data Archive `fla1` to two years:

```
ALTER FLASHBACK ARCHIVE fla1 MODIFY RETENTION 2 YEAR;
```
- Remove tablespace `tbs2` from Flashback Data Archive `fla1`:

```
ALTER FLASHBACK ARCHIVE fla1 REMOVE TABLESPACE tbs2;
```

 (Tablespace `tbs2` is not dropped.)
- Purge all historical data from Flashback Data Archive `fla1`:

```
ALTER FLASHBACK ARCHIVE fla1 PURGE ALL;
```
- Purge all historical data older than one day from Flashback Data Archive `fla1`:

```
ALTER FLASHBACK ARCHIVE fla1
  PURGE BEFORE TIMESTAMP (SYSTIMESTAMP - INTERVAL '1' DAY);
```
- Purge all historical data older than SCN 728969 from Flashback Data Archive `fla1`:

```
ALTER FLASHBACK ARCHIVE fla1 PURGE BEFORE SCN 728969;
```

For more information about the `ALTER FLASHBACK ARCHIVE` statement, see *Oracle Database SQL Language Reference*.

19.9.3 Dropping a Flashback Data Archive

Drop a Flashback Data Archive with the `DROP FLASHBACK ARCHIVE` statement. Dropping a Flashback Data Archive deletes its historical data, but does not drop its tablespaces.

Example

Remove Flashback Data Archive `fla1` and all its historical data, but not its tablespaces:

```
DROP FLASHBACK ARCHIVE fla1;
```

For more information about the `DROP FLASHBACK ARCHIVE` statement, see *Oracle Database SQL Language Reference*.

19.9.4 Specifying the Default Flashback Data Archive

By default, the system has no default Flashback Data Archive. If you are logged on as `SYSDBA`, you can specify default Flashback Data Archive in either of these ways:

- Specify the name of an existing Flashback Data Archive in the SET DEFAULT clause of the ALTER FLASHBACK ARCHIVE statement. For example:

```
ALTER FLASHBACK ARCHIVE fla1 SET DEFAULT;
```

If fla1 does not exist, an error occurs.

- Include DEFAULT in the CREATE FLASHBACK ARCHIVE statement when you create a Flashback Data Archive. For example:

```
CREATE FLASHBACK ARCHIVE DEFAULT fla2 TABLESPACE tbs1  
QUOTA 10G RETENTION 1 YEAR;
```

The default Flashback Data Archive for the system is the default Flashback Data Archive for every user who does not have his or her own default Flashback Data Archive.

See Also:

- *Oracle Database SQL Language Reference* for more information about the CREATE FLASHBACK ARCHIVE statement
 - *Oracle Database SQL Language Reference* for more information about the ALTER DATABASE statement
-
-

19.9.5 Enabling and Disabling Flashback Data Archive

By default, Flashback Data Archive is disabled for any table. You can enable Flashback Data Archive for a table if you have the FLASHBACK ARCHIVE object privilege on the Flashback Data Archive to use for that table.

To enable Flashback Data Archive for a table, include the FLASHBACK ARCHIVE clause in either the CREATE TABLE or ALTER TABLE statement. In the FLASHBACK ARCHIVE clause, you can specify the Flashback Data Archive where the historical data for the table are stored. The default is the default Flashback Data Archive for the system. If you specify a nonexistent Flashback Data Archive, an error occurs.

If you enable Flashback Data Archive for a table, but AUM is disabled, error ORA-55614 occurs when you try to modify the table.

If a table has Flashback Data Archive enabled, and you try to enable it again with a different Flashback Data Archive, an error occurs.

After Flashback Data Archive is enabled for a table, you can disable it only if you either have the FLASHBACK ARCHIVE ADMINISTER system privilege or you are logged on as SYSDBA. To disable Flashback Data Archive for a table, specify NO FLASHBACK ARCHIVE in the ALTER TABLE statement. (It is unnecessary to specify NO FLASHBACK ARCHIVE in the CREATE TABLE statement, because that is the default.)

After enabling Flashback Data Archive on a table, Oracle recommends waiting at least 20 seconds before inserting data into the table, and waiting up to 5 minutes before using Flashback Query on the table.

See Also:

Oracle Database SQL Language Reference for more information about the FLASHBACK ARCHIVE clause of the CREATE TABLE statement, including restrictions on its use

Examples

- Create table `employee` and store the historical data in the default Flashback Data Archive:

```
CREATE TABLE employee (EMPNO NUMBER(4) NOT NULL, ENAME VARCHAR2(10),
    JOB VARCHAR2(9), MGR NUMBER(4)) FLASHBACK ARCHIVE;
```

- Create table `employee` and store the historical data in the Flashback Data Archive `fla1`:

```
CREATE TABLE employee (EMPNO NUMBER(4) NOT NULL, ENAME VARCHAR2(10),
    JOB VARCHAR2(9), MGR NUMBER(4)) FLASHBACK ARCHIVE fla1;
```

- Enable Flashback Data Archive for the table `employee` and store the historical data in the default Flashback Data Archive:

```
ALTER TABLE employee FLASHBACK ARCHIVE;
```

- Enable Flashback Data Archive for the table `employee` and store the historical data in the Flashback Data Archive `fla1`:

```
ALTER TABLE employee FLASHBACK ARCHIVE fla1;
```

- Disable Flashback Data Archive for the table `employee`:

```
ALTER TABLE employee NO FLASHBACK ARCHIVE;
```

19.9.6 DDL Statements on Tables Enabled for Flashback Data Archive

Flashback Data Archive supports only these DDL statements:

- ALTER TABLE statement that does any of the following:
 - Adds, drops, renames, or modifies a column
 - Adds, drops, or renames a constraint
 - Drops or truncates a partition or subpartition operation
- TRUNCATE TABLE statement
- RENAME statement that renames a table

Flashback Data Archive does not support DDL statements that move, split, merge, or coalesce partitions or subpartitions, move tables, or convert LONG columns to LOB columns.

For example, the following DDL statements cause error ORA-55610 when used on a table enabled for Flashback Data Archive:

- ALTER TABLE statement that includes an UPGRADE TABLE clause, with or without an INCLUDING DATA clause

- ALTER TABLE statement that moves or exchanges a partition or subpartition operation
- DROP TABLE statement

If you must use unsupported DDL statements on a table enabled for Flashback Data Archive, use the `DBMS_FLASHBACK_ARCHIVE.DISASSOCIATE_FBA` procedure to disassociate the base table from its Flashback Data Archive. To reassociate the Flashback Data Archive with the base table afterward, use the `DBMS_FLASHBACK_ARCHIVE.REASSOCIATE_FBA` procedure. Also, to drop a table enabled for Flashback Data Archive, you must first disable Flashback Data Archive on the table by using the `ALTER TABLE . . . NO FLASHBACK ARCHIVE` clause.

See Also:

- *Oracle Database SQL Language Reference* for information about the ALTER TABLE statement
 - *Oracle Database SQL Language Reference* for information about the TRUNCATE TABLE statement
 - *Oracle Database SQL Language Reference* for information about the RENAME statement
 - *Oracle Database SQL Language Reference* for information about the DROP TABLE statement
 - *Oracle Database PL/SQL Packages and Types Reference* for information about the `DBMS_FLASHBACK_ARCHIVE` package
-
-

19.9.7 Viewing Flashback Data Archive Data

[Table 19-3](#) (page 19-24) lists and briefly describes the static data dictionary views that you can query for information about Flashback Data Archive files.

Table 19-3 Static Data Dictionary Views for Flashback Data Archive Files

View	Description
<code>*_FLASHBACK_ARCHIVE</code>	Displays information about Flashback Data Archive files.
<code>*_FLASHBACK_ARCHIVE_TS</code>	Displays tablespaces of Flashback Data Archive files.
<code>*_FLASHBACK_ARCHIVE_TABLES</code>	Displays information about tables that are enabled for Data Flashback Archive files.

See Also:

- *Oracle Database Reference* for detailed information about *_FLASHBACK_ARCHIVE
- *Oracle Database Reference* for detailed information about *_FLASHBACK_ARCHIVE_TS
- *Oracle Database Reference* for detailed information about *_FLASHBACK_ARCHIVE_TABLES

19.9.8 Flashback Data Archive Scenarios

- [Scenario: Using Flashback Data Archive to Enforce Digital Shredding](#) (page 19-25)
- [Scenario: Using Flashback Data Archive to Access Historical Data](#) (page 19-25)
- [Scenario: Using Flashback Data Archive to Generate Reports](#) (page 19-26)
- [Scenario: Using Flashback Data Archive for Auditing](#) (page 19-26)
- [Scenario: Using Flashback Data Archive to Recover Data](#) (page 19-26)

19.9.8.1 Scenario: Using Flashback Data Archive to Enforce Digital Shredding

Your company wants to "shred" (delete) historical data changes to the `Taxes` table after ten years. When you create the Flashback Data Archive for `Taxes`, you specify a retention time of ten years:

```
CREATE FLASHBACK ARCHIVE taxes_archive TABLESPACE tbs1 RETENTION 10 YEAR;
```

When history data from transactions on `Taxes` exceeds the age of ten years, it is purged. (The `Taxes` table itself, and history data from transactions less than ten years old, are not purged.)

19.9.8.2 Scenario: Using Flashback Data Archive to Access Historical Data

You want to be able to retrieve the inventory of all items at the beginning of the year from the table `inventory`, and to be able to retrieve the stock price for each symbol in your portfolio at the close of business on any specified day of the year from the table `stock_data`.

Create a default Flashback Data Archive named `fla1` that uses up to 10 G of tablespace `tbs1`, whose data are retained for five years (you must be logged on as `SYSDBA`):

```
CREATE FLASHBACK ARCHIVE DEFAULT fla1 TABLESPACE tbs1
  QUOTA 10G RETENTION 5 YEAR;
```

Enable Flashback Data Archive for the tables `inventory` and `stock_data`, and store the historical data in the default Flashback Data Archive:

```
ALTER TABLE inventory FLASHBACK ARCHIVE;
ALTER TABLE stock_data FLASHBACK ARCHIVE;
```

To retrieve the inventory of all items at the beginning of the year 2007, use this query:

```
SELECT product_number, product_name, count FROM inventory AS OF
TIMESTAMP TO_TIMESTAMP ('2007-01-01 00:00:00', 'YYYY-MM-DD HH24:MI:SS');
```

To retrieve the stock price for each symbol in your portfolio at the close of business on July 23, 2007, use this query:

```
SELECT symbol, stock_price FROM stock_data AS OF
TIMESTAMP TO_TIMESTAMP ('2007-07-23 16:00:00', 'YYYY-MM-DD HH24:MI:SS')
WHERE symbol IN my_portfolio;
```

19.9.8.3 Scenario: Using Flashback Data Archive to Generate Reports

You want users to be able to generate reports from the table `investments`, for data stored in the past five years.

Create a default Flashback Data Archive named `fla2` that uses up to 20 G of tablespace `tbs1`, whose data are retained for five years (you must be logged on as `SYSDBA`):

```
CREATE FLASHBACK ARCHIVE DEFAULT fla2 TABLESPACE tbs1
QUOTA 20G RETENTION 5 YEAR;
```

Enable Flashback Data Archive for the table `investments`, and store the historical data in the default Flashback Data Archive:

```
ALTER TABLE investments FLASHBACK ARCHIVE;
```

Lisa wants a report on the performance of her investments at the close of business on December 31, 2006. She uses this query:

```
SELECT * FROM investments AS OF
TIMESTAMP TO_TIMESTAMP ('2006-12-31 16:00:00', 'YYYY-MM-DD HH24:MI:SS')
WHERE name = 'LISA';
```

19.9.8.4 Scenario: Using Flashback Data Archive for Auditing

A medical insurance company must audit a medical clinic. The medical insurance company has its claims in the table `Billings`, and creates a default Flashback Data Archive named `fla4` that uses up to 100 G of tablespace `tbs1`, whose data are retained for 10 years:

```
CREATE FLASHBACK ARCHIVE DEFAULT fla4 TABLESPACE tbs1
QUOTA 100G RETENTION 10 YEAR;
```

The company enables Flashback Data Archive for the table `Billings`, and stores the historical data in the default Flashback Data Archive:

```
ALTER TABLE Billings FLASHBACK ARCHIVE;
```

On May 1, 2007, clients were charged the wrong amounts for some diagnoses and tests. To see the records as of May 1, 2007, the company uses this query:

```
SELECT date_billed, amount_billed, patient_name, claim_Id,
test_costs, diagnosis FROM Billings AS OF TIMESTAMP
TO_TIMESTAMP('2007-05-01 00:00:00', 'YYYY-MM-DD HH24:MI:SS');
```

19.9.8.5 Scenario: Using Flashback Data Archive to Recover Data

An end user recovers from erroneous transactions that were previously committed in the database. The undo data for the erroneous transactions is no longer available, but because the required historical information is available in the Flashback Data Archive, Flashback Query works seamlessly.

Lisa manages a software development group whose product sales are doing well. On November 3, 2007, she decides to give all her level-three employees who have more than two years of experience a salary increase of 10% and a promotion to level four. Lisa asks her HR representative, Bob, to make the changes.

Using the HR web application, Bob updates the `employee` table to give Lisa's level-three employees a 10% raise and a promotion to level four. Then Bob finishes his work for the day and leaves for home, unaware that he omitted the requirement of two years of experience in his transaction. A few days later, Lisa checks to see if Bob has done the updates and finds that everyone in the group was given a raise! She calls Bob immediately and asks him to correct the error.

At first, Bob thinks he cannot return the `employee` table to its prior state without going to the backups. Then he remembers that the `employee` table has Flashback Data Archive enabled.

First, he verifies that no other transaction modified the `employee` table after his: The commit time stamp from the transaction query corresponds to Bob's transaction, two days ago.

Next, Bob uses these statements to return the `employee` table to the way it was before his erroneous change:

```
DELETE EMPLOYEE WHERE MANAGER = 'LISA JOHNSON';
INSERT INTO EMPLOYEE
  SELECT * FROM EMPLOYEE
  AS OF TIMESTAMP (SYSTIMESTAMP - INTERVAL '2' DAY)
  WHERE MANAGER = 'LISA JOHNSON';
```

Bob then reexecutes the update that Lisa had requested.

19.10 General Guidelines for Oracle Flashback Technology

- Use the `DBMS_FLASHBACK.ENABLE` and `DBMS_FLASHBACK.DISABLE` procedures around SQL code that you do not control, or when you want to use the same past time for several consecutive queries.
- Use Oracle Flashback Query, Oracle Flashback Version Query, or Oracle Flashback Transaction Query for SQL code that you write, for convenience. An Oracle Flashback Query, for example, is flexible enough to do comparisons and store results in a single query.
- To obtain an SCN to use later with a flashback feature, use `DBMS_FLASHBACK.GET_SYSTEM_CHANGE_NUMBER`.
- To compute or retrieve a past time to use in a query, use a function return value as a time stamp or SCN argument. For example, add or subtract an `INTERVAL` value to the value of the `SYSTIMESTAMP` function.
- Use Oracle Flashback Query, Oracle Flashback Version Query, and Oracle Flashback Transaction Query locally or remotely. An example of a remote Oracle Flashback Query is:

```
SELECT * FROM employees@some_remote_host AS OF
  TIMESTAMP (SYSTIMESTAMP - INTERVAL '60' MINUTE);
```
- To ensure database consistency, perform a `COMMIT` or `ROLLBACK` operation before querying past data.

- Remember that all flashback processing uses the current session settings, such as national language and character set, not the settings that were in effect at the time being queried.
- Remember that DDLs that alter the structure of a table (such as drop/modify column, move table, drop partition, truncate table/partition, and add constraint) invalidate any existing undo data for the table. If you try to retrieve data from a time before such a DDL executed, error ORA-01466 occurs. DDL operations that alter the storage attributes of a table (such as PCTFREE, INITRANS, and MAXTRANS) do not invalidate undo data.
- To query past data at a precise time, use an SCN. If you use a time stamp, the actual time queried might be up to 3 seconds earlier than the time you specify. Oracle Database uses SCNs internally and maps them to time stamps at a granularity of 3 seconds.

For example, suppose that the SCN values 1000 and 1005 are mapped to the time stamps 8:41 AM and 8:46 AM, respectively. A query for a time between 8:41:00 and 8:45:59 AM is mapped to SCN 1000; an Oracle Flashback Query for 8:46 AM is mapped to SCN 1005. Therefore, if you specify a time that is slightly after a DDL operation (such as a table creation) Oracle Database might use an SCN that is immediately before the DDL operation, causing error ORA-01466.

- You cannot retrieve past data from a dynamic performance (v\$) view. A query on such a view returns current data.
- You can perform queries on past data in static data dictionary views, such as *_TABLES.
- You can enable optimization of data storage for history tables maintained by Flashback Data Archive by specifying OPTIMIZE DATA when creating or altering a Flashback Data Archive.

OPTIMIZE DATA optimizes the storage of data in history tables by using any of these features:

- Advanced Row Compression
- Advanced LOB Compression
- Advanced LOB Deduplication
- Segment-level compression tiering
- Row-level compression tiering

The default is not to optimize the storage of data in history tables.

Caution:

Importing user-generated history can lead to inaccurate, or unreliable results. This procedure should only be used after consulting with Oracle Support.

19.11 Performance Guidelines for Oracle Flashback Technology

- Use the `DBMS_STATS` package to generate statistics for all tables involved in an Oracle Flashback Query. Keep the statistics current. Oracle Flashback Query uses the cost-based optimizer, which relies on these statistics.
- Minimize the amount of undo data that must be accessed. Use queries to select small sets of past data using indexes, not to scan entire tables. If you must scan a full table, add a parallel hint to the query.

The performance cost in I/O is the cost of paging in data and undo blocks that are not in the buffer cache. The performance cost in CPU use is the cost of applying undo information to affected data blocks. When operating on changes in the recent past, flashback operations are CPU-bound.

Oracle recommends that you have enough buffer cache, so that the versions query for the archiver finds the undo data in the buffer cache. Buffer cache access is significantly faster than disk access.

- If very large transactions (such as affecting more than 1 million rows) are performed on tracked tables, set the large pool size high enough (at least 1 GB) for Parallel Query not to have to allocate new chunks out of the SGA. (For information about setting the large pool size, see the chapter about tuning the shared pool and the large pool in *Oracle Database Performance Tuning Guide*.)
- For Oracle Flashback Version Query, use index structures. Oracle Database keeps undo data for index changes and data changes. Performance of index lookup-based Oracle Flashback Version Query is an order of magnitude faster than the full table scans that are otherwise needed.
- In an Oracle Flashback Transaction Query, the `xid` column is of the type `RAW(8)`. To take advantage of the index built on the `xid` column, use the `HEXTORAW` conversion function: `HEXTORAW(xid)`.
- An Oracle Flashback Query against a materialized view does not take advantage of query rewrite optimization.

19.12 Multitenant Container Database Restrictions for Oracle Flashback Technology

These Oracle Flashback Technology features are unavailable for a multitenant container database (CDB):

- For Oracle Database 12c Release 1 (12.1.0.1), Flashback Data Archive (FDA) is not supported in a CDB.
For Oracle Database 12c Release 1 (12.1.0.2), this restriction is removed.
- Flashback Transaction Query is not supported in a CDB.
- Flashback Transaction Backout is not supported in a CDB.

Choosing a Programming Environment

To choose a programming environment for a development project, read:

- The topics in this chapter and the documents to which they refer.
- The platform-specific documents that explain which compilers and development tools your platforms support.

Sometimes the choice of programming environment is obvious, for example:

- Pro*COBOL does not support ADTs or collection types, while Pro*C/C++ does.

If no programming language provides all the features you need, you can use multiple programming languages, because:

- Every programming language in this chapter can invoke PL/SQL and Java stored subprograms. (Stored subprograms include triggers and ADT methods.)
- PL/SQL, Java, SQL, and Oracle Call Interface (OCI) can invoke external C subprograms.
- External C subprograms can access Oracle Database using SQL, OCI, or Pro*C (but not C++).

For more information about multilanguage programming, see [Developing Applications with Multiple Programming Languages](#) (page 21-1).

Topics:

- [Overview of Application Architecture](#) (page 20-2)
- [Overview of the Program Interface](#) (page 20-3)
- [Overview of PL/SQL](#) (page 20-4)
- [Overview of Oracle Database Java Support](#) (page 20-4)
- [Choosing PL/SQL or Java](#) (page 20-13)
- [Overview of Precompilers](#) (page 20-15)
- [Overview of OCI and OCCI](#) (page 20-19)
- [Comparison of Precompilers and OCI](#) (page 20-22)
- [Overview of Oracle Data Provider for .NET \(ODP.NET\)](#) (page 20-23)
- [Overview of OraOLEDB](#) (page 20-24)

20.1 Overview of Application Architecture

In this topic, **application architecture** refers to the computing environment in which a database application connects to an Oracle Database.

Topics:

- [Client/Server Architecture](#) (page 20-2)
- [Server-Side Programming](#) (page 20-2)
- [Two-Tier and Three-Tier Architecture](#) (page 20-2)

See Also:

Oracle Database Concepts for more information about application architecture

20.1.1 Client/Server Architecture

In a traditional client/server program, your application code runs on a client system; that is, a system other than the database server. Database calls are transmitted from the client system to the database server. Data is transmitted from the client to the server for insert and update operations and returned from the server to the client for query operations. The data is processed on the client system. Client/server programs are typically written by using precompilers, whereas SQL statements are embedded within the code of another language such as C, C++, or COBOL.

See Also:

Oracle Database Concepts for more information about client/server architecture

20.1.2 Server-Side Programming

You can develop application logic that resides entirely inside the database by using triggers that are executed automatically when changes occur in the database or stored subprograms that are invoked explicitly. Off-loading the work from your application lets you reuse code that performs verification and cleanup and control database operations from a variety of clients. For example, by making stored subprograms invocable through a web server, you can construct a web-based user interface that performs the same functions as a client/server application.

See Also:

Oracle Database Concepts for more information about server-side programming

20.1.3 Two-Tier and Three-Tier Architecture

Client/server computing is often referred to as a **two-tier model**: your application communicates directly with the database server. In the **three-tier model**, a separate application server processes the requests. The application server might be a basic web server, or might perform advanced functions like caching and load-balancing. Increasing the processing power of this middle tier lets you lessen the resources

needed by client systems, resulting in a **thin client configuration** in which the client system might need only a web browser or other means of sending requests over the TCP/IP or HTTP protocols.

See Also:

Oracle Database Concepts for more information about multitier architecture

20.2 Overview of the Program Interface

The **program interface** is the software layer between a database application and Oracle Database. The program interface:

- Provides a security barrier, preventing destructive access to the SGA by client user processes
- Acts as a communication mechanism, formatting information requests, passing data, and trapping and returning errors
- Converts and translates data, particularly between different types of computers or to external user program data types

The Oracle code acts as a server, performing database tasks on behalf of an application (a client), such as fetching rows from data blocks. The program interface consists of several parts, provided by both Oracle Database software and operating system-specific software.

See Also:

Oracle Database Concepts for more information about the program interface

Topics:

- [User Interface](#) (page 20-3)
- [Stateful and Stateless User Interfaces](#) (page 20-3)

20.2.1 User Interface

The **user interface** is what your application displays to end users. It depends on the technology behind the application and the needs of the users themselves. Experienced users can enter SQL statements that are passed on to the database. Novice users can be shown a graphical user interface that uses the graphics libraries of the client system (such as Windows or X-Windows). Any traditional user interface can also be provided in a web browser through HTML and Java.

20.2.2 Stateful and Stateless User Interfaces

In traditional client/server applications, the application can keep a record of user actions and use this information over the course of one or more sessions. For example, past choices can be presented in a menu so that they not be entered again. When the application can save information in this way, the application is considered **stateful**.

Web or thin-client applications that are **stateless** are easier to develop. Stateless applications gather all the required information, process it using the database, and

then start over with the next user. This is a popular way to process single-screen requests such as customer registration.

There are many ways to add stateful action to web applications that are stateless by default. For example, an entry form on one web page can pass information to subsequent web pages, enabling you to construct a wizard-like interface that remembers user choices through several different steps. You can use cookies to store small items of information about the client system, and retrieve them when the user returns to a website. You can use servlets to keep a database session open and store variables between requests from the same client.

20.3 Overview of PL/SQL

PL/SQL, the Oracle procedural extension of SQL, is a completely portable, high-performance transaction-processing language. PL/SQL lets you manipulate data with SQL statements; control program flow with conditional selection and loops; declare constants and variables; define subprograms; define types, subtypes, and ADTs and declare variables of those types; and trap runtime errors.

Applications written in any Oracle Database programmatic interface can invoke PL/SQL stored subprograms and send blocks of PL/SQL code to Oracle Database for execution. Third-generation language (3GL) applications can access PL/SQL scalar and composite data types through host variables and implicit data type conversion. A 3GL language is easier than assembler language for a human to understand and includes features such as named variables. Unlike a fourth-generation language (4GL), it is not specific to an application domain.

You can use PL/SQL to develop stored procedures that can be invoked by a web client.

See Also:

- *Oracle Database PL/SQL Language Reference* for information about the advantages, main features, and architecture of PL/SQL
-
-

20.4 Overview of Oracle Database Java Support

This section provides an overview of Oracle Database features that support Java applications. The database includes the core JDK libraries such as `java.lang`, `java.io`, and so on. The database supports client-side Java standards such as JDBC and SQLJ, and provides server-side JDBC driver that enables data-intensive Java code to run within the database.

Topics:

- [Overview of Oracle JVM](#) (page 20-5)
- [Overview of Oracle JDBC](#) (page 20-6)
- [Overview of Oracle SQLJ](#) (page 20-9)
- [Comparison of Oracle JDBC and Oracle SQLJ](#) (page 20-11)
- [Overview of Java Stored Subprograms](#) (page 20-12)
- [Overview of Oracle Database Web Services](#) (page 20-12)

See Also:

- *Oracle Database Java Developer's Guide*
 - *Oracle Database JDBC Developer's Guide*
-

20.4.1 Overview of Oracle JVM

Oracle JVM, the Java Virtual Machine provided with the Oracle Database, is compliant with the J2SE version 1.5.x specification and supports the database session architecture.

Any database session can activate a dedicated JVM. All sessions share the same JVM code and statics; however, private states for any given session are held, and subsequently garbage collected, in an individual session space.

This design provides these benefits:

- Java applications have the same session isolation and data integrity as SQL operations.
- You need not run Java in a separate process for data integrity.
- Oracle JVM is a robust JVM with a small memory footprint.
- The JVM has the same linear Symmetric Multiprocessing (SMP) scalability as the database and can support thousands of concurrent Java sessions.

Oracle JVM works consistently with every platform supported by Oracle Database. Java applications that you develop with Oracle JVM can easily be ported to any supported platform.

Oracle JVM includes a deployment-time native compiler that enables Java code to be compiled once, stored in executable form, shared among users, and invoked more quickly and efficiently.

Security features of the database are also available with Oracle JVM. Java classes must be loaded in a database schema (by using Oracle JDeveloper, a third-party IDE, SQL*Plus, or the `loadjava` utility) before they can be called. Java class calls are secured and controlled through database authentication and authorization, Java 2 security, and invoker's rights (IR) or definer's rights (DR).

Effective with Oracle Database 12c Release 1 (12.1.0.1), Oracle JVM provides complete support for the latest Java Standard Edition. Compatibility with latest Java standards increases application portability and enables direct execution of client-side Java classes in the database.

See Also:

- *Oracle Database Concepts* for additional general information about Oracle JVM
 - *Oracle Database Java Developer's Guide* for information about support for the latest Java Standard Edition
-

20.4.2 Overview of Oracle JDBC

Java Database Connectivity (JDBC) is an Applications Programming Interface (API) that enables Java to send SQL statements to an object-relational database such as Oracle Database.

Oracle Database includes these extensions to the JDBC 1.22 standard:

- Support for Oracle data types
- Performance enhancement by row prefetching
- Performance enhancement by execution batching
- Specification of query column types to save round trips
- Control of `DatabaseMetaData` calls

Oracle Database supports all APIs from the JDBC 2.0 standard, including the core APIs, optional packages, and numerous extensions. Some highlights include datasources, JTA, and distributed transactions.

Oracle Database supports these features from the JDBC 3.0 standard:

- Support for JDK 1.5.
- Toggling between local and global transactions.
- Transaction savepoints.
- Reuse of prepared statements by connection pools.

Note:

JDBC code and SQLJ code interoperate. For more information, see [Comparison of Oracle JDBC and Oracle SQLJ](#) (page 20-11).

Topics:

- [Oracle JDBC Drivers](#) (page 20-6)
- [Sample JDBC 2.0 Program](#) (page 20-8)
- [Sample Pre-2.0 JDBC Program](#) (page 20-8)

See Also:

Oracle Database Concepts for additional general information about Java support in Oracle Database

20.4.2.1 Oracle JDBC Drivers

The JDBC standard defines four types of JDBC drivers:

Type	Description
1	A JDBC-ODBC bridge. Software must be installed on client systems.
2	Native methods (calls C or C++) and Java methods. Software must be installed on the client.
3	Pure Java. The client uses sockets to call middleware on the server.
4	The most pure Java solution. Talks directly to the database by using Java sockets.

JDBC is based on Part 3 of the SQL standard, "Call-Level Interface."

You can use JDBC to do dynamic SQL. In dynamic SQL, the embedded SQL statement to be executed is not known before the application is run and requires input to build the statement.

The drivers that are implemented by Oracle have extensions to the capabilities in the JDBC standard that was defined by Sun Microsystems.

Topics:

- [JDBC Thin Driver](#) (page 20-7)
- [JDBC OCI Driver](#) (page 20-7)
- [JDBC Server-Side Internal Driver](#) (page 20-8)

See Also:

- *Oracle Database Concepts* for additional general information about JDBC drivers
 - *Oracle Database JDBC Developer's Guide* for more information about JDBC
-
-

20.4.2.1.1 JDBC Thin Driver

The JDBC Thin driver is a Type 4 (100% pure Java) driver that uses Java sockets to connect directly to a database server. It has its own implementation of a Two-Task Common (TTC), a lightweight implementation of TCP/IP from Oracle Net. It is written entirely in Java and is therefore platform-independent.

The thin driver does not require Oracle software on the client side. It does need a TCP/IP listener on the server side. Use this driver in Java applets that are downloaded into a web browser or in applications for which you do not want to install Oracle client software. The thin driver is self-contained, but it opens a Java socket, and thus can run only in a browser that supports sockets.

20.4.2.1.2 JDBC OCI Driver

The JDBC OCI driver is a Type 2 JDBC driver. It makes calls to OCI written in C to interact with Oracle Database, thus using native and Java methods.

The OCI driver provides access to more features than the thin driver, such as Transparent Application Fail-Over, advanced security, and advanced LOB manipulation.

The OCI driver provides the highest compatibility between different Oracle Database versions. It also supports all installed Oracle Net adapters, including IPC, named pipes, TCP/IP, and IPX/SPX.

Because it uses native methods (a combination of Java and C) the OCI driver is platform-specific. It requires a client installation of version Oracle8i or later including Oracle Net, OCI libraries, CORE libraries, and all other dependent files. The OCI driver usually runs faster than the thin driver.

The OCI driver is not appropriate for Java applets, because it uses a C library that is platform-specific and cannot be downloaded into a web browser. It is usable in J2EE components running in middle-tier application servers, such as Oracle Application Server. Oracle Application Server provides middleware services and tools that support access between applications and browsers.

20.4.2.1.3 JDBC Server-Side Internal Driver

The JDBC server-side internal driver is a Type 2 driver that runs inside the database server, reducing the number of round trips needed to access large amounts of data. The driver, the Java server VM, the database, the Java native compiler (which speeds execution by as much as 10 times), and the SQL engine all run within the same address space.

This driver provides server-side support for any Java program used in the database. You can also call PL/SQL stored subprograms and triggers.

The server driver fully supports the same features and extensions as the client-side drivers.

20.4.2.2 Sample JDBC 2.0 Program

This example shows the recommended technique for looking up a data source using JNDI in JDBC 2.0:

```
// import the JDBC packages
import java.sql.*;
import javax.sql.*;
import oracle.jdbc.pool.*;
...
InitialContext ictx = new InitialContext();
DataSource ds = (DataSource)ictx.lookup("jdbc/OracleDS");
Connection conn = ds.getConnection();
Statement stmt = conn.createStatement();
ResultSet rs = stmt.executeQuery("SELECT last_name FROM employees");
while ( rs.next() ) {
    out.println( rs.getString("ename") + "<br>");
}
conn.close();
```

20.4.2.3 Sample Pre-2.0 JDBC Program

This source code registers an Oracle JDBC thin driver, connects to the database, creates a Statement object, runs a query, and processes the result set.

The SELECT statement retrieves and lists the contents of the last_name column of the hr.employees table.

```
import java.sql.*;
import java.math.*;
import java.io.*;
import java.awt.*;
```

```

class JdbcTest {
    public static void main (String args []) throws SQLException {
        // Load Oracle driver
        DriverManager.registerDriver (new oracle.jdbc.OracleDriver());

        // Connect to the local database
        Connection conn =
            DriverManager.getConnection ("jdbc:oracle:thin:@myhost:1521:orcl",
                                        "hr", "password");

        // Query the employee names
        Statement stmt = conn.createStatement ();
        ResultSet rset = stmt.executeQuery ("SELECT last_name FROM employees");

        // Print the name out
        while (rset.next ())
            System.out.println (rset.getString (1));
        // Close the result set, statement, and the connection
        rset.close();
        stmt.close();
        conn.close();
    }
}

```

One Oracle Database extension to the JDBC drivers is a form of the `getConnection()` method that uses a `Properties` object. The `Properties` object lets you specify user, password, database information, row prefetching, and execution batching.

To use the OCI driver in this code, replace the `Connection` statement with this code, where `MyHostString` is an entry in the `tnsnames.ora` file:

```

Connection conn = DriverManager.getConnection ("jdbc:oracle:oci8:@MyHostString",
                                             "hr", "password");

```

If you are creating an applet, then the `getConnection()` and `registerDriver()` strings are different.

20.4.3 Overview of Oracle SQLJ

Note:

In this guide, **SQLJ** refers to Oracle SQLJ and its extensions.

SQLJ is an ANSI SQL-1999 standard for embedding SQL statements in Java source code. SQLJ provides a simpler alternative to JDBC for client-side SQL data access from Java.

A SQLJ source file contains Java source with embedded SQL statements. Oracle SQLJ supports dynamic and static SQL. Support for dynamic SQL is an Oracle extension to the SQLJ standard.

The Oracle SQLJ translator performs these tasks:

- Translates SQLJ source to Java code with calls to the SQLJ runtime driver. The SQLJ translator converts the source code to pure Java source code and can check the syntax and semantics of static SQL statements against a database schema and verify the type compatibility of host variables with SQL types.

- Compiles the generated Java code with the Java compiler.
- (Optional) Creates profiles for the target database. SQLJ generates "profile" files with customization specific to Oracle Database.

SQLJ is integrated with JDeveloper. Source-level debugging support for SQLJ is available in JDeveloper.

This is an example of a simple SQLJ executable statement, which returns one value because `employee_id` is unique in the `employee` table:

```
String name;
#sql { SELECT first_name INTO :name FROM employees WHERE employee_id=112 };
System.out.println("Name is " + name + ", employee number = " + employee_id);
```

Each host variable (or qualified name or complex Java host expression) included in a SQL expression is preceded by a colon (:). Other SQLJ statements declare Java types. For example, you can declare an iterator (a construct related to a database cursor) for queries that retrieve many values, as follows:

```
#sql iterator EmpIter (String EmpNam, int EmpNum);
```

See Also:

Oracle Database SQLJ Developer's Guide for more examples and details about Oracle SQLJ syntax

Topics:

- [Benefits of SQLJ](#) (page 20-10)

See Also:

Oracle Database Concepts for additional general information about SQLJ

20.4.3.1 Benefits of SQLJ

Oracle SQLJ extensions to Java enable rapid development and easy maintenance of applications that perform database operations through embedded SQL.

In particular, Oracle SQLJ does this:

- Provides a concise, legible mechanism for database access from static SQL. Most SQL in applications is static. SQLJ provides more concise and less error-prone static SQL constructs than JDBC does.
- Provides an SQL Checker module for verification of syntax and semantics at translate time.
- Provides flexible deployment configurations, which makes it possible to implement SQLJ on the client, or middle tier.
- Supports a software standard. SQLJ is an effort of a group of vendors and is supported by all of them. Applications can access multiple database vendors.
- Provides source code portability. Executables can be used with all of the vendor DBMSs if the code does not rely on vendor-specific features.

- Enforces a uniform programming style for the clients and the servers.
- Integrates the SQLJ translator with **Oracle JDeveloper**, a graphical IDE that provides SQLJ translation, Java compilation, profile customizing, and debugging at the source code level, all in one step.
- Includes Oracle Database type extensions.

20.4.4 Comparison of Oracle JDBC and Oracle SQLJ

JDBC code and SQLJ code interoperate, enabling dynamic SQL statements in JDBC to be used with both static and dynamic SQL statements in SQLJ. A SQLJ iterator class corresponds to the JDBC result set.

Some differences between JDBC and SQLJ are:

- JDBC provides a complete dynamic SQL interface from Java to databases. It gives developers full control over database operations. SQLJ simplifies Java database programming to improve development productivity.
- JDBC provides fine-grained control of the execution of dynamic SQL from Java, whereas SQLJ provides a higher-level binding to SQL operations in a specific database schema.
- SQLJ source code is more concise than equivalent JDBC source code.
- SQLJ uses database connections to type-check static SQL code. JDBC, being a completely dynamic API, does not.
- SQLJ provides strong typing of query outputs and return parameters and provides type-checking on calls. JDBC passes values to and from SQL without compile-time type checking.
- SQLJ programs enable direct embedding of Java bind expressions within SQL statements. JDBC requires a separate get or set statement for each bind variable and specifies the binding by position number.
- SQLJ provides simplified rules for calling SQL stored subprograms.

For example, the following four examples show, on successive lines, how to call a stored procedure or a stored function using either JDBC escape syntax or Oracle JDBC syntax:

```

prepStmt.prepareCall("{call fun(?,?)}");          //stored proc. JDBC esc.
prepStmt.prepareCall("{? = call fun(?,?)}");      //stored func. JDBC esc.
prepStmt.prepareCall("begin fun(:1,:2);end;");    //stored proc. Oracle
prepStmt.prepareCall("begin :1 := fun(:2,:3);end;"); //stored func. Oracle

```

The SQLJ equivalent is:

```

#sql {call fun(param_list) }; //Stored procedure
// Declare x
...
#sql x = {VALUES(fun(param_list)) }; // Stored function
// where VALUES is the SQL construct

```

These benefits are common to SQLJ and JDBC:

- SQLJ source files can contain JDBC calls. SQLJ and JDBC are interoperable.

- Oracle JPublisher generates custom Java classes to be used in your SQLJ or JDBC application for mappings to Oracle Database ADTs and collections.
- PL/SQL and Java stored subprograms can be used interchangeably.

20.4.5 Overview of Java Stored Subprograms

Java stored subprograms enable you to implement programs that run in the database server and are independent of programs that run in the middle tier. Structuring applications in this way reduces complexity and increases reuse, security, performance, and scalability.

For example, you can create a Java stored subprogram that performs operations that require data persistence and a separate program to perform presentation or business logic operations.

Java stored subprograms interface with SQL using an execution model similar to that of PL/SQL.

See Also:

- *Oracle Database Concepts* for additional general information about Java stored subprograms
 - *Oracle Database Java Developer's Guide* for complete information about Java stored subprograms
-
-

20.4.6 Overview of Oracle Database Web Services

Web services represent a distributed computing paradigm for Java application development that is an alternative to earlier Java protocols such as JDBC, and which enable applications to interact through the XML and web protocols. For example, an electronics parts vendor can provide a web-based programmatic interface to its suppliers for inventory management. The vendor can invoke a web service as part of a program and automatically order stock based on the data returned.

The key technologies used in web services are:

- Web Services Description Language (WSDL), which is a standard format for creating an XML document. WSDL describes what a web service can do, where it resides, and how to invoke it. Specifically, it describes the operations and parameters, including parameter types, provided by a web service. Also, a WSDL document describes the location, the transport protocol, and the invocation style for the web service.
- Simple Object Access Protocol (SOAP) messaging, which is an XML-based message protocol used by web services. SOAP does not prescribe a specific transport mechanism such as HTTP, FTP, SMTP, or JMS; however, most web services accept messages that use HTTP or HTTPS.
- Universal Description, Discovery, and Integration (UDDI) business registry, which is a directory that lists web services on the internet. The UDDI registry is often compared to a telephone directory, listing unique identifiers (white pages), business categories (yellow pages), and instructions for binding to a service protocol (green pages).

Web services can use a variety of techniques and protocols. For example:

- Dispatching can occur in a synchronous (typical) or asynchronous manner.
- You can invoke a web service in an RPC-style operation in which arguments are sent and a response returned, or in a message style such as a one-way SOAP document exchange.
- You can use different encoding rules: literal or encoded.

You can invoke a web service statically, when you might know everything about it beforehand, or dynamically, in which case you can discover its operations and transport endpoints while using it.

Oracle Database can function as either a web service provider or as a web service consumer. When used as a provider, the database enables sharing and disconnected access to stored subprograms, data, metadata, and other database resources such as the queuing and messaging systems.

As a web service provider, Oracle Database provides a disconnected and heterogeneous environment that:

- Exposes stored subprograms independently of the language in which the subprograms are written
- Exposes SQL Queries and XQuery

See Also:

Oracle Database Concepts for additional general information about Oracle Database as a web service provider

20.5 Choosing PL/SQL or Java

PL/SQL and Java interoperate in the server. You can run a PL/SQL package from Java or PL/SQL can be invoked from Java, so that either one can be invoked from distributed CORBA and Enterprise Java Beans clients.

[Table 20-1](#) (page 20-13) shows PL/SQL packages and their Java equivalents.

Table 20-1 PL/SQL Packages and Their Java Equivalents

PL/SQL Package	Java Equivalent
DBMS_ALERT	Call package with JDBC.
DBMS_DDL	JDBC has this functionality.
DBMS_JOB	Schedule a job that has a Java stored subprogram.
DBMS_LOCK	Call with JDBC.
DBMS_MAIL	Use JavaMail.
DBMS_OUTPUT	Use subclass <code>oracle.aurora.rdbms.OracleDBMSOutputStream</code> or Java stored subprogram <code>DBMS_JAVA.SET_STREAMS</code> .
DBMS_PIPE	Call with JDBC.
DBMS_SESSION	Use JDBC to run an <code>ALTER SESSION</code> statement.

Table 20-1 (Cont.) PL/SQL Packages and Their Java Equivalents

PL/SQL Package	Java Equivalent
DBMS_SNAPSHOT	Call with JDBC.
DBMS_SQL	Use JDBC.
DBMS_TRANSACTION	Use JDBC to run an ALTER SESSION statement.
DBMS_UTILITY	Call with JDBC.
UTL_FILE	Grant the JAVAUSERPRIV privilege and then use Java I/O entry points.

Topics:

- [Similarities of PL/SQL and Java](#) (page 20-14)
- [PL/SQL Advantages Over Java](#) (page 20-14)
- [Java Advantages Over PL/SQL](#) (page 20-15)

20.5.1 Similarities of PL/SQL and Java

Both PL/SQL and Java provide packages and libraries.

Both PL/SQL and Java have object-oriented features:

- Both have inheritance.
- PL/SQL has **type evolution**, the ability to change methods and attributes of a type while preserving subtypes and table data that use the type.
- Java has polymorphism and component models for developing distributed systems.

20.5.2 PL/SQL Advantages Over Java

As an extension of SQL, PL/SQL supports all SQL data types, data encapsulation, information hiding, overloading, and exception-handling. Therefore:

- SQL data types are easier to use in PL/SQL than in Java.
- SQL operations are faster with PL/SQL than with Java, especially when a large amount of data is involved, when mostly database access is done, or when bulk operations are used.

Some advanced PL/SQL capabilities are unavailable for Java in Oracle9i (for example, autonomous transactions and the dblink facility for remote databases).

Code development is usually faster in PL/SQL than in Java; however, this really depends upon the development tool or development environment you are using.

PL/SQL is preferred when your data logic is SQL intensive. That is, the data processing or data validation requirements of your application are high.

Also, there is a large user base with Oracle-supplied packages and third party libraries that can draw upon for development.

20.5.3 Java Advantages Over PL/SQL

Java is used for open distributed applications, and many Java-based development tools are available throughout the industry. Java has native mechanisms that are unavailable in PL/SQL. For example, Java has built-in security mechanisms, an automatic Garbage Collector, type safety mechanisms, byte-code verifier, and Java 2 security. Also, Java provides built-in rapid development features, such as, built-in automatic bounds checking on arrays, built-in network access classes, and APIs that contain many useful and ready-to-use classes. Java has a vast set of class libraries, tools, and third-party class libraries that can be reused in the database. Java has a richer type system than PL/SQL. Java can use CORBA (which can have many different computer languages in its clients) and Enterprise Java Beans. PL/SQL packages can be invoked from CORBA or Enterprise Java Beans clients. You can run XML tools, the Internet File System, or JavaMail from Java.

If your application must interact with ERP systems, RMI servers, Java/J2EE, and web services, Java is preferred because none of these things can be accomplished with PL/SQL. Java is also preferred if you must develop part of your application in the middle-tier because your business logic is complex or compute intensive with little to moderate direct SQL access, you are implementing a middle-tier-driven presentation logic, your application requires transparent Java persistence, or your application requires container-managed infrastructure services. Thus, when needing to partition your application between the database tier and middle tier, migrate that part of your application as needed to the middle tier and use Java/J2EE.

20.6 Overview of Precompilers

Client/server programs are typically written using **precompilers**, which are programming tools that let you embed SQL statements in high-level programs written in languages such as C, C++, or COBOL. Because the client application hosts the SQL statements, it is called a **host program**, and the language in which it is written is called the **host language**.

A precompiler accepts the host program as input, translates the embedded SQL statements into standard database runtime library calls, and generates a source program that you can compile, link, and run in the usual way.

Topics:

- [Overview of the Pro*C/C++ Precompiler](#) (page 20-15)
- [Overview of the Pro*COBOL Precompiler](#) (page 20-18)

See Also:

Oracle Database Concepts for additional general information about Oracle precompilers

20.6.1 Overview of the Pro*C/C++ Precompiler

For the Pro*C/C++ precompiler, the host language is either C or C++. Some features of the Pro*C/C++ precompiler are:

- You can write multithreaded programs if your platform supports a threads package. Concurrent connections are supported in either single-threaded or multithreaded applications.
- You can improve performance by embedding PL/SQL blocks. These blocks can invoke subprograms in Java or PL/SQL that are written by you or provided in Oracle Database packages.
- Using precompiler options, you can check the syntax and semantics of your SQL or PL/SQL statements during precompilation, and at runtime.
- You can invoke stored PL/SQL and Java subprograms. Modules written in COBOL or in C can be invoked from Pro*C/C++. External C subprograms in shared libraries can be invoked by your program.
- You can conditionally precompile sections of your code so that they can run in different environments.
- You can use arrays, or structures, or arrays of structures as host and indicator variables in your code to improve performance.
- You can deal with errors and warnings so that data integrity is guaranteed. As a programmer, you control how errors are handled.
- Your program can convert between internal data types and C language data types.
- The Oracle Call Interface (OCI) and Oracle C++ Call Interface (OCCI), lower-level C and C++ interfaces, are available for use in your precompiler source.
- Pro*C/C++ supports dynamic SQL, a technique that enables users to input variable values and statement syntax.
- Pro*C/C++ can use special SQL statements to manipulate tables containing user-defined object types. An Object Type Translator (OTT) maps the ADTs and named collection types in your database to structures and headers that you include in your source.
- Three kinds of collection types: associative arrays, nested tables and VARRAY, are supported with a set of SQL statements that give you a high degree of control over data.
- Large Objects are accessed by another set of SQL statements.
- A new ANSI SQL standard for dynamic SQL is supported for new applications, so that you can run SQL statements with a varying number of host variables. An older technique for dynamic SQL is still usable by pre-existing applications.
- Globalization support lets you use multibyte characters and UCS2 Unicode data.
- Using scrollable cursors, you can move backward and forward through a result set. For example, you can fetch the last row of the result set, or jump forward or backward to an absolute or relative position within the result set.
- A **connection pool** is a group of physical connections to a database that can be shared by several named connections. Enabling the connection pool option can help optimize the performance of Pro*C/C++ application. The connection pool option is not enabled by default.

See Also:

*Pro*C/C++ Programmer's Guide* for complete information about the Pro*C/C++ precompiler

[Example 20-1](#) (page 20-17) is a code fragment from a C source program that queries the table `employees` in the schema `hr`.

Example 20-1 Pro*C/C++ Application

```

...
#define UNAME_LEN 10
...
int emp_number;
/* Define a host structure for the output values of a SELECT statement. */
/* No declare section needed if precompiler option MODE=ORACLE */
struct {
    VARCHAR last_name[UNAME_LEN];
    float salary;
    float commission_pct;
} emprec;
/* Define an indicator structure to correspond to the host output structure. */
struct {
    short emp_name_ind;
    short sal_ind;
    short comm_ind;
} emprec_ind;
...
/* Select columns last_name, salary, and commission_pct given the user's input
/* for employee_id. */
EXEC SQL SELECT last_name, salary, commission_pct
INTO :emprec INDICATOR :emprec_ind
FROM employees
WHERE employee_id = :emp_number;
...

```

The embedded `SELECT` statement differs slightly from the interactive (SQL*Plus) `SELECT` statement. Every embedded SQL statement begins with `EXEC SQL`. The colon (`:`) precedes every host (C) variable. The returned values of data and indicators (set when the data value is `NULL` or character columns were truncated) can be stored in structs (such as in the preceding code fragment), in arrays, or in arrays of structs. Multiple result set values are handled very simply in a manner that resembles the case shown, where there is only one result, because of the unique employee number. Use the actual names of columns and tables in embedded SQL.

Either use the default precompiler option values or enter values that give you control over the use of resources, how errors are reported, the formatting of output, and how cursors (which correspond to a particular connection or SQL statement) are managed. Cursors are used when there are multiple result set values.

Enter the options either in a configuration file, on the command line, or inline inside your source code with a special statement that begins with `EXEC ORACLE`. If there are no errors found, you can compile, link, and run the output source file, like any other C program that you write.

Use the precompiler to create server database access from clients that can be on many different platforms. Pro*C/C++ gives you the freedom to design your own user interfaces and to add database access to existing applications.

Before writing your embedded SQL statements, you can test interactive versions of the SQL in SQL*Plus and then make minor changes to start testing your embedded SQL application.

20.6.2 Overview of the Pro*COBOL Precompiler

For the Pro*COBOL precompiler, the host language is COBOL. Some features of the Pro*COBOL precompiler are:

- You can invoke stored PL/SQL or Java subprograms. You can improve performance by embedding PL/SQL blocks. These blocks can invoke PL/SQL subprograms written by you or provided in Oracle Database packages.
- Precompiler options enable you to define how cursors, errors, syntax-checking, file formats, and so on, are handled.
- Using precompiler options, you can check the syntax and semantics of your SQL or PL/SQL statements during precompilation, and at runtime.
- You can conditionally precompile sections of your code so that they can run in different environments.
- Use tables, or group items, or tables of group items as host and indicator variables in your code to improve performance.
- You can program how errors and warnings are handled, so that data integrity is guaranteed.
- Pro*COBOL supports dynamic SQL, a technique that enables users to input variable values and statement syntax.

See Also:

*Pro*COBOL Programmer's Guide* for complete information about the Pro*COBOL precompiler

[Example 20-2](#) (page 20-18) is a code fragment from a COBOL source program that queries the table `employees` in the schema `hr`.

Example 20-2 Pro*COBOL Application

```
...
WORKING-STORAGE SECTION.
*
* DEFINE HOST INPUT AND OUTPUT HOST AND INDICATOR VARIABLES.
* NO DECLARE SECTION NEEDED IF MODE=ORACLE.
*
01 EMP-REC-VARS.
   05 EMP-NAME    PIC X(10) VARYING.
   05 EMP-NUMBER  PIC S9(4) COMP VALUE ZERO.
   05 SALARY      PIC S9(5)V99 COMP-3 VALUE ZERO.
   05 COMMISSION  PIC S9(5)V99 COMP-3 VALUE ZERO.
   05 COMM-IND    PIC S9(4) COMP VALUE ZERO.
...
PROCEDURE DIVISION.
...
EXEC SQL
    SELECT last_name, salary, commission_pct
    INTO :EMP-NAME, :SALARY, :COMMISSION:COMM-IND
```



```

        FROM employees
        WHERE employee_id = :EMP-NUMBER
    END-EXEC.

```

...

The embedded `SELECT` statement is only slightly different from an interactive (SQL*Plus) `SELECT` statement. Every embedded SQL statement begins with `EXEC SQL`. The colon (`:`) precedes every host (COBOL) variable. The SQL statement is terminated by `END-EXEC`. The returned values of data and indicators (set when the data value is `NULL` or character columns were truncated) can be stored in group items (such as in the preceding code fragment), in tables, or in tables of group items. Multiple result set values are handled very simply in a manner that resembles the case shown, where there is only one result, given the unique employee number. Use the actual names of columns and tables in embedded SQL.

Use the default precompiler option values, or enter values that give you control over the use of resources, how errors are reported, the formatting of output, and how cursors are managed (cursors correspond to a particular connection or SQL statement).

Enter the options in a configuration file, on the command line, or inline inside your source code with a special statement that begins with `EXEC ORACLE`. If there are no errors found, you can compile, link, and run the output source file, like any other COBOL program that you write.

Use the precompiler to create server database access from clients that can be on many different platforms. Pro*COBOL gives you the freedom to design your own user interfaces and to add database access to existing COBOL applications.

The embedded SQL statements available conform to an ANSI standard, so that you can access data from many databases in a program, including remote servers networked through Oracle Net.

Before writing your embedded SQL statements, you can test interactive versions of the SQL in SQL*Plus and then make minor changes to start testing your embedded SQL application.

20.7 Overview of OCI and OCCI

The Oracle Call Interface (OCI) and Oracle C++ Call Interface (OCCI) are application programming interfaces (APIs) that enable you to create applications that use native subprogram invocations of a third-generation language to access Oracle Database and control all phases of SQL statement execution. These APIs provide:

- Improved performance and scalability through the efficient use of system memory and network connectivity
- Consistent interfaces for dynamic session and transaction management in a two-tier client/server or multitier environment
- *N*-tiered authentication
- Comprehensive support for application development using Oracle Database objects
- Access to external databases
- Ability to develop applications that service an increasing number of users and requests without additional hardware investments

OCI lets you manipulate data and schemas in a database using a host programming language, such as C. OCCI is an object-oriented interface suitable for use with C++. These APIs provide a library of standard database access and retrieval functions in the form of a dynamic runtime library that can be linked in an application at runtime. You need not embed SQL or PL/SQL within 3GL programs.

See Also:

For more information about OCI and OCCI calls:

- *Oracle Call Interface Programmer's Guide*
 - *Oracle C++ Call Interface Programmer's Guide*
 - *Oracle Database Advanced Queuing User's Guide*
 - *Oracle Database Globalization Support Guide*
 - *Oracle Database Data Cartridge Developer's Guide*
-

Topics:

- [Advantages of OCI and OCCI](#) (page 20-20)
- [OCI and OCCI Functions](#) (page 20-21)
- [Procedural and Nonprocedural Elements of OCI and OCCI Applications](#) (page 20-21)
- [Building an OCI or OCCI Application](#) (page 20-22)

20.7.1 Advantages of OCI and OCCI

OCI and OCCI provide significant advantages over other methods of accessing Oracle Database:

- More fine-grained control over all aspects of the application design.
- High degree of control over program execution.
- Use of familiar 3GL programming techniques and application development tools such as browsers and debuggers.
- Support of dynamic SQL, method 4.
- Availability on the broadest range of platforms of all the Oracle Database programmatic interfaces.
- Dynamic bind and define using callbacks.
- Describe functionality to expose layers of server metadata.
- Asynchronous event notification for registered client applications.
- Enhanced array data manipulation language (DML) capability for arrays.
- Ability to associate a commit request with a statement execution to reduce round trips.

- Optimization for queries using transparent prefetch buffers to reduce round trips.
- Thread safety, so you do not have to implement mutual exclusion (mutex) locks on OCI and OCCI handles.
- The server connection in nonblocking mode means that control returns to the OCI code when a call is still running or cannot complete.

20.7.2 OCI and OCCI Functions

Both OCI and OCCI have four kinds of functions:

Kind of Function	Purpose
Relational	To manage database access and process SQL statements
Navigational	To manipulate objects retrieved from the database
Database mapping and manipulation	To manipulate data attributes of Oracle Database types
External subprogram	To write C callbacks from PL/SQL (OCI only)

20.7.3 Procedural and Nonprocedural Elements of OCI and OCCI Applications

OCI and OCCI enable you to develop applications that combine the nonprocedural data access power of SQL with the procedural capabilities of most programming languages, including C and C++. Procedural and nonprocedural languages have these characteristics:

- In a nonprocedural language program, the set of data to be operated on is specified, but what operations are performed and how the operations are to be carried out is not specified. The nonprocedural nature of SQL makes it an easy language to learn and to use to perform database transactions. It is also the standard language used to access and manipulate data in modern relational and object-relational database systems.
- In a procedural language program, the execution of most statements depends on previous or subsequent statements and on control structures, such as loops or conditional branches, which are unavailable in SQL. The procedural nature of these languages makes them more complex than SQL, but it also makes them very flexible and powerful.

The combination of both nonprocedural and procedural language elements in an OCI or OCCI program provides easy access to Oracle Database in a structured programming environment.

OCI and OCCI support all SQL data definition, data manipulation, query, and transaction control facilities that are available through Oracle Database. For example, an OCI or OCCI program can run a query against Oracle Database. The queries can require the program to supply data to the database using input (bind) variables, as follows:

```
SELECT name FROM employees WHERE empno = :empnumber
```

In the preceding SQL statement, `:empnumber` is a placeholder for a value to be supplied by the application.

Alternatively, you can use PL/SQL, Oracle's procedural extension to SQL. The applications you develop can be more powerful and flexible than applications written in SQL alone. OCI and OCCI also provide facilities for accessing and manipulating objects in Oracle Database.

20.7.4 Building an OCI or OCCI Application

As [Figure 20-1](#) (page 20-22) shows, you compile and link an OCI or OCCI program in the same way that you compile and link a nondatabase application. There is no need for a separate preprocessing or precompilation step.

Figure 20-1 The OCI or OCCI Development Process

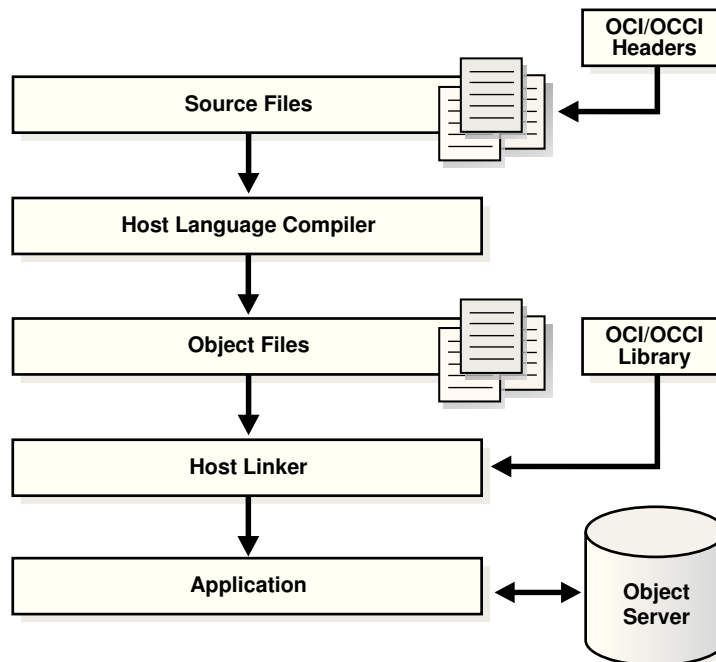

Note:

To properly link your OCI and OCCI programs, it might be necessary on some platforms to include other libraries, in addition to the OCI and OCCI libraries. Check your Oracle platform-specific documentation for further information about extra libraries that might be required.

20.8 Comparison of Precompilers and OCI

Precompiler applications typically contain less code than equivalent OCI applications, which can help productivity.

Some situations require detailed control of the database and are suited for OCI applications (either pure OCI or a precompiler application with embedded OCI calls):

- OCI provides more detailed control over multiplexing and migrating sessions.
- OCI provides dynamic bind and define using callbacks that can be used for any arbitrary structure, including lists.

- OCI has many calls to handle metadata.
- OCI enables asynchronous event notifications to be received by a client application. It provides a means for clients to generate notifications for propagation to other clients.
- OCI enables DML statements to use arrays to complete as many iterations as possible before returning any error messages.
- OCI calls for special purposes include Advanced Queuing, globalization support, Data Cartridges, and support of the date and time data types.
- OCI calls can be embedded in a Pro*C/C++ application.

20.9 Overview of Oracle Data Provider for .NET (ODP.NET)

Oracle Data Provider for .NET (ODP.NET) is an implementation of a data provider for Oracle Database.

ODP.NET uses APIs native to Oracle Database to offer fast and reliable access from any .NET application to database features and data. It also uses and inherits classes and interfaces available in the Microsoft .NET Framework Class Library.

For programmers using Oracle Provider for OLE DB, ADO (ActiveX Data Objects) provides an automation layer that exposes an easy programming model. ADO.NET provides a similar programming model, but without the automation layer, for better performance. More importantly, the ADO.NET model enables native providers such as ODP.NET to expose specific features and data types specific to Oracle Database.

See Also:

Oracle Data Provider for .NET Developer's Guide for Microsoft Windows

This is a simple C# application that connects to Oracle Database and displays its version number before disconnecting:

```
using System;
using Oracle.DataAccess.Client;

class Example
{
    OracleConnection con;

    void Connect()
    {
        con = new OracleConnection();
        con.ConnectionString = "User Id=hr;Password=password;Data Source=oracle";
        con.Open();
        Console.WriteLine("Connected to Oracle" + con.ServerVersion);
    }

    void Close()
    {
        con.Close();
        con.Dispose();
    }

    static void Main()
```

```
{  
  Example example = new Example();  
  example.Connect();  
  example.Close();  
}
```

Note:

Additional samples are provided in directory *ORACLE_BASE\ORACLE_HOME\ODP.NET\Samples*.

20.10 Overview of OraOLEDB

Oracle Provider for OLE DB (OraOLEDB) is an OLE DB data provider that offers high performance and efficient access to Oracle data by OLE DB consumers. In general, this developer's guide assumes that you are using OraOLEDB through OLE DB or ADO.

See Also:

Oracle Provider for OLE DB Developer's Guide for Microsoft Windows

Developing Applications with Multiple Programming Languages

This chapter explains how you can develop database applications that call external procedures written in other programming languages.

Topics:

- [Overview of Multilanguage Programs](#) (page 21-1)
- [What Is an External Procedure?](#) (page 21-3)
- [Overview of Call Specification for External Procedures](#) (page 21-3)
- [Loading External Procedures](#) (page 21-4)
- [Publishing External Procedures](#) (page 21-9)
- [Publishing Java Class Methods](#) (page 21-12)
- [Publishing External C Procedures](#) (page 21-13)
- [Locations of Call Specifications](#) (page 21-13)
- [Passing Parameters to External C Procedures with Call Specifications](#) (page 21-16)
- [Running External Procedures with CALL Statements](#) (page 21-30)
- [Handling Errors and Exceptions in Multilanguage Programs](#) (page 21-33)
- [Using Service Routines with External C Procedures](#) (page 21-34)
- [Doing Callbacks with External C Procedures](#) (page 21-40)

21.1 Overview of Multilanguage Programs

Oracle Database lets you work in different languages:

- PL/SQL, as described in the *Oracle Database PL/SQL Language Reference*
- C, through the Oracle Call Interface (OCI), as described in the *Oracle Call Interface Programmer's Guide*
- C++, through the Oracle C++ Call Interface (OCCI), as described in the *Oracle C++ Call Interface Programmer's Guide*
- C or C++, through the Pro*C/C++ precompiler, as described in the *Pro*C/C++ Programmer's Guide*

- COBOL, through the Pro*COBOL precompiler, as described in the *Pro*COBOL Programmer's Guide*
- Visual Basic, through Oracle Provider for OLE DB, as described in *Oracle Provider for OLE DB Developer's Guide for Microsoft Windows*.
- .NET, through Oracle Data Provider for .NET, as described in *Oracle Data Provider for .NET Developer's Guide for Microsoft Windows*
- Java, through the JDBC and SQLJ client-side application programming interfaces (APIs). See *Oracle Database JDBC Developer's Guide* and *Oracle Database SQLJ Developer's Guide*.
- Java in the database, as described in *Oracle Database Java Developer's Guide*. This includes the use of Java stored procedures (Java methods published to SQL and stored in the database), as described in a chapter in *Oracle Database Java Developer's Guide*.

The JPublisher utility is also available for generating Java classes to represent database entities, such as SQL objects and PL/SQL packages, in a Java client program; publishing from SQL, PL/SQL, and server-side Java to web services; and enabling the invocation of external web services from inside the database. See *Oracle Database JDBC Developer's Guide*.

How can you choose between these different implementation possibilities? Each of these languages offers different advantages: ease of use, the availability of programmers with specific expertise, the need for portability, and the existence of legacy code are powerful determinants.

The choice might narrow depending on how your application must work with Oracle Database:

- PL/SQL is a powerful development tool, specialized for SQL transaction processing.
- Some computation-intensive tasks are executed most efficiently in a lower level language, such as C.
- For both portability and security, you might select Java.
- For familiarity with Microsoft programming languages, you might select .NET.

Most significantly for performance, only PL/SQL and Java methods run within the address space of the server. C/C++ and .NET methods are dispatched as external procedures, and run on the server system but outside the address space of the database server. Pro*COBOL and Pro*C/C++ are precompilers, and Visual Basic accesses Oracle Database through Oracle Provider for OLE DB and subsequently OCI, which is implemented in C.

Taking all these factors into account suggests that there might be situations in which you might need to implement your application in multiple languages. For example, because Java runs within the address space of the server, you might want to import existing Java applications into the database, and then leverage this technology by calling Java functions from PL/SQL and SQL.

PL/SQL external procedures enable you to write C procedure calls as PL/SQL bodies. These C procedures are callable directly from PL/SQL, and from SQL through PL/SQL procedure calls. The database provides a special-purpose interface, the call specification, that lets you call external procedures from other languages. While this service is designed for intercommunication between SQL, PL/SQL, C, and Java, it is

accessible from any base language that can call these languages. For example, your procedure can be written in a language other than Java or C, and if C can call your procedure, then SQL or PL/SQL can use it. Therefore, if you have a candidate C++ procedure, use a C++ `extern "C"` statement in that procedure to make it callable by C.

Therefore, the strengths and capabilities of different languages are available to you, regardless of your programmatic environment. You are not restricted to one language with its inherent limitations. External procedures promote reusability and modularity because you can deploy specific languages for specific purposes.

21.2 What Is an External Procedure?

An **external procedure** is a procedure stored in a dynamic link library (DLL). You register the procedure with the base language, and then call it to perform special-purpose processing.

For example, when you work in PL/SQL, the language loads the library dynamically at runtime, and then calls the procedure as if it were a PL/SQL procedure. These procedures participate fully in the current transaction and can call back to the database to perform SQL operations.

The procedures are loaded only when necessary, so memory is conserved. The decoupling of the call specification from its implementation body means that the procedures can be enhanced without affecting the calling programs.

External procedures let you:

- Isolate execution of client applications and processes from the database instance to ensure that problems on the client side do not adversely affect the database
- Move computation-bound programs from client to server where they run faster (because they avoid the round trips of network communication)
- Interface the database server with external systems and data sources
- Extend the functionality of the database server itself

Note:

The external library (DLL file) must be statically linked. In other words, it must not reference external symbols from other external libraries (DLL files). Oracle Database does not resolve such symbols, so they can cause your external procedure to fail.

See Also:

Oracle Database Security Guide for information about securing external procedures

21.3 Overview of Call Specification for External Procedures

You publish external procedures through **call specifications**, which provide a superset of the `AS EXTERNAL` function through the `AS LANGUAGE` clause. `AS LANGUAGE` call

specifications allow the publishing of external C procedures. (Java class methods are not external procedures, but they still use call specifications.)

Note:

To support legacy applications, call specifications also enable you to publish with the `AS EXTERNAL` clause. For application development, however, using the `AS LANGUAGE` clause is recommended.

In general, call specifications enable:

- Dispatching the appropriate C or Java target procedure
- Data type conversions
- Parameter mode mappings
- Automatic memory allocation and cleanup
- Purity constraints to be specified, where necessary, for package functions called from SQL.
- Calling Java methods or C procedures from database triggers
- Location flexibility: you can put `AS LANGUAGE` call specifications in package or type specifications, or package (or type) bodies to optimize performance and hide implementation details

To use an existing program as an external procedure, load, publish, and then call it.

21.4 Loading External Procedures

To make your external C procedures or Java methods available to PL/SQL, you must first load them.

Note:

You can load external C procedures only on platforms that support either DLLs or dynamically loadable shared libraries (such as Solaris `.so` libraries).

When an application calls an external C procedure, Oracle Database or Oracle Listener starts the external procedure agent, `extproc`. Using the network connection established by Oracle Database or Oracle Listener, the application passes this information to `extproc`:

- Name of DLL or shared library
- Name of external procedure
- Any parameters for the external procedure

Then `extproc` loads the DLL or the shared library, runs the external procedure, and passes any values that the external procedure returns back to the application. The application and `extproc` must reside on the same computer.

`extproc` can call procedures in any library that complies with the calling standard used. For more information about the calling standard, see [CALLING STANDARD](#) (page 21-11).

Note:

The default configuration for external procedures no longer requires a network listener to work with Oracle Database and `extproc`. Oracle Database now spawns `extproc` directly, eliminating the risk that Oracle Listener might spawn `extproc` unexpectedly. This default configuration is recommended for maximum security.

You must change this default configuration, so that Oracle Listener spawns `extproc`, if you use any of these:

- A multithreaded `extproc` agent
- Oracle Database in shared mode on Windows
- An `AGENT` clause in the `LIBRARY` specification or an `AGENT IN` clause in the `PROCEDURE` specification that redirects external procedures to a different `extproc` agent

Changing the default configuration requires additional network configuration steps.

To configure your database to use external procedures that are written in C, or that can be called from C applications, you or your database administrator must follow these steps:

1. [Define the C Procedures](#) (page 21-5)
2. [Set Up the Environment](#) (page 21-6)
3. [Identify the DLL](#) (page 21-8)
4. [Publish the External Procedures](#) (page 21-9)

21.4.1 Define the C Procedures

Define the C procedures using one of these prototypes:

- Kernighan & Ritchie style prototypes; for example:

```
void C_findRoot(x)
float x;
...
```

- ISO/ANSI prototypes other than numeric data types that are less than full width (such as `float`, `short`, `char`); for example:

```
void C_findRoot(double x)
...
```

- Other data types that do not change size under default argument promotions.

This example changes size under default argument promotions:

```
void C_findRoot(float x)
...
```

21.4.2 Set Up the Environment

When you use the default configuration for external procedures, Oracle Database spawns `extproc` directly. You need not make configuration changes for `listener.ora` and `tnsnames.ora`. Define the environment variables to be used by external procedures in the file `extproc.ora` (located at `$ORACLE_HOME/hs/admin` on UNIX operating systems and at `ORACLE_HOME\hs\admin` on Windows), using this syntax:

```
SET name=value (environment_variable_name value)
```

Set the `EXTPROC_DLLS` environment variable, which restricts the DLLs that `extproc` can load, to one of these values:

- `NULL`; for example:

```
SET EXTPROC_DLLS=
```

This setting, the default, allows `extproc` to load only the DLLs that are in directory `$ORACLE_HOME/bin` or `$ORACLE_HOME/lib`.

- `ONLY`: followed by a colon-separated (semicolon-separated on Windows systems) list of DLLs; for example:

```
SET EXTPROC_DLLS=ONLY:DLL1:DLL2
```

This setting allows `extproc` to load only the DLLs named `DLL1` and `DLL2`. This setting provides maximum security.

- A colon-separated (semicolon-separated on Windows systems) list of DLLs; for example:

```
SET EXTPROC_DLLS=DLL1:DLL2
```

This setting allows `extproc` to load the DLLs named `DLL1` and `DLL2` and the DLLs that are in directory `$ORACLE_HOME/bin` or `$ORACLE_HOME/lib`.

- `ANY`; for example:

```
SET EXTPROC_DLLS=ANY
```

This setting allows `extproc` to load any DLL.

Set the `ENFORCE_CREDENTIAL` environment variable, which enforces the usage of credentials when spawning an `extproc` process. The `ENFORCE_CREDENTIAL` value can be `TRUE` or `FALSE` (the default). For a discussion of `ENFORCE_CREDENTIAL` and the expected behaviors of an `extproc` process based on possible authentication and impersonation scenarios, see the information about securing external procedures in *Oracle Database Security Guide*.

To change the default configuration for external procedures and have your `extproc` agent spawned by Oracle Listener, configure your database to use external procedures that are written in C, or can be called from C applications, as follows.

Note:

To use credentials for `extproc`, you cannot use Oracle Listener to spawn the `extproc` agent.

1. Set configuration parameters for the agent, named `extproc` by default, in the configuration files `tnsnames.ora` and `listener.ora`. This establishes the connection for the external procedure agent, `extproc`, when the database is started.
2. Start a listener process exclusively for external procedures.

The Listener sets a few required environment variables (such as `ORACLE_HOME`, `ORACLE_SID`, and `LD_LIBRARY_PATH`) for `extproc`. It can also define specific environment variables in the `ENVS` section of its `listener.ora` entry, and these variables are passed to the agent process. Otherwise, it provides the agent with a "clean" environment. The environment variables set for the agent are independent of those set for the client and server. Therefore, external procedures, which run in the agent process, cannot read environment variables set for the client or server processes.

Note:

It is possible for you to set and read environment variables themselves by using the standard C procedures `setenv` and `getenv`, respectively. Environment variables, set this way, are specific to the agent process, which means that they can be read by all functions executed in that process, but not by any other process running on the same host.

3. Determine whether the agent for your external procedure is to run in dedicated mode (the default) or multithreaded mode.

In dedicated mode, one "dedicated" agent is launched for each session. In multithreaded mode, a single multithreaded `extproc` agent is launched. The multithreaded `extproc` agent handles calls using different threads for different users. In a configuration where many users can call the external procedures, using a multithreaded `extproc` agent is recommended to conserve system resources.

If the agent is to run in dedicated mode, additional configuration of the agent process is not necessary.

If the agent is to run in multithreaded mode, your database administrator must configure the database system to start the agent in multithreaded mode (as a multithreaded `extproc` agent). To do this configuration, use the agent control utility, `agtctl`. For example, start `extproc` using this command:

```
agtctl startup extproc agent_sid
```

where `agent_sid` is the system identifier that this `extproc` agent services. An entry for this system identifier is typically added as an entry in the file `tnsnames.ora`. For more information about using `agtctl` for `extproc` administration, see *Administering the Multithreaded extproc Agent* in *Oracle Call Interface Programmer's Guide*.

Note:

- If you use a multithreaded `extproc` agent, the library you call must be thread-safe—to avoid errors such as a damaged call stack.
 - The database server, the agent process, and the listener process that spawns the agent process must all reside on the same host.
 - By default, the agent process runs on the same database instance as your main application. In situations where reliability is critical, you might want to run the agent process for the external procedure on a separate database instance (still on the same host), so that any problems in the agent do not affect the primary database server. To do so, specify the separate database instance using a database link.
-

Figure F-1 in *Oracle Call Interface Programmer's Guide* illustrates the architecture of the multithreaded `extproc` agent.

21.4.3 Identify the DLL

In this context, a DLL is any dynamically loadable operating-system file that stores external procedures.

For security reasons, your DBA controls access to the DLL. Using the `CREATE LIBRARY` statement, the DBA creates a schema object called an alias library, which represents the DLL. Then, if you are an authorized user, the DBA grants you `EXECUTE` privileges on the **alias** library. Alternatively, the DBA might grant you `CREATE ANY LIBRARY` privileges, in which case you can create your own alias libraries using this syntax:

```
CREATE LIBRARY [schema_name.]library_name
  {IS | AS} 'file_path'
  [AGENT 'agent_link'];
```

Note:

The `ANY` privileges are very powerful and must not be granted lightly. For more information, see:

- *Oracle Database Security Guide* for information about managing system privileges, including `ANY`
 - *Oracle Database Security Guide* for guidelines for securing user accounts and privileges
-

Oracle recommends that you specify the path to the DLL using a directory object, rather than only the DLL name. In this example, you create alias library `c_utils`, which represents DLL `utils.so`:

```
CREATE LIBRARY C_utils AS 'utils.so' IN DLL_DIRECTORY;
```

where `DLL_DIRECTORY` is a directory object that refers to `'/DLLs'`.

As an alternative, you can specify the full path to the DLL, as in this example:

```
CREATE LIBRARY C_utils AS '/DLLs/utils.so';
```

To allow flexibility in specifying the DLLs, you can specify the root part of the path as an environment variable using the notation `${VAR_NAME}`, and set up that variable in the `ENVS` section of the `listener.ora` entry.

In this example, the agent specified by the name `agent_link` is used to run any external procedure in the library `C_Utills`:

```
create database link agent_link using 'agent_tns_alias';
create or replace library C_utils is
  '${EP_LIB_HOME}/utils.so' agent 'agent_link';
```

The environment variable `EP_LIB_HOME` is expanded by the agent to the appropriate path for that instance, such as `/usr/bin/dll`. Variable `EP_LIB_HOME` must be set in the file `listener.ora`, for the agent to be able to access it.

For security reasons, `extproc`, by default, loads only DLLs that are in directory `$ORACLE_HOME/bin` or `$ORACLE_HOME/lib`. Also, only local sessions—that is, Oracle Database client processes that run on the same system—are allowed to connect to `extproc`.

To load DLLs from other directories, set the environment variable `EXTPROC_DLLS`. The value for this environment variable is a colon-separated (semicolon-separated on Windows systems) list of DLL names qualified with the complete path. For example:

```
EXTPROC_DLLS=/private1/home/johndoe/dll/myDll.so:/private1/home/johndoe/dll/newDll.so
```

While you can set up environment variables for `extproc` through the `ENVS` parameter in the file `listener.ora`, you can also set up environment variables in the `extproc` initialization file `extproc.ora` in directory `$ORACLE_HOME/hs/admin`. When both `extproc.ora` and `ENVS` parameter in `listener.ora` are used, the environment variables defined in `extproc.ora` take precedence. See the Oracle Net manual for more information about the `EXTPROC` feature.

Note:

In `extproc.ora` on a Windows system, specify the path using a drive letter and using a double backslash (`\\`) for each backslash in the path. (The first backslash in each double backslash serves as an escape character.)

21.4.4 Publish the External Procedures

You find or write an external C procedure, and add it to the DLL. When the procedure is in the DLL, you publish it using the call specification mechanism described in [Publishing External Procedures](#) (page 21-9).

21.5 Publishing External Procedures

Oracle Database can use only external procedures that are published through a call specification, which maps names, parameter types, and return types for your Java class method or C external procedure to their SQL counterparts. It is written like any other PL/SQL stored procedure except that, in its body, instead of declarations and a `BEGIN END` block, you code the `AS LANGUAGE` clause.

The `AS LANGUAGE` clause specifies:

- Which language the procedure is written in
- For a Java method:

- The signature of the Java method
- For a C procedure:
 - The alias library corresponding to the DLL for a C procedure
 - The name of the C procedure in a DLL
 - Various options for specifying how parameters are passed
 - Which parameter (if any) holds the name of the external procedure agent, `extproc`, for running the procedure on a different system

You begin the declaration using the normal `CREATE OR REPLACE` syntax for a procedure, function, package specification, package body, type specification, or type body.

The call specification follows the name and parameter declarations. Its syntax is:

```
{IS | AS} LANGUAGE {C | JAVA}
```

This is then followed by either:

```
NAME java_string_literal_name
```

Where *java_string_literal_name* is the signature of your Java method

Or by:

```
{ LIBRARY library_name [ NAME c_string_literal_name ] |
  [ NAME c_string_literal_name ] LIBRARY library_name }
[ AGENT IN ( argument [, argument]... ) ]
[ WITH CONTEXT ]
[ PARAMETERS (external_parameter [, external_parameter]...) ];
```

Where *library_name* is the name of your alias library, *c_string_literal_name* is the name of your external C procedure, and *external_parameter* stands for:

```
{ CONTEXT
  | SELF [{TDO | property}]
  | {parameter_name | RETURN} [property] [BY REFERENCE] [external_datatype}]
```

property stands for:

```
{INDICATOR [{STRUCT | TDO}] | LENGTH | DURATION | MAXLEN | CHARSETID | CHARSETFORM}
```

Note:

Unlike Java, C does not understand SQL types; therefore, the syntax is more intricate

Topics:

- [AS LANGUAGE Clause for Java Class Methods](#) (page 21-10)
- [AS LANGUAGE Clause for External C Procedures](#) (page 21-11)

21.5.1 AS LANGUAGE Clause for Java Class Methods

The `AS LANGUAGE` clause is the interface between PL/SQL and a Java class method.

21.5.2 AS LANGUAGE Clause for External C Procedures

These subclauses tell PL/SQL where to locate the external C procedure, how to call it, and what to pass to it:

- [LIBRARY](#) (page 21-11)
- [NAME](#) (page 21-11)
- [LANGUAGE](#) (page 21-11)
- [CALLING STANDARD](#) (page 21-11)
- [WITH CONTEXT](#) (page 21-11)
- [PARAMETERS](#) (page 21-12)
- "AGENT IN" (page 21-12)"

Of the preceding subclauses, only `LIBRARY` is required.

21.5.2.1 LIBRARY

Specifies a local alias library. (You cannot use a database link to specify a remote library.) The library name is a PL/SQL identifier. Therefore, if you enclose the name in double quotation marks, then it becomes case-sensitive. (By default, the name is stored in upper case.) You must have `EXECUTE` privileges on the alias library.

21.5.2.2 NAME

Specifies the external C procedure to be called. If you enclose the procedure name in double quotation marks, then it becomes case-sensitive. (By default, the name is stored in upper case.) If you omit this subclause, then the procedure name defaults to the upper-case name of the PL/SQL procedure.

Note:

The terms `LANGUAGE` and `CALLING STANDARD` apply only to the superseded `AS EXTERNAL` clause.

21.5.2.3 LANGUAGE

Specifies the third-generation language in which the external procedure was written. If you omit this subclause, then the language name defaults to `C`.

21.5.2.4 CALLING STANDARD

Specifies the calling standard under which the external procedure was compiled. The supported calling standard is `C`. If you omit this subclause, then the calling standard defaults to `C`.

21.5.2.5 WITH CONTEXT

Specifies that a context pointer is passed to the external procedure. The context data structure is opaque to the external procedure but is available to service procedures called by the external procedure.

21.5.2.6 PARAMETERS

Specifies the positions and data types of parameters passed to the external procedure. It can also specify parameter properties, such as current length and maximum length, and the preferred parameter passing method (by value or by reference).

21.5.2.7 AGENT IN

Specifies which parameter holds the name of the agent process that runs this procedure. This is intended for situations where the external procedure agent, `extproc`, runs using multiple agent processes, to ensure robustness if the agent process of one external procedure fails. You can pass the name of the agent process (corresponding to the name of a database link), and if `tnsnames.ora` and `listener.ora` are set up properly across both instances, the external procedure is called on the other instance. Both instances must be on the same host.

This is similar to the `AGENT` clause of the `CREATE LIBRARY` statement; specifying the value at runtime through `AGENT IN` allows greater flexibility.

When the agent name is specified this way, it overrides any agent name declared in the alias library. If no agent name is specified, the default is the `extproc` agent on the same instance as the calling program.

21.6 Publishing Java Class Methods

Java classes and their methods are stored in RDBMS libunits in which you can load Java sources, binaries and resources using the `LOADJAVA` utility or the `CREATEJAVA` SQL statements. Libunits can be considered analogous to DLLs written, for example, in C—although they map one-to-one with Java classes, whereas DLLs can contain multiple procedures.

The `NAME`-clause string uniquely identifies the Java method. The PL/SQL function or procedure and Java must have corresponding parameters. If the Java method takes no parameters, then you must code an empty parameter list for it.

When you load Java classes into the RDBMS, they are not published to SQL automatically. This is because only selected public static methods can be explicitly published to SQL. However, all methods can be invoked from other Java classes residing in the database, provided they have proper authorization.

Suppose you want to publish this Java method named `J_calcFactorial`, which returns the factorial of its argument:

```
package myRoutines.math;
public class Factorial {
    public static int J_calcFactorial (int n) {
        if (n == 1) return 1;
        else return n * J_calcFactorial(n - 1);
    }
}
```

This call specification publishes Java method `J_calcFactorial` as PL/SQL stored function `plsToJavaFac_func`, using `SQL*Plus`:

```
CREATE OR REPLACE FUNCTION Plstojavafac_func (N NUMBER) RETURN NUMBER AS
LANGUAGE JAVA
NAME 'myRoutines.math.Factorial.J_calcFactorial(int) return int';
```

21.7 Publishing External C Procedures

In this example, you write a PL/SQL standalone function named `plscallsCdivisor_func` that publishes C function `Cdivisor_func` as an external function:

```
CREATE OR REPLACE FUNCTION plscallsCdivisor_func (  
  /* Find greatest common divisor of x and y: */  
  x    PLS_INTEGER,  
  y    PLS_INTEGER)  
RETURN PLS_INTEGER  
AS LANGUAGE C  
  LIBRARY C_utils  
  NAME "Cdivisor_func"; /* Quotation marks preserve case. */
```

21.8 Locations of Call Specifications

For both Java class methods and external C procedures, call specifications can be specified in any of these locations:

- Standalone PL/SQL procedures
- PL/SQL Package Specifications
- PL/SQL Package Bodies
- ADT Specifications
- ADT Bodies

Topics:

- [Example: Locating a Call Specification in a PL/SQL Package](#) (page 21-14)
- [Example: Locating a Call Specification in a PL/SQL Package Body](#) (page 21-14)
- [Example: Locating a Call Specification in an ADT Specification](#) (page 21-14)
- [Example: Locating a Call Specification in an ADT Body](#) (page 21-15)
- [Example: Java with AUTHID](#) (page 21-15)
- [Example: C with Optional AUTHID](#) (page 21-15)
- [Example: Mixing Call Specifications in a Package](#) (page 21-15)

Note:

In these examples, the `AUTHID` and `SQL_NAME_RESOLVE` clauses might be required to fully stipulate a call specification.

:

- *Oracle Database PL/SQL Language Reference* for more information about calling external procedures from PL/SQL
- *Oracle Database SQL Language Reference* for more information about the SQL CALL statement

21.8.1 Example: Locating a Call Specification in a PL/SQL Package

```
CREATE OR REPLACE PACKAGE Demo_pack
AUTHID DEFINER
AS
  PROCEDURE plsToC_demoExternal_proc (x PLS_INTEGER, y VARCHAR2, z DATE)
  AS LANGUAGE C
    NAME "C_demoExternal"
    LIBRARY SomeLib
    WITH CONTEXT
    PARAMETERS(CONTEXT, x INT, y STRING, z OCIDATE);
END;
```

21.8.2 Example: Locating a Call Specification in a PL/SQL Package Body

```
CREATE OR REPLACE PACKAGE Demo_pack
  AUTHID CURRENT_USER
AS
  PROCEDURE plsToC_demoExternal_proc(x PLS_INTEGER, y VARCHAR2, z DATE);
END;

CREATE OR REPLACE PACKAGE BODY Demo_pack
  SQL_NAME_RESOLVE CURRENT_USER
AS
  PROCEDURE plsToC_demoExternal_proc (x PLS_INTEGER, y VARCHAR2, z DATE)
  AS LANGUAGE JAVA
    NAME 'pkg1.class4.methodProc1(int,java.lang.String,java.sql.Date)';
END;
```

21.8.3 Example: Locating a Call Specification in an ADT Specification

Note:

For examples in this topic to work, you must set up this data structure (which requires that you have the privilege CREATE ANY LIBRARY):

```
CREATE OR REPLACE LIBRARY SOME LIB AS '/tmp/lib.so';
```

```
CREATE OR REPLACE TYPE Demo_typ
AUTHID DEFINER
AS OBJECT
  (Attribute1 VARCHAR2(2000), SomeLib varchar2(20),
  MEMBER PROCEDURE plsToC_demoExternal_proc (x PLS_INTEGER, y VARCHAR2, z DATE)
  AS LANGUAGE C
    NAME "C_demoExternal"
    LIBRARY SomeLib
    WITH CONTEXT
    -- PARAMETERS(CONTEXT, x INT, y STRING, z OCIDATE)
```

```

        PARAMETERS(CONTEXT, x INT, y STRING, z OCIDATE, SELF)
    );

```

21.8.4 Example: Locating a Call Specification in an ADT Body

```

CREATE OR REPLACE TYPE Demo_typ
AUTHID CURRENT_USER
AS OBJECT
    (attributel NUMBER,
    MEMBER PROCEDURE plsToJ_demoExternal_proc (x PLS_INTEGER, y VARCHAR2, z DATE)
    );

CREATE OR REPLACE TYPE BODY Demo_typ
AS
    MEMBER PROCEDURE plsToJ_demoExternal_proc (x PLS_INTEGER, y VARCHAR2, z DATE)
    AS LANGUAGE JAVA
        NAME 'pkg1.class4.J_demoExternal(int,java.lang.String,java.sql.Date)';
END;

```

21.8.5 Example: Java with AUTHID

Here is an example of a publishing a Java class method in a standalone PL/SQL procedure.

```

CREATE OR REPLACE PROCEDURE plsToJ_demoExternal_proc (x PLS_INTEGER, y VARCHAR2, z
DATE)
    AUTHID CURRENT_USER
AS LANGUAGE JAVA
    NAME 'pkg1.class4.methodProc1(int,java.lang.String,java.sql.Date)';

```

21.8.6 Example: C with Optional AUTHID

Here is an example of AS EXTERNAL publishing a C procedure in a standalone PL/SQL program, in which the AUTHID clause is optional. This maintains compatibility with the external procedures of Oracle Database version 8.0.

```

CREATE OR REPLACE PROCEDURE plsToC_demoExternal_proc (x PLS_INTEGER, y VARCHAR2, z
DATE)
AS
    EXTERNAL
    NAME "C_demoExternal"
    LIBRARY SomeLib
    WITH CONTEXT
    PARAMETERS(CONTEXT, x INT, y STRING, z OCIDATE);

```

21.8.7 Example: Mixing Call Specifications in a Package

```

CREATE OR REPLACE PACKAGE Demo_pack
AUTHID DEFINER
AS
    PROCEDURE plsToC_InBodyOld_proc (x PLS_INTEGER, y VARCHAR2, z DATE);
    PROCEDURE plsToC_demoExternal_proc (x PLS_INTEGER, y VARCHAR2, z DATE);
    PROCEDURE plsToC_InBody_proc (x PLS_INTEGER, y VARCHAR2, z DATE);
    PROCEDURE plsToJ_InBody_proc (x PLS_INTEGER, y VARCHAR2, z DATE);

    PROCEDURE plsToJ_InSpec_proc (x PLS_INTEGER, y VARCHAR2, z DATE)
    IS LANGUAGE JAVA
        NAME 'pkg1.class4.J_InSpec_meth(int,java.lang.String,java.sql.Date)';

    PROCEDURE C_InSpec_proc (x PLS_INTEGER, y VARCHAR2, z DATE)

```

```

AS LANGUAGE C
  NAME "C_demoExternal"
  LIBRARY SomeLib
  WITH CONTEXT
  PARAMETERS(CONTEXT, x INT, y STRING, z OCIDATE);
END;

CREATE OR REPLACE PACKAGE BODY Demo_pack
AS
PROCEDURE plsToC_InBodyOld_proc (x PLS_INTEGER, y VARCHAR2, z DATE)
  AS EXTERNAL
  NAME "C_InBodyOld"
  LIBRARY SomeLib
  WITH CONTEXT
  PARAMETERS(CONTEXT, x INT, y STRING, z OCIDATE);
PROCEDURE plsToC_demoExternal_proc (x PLS_INTEGER, y VARCHAR2, z DATE)
  AS LANGUAGE C
  NAME "C_demoExternal"
  LIBRARY SomeLib
  WITH CONTEXT
  PARAMETERS(CONTEXT, x INT, y STRING, z OCIDATE);

PROCEDURE plsToC_InBody_proc (x PLS_INTEGER, y VARCHAR2, z DATE)
  AS LANGUAGE C
  NAME "C_InBody"
  LIBRARY SomeLib
  WITH CONTEXT
  PARAMETERS(CONTEXT, x INT, y STRING, z OCIDATE);
PROCEDURE plsToJ_InBody_proc (x PLS_INTEGER, y VARCHAR2, z DATE)
  IS LANGUAGE JAVA
  NAME 'pkg1.class4.J_InBody_meth(int, java.lang.String, java.sql.Date)';
END;
    
```

21.9 Passing Parameters to External C Procedures with Call Specifications

Call specifications allow a mapping between PL/SQL and C data types. See [Specifying Data Types](#) (page 21-17) for data type mappings.

Passing parameters to an external C procedure is complicated by several circumstances:

- The available set of PL/SQL data types does not correspond one-to-one with the set of C data types.
- Unlike C, PL/SQL includes the RDBMS concept of nullity. Therefore, PL/SQL parameters can be NULL, whereas C parameters cannot.
- The external procedure might need the current length or maximum length of CHAR, LONG RAW, RAW, and VARCHAR2 parameters.
- The external procedure might need character set information about CHAR, VARCHAR2, and CLOB parameters.
- PL/SQL might need the current length, maximum length, or null status of values returned by the external procedure.

Note:

The maximum number of parameters that you can pass to a C external procedure is 128. However, if you pass float or double parameters by value, then the maximum is less than 128. How much less depends on the number of such parameters and your operating system. To get a rough estimate, count each float or double passed by value as two parameters.

Topics:

- [Specifying Data Types](#) (page 21-17)
- [External Data Type Mappings](#) (page 21-19)
- [Passing Parameters BY VALUE or BY REFERENCE](#) (page 21-22)
- [Declaring Formal Parameters](#) (page 21-22)
- [Overriding Default Data Type Mapping](#) (page 21-23)
- [Specifying Properties](#) (page 21-23)

21.9.1 Specifying Data Types

Do not pass parameters to an external procedure directly. Instead, pass them to the PL/SQL procedure that published the external procedure, specifying PL/SQL data types for the parameters. PL/SQL data types map to default external data types, as shown in [Table 21-1](#) (page 21-17).

Note:

The PL/SQL data types `BINARY_INTEGER` and `PLS_INTEGER` are identical. For simplicity, this guide uses "PLS_INTEGER" to mean both `BINARY_INTEGER` and `PLS_INTEGER`.

Table 21-1 *Parameter Data Type Mappings*

PL/SQL Data Type	Supported External Types	Default External Type
<code>BINARY_INTEGER</code>	[UNSIGNED] CHAR	INT
<code>BOOLEAN</code>	[UNSIGNED] SHORT	
<code>PLS_INTEGER</code>	[UNSIGNED] INT	
	[UNSIGNED] LONG	
	SB1, SB2, SB4	
	UB1, UB2, UB4	
	SIZE_T	

Table 21-1 (Cont.) Parameter Data Type Mappings

PL/SQL Data Type	Supported External Types	Default External Type
NATURAL ¹ NATURALN ¹ POSITIVE ¹ POSITIVEN ¹ SIGNTYPE ¹	[UNSIGNED] CHAR [UNSIGNED] SHORT [UNSIGNED] INT [UNSIGNED] LONG SB1, SB2, SB4 UB1, UB2, UB4 SIZE_T	UNSIGNED INT
FLOAT REAL	FLOAT	FLOAT
DOUBLE PRECISION	DOUBLE	DOUBLE
CHAR CHARACTER LONG NCHAR NVARCHAR2 ROWID VARCHAR VARCHAR2	STRING OCISTRING	STRING
LONG RAW RAW	RAW OCIRAW	RAW
BFILE BLOB CLOB NCLOB	OCILOBLOCATOR	OCILOBLOCATOR
NUMBER DEC ¹ DECIMAL ¹ INT ¹ INTEGER ¹ NUMERIC ¹ SMALLINT ¹	OCINUMBER	OCINUMBER
DATE	OCIDATE	OCIDATE
TIMESTAMP TIMESTAMP WITH TIME ZONE TIMESTAMP WITH LOCAL TIME ZONE	OCIDateTime	OCIDateTime

Table 21-1 (Cont.) Parameter Data Type Mappings

PL/SQL Data Type	Supported External Types	Default External Type
INTERVAL DAY TO SECOND INTERVAL YEAR TO MONTH	OCIInterval	OCIInterval
composite object types: ADTs	dvoid	dvoid
composite object types: collections (associative arrays, varrays, nested tables)	OCICOLL	OCICOLL

¹ This PL/SQL type compiles only if you use AS EXTERNAL in your call spec.

21.9.2 External Data Type Mappings

Each external data type maps to a C data type, and the data type conversions are performed implicitly. To avoid errors when declaring C prototype parameters, see [Table 21-2](#) (page 21-19), which shows the C data type to specify for a given external data type and PL/SQL parameter mode. For example, if the external data type of an OUT parameter is `STRING`, then specify the data type `char *` in your C prototype.

Table 21-2 External Data Type Mappings

External Data Type Corresponding to PL/SL Type	If Mode is IN or RETURN, Specify in C Prototype...	If Mode is IN by Reference or RETURN by Reference, Specify in C Prototype...	If Mode is IN OUT or OUT, Specify in C Prototype...
CHAR	char	char *	char *
UNSIGNED CHAR	unsigned char	unsigned char *	unsigned char *
SHORT	short	short *	short *
UNSIGNED SHORT	unsigned short	unsigned short *	unsigned short *
INT	int	int *	int *
UNSIGNED INT	unsigned int	unsigned int *	unsigned int *
LONG	long	long *	long *

Table 21-2 (Cont.) External Data Type Mappings

External Data Type Corresponding to PL/SL Type	If Mode is IN or RETURN, Specify in C Prototype...	If Mode is IN by Reference or RETURN by Reference, Specify in C Prototype...	If Mode is IN OUT or OUT, Specify in C Prototype...
UNSIGNED LONG	unsigned long	unsigned long *	unsigned long *
CHAR	char	char *	char *
UNSIGNED CHAR	unsigned char	unsigned char *	unsigned char *
SHORT	short	short *	short *
UNSIGNED SHORT	unsigned short	unsigned short *	unsigned short *
INT	int	int *	int *
UNSIGNED INT	unsigned int	unsigned int *	unsigned int *
LONG	long	long *	long *
UNSIGNED LONG	unsigned long	unsigned long *	unsigned long *
SIZE_T	size_t	size_t *	size_t *
SB1	sb1	sb1 *	sb1 *
UB1	ub1	ub1 *	ub1 *
SB2	sb2	sb2 *	sb2 *
UB2	ub2	ub2 *	ub2 *
SB4	sb4	sb4 *	sb4 *

Table 21-2 (Cont.) External Data Type Mappings

External Data Type Corresponding to PL/SL Type	If Mode is IN or RETURN, Specify in C Prototype...	If Mode is IN by Reference or RETURN by Reference, Specify in C Prototype...	If Mode is IN OUT or OUT, Specify in C Prototype...
UB4	ub4	ub4 *	ub4 *
FLOAT	float	float *	float *
DOUBLE	double	double *	double *
STRING	char *	char *	char *
RAW	unsigned char *	unsigned char *	unsigned char *
OCILOBLOCATOR	OCILOBLocator *	OCILOBLocator **	OCILOBLocator **
OCINUMBER	OCINumber *	OCINumber *	OCINumber *
OCISTRING	OCIString *	OCIString *	OCIString *
OCIRAW	OCIRaw *	OCIRaw *	OCIRaw *
OCIDATE	OCIDate *	OCIDate *	OCIDate *
OCICOLL	OCIColl * or OCIArray * or OCITable *	OCIColl ** or OCIArray ** or OCITable **	OCIColl ** or OCIArray ** or OCITable **
OCITYPE	OCIType *	OCIType *	OCIType *
TDO	OCIType *	OCIType *	OCIType *
ADT (final types)	dvoid*	dvoid*	dvoid*

Table 21-2 (Cont.) External Data Type Mappings

External Data Type Corresponding to PL/SQL Type	If Mode is IN or RETURN, Specify in C Prototype...	If Mode is IN by Reference or RETURN by Reference, Specify in C Prototype...	If Mode is IN OUT or OUT, Specify in C Prototype...
ADT (nonfinal types)	dvoid*	dvoid*	dvoid**

Composite data types are not self describing. Their description is stored in a **Type Descriptor Object** (TDO). Objects and indicator structs for objects have no predefined OCI data type, but must use the data types generated by Oracle Database's **Object Type Translator** (OTT). The optional TDO argument for **INDICATOR**, and for composite objects, in general, has the C data type, `OCIType *`.

`OCICOLL` for `REF` and collection arguments is optional and exists only for completeness. You cannot map a `REF` or collection type onto any other data type, or any other data type onto a `REF` or collection type.

21.9.3 Passing Parameters BY VALUE or BY REFERENCE

If you specify `BY VALUE`, then scalar `IN` and `RETURN` arguments are passed by value (which is also the default). Alternatively, you might have them passed by reference by specifying `BY REFERENCE`.

By default, or if you specify `BY REFERENCE`, then scalar `IN OUT`, and `OUT` arguments are passed by reference. Specifying `BY VALUE` for `IN OUT`, and `OUT` arguments is not supported for C. The usefulness of the `BY REFERENCE/VALUE` clause is restricted to external data types that are, by default, passed by value. This is true for `IN`, and `RETURN` arguments of these external types:

```
[UNSIGNED] CHAR
[UNSIGNED] SHORT
[UNSIGNED] INT
[UNSIGNED] LONG
SIZE_T
SB1
SB2
SB4
UB1
UB2
UB4
FLOAT
DOUBLE
```

All `IN` and `RETURN` arguments of external types not on this list, all `IN OUT` arguments, and all `OUT` arguments are passed by reference.

21.9.4 Declaring Formal Parameters

Generally, the PL/SQL procedure that publishes an external procedure declares a list of formal parameters, as this example shows:

Note:

You might need to set up this data structure for examples in this topic to work:

```
CREATE LIBRARY MathLib AS '/tmp/math.so';
```

```
CREATE OR REPLACE FUNCTION Interp_func (
/* Find the value of y at x degrees using Lagrange interpolation: */
  x    IN FLOAT,
  y    IN FLOAT)
RETURN FLOAT AS
LANGUAGE C
NAME "Interp_func"
LIBRARY MathLib;
```

Each formal parameter declaration specifies a name, parameter mode, and PL/SQL data type (which maps to the default external data type). That might be all the information the external procedure needs. If not, then you can provide more information using the `PARAMETERS` clause, which lets you specify:

- Nondefault external data types
- The current or maximum length of a parameter
- NULL/NOT NULL indicators for parameters
- Character set IDs and forms
- The position of parameters in the list
- How IN parameters are passed (by value or by reference)

If you decide to use the `PARAMETERS` clause, keep in mind:

- For every formal parameter, there must be a corresponding parameter in the `PARAMETERS` clause.
- If you include the `WITH CONTEXT` clause, then you must specify the parameter `CONTEXT`, which shows the position of the context pointer in the parameter list.
- If the external procedure is a function, then you might specify the `RETURN` parameter, but it must be in the last position. If `RETURN` is not specified, the default external type is used.

21.9.5 Overriding Default Data Type Mapping

In some cases, you can use the `PARAMETERS` clause to override the default data type mappings. For example, you can remap the PL/SQL data type `BOOLEAN` from external data type `INT` to external data type `CHAR`.

21.9.6 Specifying Properties

You can also use the `PARAMETERS` clause to pass more information about PL/SQL formal parameters and function results to an external procedure. Do this by specifying one or more of these properties:

INDICATOR [{STRUCT | TDO}]
 LENGTH
 DURATION
 MAXLEN
 CHARSETID
 CHARSETFORM
 SELF

Table 21-3 (page 21-24) shows the allowed and the default external data types, PL/SQL data types, and PL/SQL parameter modes allowed for a given property. MAXLEN (used to specify data returned from C back to PL/SQL) cannot be applied to an IN parameter.

Table 21-3 Properties and Data Types

Property	Allowed External Types (C)	Default External Type (C)	Allowed PL/SQL Types	Allowed PL/SQL Modes	Default PL/SQL Passing Method
INDICATOR	SHORT	SHORT	all scalars	IN IN OUT OUT RETURN	BY VALUE BY REFERENCE BY REFERENCE BY REFERENCE
LENGTH	[UNSIGNED] SHORT [UNSIGNED] INT [UNSIGNED] LONG	INT	CHAR LONG RAW RAW VARCHAR2	IN IN OUT OUT RETURN	BY VALUE BY REFERENCE BY REFERENCE BY REFERENCE
MAXLEN	[UNSIGNED] SHORT [UNSIGNED] INT [UNSIGNED] LONG	INT	CHAR LONG RAW RAW VARCHAR2	IN OUT OUT RETURN	BY REFERENCE BY REFERENCE BY REFERENCE
CHARSETID CHARSETFOR M	UNSIGNED SHORT UNSIGNED INT UNSIGNED LONG	UNSIGNED INT	CHAR CLOB VARCHAR2	IN IN OUT OUT RETURN	BY VALUE BY REFERENCE BY REFERENCE BY REFERENCE

In this example, the PARAMETERS clause specifies properties for the PL/SQL formal parameters and function result:

```
CREATE OR REPLACE FUNCTION plsToCparse_func (
  x IN PLS_INTEGER,
  Y IN OUT CHAR)
RETURN CHAR AS LANGUAGE C
  LIBRARY c_utils
  NAME "C_parse"
  PARAMETERS (
    x,          -- stores value of x
    x INDICATOR, -- stores null status of x
    y,          -- stores value of y
    y LENGTH,  -- stores current length of y
    y MAXLEN,  -- stores maximum length of y
```

```

RETURN INDICATOR,
RETURN);

```

With this `PARAMETERS` clause, the C prototype becomes:

```

char *C_parse( int x, short x_ind, char *y, int *y_len, int *y_maxlen,
short *retind );

```

The additional parameters in the C prototype correspond to the `INDICATOR` (for `x`), `LENGTH` (of `y`), and `MAXLEN` (of `y`), and the `INDICATOR` for the function result in the `PARAMETERS` clause. The parameter `RETURN` corresponds to the C function identifier, which stores the result value.

Topics:

- [INDICATOR](#) (page 21-25)
- [LENGTH and MAXLEN](#) (page 21-26)
- [CHARSETID and CHARSETFORM](#) (page 21-26)
- [Repositioning Parameters](#) (page 21-27)
- [SELF](#) (page 21-27)
- [BY REFERENCE](#) (page 21-29)
- [WITH CONTEXT](#) (page 21-11)
- [Interlanguage Parameter Mode Mappings](#) (page 21-30)

21.9.6.1 INDICATOR

An `INDICATOR` is a parameter whose value indicates whether another parameter is `NULL`. PL/SQL does not need indicators, because the RDBMS concept of nullity is built into the language. However, an external procedure might need to determine if a parameter or function result is `NULL`. Also, an external procedure might need to signal the server that a returned value is `NULL`, and must be treated accordingly.

In such cases, you can use the property `INDICATOR` to associate an indicator with a formal parameter. If the PL/SQL procedure is a function, then you can also associate an indicator with the function result, as shown in [Specifying Properties](#) (page 21-23).

To check the value of an indicator, you can use the constants `OCI_IND_NULL` and `OCI_IND_NOTNULL`. If the indicator equals `OCI_IND_NULL`, then the associated parameter or function result is `NULL`. If the indicator equals `OCI_IND_NOTNULL`, then the parameter or function result is not `NULL`.

For `IN` parameters, which are inherently read-only, `INDICATOR` is passed by value (unless you specify `BY REFERENCE`) and is read-only (even if you specify `BY REFERENCE`). For `OUT`, `IN OUT`, and `RETURN` parameters, `INDICATOR` is passed by reference by default.

The `INDICATOR` can also have a `STRUCT` or `TDO` option. Because specifying `INDICATOR` as a property of an object is not supported, and because arguments of objects have complete indicator structs instead of `INDICATOR` scalars, you must specify this by using the `STRUCT` option. You must use the type descriptor object (`TDO`) option for composite objects and collections,

21.9.6.2 LENGTH and MAXLEN

In PL/SQL, there is no standard way to indicate the length of a RAW or string parameter. However, you might want to pass the length of such a parameter to and from an external procedure. Using the properties `LENGTH` and `MAXLEN`, you can specify parameters that store the current length and maximum length of a formal parameter.

Note:

With a parameter of type RAW or LONG RAW, you must use the property `LENGTH`. Also, if that parameter is IN OUT and NULL or OUT and NULL, then you must set the length of the corresponding C parameter to zero.

For IN parameters, `LENGTH` is passed by value (unless you specify `BY REFERENCE`) and is read-only. For OUT, IN OUT, and RETURN parameters, `LENGTH` is passed by reference.

`MAXLEN` does not apply to IN parameters. For OUT, IN OUT, and RETURN parameters, `MAXLEN` is passed by reference and is read-only.

21.9.6.3 CHARSETID and CHARSETFORM

Oracle Database provides globalization support, which lets you process single-byte and multibyte character data and convert between character sets. It also lets your applications run in different language environments.

By default, if the server and agent use the exact same `$ORACLE_HOME` value, the agent uses the same globalization support settings as the server (including any settings that were specified with `ALTER SESSION` statements).

If the agent is running in a separate `$ORACLE_HOME` (even if the same location is specified by two different aliases or symbolic links), the agent uses the same globalization support settings as the server except for the character set; the default character set for the agent is defined by the `NLS_LANG` and `NLS_NCHAR` environment settings for the agent.

The properties `CHARSETID` and `CHARSETFORM` identify the nondefault character set from which the character data being passed was formed. With `CHAR`, `CLOB`, and `VARCHAR2` parameters, you can use `CHARSETID` and `CHARSETFORM` to pass the character set ID and form to the external procedure.

For IN parameters, `CHARSETID` and `CHARSETFORM` are passed by value (unless you specify `BY REFERENCE`) and are read-only (even if you specify `BY REFERENCE`). For OUT, IN OUT, and RETURN parameters, `CHARSETID` and `CHARSETFORM` are passed by reference and are read-only.

The OCI attribute names for these properties are `OCI_ATTR_CHARSET_ID` and `OCI_ATTR_CHARSET_FORM`.

:

- *Oracle Call Interface Programmer's Guide* for more information about OCI_ATTR_CHARSET_ID and OCI_ATTR_CHARSET_FORM
- *Oracle Database Globalization Support Guide* for more information about using national language data with the OCI

21.9.6.4 Repositioning Parameters

Remember, each formal parameter of the external procedure must have a corresponding parameter in the `PARAMETERS` clause. Their positions can differ, because PL/SQL associates them by name, not by position. However, the `PARAMETERS` clause and the C prototype for the external procedure must have the same number of parameters, and they must be in the same order.

21.9.6.5 SELF

`SELF` is the always-present argument of an object type's member procedure, namely the object instance itself. In most cases, this argument is implicit and is not listed in the argument list of the PL/SQL procedure. However, `SELF` must be explicitly specified as an argument of the `PARAMETERS` clause.

For example, assume that you want to create a `Person` object, consisting of a person's name and date of birth, and then create a table of this object type. You eventually want to determine the age of each `Person` object in this table.

1. In SQL*Plus, the `Person` object type can be created by:

```
CREATE OR REPLACE TYPE Person1_typ AS OBJECT (
    Name_   VARCHAR2(30),
    B_date  DATE,
    MEMBER FUNCTION calcAge_func RETURN NUMBER
);
/
```

2. Declare the body of the member function as follows:

```
CREATE OR REPLACE TYPE BODY Person1_typ AS
    MEMBER FUNCTION calcAge_func RETURN NUMBER
    AS LANGUAGE C
    NAME "age"
    LIBRARY agelib
    WITH CONTEXT
    PARAMETERS (
        CONTEXT,
        SELF,
        SELF INDICATOR STRUCT,
        SELF TDO,
        RETURN INDICATOR
    );
END;
/
```

(Typically, the member function is implemented in PL/SQL, but in this example it is an external procedure.)

The `calcAge_func` member function takes no arguments and returns a number. A member function is always called on an instance of the associated object type.

The object instance itself always is an implicit argument of the member function. To refer to the implicit argument, the `SELF` keyword is used. This is incorporated into the external procedure syntax by supporting references to `SELF` in the parameters clause.

3. Create and populate the matching table.

```
CREATE TABLE Person_tab OF Person1_typ;

INSERT INTO Person_tab
VALUES ('BOB', TO_DATE('14-MAY-85'));

INSERT INTO Person_tab
VALUES ('JOHN', TO_DATE('22-DEC-71'));
```

4. Retrieve the information of interest from the table.

```
SELECT p.name, p.b_date, p.calcAge_func() FROM Person_tab p;
```

NAME	B_DATE	P.CALCAGE_
BOB	14-MAY-85	0
JOHN	22-DEC-71	0

This is sample C code that implements the external member function and the Object-Type-Translator (OTT)-generated struct definitions:

```
#include <oci.h>

struct PERSON
{
    OCIStrng    *NAME;
    OCIDate     B_DATE;
};
typedef struct PERSON PERSON;

struct PERSON_ind
{
    OCIInd     _atomic;
    OCIInd     NAME;
    OCIInd     B_DATE;
};
typedef struct PERSON_ind PERSON_ind;

OCINumber *age (ctx, person_obj, person_obj_ind, tdo, ret_ind)
OCIExtProcContext *ctx;
PERSON          *person_obj;
PERSON_ind      *person_obj_ind;
OCIType         *tdo;
OCIInd          *ret_ind;
{
    sword      err;
    text       errbuf[512];
    OCIEnv     *envh;
    OCISvcCtx  *svch;
    OCIError   *errh;
    OCINumber  *age;
    int        inum = 0;
    sword      status;
```

```

/* get OCI Environment */
err = OCIEExtProcGetEnv( ctx, &envh, &svch, &errh );

/* initialize return age to 0 */
age = (OCINumber *)OCIEExtProcAllocCallMemory(ctx, sizeof(OCINumber));
status = OCINumberFromInt(errh, &inum, sizeof(inum), OCI_NUMBER_SIGNED,
                          age);
if (status != OCI_SUCCESS)
{
    OCIEExtProcRaiseExcp(ctx, (int)1476);
    return (age);
}

/* return NULL if the person object is null or the birthdate is null */
if ( person_obj_ind->_atomic == OCI_IND_NULL ||
    person_obj_ind->B_DATE == OCI_IND_NULL )
{
    *ret_ind = OCI_IND_NULL;
    return (age);
}

/* The actual implementation to calculate the age is left to the reader,
   but an easy way of doing this is a callback of the form:
       select trunc(months_between(sysdate, person_obj->b_date) / 12)
       from DUAL;
*/
*ret_ind = OCI_IND_NOTNULL;
return (age);
}

```

21.9.6.6 BY REFERENCE

In C, you can pass IN scalar parameters by value (the value of the parameter is passed) or by reference (a pointer to the value is passed). When an external procedure expects a pointer to a scalar, specify BY REFERENCE phrase to pass the parameter by reference:

```

CREATE OR REPLACE PROCEDURE findRoot_proc (
    x IN DOUBLE PRECISION)
AS LANGUAGE C
LIBRARY c_utils
NAME "C_findRoot"
PARAMETERS (
    x BY REFERENCE);

```

In this case, the C prototype is:

```
void C_findRoot(double *x);
```

The default (used when there is no PARAMETERS clause) is:

```
void C_findRoot(double x);
```

21.9.6.7 WITH CONTEXT

By including the WITH CONTEXT clause, you can give an external procedure access to information about parameters, exceptions, memory allocation, and the user environment. The WITH CONTEXT clause specifies that a context pointer is passed to the external procedure. For example, if you write this PL/SQL function:

```

CREATE OR REPLACE FUNCTION getNum_func (
    x IN REAL)

```

```
RETURN PLS_INTEGER AS LANGUAGE C
  LIBRARY c_utils
  NAME "C_getNum"
  WITH CONTEXT
  PARAMETERS (
    CONTEXT,
    x BY REFERENCE,
    RETURN INDICATOR);
```

The C prototype is:

```
int C_getNum(
  OCIExtProcContext *with_context,
  float *x,
  short *retind);
```

The context data structure is opaque to the external procedure; but, is available to service procedures called by the external procedure.

If you also include the `PARAMETERS` clause, then you must specify the parameter `CONTEXT`, which shows the position of the context pointer in the parameter list. If you omit the `PARAMETERS` clause, then the context pointer is the first parameter passed to the external procedure.

21.9.6.8 Interlanguage Parameter Mode Mappings

PL/SQL supports the `IN`, `IN OUT`, and `OUT` parameter modes, and the `RETURN` clause for procedures returning values.

21.10 Running External Procedures with CALL Statements

Now that you have published your Java class method or external C procedure, you are ready to call it.

Do not call an external procedure directly. Instead, use the `CALL` statement to call the PL/SQL procedure that published the external procedure. See [CALL Statement Syntax](#) (page 21-32).

Such calls, which you code in the same manner as a call to a regular PL/SQL procedure, can appear in:

- Anonymous blocks
- Standalone and package procedures
- Methods of an object type
- Database triggers
- SQL statements (calls to package functions only).

Any PL/SQL block or procedure running on the server side, or on the client side, (for example, in a tool such as Oracle Forms) can call an external procedure. On the server side, the external procedure runs in a separate process address space, which safeguards your database. [Figure 21-1](#) (page 21-31) shows how Oracle Database and external procedures interact.

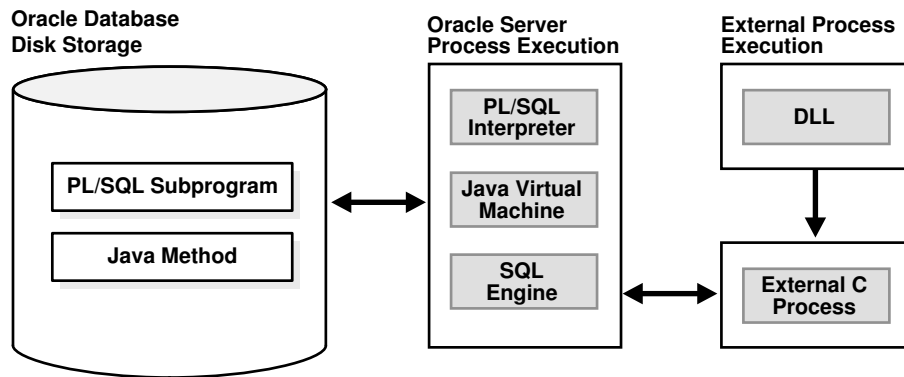
Figure 21-1 Oracle Database and External Procedures**Topics:**

- [Preconditions for External Procedures](#) (page 21-31)
- [CALL Statement Syntax](#) (page 21-32)
- [Calling Java Class Methods](#) (page 21-32)
- [Calling External C Procedures](#) (page 21-33)

21.10.1 Preconditions for External Procedures

Before calling external procedures, consider the privileges, permissions, and synonyms that exist in the execution environment.

Topics:

- [Privileges of External Procedures](#) (page 21-31)
- [Managing Permissions](#) (page 21-31)
- [Creating Synonyms for External Procedures](#) (page 21-32)

21.10.1.1 Privileges of External Procedures

When external procedures are called through `CALL` specifications, they run with definer's privileges, rather than invoker privileges.

A program running with invoker privileges is not bound to a particular schema. It runs at the calling site and accesses database items (such as tables and views) with the caller's visibility and permissions. However, a program running with definer's privileges is bound to the schema in which it is defined. It runs at the defining site, in the definer's schema, and accesses database items with the definer's visibility and permissions.

21.10.1.2 Managing Permissions

To call an external procedure, a user must have the `EXECUTE` privilege on its call specification. To grant this privilege, use the SQL statement `GRANT` (described in *Oracle Database SQL Language Reference*). For example, this statement allows the user johndoe to call the external procedure whose call specification is `plsToJ_demoExternal_proc`:

```
GRANT EXECUTE ON plsToJ_demoExternal_proc TO johndoe;
```

Grant the `EXECUTE` privilege on a call specification only to users who must call the procedure.

21.10.1.3 Creating Synonyms for External Procedures

For convenience, you or your DBA can create synonyms for external procedures using the `CREATE PUBLIC SYNONYM` statement. In this example, your DBA creates a public synonym, which is accessible to all users. If `PUBLIC` is not specified, then the synonym is private and accessible only within its schema.

```
CREATE PUBLIC SYNONYM Rfac FOR johndoe.RecursiveFactorial;
```

21.10.2 CALL Statement Syntax

Call the external procedure through the SQL `CALL` statement. You can run the `CALL` statement interactively from SQL*Plus. The syntax is:

```
CALL [schema.][{object_type_name | package_name}]procedure_name[@dblink_name]
[(parameter_list)] [INTO :host_variable][INDICATOR][:indicator_variable];
```

This is equivalent to running a procedure `myproc` using a SQL statement of the form "`SELECT myproc (...) FROM DUAL,`" except that the overhead associated with performing the `SELECT` is not incurred.

For example, here is an anonymous PL/SQL block that uses dynamic SQL to call `plsToC_demoExternal_proc`, which you published. PL/SQL passes three parameters to the external C procedure `C_demoExternal_proc`.

```
DECLARE
  xx NUMBER(4);
  yy VARCHAR2(10);
  zz DATE;
BEGIN
  EXECUTE IMMEDIATE
  'CALL plsToC_demoExternal_proc(:xxx, :yyy, :zzz)' USING xx,yy,zz;
END;
```

The semantics of the `CALL` statement are identical to the that of an equivalent `BEGIN END` block.

Note:

`CALL` is the only SQL statement that cannot be put, by itself, in a PL/SQL `BEGIN END` block. It can be part of an `EXECUTE IMMEDIATE` statement within a `BEGIN END` block.

21.10.3 Calling Java Class Methods

To call the `J_calcFactorial` class method published in [Publishing Java Class Methods](#) (page 21-12):

1. Declare and initialize two SQL*Plus host variables:

```
VARIABLE x NUMBER
VARIABLE y NUMBER
EXECUTE :x := 5;
```

2. Call `J_calcFactorial`:

```
CALL J_calcFactorial(:x) INTO :y;
PRINT y
```

Result:

```
Y
-----
120
```

21.10.4 Calling External C Procedures

To call an external C procedure, PL/SQL must find the path of the appropriate DLL. The PL/SQL engine retrieves the path from the data dictionary, based on the library alias from the `AS LANGUAGE` clause of the procedure declaration.

Next, PL/SQL alerts a Listener process which, in turn, spawns a session-specific agent. By default, this agent is named `extproc`, although you can specify other names in the `listener.ora` file. The Listener hands over the connection to the agent, and PL/SQL passes to the agent the name of the DLL, the name of the external procedure, and any parameters.

Then, the agent loads the DLL and runs the external procedure. Also, the agent handles service calls (such as raising an exception) and callbacks to Oracle Database. Finally, the agent passes to PL/SQL any values returned by the external procedure.

Note:

Although some DLL caching takes place, your DLL might not remain in the cache; therefore, do not store global variables in your DLL.

After the external procedure completes, the agent remains active throughout your Oracle Database session; when you log off, the agent is stopped. Consequently, you incur the cost of launching the agent only once, no matter how many calls you make. Still, call an external procedure only when the computational benefits outweigh the cost.

Here, you call PL/SQL function `plsCallsCdivisor_func`, which you published in [Publishing External C Procedures](#) (page 21-13), from an anonymous block. PL/SQL passes the two integer parameters to external function `Cdivisor_func`, which returns their greatest common divisor.

```
DECLARE
  g   PLS_INTEGER;
  a   PLS_INTEGER;
  b   PLS_INTEGER;
CALL plsCallsCdivisor_func(a, b);
IF g IN (2,4,8) THEN ...
```

21.11 Handling Errors and Exceptions in Multilanguage Programs

The PL/SQL compiler raises compile-time exceptions if an `AS EXTERNAL` call specification is found in a `TYPE` or `PACKAGE` specification.

C programs can raise exceptions through the `OCIExtproc` functions.

21.12 Using Service Routines with External C Procedures

When called from an external procedure, a **service routine** can raise exceptions, allocate memory, and call OCI handles for callbacks to the server. To use a service routine, you must specify the `WITH CONTEXT` clause, which lets you pass a context structure to the external procedure. The context structure is declared in header file `ociextp.h` as follows:

```
typedef struct OCIExtProcContext OCIExtProcContext;
```

Note:

`ociextp.h` is located in `$ORACLE_HOME/plsql/public` on Linux and UNIX.

Service procedures:

- [OCIExtProcAllocCallMemory](#) (page 21-34)
- [OCIExtProcRaiseExcp](#) (page 21-38)
- [OCIExtProcRaiseExcpWithMsg](#) (page 21-39)

21.12.1 OCIExtProcAllocCallMemory

The `OCIExtProcAllocCallMemory` service routine allocates *n* bytes of memory for the duration of the external procedure call. Any memory allocated by the function is freed automatically as soon as control returns to PL/SQL.

Note:

Do not have the external procedure call the C function `free` to free memory allocated by this service routine, as this is handled automatically.

The C prototype for this function is as follows:

```
dvoid *OCIExtProcAllocCallMemory(
    OCIExtProcContext *with_context,
    size_t amount);
```

The parameters `with_context` and `amount` are the context pointer and number of bytes to allocate, respectively. The function returns an untyped pointer to the allocated memory. A return value of zero indicates failure.

In SQL*Plus, suppose you publish external function `plsToC_concat_func`, as follows:

```
CREATE OR REPLACE FUNCTION plsToC_concat_func (
    str1 IN VARCHAR2,
    str2 IN VARCHAR2)
RETURN VARCHAR2 AS LANGUAGE C
NAME "concat"
LIBRARY stringlib
WITH CONTEXT
PARAMETERS (
```



```

CONTEXT,
str1  STRING,
str1  INDICATOR short,
str2  STRING,
str2  INDICATOR short,
RETURN INDICATOR short,
RETURN LENGTH short,
RETURN STRING);

```

When called, `C_concat` concatenates two strings, then returns the result:

```

select plsToC_concat_func('hello ', 'world') from DUAL;
PLSTOC_CONCAT_FUNC('HELLO','WORLD')
-----

```

```
hello world
```

If either string is `NULL`, the result is also `NULL`. As this example shows, `C_concat` uses `OCIExtProcAllocCallMemory` to allocate memory for the result string:

```

#include <stdio.h>
#include <stdlib.h>
#include <string.h>
#include <oci.h>
#include <ociextp.h>

char *concat(ctx, str1, str1_i, str2, str2_i, ret_i, ret_l)
OCIExtProcContext *ctx;
char *str1;
short str1_i;
char *str2;
short str2_i;
short *ret_i;
short *ret_l;
{
    char *tmp;
    short len;
    /* Check for null inputs. */
    if ((str1_i == OCI_IND_NULL) || (str2_i == OCI_IND_NULL))
    {
        *ret_i = (short)OCI_IND_NULL;
        /* PL/SQL has no notion of a NULL ptr, so return a zero-byte string. */
        tmp = OCIExtProcAllocCallMemory(ctx, 1);
        tmp[0] = '\0';
        return(tmp);
    }
    /* Allocate memory for result string, including NULL terminator. */
    len = strlen(str1) + strlen(str2);
    tmp = OCIExtProcAllocCallMemory(ctx, len + 1);

    strcpy(tmp, str1);
    strcat(tmp, str2);

    /* Set NULL indicator and length. */
    *ret_i = (short)OCI_IND_NOTNULL;
    *ret_l = len;
    /* Return pointer, which PL/SQL frees later. */
    return(tmp);
}

#ifdef LATER
static void checkerr (/*_ OCIError *errhp, sword status _*/);

```

```
void checkerr(errhp, status)
OCIError *errhp;
sword status;
{
    text errbuf[512];
    sb4 errcode = 0;

    switch (status)
    {
        case OCI_SUCCESS:
            break;
        case OCI_SUCCESS_WITH_INFO:
            (void) printf("Error - OCI_SUCCESS_WITH_INFO\n");
            break;
        case OCI_NEED_DATA:
            (void) printf("Error - OCI_NEED_DATA\n");
            break;
        case OCI_NO_DATA:
            (void) printf("Error - OCI_NODATA\n");
            break;
        case OCI_ERROR:
            (void) OCIErrorGet((dvoid *)errhp, (ub4) 1, (text *) NULL, &errcode,
                               errbuf, (ub4) sizeof(errbuf), OCI_HTYPE_ERROR);
            (void) printf("Error - %.*s\n", 512, errbuf);
            break;
        case OCI_INVALID_HANDLE:
            (void) printf("Error - OCI_INVALID_HANDLE\n");
            break;
        case OCI_STILL_EXECUTING:
            (void) printf("Error - OCI_STILL_EXECUTE\n");
            break;
        case OCI_CONTINUE:
            (void) printf("Error - OCI_CONTINUE\n");
            break;
        default:
            break;
    }
}

char *concat(ctx, str1, str1_i, str2, str2_i, ret_i, ret_l)
OCIExtProcContext *ctx;
char *str1;
short str1_i;
char *str2;
short str2_i;
short *ret_i;
short *ret_l;
{
    char *tmp;
    short len;
    /* Check for null inputs. */
    if ((str1_i == OCI_IND_NULL) || (str2_i == OCI_IND_NULL))
    {
        *ret_i = (short)OCI_IND_NULL;
        /* PL/SQL has no notion of a NULL ptr, so return a zero-byte string. */
        tmp = OCIExtProcAllocCallMemory(ctx, 1);
        tmp[0] = '\0';
        return(tmp);
    }
    /* Allocate memory for result string, including NULL terminator. */
    len = strlen(str1) + strlen(str2);
```

```

tmp = OCIExtProcAllocCallMemory(ctx, len + 1);

strcpy(tmp, str1);
strcat(tmp, str2);

/* Set NULL indicator and length. */
*ret_i = (short)OCI_IND_NOTNULL;
*ret_l = len;
/* Return pointer, which PL/SQL frees later. */
return(tmp);
}

/*=====*/
int main(char *argv, int argc)
{
OCIExtProcContext *ctx;
char *str1;
short str1_i;
char *str2;
short str2_i;
short *ret_i;
short *ret_l;
/* OCI Handles */
OCIEnv *envhp;
OCIserver *srvhp;
OCISvcCtx *svchp;
OCIError *errhp;
OCIsession *authp;
OCIStmt *stmthp;
OCIlobLocator *clob, *blob;
OCIlobLocator *lob_loc;

/* Initialize and Logon */
(void) OCIInitialize((ub4) OCI_DEFAULT, (dvoid *)0,
                    (dvoid * (*)(dvoid *, size_t)) 0,
                    (dvoid * (*)(dvoid *, dvoid *, size_t))0,
                    (void (*)(dvoid *, dvoid *)) 0 );

(void) OCIEnvInit( (OCIEnv **) &envhp,
                  OCI_DEFAULT, (size_t) 0,
                  (dvoid **) 0 );

(void) OCIHandleAlloc( (dvoid *) envhp, (dvoid **) &errhp, OCI_HTYPE_ERROR,
                      (size_t) 0, (dvoid **) 0);

/* Server contexts */
(void) OCIHandleAlloc( (dvoid *) envhp, (dvoid **) &srvhp, OCI_HTYPE_SERVER,
                      (size_t) 0, (dvoid **) 0);

/* Service context */
(void) OCIHandleAlloc( (dvoid *) envhp, (dvoid **) &svchp, OCI_HTYPE_SVCCTX,
                      (size_t) 0, (dvoid **) 0);

/* Attach to Oracle Database */
(void) OCIserverAttach( srvhp, errhp, (text *)"", strlen(""), 0);

/* Set attribute server context in the service context */
(void) OCIAttrSet ((dvoid *) svchp, OCI_HTYPE_SVCCTX,
                  (dvoid *)srvhp, (ub4) 0,
                  OCI_ATTR_SERVER, (OCIError *) errhp);

```

```

(void) OCIHandleAlloc((dvoid *) envhp,
                    (dvoid **)&authp, (ub4) OCI_HTYPE_SESSION,
                    (size_t) 0, (dvoid **) 0);

(void) OCIAttrSet((dvoid *) authp, (ub4) OCI_HTYPE_SESSION,
                (dvoid *) "samp", (ub4)4,
                (ub4) OCI_ATTR_USERNAME, errhp);

(void) OCIAttrSet((dvoid *) authp, (ub4) OCI_HTYPE_SESSION,
                (dvoid *) "password", (ub4) 4,
                (ub4) OCI_ATTR_PASSWORD, errhp);

/* Begin a User Session */
checkerr(errhp, OCISessionBegin ( svchp, errhp, authp, OCI_CRED_RDBMS,
                                (ub4) OCI_DEFAULT));

(void) OCIAttrSet((dvoid *) svchp, (ub4) OCI_HTYPE_SVCCTX,
                (dvoid *) authp, (ub4) 0,
                (ub4) OCI_ATTR_SESSION, errhp);

/* -----User Logged In-----*/
printf ("user logged in \n");

/* allocate a statement handle */
checkerr(errhp, OCIHandleAlloc( (dvoid *) envhp, (dvoid **) &stmthp,
                                OCI_HTYPE_STMT, (size_t) 0, (dvoid **) 0));

checkerr(errhp, OCIDescriptorAlloc((dvoid *)envhp, (dvoid **) &Lob_loc,
                                (ub4) OCI_DTYPE_LOB,
                                (size_t) 0, (dvoid **) 0));

/* ----- subprogram called here-----*/
printf ("calling concat...\n");
concat(ctx, str1, str1_i, str2, str2_i, ret_i, ret_l);

return 0;
}

#endif

```

21.12.2 OCIExtProcRaiseExcp

The `OCIExtProcRaiseExcp` service routine raises a predefined exception, which must have a valid Oracle Database error number in the range 1..32,767. After doing any necessary cleanup, your external procedure must return immediately. (No values are assigned to OUT or IN OUT parameters.) The C prototype for this function follows:

```

int OCIExtProcRaiseExcp(
    OCIExtProcContext *with_context,
    size_t errnum);

```

The parameters `with_context` and `error_number` are the context pointer and Oracle Database error number. The return values `OCIEXTPROC_SUCCESS` and `OCIEXTPROC_ERROR` indicate success or failure.

In SQL*Plus, suppose you publish external procedure `plsTo_divide_proc`, as follows:

```

CREATE OR REPLACE PROCEDURE plsTo_divide_proc (
    dividend IN PLS_INTEGER,
    divisor  IN PLS_INTEGER,

```

```

    result OUT FLOAT)
AS LANGUAGE C
NAME "C_divide"
LIBRARY MathLib
WITH CONTEXT
PARAMETERS (
    CONTEXT,
    dividend INT,
    divisor INT,
    result FLOAT);

```

When called, `C_divide` finds the quotient of two numbers. As this example shows, if the divisor is zero, `C_divide` uses `OCIExtProcRaiseExcp` to raise the predefined exception `ZERO_DIVIDE`:

```

void C_divide (ctx, dividend, divisor, result)
OCIExtProcContext *ctx;
int dividend;
int divisor;
float *result;
{
    /* Check for zero divisor. */
    if (divisor == (int)0)
    {
        /* Raise exception ZERO_DIVIDE, which is Oracle Database error 1476. */
        if (OCIExtProcRaiseExcp(ctx, (int)1476) == OCIEXTPROC_SUCCESS)
        {
            return;
        }
        else
        {
            /* Incorrect parameters were passed. */
            assert(0);
        }
    }
    *result = (float)dividend / (float)divisor;
}

```

21.12.3 OCIExtProcRaiseExcpWithMsg

The `OCIExtProcRaiseExcpWithMsg` service routine raises a user-defined exception and returns a user-defined error message. The C prototype for this function follows:

```

int OCIExtProcRaiseExcpWithMsg(
    OCIExtProcContext *with_context,
    size_t error_number,
    text *error_message,
    size_t len);

```

The parameters `with_context`, `error_number`, and `error_message` are the context pointer, Oracle Database error number, and error message text. The parameter `len` stores the length of the error message. If the message is a null-terminated string, then `len` is zero. The return values `OCIEXTPROC_SUCCESS` and `OCIEXTPROC_ERROR` indicate success or failure.

In the previous example, you published external procedure `plsTo_divide_proc`. In this example, you use a different implementation. With this version, if the divisor is zero, then `C_divide` uses `OCIExtProcRaiseExcpWithMsg` to raise a user-defined exception:

```
void C_divide (ctx, dividend, divisor, result)
OCIExtProcContext *ctx;
int    dividend;
int    divisor;
float  *result;
    /* Check for zero divisor. */
    if (divisor == (int)0)
    {
        /* Raise a user-defined exception, which is Oracle Database error 20100,
           and return a null-terminated error message. */
        if (OCIExtProcRaiseExcpWithMsg(ctx, (int)20100,
            "divisor is zero", 0) == OCIEXTPROC_SUCCESS)
        {
            return;
        }
    }
    else
    {
        /* Incorrect parameters were passed. */
        assert(0);
    }
    }
    *result = dividend / divisor;
}
```

21.13 Doing Callbacks with External C Procedures

To enable callbacks, use the function `OCIExtProcGetEnv`.

Topics:

- [OCIExtProcGetEnv](#) (page 21-40)
- [Object Support for OCI Callbacks](#) (page 21-42)
- [Restrictions on Callbacks](#) (page 21-42)
- [Debugging External C Procedures](#) (page 21-43)
- [Example: Calling an External C Procedure](#) (page 21-44)
- [Global Variables in External C Procedures](#) (page 21-44)
- [Static Variables in External C Procedures](#) (page 21-44)
- [Restrictions on External C Procedures](#) (page 21-45)

21.13.1 OCIExtProcGetEnv

The `OCIExtProcGetEnv` service routine enables OCI callbacks to the database during an external procedure call. The environment handles obtained by using this function reuse the existing connection to go back to the database. If you must establish a new connection to the database, you cannot use these handles; instead, you must create your own.

The C prototype for this function follows:

```
sword OCIExtProcGetEnv ( OCIExtProcContext *with_context,
    OCIEnv envh,
```

```

OCIsvcCtx svch,
OCIError errh )

```

The parameter `with_context` is the context pointer, and the parameters `envh`, `svch`, and `errh` are the OCI environment, service, and error handles, respectively. The return values `OCIEXTPROC_SUCCESS` and `OCIEXTPROC_ERROR` indicate success or failure.

Both external C procedures and Java class methods can call-back to the database to do SQL operations. For a working example, see [Example: Calling an External C Procedure](#) (page 21-44).

Note:

Callbacks are not necessarily a same-session phenomenon; you might run an SQL statement in a different session through `OCIlogon`.

An external C procedure running on Oracle Database can call a service routine to obtain OCI environment and service handles. With the OCI, you can use callbacks to run SQL statements and PL/SQL subprograms, fetch data, and manipulate LOBs. Callbacks and external procedures operate in the same user session and transaction context, and so have the same user privileges.

In SQL*Plus, suppose you run this script:

```

CREATE TABLE Emp_tab (empno NUMBER(10))

CREATE PROCEDURE plsToC_insertIntoEmpTab_proc (
    empno PLS_INTEGER)
AS LANGUAGE C
NAME "C_insertEmpTab"
LIBRARY insert_lib
WITH CONTEXT
PARAMETERS (
    CONTEXT,
    empno LONG);

```

Later, you might call service routine `OCIExtProcGetEnv` from external procedure `plsToC_insertIntoEmpTab_proc`, as follows:

```

#include <stdio.h>
#include <stdlib.h>
#include <oratypes.h>
#include <oci.h> /* includes ociextp.h */
...
void C_insertIntoEmpTab (ctx, empno)
OCIExtProcContext *ctx;
long empno;
{
    OCIEnv *envhp;
    OCIsvcCtx *svchp;
    OCIError *errhp;
    int err;
    ...
    err = OCIExtProcGetEnv(ctx, &envhp, &svchp, &errhp);
    ...
}

```

If you do not use callbacks, you need not include `oci.h`; instead, include `ociextp.h`.

21.13.2 Object Support for OCI Callbacks

To run object-related callbacks from your external procedures, the OCI environment in the `extproc` agent is fully initialized in object mode. You retrieve handles to this environment with the `OCIExtProcGetEnv` procedure.

The object runtime environment lets you use static and dynamic object support provided by OCI. To use static support, use the OTT to generate C structs for the appropriate object types, and then use conventional C code to access the object attributes.

For those objects whose types are unknown at external procedure creation time, an alternative, dynamic, way of accessing objects is first to call `OCIDescribeAny` to obtain attribute and method information about the type. Then, `OCIObjectGetAttr` and `OCIObjectSetAttr` can be called to retrieve and set attribute values.

Because the current external procedure model is stateless, `OCIExtProcGetEnv` must be called in every external procedure that wants to run callbacks, or call `OCIExtProc` service routines. After every external procedure call, the callback mechanism is cleaned up and all OCI handles are freed.

21.13.3 Restrictions on Callbacks

With callbacks, this SQL statements and OCI subprograms are not supported:

- Transaction control statements such as `COMMIT`
- Data definition statements such as `CREATE`
- These object-oriented OCI subprograms:

```
OCIObjectNew
OCIObjectPin
OCIObjectUnpin
OCIObjectPinCountReset
OCIObjectLock
OCIObjectMarkUpdate
OCIObjectUnmark
OCIObjectUnmarkByRef
OCIObjectAlwaysLatest
OCIObjectNotAlwaysLatest
OCIObjectMarkDeleteByRef
OCIObjectMarkDelete
OCIObjectFlush
OCIObjectFlushRefresh
OCIObjectGetTypeRef
OCIObjectGetObjectRef
OCIObjectExists
OCIObjectIsLocked
OCIObjectIsDirtied
OCIObjectIsLoaded
OCIObjectRefresh
OCIObjectPinTable
OCIObjectArrayPin
OCICacheFlush,
OCICacheFlushRefresh,
OCICacheRefresh
OCICacheUnpin
OCICacheFree
OCICacheUnmark
```



```
OCI_CACHE_GET_OBJECTS
OCI_CACHE_REGISTER
```

- Polling-mode OCI subprograms such as `OCI_GET_PIECE_INFO`
- These OCI subprograms:

```
OCI_ENV_INIT
OCI_INITIALIZE
OCI_PASSWORD_CHANGE
OCI_SERVER_ATTACH
OCI_SERVER_DETACH
OCI_SESSION_BEGIN
OCI_SESSION_END
OCI_SVC_CTX_TO_LDA
OCI_TRANS_COMMIT
OCI_TRANS_DETACH
OCI_TRANS_ROLLBACK
OCI_TRANS_START
```

Also, with OCI subprogram `OCI_HANDLE_ALLOC`, these handle types are not supported:

```
OCI_HTYPE_SERVER
OCI_HTYPE_SESSION
OCI_HTYPE_SVCCTX
OCI_HTYPE_TRANS
```

21.13.4 Debugging External C Procedures

Usually, when an external procedure fails, its prototype is faulty. In other words, the prototype does not match the one generated internally by PL/SQL. This can happen if you specify an incompatible C data type. For example, to pass an OUT parameter of type `REAL`, you must specify `float *`. Specifying `float`, `double *`, or any other C data type results in a mismatch.

In such cases, you might get:

```
lost RPC connection to external routine agent
```

This error, which means that `extproc` terminated abnormally because the external procedure caused a core dump. To avoid errors when declaring C prototype parameters, see the preceding tables.

To help you debug external procedures, PL/SQL provides the utility package `DEBUG_EXTPROC`. To install the package, run the script `dbgextp.sql`, which you can find in the PL/SQL demo directory. (For the location of the directory, see your Oracle Database Installation or User's Guide.)

To use the package, follow the instructions in `dbgextp.sql`. Your Oracle Database account must have `EXECUTE` privileges on the package and `CREATE LIBRARY` privileges.

Note:

`DEBUG_EXTPROC` works only on platforms with debuggers that can attach to a running process.

21.13.5 Example: Calling an External C Procedure

Also in the PL/SQL demo directory is the script `extproc.sql`, which demonstrates the calling of an external procedure. The companion file `extproc.c` contains the C source code for the external procedure.

To run the demo, follow the instructions in `extproc.sql`. You must use the `SCOTT` account, which must have `CREATE LIBRARY` privileges.

21.13.6 Global Variables in External C Procedures

A global variable is declared outside of a function, and its value is shared by all functions of a program. Therefore, in external procedures, all functions in a DLL share the value of the global variable. Global variables are also used to store data that is intended to persist beyond the lifetime of a function. However, Oracle discourages the use of global variables for two reasons:

- Threading

In the nonthreaded configuration of the agent process, one function is active at a time. For the multithreaded `extproc` agent, multiple functions can be active at the same time, and they might try to access the global variable concurrently, with unsuccessful results.

- DLL caching

Suppose that function `func1` tries to pass data to function `func2` by storing the data in a global variable. After `func1` completes, the DLL cache might be unloaded, causing all global variables to lose their values. Then, when `func2` runs, the DLL is reloaded, and all global variables are initialized to 0.

21.13.7 Static Variables in External C Procedures

There are two types of static variables: external and internal. An external static variable is a special case of a global variable, so its usage is discouraged. Internal static variables are local to a particular function, but remain in existence rather than coming and going each time the function is activated. Therefore, they provide private, permanent storage within a single function. These variables are used to pass on data to subsequent calls to the same function. But, because of the DLL caching feature mentioned in [Global Variables in External C Procedures](#) (page 21-44), the DLL might be unloaded and reloaded between calls, which means that the internal static variable loses its value.

:

Template `makefile` in the RDBMS subdirectory `/public` for help creating a dynamic link library

When calling external procedures:

- Never write to `IN` parameters or overflow the capacity of `OUT` parameters. (PL/SQL does no runtime checks for these error conditions.)
- Never read an `OUT` parameter or a function result.

- Always assign a value to IN OUT and OUT parameters and to function results. Otherwise, your external procedure will not return successfully.
- If you include the WITH CONTEXT and PARAMETERS clauses, then you must specify the parameter CONTEXT, which shows the position of the context pointer in the parameter list.
- If you include the PARAMETERS clause, and if the external procedure is a function, then you must specify the parameter RETURN in the last position.
- For every formal parameter, there must be a corresponding parameter in the PARAMETERS clause. Also, ensure that the data types of parameters in the PARAMETERS clause are compatible with those in the C prototype, because no implicit conversions are done.
- With a parameter of type RAW or LONG RAW, you must use the property LENGTH. Also, if that parameter is IN OUT or OUT and null, then you must set the length of the corresponding C parameter to zero.

21.13.8 Restrictions on External C Procedures

These restrictions apply to external procedures:

- This feature is available only on platforms that support DLLs.
- Only C procedures and procedures callable from C code are supported.
- External procedure callouts combined with distributed transactions is not supported.
- You cannot pass PL/SQL cursor variables or records to an external procedure. For records, use instances of object types instead.
- In the LIBRARY subclause, you cannot use a database link to specify a remote library.
- The maximum number of parameters that you can pass to a external procedure is 128. However, if you pass float or double parameters by value, then the maximum is less than 128. How much less depends on the number of such parameters and your operating system. To get a rough estimate, count each float or double passed by value as two parameters.

Developing Applications with Oracle XA

Note:

Avoid using XA if possible, for these reasons:

- XA can degrade performance.
- XA can cause in-doubt transactions.
- XA might be unable to take advantage of Oracle Database 12c Release 1 (12.1.0.1) features that enhance the ability of applications to continue after recoverable outages.

It might be possible to avoid using XA even when that seems avoidable (for example, if Oracle and non-Oracle resources must be used in the same transaction).

This chapter explains how to use the Oracle XA library. Typically, you use this library in applications that work with transaction monitors. The XA features are most useful in applications in which transactions interact with multiple databases.

Topics:

- [X/Open Distributed Transaction Processing \(DTP\)](#) (page 22-2)
- [Oracle XA Library Subprograms](#) (page 22-6)
- [Developing and Installing XA Applications](#) (page 22-8)
- [Troubleshooting XA Applications](#) (page 22-21)
- [Oracle XA Issues and Restrictions](#) (page 22-24)

See Also:

- *Distributed TP: The XA Specification*, for an overview of XA, including basic architecture. Access at <https://www2.opengroup.org/ogsys/jsp/publications/PublicationDetails.jsp?publicationid=11144>.
 - *Oracle Call Interface Programmer's Guide* for background and reference information about the Oracle XA library
 - The Oracle Database platform-specific documentation for information about library linking filenames
 - README for changes, bugs, and restrictions in the Oracle XA library for your platform
-
-

22.1 X/Open Distributed Transaction Processing (DTP)

The X/Open Distributed Transaction Processing (DTP) architecture defines a standard architecture or interface that enables multiple application programs (APs) to share resources provided by multiple, and possibly different, resource managers (RMs). It coordinates the work between APs and RMs into global transactions.

The Oracle XA library conforms to the X/Open software architecture's XA interface specification. The Oracle XA library is an external interface that enables a client-side transaction manager (TM) that is not an Oracle client-side TM to coordinate global transactions, thereby allowing inclusion of database RMs that are not Oracle Database RMs in distributed transactions. For example, a client application can manage an Oracle Database transaction and a transaction in an NTFS file system as a single, global transaction.

[Figure 22-1](#) (page 22-3) illustrates a possible X/Open DTP model.

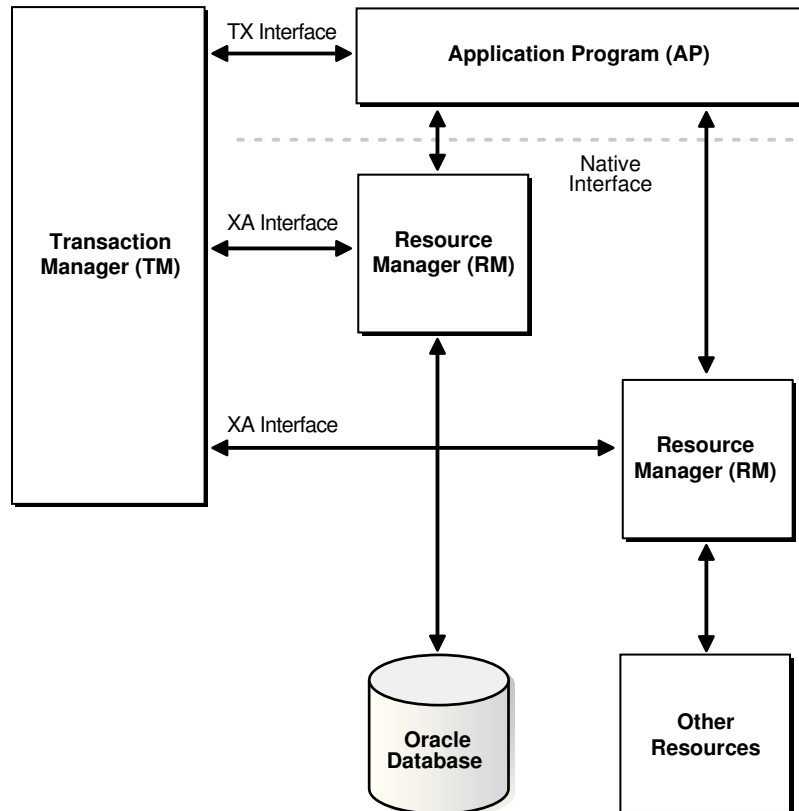
Figure 22-1 Possible DTP Model**Topics:**

- [DTP Terminology](#) (page 22-3)
- [Required Public Information](#) (page 22-5)

22.1.1 DTP Terminology

- [Resource Manager \(RM\)](#) (page 22-4)
- [Distributed Transaction](#) (page 22-4)
- [Branch](#) (page 22-4)
- [Transaction Manager \(TM\)](#) (page 22-4)
- [Transaction Processing Monitor \(TPM\)](#) (page 22-4)
- [Two-Phase Commit Protocol](#) (page 22-4)
- [Application Program \(AP\)](#) (page 22-5)
- [TX Interface](#) (page 22-5)
- [Tight and Loose Coupling](#) (page 22-5)
- [Dynamic and Static Registration](#) (page 22-5)

Resource Manager (RM)

A resource manager controls a shared, recoverable resource that can be returned to a consistent state after a failure. Examples are relational databases, transactional queues, and transactional file systems. Oracle Database is an RM and uses its online redo log and undo segments to return to a consistent state after a failure.

Distributed Transaction

A distributed transaction, also called a **global transaction**, is a client transaction that involves updates to multiple distributed resources and requires "all-or-none" semantics across distributed RMs.

Branch

A branch is a unit of work contained within one RM. Multiple branches comprise a global transaction. For Oracle Database, each branch maps to a local transaction inside the database server.

Transaction Manager (TM)

A transaction manager provides an API for specifying the boundaries of the transaction and manages commit and recovery. The TM implements a two-phase commit engine to provide "all-or-none" semantics across distributed RMs.

An **external TM** is a middle-tier component that resides outside Oracle Database. Normally, the database is its own internal TM. Using a standards-based TM enables Oracle Database to cooperate with other heterogeneous RMs in a single transaction.

Transaction Processing Monitor (TPM)

A TM is usually provided by a transaction processing monitor (TPM), such as:

- Oracle Tuxedo
- IBM Transarc Encina
- IBM CICS

A TPM coordinates the flow of transaction requests between the client processes that issue requests and the back-end servers that process them. Basically, a TPM coordinates transactions that require the services of several different types of back-end processes, such as application servers and RMs distributed over a network.

The TPM synchronizes any commits or rollbacks required to complete a distributed transaction. The TM portion of the TPM is responsible for controlling when distributed commits and rollbacks take place. Thus, if a distributed application program takes advantage of a TPM, then the TM portion of the TPM is responsible for controlling the two-phase commit protocol. The RMs enable the TMs to perform this task.

Because the TM controls distributed commits or rollbacks, it must communicate directly with Oracle Database (or any other RM) through the XA interface. It uses Oracle XA library subprograms, which are described in "[Oracle XA Library Subprograms](#) (page 22-6)", to tell Oracle Database how to process the transaction, based on its knowledge of all RMs in the transaction.

Two-Phase Commit Protocol

The Oracle XA library interface follows the two-phase commit protocol. The sequence of events is as follows:

1. In the prepare phase, the TM asks each RM to guarantee that it can commit any part of the transaction. If this is possible, then the RM records its prepared state and replies affirmatively to the TM. If it is not possible, then the RM might roll back any work, reply negatively to the TM, and forget about the transaction. The protocol allows the application, or any RM, to roll back the transaction unilaterally until the prepare phase completes.
2. In phase two, the TM records the commit decision and issues a commit or rollback to all RMs participating in the transaction. TM can issue a commit for an RM only if all RMs have replied affirmatively to phase one.

Application Program (AP)

An application program defines transaction boundaries and specifies actions that constitute a transaction. For example, an AP can be a precompiler or Oracle Call Interface (OCI) program. The AP operates on the RM resource through its native interface, for example, SQL.

TX Interface

An application program starts and completes all transaction control operations through the TM through an interface called TX. The AP does not directly use the XA interface. APs are not aware of branches that fork in the middle-tier: application threads do not explicitly join, leave, suspend, and resume branch work, instead the TM portion of the transaction processing monitor manages the branches of a global transaction for APs. Ultimately, APs call the TM to commit all-or-none.

Note:

The naming conventions for the TX interface and associated subprograms are vendor-specific. For example, the `tx_open` call might be referred to as `tp_open` on your system. In some cases, the calls might be implicit, for example, at the entry to a transactional RPC. See the documentation supplied with the transaction processing monitor for details.

Tight and Loose Coupling

Application threads are **tightly coupled** if the RM considers them as a single entity for all isolation semantic purposes. Tightly coupled branches must see changes in each other. Furthermore, an external client must either see all changes of a tightly coupled set or none of the changes. If application threads are not tightly coupled, then they are **loosely coupled**.

Dynamic and Static Registration

Oracle Database supports both dynamic and static registration. In **dynamic registration**, the RM runs an application callback before starting any work. In **static registration**, you must call `xa_start` for each RM before starting any work, even if some RMs are not involved.

22.1.2 Required Public Information

As a resource manager, Oracle Database must publish the information described in [Table 22-1](#) (page 22-6).

Table 22-1 Required XA Features Published by Oracle Database

XA Feature	Oracle Database Details
xa_switch_t structures	The Oracle Database xa_switch_t structure name is xaosw for static registration and xaoswd for dynamic registration. These structures contain entry points and other information for the resource manager.
xa_switch_t resource manager	The Oracle Database resource manager name within the xa_switch_t structure is Oracle_XA.
Close string	The close string used by xa_close is ignored and can be null.
Open string	For the description of the format of the open string that xa_open uses, see Defining the xa_open String (page 22-9).
Libraries	Libraries needed to link applications using Oracle XA have platform-specific names. The procedure is similar to linking an ordinary precompiler or OCI program except that you might have to link any TPM-specific libraries. If you are not using Precompilers (such as Pro*C/C++, Pro*COBOL, and others), then link with \$ORACLE_HOME/rdbms/lib/xaons1.o or \$ORACLE_HOME/rdbms/lib32/xaons1.o (for 32 bit application on 64 bit platforms).
Requirements	None. The functionality to support XA is part of both Standard Edition and Enterprise Edition.

22.2 Oracle XA Library Subprograms

The Oracle XA library subprograms enable a TM to tell Oracle Database how to process transactions. Generally, the TM must open the resource by using xa_open. Typically, the opening of the resource results from the AP call to tx_open. Some TMs might call xa_open implicitly when the application begins.

Similarly, there is a close (using xa_close) that occurs when the application is finished with the resource. The close might occur when the AP calls tx_close or when the application terminates.

The TM instructs the RMs to perform several other tasks, which include:

- Starting a transaction and associating it with an ID
- Rolling back a transaction
- Preparing and committing a transaction

Topics:

- [Oracle XA Library Subprograms](#) (page 22-6)
- [Oracle XA Interface Extensions](#) (page 22-7)

22.2.1 Oracle XA Library Subprograms

XA Library subprograms are described in [Table 22-2](#) (page 22-7).

Table 22-2 XA Library Subprograms

XA Subprogram	Description
<code>xa_open</code>	Connects to the RM.
<code>xa_close</code>	Disconnects from the RM.
<code>xa_start</code>	Starts a transaction and associates it with the given transaction ID (XID), or associates the process with an existing transaction.
<code>xa_end</code>	Disassociates the process from the given XID.
<code>xa_rollback</code>	Rolls back the transaction associated with the given XID.
<code>xa_prepare</code>	Prepares the transaction associated with the given XID. This is the first phase of the two-phase commit protocol.
<code>xa_commit</code>	Commits the transaction associated with the given XID. This is the second phase of the two-phase commit protocol.
<code>xa_recover</code>	Retrieves a list of prepared, heuristically committed, or heuristically rolled back transactions.
<code>xa_forget</code>	Forgets the heuristically completed transaction associated with the given XID.

In general, the AP need not worry about the subprograms in [Table 22-2](#) (page 22-7) except to understand the role played by the `xa_open` string.

22.2.2 Oracle XA Interface Extensions

Oracle Database's XA interface includes some additional functions, which are described in [Table 22-3](#) (page 22-7).

Table 22-3 Oracle XA Interface Extensions

Function	Description
<code>OCISvcCtx *xaoSvcCtx(text *dbname)</code>	Returns the OCI service handle for a given XA connection. The <code>dbname</code> parameter must be the same as the <code>DB</code> parameter passed in the <code>xa_open</code> string. OCI applications can use this routing instead of the <code>sqlld2</code> calls to obtain the connection handle. Hence, OCI applications need not link with the <code>sqllib</code> library. The service handle can be converted to the Version 7 OCI logon data area (LDA) by using <code>OCISvcCtxToLda</code> [Version 8 OCI]. Client applications must remember to convert the Version 7 LDA to a service handle by using <code>OCILdaToSvcCtx</code> after completing the OCI calls.
<code>OCIEnv *xaoEnv(text *dbname)</code>	Returns the OCI environment handle for a given XA connection. The <code>dbname</code> parameter must be the same as the <code>DB</code> parameter passed in the <code>xa_open</code> string.

Table 22-3 (Cont.) Oracle XA Interface Extensions

Function	Description
<code>int xaosterr(OCISvcCtx *SvcCtx, sb4 error)</code>	Converts an Oracle Database error code to an XA error code (applicable only to dynamic registration). The first parameter is the service handle used to run the work in the database. The second parameter is the error code that was returned from Oracle Database. Use this function to determine if the error returned from an OCI statement was caused because the <code>xa_start</code> failed. The function returns <code>XA_OK</code> if the error was not generated by the XA module or a valid XA error if the error was generated by the XA module.

22.3 Developing and Installing XA Applications

This section explains how to develop and install Oracle XA applications:

- [DBA or System Administrator Responsibilities](#) (page 22-8)
- [Application Developer Responsibilities](#) (page 22-9)
- [Defining the xa_open String](#) (page 22-9)
- [Developing and Installing XA Applications](#) (page 22-8)
- [Managing Transaction Control with Oracle XA](#) (page 22-15)
- [Migrating Precompiler or OCI Applications to TPM Applications](#) (page 22-17)
- [Managing Oracle XA Library Thread Safety](#) (page 22-18)
- [Using the DBMS_XA Package](#) (page 22-19)

22.3.1 DBA or System Administrator Responsibilities

The responsibilities of the DBA or system administrator are:

1. Define the open string, with help from the application developer. For details, see [Defining the xa_open String](#) (page 22-9).
2. Ensure that the static data dictionary view `DBA_PENDING_TRANSACTIONS` exists and grant the `READ` or `SELECT` privilege to the view for all Oracle users specified in the `xa_open` string.

Grant `FORCE TRANSACTION` privilege to the Oracle user who might commit or roll back pending (in-doubt) transactions that he or she created, using the command `COMMIT FORCE local_tran_id` or `ROLLBACK FORCE local_tran_id`.

Grant `FORCE ANY TRANSACTION` privilege to the Oracle user who might commit or roll back XA transactions created by other users. For example, if user A might commit or roll back a transaction that was created by user B, user A must have `FORCE ANY TRANSACTION` privilege.

In Oracle Database version 7 client applications, all Oracle Database accounts used by Oracle XA library must have the `SELECT` privilege on the dynamic performance view `V$XATRANS$`. This view must have been created during the XA library

installation. If necessary, you can manually create the view by running the SQL script `xaview.sql` as Oracle Database user `SYS`.

See Also:

Your Oracle Database platform-specific documentation for the location of the `catxpend.sql` script

3. Using the open string information, install the RM into the TPM configuration. Follow the TPM vendor instructions.

The DBA or system administrator must be aware that a TPM system starts the process that connects to Oracle Database. See your TPM documentation to determine what environment exists for the process and what user ID it must have. Ensure that correct values are set for `$ORACLE_HOME` and `$ORACLE_SID` in this environment.

4. Grant the user ID write permission to the directory in which the system is to write the XA trace file.

See Also:

[Defining the xa_open String](#) (page 22-9), for information about how to specify an Oracle System Identifier (SID) or a trace directory that is different from the defaults

5. Start the relevant database instances to bring Oracle XA applications on-line. Perform this task before starting any TPM servers.

22.3.2 Application Developer Responsibilities

The responsibilities of the application developer are:

1. Define the open string with help from the DBA or system administrator, as explained in [Defining the xa_open String](#) (page 22-9)..
2. Develop the applications.

Observe special restrictions on transaction-oriented SQL statements for precompilers.

See Also:

[Developing and Installing XA Applications](#) (page 22-8)

3. Link the application according to TPM vendor instructions.

22.3.3 Defining the xa_open String

The open string is used by the transaction monitor to open the database. The maximum number of characters in an open string is 256.

Topics:

- [Syntax of the xa_open String](#) (page 22-10)
- [Required Fields for the xa_open String](#) (page 22-10)
- [Optional Fields for the xa_open String](#) (page 22-11)

22.3.3.1 Syntax of the xa_open String

You can define an open string with the syntax shown in [Example 22-1](#) (page 22-10).

These strings shows sample parameter settings:

```
ORACLE_XA+DB=MANAGERS+SqlNet=SID1+ACC=P/username/password
+SesTM=10+LogDir=/usr/local/xalog
ORACLE_XA+DB=PAYROLL+SqlNet=SID2+ACC=P/username/password
+SesTM=10+LogDir=/usr/local/xalog
ORACLE_XA+SqlNet=SID3+ACC=P/username/password
+SesTM=10+LogDir=/usr/local/xalog
```

These topics describe valid parameters for the *required_fields* and *optional_fields* placeholders:

- [Required Fields for the xa_open String](#) (page 22-10)
- [Optional Fields for the xa_open String](#) (page 22-11)

Note:

- You can enter the required fields and optional fields in any order when constructing the open string.
 - All field names are case insensitive. Whether their values are case-sensitive depends on the platform.
 - There is no way to use the plus character (+) as part of the actual information string.
-
-

Example 22-1 xa_open String

```
ORACLE_XA{+required_fields...} [+optional_fields...]
```

22.3.3.2 Required Fields for the xa_open String

The *required_fields* placeholder in [Example 22-1](#) (page 22-10) refers to any of the name-value pairs described in [Table 22-4](#) (page 22-10).

Table 22-4 Required Fields of xa_open string

Syntax Element	Description
Acc=P//	Specifies that no explicit user or password information is provided and that the operating system authentication form is used. For more information see <i>Oracle Database Administrator's Guide</i> .

Table 22-4 (Cont.) Required Fields of xa_open string

Syntax Element	Description
<code>Acc=P/user/password</code>	Specifies the user name and password for a valid Oracle Database account. As described in DBA or System Administrator Responsibilities (page 22-8), ensure that HR has the READ or SELECT privilege on the DBA_PENDING_TRANSACTIONS table.
<code>SesTm=session_time_limit</code>	<p>Specifies the maximum number of seconds allowed in a transaction between one service and the next, or between a service and the commit or rollback of the transaction, before the system terminates the transaction. For example, <code>SesTM=15</code> indicates that the session idle time limit is 15 seconds.</p> <p>For example, if the TPM uses remote subprogram calls between the client and the servers, then <code>SesTM</code> applies to the time between the completion of one RPC and the initiation of the next RPC, or the <code>tx_commit</code>, or the <code>tx_rollback</code>.</p> <p>The value of 0 indicates no limit. Entering a value of 0 is strongly discouraged. It might tie up resources for a long time if something goes wrong. Also, if a child process has <code>SesTM=0</code>, then the <code>SesTM</code> setting is not effective after the parent process is terminated.</p>

22.3.3.3 Optional Fields for the xa_open String

The `optional_fields` placeholder in [Example 22-1](#) (page 22-10) refers to any of the name-value pairs described in [Table 22-5](#) (page 22-11).

Table 22-5 Optional Fields in the xa_open String

Syntax Element	Description
<code>NoLocal= true false</code>	Specifies whether local transactions are allowed. The default value is <code>false</code> . If the application must disallow local transactions, then set the value to <code>true</code> .

Table 22-5 (Cont.) Optional Fields in the xa_open String

Syntax Element	Description
<code>DB=db_name</code>	<p>Specifies the name used by Oracle Database precompilers to identify the database. For example, <code>DB=payroll</code> specifies that the database name is <code>payroll</code> and that the application server program uses that name in AT clauses.</p> <p>Application programs that use only the default database for the Oracle Database precompiler (that is, they do not use the AT clause in their SQL statements) must omit the <code>DB=db_name</code> clause in the open string. Applications that use explicitly named databases must indicate that database name in their <code>DB=db_name</code> field. Oracle Database Version 7 OCI programs must call the <code>sqlld2</code> function to obtain the correct context for logon data area (<code>Lda_Def</code>), which is the equivalent of an OCI service context. Version 8 and higher OCI programs must call the <code>xaoSvcCtx</code> function to get the <code>OCISvcCtx</code> service context. The <code>db_name</code> is not the SID and is not used to locate the database to be opened. Rather, it correlates the database opened by this open string with the name used in the application program to run SQL statements. The SID is set from either the environment variable <code>ORACLE_SID</code> of the TPM application server or the SID given in the Oracle Net clause in the open string. The Oracle Net clause is described later in this section. Some TPM vendors provide a way to name a group of servers that use the same open string. You might find it convenient to choose the same name both for that purpose and for <code>db_name</code>.</p>
<code>LogDir=log_dir</code>	<p>Specifies the path name on the local system where the Oracle XA library error and tracing information is to be logged. The default is <code>\$ORACLE_HOME/rdbms/log</code> if <code>ORACLE_HOME</code> is set; otherwise, it specifies the current directory. For example, <code>LogDir=/xa_trace</code> indicates that the logging information is located under the <code>/xa_trace</code> directory. Ensure that the directory exists and the application server can write to it.</p>
<code>Objects= true false</code>	<p>Specifies whether the application is initialized in object mode. The default value is <code>false</code>. If the application must use certain API calls that require object mode, such as <code>OCIRawAssignBytes</code>, then set the value to <code>true</code>.</p>
<code>MaxCur=maximum_#_of_ open_cursors</code>	<p>Specifies the number of cursors to be allocated when the database is opened. It serves the same purpose as the precompiler option <code>maxopencursors</code>. For example, <code>MaxCur=5</code> indicates that the precompiler tries to keep five open cursors cached. This parameter overrides the precompiler option <code>maxopencursors</code> that you might have specified in your source code or at compile time.</p>

Table 22-5 (Cont.) Optional Fields in the xa_open String

Syntax Element	Description
<code>SqlNet=db_link</code>	Specifies the Oracle Net database link to use to log on to the system. This string must be an entry in <code>tnsnames.ora</code> . For example, the string <code>SqlNet=inst1_disp</code> might connect to a shared server at instance 1 if so defined in <code>tnsnames.ora</code> . You can use the <code>SqlNet</code> parameter to specify the <code>ORACLE_SID</code> in cases where you cannot control the server environment variable. You must also use it when the server must access multiple Oracle Database instances. To use the Oracle Net string without actually accessing a remote database, use the Pipe driver. For example, specify <code>SqlNet=localsid1</code> , where <code>localsid1</code> is an alias defined in the <code>tnsnames.ora</code> file.
<code>Loose_Coupling=true</code> <code>false</code>	Specifies whether locks are shared. Oracle Database transaction branches within the same global transaction can be coupled tightly or loosely. If branches are loosely coupled, then they do not share locks. Set the value to <code>true</code> for loosely coupled branches. If branches are tightly coupled, then they share locks. Set the value to <code>false</code> for tightly coupled branches. The default value is <code>false</code> . Note: When running Oracle RAC, if transaction branches land on different Oracle RAC instances, then they are loosely coupled even if <code>Loose_Coupling=false</code> .
<code>SesWt=session_wait_limit</code>	Specifies the number of seconds Oracle Database waits for a transaction branch that is being used by another session before <code>XA_RETRY</code> is returned. The default value is 60 seconds.
<code>Threads=true</code> <code>false</code>	Specifies whether the application is multithreaded. The default value is <code>false</code> . If the application is multithreaded, then the setting is <code>true</code> .
<code>FAN=true</code> <code>false</code>	Specifies whether the application will use Fast Application Notification (FAN). The default value is <code>false</code> . If the application will use FAN, then the setting is <code>true</code> . For information about FAN, see <i>Oracle Database Administrator's Guide</i> .

22.3.4 Using Oracle XA with Precompilers

When used in an Oracle XA application, cursors are valid only for the duration of the transaction. Explicit cursors must be opened after the transaction begins, and closed before the commit or rollback.

You have these options when interfacing with precompilers:

- [Using Precompilers with the Default Database](#) (page 22-14)
- [Using Precompilers with a Named Database](#) (page 22-14)

The examples in this topic use the precompiler Pro*C/C++.

22.3.4.1 Using Precompilers with the Default Database

To interface to a precompiler with the default database, ensure that the `DB=db_name` field used in the open string is not present. The absence of this field indicates the default connection. Only one default connection is allowed for each process.

This is an example of an open string identifying a default Pro*C/C++ connection:

```
ORACLE_XA+SqlNet=maildb+ACC=P/username/password
+SesTM=10+LogDir=/usr/local/logs
```

The `DB=db_name` is absent, indicating an empty database ID string.

The syntax of a SQL statement is:

```
EXEC SQL UPDATE Emp_tab SET Sal = Sal*1.5;
```

22.3.4.2 Using Precompilers with a Named Database

To interface to a precompiler with a named database, include the `DB=db_name` field in the open string. Any database you refer to must reference the same `db_name` you specified in the corresponding open string.

An application might include the default database and one or more named databases. For example, suppose you want to update an employee's salary in one database, his department number (DEPTNO) in another, and his manager in a third database. Configure the open strings in the transaction manager as shown in [Example 22-2](#) (page 22-14).

Example 22-2 Sample Open String Configuration

```
ORACLE_XA+DB=MANAGERS+SqlNet=SID1+ACC=P/username/password
+SesTM=10+LogDir=/usr/local/xalog
ORACLE_XA+DB=PAYROLL+SqlNet=SID2+ACC=P/username/password
+SesTM=10+LogDir=/usr/local/xalog
ORACLE_XA+SqlNet=SID3+ACC=P/username/password
+SesTM=10+LogDir=/usr/local/xalog
```

There is no `DB=db_name` field in the last open string in [Example 22-2](#) (page 22-14).

In the application server program, enter declarations such as:

```
EXEC SQL DECLARE PAYROLL DATABASE;
EXEC SQL DECLARE MANAGERS DATABASE;
```

Again, the default connection (corresponding to the third open string that does not contain the DB field) needs no declaration.

When doing the update, enter statements similar to these:

```
EXEC SQL AT PAYROLL UPDATE Emp_Tab SET Sal=4500 WHERE Empno=7788;
EXEC SQL AT MANAGERS UPDATE Emp_Tab SET Mgr=7566 WHERE Empno=7788;
EXEC SQL UPDATE Emp_Tab SET Deptno=30 WHERE Empno=7788;
```

There is no `AT` clause in the last statement because it is referring to the default database.

In Oracle Database precompilers release 1.5.3 or later, you can use a character host variable in the `AT` clause, as this example shows:

```
EXEC SQL BEGIN DECLARE SECTION;
DB_NAME1 CHARACTER(10);
DB_NAME2 CHARACTER(10);
```

```
EXEC SQL END DECLARE SECTION;
...
SET DB_NAME1 = 'PAYROLL'
SET DB_NAME2 = 'MANAGERS'
...
EXEC SQL AT :DB_NAME1 UPDATE...
EXEC SQL AT :DB_NAME2 UPDATE...
```

Caution:

Do not have XA applications create connections other than those created through `xa_open`. Work performed on non-XA connections is outside the global transaction and must be committed separately.

22.3.5 Using Oracle XA with OCI

Oracle Call Interface applications that use the Oracle XA library must not call `OCISessionBegin` to log on to the resource manager. Rather, the logon must be done through the TPM. The applications can run the function `xaoSvcCtx` to obtain the service context structure when they must access the resource manager.

In applications that must pass the environment handle to OCI functions, you can also call `xaoEnv` to find that handle.

Because an application server can have multiple concurrent open Oracle Database resource managers, it must call the function `xaoSvcCtx` with the correct arguments to obtain the correct service context.

See Also:

Oracle Call Interface Programmer's Guide

22.3.6 Managing Transaction Control with Oracle XA

When you use the XA library, transactions are not controlled by the SQL statements that commit or roll back transactions. Rather, they are controlled by an API accepted by the TM that starts and stops transactions. You call the API that is provided by the transaction manager, including the TX interface listed in [Table 22-6](#) (page 22-15), but not the XA Library Subprograms listed in [Table 22-2](#) (page 22-7).

The TMs typically control the transactions through the XA interface. This interface includes the functions described in [Table 22-2](#) (page 22-7).

Table 22-6 TX Interface Functions

TX Function	Description
<code>tx_open</code>	Logs into the resource manager(s)
<code>tx_close</code>	Logs out of the resource manager(s)
<code>tx_begin</code>	Starts a transaction
<code>tx_commit</code>	Commits a transaction

Table 22-6 (Cont.) TX Interface Functions

TX Function	Description
tx_rollback	Rolls back the transaction

Most TPM applications use a client/server architecture in which an application client requests services and an application server provides them. The examples shown in ["Examples of Precompiler Applications"](#) (page 22-16) use such a client/server model. A service is a logical unit of work that, for Oracle Database as the resource manager, comprises a set of SQL statements that perform a related unit of work.

For example, when a service named "credit" receives an account number and the amount to be credited, it runs SQL statements to update information in certain tables in the database. Also, a service might request other services. For example, a "transfer fund" service might request services from a "credit" and "debit" service.

Typically, application clients request services from the application servers to perform tasks within a transaction. For some TPM systems, however, the application client itself can offer its own local services. As shown in ["Examples of Precompiler Applications"](#) (page 22-16), you can encode transaction control statements within either the client or the server.

To have multiple processes participating in the same transaction, the TPM provides a communication API that enables transaction information to flow between the participating processes. Examples of communications APIs include RPC, pseudo-RPC functions, and send/receive functions.

Because the leading vendors support different communication functions, these examples use the communication pseudo-function `tpm_service` to generalize the communications API.

X/Open includes several alternative methods for providing communication functions in their preliminary specification. At least one of these alternatives is supported by each of the leading TPM vendors.

22.3.7 Examples of Precompiler Applications

These examples illustrate precompiler applications. Assume that the application server has logged onto the RMs system, in a TPM-specific manner. [Example 22-3](#) (page 22-16) shows a transaction started by an application server.

Example 22-3 Transaction Started by an Application Server

```

/***** Client: *****/
tpm_service("ServiceName");           /*Request Service*/

/***** Server: *****/
ServiceName()
{
  <get service specific data>
  tx_begin();                          /* Begin transaction boundary */
  EXEC SQL UPDATE ...;

  /* This application server temporarily becomes */
  /* a client and requests another service. */

  tpm_service("AnotherService");
  tx_commit();                          /* Commit the transaction */
}

```

```

    <return service status back to the client>
}

```

[Example 22-4](#) (page 22-17) shows a transaction started by an application client.

Example 22-4 Transaction Started by an Application Client

```

/***** Client: *****/
tx_begin();                               /* Begin transaction boundary */
tpm_service("Service1");
tpm_service("Service2");
tx_commit();                               /* Commit the transaction */

/***** Server: *****/
Service1()
{
    <get service specific data>
    EXEC SQL UPDATE ...;
    <return service status back to the client>
}
Service2()
{
    <get service specific data>
    EXEC SQL UPDATE ...;
    ...
    <return service status back to client>
}

```

22.3.8 Migrating Precompiler or OCI Applications to TPM Applications

To migrate existing precompiler or OCI applications to a TPM application that uses the Oracle XA library, you must:

1. Reorganize the application into a framework of "services" so that application clients request services from application servers. Some TPMs require the application to use the `tx_open` and `tx_close` functions, whereas other TPMs do the logon and logoff implicitly.

If you do not specify the `SqlNet` parameter in your open string, then the application uses the default Oracle Net driver. Thus, ensure that the application server is brought up with the `ORACLE_HOME` and `ORACLE_SID` environment variables properly defined. This is accomplished in a TPM-specific fashion. See your TPM vendor documentation for instructions on how to accomplish this.

2. Ensure that the application replaces the regular connect and disconnect statements. For example, replace the connect statements `EXEC SQL CONNECT` (for precompilers) or `OCISessionBegin`, `OCIServerAttach`, and `OCIEnvCreate` (for OCI) with `tx_open`. Replace the disconnect statements `EXEC SQL COMMIT/ROLLBACK WORK RELEASE` (for precompilers) or `OCISessionEnd/OCIServerDetach` (for OCI) with `tx_close`.
3. Ensure that the application replaces the regular commit or rollback statements for any global transactions and begins the transaction explicitly.

For example, replace the `COMMIT/ROLLBACK` statements `EXEC SQL COMMIT/ROLLBACK WORK` (for precompilers), or `OCITransCommit/OCITransRollback` (for OCI) with `tx_commit/tx_rollback` and start the transaction by calling `tx_begin`.

Note:

The preceding is true only for global rather than local transactions. Commit or roll back local transactions with the Oracle API.

4. Ensure that the application resets the fetch state before ending a transaction. In general, use `release_cursor=no`. Use `release_cursor=yes` only when you are certain that a statement will run only once.

[Table 22-7](#) (page 22-18) lists the TPM functions that replace regular Oracle Database statements when migrating precompiler or OCI applications to TPM applications.

Table 22-7 TPM Replacement Statements

Regular Oracle Database Statements	TPM Functions
CONNECT <i>user/password</i>	tx_open (possibly implicit)
implicit start of transaction	tx_begin
SQL	Service that runs the SQL
COMMIT	tx_commit
ROLLBACK	tx_rollback
disconnect	tx_close (possibly implicit)

22.3.9 Managing Oracle XA Library Thread Safety

If you use a transaction monitor that supports threads, then the Oracle XA library enables you to write applications that are thread-safe. Nevertheless, keep certain issues in mind.

A **thread of control** (or thread) refers to the set of connections to resource managers. In a nonthreaded system, each process is considered a thread of control because each process has its own set of connections to RMs and maintains its own independent resource manager table. In a threaded system, each thread has an autonomous set of connections to RMs and each thread maintains a *private* RM table. This private table must be allocated for each thread and deallocated when the thread terminates, even if the termination is abnormal.

Note:

In Oracle Database, each thread that accesses the database must have its own connection.

Topics:

- [Specifying Threading in the Open String](#) (page 22-19)
- [Restrictions on Threading in Oracle XA](#) (page 22-19)

22.3.9.1 Specifying Threading in the Open String

The `xa_open` string provides the clause `Threads=`. You must specify this clause as `true` to enable the use of threads by the TM. The default is `false`. In most cases, the TM creates the threads; the application does not know when a thread is created. Therefore, it is advisable to allocate a service context on the stack within each service that is written for a TM application. Before doing any Oracle Database-related calls in that service, you must call the `xaoSvcCtx` function to retrieve the initialized OCI service context. You can then use this context for OCI calls within the service.

22.3.9.2 Restrictions on Threading in Oracle XA

These restrictions apply when using threads:

- Any Pro* or OCI code that runs as part of the application server process on the transaction monitor cannot be threaded unless the transaction monitor is explicitly told when each application thread is started. This is typically accomplished by using a special C compiler provided by the TM vendor.
- The Pro* statements `EXEC SQL ALLOCATE` and `EXEC SQL USE` are not supported. Therefore, when threading is enabled, you cannot use embedded SQL statements across non-XA connections.
- If one thread in a process connects to Oracle Database through XA, then all other threads in the process that connect to Oracle Database must also connect through XA. You cannot connect through `EXEC SQL CONNECT` in one thread and through `xa_open` in another thread.

22.3.10 Using the DBMS_XA Package

PL/SQL applications can use the Oracle XA library with the `DBMS_XA` package. For information about this package, see *Oracle Database PL/SQL Packages and Types Reference*.

In [Example 22-5](#) (page 22-19), one PL/SQL session starts a transaction but does not commit it, a second session resumes the transaction, and a third session commits the transaction. All three sessions are connected to the HR schema.

Example 22-5 Using the DBMS_XA Package

REM Session 1 starts a transaction and does some work.

```

DECLARE
  rc  PLS_INTEGER;
  oer PLS_INTEGER;
  xae EXCEPTION;
BEGIN
  rc := DBMS_XA.XA_START(DBMS_XA_XID(123), DBMS_XA.TMNOFLAGS);

  IF rc!=DBMS_XA.XA_OK THEN
    oer := DBMS_XA.XA_GETLASTOER();
    DBMS_OUTPUT.PUT_LINE('ORA- ' || oer || ' occurred, XA_START failed');
    RAISE xae;
  ELSE DBMS_OUTPUT.PUT_LINE('XA_START(new xid=123)    OK');
  END IF;

  UPDATE employees SET salary=salary*1.1 WHERE employee_id = 100;
  rc := DBMS_XA.XA_END(DBMS_XA_XID(123), DBMS_XA.TMSUSPEND);

  IF rc!=DBMS_XA.XA_OK THEN

```

```

        oer := DBMS_XA.XA_GETLASTOER();
        DBMS_OUTPUT.PUT_LINE('ORA-' || oer || ' occurred, XA_END failed');
        RAISE xae;
    ELSE DBMS_OUTPUT.PUT_LINE('XA_END(suspend xid=123) OK');
    END IF;

EXCEPTION
    WHEN OTHERS THEN
        DBMS_OUTPUT.PUT_LINE
            ('XA error('||rc||') occurred, rolling back the transaction ...');
        rc := DBMS_XA.XA_END(DBMS_XA_XID(123), DBMS_XA.TMSUCCESS);
        rc := DBMS_XA.XA_ROLLBACK(DBMS_XA_XID(123));

        IF rc != DBMS_XA.XA_OK THEN
            oer := DBMS_XA.XA_GETLASTOER();
            DBMS_OUTPUT.PUT_LINE('XA-'||rc||', ORA-' || oer ||
                ' XA_ROLLBACK does not return XA_OK');
            raise_application_error(-20001, 'ORA-'||oer||
                ' error in rolling back a failed transaction');
        END IF;

        raise_application_error(-20002, 'ORA-'||oer||
            ' error in transaction processing, transaction rolled back');
END;
/
SHOW ERRORS
DISCONNECT

REM Session 2 resumes the transaction and does some work.
DECLARE
    rc PLS_INTEGER;
    oer PLS_INTEGER;
    s NUMBER;
    xae EXCEPTION;
BEGIN
    rc := DBMS_XA.XA_START(DBMS_XA_XID(123), DBMS_XA.TMRESUME);

    IF rc!=DBMS_XA.XA_OK THEN
        oer := DBMS_XA.XA_GETLASTOER();
        DBMS_OUTPUT.PUT_LINE('ORA-' || oer || ' occurred, xa_start failed');
        RAISE xae;
    ELSE DBMS_OUTPUT.PUT_LINE('XA_START(resume xid=123) OK');
    END IF;

    SELECT salary INTO s FROM employees WHERE employee_id = 100;
    DBMS_OUTPUT.PUT_LINE('employee_id = 100, salary = ' || s);
    rc := DBMS_XA.XA_END(DBMS_XA_XID(123), DBMS_XA.TMSUCCESS);

    IF rc!=DBMS_XA.XA_OK THEN
        oer := DBMS_XA.XA_GETLASTOER();
        DBMS_OUTPUT.PUT_LINE('ORA-' || oer || ' occurred, XA_END failed');
        RAISE xae;
    ELSE DBMS_OUTPUT.PUT_LINE('XA_END(detach xid=123) OK');
    END IF;

EXCEPTION
    WHEN OTHERS THEN
        DBMS_OUTPUT.PUT_LINE
            ('XA error('||rc||') occurred, rolling back the transaction ...');
        rc := DBMS_XA.XA_END(DBMS_XA_XID(123), DBMS_XA.TMSUCCESS);
        rc := DBMS_XA.XA_ROLLBACK(DBMS_XA_XID(123));

```



```

IF rc != DBMS_XA.XA_OK THEN
  oer := DBMS_XA.XA_GETLASTOER();
  DBMS_OUTPUT.PUT_LINE('XA-'||rc||', ORA-' || oer ||
    ' XA_ROLLBACK does not return XA_OK');
  raise_application_error(-20001, 'ORA-'||oer||
    ' error in rolling back a failed transaction');
END IF;

raise_application_error(-20002, 'ORA-'||oer||
  ' error in transaction processing, transaction rolled back');
END;
/
SHOW ERRORS
DISCONNECT

REM Session 3 commits the transaction.
DECLARE
  rc PLS_INTEGER;
  oer PLS_INTEGER;
  xae EXCEPTION;
BEGIN
  rc := DBMS_XA.XA_COMMIT(DBMS_XA_XID(123), TRUE);

  IF rc!=DBMS_XA.XA_OK THEN
    oer := DBMS_XA.XA_GETLASTOER();
    DBMS_OUTPUT.PUT_LINE('ORA-' || oer || ' occurred, XA_COMMIT failed');
    RAISE xae;
  ELSE DBMS_OUTPUT.PUT_LINE('XA_COMMIT(commit xid=123) OK');
  END IF;

  EXCEPTION
  WHEN xae THEN
    DBMS_OUTPUT.PUT_LINE
      ('XA error('||rc||') occurred, rolling back the transaction ...');
    rc := DBMS_XA.XA_ROLLBACK(DBMS_XA_XID(123));

  IF rc != DBMS_XA.XA_OK THEN
    oer := DBMS_XA.XA_GETLASTOER();
    DBMS_OUTPUT.PUT_LINE('XA-'||rc||', ORA-' || oer ||
      ' XA_ROLLBACK does not return XA_OK');
    raise_application_error(-20001, 'ORA-'||oer||
      ' error in rolling back a failed transaction');
  END IF;

  raise_application_error(-20002, 'ORA-'||oer||
    ' error in transaction processing, transaction rolled back');
END;
/
SHOW ERRORS
DISCONNECT
QUIT

```

22.4 Troubleshooting XA Applications

Topics:

- [Accessing Oracle XA Trace Files](#) (page 22-22)
- [Managing In-Doubt or Pending Oracle XA Transactions](#) (page 22-23)

- [Using SYS Account Tables to Monitor Oracle XA Transactions](#) (page 22-23)

22.4.1 Accessing Oracle XA Trace Files

The Oracle XA library logs any error and tracing information to its trace file. This information is useful in supplementing the XA error codes. For example, it can indicate whether an `xa_open` failure is caused by an incorrect open string, failure to find the Oracle Database instance, or a logon authorization failure.

The name of the trace file is `xa_db_namedate.trc`, where `db_name` is the database name specified in the open string field `DB=db_name`, and `date` is the date when the information is logged to the trace file. If you do not specify `DB=db_name` in the open string, then it automatically defaults to `NULL`.

For example, `xa_NULL06022005.trc` indicates a trace file that was created on June 2, 2005. Its `DB` field was not specified in the open string when the resource manager was opened. The filename `xa_Finance12152004.trc` indicates a trace file was created on December 15, 2004. Its `DB` field was specified as "Finance" in the open string when the resource manager was opened.

Note:

Multiple Oracle XA library resource managers with the same `DB` field and `LogDir` field in their open strings log all trace information that occurs on the same day to the same trace file.

Suppose that a trace file contains these contents:

```
1032.12345.2: ORA-01017: invalid username/password; logon denied
1032.12345.2: xaolgn: XAER_INVAL; logon denied
```

[Table 22-8](#) (page 22-22) explains the meaning of each element.

Table 22-8 Sample Trace File Contents

String	Description
1032	The time when the information is logged.
12345	The process ID (PID).
2	Resource manager ID
xaolgn	Name of module
XAER_INVAL	Error returned as specified in the XA standard
ORA-01017	Oracle Database information that was returned

Topics:

- [xa_open String DbgFl](#) (page 22-23)
- [Trace File Locations](#) (page 22-23)

22.4.1.1 xa_open String DbgFl

Normally, the XA trace file is opened only if an error is detected. The `xa_open` string `DbgFl` provides a tracing facility to record additional detail about the XA library. By default, its value is zero. You can set it to any combination of these values:

- `0x1`, which enables you to trace the entry and exit to each subprogram in the XA interface. This value can be useful in seeing exactly which XA calls the TP Monitor is making and which transaction identifier it is generating.
- `0x2`, which enables you to trace the entry to and exit from other nonpublic XA library programs. This is generally useful only to Oracle Database developers.
- `0x4`, which enables you to trace various other "interesting" calls made by the XA library, such as specific calls to the OCI. This is generally useful only to Oracle Database developers.

Note:

The flags are independent bits of an `ub4`, so to obtain printout from two or more flags, you must set a combined value of the flags.

22.4.1.2 Trace File Locations

The XA application determines a location for the trace file according to this algorithm:

1. The `LogDir` directory specified in the open string.
2. If you do not specify `LogDir` in the open string, then the Oracle XA application attempts to create the trace file in this directory (if the Oracle home is accessible):
 - `%ORACLE_HOME%\rdbms\trace` on Windows
 - `$ORACLE_HOME/rdbms/log` on Linux and UNIX
3. If the Oracle XA application cannot determine where the Oracle home is located, then the application creates the trace file in the current working directory.

22.4.2 Managing In-Doubt or Pending Oracle XA Transactions

In-doubt or pending transactions are transactions that were prepared but not committed to the database. In general, the TM provided by the TPM system resolves any failure and recovery of in-doubt or pending transactions. The DBA might have to override an in-doubt transaction if these situations occur:

- It is locking data that is required by other transactions.
- It is not resolved in a reasonable amount of time.

See the TPM documentation for more information about overriding in-doubt transactions in such circumstances and about how to decide whether to commit or roll back the in-doubt transaction.

22.4.3 Using SYS Account Tables to Monitor Oracle XA Transactions

These views under the Oracle Database `SYS` account contain transactions generated by regular Oracle Database applications and Oracle XA applications:

- DBA_PENDING_TRANSACTIONS
- V\$GLOBAL_TRANSACTION
- DBA_2PC_PENDING
- DBA_2PC_NEIGHBORS

For transactions generated by Oracle XA applications, this column information applies specifically to the DBA_2PC_NEIGHBORS table:

- The DBID column is always `xa_orcl`
- The DBUSER_OWNER column is always `db_namexa.oracle.com`

Remember that the `db_name` is always specified as `DB=db_name` in the open string. If you do not specify this field in the open string, then the value of this column is `NULLxa.oracle.com` for transactions generated by Oracle XA applications.

For example, this SQL statement provide more information about in-doubt transactions generated by Oracle XA applications:

```
SELECT *
FROM DBA_2PC_PENDING p, DBA_2PC_NEIGHBORS n
WHERE p.LOCAL_TRAN_ID = n.LOCAL_TRAN_ID
AND n.DBID = 'xa_orcl';
```

Alternatively, if you know the format ID used by the transaction processing monitor, then you can use DBA_PENDING_TRANSACTIONS or V\$GLOBAL_TRANSACTION. Whereas DBA_PENDING_TRANSACTIONS gives a list of prepared transactions, V\$GLOBAL_TRANSACTION provides a list of all active global transactions.

22.5 Oracle XA Issues and Restrictions

Topics:

- [Using Database Links in Oracle XA Applications](#) (page 22-24)
- [Managing Transaction Branches in Oracle XA Applications](#) (page 22-25)
- [Using Oracle XA with Oracle Real Application Clusters \(Oracle RAC\)](#) (page 22-25)
- [SQL-Based Oracle XA Restrictions](#) (page 22-29)
- [Miscellaneous Restrictions](#) (page 22-30)

22.5.1 Using Database Links in Oracle XA Applications

Oracle XA applications can access other Oracle Database instances through database links with these restrictions:

- They must use the shared server configuration.

The transaction processing monitors (TPMs) use shared servers to open the connection to an Oracle Database A. Then the operating system network connection required for the database link is opened by the dispatcher instead of a dedicated server process. This allows different services or threads to operate on the transaction.

If this restriction is not satisfied, then when you use database links within an XA transaction, it creates an operating system network connection between the dedicated server process and the other Oracle Database B. Because this network connection cannot be moved from one dedicated server process to another, you cannot detach from this dedicated server process of database A. Then when you access the database B through a database link, you receive an ORA-24777 error.

- The other database being accessed must be another Oracle Database.

If these restrictions are satisfied, Oracle Database allows such links and propagates the transaction protocol (prepare, rollback, and commit) to the other Oracle Database instances.

If using the shared server configuration is not possible, then access the remote database through the Pro*C/C++ application by using `EXEC SQL AT` syntax.

The `init.ora` parameter `OPEN_LINKS_PER_INSTANCE` specifies the number of open database link connections that can be migrated. These `dblink` connections are used by XA transactions so that the connections are cached after a transaction is committed. Another transaction can use the database link connection if the user who created the connection also created the transaction. This parameter is different from the `init.ora` parameter `OPEN_LINKS`, which specifies the maximum number of concurrent open connections (including database links) to remote databases in one session. The `OPEN_LINKS` parameter does not apply to XA applications.

22.5.2 Managing Transaction Branches in Oracle XA Applications

Oracle Database transaction branches within the same global transaction can be coupled tightly or loosely. If the transaction branches are **tightly coupled**, then they share locks. Consequently, pre-COMMIT updates in one transaction branch are visible in other branches that belong to the same global transaction. In loosely coupled transaction branches, the branches do not share locks and do not see updates in other branches.

In a tightly coupled branch, Oracle Database obtains the DX lock before running any statement. Because the system does not obtain a lock before running the statement, loosely coupled transaction branches result in greater concurrency. The disadvantage is that all transaction branches must go through the two phases of commit, that is, the system cannot use XA one-phase optimization.

[Table 22-9](#) (page 22-25) summarizes the trade-offs between tightly coupled branches and loosely coupled branches.

Table 22-9 *Tightly and Loosely Coupled Transaction Branches*

Attribute	Tightly Coupled Branches	Loosely Coupled Branches
Two Phase Commit	Read-only optimization [prepare for all branches, commit for last branch]	Two phases [prepare and commit for all branches]
Serialization	Database call	None

22.5.3 Using Oracle XA with Oracle Real Application Clusters (Oracle RAC)

As of Oracle Database 11g Release 1 (11.1), an XA transaction can span Oracle RAC instances, allowing any application that uses XA to take full advantage of the Oracle RAC environment, enhancing the availability and scalability of the application.

Note:

External procedure callouts combined with distributed transactions is not supported.

Topics:

- [GLOBAL_TXN_PROCESSES Initialization Parameter](#) (page 22-26)
- [Managing Transaction Branches on Oracle RAC](#) (page 22-26)
- [Managing Instance Recovery in Oracle RAC with DTP Services \(10.2\)](#) (page 22-28)
- [Global Uniqueness of XIDs in Oracle RAC](#) (page 22-29)
- [Tight and Loose Coupling](#) (page 22-29)

22.5.3.1 GLOBAL_TXN_PROCESSES Initialization Parameter

The initialization parameter GLOBAL_TXN_PROCESSES specifies the initial number of GTX*n* background processes for each Oracle RAC instance. Its default value is 1.

Leave this parameter at its default value clusterwide if distributed transactions might span multiple Oracle RAC instances. This allows the units of work performed across these Oracle RAC instances to share resources and act as a single transaction (that is, the units of work are tightly coupled). It also allows 2PC requests to be sent to any node in the cluster.

See Also:

Oracle Database Reference for more information about GLOBAL_TXN_PROCESSES

22.5.3.2 Managing Transaction Branches on Oracle RAC

Note:

This topic applies if either of the following is true:

- The initialization parameter GLOBAL_TXN_PROCESSES is not at its default value in the initialization file of every Oracle RAC instance.
 - The Oracle XA application resumes or joins previously detached branches of a transaction.
-

Oracle Database permits different instances to operate on different transaction branches in Oracle RAC. For example, Node 1 can operate on branch A while Node 2 operates on branch B. Before Oracle Database 11g Release 1 (11.1), if transaction branches were on different instances, then they were loosely coupled and did not share locks. In this case, Oracle Database treated different units of work in different application threads as separate entities that did not share resources.

A different case is when multiple instances operate on a single transaction branch. For example, assume that a single transaction lands on Node 1 and Node 2 as follows:

Node 1

1. xa_start
2. SQL operations
3. xa_end (SUSPEND)

Node 2

1. xa_start (RESUME)
2. xa_prepare
3. xa_commit
4. xa_end

In the immediately preceding sequence, Oracle Database returns an error because Node 2 must not resume a branch that is physically located on a different node (Node 1).

Before Oracle Database 11g Release 1 (11.1), the way to achieve tight coupling in Oracle RAC was to use **Distributed Transaction Processing (DTP) services**, that is, services whose cardinality (one) ensured that all tightly-coupled branches landed on the same instance—regardless of whether load balancing was enabled. Middle-tier components addressed Oracle Database through a common logical database service name that mapped to a single Oracle RAC instance at any point in time. An intermediate name resolver for the database service hid the physical characteristics of the database instance. DTP services enabled all participants of a tightly-coupled global transaction to create branches on one instance.

As of Oracle Database 11g Release 1 (11.1), the DTP service is no longer required to support XA transactions with tightly coupled branches. By default, tightly coupled branches that land on different Oracle RAC instances remain tightly coupled; that is, they share locks and resources across Oracle RAC instances.

For example, when you use a DTP service, this sequence of actions occurs on the same instance:

1. xa_start
2. SQL operations
3. xa_end (SUSPEND)
4. xa_start (RESUME)
5. SQL operations
6. xa_prepare
7. xa_commit or xa_rollback

Moreover, multiple tightly-coupled branches land on the same instance if each addresses the Oracle RM with the same DTP service.

To leverage all instances in the cluster, create multiple DTP services, with one or more on each node that hosts distributed transactions. All branches of a global distributed transaction exist on the same instance. Thus, you can leverage all instances and nodes of an Oracle RAC cluster to balance the load of many distributed XA transactions, thereby maximizing application throughput.

See Also:

Oracle Real Application Clusters Administration and Deployment Guide to learn how to manage distributed transactions in a Real Application Clusters configuration

22.5.3.3 Managing Instance Recovery in Oracle RAC with DTP Services (10.2)

Before Oracle Database 10g Release 2 (10.2), TM was responsible for detecting failure and triggering failover and failback in Oracle RAC. To ensure that information about in-doubt transactions was propagated to `DBA_2PC_PENDING`, TM had to call `xa_recover` before resolving the in-doubt transactions. If an instance failed, then the XA client library could not fail over to another instance until it had run the `SYS.DBMS_XA.DIST_TXN_SYNC` procedure to ensure that the undo segments of the failed instance were recovered. As of Oracle Database 10g Release 2 (10.2), there is no such requirement to call `xa_recover` in cases where the TM has enough information about in-flight transactions.

Note:

As of Oracle Database 9g Release 2 (9.2), `xa_recover` is required to wait for distributed data manipulation language (DML) statements to complete on remote sites.

Using DTP services in Oracle RAC has these benefits:

- Automates instance failure detection.
- Automates instance failover and failback. When an instance fails, the DTP service hosted on this instance fails over to another instance. The failover forces clients to reconnect; nevertheless, the logical names for the service remain the same. Failover is automatic and does not require an administrator intervention. The administrator can induce failback by a service relocate statement, but all failback-related recovery is automatically handled within the database server.
- Enables Oracle Database rather than the client to drive instance recovery. The database does not require middle-tier TM involvement to determine the state of transactions prepared by other instances.

See Also:

- *Oracle Real Application Clusters Administration and Deployment Guide* to learn how to manage instance recovery
 - *Oracle Real Application Clusters Administration and Deployment Guide* for information about services and distributed transaction processing in Oracle RAC
-
-

22.5.3.4 Global Uniqueness of XIDs in Oracle RAC

Before Oracle Database 11g Release 1 (11.1), Oracle RAC database cannot determine whether a given XID is unique for XA transactions throughout the cluster.

For example, suppose that there is an XID `Fmt(x).Tx(1).Br(1)` on Oracle RAC instance 1 and another XID `Fmt(x).Tx(1).Br(1)` on Oracle RAC instance 2. Each of these can start a branch and run SQL even though the XID is not unique across Oracle RAC instances.

As of Oracle Database 11g Release 1 (11.1), Oracle RAC database detects the duplicate XIDs across Oracle RAC instances and prevents a branch with a duplicate XID from starting.

See Also:

Oracle Real Application Clusters Administration and Deployment Guide for information about services and distributed transaction processing in Oracle RAC

22.5.3.5 Tight and Loose Coupling

Oracle Database transaction branches within the same global transaction can be coupled either tightly or loosely (for details, see [Managing Transaction Branches in Oracle XA Applications](#) (page 22-25)). Ordinarily, coupling type is determined by the value of the `Loose_Coupling` field of the `xa_open` string (see [Table 22-5](#) (page 22-11)). However, if transaction branches land on different Oracle RAC instances when running Oracle RAC, they are loosely coupled even if `Loose_Coupling=false`.

See Also:

Oracle Real Application Clusters Administration and Deployment Guide for information about services and distributed transaction processing in Oracle RAC

22.5.4 SQL-Based Oracle XA Restrictions

This section describes restrictions concerning these SQL operations:

- [Rollbacks and Commits](#) (page 22-30)
- [DDL Statements](#) (page 22-30)
- [Session State](#) (page 22-30)

- [EXEC SQL](#) (page 22-30)

22.5.4.1 Rollbacks and Commits

Because the transaction manager is responsible for coordinating and monitoring the progress of the global transaction, the application must not contain any Oracle Database-specific statement that independently rolls back or commits a global transaction. However, you can use rollbacks and commits in a local transaction.

Do not use `EXEC SQL ROLLBACK WORK` for precompiler applications when you are in the middle of a global transaction. Similarly, an OCI application must not run `OCITransRollback`, or the Version 7 equivalent `orol`. You can roll back a global transaction by calling `tx_rollback`.

Similarly, a precompiler application must not have the `EXEC SQL COMMIT WORK` statement in the middle of a global transaction. An OCI application must not run `OCITransCommit` or the Version 7 equivalent `ocom`. For example, use `tx_commit` or `tx_rollback` to end a global transaction.

22.5.4.2 DDL Statements

Because a data definition language (DDL) statement, such as `CREATE TABLE`, implies an implicit commit, the Oracle XA application cannot run any DDL statements.

22.5.4.3 Session State

Oracle Database does not guarantee that session state is valid between TPM services. For example, if a TPM service updates a session variable (such as a global package variable), then another TPM service that runs as part of the same global transaction might not see the change. Use savepoints only within a TPM service. The application must not refer to a savepoint that was created in another TPM service. Similarly, an application must not attempt to fetch from a cursor that was executed in another TPM service.

22.5.4.4 EXEC SQL

Do not use the `EXEC SQL` statement to connect or disconnect. That is, do not use `EXEC SQL CONNECT`, `EXEC SQL COMMIT WORK RELEASE` or `EXEC SQL ROLLBACK WORK RELEASE`.

22.5.5 Miscellaneous Restrictions

- You cannot use both Oracle XA and a gateway in the same session.
- Oracle Database does not support association migration (a means whereby a transaction manager might resume a suspended branch association in another branch).
- The optional XA feature asynchronous XA calls is not supported.
- Set the `TRANSACTIONS` initialization parameter to the expected number of concurrent global transactions. The initialization parameter `OPEN_LINKS_PER_INSTANCE` specifies the number of open database link connections that can be migrated. These database link connections are used by XA transactions so that the connections are cached after a transaction is committed.

See Also:

[Using Database Links in Oracle XA Applications](#) (page 22-24)

- The maximum number of `xa_open` calls for each thread is 32.
- When building an XA application based on TP-monitor, ensure that the TP-monitors libraries (that define the symbols `ax_reg` and `ax_unreg`) are placed in the link line before Oracle Database's client shared library. If your platform does not support shared libraries or if your linker is not sensitive to ordering of libraries in the link line, use Oracle Database's nonshared client library. These link restrictions are applicable only when using XA's dynamic registration (Oracle XA switch `xaoswd`).

Developing Applications with the Publish-Subscribe Model

This chapter explains how to develop applications on the publish-subscribe model.

Topics:

- [Introduction to the Publish-Subscribe Model](#) (page 23-1)
- [Publish-Subscribe Architecture](#) (page 23-2)
- [Publish-Subscribe Concepts](#) (page 23-3)
- [Examples of a Publish-Subscribe Mechanism](#) (page 23-5)

23.1 Introduction to the Publish-Subscribe Model

Because the database is the most significant resource of information within the enterprise, Oracle created a publish-subscribe solution for enterprise information delivery and messaging to complement this role.

Networking technologies and products enable a high degree of connectivity across a large number of computers, applications, and users. In these environments, it is important to provide asynchronous communications for the class of distributed systems that operate in a loosely-coupled and autonomous fashion, and which require operational immunity from network failures. This requirement is filled by various middleware products that are characterized as messaging, message-oriented middleware (MOM), message queuing, or publish-subscribe.

Applications that communicate through a publish and subscribe paradigm require the sending applications (publishers) to publish messages without explicitly specifying recipients or having knowledge of intended recipients. Similarly, receiving applications (subscribers) must receive only those messages that the subscriber has registered an interest in.

This decoupling between senders and recipients is usually accomplished by an intervening entity between the publisher and the subscriber, which serves as a level of indirection. This intervening entity is a queue that represents a subject or channel. [Figure 23-1](#) (page 23-2) illustrates publish and subscribe functionality.

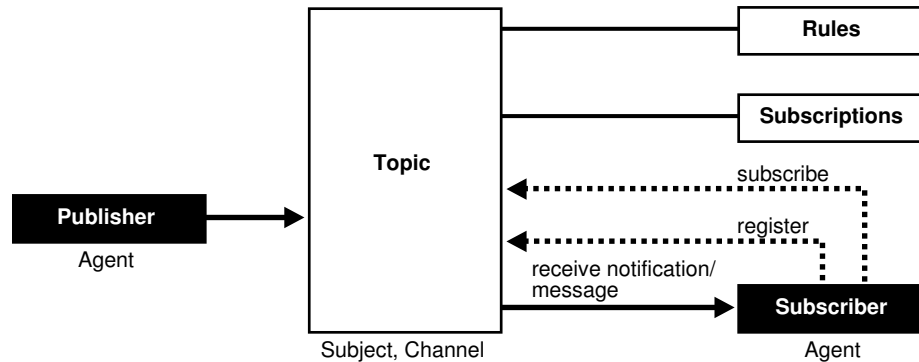
Figure 23-1 Oracle Publish-Subscribe Functionality

A subscriber subscribes to a queue by expressing interest in messages enqueued to that queue and by using a subject- or content-based rule as a filter. This results in a set of rule-based subscriptions associated with a given queue.

At runtime, publishers post messages to various queues. The queue (in other words, the delivery mechanisms of the underlying infrastructure) then delivers messages that match the various subscriptions to the appropriate subscribers.

23.2 Publish-Subscribe Architecture

Oracle Database includes these features to support database-enabled publish-subscribe messaging:

- [Database Events](#) (page 23-2)
- [Oracle Advanced Queuing](#) (page 23-2)
- [Client Notification](#) (page 23-3)

23.2.1 Database Events

Database events support declarative definitions for publishing database events, detection, and runtime publication of such events. This feature enables active publication of information to end-users in an event-driven manner, to complement the traditional pull-oriented approaches to accessing information.

See Also:

Oracle Database PL/SQL Language Reference

23.2.2 Oracle Advanced Queuing

Oracle Advanced Queuing (AQ) supports a queue-based publish-subscribe paradigm. Database queues serve as a durable store for messages, along with capabilities to allow publish and subscribe based on queues. A rules-engine and subscription service dynamically route messages to recipients based on expressed interest. This allows decoupling of addressing between senders and receivers to complement the existing explicit sender-receiver message addressing.

See Also:*Oracle Database Advanced Queuing User's Guide*

23.2.3 Client Notification

Client notifications support asynchronous delivery of messages to interested subscribers, enabling database clients to register interest in certain queues, and it enables these clients to receive notifications when publications on such queues occur. Asynchronous delivery of messages to database clients is in contrast to the traditional polling techniques used to retrieve information.

See Also:*Oracle Call Interface Programmer's Guide*

23.3 Publish-Subscribe Concepts

queue

A **queue** is an entity that supports the notion of named subjects of interest. Queues can be characterized as persistent or nonpersistent (lightweight).

A **persistent queue** serves as a durable container for messages. Messages are delivered in a deferred and reliable mode.

The underlying infrastructure of a **nonpersistent, or lightweight, queue** pushes the messages published to connected clients in a lightweight, at-best-once, manner.

agent

Publishers and subscribers are internally represented as agents.

An **agent** is a persistent logical subscribing entity that expresses interest in a queue through a subscription. An agent has properties, such as an associated subscription, an address, and a delivery mode for messages. In this context, an agent is an electronic proxy for a publisher or subscriber.

client

A **client** is a transient physical entity. The attributes of a client include the physical process where the client programs run, the node name, and the client application logic. Several clients can act on behalf of a single agent. The same client, if authorized, can act on behalf of multiple agents.

rule on a queue

A **rule on a queue** is specified as a conditional expression using a predefined set of operators on the message format attributes or on the message header attributes. Each queue has an associated message content format that describes the structure of the messages represented by that queue. The message format might be unstructured (RAW) or it might have a well-defined structure (ADT). This allows both subject- or content-based subscriptions.

subscriber

Subscribers (agents) can specify subscriptions on a queue using a rule. Subscribers are durable and are stored in a catalog.

database event publication framework

The database represents a significant source for publishing information. An event framework is proposed to allow declarative definition of database event publication. As these predefined events occur, the framework detects and publishes such events. This allows active delivery of information to end-users in an event-driven manner as part of the publish-subscribe capability.

registration

Registration is the process of associated delivery information by a given client, acting on behalf of an agent. There is an important distinction between the subscription and registration related to the agent/client separation.

Subscription indicates an interest in a particular queue by an agent. It does not specify where and how delivery must occur. Delivery information is a physical property that is associated with a client, and it is a transient manifestation of the logical agent (the subscriber). A specific client process acting on behalf of an agent registers delivery information by associating a host and port, indicating *where* the delivery is to be done, and a callback, indicating *how* there delivery is to be done.

publishing a message

Publishers publish messages to queues by using the appropriate queuing interfaces. The interfaces might depend on which model the queue is implemented on. For example, an enqueue call represents the publishing of a message.

rules engine

When a message is posted or published to a given queue, a rules engine extracts the set of candidate rules from all rules defined on that queue that match the published message.

subscription services

Corresponding to the list of candidate rules on a given queue, the set of subscribers that match the candidate rules can be evaluated. In turn, the set of agents corresponding to this subscription list can be determined and notified.

posting

The queue notifies all registered clients of the appropriate published messages. This concept is called **posting**. When the queue must notify all interested clients, it posts the message to all registered clients.

receiving a message

A subscriber can receive messages through any of these mechanisms:

- A client process acting on behalf of the subscriber specifies a callback using the registration mechanism. The posting mechanism then asynchronously invokes the callback when a message matches the subscriber's subscription. The message content can be passed to the callback function (nonpersistent queues only).
- A client process acting on behalf of the subscriber specifies a callback using the registration mechanism. The posting mechanism then asynchronously invokes the callback function, but without the full message content. This serves as a notification to the client, which subsequently retrieves the message content in a pull fashion (persistent queues only).
- A client process acting on behalf of the subscriber simply retrieves messages from the queue in a periodic or other appropriate manner. While the messages are deferred, there is no asynchronous delivery to the end-client.

23.4 Examples of a Publish-Subscribe Mechanism

This example shows how database events, client notification, and AQ work to implement publish-subscribe.

- Create under the user schema, pubsub, with all objects necessary to support a publish-subscribe mechanism. In this particular code, the Agent snoop subscribe to messages that are published at logon events. To use AQ functionality, user pubsub needs AQ_ADMINISTRATOR_ROLE privileges and EXECUTE privilege on DBMS_AQ and DBMS_AQADM.

```

Rem -----
REM create queue table for persistent multiple consumers:
Rem -----

Rem Create or replace a queue table
BEGIN
DBMS_AQADM.CREATE_QUEUE_TABLE(
  Queue_table      => 'Pubsub.Raw_msg_table',
  Multiple_consumers => TRUE,
  Queue_payload_type => 'RAW',
  Compatible       => '8.1');
END;
/

Rem -----
Rem Create a persistent queue for publishing messages:
Rem -----

Rem Create a queue for logon events
BEGIN
  DBMS_AQADM.CREATE_QUEUE(
    Queue_name      => 'Pubsub.Logon',
    Queue_table     => 'Pubsub.Raw_msg_table',
    Comment         => 'Q for error triggers');
END;
/

Rem -----
Rem Start the queue:
Rem -----

BEGIN
  DBMS_AQADM.START_QUEUE('pubsub.logon');
END;
/

Rem -----
Rem define new_enqueue for convenience:
Rem -----

CREATE OR REPLACE PROCEDURE New_enqueue(
  Queue_name      IN VARCHAR2,
  Payload         IN RAW ,
  Correlation     IN VARCHAR2 := NULL,
  Exception_queue IN VARCHAR2 := NULL)
AS

Enq_ct  DBMS_AQ.Enqueue_options_t;
Msg_prop DBMS_AQ.Message_properties_t;

```

```

Enq_msgid RAW(16);
Userdata RAW(1000);

BEGIN
    Msg_prop.Exception_queue := Exception_queue;
    Msg_prop.Correlation := Correlation;
    Userdata := Payload;

DBMS_AQ.ENQUEUE(Queue_name, Enq_ct, Msg_prop, Userdata, Enq_msgid);
END;
/

Rem -----
Rem add subscriber with rule based on current user name,
Rem using correlation_id
Rem -----

DECLARE
Subscriber Sys.Aq$_agent;
BEGIN
    Subscriber := sys.aq$_agent('SNOOP', NULL, NULL);
DBMS_AQADM.ADD_SUBSCRIBER(
    Queue_name      => 'Pubsub.logon',
    Subscriber      => subscriber,
    Rule            => 'CORRID = ''HR'' ');
END;
/

Rem -----
Rem create a trigger on logon on database:
Rem -----

Rem create trigger on after logon:
CREATE OR REPLACE TRIGGER pubsub.Systrig2
AFTER LOGON
ON DATABASE
BEGIN
    New_enqueue('Pubsub.Logon', HEXTORAW('9999'), Dbms_standard.login_user);
END;
/

• After subscriptions are created, the next step is for the client to register for
notification using callback functions. This is done using the Oracle Call Interface
(OCI). This code performs necessary steps for registration. The initial steps of
allocating and initializing session handles are omitted here for sake of clarity:

ub4 namespace = OCI_SUBSCR_NAMESPACE_AQ;

/* callback function for notification of logon of user 'HR' on database: */

ub4 notifySnoop(ctx, subscrhp, pay, payl, desc, mode)
dvoid *ctx;
OCISubscription *subscrhp;
dvoid *pay;
ub4 payl;
dvoid *desc;
ub4 mode;
{
    printf("Notification : User HR Logged on\n");

```

```

}

int main()
{
    OCISession *authp = (OCISession *) 0;
    OCISubscription *subscrhpSnoop = (OCISubscription *)0;

    /******
       Initialize OCI Process/Environment
       Initialize Server Contexts
       Connect to Server
       Set Service Context
    *****/

    /* Registration Code Begins */

    /* Each call to initSubscriptionHn allocates
       and Initialises a Registration Handle */

    initSubscriptionHn( &subscrhpSnoop, /* subscription handle */
        "ADMIN:PUBSUB.SNOOP", /* subscription name */
        /* <agent_name>:<queue_name> */
        (dvoid*)notifySnoop); /* callback function */

    /******
       The Client Process does not need a live Session for Callbacks
       End Session and Detach from Server
    *****/

    OCISessionEnd ( svchp, errhp, authp, (ub4) OCI_DEFAULT);

    /* detach from server */
    OCIServerDetach( srvhp, errhp, OCI_DEFAULT);

    while (1) /* wait for callback */
        sleep(1);
}

void initSubscriptionHn (subscrhp,
    subscriptionName,
    func)

OCISubscription **subscrhp;
char* subscriptionName;
dvoid * func;
{

    /* allocate subscription handle: */

    (void) OCIHandleAlloc((dvoid *) envhp, (dvoid **)subscrhp,
        (ub4) OCI_HTYPE_SUBSCRIPTION,
        (size_t) 0, (dvoid **) 0);

    /* set subscription name in handle: */

    (void) OCIAttrSet((dvoid *) *subscrhp, (ub4) OCI_HTYPE_SUBSCRIPTION,
        (dvoid *) subscriptionName,
        (ub4) strlen((char *)subscriptionName),
        (ub4) OCI_ATTR_SUBSCR_NAME, errhp);
}

```

```
/* set callback function in handle: */

(void) OCIAttrSet((dvoid *) *subscrhp, (ub4) OCI_HTYPE_SUBSCRIPTION,
    (dvoid *) func, (ub4) 0,
    (ub4) OCI_ATTR_SUBSCR_CALLBACK, errhp);

(void) OCIAttrSet((dvoid *) *subscrhp, (ub4) OCI_HTYPE_SUBSCRIPTION,
    (dvoid *) 0, (ub4) 0,
    (ub4) OCI_ATTR_SUBSCR_CTX, errhp);

/* set namespace in handle: */

(void) OCIAttrSet((dvoid *) *subscrhp, (ub4) OCI_HTYPE_SUBSCRIPTION,
    (dvoid *) &namespace, (ub4) 0,
    (ub4) OCI_ATTR_SUBSCR_NAMESPACE, errhp);

checkerr(errhp, OCISubscriptionRegister(svchp, subscrhp, 1, errhp,
    OCI_DEFAULT));
}
```

If user HR logs on to the database, the client is notified, and the call back function `notifySnoop` is invoked.

Using the Oracle ODBC Driver

This chapter contains the following sections:

Topics:

- [About Oracle ODBC Driver](#) (page 24-1)
- [For All Users](#) (page 24-2)
- [For Advanced Users](#) (page 24-22)
- [For Programmers](#) (page 24-26)

24.1 About Oracle ODBC Driver

What is ODBC?

Open Database Connectivity (ODBC) provides a standard interface that allows one application to access many different data sources. The application's source code does not have to be recompiled for each data source. A database driver links the application to a specific data source. A database driver is a dynamic-link library that an application can invoke on demand to gain access to a particular data source. Therefore, the application can access any data source for which a database driver exists.

The ODBC interface defines the following:

- A library of ODBC function calls that allows an application to connect to a data source, execute structured query language (SQL) statements, and retrieve results.
- SQL syntax based on the SQL-99 specification.
- A standard set of error codes.
- A standard way to connect to and log in to a data source.
- A standard representation for data types.

[Figure 24-1](#) (page 24-2) shows the components of the ODBC model. The model begins with an ODBC application making a call to the Driver Manager through the ODBC application program interface (API). The Driver Manager can be either the Microsoft Driver Manager or the unixODBC Driver Manager. Still using the ODBC API, the Driver Manager makes a call to the ODBC Driver. The ODBC Driver accesses the database over a network communications link using the database API. [Figure 24-1](#) (page 24-2) shows an ODBC application accessing three separate databases.

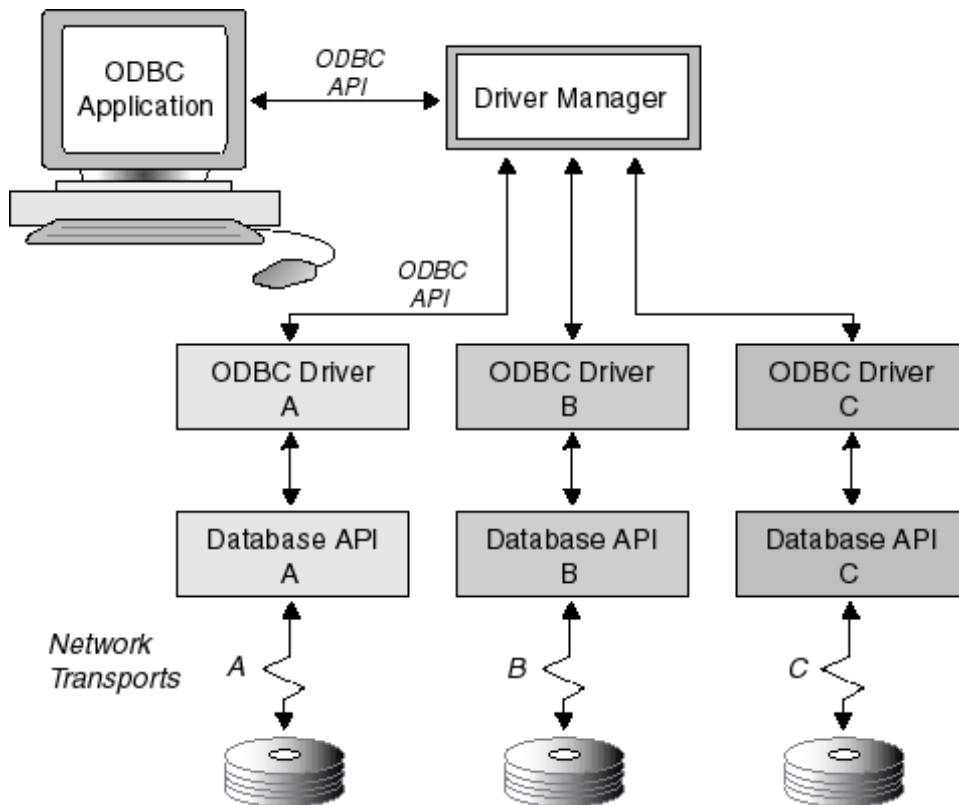
Figure 24-1 Components of the ODBC Model**Related Topic**

[What is the Oracle ODBC Driver](#) (page 24-3)

24.2 For All Users**Topics:**

- [Oracle ODBC Driver](#) (page 24-2)
- [Configuration Tasks](#) (page 24-11)
- [Modifying the oraodbc.ini File](#) (page 24-21)
- [Connecting to a Data Source](#) (page 24-21)
- [Troubleshooting](#) (page 24-22)

24.2.1 Oracle ODBC Driver**Topics:**

- [What is the Oracle ODBC Driver](#) (page 24-3)
- [New and Changed Features](#) (page 24-5)
- [Features Not Supported](#) (page 24-9)
- [Files Created by the Installation](#) (page 24-10)

- [Driver Conformance Levels](#) (page 24-11)
- [Known Limitations](#) (page 24-11)

24.2.1.1 What Is the Oracle ODBC Driver

The Oracle ODBC Driver enables ODBC applications on Microsoft Windows, as well as UNIX platforms like Linux, Solaris, and IBM Advanced Interactive eXecutive (AIX) read and write access to Oracle® databases through the ODBC interface using Oracle Net Services software.

The Oracle ODBC Driver uses the Oracle Call Interface (OCI) client and server software to submit requests to and receive responses from the data source. Oracle Net Services communications protocol is used for communications between the OCI client and the Oracle server.

The Oracle ODBC Driver translates ODBC SQL syntax into syntax that can be used to access the data source. When the results are returned from the data source, the Oracle ODBC Driver translates them back to ODBC SQL syntax.

[Figure 24-2](#) (page 24-4) shows the Oracle ODBC Driver architecture as described in the preceding paragraphs.

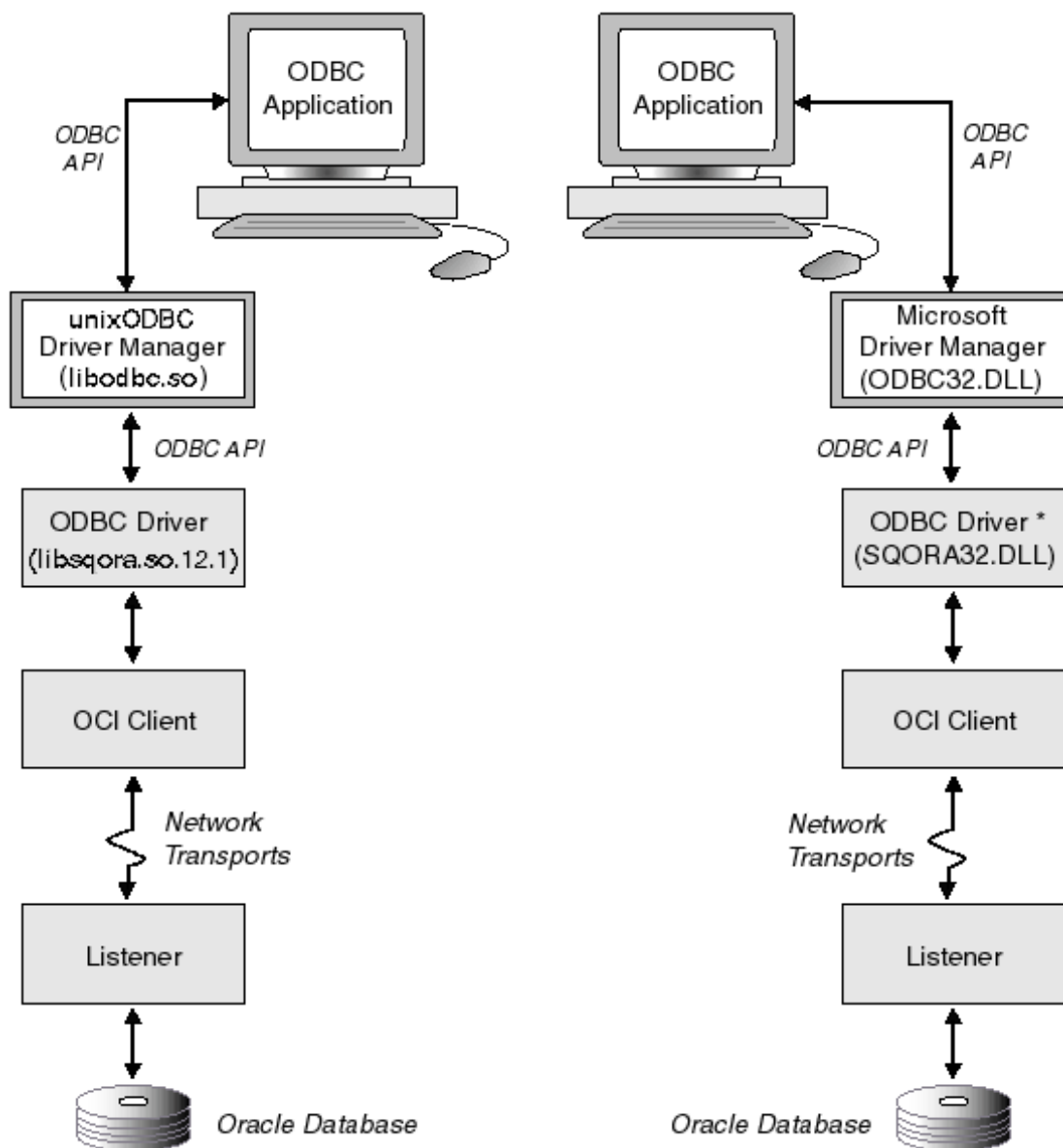
Figure 24-2 Oracle ODBC Driver Architecture

* The Oracle ODBC Resource data definition language (DLL) file (sqresxx.dll), where xx represents the language abbreviation, contains all pertinent language information; the default resource file used is sqresus.dll.

For more information about the OCI client and server software, refer to the OCI documentation.

Related Topics

[Configuring the Data Source](#) (page 24-11)

[Connecting to a Data Source](#) (page 24-21)

[Driver Conformance Levels](#) (page 24-11)

[New and Changed Features](#) (page 24-5)

[Files Created by the Installation](#) (page 24-10)

24.2.1.2 New and Changed Features

Topics:

- [New Features for Oracle ODBC Driver Release 12.2.0.1.0](#) (page 24-5)
- [New Features for Oracle ODBC Driver Release 12.1.0.1.0](#) (page 24-5)
- [New Features for Oracle ODBC Driver Release 12.1.0.2.0](#) (page 24-5)
- [New Features for Oracle ODBC Driver Release 11.2.0.1.0](#) (page 24-7)
- [New Features for Oracle ODBC Driver Release 11.1.0.1.0](#) (page 24-7)
- [New Features for Oracle ODBC Driver Release 10.1.0.2.0](#) (page 24-8)
- [Changes for Oracle ODBC Driver Release 10.1.0.2.0](#) (page 24-8)

New Features for Oracle ODBC Driver Release 12.2.0.1.0

Features of the Oracle ODBC Driver Release 12.2.0.1.0 software for the Microsoft Windows Server 2008, Windows Server 2008 R2, Windows Server 2012, Windows Server 2012 R2, Windows 7, Windows 8, Windows 8.1, Windows 10, Linux X86-64 (32/64 bit), Sun Solaris SPARC64 (32,64 bit), IBM AIX 5L (32,64 bit), Sun Solaris X64 (32,64 bit), HPUX IA64 (32,64 bit), ZLinux (32,64 bit) operating systems are described as follows:

- Support is added for long identifiers.
Oracle ODBC Driver now supports object lengths of 128 bytes. In previous releases, the object length limit was 30 bytes.
- Support is added for time stamp with time zone and time stamp with local time zone.

This features does not require changes to the existing ODBC application where ODBC `TIMESTAMP` data type is used. If an existing application uses ODBC `TIMESTAMP` data type and the database column is `TIMESTAMP`, the current behavior is preserved.

For database column `TIMESTAMP WITH TIMEZONE` or `TIMESTAMP WITH LOCAL TIMEZONE`, the time component in the ODBC `TIMESTAMP_STRUCT` is in the user's session time zone. This behavior is transparent to the user's application, requiring no change to the ODBC application.

See [About Supporting Oracle `TIMESTAMP WITH TIME ZONE` and `TIMESTAMP WITH LOCAL TIME ZONE` Column Type in ODBC](#) (page 24-41) for examples.

New Features for Oracle ODBC Driver Release 12.1.0.2.0

Features of the Oracle ODBC Driver Release 12.1.0.2.0 software for the Microsoft Windows Server 2008, Windows Server 2008 R2, Windows Server 2012, Windows 7, Windows 8, Windows 10, Linux X86-64 (32/64 bit), Sun Solaris SPARC64 (32,64 bit), IBM AIX 5L (32,64 bit), Sun Solaris X64 (32,64 bit), HPUX IA64 (32,64 bit), ZLinux (32,64 bit) operating systems are described as follows:

Microsoft Windows 10 platform is added.

New Features for Oracle ODBC Driver Release 12.1.0.1.0

Features of the Oracle ODBC Driver Release 12.1.0.1.0 software for the Microsoft Windows Server 2008, Windows Server 2008 R2, Windows Server 2012, Windows 7,

Windows 8, Linux X86-64 (32/64 bit), Sun Solaris SPARC64 (32,64 bit), IBM AIX 5L (32,64 bit), Sun Solaris X64 (32,64 bit), HP-UX IA64 (32,64 bit), ZLinux (32,64 bit) operating systems are described as follows:

- Oracle ODBC Driver now supports 32 KB data columns with `VARCHAR2`, `NVARCHAR2` and `RAW` data. See *Oracle Database PL/SQL Language Reference* and *Oracle Database SQL Language Reference* for information about creating 32 KB columns.
- New parameters in the `odbc.ini` file or connection level attributes:
 - `SQL_TRANSLATE_ERRORS = {T|F}` [Default is F (false)]

Any migrated third party ODBC application, which is using the SQL Translation Framework feature, expects that errors returned by the server to be in their native database format, then users can register their translation of errors with the SQL Translation Profile in Oracle Database running in SQL Translation Framework mode. After error translation is registered, then ODBC application users can enable this option, `SQLTranslateErrors = T`, to receive native errors according to their registration.

For more information on SQL Translation Framework, see *Oracle Database Migration Guide*, in particular information about SQL Translation Framework Architecture and Overview, Translation Framework installation and configuration, and migration examples.

See [Table 24-4](#) (page 24-26) for more information.

- Oracle ODBC driver now supports executing a stored procedure, which can return implicit results without using `RefCursor`. This support eases any third party ODBC application, which migrated to Oracle and wants to use this same functionality that was provided by their previous vendors.

See *Oracle Database Migration Guide* for more information about implicit results support by Oracle Database.

- Extended support of `SQLColAttribute()` field identifiers to support Oracle Database auto increment feature. You can use this feature by including Oracle ODBC driver specific header file `sqora.h` in the application. See *Oracle Call Interface Programmer's Guide* for more information about auto increment:
 - `SQL_COLUMN_AUTO_INCREMENT`

Starting from Oracle Database 12c Release 1 (12.1.0.1), Oracle supports auto increment columns so the Oracle ODBC Driver has extended the same support through the existing `SQLColAttribute()` identifier `SQL_COLUMN_AUTO_INCREMENT`. This property is read-only and returns `SQL_TRUE` if the column is auto increment; otherwise, it returns `SQL_FALSE`.
 - `SQL_ORCLATTR_COLUMN_PROP`

Starting from Oracle Database 12c Release 1 (12.1.0.1), Oracle ODBC Driver supports a new driver specific field identifier `SQL_ORCLATTR_COLUMN_PROP`, which returns the attributes of the column. This identifier returns `SQLULEN` value, which has all the column properties, shown as follows:

```

+-----+
| 32 |...| 10 | 9 | 8 |.....| 3 | 2 | 1 |
+-----+

```

```

| | |
| | | -> Column is auto-increment?
| | | -> Auto value is always generated?
| -> If generated by default when null?

```

- ODBC APIs supported in Oracle Database 12c Release 1 (12.1.0.1)

- `SQLMoreResults()`

Implements ODBC support for implicit results. See [Table 24-6](#) (page 24-46) in [Implementation of ODBC API Functions](#) (page 24-46), and [http://msdn.microsoft.com/en-us/library/ms714673\(v=VS.85\).aspx](http://msdn.microsoft.com/en-us/library/ms714673(v=VS.85).aspx) for more information.

New Features for Oracle ODBC Driver Release 11.2.0.1.0

Features of the Oracle ODBC Driver Release 11.2.0.1.0 software for the Microsoft Windows XP, Microsoft Windows 2003 Server, Microsoft Windows Vista, Linux X86-32 (RHEL AS 4,5), Linux X86-64 (RHEL AS 4,5) (32/64 bit), Sun Solaris SPARC64 (9,10) (32,64 bit), IBM AIX 5L 5.2 (32,64 bit), Linux IA64 (64 bit), Linux on Power (32,64 bit), Sun Solaris X64 (64 bit), Hewlett Packard Itanium (32,64 bit) operating systems are described as follows:

- Prefetching of LONG and LONG RAW data

Oracle ODBC driver is enhanced to prefetch LONG or LONG RAW data to improve performance of ODBC applications. To do this, the maximum size of LONG data (`MaxLargeData`) must be set in the registry on Windows (you also must add the registry key `MaxLargeData` in the data source name (DSN)), and set this manually in the `odbc.ini` file on UNIX platforms. This enhancement improves the performance of Oracle ODBC driver up to 10 times, depending on the `MaxLargeData` size set by the user. The default value of `MaxLargeData` is 0. The maximum value for `MaxLargeData` that you can set is 64 KB (65536 bytes).

If the value of `MaxLargeData` is greater than 65536, the data fetched is only 65536 bytes. If your database has LONG or LONG RAW data that is greater than 65536 bytes, then set `MaxLargeData` to 0 (the default value), which causes single-row fetch and fetches complete LONG data. If you pass a buffer size less than the `MaxLargeData` size in nonpolling mode, a data truncation error occurs if the LONG data size in the database is greater than the buffer size.

- Option for using `OCIDescribeAny()` for fetching metadata

When an application makes heavy calls to small packaged procedures that return `REF CURSORS`, a performance improvement can be made by forcing the driver to use `OCIDescribeAny()`. To enable this option, set the value of `UseOCIDescribeAny` in `odbc.ini` to T (True), default value is F (False), on UNIX platforms, and through the registry on Windows.

New Features for Oracle ODBC Driver Release 11.1.0.1.0

Features of the Oracle ODBC Driver Release 11.1.0.1.0 software for the Windows XP, Linux, Solaris, and IBM AIX operating systems are described as follows:

- Disable Rule Hint (DRH Connect String)

Added the new connection option, Disable RULE Hint that allows user to specify the option to select whether to use RULE Hint in catalog APIs. The change has been done to increase the performance of ODBC driver for catalog APIs. The default value for the option is `TRUE`, which means that RULE Hint is not used in catalog APIs by default.

- **Bind Number As Float (BNF Connect String)**
Added the new connection option, Bind Number As Float. By introducing Column Binding for NUMBER Column as FLOAT when column contains float data speeds up the query execution that uses bind variables as FLOAT.
- **Statement Caching**
Added support for OCI statement caching feature that provides and manages a cache of statements for each session. By implementing the support for OCI Statement Caching option, Oracle ODBC Driver performance improves when users parse the same statement multiple times in the same connection. The default value for the statement cache flag is FALSE.

New Features for Oracle ODBC Driver Release 10.1.0.2.0

Features of the Oracle ODBC Driver Release 10.1.0.2.0 software for the Windows 98, Windows 2000, Windows XP, and Windows NT X86 operating systems are described as follows:

- **Bind TIMESTAMP as DATE (BTD Connect String)**
Added the new connection option, Bind TIMESTAMP as DATE, that allows you to bind the ODBC driver SQL_TIMESTAMP data type to the Oracle DATE data type instead of to the Oracle TIMESTAMP data type (which is the default).
- **MONTHNAME (exp) Function**
Added support for the MONTHNAME (exp) function which returns the name of the month represented by the date expression. For example, 'April'.
- **DAYNAME (exp) Function**
Added support for the DAYNAME (exp) function which returns the name of the day represented by the date expression. For example, 'Tuesday'.
- **Instant Client Configuration**
Added support for the Instant Client mode configuration.

Changes for Oracle ODBC Driver Release 10.1.0.2.0

Changed or deprecated features of the Oracle ODBC Driver Release 10.1.0.2.0 include:

- **Disable Microsoft Transaction Server**
Changed the default setting for the Disable Microsoft Transaction Server (MTS) from FALSE to TRUE. By default, MTS support is disabled.
- **Floating Point Data Types**
Changed the mapping of the Oracle data types, BINARY_FLOAT and BINARY_DOUBLE, to map to the ODBC data types, SQL_REAL and SQL_DOUBLE, respectively.
- **SQLGetData Extensions (GDE Connect String)**
Deprecated the SQLGetData Extensions connection in this release. The functionality of this feature is always enabled.
- **Force Retrieval of Longs (FRL Connect String)**
Deprecated the Force Retrieval of Longs connection option in this release. The functionality of this feature is always enabled.

- Translation Options Configuration Tab
Deprecated the Translation Options tab previously found on the Oracle ODBC Driver Configuration dialog box in this release.
- Release Notes
Renamed the Release Notes file from `ODBCReInotes.wri` to `ODBCReInotesUS.htm`.

24.2.1.3 Features Not Supported

Features Not Supported by the Oracle ODBC 3.0 Driver.

The Oracle ODBC Driver does not support the following ODBC 3.0 features:

- Interval data types
- `SQL_C_UBIGINT` and `SQL_C_SBIGINT` C data type identifiers
- Shared connections
- Shared environments
- The `SQL_LOGIN_TIMEOUT` attribute of `SQLSetConnectAttr`

The Oracle ODBC Driver does not support the following SQL string functions:

- `BIT_LENGTH`
- `CHAR_LENGTH`
- `CHARACTER_LENGTH`
- `DIFFERENCE`
- `OCTET_LENGTH`
- `POSITION`

The Oracle ODBC Driver does not support the following SQL numeric functions

- `ACOS`
- `ASIN`
- `ATAN`
- `ATAN2`
- `COT`
- `DEGREES`
- `RADIANS`
- `RAND`
- `ROUND`

The Oracle ODBC Driver does not support the following SQL time, date, and interval functions:

- `CURRENT_DATE`

- CURRENT_TIME
- CURRENT_TIMESTAMP
- EXTRACT
- TIMESTAMPDIFF

24.2.1.4 Files Created by the Installation

Table 24-1 (page 24-10) describes the files that are installed by the Oracle ODBC Driver kit.

Table 24-1 Files Installed by the Oracle ODBC Driver Kit

Description	File Name for Windows Installation	File Name for UNIX Installation
Oracle ODBC Database Access DLL	sqora32.dll	libsqora.so.12.1
Oracle ODBC Driver Setup DLL	sqoras32.dll	None
Oracle ODBC Resource DLL	sqresus.dll	None
Oracle ODBC Resource DLL for Japanese	sqresja.dll	None
Oracle ODBC Driver message file	oraodbcus.msb	oraodbcus.msb
Oracle ODBC Driver message file for Japanese	oraodbcja.msb	oraodbcja.msb
Oracle ODBC Driver release notes	<i>Oracle Database ODBC Driver Release Notes</i>	<i>Oracle Database ODBC Driver Release Notes</i>
Oracle ODBC Driver Instant Client Release Notes	ODBC_IC_Readme_Win.html	ODBC_IC_Readme_Unix.html
Oracle ODBC Driver help file	sqora.htm	sqora.htm
Oracle ODBC Driver help file for Japanese	sqora.htm	sqora.htm
Oracle ODBC Driver Instant Client install script	odbc_install.exe	odbc_update_ini.sh
Oracle ODBC Driver Instant Client uninstall script	odbc_uninstall.exe	None

Microsoft Driver Manager and Administrator Files

See the Microsoft ODBC 3.52 Software Development Kit and Programmer's Reference for the list of files that are installed with Microsoft's ODBC 3.52 Components.

The Microsoft ODBC components are packages in the Microsoft Data Access Component (MDAC) kit. Oracle ODBC driver on Windows has been tested using MDAC version 2.8. This can be downloaded from <http://www.microsoft.com/download/en/search.aspx?q=ODBC+MDAC>

unixODBC Driver Manager and Administrator Files

See the unixODBC readme and INSTALL files for the list of files that are installed with unixODBC Driver Manager.

The unixODBC Driver Manager can be downloaded from <http://www.unixodbc.org/download.html>

24.2.1.5 Driver Conformance Levels

ODBC defines Conformance Levels for drivers in two areas:

- ODBC application programming interface (API)
- ODBC SQL-99 syntax

The Oracle ODBC Driver supports all core API functionality and a limited set of Level 1 and Level 2 functionality. See [API Conformance](#) (page 24-46), for more information.

The Oracle ODBC Driver is broadly compatible with the SQL-99 Core specification which is a superset of the SQL-92 Entry Level specification. Applications must call SQLGetInfo with the appropriate information type to retrieve a list of SQL-99 supported features.

24.2.1.6 Known Limitations

The following are not supported by Oracle ODBC driver:

- ODBC ASYNC interface
- Control-C to cancel execution in an application

24.2.2 Configuration Tasks

Topics:

- [Configuring Oracle Net Services](#) (page 24-11)
- [Configuring the Data Source](#) (page 24-11)
- [Oracle ODBC Driver Configuration Dialog Box](#) (page 24-13)

24.2.2.1 Configuring Oracle Net Services

Before [Configuring the Data Source](#) (page 24-11), you must configure network database services so there is an entry for each Transparent Network Substrate (TNS) Service Name. To do this, use Oracle Net Configuration Assistant (NETCA).

Using NETCA, you can create an entry in the tnsnames.ora file for each TNS Service Name. NETCA is installed when you install Oracle Net Services.

24.2.2.2 Configuring the Data Source

Note:

The following configuration steps are for Windows users. Unix users must use the `odbc_update_ini.sh` file to create a DSN.

After installing the Oracle ODBC Driver and [Configuring Oracle Net Services](#) (page 24-11), and before using the Oracle ODBC Driver, you must configure the data source.

Before an application can communicate with the data source, you must provide configuration information. The configuration information informs the Oracle ODBC Driver as to which information you want to access.

The data source consists of the data that you want to access, its associated operating system, database management system, and network platform used to access the database management system. The data source for requests submitted by the Oracle ODBC Driver is an Oracle database and supports transports available under Oracle Net Services.

To configure or add an Oracle data source:

After you have installed the Oracle ODBC Driver, use the ODBC Data Source Administrator to configure or add an Oracle data source for each of your Oracle databases. The Oracle ODBC Driver uses the information you enter when you add the data source to access the data. Follow these steps:

1. From the start menu, select **Programs, Administrative Tools, Data Sources (ODBC)**. A list of installed drivers is displayed.
2. Click **Add** in the Create New Data Source window and then select the Oracle ODBC Driver in the list of installed drivers.
3. Click **Finish**. The [Oracle ODBC Driver Configuration Dialog Box](#) (page 24-13) is displayed. You must enter the DSN and TNS Service Name. You can provide the other information requested in the dialog box, or you can leave the fields blank and provide the information when you run the application.
4. After you have entered the data, click **OK** or click **Return**.

You can change or delete a data source at any time. The following subtopics explain how to add, change, or delete a data source.

To modify an Oracle data source:

1. From the start menu, select **Programs, Administrative Tools, Data Sources(ODBC)**.
2. In the ODBC Data Source Administrator dialog box, select the data source from the Data Sources list and click **Configure**. The Oracle ODBC Driver Configuration dialog box is displayed.
3. In the [Oracle ODBC Driver Configuration Dialog Box](#) (page 24-13), modify the option values as necessary and click **OK**.

To delete an Oracle data source:

1. From the start menu, select **Programs, Administrative Tools, Data Sources(ODBC)**.
2. In the ODBC Data Source Administrator dialog box, select the data source you want to delete from the Data Sources list.
3. Click **Remove**, and then click **Yes** to confirm the deletion.

24.2.2.3 Oracle ODBC Driver Configuration Dialog Box

Note:

The Oracle ODBC Driver Configuration dialog box is available only for Microsoft Windows users.

Figure 24-3 (page 24-13) is an example of the Oracle ODBC Driver Configuration dialog box.

Figure 24-3 Oracle ODBC Driver Configuration Dialog Box

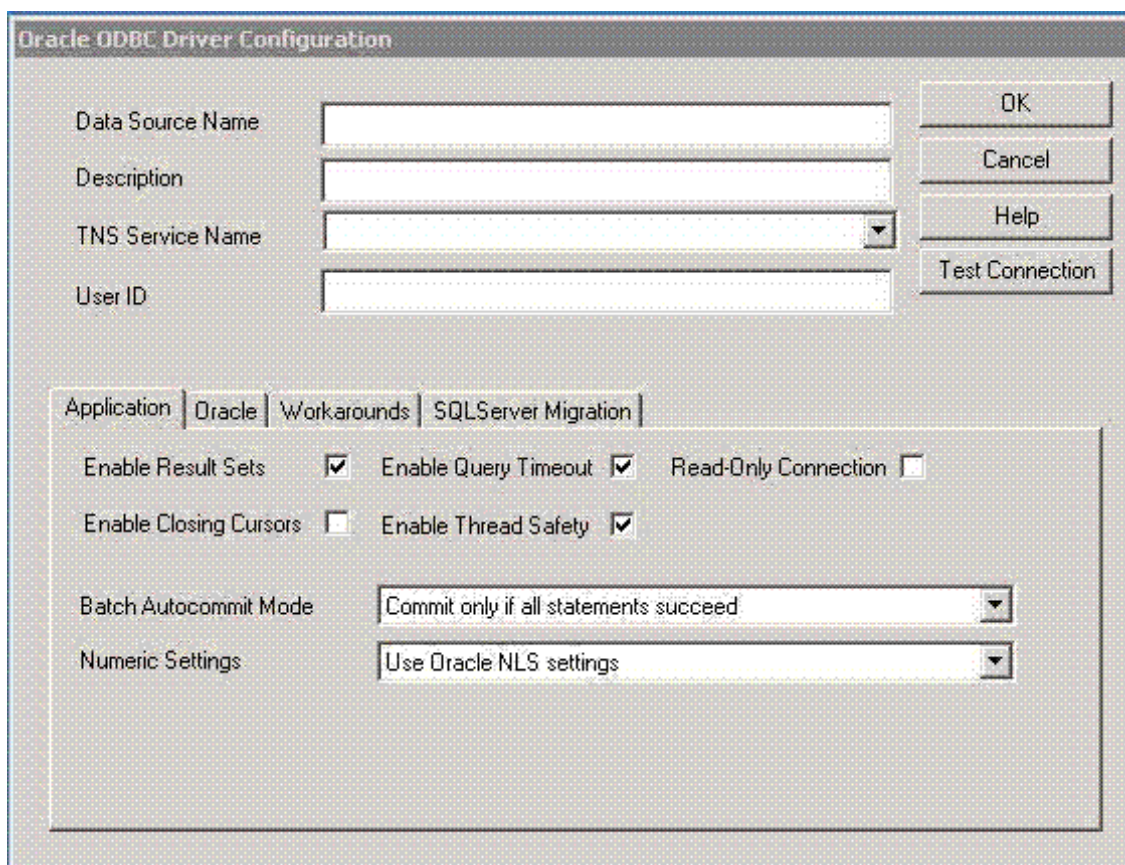

The following list is an explanation of the main setup options and fields found on the Oracle ODBC Driver Configuration dialog box shown in the preceding graphic. The tabs found on the lower half of this dialog box are described in subsequent topics.

- **Data Source Name (DSN)** - The name used to identify the data source to ODBC. For example, "odbc-pc". You must enter a DSN.
- **Description** - A description or comment about the data in the data source. For example, "Hire date, salary history, and current review of all employees." The Description field is optional.
- **TNS Service Name** - The location of the Oracle database from which the ODBC driver will retrieve data. This is the same name entered in [Configuring Oracle Net Services](#) (page 24-11) using the Oracle Net Configuration Assistant (NETCA). For

more information, see the NETCA documentation and [About Using the Oracle ODBC Driver for the First Time](#) (page 24-22). The TNS Service Name can be selected from a pull-down list of available TNS names. For example, "ODBC-PC". You must enter a TNS Service Name.

- **User ID** - The user name of the account on the server used to access the data. For example, "scott". The User ID field is optional.

You must enter the DSN and the TNS Service Name. You can provide the other information requested in the dialog box or you can leave the fields blank and provide the information when you run the application.

In addition to the main setup options previously described, there is a Test Connection button available. The Test Connection button verifies whether the ODBC environment is configured properly by connecting to the database specified by the DSN definition. When you press the Test Connection button, you are prompted for the username and password.

For an explanation of the Options tabs found on the lower half of the Oracle ODBC Driver Configuration dialog box, click any of these links:

[Application Options](#) (page 24-14)

[Oracle Options](#) (page 24-16)

[Workarounds Options](#) (page 24-18)

[SQL Server Migration Options](#) (page 24-20)

Application Options

[Figure 24-4](#) (page 24-15) is an example of the Application Options tab found on the Oracle ODBC Driver Configuration dialog box.

Figure 24-4 The Application Options Tab of the Oracle ODBC Driver Configuration Dialog Box

The following list is an explanation of the fields found on the Application Options tab shown in the preceding graphic:

- **Enable Result Sets** - Enables the processing of Oracle Result Sets. If Result Sets are not required for your application, Result Set support can be disabled. There is a small performance penalty for procedures called from packages not containing Result Sets. Result Sets are enabled by default.
- **Enable Query Timeout** - Enables query timeout for SQL queries. By default, the Oracle ODBC Driver supports the `SQL_ATTR_QUERY_TIMEOUT` attribute for the `SQLSetStmtAttr` function. If this box is not checked, the Oracle ODBC Driver responds with a "not capable" message. Query Timeout is enabled by default.
- **Read-Only Connection** - Check this box to force read-only access. The default is write access.
- **Enable Closing Cursors** - Enables closing cursors. By default, closing cursors is disabled (the field is empty), meaning a call to close a cursor does not force the closing of OCI cursors when this behavior is not desired because it can cause an unnecessary performance hit. Enable closing cursors when you want to force the closing of OCI cursors upon a call to close a cursor.

Note:

There is an impact on performance each time a cursor is closed.

- **Enable Thread Safety** - Thread safety can be disabled for a data source. If thread safety is not required, disabling this option eliminates the overhead of using thread safety. By default, thread safety is enabled.
- **Batch Autocommit Mode** - By default, commit is executed only if all statements succeed.
- **Numeric Settings** - Allows you to choose the numeric settings that determine the decimal and group separator characters when receiving and returning numeric data that is bound as strings. This option allows you to choose Oracle NLS settings (the default setting), Microsoft default regional settings (to provide a way to mirror the Oracle OLE DB driver's behavior for greater interoperability), or US numeric settings (which are necessary when using MS Access or DAO (Database Access Objects) in non-US environments).

The main configuration setup options are described in the [Oracle ODBC Driver Configuration Dialog Box](#) (page 24-13) topic.

Oracle Options

[Figure 24-5](#) (page 24-16) is an example of the Oracle Options tab found on the Oracle ODBC Driver Configuration dialog box.

Figure 24-5 The Oracle Options Tab of the Oracle ODBC Driver Configuration Dialog Box

The screenshot shows the Oracle ODBC Driver Configuration dialog box with the Oracle Options tab selected. The dialog has a title bar and a main area with several sections. At the top right, there are buttons for OK, Cancel, Help, and Test Connection. Below these are input fields for Data Source Name, Description, TNS Service Name (a dropdown menu), and User ID. The Oracle Options tab is active, showing various configuration options. On the left, there are checkboxes for 'Enable LOBs' (checked) and 'Enable Statement Caching' (unchecked), and text boxes for 'Fetch Buffer Size' (64000), 'Cache Buffer Size' (20), 'Max Token Size' (8192), and 'Translate ORA errors' (unchecked). On the right, there is a 'Failover Support' section with a checked 'Enable Failover' checkbox, and text boxes for 'Retry' (10) and 'Delay' (10). At the bottom right of the Oracle Options section, there is a 'Convert Empty String' checkbox (unchecked).

The following list is an explanation of the fields found on the Oracle Options tab shown in the preceding graphic:

- **Fetch Buffer Size** - The amount of memory used to determine how many rows of data the ODBC Driver prefetches at a time from an Oracle database regardless of

the number of rows the application program requests in a single query. However, the number of prefetched rows depends on the width and number of columns specified in a single query. Applications that typically fetch fewer than 20 rows of data at a time improve their response time, particularly over slow network connections or to heavily loaded servers. Setting Fetch Buffer Size too high can make response time worse or consume large amounts of memory.

Note:

When LONG and LOB data types are present, the number of rows prefetched by the ODBC Driver is not determined by the Fetch Buffer Size. The inclusion of the LONG and LOB data types minimizes the performance improvement and could result in excessive memory use. The ODBC Driver disregards Fetch Buffer Size and prefetches a set number of rows only in the presence of the LONG and LOB data types.

- **Enable LOBs** - Enables the writing of Oracle LOBs. If writing Oracle LOBs is not required for your application, LOB support can be disabled. There is a small performance penalty for insert and update statements when LOBs are enabled. LOB writing is enabled by default but disabled for Oracle databases that do not support the LOB data type.
- **Enable Statement Caching** - Enables statement caching feature, which increases the performance of parsing the query, in case the user has to parse the same text of query and related parameters multiple times. The default is disabled.
- **Cache Buffer Size** - The statement cache has a maximum size (number of statements) that can be modified by an attribute on the service context, OCI_ATTR_STMTCACHE_SIZE. The default cache buffer size is 20 that are used only if statement caching option is enabled. Setting cache buffer size to 0 disables statement caching feature.
- **Max Token Size** - Sets the token size to the nearest multiple of 1 KB (1024 bytes) beginning at 4 KB (4096 bytes). The default size is 8 KB (8192 bytes). The maximum value that can be set is 128 KB (131068 bytes).
- **Translate ORA errors** - Any migrated third party ODBC application, which is using the SQL Translation Framework feature, expects that errors returned by the server to be in their native database format, then users can enable this option to receive native errors based on the error translation registered with SQL Translation Profile.
- **Convert Empty String** - Any third party ODBC application that is migrated to Oracle Database requires handling empty string data (Oracle Database does not handle empty string data in table columns), then they can enable this option so that the application can insert empty string data or retrieve empty string data.

Note:

This feature is not implemented for Oracle Database 12c Release 1 (12.1.0.1).

The Failover area of the Oracle Options tab contains the following fields:

- **Enable Failover** - Enables Oracle Fail Safe and Oracle Parallel Server failover retry. This option is an enhancement to the failover capabilities of Oracle Fail Safe

and Oracle Parallel Server. Enable this option to configure additional failover retries. The default is enabled.

- **Retry** - The number of times the connection failover is attempted. The default is 10 attempts.
- **Delay** - The number of seconds to delay between failover attempts. The default is 10 seconds.

Note:

See the Oracle Fail Safe and Oracle Parallel Server documentation on how to set up and use both of these products.

The main configuration setup options are described in the [Oracle ODBC Driver Configuration Dialog Box](#) (page 24-13) topic.

Workarounds Options

[Figure 24-6](#) (page 24-18) is an example of the Workarounds Options tab found on the Oracle ODBC Driver Configuration dialog box.

Figure 24-6 The Workarounds Options Tab of the Oracle ODBC Driver Configuration Dialog Box

Option	Checked	Option	Checked
Bind TIMESTAMP as DATE	<input type="checkbox"/>	Disable SQLDescribeParam	<input type="checkbox"/>
Force SQL_WCHAR Support	<input type="checkbox"/>	Bind NUMBER As FLOAT	<input type="checkbox"/>
Disable Microsoft Transaction Server	<input checked="" type="checkbox"/>	Disable RULE Hint	<input checked="" type="checkbox"/>
Set Metadata Id Default to SQL_TRUE	<input type="checkbox"/>	Use OCIDescribeAny	<input type="checkbox"/>
Pre-fetch size for LONG column data	<input type="text" value="0"/>		

The following list is an explanation of the fields found on the Workarounds Options tab shown in the preceding graphic:

- **Bind TIMESTAMP as DATE** - Check this box to force the Oracle ODBC Driver to bind `SQL_TIMESTAMP` parameters as the Oracle `DATE` type instead of as the Oracle `TIMESTAMP` type (the default). For more information, see [Implementation of Data Types \(Advanced\)](#) (page 24-23).
- **Force SQL_WCHAR Support** - Check this box to enable `SQLDescribeCol`, `SQLColumns`, and `SQLProcedureColumns` to unconditionally return the data type of `SQL_WCHAR` for `SQL_CHAR` columns; `SQL_WVARCHAR` for `SQL_VARCHAR` columns; and `SQL_WLONGVARCHAR` for `SQL_LONGVARCHAR` columns. This feature enables Unicode support in applications that rely on the results of these ODBC calls (for example, ADO). This support is disabled by default.
- **Disable Microsoft Transaction Server** - Clear the check in this box to enable Microsoft Transaction Server (MTS) support. By default, MTS support is disabled.
- **Set Metadata Id Default to SQL_TRUE** - Check this box to change the default value of the `SQL_ATTR_METADATA_ID` connection and statement attribute at connection time to `SQL_TRUE`. Under normal circumstances, `SQL_ATTR_METADATA_ID` would default to `SQL_FALSE`. ODBC calls made by the application to specifically change the value of the attribute after connection time are unaffected by this option and complete their functions as expected. By default, this option is off. The [Implementation of ODBC API Functions](#) (page 24-46) topic provides additional information about the `SQL_ATTR_METADATA_ID` attribute.
- **Prefetch size for LONG column data** - Set this value to prefetch `LONG` or `LONG RAW` data to improve performance of ODBC applications. This enhancement improves the performance of Oracle ODBC driver up to 10 times, depending on the prefetch size set by the user. The default value is 0. The maximum value that you can set is 64 KB (65536 bytes).

If the value of prefetch size is greater than 65536, the data fetched is only 65536 bytes. If you have `LONG` or `LONG RAW` data in the database that is greater than 65536 bytes, then set the prefetch size to 0 (the default value), which causes single-row fetch and fetches complete `LONG` data. If you pass a buffer size less than the prefetch size in nonpolling mode, a data truncation error occurs if the `LONG` data size in the database is greater than the buffer size.
- **Disable SQLDescribeParam** - If the `SQLDescribeParam` function is enabled, the `SQL_VARCHAR` data type is returned for all parameters. If the `Force SQL_WCHAR Support` function is also enabled, the `SQL_WVARCHAR` data type is returned for all parameters. By default, this function is enabled.
- **Bind NUMBER as FLOAT** - Check this box to force the Oracle ODBC Driver to bind `NUMBER` column containing `FLOAT` data as `Float` instead of as the `Binary Float` (the default).
- **Disable RULE Hint** - Clear the check in this box to enable `RULE Hint` specified with catalogue queries. By default, `RULE Hint` option is disabled.
- **Use OCIDescribeAny** - Check this box to gain a performance improvement by forcing the driver to use `OCIDescribeAny()` when an application makes heavy calls to small packaged procedures that return `REF CURSORS`.

The main configuration setup options are described in the [Oracle ODBC Driver Configuration Dialog Box](#) (page 24-13) topic.

SQL Server Migration Options

Figure 24-7 (page 24-20) is an example of the SQL Server Migration Options tab found on the Oracle ODBC Driver Configuration dialog box.

Figure 24-7 The SQL Server Migration Options Tab of the Oracle ODBC Driver Configuration Dialog Box

The fields of the SQL Server Migration Options tab in the preceding graphic are:

- **EXEC Syntax Enabled**, which enables support for SQL Server EXEC syntax. A subprogram call specified in an EXEC statement is translated to its equivalent Oracle subprogram call before being processed by an Oracle database server. By default this option is disabled.
- **Schema**, which is the translated Oracle subprogram assumed to be defined in the user's default schema. However, if all subprograms from the same SQL Server database are migrated to the same Oracle schema with their database name as the schema name, then set this field to database. If all subprograms owned by the same SQL Server user are defined in the same Oracle schema, then set this field to owner. This field is empty by default.

The main configuration setup options are described in the [Oracle ODBC Driver Configuration Dialog Box](#) (page 24-13) topic.

24.2.3 Modifying the oraodbc.ini File

Topics:

- [Reducing Lock Timeout](#) (page 24-21)

24.2.3.1 Reducing Lock Timeout

An Oracle server waits indefinitely for lock conflicts between transactions to be resolved. You can limit the amount of time that an Oracle server waits for locks to be resolved by setting the Oracle ODBC Driver's `LockTimeOut` entry in the `oraodbc.ini` file. The value you enter for the `LockTimeOut` parameter is the number of seconds after which an Oracle server times out if it cannot obtain the requested locks. In the following example, the Oracle server times out after 60 seconds:

```
[Oracle ODBC Driver Common]
LockTimeOut=60
```

24.2.4 Connecting to a Data Source

Topics:

- [Connecting to an Oracle Data Source](#) (page 24-21)

24.2.4.1 Connecting to an Oracle Data Source

To connect to a Data Source, the Oracle ODBC Driver requires that the OCI client software be installed on your computer and the corresponding listener be running on the Oracle server. Oracle Net Services for Windows is a Dynamic Linked Library (DLL) based application. For more information about Oracle Net Services, see the Oracle Net Services documentation.

As part of the connection process, an application can prompt you for information. If an application prompts you for information about an Oracle data source, do the following:

1. In the TNS Service Name box, enter the name of the TNS service.
2. In the User Name box, enter the name you use to access an Oracle Database.
3. In the Password box, enter the password you use to access an Oracle Database.
4. Click **OK**.

An application must connect to a data source to access the data in it. Different applications connect to data sources at different times. For example, an application might connect to a data source only at your request, or it might connect automatically when it starts. For information about when an application connects to a data source, see the documentation for that application.

For additional information, click any of these links:

- For all users:
 - [Configuring the Data Source](#) (page 24-11)
- For programmers:

- [SQLDriverConnect Implementation](#) (page 24-29)
- [Data Source Configuration Options](#) (page 24-55)

24.2.5 Troubleshooting

Topics:

- [About Using the Oracle ODBC Driver for the First Time](#) (page 24-22)
- [Expired Password](#) (page 24-22)

24.2.5.1 About Using the Oracle ODBC Driver for the First Time

Describes useful information about using the Oracle ODBC Driver for the first time.

See the Oracle ODBC Driver developer home [ODBC Developer Center](#) where you can find additional information about Oracle ODBC Driver features, resources, such as the Oracle Instant Client ODBC Installation Guide, the Oracle Instant Client ODBC download site, the Oracle ODBC discussion forum, the Oracle ODBC Driver Development Guide and information about some related technologies.

24.2.5.2 Expired Password

This section contains information about expired passwords.

Expired Password Behavior

If you try to connect to the database and your password has expired, you are prompted to change your password. Upon making a successful password change, you are connected to the database. However, if you try to connect to the database with a `SQLDriverConnect` call with a `SQL_DRIVER_NOPROMPT` parameter value, the Oracle ODBC Driver does not prompt you for the password change. Instead, an error condition results, producing an error message and number that indicates that the password has expired.

24.3 For Advanced Users

Topics:

- [Creating Oracle ODBC Driver TNS Service Names](#) (page 24-22)
- [SQL Statements](#) (page 24-23)
- [Data Types](#) (page 24-23)
- [Implementation of Data Types \(Advanced\)](#) (page 24-23)
- [Limitations on Data Types](#) (page 24-24)
- [Error Messages](#) (page 24-24)

24.3.1 Creating Oracle ODBC Driver TNS Service Names

To create Oracle ODBC Driver TNS Service Names with Oracle Net Services, use the Oracle Net Configuration Assistant (NETCA), which is installed when you install Oracle Net Services. NETCA creates Oracle ODBC Driver TNS Service Name entries in the `tnsnames.ora` file.

24.3.2 SQL Statements

The Oracle ODBC Driver is broadly compatible with the SQL-99 Core specification which is a superset of the SQL-92 Entry Level specification. In addition to Oracle's grammar, the vendor-specific escape sequences outlined in Appendix C of the ODBC specifications are also supported. In accordance with the design of ODBC, the Oracle ODBC Driver passes native SQL syntax to the Oracle database.

See the following related topics:

- [Data Types](#) (page 24-23), if you are an advanced user
- [Implementation of the ODBC SQL Syntax](#) (page 24-47), if you are a programmer

24.3.3 Data Types

The Oracle ODBC Driver maps Oracle database data types to ODBC SQL data types.

Note:

All conversions in Appendix D of the *Microsoft ODBC 3.52 Software Development Kit and Programmer's Reference* are supported for the ODBC SQL data types listed from a call to `SQLGetInfo` with the appropriate information type.

See the following topics for additional information:

- For advanced users:
 - [Implementation of Data Types \(Advanced\)](#) (page 24-23)
 - [Limitations on Data Types](#) (page 24-24)
 - [SQL Statements](#) (page 24-23)
- For programmers:
 - [Implementation of Data Types \(Programming\)](#) (page 24-47)

24.3.4 Implementation of Data Types (Advanced)

Topics:

- [DATE and TIMESTAMP](#) (page 24-23)
- [Floating Point Data Types](#) (page 24-24)

DATE and TIMESTAMP

The semantics of Oracle `DATE` and `TIMESTAMP` data types do not correspond exactly with the ODBC data types with the same names. The Oracle `DATE` data type contains both date and time information while the `SQL_DATE` data type contains only date information. The Oracle `TIMESTAMP` data type also contains date and time information, but it has greater precision in fractional seconds. The ODBC Driver reports the data types of both Oracle `DATE` and `TIMESTAMP` columns as

SQL_TIMESTAMP to prevent information loss. Similarly the ODBC Driver binds SQL_TIMESTAMP parameters as Oracle TIMESTAMP values.

Floating Point Data Types

When connected to a 10.1 or later Oracle server, the ODBC Driver maps the Oracle floating point data types BINARY_FLOAT and BINARY_DOUBLE to the ODBC data types SQL_REAL and SQL_DOUBLE, respectively. In previous releases, SQL_REAL and SQL_DOUBLE mapped to the generic Oracle numeric data type.

See Also:

[DATE and TIMESTAMP Data Types](#) (page 24-57)

24.3.5 Limitations on Data Types

The Oracle ODBC Driver and the Oracle database impose limitations on data types. [Table 24-2](#) (page 24-24) describes these limitations.

Table 24-2 Oracle ODBC Driver and Oracle Database Limitations on Data Types

Limited Data Type	Description
Literals	Oracle database limits literals in SQL statements to 4,000 bytes.
SQL_LONGVARCHAR and SQL_WLONGVARCHAR	Oracle's limit for SQL_LONGVARCHAR data where the column type is LONG is 2,147,483,647 bytes. Oracle's limit for the SQL_LONGVARCHAR data where the column type is CLOB is 4 gigabytes. The limiting factor is the client workstation memory.
SQL_LONGVARCHAR and SQL_LONGVARBINARY	Oracle database allows only a single long data column per table. The long data types are SQL_LONGVARCHAR (LONG) and SQL_LONGVARBINARY (LONG RAW). Oracle recommends you use CLOB and BLOB columns instead. There is no restriction on the number of CLOB and BLOB columns in a table.

24.3.6 Error Messages

When an error occurs, the Oracle ODBC Driver returns the native error number, the SQLSTATE (an ODBC error code), and an error message. The driver derives this information both from errors detected by the driver and errors returned by the Oracle server.

Native Error

For errors that occur in the data source, the Oracle ODBC Driver returns the native error returned to it by the Oracle server. When the Oracle ODBC Driver or the Driver Manager detects an error, the Oracle ODBC Driver returns a native error of zero.

SQLSTATE

For errors that occur in the data source, the Oracle ODBC Driver maps the returned native error to the appropriate SQLSTATE. When the Oracle ODBC Driver detects an error, it generates the appropriate SQLSTATE. When the Driver Manager detects an error, it generates the appropriate SQLSTATE.

Error Message

For errors that occur in the data source, the Oracle ODBC Driver returns an error message based on the message returned by the Oracle server. For errors that occur in the Oracle ODBC Driver or the Driver Manager, the Oracle ODBC Driver returns an error message based on the text associated with the `SQLSTATE`.

Error messages have the following format:

```
[vendor] [ODBC-component] [data-source] error-message
```

The prefixes in brackets ([]) identify the source of the error. [Table 24-3](#) (page 24-25) shows the values of these prefixes returned by the Oracle ODBC Driver. When the error occurs in the data source, the [vendor] and [ODBC-component] prefixes identify the vendor and name of the ODBC component that received the error from the data source.

Table 24-3 Error Message Values of Prefixes Returned by the Oracle ODBC Driver

Error Source	Prefix	Value
Driver Manager	[vendor][ODBC-component][data-source]	[Microsoft/unixODBC][ODBC Driver Manager]N/A
Oracle ODBC Driver	[vendor][ODBC-component][data-source]	[ORACLE][ODBC Driver]N/A
Oracle server	[vendor][ODBC-component][data-source]	[ORACLE][ODBC Driver]N/A

For example, if the error message does not contain the [Ora] prefix shown in the following format, the error is an Oracle ODBC Driver error and should be self-explanatory.

```
[Oracle][ODBC]Error message text here
```

If the error message contains the [Ora] prefix shown in the following format, it is not an Oracle ODBC Driver error.

Note:

Although the error message contains the [Ora] prefix, the actual error may be coming from one of several sources.

```
[Oracle][ODBC][Ora]Error message text here
```

If the error message text starts with the following prefix, you can obtain more information about the error in the Oracle server documentation.

```
ORA-
```

Oracle Net Services errors and Trace logging are located under the `ORACLE_HOME \NETWORK` directory on Windows systems or the `ORACLE_HOME/NETWORK` directory on UNIX systems where the OCI software is installed and specifically in the log and

trace directories respectively. Database logging is located under the `ORACLE_HOME \RDBMS` directory on Windows systems or the `ORACLE_HOME/rdbms` directory on UNIX systems where the Oracle server software is installed.

See the Oracle server documentation for more information about server error messages.

24.4 For Programmers

Topics:

- [Format of the Connection String](#) (page 24-26)
- [SQLDriverConnect Implementation](#) (page 24-29)
- [Reducing Lock Timeout in a Program](#) (page 24-29)
- [Linking with odbc32.lib \(Windows\) or libodbc.so \(UNIX\)](#) (page 24-29)
- [Information About rowids](#) (page 24-30)
- [Rowids in a WHERE Clause](#) (page 24-30)
- [Enabling Result Sets](#) (page 24-30)
- [Enabling EXEC Syntax](#) (page 24-35)
- [Enabling Event Notification for Connection Failures in an Oracle RAC Environment](#) (page 24-36)
- [Using Implicit Results Feature Through ODBC](#) (page 24-40)
- [About Supporting Oracle TIMESTAMP WITH TIME ZONE and TIMESTAMP WITH LOCAL TIME ZONE Column Type in ODBC](#) (page 24-41)
- [About the Effect of Setting ORA_SDTZ in Oracle Clients \(OCI, SQL*Plus, Oracle ODBC driver, and Others\)](#) (page 24-43)
- [Supported Functionality](#) (page 24-46)
- [Unicode Support](#) (page 24-47)
- [Performance and Tuning](#) (page 24-54)

24.4.1 Format of the Connection String

Table 24-4 (page 24-26) describes keywords that can be included in the connection string argument of the `SQLDriverConnect` function call. Missing keywords are read from the Administrator entry for the data source. Values specified in the connection string override those contained in the Administrator entry. See the *Microsoft ODBC 3.52 Software Development Kit and Programmer's Reference* for more information about the `SQLDriverConnect` function.

Table 24-4 Keywords that Can Be Included in the Connection String Argument of the SQLDriverConnect Function Call

Keyword	Meaning	Comments
DSN	ODBC Data Source Name	User-supplied name.

Table 24-4 (Cont.) Keywords that Can Be Included in the Connection String Argument of the `SQLDriverConnect` Function Call

Keyword	Meaning	Comments
DBQ	TNS Service Name	User-supplied name.
UID	User ID or User Name	User-supplied name.
PWD	Password	User-supplied password. Specify PWD=; for an empty password.
DBA	Database Attribute	W=write access. R=read-only access.
APA	Applications Attributes	T=Thread Safety Enabled. F=Thread Safety Disabled.
RST	Result Sets	T=Result Sets Enabled. F=Result Sets Disabled.
QTO	Query Timeout Option	T=Query Timeout Enabled. F=Query Timeout Disabled.
CSR	Close Cursor	T=Close Cursor Enabled. F=Close Cursor Disabled.
BNF	Bind NUMBER as FLOAT	T=Bind NUMBER as FLOAT. F=Bind NUMBER as NUMBER.
DRH	Disable Rule Hint	T=Disable Rule Hint. F=Enable Rule Hint.
BAM	Batch Autocommit Mode	IfAllSuccessful=Commit only if all statements are successful (old behavior). UpToFirstFailure=Commit up to first failing statement (V7 ODBC behavior). AllSuccessful=Commit all successful statements (only when connected to an Oracle database; against other databases, same behavior as V7).
FBS	Fetch Buffer Size	User-supplied numeric value (specify a value in bytes of 0 or greater). The default is 60,000 bytes.
FEN	Failover	T=Failover Enabled. F=Failover Disabled.
FRC	Failover Retry Count	User-supplied numeric value. The default is 10.
FDL	Failover Delay	User-supplied numeric value. The default is 10.
LOB	LOB Writes	T=LOBs Enabled. F=LOBs Disabled.

Table 24-4 (Cont.) Keywords that Can Be Included in the Connection String Argument of the `SQLDriverConnect` Function Call

Keyword	Meaning	Comments
MTS	Microsoft Transaction Server Support	T=Disabled. F=Enabled.
FWC	Force <code>SQL_WCHAR</code> Support	T=Force <code>SQL_WCHAR</code> Enabled. F=Force <code>SQL_WCHAR</code> Disabled.
EXC	EXEC Syntax	T=EXEC Syntax Enabled. F=EXEC Syntax Disabled.
XSM	Schema Field	Default=Default. Database=Database Name. Owner=Owner Name.
MDI	Set Metadata ID Default	T= <code>SQL_ATTR_METADATA_ID</code> defaults to <code>SQL_TRUE</code> . F= <code>SQL_ATTR_METADATA_ID</code> defaults to <code>SQL_FALSE</code> .
DPM	Disable <code>SQLDescribeParam</code>	T= <code>SQLDescribeParam</code> Disabled. F= <code>SQLDescribeParam</code> Enabled.
BTD	Bind <code>TIMESTAMP</code> as <code>DATE</code>	T=Bind <code>SQL_TIMESTAMP</code> as Oracle <code>DATE</code> F=Bind <code>SQL_TIMESTAMP</code> as Oracle <code>TIMESTAMP</code>
NUM	Numeric Settings	NLS=Use Oracle NLS numeric settings (to determine the decimal and group separator). MS=Use Microsoft regional settings. US=Use US settings.
ODA	Use <code>OCIDescribeAny()</code>	T= Use <code>OCIDescribeAny()</code> call to gain performance improvement when application makes heavy calls to small packaged procedures that return <code>REF CURSORS</code> . F= Do not use <code>OCIDescribeAny()</code> . By default, use <code>OCIDescribeAny()</code> value is <code>FALSE</code> .
STE	SQL Translate ORA Errors Specifies whether the Oracle ODBC Driver is to translate the Oracle error codes	T=Translate ORA errors. F=Do not translate any ORA error. By default, <code>SQLTranslateErrors</code> is <code>FALSE</code> .
TSZ	Token Size	User-supplied numeric value. Sets the token size to the nearest multiple of 1 KB (1024 bytes) beginning at 4 KB (4096 bytes). The default size is 8 KB (8192 bytes). The maximum value that can be set is 128 KB (131068 bytes).

If the following keyword is specified in the connection string, the Oracle ODBC Driver does not read values defined from the Administrator:

```
DRIVER={Oracle ODBC Driver}
```

Examples of valid connection strings are:

```
1) DSN=Personnel;UID=Kotzwinkle;PWD=;2) DRIVER={Oracle ODBC Driver};UID=Kotzwinkle;PWD=whatever;DBQ=instl_alias;DBA=W;
```

For additional information, click any of these links:

- [Connecting to an Oracle Data Source](#) (page 24-21), for all users
- [SQLDriverConnect Implementation](#) (page 24-29), for programmers

24.4.2 SQLDriverConnect Implementation

[Table 24-5](#) (page 24-29) describes the keywords required by the SQLDriverConnect connection string.

Table 24-5 Keywords Required by the SQLDriverConnect Connection String

Keyword	Description
DSN	The name of the data source.
DBQ	The TNS Service Name. See Creating Oracle ODBC Driver TNS Service Names (page 24-22). For more information, see the Oracle Net Services documentation.
UID	The user login ID or user name.
PWD	The user-specified password.

24.4.3 Reducing Lock Timeout in a Program

The Oracle server waits indefinitely for lock conflicts between transactions to be resolved. You can limit the amount of time that the Oracle server waits for locks to be resolved by calling the ODBC `SQLSetConnectAttr` function before connecting to the data source. Specify a nonzero value for the `SQL_ATTR_QUERY_TIMEOUT` attribute in the ODBC `SQLSetStmtAttr` function.

If you specify a lock timeout value using the ODBC `SQLSetConnectAttr` function, it overrides any value specified in the `oraodbc.ini` file. Refer to [Reducing Lock Timeout](#) (page 24-21) for more information on specifying a value in the `oraodbc.ini` file.

24.4.4 Linking with `odbc32.lib` (Windows) or `libodbc.so` (UNIX)

For Windows platforms, when you link your program, you must link it with the import library `odbc32.lib`.

For UNIX platforms, an ODBC application must be linked to `libodbc.so`.

24.4.5 Information About rowids

The ODBC `SQLSpecialColumns` function returns information about the columns in a table. When used with the Oracle ODBC Driver, it returns information about the Oracle rowids associated with an Oracle table.

24.4.6 Rowids in a WHERE Clause

Rowids can be used in the `WHERE` clause of an SQL statement. However, the rowid value must be presented in a parameter marker.

24.4.7 Enabling Result Sets

Oracle reference cursors (Result Sets) allow an application to retrieve data using stored procedures and stored functions. The following information identifies how to use reference cursors to enable Result Sets through ODBC.

- The ODBC syntax for calling stored procedures must be used. Native PL/SQL is not supported through ODBC. The following identifies how to call the procedure or function without a package and within a package. The package name in this case is `RSET`.

```
Procedure call:
{CALL Example1(?)}
{CALL RSET.Example1(?)}
Function Call:
{? = CALL Example1(?)}
{? = CALL RSET.Example1(?)}
```

- The PL/SQL reference cursor parameters are omitted when calling the procedure. For example, assume procedure `Example2` is defined to have four parameters. Parameters 1 and 3 are reference cursor parameters and parameters 2 and 4 are character strings. The call is specified as:

```
{CALL RSET.Example2("Literal 1", "Literal 2")}
```

The following example application shows how to return a Result Set using the Oracle ODBC Driver:

```
/*
 * Sample Application using Oracle reference cursors via ODBC
 *
 * Assumptions:
 *
 * 1) Oracle Sample database is present with data loaded for the EMP table.
 * 2) Two fields are referenced from the EMP table ename and mgr.
 * 3) A data source has been setup to access the sample database.
 *
 * Program Description:
 *
 * Abstract:
 *
 * This program demonstrates how to return result sets using
 * Oracle stored procedures
 *
 * Details:
 *
 * This program:
 * Creates an ODBC connection to the database.
```

```

* Creates a Packaged Procedure containing two result sets.
* Executes the procedure and retrieves the data from both result sets.
* Displays the data to the user.
* Deletes the package then logs the user out of the database.
*
*
* The following is the actual PL/SQL this code generates to
* create the stored procedures.
*
* DROP PACKAGE ODBCRefCur;
*
* CREATE PACKAGE ODBCRefCur AS
* TYPE ename_cur IS REF CURSOR;
* TYPE mgr_cur IS REF CURSOR;
* PROCEDURE EmpCurs(Ename IN OUT ename_cur, Mgr IN OUT mgr_cur, pjob IN VARCHAR2);
* END;
*
* CREATE or REPLACE PACKAGE BODY ODBCRefCur AS
* PROCEDURE EmpCurs(Ename IN OUT ename_cur, Mgr IN OUT mgr_cur, pjob IN VARCHAR2)
* AS
* BEGIN
* IF NOT Ename%ISOPEN
* THEN
* OPEN Ename for SELECT ename from emp;
* END IF;
* IF NOT Mgr%ISOPEN
* THEN
* OPEN Mgr for SELECT mgr from emp where job = pjob;
* END IF;
* END;
* END;
*
*/

/* Include Files */
#ifdef WIN32
#include <windows.h>
#endif
#include <stdio.h>
#include <sql.h>
#include <sqlext.h>

/* Defines */
#define JOB_LEN 9
#define DATA_LEN 100
#define SQL_STMT_LEN 500

/* Procedures */
void DisplayError(SWORD HandleType, SQLHANDLE hHandle, char *Module);

/* Main Program */
int main()
{
    SQLHENV hEnv;
    SQLHDBC hDbc;
    SQLHSTMT hStmt;
    SQLRETURN rc;
    char *DefUserName ="scott";
    char *DefPassWord ="tiger";
    SQLCHAR ServerName[DATA_LEN];
    SQLCHAR *pServerName=ServerName;

```

```
SQLCHAR UserName[DATA_LEN];
SQLCHAR *pUserName=UserName;
SQLCHAR PassWord[DATA_LEN];
SQLCHAR *pPassWord=PassWord;
char Data[DATA_LEN];
SQLINTEGER DataLen;
char error[DATA_LEN];
char *charptr;
SQLCHAR SqlStmt[SQL_STMT_LEN];
SQLCHAR *pSqlStmt=SqlStmt;
char *pSalesMan = "SALESMAN";
SQLINTEGER sqlNts=SQL_NTS;

/* Allocate the Environment Handle */
rc = SQLAllocHandle( SQL_HANDLE_ENV, SQL_NULL_HANDLE, &hEnv );
if (rc != SQL_SUCCESS)
{
    printf( "Cannot Allocate Environment Handle/n");
    printf( "/nHit Return to Exit/n");
    charptr = gets ((char *)error);
    exit(1);
}

/* Set the ODBC Version */
rc = SQLSetEnvAttr(hEnv, SQL_ATTR_ODBC_VERSION, (void *)SQL_OV_ODBC3, 0);
if (rc != SQL_SUCCESS)
{
    printf("Cannot Set ODBC Version/n");
    printf("/nHit Return to Exit/n");
    charptr = gets((char *)error);
    exit(1);
}

/* Allocate the Connection handle */
rc = SQLAllocHandle(SQL_HANDLE_DBC, hEnv, &hDbc);
if (rc != SQL_SUCCESS)
{
    printf("Cannot Allocate Connection Handle/n");
    printf("/nHit Return to Exit/n");
    charptr = gets((char*) error);
    exit(1);
}

/* Get User Information */
lstrcpy((char*) pUserName, DefUserName);
lstrcpy((char*) pPassWord, DefPassWord);

/* Data Source name */
printf( "/nEnter the ODBC Data Source Name/n" );
charptr = gets((char*) ServerName);

/* User Name */
printf("/nEnter User Name Default [%s]/n", pUserName);
charptr = gets((char*) UserName);
if (*charptr == '/0')
{
    lstrcpy((char*) pUserName, (char*) DefUserName);
}

/* Password */
```

```

printf ("\nEnter Password Default [%s]/n", pPassWord);
charptr = gets((char*) PassWord);
if (*charptr == '/0')
{
    lstrcpy((char*) pPassWord, (char*) DefPassWord);
}

/* Connection to the database */
rc = SQLConnect(hDbc, pServerName, (SQLSMALLINT) lstrlen((char *)pServerName),
pUserName,
                (SQLSMALLINT) lstrlen((char*)pUserName), pPassWord,
                (SQLSMALLINT) lstrlen((char *)pPassWord));
if (rc != SQL_SUCCESS)
{
    DisplayError(SQL_HANDLE_DBC, hDbc, "SQLConnect");
}

/* Allocate a Statement */
rc = SQLAllocHandle(SQL_HANDLE_STMT, hDbc, &hStmt);
if (rc != SQL_SUCCESS)
{
    printf("Cannot Allocate Statement Handle/n");
    printf("\nHit Return to Exit/n");
    charptr = gets((char *)error);
    exit(1);
}

/* Drop the Package */
lstrcpy((char *) pSqlStmt, "DROP PACKAGE ODBCRefCur");
rc = SQLExecDirect(hStmt, pSqlStmt, lstrlen((char *)pSqlStmt));

/* Create the Package Header */
lstrcpy((char *) pSqlStmt, "CREATE PACKAGE ODBCRefCur AS/n" );
lstrcat((char *) pSqlStmt, " TYPE ename_cur IS REF CURSOR;/n" );
lstrcat((char *) pSqlStmt, " TYPE mgr_cur IS REF CURSOR;/n" );
lstrcat((char *) pSqlStmt, " PROCEDURE EmpCurs (Ename IN OUT ename_cur," );
lstrcat((char *) pSqlStmt, " Mgr IN OUT mgr_cur,pjob IN VARCHAR2);/n/n");
lstrcat((char *) pSqlStmt, "END;/n" );

rc = SQLExecDirect(hStmt, pSqlStmt, lstrlen((char *)pSqlStmt));
if (rc != SQL_SUCCESS)
{
    DisplayError(SQL_HANDLE_STMT, hStmt, "SQLExecDirect");
}

/* Create the Package Body */
lstrcpy((char *) pSqlStmt, "CREATE PACKAGE BODY ODBCRefCur AS/n" );
lstrcat((char *) pSqlStmt, " PROCEDURE EmpCurs (Ename IN OUT ename_cur," );
lstrcat((char *) pSqlStmt, " Mgr IN OUT mgr_cur, pjob IN VARCHAR2)/n" );
lstrcat((char *) pSqlStmt, " AS/n" );
lstrcat((char *) pSqlStmt, " BEGIN/n" );
lstrcat((char *) pSqlStmt, " IF NOT Ename%ISOPEN/n" );
lstrcat((char *) pSqlStmt, " THEN/n" );
lstrcat((char *) pSqlStmt, " OPEN Ename for SELECT ename from emp;/n" );
lstrcat((char *) pSqlStmt, " END IF;/n/n" );
lstrcat((char *) pSqlStmt, " IF NOT Mgr%ISOPEN/n THEN/n" );
lstrcat((char *) pSqlStmt, " OPEN Mgr for SELECT mgr from emp where job = pjob;/
n");
lstrcat((char *) pSqlStmt, " END IF;/n" );
lstrcat((char *) pSqlStmt, " END;/n" );

```

```
lstrcat((char *) pSqlStmt, "END;/n" );

rc = SQLExecDirect(hStmt, pSqlStmt, strlen((char *)pSqlStmt));
if(rc != SQL_SUCCESS)
    DisplayError(SQL_HANDLE_STMT, hStmt, "SQLExecDirect");

/* Bind the Parameter */
rc = SQLBindParameter(hStmt, 1, SQL_PARAM_INPUT, SQL_C_CHAR, SQL_CHAR, JOB_LEN, 0,
pSalesMan, 0, &sqlnts);

/* Call the Store Procedure which executes the Result Sets */
strcpy( (char *) pSqlStmt, "{CALL ODBCRefCur.EmpCurs(?)}");

rc = SQLExecDirect(hStmt, pSqlStmt, strlen((char *)pSqlStmt));
if(rc != SQL_SUCCESS)
    DisplayError(SQL_HANDLE_STMT, hStmt, "SQLExecDirect");

/* Bind the Data */
rc = SQLBindCol(hStmt, 1, SQL_C_CHAR, Data, sizeof(Data), &DataLen);
if(rc != SQL_SUCCESS)
    DisplayError(SQL_HANDLE_STMT, hStmt, "SQLBindCol");

/* Get the data for Result Set 1 */
printf("/nEmployee Names/n/n");

while(rc == SQL_SUCCESS)
{
    rc = SQLFetch(hStmt);
    if(rc == SQL_SUCCESS)
        printf("%s/n", Data);
    else
        if(rc != SQL_NO_DATA)
            DisplayError(SQL_HANDLE_STMT, hStmt, "SQLFetch");
}

printf( "/nFirst Result Set - Hit Return to Continue/n");
charptr = gets ((char *)error);

/* Get the Next Result Set */
rc = SQLMoreResults( hStmt );
if(rc != SQL_SUCCESS)
    DisplayError(SQL_HANDLE_STMT, hStmt, "SQLMoreResults");

/* Get the data for Result Set 2 */
printf("/nManagers/n/n");
while (rc == SQL_SUCCESS)
{
    rc = SQLFetch(hStmt);
    if(rc == SQL_SUCCESS)
        printf("%s/n", Data);
    else
        if (rc != SQL_NO_DATA)
            DisplayError(SQL_HANDLE_STMT, hStmt, "SQLFetch");
}

printf("/nSecond Result Set - Hit Return to Continue/n");
charptr = gets((char *)error);

/* Should Be No More Results Sets */
rc = SQLMoreResults( hStmt );
```

```

if (rc != SQL_NO_DATA)
    DisplayError(SQL_HANDLE_STMT, hStmt, "SQLMoreResults");

/* Drop the Package */
lstrcpy((char *)pSqlStmt, "DROP PACKAGE ODBCRefCur");
rc = SQLExecDirect(hStmt, pSqlStmt, strlen((char *)pSqlStmt));

/* Free handles close connections to the database */
SQLFreeHandle( SQL_HANDLE_STMT, hStmt );
SQLDisconnect( hDbc );
SQLFreeHandle( SQL_HANDLE_DBC, hDbc );
SQLFreeHandle( SQL_HANDLE_ENV, hEnv );

printf( "\nAll Done - Hit Return to Exit\n");
charptr = gets ((char *)error);
return(0);
}

/* Display Error Messages */
void DisplayError( SWORD HandleType, SQLHANDLE hHandle, char *Module )
{
    SQLCHAR MessageText[255];
    SQLCHAR SQLState[80];
    SQLRETURN rc=SQL_SUCCESS;
    LONG NativeError;
    SWORD RetLen;
    SQLCHAR error[25];
    char *charptr;

    rc = SQLGetDiagRec(HandleType, hHandle, 1, SQLState, &NativeError, MessageText,
255, &RetLen);
    printf( "Failure Calling %s\n", Module );
    if (rc == SQL_SUCCESS || rc == SQL_SUCCESS_WITH_INFO)
    {
        printf( "/t/t/t State: %s\n", SQLState);
        printf( "/t/t/t Native Error: %d\n", NativeError );
        printf( "/t/t/t Error Message: %s\n", MessageText );
    }

    printf( "\nHit Return to Exit\n");
    charptr = gets ((char *)error);
    exit(1);
}

```

24.4.8 Enabling EXEC Syntax

If the syntax of your SQL Server EXEC statement can be readily translated to an equivalent Oracle procedure call without change, the Oracle ODBC Driver can translate it if you enable this option.

The complete name of a SQL Server procedure consists of up to four identifiers:

- server name
- database name
- owner name
- procedure name

The format for the name is:

```
[[[server.][database.][owner_name].]procedure_name
```

During the migration of the SQL Server database to Oracle, the definition of each SQL Server procedure (or function) is converted to its equivalent Oracle syntax and is defined in a schema in Oracle. Migrated procedures are often reorganized (and created in schemas) in one of these ways:

- All procedures are migrated to one schema (the default option).
- All procedures defined in one SQL Server database are migrated to the schema named with that database name.
- All procedures owned by one user are migrated to the schema named with that user's name.

To support these three ways of organizing migrated procedures, you can specify one of these schema name options for translating procedure names. Object names in the translated Oracle procedure call are not case-sensitive.

24.4.9 Enabling Event Notification for Connection Failures in an Oracle RAC Environment

If the `SQL_ORCLATTR_FAILOVER_CALLBACK` and `SQL_ORCLATTR_FAILOVER_HANDLE` attributes of the `SQLSetConnectAttr` function are set when a connection failure occurs in an Oracle Real Application Clusters (Oracle RAC) Database environment, event notification is enabled. Both attributes are set using the `SQLSetConnectAttr` function. The symbols for the new attributes are defined in the file `sqora.h`.

The `SQL_ORCLATTR_FAILOVER_CALLBACK` attribute specifies the address of a routine to call when a failure event takes place.

The `SQL_ORCLATTR_FAILOVER_HANDLE` attribute specifies a context handle that is passed as a parameter in the callback routine. This attribute is necessary for the ODBC application to determine which connection the failure event is taking place on.

The function prototype for the callback routine is:

```
void failover_callback(void *handle, SQLINTEGER fo_code)
```

The 'handle' parameter is the value that was set by the `SQL_ORCLATTR_FAILOVER_HANDLE` attribute. Null is returned if the attribute has not been set.

The `fo_code` parameter identifies the failure event which is taking place. The failure events map directly to the events defined in the OCI programming interface. The list of possible events is:

- `ODBC_FO_BEGIN`
- `ODBC_FO_ERROR`
- `ODBC_FO_ABORT`
- `ODBC_FO_REAUTH`
- `ODBC_FO_END`

The following is a sample program which demonstrates using this feature:

```

/*
    NAME
    ODBC_CALLBACK_TEST

    DESCRIPTION
    Simple program to demonstrate the connection failover callback feature.

    PUBLIC FUNCTION(S)
    main

    PRIVATE FUNCTION(S)

    NOTES

    Command Line: ODBC_CALLBACK_TEST filename [odbc-driver]

*/

#include <windows.h>
#include <tchar.h>
#include <malloc.h>
#include <stdio.h>
#include <string.h>
#include <sql.h>
#include <sqlext.h>
#include "sqora.h"

/*
** Function Prototypes
*/
void display_errors(SQLSMALLINT HandleType, SQLHANDLE Handle);
void failover_callback(void *Handle, SQLINTEGER fo_code);

/*
** Macros
*/
#define ODBC_STS_CHECK(sts) \
    if (sts != SQL_SUCCESS) \
    { \
        display_errors(SQL_HANDLE_ENV, hEnv); \
        display_errors(SQL_HANDLE_DBC, hDbc); \
        display_errors(SQL_HANDLE_STMT, hStmt); \
        return FALSE; \
    }

/*
** ODBC Handles
*/
SQLHENV *hEnv = NULL; // ODBC Environment Handle
SQLHANDLE *hDbc = NULL; // ODBC Connection Handle
SQLHANDLE *hStmt = NULL; // ODBC Statement Handle

/*
** Connection Information
*/
TCHAR *dsn = _T("odbctest");
TCHAR *uid = _T("scott");
TCHAR *pwd = _T("tiger");
TCHAR *szSelect = _T("select * from emp");

/*

```

```
** MAIN Routine
*/
main(int argc, char **argv)
{
    SQLRETURN rc;

    /*
    ** Allocate handles
    */
    rc = SQLAllocHandle(SQL_HANDLE_ENV, SQL_NULL_HANDLE, (SQLHANDLE *)&hEnv);
    ODBC_STS_CHECK(rc)

    rc = SQLSetEnvAttr(hEnv, SQL_ATTR_ODBC_VERSION, (SQLPOINTER)SQL_OV_ODBC3, 0);
    ODBC_STS_CHECK(rc);

    rc = SQLAllocHandle(SQL_HANDLE_DBC, hEnv, (SQLHANDLE *)&hDbc);
    ODBC_STS_CHECK(rc);

    /*
    ** Connect to the database
    */
    rc = SQLConnect(hDbc, dsn, (SQLSMALLINT)_tcslen(dsn),
        uid, (SQLSMALLINT)_tcslen(uid),
        pwd, (SQLSMALLINT)_tcslen(pwd));
    ODBC_STS_CHECK(rc);

    /*
    ** Set the connection failover attributes
    */
    rc = SQLSetConnectAttr(hDbc, SQL_ORCLATTR_FAILOVER_CALLBACK, &failover_callback,
0);
    ODBC_STS_CHECK(rc);

    rc = SQLSetConnectAttr(hDbc, SQL_ORCLATTR_FAILOVER_HANDLE, hDbc, 0);
    ODBC_STS_CHECK(rc);

    /*
    ** Allocate the statement handle
    */
    rc = SQLAllocHandle(SQL_HANDLE_STMT, hDbc, (SQLHANDLE *)&hStmt);
    ODBC_STS_CHECK(rc);

    /*
    ** Wait for connection failovers
    */
    while (TRUE)
    {
        Sleep(5000);
        rc = SQLExecDirect(hStmt, szSelect, _tcslen(szSelect));
        ODBC_STS_CHECK(rc);

        rc = SQLFreeStmt(hStmt, SQL_CLOSE);
        ODBC_STS_CHECK(rc);
    }

    /*
    ** Free up the handles and close the connection
    */
    rc = SQLFreeHandle(SQL_HANDLE_STMT, hStmt);
    ODBC_STS_CHECK(rc);
}
```

```

rc = SQLDisconnect(hDbc);
ODBC_STS_CHECK(rc);

rc = SQLFreeHandle(SQL_HANDLE_DBC, hDbc);
ODBC_STS_CHECK(rc);

rc = SQLFreeHandle(SQL_HANDLE_ENV, hEnv);
ODBC_STS_CHECK(rc);

return TRUE;
}

/*
** Failover Callback Routine
*/
void failover_callback(void *Handle, SQLINTEGER fo_code)
{
    switch(fo_code)
    {
        case ODBC_FO_BEGIN:
            printf("ODBC_FO_BEGIN received\n");
            break;

        case ODBC_FO_ERROR:
            printf("ODBC_FO_ERROR received\n");
            break;

        case ODBC_FO_ABORT:
            printf("ODBC_FO_ABORT received\n");
            break;

        case ODBC_FO_REAUTH:
            printf("ODBC_FO_REAUTH received\n");
            break;

        case ODBC_FO_END:
            printf("ODBC_FO_END received\n");
            break;

        default:
            printf("Invalid or unknown ODBC failover code received\n");
            break;
    }
    return;
}

/*
** Retrieve the errors associated with the handle passed
** and display them.
*/
void display_errors(SQLSMALLINT HandleType, SQLHANDLE Handle)
{
    SQLTCHAR MessageText[256];
    SQLTCHAR SqlState[5+1];
    SQLSMALLINT i=1;
    SQLINTEGER NativeError;
    SQLSMALLINT TextLength;
    SQLRETURN sts = SQL_SUCCESS;

    if (Handle == NULL) return;

```

```

/* Make sure all SQLState text is null terminated */
SqlState[5] = '\0';

/*
** Fetch and display all diagnostic records that exist for this handle
*/
while (sts == SQL_SUCCESS)
{
    NativeError = 0;
    TextLength = 0;

    sts = SQLGetDiagRec(HandleType, Handle, i, SqlState, &NativeError, (SQLTCHAR
*)&MessageText, sizeof(MessageText), &TextLength);
    if (sts == SQL_SUCCESS)
    {
        printf("[%s]%s\n", SqlState, MessageText);
        if (NativeError != 0)
            printf("Native Error Code: %d\n", NativeError);
        i++;
    }
}
return;
}

```

24.4.10 Using Implicit Results Feature Through ODBC

Use this option when you migrate any third party ODBC application to Oracle Database and you want to use implicit results functionality as supported by the previous vendor. Oracle ODBC driver supports implicit results with stored procedures or an anonymous PL/SQL block. For the current release, implicit results are returned only for SELECT statements.

The following code example shows an example ODBC test case using an anonymous SQL script for implicit results.

```

const char *query1="declare \
    c1 sys_refcursor; \
    c2 sys_refcursor; \
begin \
    open c1 for select empno,ename from emp where rownum<=3; \
    dbms_sql.return_result(c1); \
    open c2 for select empno,ename from emp where rownum<=3; \
    dbms_sql.return_result(c2); end; ";

int main( )
{
    ...
    ...
    //Allocate all required handles and establish a connection to the database.

    //Prepare and execute the above anonymous PL/SQL block
    SQLPrepare (hstmt, (SQLCHAR *) query1, SQL_NTS);
    SQLExecute(hstmt);

    //Bind the columns for the results from the first SELECT statement in an anonymous
    block.
    SQLBindCol (hstmt, 1, SQL_C_ULONG, &eno, 0, &jind);
    SQLBindCol (hstmt, 2, SQL_C_CHAR, empname, sizeof (empname),&enind);

    //Fetch implicit results through the SQLFetch( ) call.

```

```

        while((retCode = SQLFetch(hstmt)) != SQL_NO_DATA)
        {
//Do whatever you want to do with the data.
        }

        retCode = SQLMoreResults(hstmt);

        if(retCode == SQL_SUCCESS)
        {
            printf("SQLMoreResults returned with SQL_SUCCESS\n");

//Bind the columns for the results from the second SELECT statement in an anonymous
block.
            SQLBindCol (hstmt, 1, SQL_C_ULONG, &eno, 0, &jind);
            SQLBindCol (hstmt, 2, SQL_C_CHAR, empname, sizeof (empname), &enind);

//Fetch implicit results through the SQLFetch( ) call.
            while((retCode = SQLFetch(hstmt)) != SQL_NO_DATA)
            {
//Do whatever you want to do with data.
            }
        }
    }
}

```

24.4.11 About Supporting Oracle **TIMESTAMP WITH TIME ZONE** and **TIMESTAMP WITH LOCAL TIME ZONE** Column Type in ODBC

The time zone is dictated by the system variable `ORA_SDTZ`. The system variable can be set to `'OS_TZ'`, `'DB_TZ'`, or a valid time zone value. See the information about Datetime data types and time zone support in *Oracle Database Globalization Support Guide*. When `ORA_SDTZ` is set to `'OS_TZ'`, the operating system time zone is used. If it is set to `'DB_TZ'`, the default time zone set in the database is used.

By default when `ORA_SDTZ` is not set, the operating system time zone is used.

Note:

When setting the `ORA_SDTZ` variable in a Microsoft Windows environment -- in the Registry, among system environment variables, or in a command prompt window -- do not enclose the time zone value in quotes.

Fetching Data from These Time Zone Columns Using the Variable of ODBC Data Type `TIMESTAMP_STRUCT`

The following example demonstrates how to fetch data from `TIMESTAMP WITH TIME ZONE` and `TIMESTAMP WITH LOCAL TIME ZONE` column using the variable of ODBC datatype `TIMESTAMP_STRUCT`.

Example 24-1 How to Fetch Data from `TIMESTAMP WITH TIME ZONE` and `TIMESTAMP WITH LOCAL TIME ZONE` Columns Using the Variable of ODBC Data Type `TIMESTAMP_STRUCT`

```

int main()
{
...
...
/* TSTAB table's DDL statement:
* -----

```

```

* CREATE TABLE TSTAB (COL_TSTZ  TIMESTAMP WITH TIME ZONE,
*                       COL_TSLTZ TIMESTAMP WITH LOCAL TIME ZONE);
*
* Insert statement:
* -----
* Sample #1:
* -----
* INSERT INTO TSTAB VALUES (TIMESTAMP '2010-03-13 03:47:30.123456 America/
Los_Angeles'
*                               TIMESTAMP '2010-04-14 04:47:30.123456 America/
Los_Angeles');
*
* Sample #2:
* -----
* INSERT INTO TSTAB VALUES ('22-NOV-1963 12:30:00.000000 PM',
*                               '24-NOV-1974 02:30:00.000000 PM');
*
* Refer Oracle Database documentations to know more details about TIMESTAMP
* WITH TIME ZONE and TIMESTAMP WITH LOCAL TIME ZONE columns.
*/
SQLCHAR sqlSelQuery[] = "SELECT COL_TSTZ, COL_TSLTZ FROM TSTAB";
TIMESTAMP_STRUCT timestampcoll;
TIMESTAMP_STRUCT timestampcol2;
...
...
/* Allocate the ODBC statement handle. */
SQLAllocHandle(SQL_HANDLE_STMT, hdbc, &hstmt);

/* Execute the statement sqlSelQuery. */
SQLExecDirect(hstmt, sqlSelQuery, SQL_NTS);

/* Bind the variable to read the value from the TIMESTAMP WITH TIME ZONE column.
*/
SQLBindCol(hstmt, 1, SQL_C_TIMESTAMP, &timestampcoll, sizeof(timestampcoll),
NULL);

/* Bind the variable to read the value from the TIMESTAMP WITH LOCAL TIME ZONE
column. */
SQLBindCol(hstmt, 2, SQL_C_TIMESTAMP, &timestampcol2, sizeof(timestampcol2),
NULL);
...
...
/* Fetch data from the TSTAB table. */
retcode = SQLFetch(hstmt);
/* Values of column COL_TSTZ and COL_TSLTZ are available in variables
* timestampcoll and timestampcol2 respectively. Refer to Microsoft ODBC
* documentation for more information about data type TIMESTAMP_STRUCT. */
...
...
/* Close the statement. */
SQLFreeStmt(hstmt, SQL_CLOSE);
/* Free the statement handle. */
SQLFreeHandle(SQL_HANDLE_STMT, hstmt); ... }

```

Example 24-2 How to Insert Data into *TIMESTAMP WITH TIME ZONE* and *TIMESTAMP WITH LOCAL TIME ZONE* Columns

```

int main()
{
...

```

```

...
SQLCHAR sqlInsQuery[] = "INSERT INTO TSTAB VALUES (?, ?)";
TIMESTAMP_STRUCT timestampcoll1;
TIMESTAMP_STRUCT timestampcol2;
...
...
/* Input the value for column COL_TSTZ in table TSTAB. */
timestampcoll1.year = 2000;
timestampcoll1.month = 1;
timestampcoll1.day = 1;
timestampcoll1.hour = 0;
timestampcoll1.minute = 0;
timestampcoll1.second = 1;
timestampcoll1.fraction = 1000;

/* Input the value for column COL_TSLTZ in table TSTAB. */
timestampcoll1.year = 2012;
timestampcoll1.month = 2;
timestampcoll1.day = 5;
timestampcoll1.hour = 10;
timestampcoll1.minute = 30;
timestampcoll1.second = 10;
timestampcoll1.fraction = 1000;
...
...
/* Allocate the ODBC statement handle. */
SQLAllocHandle(SQL_HANDLE_STMT, hdbc, &hstmt);
...
...
/* Bind the input value for column COL_TSTZ. */
SQLBindParameter(hstmt, 1, SQL_PARAM_INPUT, SQL_C_TIMESTAMP, SQL_TIMESTAMP,
0, 0, &timestampcoll1, sizeof(timestampcoll1), NULL);

/* Bind the input value for column COL_TSLTZ. */
SQLBindParameter(hstmt, 2, SQL_PARAM_INPUT, SQL_C_TIMESTAMP, SQL_TIMESTAMP,
0, 0, &timestampcol2, sizeof(timestampcol2), NULL);
...
...
/* Execute the statement sqlInsQuery. */
SQLExecDirect(hstmt, sqlInsQuery, SQL_NTS);

/* Close the statement. */
SQLFreeStmt(hstmt, SQL_CLOSE);
/* Free the statement handle. */
SQLFreeHandle(SQL_HANDLE_STMT, hstmt);
...
...
}

```

24.4.12 About the Effect of Setting ORA_SDTZ in Oracle Clients (OCI, SQL*Plus, Oracle ODBC driver, and Others)

Describes the effect of setting the system variable ORA_SDTZ in Oracle Clients.

The time zone is dictated by the system variable ORA_SDTZ. See the information about setting the session time zone in [Oracle Database Globalization Support Guide](#) for more information.

The following sections describe the effects of not setting and setting the system variable ORA_SDTZ in Oracle Clients (OCI, SQL*Plus, Oracle ODBC Driver, and others). The examples in these sections are run in India (GMT+5:30) time zone.

Environment Setup

To set up the environment, create the following table with TSLTZ (TIMESTAMP WITH LOCAL TIME ZONE) column and insert the value of 01/01/2016 00:00 GMT into the TSLTZ column as follows:

Example 24-3 How to Set Up the Environment

The following example sets up the environment for the example sections that follow.

```
SQL> create table timezone_demo(col1 TIMESTAMP WITH LOCAL TIME ZONE);

Table created.

SQL> INSERT INTO TIMEZONE_DEMO VALUES(TIMESTAMP '2016-01-01 00:00:00.000000 ETC/GREENWICH');

1 row created.
```

When ORA_SDTZ Is Not Set in the Environment

When ORA_SDTZ is not set in the environment, then the operating system (OS) time zone setting is taken as the default time zone for Oracle Clients. For example:

Example 24-4 What Happens When ORA_SDTZ Is Not Set

```
C:\Users\example.ORADEV>set ORA_SDTZ=

C:\Users\example.ORADEV>sqlplus scott/password@//host01.example.com:1521/ORCL12C1

SQL*Plus: Release 12.1.0.2.0 Production on Fri Apr 22 12:03:52 2016

Copyright (c) 1982, 2014, Oracle. All rights reserved.

Last Successful login time: Fri Apr 22 2016 11:47:12 +05:30

Connected to:
Oracle Database 12c Enterprise Edition Release 12.1.0.2.0 - 64bit Production
With the Partitioning, OLAP, Advanced Analytics and Real Application Testing options

SQL> select sessiontimezone from dual;

SESSIONTIMEZONE
-----
+05:30

SQL> select * from timezone_demo;

COL1
-----
01-JAN-16 05.30.00.000000 AM
```

Setting ORA_SDTZ to the Operating System (OS) Timezone in the Environment

When ORA_SDTZ is set to the operating system (OS) Time zone, the Oracle Client's user session is set to the OS time zone setting. You can either unset it in the environment or set ORA_SDTZ to OS_TZ. For example:

Example 24-5 What Happens When ORA_SDTZ Is Set to the Operating System (OS) Timezone

```
C:\Users\example.ORADEV>set ORA_SDTZ=OS_TZ

C:\Users\example.ORADEV>sqlplus scott/password@//host01.example.com:1521/ORCL12C1
```



```
SQL*Plus: Release 12.1.0.2.0 Production on Fri Apr 22 11:42:36 2016
```

```
Copyright (c) 1982, 2014, Oracle. All rights reserved.
```

```
Last Successful login time: Fri Apr 22 2016 11:42:09 +05:30
```

```
Connected to:
```

```
Oracle Database 12c Enterprise Edition Release 12.1.0.2.0 - 64bit Production  
With the Partitioning, OLAP, Advanced Analytics and Real Application Testing options
```

```
SQL> select sessiontimezone from dual;
```

```
SESSIONTIMEZONE
```

```
-----  
+05:30
```

```
SQL> select * from timezone_demo;
```

```
COL1
```

```
-----  
01-JAN-16 05.30.00.000000 AM
```

Setting ORA_SDTZ to a Specific Time Zone in the Environment

The Oracle Client can be set to retrieve the time stamp value adjusted to a specific time zone (for example, Helsinki Time Zone). To do this, you can set

```
ORA_SDTZ
```

to the Oracle Time Zone region name for the corresponding time zone (Oracle Time Zone Region Name for Helsinki Time Zone is Europe/Helsinki). For example:

Example 24-6 What Happens When ORA_SDTZ Is Set to a Specific Time Zone

```
C:\Users\example.ORADEV>set ORA_SDTZ=Europe/Helsinki
```

```
C:\Users\example.ORADEV>sqlplus scott/password@//host01.example.com:1521/ORCL12C1
```

```
SQL*Plus: Release 12.1.0.2.0 Production on Fri Apr 22 11:47:10 2016
```

```
Copyright (c) 1982, 2014, Oracle. All rights reserved.
```

```
Last Successful login time: Fri Apr 22 2016 09:16:18 EUROPE/HELSINKI EEST
```

```
Connected to:
```

```
Oracle Database 12c Enterprise Edition Release 12.1.0.2.0 - 64bit Production  
With the Partitioning, OLAP, Advanced Analytics and Real Application Testing options
```

```
SQL> select sessiontimezone from dual;
```

```
SESSIONTIMEZONE
```

```
-----  
Europe/Helsinki
```

```
SQL> select * from timezone_demo;
```

```
COL1
```

```
-----  
01-JAN-16 02.00.00.000000 AM
```

24.4.13 Supported Functionality

Topics:

- [API Conformance](#) (page 24-46)
- [Implementation of ODBC API Functions](#) (page 24-46)
- [Implementation of the ODBC SQL Syntax](#) (page 24-47)
- [Implementation of Data Types \(Programming\)](#) (page 24-47)

24.4.13.1 API Conformance

Oracle ODBC Driver release 9.2.0.0.0 and higher supports all Core, Level 2, and Level 1 functions.

Also, Oracle ODBC Driver release 9.2.0.0.0 and higher supports translation DLLs.

The following topics describe the ODBC API functions implemented by the Oracle ODBC Driver.

See the following topics for additional information:

- [Error Messages](#) (page 24-24), for advanced users
- [Implementation of ODBC API Functions](#) (page 24-46), for programmers

24.4.13.2 Implementation of ODBC API Functions

[Table 24-6](#) (page 24-46) describes how the Oracle ODBC Driver implements specific functions:

Table 24-6 How Oracle ODBC Driver Implements Specific Functions

Function	Description
SQLConnect	SQLConnect requires only a DBQ, user ID, and password.
SQLDriverConnect	SQLDriverConnect uses the DSN, DBQ, UID, and PWD keywords.
SQLMoreResults	Implements ODBC support for implicit results. This is a new API implemented for Oracle Database 12c Release 1 (12.1.0.1). See http://msdn.microsoft.com/en-us/library/ms714673(v=VS.85).aspx for more information.
SQLSpecialColumns	If SQLSpecialColumns is called with the SQL_BEST_ROWID attribute, it returns the rowid column.
SQLProcedures and SQLProcedureColumns	See the information that follows.

Table 24-6 (Cont.) How Oracle ODBC Driver Implements Specific Functions

Function	Description
All catalog functions	If the <code>SQL_ATTR_METADATA_ID</code> statement attribute is <code>SQL_TRUE</code> , a string argument is treated as an identifier argument, and its case is not significant. In this case, the underscore ("_") and the percent sign ("%") are treated as the actual character, not as a search pattern character. On the other hand, if this attribute is <code>SQL_FALSE</code> , it is either an ordinary argument or a pattern value argument and is treated literally, and its case is significant.

24.4.13.3 Implementation of the ODBC SQL Syntax

If a comparison predicate has a parameter marker as the second expression in the comparison and the value of that parameter is `SQL_NULL_DATA` with `SQLBindParameter`, the comparison fails. This is consistent with the null predicate syntax in ODBC SQL.

24.4.13.4 Implementation of Data Types (Programming)

For programmers, the noteworthy part of the implementation of the data types concerns the `CHAR`, `VARCHAR`, and `VARCHAR2` data types.

For an `fSqlType` value of `SQL_VARCHAR`, `SQLGetTypeInfo` returns the Oracle database data type `VARCHAR2`. For an `fSqlType` value of `SQL_CHAR`, `SQLGetTypeInfo` returns the Oracle database data type `CHAR`.

24.4.14 Unicode Support

Topics:

- [Unicode Support Within the ODBC Environment](#) (page 24-47)
- [Unicode Support in ODBC API](#) (page 24-48)
- [Unicode Functions in the Driver Manager](#) (page 24-48)
- [SQLGetData Performance](#) (page 24-49)
- [Unicode Samples](#) (page 24-49)

24.4.14.1 Unicode Support Within the ODBC Environment

The Microsoft or `unixODBC` ODBC Driver Manager (Driver Manager) makes all ODBC drivers, regardless if they support Unicode, appear as if they are Unicode compliant. This allows ODBC applications to be written independent of the Unicode capabilities of underlying ODBC drivers.

The extent to which the Driver Manager can emulate Unicode support for ANSI ODBC drivers is limited by the conversions possible between the Unicode data and the local code page. Data loss is possible when the Driver Manager is converting from Unicode to the local code page. Full Unicode support is not possible unless the underlying ODBC driver supports Unicode. The Oracle ODBC Driver provides full Unicode support.

24.4.14.2 Unicode Support in ODBC API

The ODBC API supports both Unicode and ANSI entry points using the "W" and "A" suffix convention. An ODBC application developer need not explicitly call entry points with the suffix. An ODBC application that is compiled with the UNICODE and _UNICODE preprocessor definitions generates the appropriate calls. For example, a call to `SQLPrepare` is compiled as `SQLPrepareW`.

The C data type, `SQL_C_WCHAR`, was added to the ODBC interface to allow applications to specify that an input parameter is encoded as Unicode or to request column data returned as Unicode. The macro `SQL_C_TCHAR` is useful for applications that must be built as both Unicode and ANSI. The `SQL_C_TCHAR` macro compiles as `SQL_C_WCHAR` for Unicode applications and as `SQL_C_CHAR` for ANSI applications.

The SQL data types, `SQL_WCHAR`, `SQL_WVARCHAR`, and `SQL_WLONGVARCHAR`, have been added to the ODBC interface to represent columns defined in a table as Unicode. Potentially, these values are returned from calls to `SQLDescribeCol`, `SQLColAttribute`, `SQLColumns`, and `SQLProcedureColumns`.

Unicode encoding is supported for SQL column types `NCHAR`, `NVARCHAR2`, and `NCLOB`. Also, Unicode encoding is also supported for SQL column types `CHAR` and `VARCHAR2` if the character semantics are specified in the column definition.

The ODBC Driver supports these SQL column types and maps them to ODBC SQL data types.

[Table 24-7](#) (page 24-48) lists the supported SQL data types and the equivalent ODBC SQL data type.

Table 24-7 Supported SQL Data Types and the Equivalent ODBC SQL Data Type

SQL Data Types	ODBC SQL Data Types
CHAR	SQL_CHAR or SQL_WCHAR ¹
VARCHAR2	SQL_VARCHAR or SQL_WVARCHAR ²
NCHAR	SQL_WCHAR
NVARCHAR2	SQL_WVARCHAR
NCLOB	SQL_WLONGVARCHAR

¹ CHAR maps to SQL_WCHAR if the character semantics were specified in the column definition and if the character set for the database is Unicode.

² VARCHAR2 maps to SQL_WVARCHAR if the character semantics were specified in the column definition and if the character set for the database is Unicode.

24.4.14.3 Unicode Functions in the Driver Manager

The Driver Manager performs the following functions when it detects that the underlying ODBC driver does not support Unicode:

- Convert Unicode function calls to ANSI function calls before calling the ANSI ODBC driver. String arguments are converted from Unicode to the local code page. For example, a call to `SQLPrepareW` is converted to call `SQLPrepare`. The text of the SQL statement parameter is converted from Unicode to the local code page.

- Convert return parameters that are character data from the local code page to Unicode. For example, returning the column name through `SQLColAttribute`.
- Convert data from the local code page to Unicode for columns bound as `SQL_C_WCHAR`.
- Convert data from Unicode to the local code page for input parameters bound as `SQL_C_WCHAR`.

24.4.14.4 SQLGetData Performance

The `SQLGetData` function allows an ODBC application to specify the data type to receive a column as after the data has been fetched. OCI requires the Oracle ODBC Driver to specify the data type before it is fetched. In this case, the Oracle ODBC Driver uses the knowledge it has about the data type of the column as defined in the database to determine how to best default to fetching the column through OCI.

If a column that contains character data is not bound by `SQLBindCol`, the Oracle ODBC Driver must determine if it must fetch the column as Unicode or as the local code page. The driver could default to receiving the column as Unicode, however, this may result in as many as two unnecessary conversions. For example, if the data were encoded in the database as ANSI, there would be an ANSI to Unicode conversion to fetch the data into the Oracle ODBC Driver. If the ODBC application then requested the data as `SQL_C_CHAR`, there would be an additional conversion to revert the data back to its original encoding.

The default encoding of the Oracle client is used when fetching data. However, an ODBC application can overwrite this default and fetch the data as Unicode by binding the column or the parameter as the `WCHAR` data type.

24.4.14.5 Unicode Samples

As the Oracle ODBC Driver itself was implemented using `TCHAR` macros, Oracle recommends that ODBC application programs use `TCHAR` to take advantage of the driver.

The following links are program examples showing how to use `TCHAR`, which becomes the `WCHAR` data type in case you compile with `UNICODE` and `_UNICODE`.

- [Example 1: Connection to Database](#) (page 24-49)
- [Example 2: Simple Retrieval](#) (page 24-50)
- [Example 3: Retrieval Using SQLGetData \(Binding After Fetch\)](#) (page 24-51)
- [Example 4: Simple Update](#) (page 24-51)
- [Example 5: Update and Retrieval for Long Data \(CLOB\)](#) (page 24-52)

Example 1: Connection to Database

No difference other than specifying Unicode literals for `SQLConnect`.

```
SQLHENV envHnd;
SQLHDBC conHnd;
SQLHSTMT stmtHnd;
RETCODE rc;

rc = SQL_SUCCESS;

// ENV is allocated
```

```
rc = SQLAllocHandle(SQL_HANDLE_ENV, SQL_NULL_HANDLE, &envHnd);
// Connection Handle is allocated
rc = SQLAllocHandle(SQL_HANDLE_DBC, envHnd, &conHnd);
rc = SQLConnect(conHnd, _T("stpcl9"), SQL_NTS, _T("scott"), SQL_NTS, _T("tiger"),
SQL_NTS);
.
.
.
if (conHnd)
{
    SQLDisconnect(conHnd);
    SQLFreeHandle(SQL_HANDLE_DBC, conHnd);
}
if (envHnd)
    SQLFreeHandle(SQL_HANDLE_ENV, envHnd);
```

Example 2: Simple Retrieval

The following example retrieves the employee names and the job titles from the EMP table. With the exception that you must specify TCHAR compliant data to every ODBC function, there is no difference to the ANSI case. If the case is a Unicode application, you have to specify the length of the buffer to the BYTE length when you call SQLBindCol (for example, sizeof(ename)).

```
/*
** Execute SQL, bind columns, and Fetch.
** Procedure:
**
** SQLExecDirect
** SQLBindCol
** SQLFetch
**
*/
static SQLTCHAR *sqlStmt = _T("SELECT ename, job FROM emp");
SQLTCHAR ename[50];
SQLTCHAR job[50];
SQLINTEGER enamelen, joblen;

_tprintf(_T("Retrieve ENAME and JOB using SQLBindCol 1.../n[%s]/n"), sqlStmt);

/* Step 1: Prepare and Execute */
rc = SQLExecDirect(stmtHnd, sqlStmt, SQL_NTS); /* select */
checkSQLErr(envHnd, conHnd, stmtHnd, rc);

/* Step 2: Bind Columns */
rc = SQLBindCol(stmtHnd, 1, SQL_C_TCHAR, ename, sizeof(ename), &enamelen);
checkSQLErr(envHnd, conHnd, stmtHnd, rc);

rc = SQLBindCol(stmtHnd, 2, SQL_C_TCHAR, job, sizeof(job), &joblen);
checkSQLErr(envHnd, conHnd, stmtHnd, rc);

do
{
    /* Step 3: Fetch Data */
    rc = SQLFetch(stmtHnd);
    if (rc == SQL_NO_DATA)
        break;
    checkSQLErr(envHnd, conHnd, stmtHnd, rc);
    _tprintf(_T("ENAME = %s, JOB = %s/n"), ename, job);
} while (1);
_tprintf(_T("Finished Retrieval/n/n"));
```

Example 3: Retrieval Using SQLGetData (Binding After Fetch)

This example shows how to use `SQLGetData`. For those who are not familiar with ODBC programming, the fetch is allowed before binding the data using `SQLGetData`, unlike in an OCI program. There is no difference to the ANSI application in terms of Unicode-specific issues.

```

/*
** Execute SQL, bind columns, and Fetch.
** Procedure:
**
** SQLExecDirect
** SQLFetch
** SQLGetData
*/
static SQLTCHAR *sqlStmt = _T("SELECT ename,job FROM emp"); // same as Case 1.
SQLTCHAR ename[50];
SQLTCHAR job[50];

_tprintf(_T("Retrieve ENAME and JOB using SQLGetData...\n[%s]\n"), sqlStmt);
if (rc != SQL_SUCCESS)
{
    _tprintf(_T("Failed to allocate STMT\n"));
    goto exit2;
}

/* Step 1: Prepare and Execute */
rc = SQLExecDirect(stmtHnd, sqlStmt, SQL_NTS); // select
checkSQLErr(envHnd, conHnd, stmtHnd, rc);

do
{
    /* Step 2: Fetch */
    rc = SQLFetch(stmtHnd);
    if (rc == SQL_NO_DATA)
        break;

    checkSQLErr(envHnd, conHnd, stmtHnd, rc);

    /* Step 3: GetData */
    rc = SQLGetData(stmtHnd, 1, SQL_C_TCHAR, (SQLPOINTER)ename, sizeof(ename), NULL);
    checkSQLErr(envHnd, conHnd, stmtHnd, rc);

    rc = SQLGetData(stmtHnd, 2, SQL_C_TCHAR, (SQLPOINTER)job, sizeof(job), NULL);
    checkSQLErr(envHnd, conHnd, stmtHnd, rc);

    _tprintf(_T("ENAME = %s, JOB = %s\n"), ename, job);
} while (1);

_tprintf(_T("Finished Retrieval\n\n"));

```

Example 4: Simple Update

This example shows how to update data. Likewise, the length of data for `SQLBindParameter` has to be specified with the `BYTE` length, even in the case of a Unicode application.

```

/
*
** Execute SQL, bind columns, and Fetch.

```

```

** Procedure:
**
** SQLPrepare
** SQLBindParameter
** SQLExecute
**
static SQLTCHAR *sqlStmt = _T("INSERT INTO emp(empno,ename,job) VALUES(?,?,?)");
static SQLTCHAR *empno = _T("9876"); // Emp No
static SQLTCHAR *ename = _T("ORACLE"); // Name
static SQLTCHAR *job = _T("PRESIDENT"); // Job

_tprintf(_T("Insert User ORACLE using SQLBindParameter...\n[%s]\n"), sqlStmt);

/* Step 1: Prepare */

rc = SQLPrepare(stmtHnd, sqlStmt, SQL_NTS);
checkSQLErr(envHnd, conHnd, stmtHnd, rc);

/* Step 2: Bind Parameter */

rc = SQLBindParameter(stmtHnd, 1, SQL_PARAM_INPUT, SQL_C_TCHAR, SQL_DECIMAL, 4, 0,
(SQLPOINTER)empno, 0, NULL);
checkSQLErr(envHnd, conHnd, stmtHnd, rc);

rc = SQLBindParameter(stmtHnd, 2, SQL_PARAM_INPUT, SQL_C_TCHAR, SQL_CHAR,
lstrlen(ename)*sizeof(TCHAR), 0, (SQLPOINTER)ename, lstrlen(ename)*sizeof(TCHAR),
NULL);
checkSQLErr(envHnd, conHnd, stmtHnd, rc);

rc = SQLBindParameter(stmtHnd, 3, SQL_PARAM_INPUT, SQL_C_TCHAR, SQL_CHAR,
lstrlen(job)*sizeof(TCHAR), 0, (SQLPOINTER)job, lstrlen(job)*sizeof(TCHAR), NULL);
checkSQLErr(envHnd, conHnd, stmtHnd, rc);

/* Step 3: Execute */

rc = SQLExecute(stmtHnd);
checkSQLErr(envHnd, conHnd, stmtHnd, rc);

```

Example 5: Update and Retrieval for Long Data (CLOB)

This example may be the most complicated case to update and retrieve data for long data, like CLOB, in Oracle. Because the length of data must be the BYTE length, `lstrlen(TCHAR data)*sizeof(TCHAR)` is needed to derive the BYTE length.

```

/*
** Execute SQL, bind columns, and Fetch.
** Procedure:
**
** SQLPrepare
** SQLBindParameter
** SQLExecute
** SQLParamData
** SQLPutData
**
** SQLExecDirect
** SQLFetch
** SQLGetData
**
static SQLTCHAR *sqlStmt1 = _T("INSERT INTO clobtbl(clob1) VALUES(?)");

```



```

static SQLTCHAR *sqlStmt2 = _T("SELECT clob1 FROM clobtbl");
SQLTCHAR clobdata[1001];
SQLTCHAR resultdata[1001];
SQLINTEGER ind = SQL_DATA_AT_EXEC;
SQLTCHAR *bufp;
SQLTCHAR ch;
int clobdatalen, chunksize, dtsize, retchklen, i, len;

_tprintf(_T("Insert CLOB1 using SQLPutData...\n[%s]\n"), sqlStmt1);

/* Set CLOB Data */

for (i=0, ch=_T('A'); i< sizeof(clobdata)/sizeof(SQLTCHAR); ++i, ++ch)
{
    if (ch > _T('Z'))
        ch = _T('A');
    clobdata[i] = ch;
}

clobdata[sizeof(clobdata)/sizeof(SQLTCHAR)-1] = _T('/0');
clobdatalen = strlen(clobdata);
chunksize = clobdatalen / 7;

/* Step 1: Prepare */
rc = SQLPrepare(stmtHnd, sqlStmt1, SQL_NTS);
checkSQLErr(envHnd, conHnd, stmtHnd, rc);

/* Step 2: Bind Parameter with SQL_DATA_AT_EXEC */
rc = SQLBindParameter(stmtHnd, 1, SQL_PARAM_INPUT, SQL_C_TCHAR, SQL_LONGVARCHAR,
clobdatalen*sizeof(TCHAR), 0, (SQLPOINTER)clobdata, clobdatalen*sizeof(TCHAR), &ind);
checkSQLErr(envHnd, conHnd, stmtHnd, rc);

/* Step 3: Execute */
rc = SQLExecute(stmtHnd);
checkSQLErr(envHnd, conHnd, stmtHnd, rc);
sdhamoth: Continuation:

/* Step 4: ParamData (initiation) */
rc = SQLParamData(stmtHnd, (SQLPOINTER*)&bufp);
checkSQLErr(envHnd, conHnd, stmtHnd, rc);

for (dtsize=0, bufp = clobdata; dtsize < clobdatalen; dtsize += chunksize, bufp +=
chunksize)
{
    if (dtsize+chunksize<clobdatalen)
        len = chunksize;
    else
        len = clobdatalen-dtsize;

    /* Step 5: PutData */
    rc = SQLPutData(stmtHnd, (SQLPOINTER)bufp, len*sizeof(TCHAR));
    checkSQLErr(envHnd, conHnd, stmtHnd, rc);
}

/* Step 6: ParamData (termination) */
rc = SQLParamData(stmtHnd, (SQLPOINTER*)&bufp);
checkSQLErr(envHnd, conHnd, stmtHnd, rc);

rc = SQLFreeStmt(stmtHnd, SQL_CLOSE);
_tprintf(_T("Finished Update\n\n"));

```

```
rc = SQLAllocStmt(conHnd, &stmtHnd);
if (rc != SQL_SUCCESS)
{
    _tprintf(_T("Failed to allocate STMT/n"));
    goto exit2;
}

/* Clear Result Data */
memset(resultdata, 0, sizeof(resultdata));
chunksize = clobdatalen / 15; /* 15 times to put */

/* Step 1: Prepare */
rc = SQLExecDirect(stmtHnd, sqlStmt2, SQL_NTS); /* select */
checkSQLErr(envHnd, conHnd, stmtHnd, rc);

/* Step 2: Fetch */
rc = SQLFetch(stmtHnd);
checkSQLErr(envHnd, conHnd, stmtHnd, rc);

for(dtsize=0, bufp = resultdata; dtsize < sizeof(resultdata)/sizeof(TCHAR) && rc !=
SQL_NO_DATA; dtsize += chunksize-1, bufp += chunksize-1)
{
    if (dtsize+chunksize<sizeof(resultdata)/sizeof(TCHAR))
        len = chunksize;
    else
        len = sizeof(resultdata)/sizeof(TCHAR)-dtsize;

    /* Step 3: GetData */
    rc = SQLGetData(stmtHnd, 1, SQL_C_TCHAR, (SQLPOINTER)bufp, len*sizeof(TCHAR),
&retchklen);
}

if (!_tcscmp(resultdata, clobdata))
{
    _tprintf(_T("Succeeded!!/n/n"));
}
else
{
    _tprintf(_T("Failed!!/n/n"));
}
```

24.4.15 Performance and Tuning

Topics:

- [General ODBC Programming Tips](#) (page 24-54)
- [Data Source Configuration Options](#) (page 24-55)
- [DATE and TIMESTAMP Data Types](#) (page 24-57)

24.4.15.1 General ODBC Programming Tips

This section describes some general programming tips to improve the performance of an ODBC application.

- Enable connection pooling if the application will frequently connect and disconnect from a data source. Reusing pooled connections is extremely efficient compared to reestablishing a connection.

- Minimize the number of times a statement must be prepared. Where possible, use bind parameters to make a statement reusable for different parameter values. Preparing a statement once and executing it several times is much more efficient than preparing the statement for every `SQLExecute`.
- Do not include columns in a `SELECT` statement if you know the application will not retrieve them; especially `LONG` columns. Due to the nature of the database server protocols, the ODBC Driver must fetch the entire contents of a `LONG` column if it is included in the `SELECT` statement, regardless if the application binds the column or does a `SQLGetData`.
- If you are performing transactions that do not update the data source, set the `SQL_ATTR_ACCESS_MODE` attribute of the ODBC `SQLSetConnectAttr` function to `SQL_MODE_READ_ONLY`.
- If you are not using ODBC escape clauses, set the `SQL_ATTR_NOSCAN` attribute of the ODBC `SQLSetConnectAttr` function or the ODBC `SQLSetStmtAttr` function to true.
- Use the ODBC `SQLFetchScroll` function instead of the ODBC `SQLFetch` function for retrieving data from tables that have a large number of rows.
- Enable OCI statement caching when the same SQL statements are used multiple times (`StatementCache=T`).
- Binding `NUMBER` columns as `FLOAT` speeds up query execution (`BindAsFLOAT=T`).
- While fetching `LONG` or `LONG RAW` set `MaxLargeData=<value>` for optimum performance.
- Setting `UseOCIDescribeAny=T` for applications making heavy calls to small packaged procedures that return `Ref Cursor` improves performance.

24.4.15.2 Data Source Configuration Options

This topic discusses performance implications of the following ODBC data source configuration options:

Topics:

- [Enable Result Sets](#) (page 24-55)
- [Enable LOBs](#) (page 24-56)
- [Bind TIMESTAMP as DATE](#) (page 24-56)
- [Enable Closing Cursors](#) (page 24-56)
- [Enable Thread Safety](#) (page 24-56)
- [Fetch Buffer Size](#) (page 24-56)

Enable Result Sets

This option enables the support of returning result sets (for example, `RefCursor`) from procedure calls. The default is enabling the returning of result sets.

The ODBC Driver must query the database server to determine the set of parameters for a procedure and their data types to determine if there are any `RefCursor`

parameters. This query incurs an additional network round trip the first time any procedure is prepared and executed.

Enable LOBs

This option enables the support of inserting and updating LOBs. The default is enabled.

The ODBC Driver must query the database server to determine the data types of each parameter in an `INSERT` or `UPDATE` statement to determine if there are any LOB parameters. This query incurs an additional network round trip the first time any `INSERT` or `UPDATE` is prepared and executed.

Bind TIMESTAMP as DATE

Binds `SQL_TIMESTAMP` parameters as the appropriate Oracle data type. If this option is `TRUE`, `SQL_TIMESTAMP` binds as the Oracle `DATE` data type. If this option is `FALSE`, `SQL_TIMESTAMP` binds as the Oracle `TIMESTAMP` data type (which is the default).

Enable Closing Cursors

The `SQL_CLOSE` option of the ODBC function, `SQLFreeStmt`, is supposed to close associated cursors with a statement and discard all pending results. The application can reopen the cursor by executing the statement again without doing a `SQLPrepare` again. A typical scenario for this is an application that is idle for a while but reuses the same SQL statement. While the application is idle, it might free up associated server resources.

The Oracle Call Interface (OCI), on which the Oracle ODBC Driver is layered, does not support the functionality of closing cursors. So, by default, the `SQL_CLOSE` option has no effect in the Oracle ODBC Driver. The cursor and associated resources remain open on the database server.

Enabling this option causes the associated cursor to be closed on the database server. However, this results in the parse context of the SQL statement being lost. The ODBC application can execute the statement again without calling `SQLPrepare`. However, internally the ODBC Driver must prepare and execute the statement all over. Enabling this option severely impacts performance of applications that prepare a statement once and execute it repeatedly.

Enable this option only if freeing the resources on the server is absolutely necessary.

Enable Thread Safety

If an application is single-threaded, this option can be disabled. By default, the ODBC Driver ensures that access to all internal structures (environment, connection, statement) are thread-safe. Single-threaded applications can eliminate some of the thread safety overhead by disabling this option. Disabling this option typically shows a minor performance improvement.

Fetch Buffer Size

Set the Fetch Buffer Size in the [Oracle Options](#) (page 24-16) tab of the [Oracle ODBC Driver Configuration Dialog Box](#) (page 24-13) to a value specified in bytes. This value determines how many rows of data at a time the ODBC Driver prefetches from an Oracle database to the client's cache, regardless of the number of rows the application program requests in a single query, thus improving performance.

Applications that typically fetch fewer than 20 rows of data at a time improve their response time, particularly over slow network connections or to heavily loaded servers. Setting this too high can worsen response time or consume large amounts of memory. The default is 64,000 bytes. Choose a value that works best for your application.

Note:

When LONG and LOB data types are present, the number of rows prefetched by the ODBC Driver is not determined by the Fetch Buffer Size. The inclusion of the LONG and LOB data types minimizes the performance improvement and could result in excessive memory use. The ODBC Driver disregards the Fetch Buffer Size and prefetch a set number of rows in the presence of the LONG and LOB data types.

24.4.15.3 DATE and TIMESTAMP Data Types

If a DATE column in the database is used in a WHERE clause and the column has an index, there can be an impact on performance. For example:

```
SELECT * FROM EMP WHERE HIREDATE = ?
```

In this example, an index on the HIREDATE column could be used to make the query execute quickly. But, because HIREDATE is actually a DATE value and the ODBC Driver is supplying the parameter value as TIMESTAMP, the Oracle server's query optimizer must apply a conversion function. To prevent incorrect results (as might happen if the parameter value had nonzero fractional seconds), the optimizer applies the conversion to the HIREDATE column resulting in the following statement:

```
SELECT * FROM EMP WHERE TO_TIMESTAMP(HIREDATE) = ?
```

Unfortunately, this has the effect of disabling the use of the index on the HIREDATE column and instead the server performs a sequential scan of the table. If the table has many rows, this can take a long time. As a workaround for this situation, the ODBC Driver has the connection option to Bind TIMESTAMP as DATE. When this option is enabled, the ODBC Driver binds SQL_TIMESTAMP parameters as the Oracle DATE data type instead of the Oracle TIMESTAMP data type. This allows the query optimizer to use any index on the DATE columns.

Note:

This option is intended for use only with Microsoft Access or other similar programs that bind DATE columns as TIMESTAMP columns. Do not use this option when there are actual TIMESTAMP columns present or when data loss may occur. Microsoft Access executes such queries using whatever columns are selected as the primary key.

See Also:

[Implementation of Data Types \(Advanced\)](#) (page 24-23)

Using the Identity Code Package

The Identity Code Package is a feature in the Oracle Database that offers tools and techniques to store, retrieve, encode, decode, and translate between various product or identity codes, including Electronic Product Code (EPC), in an Oracle Database. The Identity Code Package provides data types, metadata tables and views, and PL/SQL packages for storing EPC standard RFID tags or new types of RFID tags in a user table.

The Identity Code Package empowers Oracle Database with the knowledge to recognize EPC coding schemes, support efficient storage and component level retrieval of EPC data, and comply with the EPCglobal Tag Data Translation 1.0 (TDT) standard that defines how to decode, encode, and translate between various EPC RFID tag representations.

The Identity Code Package also provides an extensible framework that allows developers to use pre-existing coding schemes with their applications that are not included in the EPC standard and make the Oracle Database adaptable to these older systems and to any evolving identity codes that may some day be part of a future EPC standard.

The Identity Code Package also lets developers create their own identity codes by first registering the encoding category, registering the encoding type, and then registering the components associated with each encoding type.

Topics:

- [Identity Concepts](#) (page 25-1)
- [What is the Identity Code Package?](#) (page 25-5)
- [Using the Identity Code Package](#) (page 25-6)
- [Identity Code Package Types](#) (page 25-18)
- [DBMS_MGD_ID_UTL Package](#) (page 25-19)
- [Identity Code Metadata Tables and Views](#) (page 25-20)
- [Electronic Product Code \(EPC\) Concepts](#) (page 25-22)
- [Oracle Database Tag Data Translation Schema](#) (page 25-26)

25.1 Identity Concepts

A database object `MGD_ID` is defined that lets users use EPC standard identity codes and use their own existing identity codes. See [Electronic Product Code \(EPC\) Concepts](#) (page 25-22) for a brief description of EPC concepts. The `MGD_ID` object serves as the base code object to which belong certain categories, or types of the RFID tag, such as the EPC category, NASA category, and many other categories. Each category has a set of tag schemes or documents that define tag representation structures and their

components. For the EPC category, the metadata needed to define encoding schemes (SGTIN-64, SGTIN-96, GID-96, and so on) representing different encoding types (defined in the EPC standard v1.1) is loaded by default into the database. Users can define encoding their own categories and schemes as shown in [Figure 25-1](#) (page 25-2) and load these into the database as well.

Figure 25-1 RFID Code Categories and Their Schemes

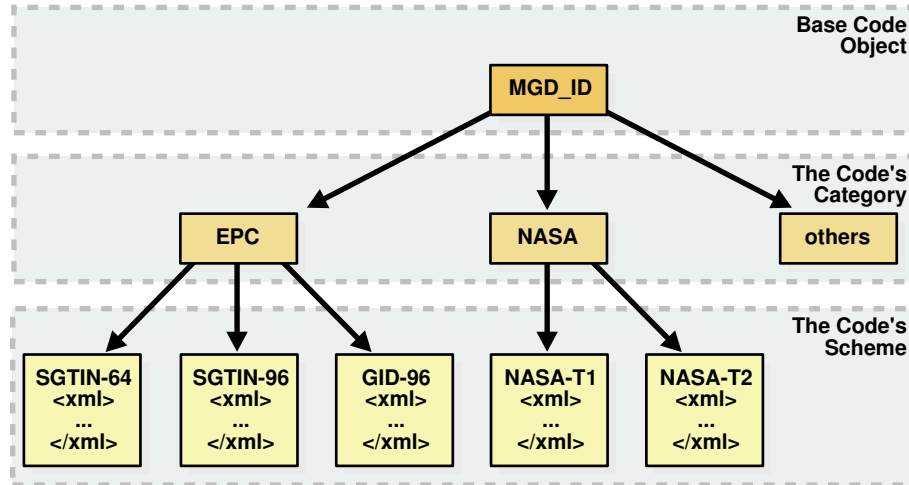

An MGD_ID object contains two attributes, a category_id and a list of components consisting of name-value pairs. When MGD_ID objects are stored, the tag representation must be parsed into these component name-value pairs upon object creation.

EPC standard version 1.1 defines one General Identifier type (GID) that is independent of any known, existing code schemes, five Domain Identifier types that are based on EAN.UCC specifications, and the identity type United States Department of Defense (USDOD). The five EAN.UCC based identity types are the serialized global trade identification number (SGTIN), the serial shipping container code (SSCC), the serialized global location number (SGLN), the global returnable asset identifier (GRAI) and the global individual asset identifier (GIAI).

Except GID, which has one bit-level encoding, all the other identity types each have two encodings depending on their length: 64-bit and 96-bit. So in total there are thirteen different standard encodings for EPC tags. Also, tags can be encoded in representations other than binary, such as the tag URI and pure identity representations.

Each EPC encoding has its own structure and organization, see [Table 25-1](#) (page 25-2). The EPC encoding structure field names relate to the names in the parameter_list parameter name-value pairs in the Identity Code Package API. For example, for SGTIN-64, the structure field names are Filter Value, Company Prefix Index, Item Reference, and Serial Number.

Table 25-1 General Structure of EPC Encodings

Encoding Name	Header Length in bits	Field Names (parameter_list name-value pairs) and (length in bits)
GID-96	8	General Manager Number (8), Object Class (24), Serial Number (36)

Table 25-1 (Cont.) General Structure of EPC Encodings

Encoding Name	Header Length in bits	Field Names (parameter_list name-value pairs) and (length in bits)
SGTIN-64	2	Filter Value (3), Company Prefix Index (14), Item Reference (20), Serial Number (25)
SGTIN-96	8	Filter Value (3), Partition (3), Company Prefix (20-40), Item Reference (24-4), Serial Number (38)
SSCC-64	8	Filter Value (3), Company Prefix Index (14), Serial Reference (39)
SSCC-96	8	Filter Value (3), Partition (3), Company Prefix (20-40), Serial Reference (38-18), Unallocated (24)
SGLN-64	8	Filter Value (3), Company Prefix Index (14), Location Reference (20), Serial Number (19)
SGLN-96	8	Filter Value (3), Partition (3), Company Prefix (20-40), Location Reference (21-1), Serial Number (41)
GRAI-64	8	Filter Value (3), Company Prefix Index (14), Asset Type (20), Serial Number (19)
GRAI-96	8	Filter Value (3), Partition (3), Company Prefix (20-40), Asset Type (24-4), Serial Number (38)
GIAI-64	8	Filter Value (3), Company Prefix Index (14), Individual Asset Reference (39)
GIAI-96	8	Filter Value (3), Partition (3), Company Prefix (20-40), Individual Asset Reference (62-42)
USDOD-64	8	Filter Value (2), Government Managed Identifier (30), Serial Number (24)
USDOD-96	8	Filter Value (4), Government Managed Identifier (48), Serial Number (36)

EPCglobal defines eleven tag schemes (GID-96, SGTIN-64, SGTIN-96, and so on). Each of these schemes has various representations; today, the most often used are BINARY, TAG_URI, and PURE_IDENTITY. For example, information in an SGTIN-64 can be represented in these ways:

```

BINARY: 1001100000000000001000001110110001000010000011111110011000110010
PURE_IDENTITY: urn:epc:id:sgtin:0037000.030241.1041970
TAG_URI: urn:epc:tag:sgtin-64:3.0037000.030241.1041970
LEGACY: gtin=00037000302414;serial=1041970
ONS_HOSTNAME: 030241.0037000.sgtin.id.example.com

```

Some representations contain all information about the tag (BINARY and TAG_URI), while other representations contain partial information (PURE_IDENTITY). It is therefore possible to translate a tag from its TAG_URI to its PURE_IDENTITY representation, but it is not possible to translate in the other direction without more information being provided, namely the filter value must be supplied.

EPCglobal released a Tag Data Translation 1.0 (TDT) standard that defines how to decode, encode, and translate between various EPC RFID tag representations.

Decoding refers to parsing a given representation into field/value pairs, and encoding refers to reconstructing representations from these fields. Translating refers to decoding one representation and instantly encoding it into another. TDT defines this information using a set of XML files, each referred to as a scheme. For example, the SGTIN-64 scheme defines how to decode, encode, and translate between various SGTIN-64 representations, such as binary and pure identity. For details about the EPCglobal TDT schema, see the EPCglobal Tag Data Translation specification.

A key feature of the TDT specification is its ability to define any EPC scheme using the same XML schema. This approach creates a standard way of defining EPC metadata that RFID applications can then use to write their parsers, encoders, and translators. When the application is written according to the TDT specification, it must be able to update its set of EPC tag schemes and modify its action according to the metadata.

The Oracle Database metadata structure is similar, but not identical to the TDT standard. To fit the EPCglobal TDT specification, the Oracle RFID package must be able to ingest any TDT compatible scheme and seamlessly translate it into the generic Oracle Database defined metadata. See the `EPC_TO_ORACLE` Function in [Table 25-4](#) (page 25-19) for more information.

Reconstructing tag representation from fields, or in other words, encoding tag data into predefined representations is easily accomplished using the `MGD_ID.format` function. Likewise, the decoding of tag representations into `MGD_ID` objects and then encoding these objects into tag representations is also easily accomplished using the `MGDID.translate` function. See the `FORMAT` Member Function and the `TRANSLATE` Static Function in [Table 25-3](#) (page 25-19) for more information.

Because the EPCglobal TDT standard is powerful and highly extensible, the Oracle RFID standard metadata is a close relative of the TDT specification. See [Oracle Database Tag Data Translation Schema](#) (page 25-26) for the actual Oracle Database TDT XML schema. Developers can refer to this Oracle Database TDT XML schema to define their own tag structures.

[Figure 25-2](#) (page 25-4) shows the Oracle Database Tag Data Translation Markup Language Schema diagram.

Figure 25-2 Oracle Database Tag Data Translation Markup Language Schema

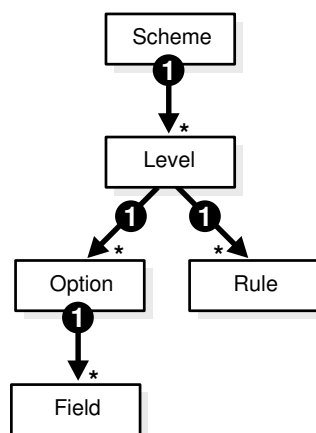

The top level element in a tag data translation xml is 'scheme'. Each scheme defines various tag encoding representations, or levels. SGTIN-64 and GID-96 are examples of tag encoding schemes, and `BINARY` or `PURE_IDENTITY` are examples of levels within these schemes. Each level has a set of options that define how to parse various representations into fields, and rules that define how to derive values for fields that

require additional work, such as an external table lookup or the concatenation of other parsed fields. See the EPCGlobal Tag Translator Specification for more information.

25.2 What Is the Identity Code Package?

The Identity Code Package provides an extensible framework that supports the current RFID tags with the standard family of EPC bit encodings for the supported encoding types and new and evolving tag encodings that are not included in the current EPC standard.

The Identity Code Package defines these ADTs:

- `MGD_ID` -- defines these (see `MGD_ID` ADT in [Table 25-2](#) (page 25-18) for more information):
 - Two attributes, `category_id` and `components`.
 - Four `MGD_ID` constructor functions for constructing identity code type objects to represent RFID tags.
 - A set of member subprograms for operating on these ADTs.

[Using the Identity Code Package](#) (page 25-6) describes how to use these ADTs and member functions.

[Identity Code Package Types](#) (page 25-18) and [DBMS_MGD_ID_UTL Package](#) (page 25-19) briefly describe the reference information for these ADTs along with a set of utility subprograms. See *Oracle Database PL/SQL Packages and Types Reference* for detailed reference information.

- `MGD_ID_COMPONENT` — defines two attributes, `comp_name`, which identifies the name of the component and `comp_value`, which identifies the components value.
- `MGD_ID_COMPONENT_VARRAY` — defines an array type that can store up to 128 elements of `MGD_IDCOMPONENT` type, which is used in two constructor functions for creating an identity code type object with a list of components.

The Identity Code Package supports EPC spec v1.1 by supplying the predefined `EPC_ENCODING_CATEGORY` encoding_category attribute definition with its bit-encoding structures for the supported encoding types. This information is stored as meta information in the supplied encoding metadata views, `MGD_USR_ID_CATEGORY`, `MGD_USR_ID_SCHEME`, the read-only views `MGD_ID_CATEGORY`, `MGD_ID_SCHEME`, and their underlying tables: `MGD_ID_CATEGORY_TAB`, `MGD_ID_SCHEME_TAB`, `MGD_ID_XML_VALIDATOR`. See these topics and files for more information:

- [Electronic Product Code \(EPC\) Concepts](#) (page 25-22) describes the EPC spec v1.1 product code and its family of coding schemes.
- [Identity Code Metadata Tables and Views](#) (page 25-20) describes the structure of the identity code meta tables and views and how metadata are used by the Identity Code Package to interpret the various RFID tags.
- The `mgdmeta.sql` file describes the meta table data for the `EPC_ENCODING_CATEGORY` categories and each of its specific encoding schemes.

After storing many thousands of RFID tags into the column of `MGD_ID` column type of your user table, you can improve query performance by creating an index on this column. See these topics for more information:

- [Building a Function-Based Index Using the Member Functions of the MGD_ID Column Type](#) (page 25-10) describes how to create a function based index or bitmap function based index using the member functions of the MGD_ID ADT.

The Identity Code Package provides a utility package that consists of various utility subprograms. See this topic for more information:

- [Identity Code Package Types](#) (page 25-18) and [DBMS_MGD_ID_UTL Package](#) (page 25-19) describes each of the member subprograms. A proxy utility sets and removes proxy information. A metadata utility gets a category ID, refreshes a tag scheme for a category, removes a tag scheme for a category, and validates a tag scheme. A conversion utility translates standard EPCglobal Tag Data Translation (TDT) files into Oracle Database TDT files.

The Identity Code Package is extensible and lets you create your own identity code types for your new or evolving RFID tags. You can define your identity code types, category_id attribute values, and components structures for your own encoding types. See these topics for more information:

- [Creating a Category of Identity Codes](#) (page 25-14) describes how to create your own identity codes by first registering the encoding category, and then registering the schemes associated to the encoding category.
- [Identity Code Metadata Tables and Views](#) (page 25-20) describes the structure of the identity code meta tables and views and how to register meta information by storing it in the supplied metadata tables and views.

25.3 Using the Identity Code Package

Topics:

- [Storing RFID Tags in Oracle Database Using MGD_ID ADT](#) (page 25-6)
- [Building a Function-Based Index Using the Member Functions of the MGD_ID Column Type](#) (page 25-10)
- [Using MGD_ID ADT Functions](#) (page 25-11)
- [Defining a Category of Identity Codes and Adding Encoding Schemes to an Existing Category](#) (page 25-14)

25.3.1 Storing RFID Tags in Oracle Database Using MGD_ID ADT

Topics:

- [Creating a Table with MGD_ID Column Type and Storing EPC Tag Encodings in the Column](#) (page 25-7)
- [Constructing MGD_ID Objects to Represent RFID Tags](#) (page 25-7)
- [Inserting an MGD_ID Object into a Database Table](#) (page 25-9)
- [Querying MGD_ID Column Type](#) (page 25-10)

25.3.1.1 Creating a Table with MGD_ID Column Type and Storing EPC Tag Encodings in the Column

You can create tables using MGD_ID as the column type to represent RFID tags, for example:

Example 1. Using the MGD_ID column type:

```
CREATE TABLE Warehouse_info (
    Code          MGD_ID,
    Arrival_time  TIMESTAMP,
    Location      VARCHAR2(256);
    ...);
```

SQL*Plus command:

```
describe warehouse_info;
```

Result:

Name	Null?	Type
CODE	NOT NULL	MGDSYS.MGD_ID
ARRIVAL_TIME		TIMESTAMP(6)
LOCATION		VARCHAR2(256)

25.3.1.2 Constructing MGD_ID Objects to Represent RFID Tags

There are several ways to construct MGD_ID objects:

- [Constructing an MGD_ID Object \(SGTIN-64\) Passing in the Category ID and a List of Components](#) (page 25-7)
- [Constructing an MGD_ID object \(SGTIN-64\) and Passing in the Category ID_ the Tag Identifier_ and the List of Additional Required Parameters](#) (page 25-8)
- [Constructing an MGD_ID object \(SGTIN-64\) and Passing in the Category Name_ Category Version \(if null_ then the latest version is used\)_ and a List of Components](#) (page 25-8)
- [Constructing an MGD_ID object \(SGTIN-64\) and Passing in the Category Name and Category Version_ the Tag Identifier_ and the List of Additional Required Parameters](#) (page 25-9)

25.3.1.2.1 Constructing an MGD_ID Object (SGTIN-64) Passing in the Category ID and a List of Components

If a RFID tag complies to the EPC standard, an MGD_ID object can be created using its category ID and a list of components. For example:

```
call DBMS_MGD_ID_UTL.set_proxy('example.com', '80');
call DBMS_MGD_ID_UTL.refresh_category('1');
select MGD_ID ('1',
    MGD_ID_COMPONENT_VARRAY(
        MGD_ID_COMPONENT('companyprefix','0037000'),
        MGD_ID_COMPONENT('itemref','030241'),
        MGD_ID_COMPONENT('serial','1041970'),
        MGD_ID_COMPONENT('schemes','SGTIN-64')
    )
) from DUAL;
call DBMS_MGD_ID_UTL.remove_proxy();
```

```

@constructor11.sql
.
.
.
MGD_ID ('1', MGD_ID_COMPONENT_VARRAY
        (MGD_ID_COMPONENT('companyprefix', '0037000'),
         MGD_ID_COMPONENT('itemref', '030241'),
         MGD_ID_COMPONENT('serial', '1041970'),
         MGD_ID_COMPONENT('schemes', 'SGTIN-64')))
.
.
.

```

25.3.1.2.2 Constructing an MGD_ID object (SGTIN-64) and Passing in the Category ID, the Tag Identifier, and the List of Additional Required Parameters

Use this constructor when there is a list of additional parameters required to create the MGD_ID object. For example:

```

call DBMS_MGD_ID_UTL.set_proxy('example.com', '80');
call DBMS_MGD_ID_UTL.refresh_category('1');
select MGD_ID('1',
             'urn:epc:id:sgtin:0037000.030241.1041970',
             'filter=3;scheme=SGTIN-64') from DUAL;
call DBMS_MGD_ID_UTL.remove_proxy();

```

```

@constructor22.sql
.
.
.
MGD_ID('1', MGD_ID_COMPONENT_VARRAY(MGD_ID_COMPONENT('filter', '3'),
                                     MGD_ID_COMPONENT('schemes', 'SGTIN-64'),
                                     MGD_ID_COMPONENT('companyprefixlength', '7'),
                                     MGD_ID_COMPONENT('companyprefix', '0037000'),
                                     MGD_ID_COMPONENT('scheme', 'SGTIN-64'),
                                     MGD_ID_COMPONENT('serial', '1041970'),
                                     MGD_ID_COMPONENT('itemref', '030241')))
.
.
.

```

25.3.1.2.3 Constructing an MGD_ID object (SGTIN-64) and Passing in the Category Name, Category Version (if null, then the latest version is used), and a List of Components

Use this constructor when a category version must be specified along with a category ID and a list of components. For example:

```

call DBMS_MGD_ID_UTL.set_proxy('example.com', '80');
call DBMS_MGD_ID_UTL.refresh_category
  (DBMS_MGD_ID_UTL.get_category_id('EPC', NULL));
select MGD_ID('EPC', NULL,
             MGD_ID_COMPONENT_VARRAY(
               MGD_ID_COMPONENT('companyprefix', '0037000'),
               MGD_ID_COMPONENT('itemref', '030241'),
               MGD_ID_COMPONENT('serial', '1041970'),
               MGD_ID_COMPONENT('schemes', 'SGTIN-64')
             )
             ) from DUAL;
call DBMS_MGD_ID_UTL.remove_proxy();

```

```
@constructor33.sql
.
.
.
MGD_ID('1', MGD_ID_COMPONENT_VARRAY
      (MGD_ID_COMPONENT('companyprefix', '0037000'),
       MGD_ID_COMPONENT('itemref', '030241'),
       MGD_ID_COMPONENT('serial', '1041970'),
       MGD_ID_COMPONENT('schemes', 'SGTIN-64')
      )
      )
.
.
.
```

25.3.1.2.4 Constructing an MGD_ID object (SGTIN-64) and Passing in the Category Name and Category Version, the Tag Identifier, and the List of Additional Required Parameters

Use this constructor when the category version and an additional list of parameters is required.

```
call DBMS_MGD_ID_UTL.set_proxy('example.com', '80');
call DBMS_MGD_ID_UTL.refresh_category
      (DBMS_MGD_ID_UTL.get_category_id('EPC', NULL));
select MGD_ID('EPC', NULL,
             'urn:epc:id:sgtin:0037000.030241.1041970',
             'filter=3;scheme=SGTIN-64') from DUAL;
call DBMS_MGD_ID_UTL.remove_proxy();
```

```
@constructor44.sql
.
.
.
MGD_ID('1', MGD_ID_COMPONENT_VARRAY
      (MGD_ID_COMPONENT('filter', '3'),
       MGD_ID_COMPONENT('schemes', 'SGTIN-64'),
       MGD_ID_COMPONENT('companyprefixlength', '7'),
       MGD_ID_COMPONENT('companyprefix', '0037000'),
       MGD_ID_COMPONENT('scheme', 'SGTIN-64'),
       MGD_ID_COMPONENT('serial', '1041970'),
       MGD_ID_COMPONENT('itemref', '030241')
      )
      )
.
.
.
```

25.3.1.3 Inserting an MGD_ID Object into a Database Table

This example shows how to populate the WAREHOUSE_INFO table by inserting each MGD_ID object into the table along with the additional column values:

```
call DBMS_MGD_ID_UTL.set_proxy('example.com', '80');

call DBMS_MGD_ID_UTL.refresh_category
      (DBMS_MGD_ID_UTL.get_category_id('EPC', NULL));

INSERT INTO WAREHOUSE_INFO (code, arrival_time, location)
      values (MGDSYS.MGD_ID ('EPC',
                            NULL,
                            'urn:epc:id:sgtin:0037000.030241.1041970',
                            null
```

```

        ),
        SYSDATE,
        'SHELF_123');

INSERT INTO WAREHOUSE_INFO (code, arrival_time, location)
values (MGDSYS.MGD_ID ('EPC',
                     NULL,
                     'urn:epc:id:sgtin:0037000.053021.1012353',
                     null
        ),
        SYSDATE,
        'SHELF_456');

INSERT INTO WAREHOUSE_INFO (code, arrival_time, location)
values (MGDSYS.MGD_ID ('EPC',
                     NULL,
                     'urn:epc:id:sgtin:0037000.020140.10174832',
                     null
        ),
        SYSDATE,
        'SHELF_1034');

COMMIT;
call DBMS_MGD_ID_UTL.remove_proxy();

```

25.3.1.4 Querying MGD_ID Column Type

There are three ways to query on MGD_ID column type.

- Query the MGD_ID column type. Find all items with item reference 030241.

```

SELECT location, wi.code.get_component('itemref') as itemref,
       wi.code.get_component('serial') as serial
FROM warehouse_info wi WHERE wi.code.get_component('itemref') = '030241';

```

LOCATION	ITEMREF	SERIAL
SHELF_123	030241	1041970

- Query using the member functions of the MGD_ID ADT. Select the pure identity representations of all RFID tags in the table.

```

SELECT wi.code.format(null, 'PURE_IDENTITY')
       as PURE_IDENTITY FROM warehouse_info wi;

```

```

PURE_IDENTITY
-----
urn:epc:id:sgtin:0037000.030241.1041970
urn:epc:id:gid:0037000.053021.1012353
urn:epc:id:sgtin:0037000.020140.10174832

```

See [Using the get_component Function with the MGD_ID Object](#) (page 25-11) for more information and see [Table 25-3](#) (page 25-19) for a list of member functions.

25.3.2 Building a Function-Based Index Using the Member Functions of the MGD_ID Column Type

You can improve the performance of queries based on a certain component of the RFID tags by creating a function-based index that uses the `get_component` member function or its variation convenience functions. For example:

```
CREATE INDEX warehouseinfo_idx2
  on warehouse_info(code.get_component('itemref'));
```

You can also improve the performance of queries based on a certain component of the RFID tags by creating a bitmap function based index that uses the `get_component` member function or its variation convenience functions. For example:

```
CREATE BITMAP INDEX warehouseinfo_idx3
  on warehouse_info(code.get_component('serial'));
```

25.3.3 Using MGD_ID ADT Functions

The `MGD_ID` ADT contains member subprograms that operate on these ADTs. See [Table 25-2](#) (page 25-18) for `MGD_ID_COMPONENT`, `MGD_ID_COMPONENT_VARRAY`, `MGD_ID` ADT reference information. See the `mgdtyp.sql` file for the `MGD_ID` ADT definition and its member subprograms.

Topics:

- [Using the `get_component` Function with the `MGD_ID` Object](#) (page 25-11)
- [Parsing Tag Data from Standard Representations](#) (page 25-12)
- [Reconstructing Tag Representations from Fields](#) (page 25-13)
- [Translating Between Tag Representations](#) (page 25-13)

25.3.3.1 Using the `get_component` Function with the `MGD_ID` Object

The `get_component` function is defined as follows:

```
MEMBER FUNCTION get_component(component_name IN VARCHAR2)
  RETURN VARCHAR2 DETERMINISTIC,
```

Each component in a identity code has a name. It is defined when the code type is registered. See [Defining a Category of Identity Codes and Adding Encoding Schemes to an Existing Category](#) (page 25-14) for more information about how to create a identity code type.

The `get_component` function takes the name of the component, `component_name` as a parameter, uses the metadata registered in the metadata table to analyze the identity code, and returns the component with the name `component_name`.

The `get_component` function can be used in a SQL query. For example, find the current location of the coded item for the component named `itemref`; or, in other words find all items with the item reference of 03024. Because the code tag has encoded `itemref` as a component, you can use this SQL query:

```
SELECT location,
       w.code.get_component('itemref') as itemref,
       w.code.get_component('serial') as serial
FROM   warehouse_info w
WHERE  w.code.get_component('itemref') = '030241';
```

LOCATION	ITEMREF	SERIAL
SHELF_123	030241	1041970

See [Table 25-3](#) (page 25-19) for a list of other member functions.

25.3.3.2 Parsing Tag Data from Standard Representations

RFID readers read the bit strings stored in the tags. The tag data and other information, such as the reader ID and the time stamp, first go through an edge server to be processed, normalized, and preliminarily filtered. Then, in many application scenarios, the information must be persistently stored and later on be retrieved. The Oracle Database understands the code structures representations of various EPC tags as described in [Table 25-1](#) (page 25-2) because these code representation schemes defined in the EPC Standard are preregistered. This gives the Oracle Database the ability to understand all the EPC code schemes and parse various tag representations into fields. Users can also register their own coding structures for the identity codes that use other encoding technologies. In this way the system is extensible.

As mentioned in [Identity Concepts](#) (page 25-1), each of the EPCGlobal tag schemes (GID-96, SGTIN-64, SGTIN-96, and so on) has various representations with the most often used being `BINARY`, `TAG_URI`, and `PURE_IDENTITY`.

Some representations contain all the information about the tag (`BINARY` and `TAG_URI`), while representations contain partial information (`PURE_IDENTITY`). It is therefore possible to translate a tag from its `TAG_URI` to its `PURE_IDENTITY` representation, but it is not possible to translate in the other direction (`PURE_IDENTITY` to `TAG_URI`) without supplying more information, namely the filter value.

One `MGD_ID` constructor takes in four fields, the category name (such as EPC), the category version, the tag identifier (for EPC, the identifier must be in a representation previously described), and a parameter list for any additional parameters required to parse the tag representation. For example, this code creates an `MGD_ID` object from its `BINARY` representation.

```
SELECT MGD_ID
  ('EPC',
   null,
   '10011000000000000001000001110110001000010000011111110011000110010',
   null
  )
AS NEW_RFID_CODE FROM DUAL;
```

```
NEW_RFID_CODE(CATEGORY_ID, COMPONENTS(NAME, VALUE))
-----
MGD_ID ('1',
        MGD_ID_COMPONENT_VARRAY(MGD_ID_COMPONENT('filter', '3'),
        MGD_ID_COMPONENT('schemes', 'SGTIN-64'),
        MGD_ID_COMPONENT('companyprefixlength', '7'),
        MGD_ID_COMPONENT('companyprefix', '0037000'),
        MGD_ID_COMPONENT('companyprefixindex', '1'),
        MGD_ID_COMPONENT('serial', '1041970'),
        MGD_ID_COMPONENT('itemref', '030241')
        )
        )
```

For example, an identical object can be created if the call is done with the `TAG_URI` representation of the tag as follows with the addition of the value of the filter value:

```
SELECT MGD_ID ('EPC',
  null,
  'urn:epc:tag:sgtin-64:3.0037000.030241.1041970',
  null
)
as NEW_RFID_CODE FROM DUAL;
```

```
NEW_RFID_CODE(CATEGORY_ID, COMPONENTS(NAME, VALUE))
```

```
-----
MGD_ID ('1',
  MGD_ID_COMPONENT_VARRAY (
    ( MGD_ID_COMPONENT('filter', '3'),
      MGD_ID_COMPONENT('schemes', 'SGTIN-64'),
      MGD_ID_COMPONENT('companyprefixlength', '7'),
      MGD_ID_COMPONENT('companyprefix', '0037000'),
      MGD_ID_COMPONENT('serial', '1041970'),
      MGD_ID_COMPONENT('itemref', '030241')
    )
  )
)
```

25.3.3.3 Reconstructing Tag Representations from Fields

Another useful feature of the Identity Code package is the ability to encode tag data into predefined representations. For example, a warehouse wants to send certain inventory to a retailer, but first it wants to send an invoice that tells the retailer what inventory to expect. The invoice can be a list of pure identity URIs that the warehouse intends to send. If all the inventory in the `WAREHOUSE_INFO` table is to be sent, this example constructs the desired URIs:

```
SELECT wi.code.format (null, 'PURE_IDENTITY')
       as PURE_IDENTITY FROM warehouse_info wi;
```

```
PURE_IDENTITY
```

```
-----
urn:epc:id:sgtin:0037000.030241.1041970
urn:epc:id:gid:0037000.053021.1012353
urn:epc:id:sgtin:0037000.020140.10174832
```

25.3.3.4 Translating Between Tag Representations

The Identity Code package can decode tag representations into `MGD_ID` objects and encode these objects into tag representations. These two steps can be combined into one step using the `MGD_ID.translate` function. Static translation allows for the conversion of an RFID tag from one representation to another. For example:

```
SELECT MGD_ID.translate ('EPC',
                        null,
                        'urn:epc:id:sgtin:0037000.030241.1041970',
                        'filter=3;scheme=SGTIN-64',
                        'BINARY'
                       )
       as BINARY FROM DUAL;
```

```
BINARY
```

```
-----
1001100000000000001000001110110001000010000011111110011000110010
```

In this example, the binary representation contains more information than the pure identity representation. Specifically, it also contains the filter value and in this case the scheme value must also be specified to distinguish SGTIN-64 from SGTIN-96. Thus, the function call must provide the missing filter parameter information and specify the scheme name in order for translation call to succeed.

25.3.4 Defining a Category of Identity Codes and Adding Encoding Schemes to an Existing Category

Topics:

- [Creating a Category of Identity Codes](#) (page 25-14)
- [Adding Two Metadata Schemes to a Newly Created Category](#) (page 25-14)

25.3.4.1 Creating a Category of Identity Codes

Because the EPCglobal TDT standard is powerful and highly extensible, the Oracle Database RFID standard metadata is a close relative of the TDT specification. Thus, the Identity Code package is extensible: You can create your own categories and tag structures using generic metadata. To create a category of identity codes, use the `DBMS_MGD_ID_UTIL.create_category` function.

For example, suppose you want to create a category called `MGD_SAMPLE_CATEGORY`, which has two types of tags, a `CONTRACTOR_TAG` and an `EMPLOYEE_TAG`. This category and its two metadata schemes might be used within a company that must grant different access privileges to people who are full time employees from those who are contractors, and thus require that their security software be able to identify quickly between the two badge types at an RFID reader. This script creates a category named `MGD_SAMPLE_CATEGORY`, with a 1.0 category version, having an agency name as Oracle, with a URI as `http://www.oracle.com/mgd/sample`. See [Adding Two Metadata Schemes to a Newly Created Category](#) (page 25-14) for an example.

25.3.4.2 Adding Two Metadata Schemes to a Newly Created Category

Next, create an `CONTRACTOR_TAG` metadata scheme such as:

```
<?xml version="1.0" encoding="UTF-8"?>
<TagDataTranslation version="0.04" date="2005-04-18T16:05:00Z"
  xmlns:xsi="http://www.w3.org/2001/XMLSchema"
  xmlns="oracle.mgd.idcode">
  <scheme name="CONTRACTOR_TAG" optionKey="1" xmlns="">
    <level type="URI" prefixMatch="mycompany.contractor.">
      <option optionKey="1" pattern="mycompany.contractor.([0-9]*).([0-9]*)"
        grammar="'mycompany.contractor.' ' contractorID '.' ' divisionID">
        <field seq="1" characterSet="[0-9]*" name="contractorID"/>
        <field seq="2" characterSet="[0-9]*" name="divisionID"/>
      </option>
    </level>
    <level type="BINARY" prefixMatch="11">
      <option optionKey="1" pattern="11([01]{7})([01]{6})"
        grammar="'11' contractorID divisionID ">
        <field seq="1" characterSet="[01]*" name="contractorID"/>
        <field seq="2" characterSet="[01]*" name="divisionID"/>
      </option>
    </level>
  </scheme>
</TagDataTranslation>
```

The `CONTRACTOR_TAG` scheme contains two encoding levels, or ways in which the tag can be represented. The first level is URI and the second level is BINARY. The URI representation starts with the prefix "mycompany.contractor." and is then followed by two numeric fields separated by a period. The names of the two fields are `contractorID` and `divisionID`. The pattern field in the option tag defines the

parsing structure of the tag URI representation, and the grammar field defines how to reconstruct the URI representation. The BINARY representation can be understood in a similar fashion. This representation starts with the prefix "01" and is then followed by the same two fields, contractorID and divisionID, this time, in their respective binary formats. Given this XML metadata structure, contractor tags can now be decoded from their URI and BINARY representations and the resulting fields can be re-encoded into one of these representations.

The EMPLOYEE_TAG scheme is defined in a similar fashion and is shown as follows.

```
<?xml version="1.0" encoding="UTF-8"?>
<TagDataTranslation version="0.04" date="2005-04-18T16:05:00Z"
  xmlns:xsi="http://www.w3.org/2001/XMLSchema"
  xmlns="oracle.mgd.idcode">
  <scheme name="EMPLOYEE_TAG" optionKey="1" xmlns="">
    <level type="URI" prefixMatch="mycompany.employee.">
      <option optionKey="1" pattern="mycompany.employee.([0-9]*).([0-9]*)"
        grammar="'mycompany.employee.' employeeID '.' divisionID">
        <field seq="1" characterSet="[0-9]*" name="employeeID"/>
        <field seq="2" characterSet="[0-9]*" name="divisionID"/>
      </option>
    </level>
    <level type="BINARY" prefixMatch="01">
      <option optionKey="1" pattern="01([01]{7})([01]{6})"
        grammar="'01' employeeID divisionID ">
        <field seq="1" characterSet="[01]*" name="employeeID"/>
        <field seq="2" characterSet="[01]*" name="divisionID"/>
      </option>
    </level>
  </scheme>
</TagDataTranslation>;
```

To add these schemes to the category ID previously created, use the DBMS_MGD_ID_UTIL.add_scheme function.

This script creates the MGD_SAMPLE_CATEGORY category, adds a contractor scheme and an employee scheme to the MGD_SAMPLE_CATEGORY category, validates the MGD_SAMPLE_CATEGORY scheme, tests the tag translation of the contractor scheme and the employee scheme, then removes the contractor scheme, tests the tag translation of the contractor scheme and this returns the expected exception for the removed contractor scheme, tests the tag translation of the employee scheme and this returns the expected values, then removes the MGD_SAMPLE_CATEGORY category:

```
--contents of add_scheme2.sql
SET LINESIZE 160
CALL DBMS_MGD_ID_UTIL.set_proxy('example.com', '80');
-----
---CREATE CATEGORY, ADD_SCHEME, REMOVE_SCHEME, REMOVE_CATEGORY-----
-----
DECLARE
  amt          NUMBER;
  buf          VARCHAR2(32767);
  pos          NUMBER;
  tdt_xml      CLOB;
  validate_tdtxml VARCHAR2(1042);
  category_id  VARCHAR2(256);
BEGIN
  -- remove the testing category if it exists
  DBMS_MGD_ID_UTIL.remove_category('MGD_SAMPLE_CATEGORY', '1.0');
  -- create the testing category 'MGD_SAMPLE_CATEGORY', version 1.0
  category_id := DBMS_MGD_ID_UTIL.CREATE_CATEGORY('MGD_SAMPLE_CATEGORY', '1.0', 'Oracle',
```

```

'http://www.oracle.com/mgd/sample');
-- add contractor scheme to the category
DBMS_LOB.CREATETEMPORARY(tdt_xml, true);
DBMS_LOB.OPEN(tdt_xml, DBMS_LOB.LOB_READWRITE);

buf := '<?xml version="1.0" encoding="UTF-8"?>
<TagDataTranslation version="0.04" date="2005-04-18T16:05:00Z"
      xmlns:xsi="http://www.w3.org/2001/XMLSchema"
      xmlns="oracle.mgd.idcode">
<scheme name="CONTRACTOR_TAG" optionKey="1" xmlns="">
<level type="URI" prefixMatch="mycompany.contractor.">
  <option optionKey="1" pattern="mycompany.contractor.([0-9]*).([0-9]*"
    grammar="'mycompany.contractor.'" contractorID ''.' divisionID">
    <field seq="1" characterSet="[0-9]*" name="contractorID"/>
    <field seq="2" characterSet="[0-9]*" name="divisionID"/>
  </option>
</level>
<level type="BINARY" prefixMatch="11">
  <option optionKey="1" pattern="11([01]{7})([01]{6})"
    grammar="'11' contractorID divisionID ">
    <field seq="1" characterSet="[01]*" name="contractorID"/>
    <field seq="2" characterSet="[01]*" name="divisionID"/>
  </option>
</level>
</scheme>
</TagDataTranslation>';

amt := length(buf);
pos := 1;
DBMS_LOB.WRITE(tdt_xml, amt, pos, buf);
DBMS_LOB.CLOSE(tdt_xml);

DBMS_MGD_ID_UTL.ADD_SCHEME(category_id, tdt_xml);

-- add employee scheme to the category
DBMS_LOB.CREATETEMPORARY(tdt_xml, true);
DBMS_LOB.OPEN(tdt_xml, DBMS_LOB.LOB_READWRITE);

buf := '<?xml version="1.0" encoding="UTF-8"?>
<TagDataTranslation version="0.04" date="2005-04-18T16:05:00Z"
      xmlns:xsi="http://www.w3.org/2001/XMLSchema"
      xmlns="oracle.mgd.idcode">
<scheme name="EMPLOYEE_TAG" optionKey="1" xmlns="">
<level type="URI" prefixMatch="mycompany.employee.">
  <option optionKey="1" pattern="mycompany.employee.([0-9]*).([0-9]*"
    grammar="'mycompany.employee.'" employeeID ''.' divisionID">
    <field seq="1" characterSet="[0-9]*" name="employeeID"/>
    <field seq="2" characterSet="[0-9]*" name="divisionID"/>
  </option>
</level>
<level type="BINARY" prefixMatch="01">
  <option optionKey="1" pattern="01([01]{7})([01]{6})"
    grammar="'01' employeeID divisionID ">
    <field seq="1" characterSet="[01]*" name="employeeID"/>
    <field seq="2" characterSet="[01]*" name="divisionID"/>
  </option>
</level>
</scheme>
</TagDataTranslation>';

amt := length(buf);

```

```

pos := 1;
DBMS_LOB.WRITE(tdt_xml, amt, pos, buf);
DBMS_LOB.CLOSE(tdt_xml);
DBMS_MGD_ID_UTL.ADD_SCHEME(category_id, tdt_xml);

-- validate the scheme
dbms_output.put_line('Validate the MGD_SAMPLE_CATEGORY Scheme');
validate_tdtxml := DBMS_MGD_ID_UTL.validate_scheme(tdt_xml);
dbms_output.put_line(validate_tdtxml);
dbms_output.put_line('Length of scheme xml is: '||DBMS_LOB.GETLENGTH(tdt_xml));

-- test tag translation of contractor scheme
dbms_output.put_line(
  mgd_id.translate('MGD_SAMPLE_CATEGORY', NULL,
    'mycompany.contractor.123.45',
    NULL, 'BINARY'));

dbms_output.put_line(
  mgd_id.translate('MGD_SAMPLE_CATEGORY', NULL,
    '11111011101101',
    NULL, 'URI'));

-- test tag translation of employee scheme
dbms_output.put_line(
  mgd_id.translate('MGD_SAMPLE_CATEGORY', NULL,
    'mycompany.employee.123.45',
    NULL, 'BINARY'));

dbms_output.put_line(
  mgd_id.translate('MGD_SAMPLE_CATEGORY', NULL,
    '011111011101101',
    NULL, 'URI'));

DBMS_MGD_ID_UTL.REMOVE_SCHEME(category_id, 'CONTRACTOR_TAG');

-- Test tag translation of contractor scheme. Doesn't work any more.
BEGIN
  dbms_output.put_line(
    mgd_id.translate('MGD_SAMPLE_CATEGORY', NULL,
      'mycompany.contractor.123.45',
      NULL, 'BINARY'));

  dbms_output.put_line(
    mgd_id.translate('MGD_SAMPLE_CATEGORY', NULL,
      '111111011101101',
      NULL, 'URI'));
EXCEPTION
  WHEN others THEN
    dbms_output.put_line('Contractor tag translation failed: '||SQLERRM);
END;

-- Test tag translation of employee scheme. Still works.
BEGIN
  dbms_output.put_line(
    mgd_id.translate('MGD_SAMPLE_CATEGORY', NULL,
      'mycompany.employee.123.45',
      NULL, 'BINARY'));
  dbms_output.put_line(
    mgd_id.translate('MGD_SAMPLE_CATEGORY', NULL,
      '011111011101101',
      NULL, 'URI'));

```

```

EXCEPTION
  WHEN others THEN
    dbms_output.put_line('Employee tag translation failed: '||SQLERRM);
END;

-- remove the testing category, which also removes all the associated schemes
DBMS_MGD_ID_UTL.remove_category('MGD_SAMPLE_CATEGORY', '1.0');
END;
/
SHOW ERRORS;
call DBMS_MGD_ID_UTL.remove_proxy();

@add_scheme3.sql
.
.
.
Validate the MGD_SAMPLE_CATEGORY Scheme
EMPLOYEE_TAG;URI,BINARY;divisionID,employeeID
Length of scheme xml is: 933
111111011101101
mycompany.contractor.123.45
011111011101101
mycompany.employee.123.45
Contractor tag translation failed: ORA-55203: Tag data translation level not found
ORA-06512: at "MGDSYS.DBMS_MGD_ID_UTL", line 54
ORA-06512: at "MGDSYS.MGD_ID", line 242
ORA-29532: Java call terminated by uncaught Java
exception: oracle.mgd.idcode.exceptions.TDTLevelNotFound: Matching level not
found for any configured scheme
011111011101101
mycompany.employee.123.45
.
.
.

```

25.4 Identity Code Package Types

[Table 25-2](#) (page 25-18) describes the Identity Code Package ADTs.

Table 25-2 Identity Code Package ADTs

ADT Name	Description
MGD_ID_COMPONENT ADT	A data type that specifies the name and value pair attributes that define a component.
MGD_ID_COMPONENT_VARRAY ADT	A data type that specifies a list of up to 128 components as name-value attribute pairs used in two constructor functions for creating an identity code type object.
MGD_ID ADT	Represents an identity code type that specifies the category identifier for the code category for this identity code and its list of components.

[Table 25-3](#) (page 25-19) describes the subprograms in the MGD_ID ADT.

All the values and names passed to the subprograms defined in the MGD_ID ADT are case-insensitive unless otherwise noted. To preserve case, enclose values in double quotation marks.

Table 25-3 MGD_ID ADT Subprograms

Subprogram	Description
MGD_ID Constructor Function	Creates an identity code type object, MGD_ID, and returns self.
FORMAT Member Function	Returns a representation of an identity code given an MGD_ID component.
GET_COMPONENT Member Function	Returns the value of an MGD_ID component.
TO_STRING Member Function	Concatenates the <code>category_id</code> parameter value with the components name-value attribute pair.
TRANSLATE Static Function	Translates one MGD_ID representation of an identity code into a different MGD_ID representation.

25.5 DBMS_MGD_ID_UTL Package

[Table 25-4](#) (page 25-19) describes the Utility subprograms in the `DBMS_MGD_ID_UTL` package.

All the values and names passed to the subprograms defined in the `MGD_ID` ADT are case-insensitive unless otherwise noted. To preserve case, enclose values in double quotation marks.

Table 25-4 DBMS_MGD_ID_UTL Package Utility Subprograms

Subprogram	Description
ADD_SCHEME Procedure	Adds a tag data translation scheme to an existing category.
CREATE_CATEGORY Function	Creates a category or a version of a category.
EPC_TO_ORACLE Function	Converts the EPCglobal tag data translation (TDT) XML to Oracle Database tag data translation XML.
GET_CATEGORY_ID Function	Returns the category ID given the category name and the category version.
GET_COMPONENTS Function	Returns all relevant separated component names separated by semicolon (;) for the specified scheme.
GET_ENCODINGS Function	Returns a list of semicolon (;) separated encodings (formats) for the specified scheme.
GET_JAVA_LOGGING_LEVEL Function	Returns an integer representing the current Java trace logging level.
GET_PLSQL_LOGGING_LEVEL Function	Returns an integer representing the current PL/SQL trace logging level.
GET_SCHEME_NAMES Function	Returns a list of semicolon (;) separated scheme names for the specified category.
GET_TDT_XML Function	Returns the Oracle Database tag data translation XML for the specified scheme.

Table 25-4 (Cont.) DBMS_MGD_ID_UTL Package Utility Subprograms

Subprogram	Description
GET_VALIDATOR Function	Returns the Oracle Database tag data translation schema.
REFRESH_CATEGORY Function	Refreshes the metadata information about the Java stack for the specified category.
REMOVE_CATEGORY Function	Removes a category including all the related TDT XML.
REMOVE_PROXY Procedure	Unsets the host and port of the proxy server.
REMOVE_SCHEME Procedure	Removes the tag scheme for a category.
SET_JAVA_LOGGING_LEVEL Procedure	Sets the Java logging level.
SET_PLSQL_LOGGING_LEVEL Procedure	Sets the PL/SQL tracing logging level.
SET_PROXY Procedure	Sets the host and port of the proxy server for Internet access.
VALIDATE_SCHEME Function	Validates the input tag data translation XML against the Oracle Database tag data translation schema.

25.6 Identity Code Metadata Tables and Views

This topic describes the structure of identity code metadata tables and views and explains how the metadata are used by the Identity Code Package to interpret the various RFID tags. The creation of these meta tables, views, and triggers is done automatically during the Identity Code Package installation.

Encoding metadata views are used to store encoding categories and schemes. Application developers can insert the meta information of their own identity codes into these views. The MGD_ID ADT is designed to understand the encodings if the metadata for the encodings are stored in the meta tables. If an application developer uses only the encodings defined in the EPC specification v1.1, the developer does not have to worry about the meta tables because product codes specified in EPC spec v1.1 are predefined.

There are two encoding metadata views:

- `user_mgd_id_category` stores the encoding category information defined by the session user.
- `user_mgd_id_scheme` stores the encoding type information defined by the session user.

You can query the following read-only views to see the system's predefined encoding metadata and the metadata defined by the user:

- `mgd_id_category` lets you query the encoding category information defined by the system or the session user
- `mgd_id_scheme` lets you query the encoding type information defined by the system or the session user.

The underlying metadata tables for the preceding views are:

- `mgd_id_xml_validator`
- `mgd_id_category_tab`
- `mgd_id_scheme_tab`

Users other than the Identity Code Package system users cannot operate on these tables. Users must not use the metadata tables directly. They must use the read-only views and the metadata functions described in the `DBMS_MGD_ID_UTL` package.

See Also:

Oracle Database PL/SQL Packages and Types Reference for information about the `DBMS_MGD_ID_UTL` package

Metadata View Definitions

[Table 25-5](#) (page 25-21), [Table 25-6](#) (page 25-21), [Table 25-7](#) (page 25-21), and [Table 25-8](#) (page 25-22) describe the metadata view definitions for the `MGD_ID_CATEGORY`, `USER_ID_CATEGORY`, `MGD_ID_SCHEME`, and `USER_MGD_ID_SCHEME` respectively as defined in the `mgdview.sql` file.

Table 25-5 Definition and Description of the `MGD_ID_CATEGORY` Metadata View

Column Name	Data Type	Description
<code>CATEGORY_ID</code>	<code>NUMBER (4)</code>	Category identifier
<code>CATEGORY_NAME</code>	<code>VARCHAR2 (256)</code>	Category name
<code>AGENCY</code>	<code>VARCHAR2 (256)</code>	Organization that defined the category
<code>VERSION</code>	<code>VARCHAR2 (256)</code>	Category version
<code>URI</code>	<code>VARCHAR2 (256)</code>	URI that describes the category

Table 25-6 Definition and Description of the `USER_MGD_ID_CATEGORY` Metadata View

Column Name	Data Type	Description
<code>CATEGORY_ID</code>	<code>NUMBER (4)</code>	Category identifier
<code>CATEGORY_NAME</code>	<code>VARCHAR2 (256)</code>	Category name
<code>AGENCY</code>	<code>VARCHAR2 (256)</code>	Organization that defined the category
<code>VERSION</code>	<code>VARCHAR2 (256)</code>	Category version
<code>URI</code>	<code>VARCHAR2 (256)</code>	URI that describes the category

Table 25-7 Definition and Description of the `MGD_ID_SCHEME` Metadata View

Column Name	Data Type	Description
<code>CATEGORY_ID</code>	<code>NUMBER (4)</code>	Category identifier

Table 25-7 (Cont.) Definition and Description of the MGD_ID_SCHEME Metadata View

Column Name	Data Type	Description
TYPE_NAME	VARCHAR2 (256)	Encoding scheme name, for example, SGTIN-96, GID-96, and so on
TDT_XML	CLOB	Tag data translation XML for this encoding scheme
ENCODINGS	VARCHAR2 (256)	Encodings separated by a comma (,), for example, LEGACY, TAG_ENCODING, PURE_IDENTITY, BINARY (for SGTIN-96)
COMPONENTS	VARCHAR2 (1024)	Relevant component names, extracted from each level and then combined. Each is separated by a comma (.). For example, objectclass, generalmanager, serial (for GID-96)

Table 25-8 Definition and Description of the USER_MGD_ID_SCHEME Metadata View

Column Name	Data Type	Description
CATEGORY_ID	NUMBER (4)	Category identifier
TYPE_NAME	VARCHAR2 (256)	Encoding scheme name, for example, SGTIN-96, GID-96, and so on
TDT_XML	CLOB	Tag data translation XML for this encoding scheme
ENCODINGS	VARCHAR2 (256)	Encodings separated by a comma (,), for example, LEGACY, TAG_ENCODING, PURE_IDENTITY, BINARY (for SGTIN-96)
COMPONENTS	VARCHAR2 (1024)	Relevant component names, extracted from each level and then combined. Each is separated by a comma (.). For example, objectclass, generalmanager, serial (for GID-96)

25.7 Electronic Product Code (EPC) Concepts

Topics:

- [RFID Technology and EPC v1.1 Coding Schemes](#) (page 25-23)
- [Product Code Concepts and Their Current Use](#) (page 25-23)

25.7.1 RFID Technology and EPC v1.1 Coding Schemes

Radio Frequency Identification (RFID) technology continues to gain momentum with suppliers, distributors, manufacturers, and retailers for its ability to eliminate line-of-site processes and automate critical supply chain transactions. Electronic Product Code (EPC), an identification scheme for universally identifying objects using RFID tags and other means, is gaining widespread acceptance as an emerging standard. Its capabilities enable companies to reduce warehouse and distribution costs through improved inventory control and extended supply chain visibility.

The standardized EPC Identifier is a metacoding scheme designed to support the needs of various industries. Therefore, the EPC represents a family of coding schemes and a means to make them unique across all possible EPC-compliant tags. EPC Version 1.1 includes these specific coding schemes:

- General Identifier (GID)
- Serialized version of the EAN.UCC Global Trade Item Number (GTIN)
- EAN.UCC Serial Shipping Container Code (SSCC)
- EAN.UCC Global Location Number (GLN)
- EAN.UCC Global Returnable Asset Identifier (GRAI)
- EAN.UCC Global Individual Asset Identifier (GIAI)

RFID applications require the storage of a large volume of EPC data into a database. The efficient use of EPC data also requires that the database recognizes the different coding schemes of EPC data.

EPC is an emerging standard. It does not cover all the numbering schemes used in the various industries and is itself still evolving (the changes from EPC version 1.0 to EPC version 1.1 are significant).

Identity Code Package empowers the Oracle Database with the knowledge to recognize EPC coding schemes. It makes the Oracle Database a database system that not only provides efficient storage and component level retrieval for EPC data, but also has features to support EPC data encoding and decoding, and conversion between bit encoding and URI encoding.

Identity Code Package provides an extensible framework that allows developers to define their own coding schemes that are not included in the EPC standard. This extensibility feature also makes the Oracle Database adaptable to the evolving future EPC standard.

This chapter describes the requirement of storing, retrieving, encoding and decoding various product codes, including EPC, in an Oracle Database and shows how the Identity Code Package solution meets all these requirements by providing data types, metadata tables, and PL/SQL packages for these purposes.

25.7.2 Product Code Concepts and Their Current Use

This topic describes these product codes:

- [Electronic Product Code \(EPC\)](#) (page 25-24)
- [Global Trade Identification Number \(GTIN\) and Serializable Global Trade Identification Number \(SGTIN\)](#) (page 25-25)

- [Serial Shipping Container Code \(SSCC\)](#) (page 25-25)
- [Global Location Number \(GLN\) and Serializable Global Location Number \(SGLN\)](#) (page 25-25)
- [Global Returnable Asset Identifier \(GRAI\)](#) (page 25-26)
- [Global Individual Asset Identifier \(GIAI\)](#) (page 25-26)
- [RFID EPC Network](#) (page 25-26)

25.7.2.1 Electronic Product Code (EPC)

The Electronic Product Code™ (EPC™) is an identification scheme for universally identifying physical objects using Radio Frequency Identification (RFID) tags and other means. The standardized EPC data consists of an EPC (or EPC Identifier) that uniquely identifies an individual object, and an optional Filter Value when judged to be necessary to enable effective and efficient reading of the EPC tags. In addition to this standardized data, certain classes of EPC tags allow user-defined data.

The EPC Identifier is a meta-coding scheme designed to support the needs of various industries by accommodating both existing coding schemes where possible and defining schemes where necessary. The various coding schemes are referred to as Domain Identifiers, to indicate that they provide object identification within certain domains such as a particular industry or group of industries. As such, EPC represents a family of coding schemes (or "namespaces") and a means to make them unique across all possible EPC-compliant tags.

The EPCGlobal EPC Data Standards Version 1.1 defines the abstract content of the Electronic Product Code, and its concrete realization in the form of RFID tags, Internet URIs, and other representations. In EPC Version 1.1, the specific coding schemes include a General Identifier (GID), a serialized version of the EAN.UCC Global Trade Item Number (GTIN®), the EAN.UCC Serial Shipping Container Code (SSCC®), the EAN.UCC Global Location Number (GLN®), the EAN.UCC Global Returnable Asset Identifier (GRAI®), and the EAN.UCC Global Individual Asset Identifier (GIAI®).

25.7.2.1.1 EPC Pure Identity

The EPC pure identity is the identity associated with a specific physical or logical entity, independent of any particular encoding vehicle such as an RF tag, bar code or database field. As such, a pure identity is an abstract name or number used to identify an entity. A pure identity consists of the information required to uniquely identify a specific entity, and no more.

25.7.2.1.2 EPC Encoding

EPC encoding is a pure identity with more information, such as filter value, rendered into a specific syntax (typically consisting of value fields of specific sizes). A given pure identity might have several possible encodings, such as a Barcode Encoding, various Tag Encodings, and various URI Encodings. Encodings can also incorporate additional data besides the identity (such as the Filter Value used in some encodings), in which case the encoding scheme specifies what additional data it can hold.

For example, the Serial Shipping Container Code (SSCC) format as defined by the EAN.UCC System is an example of a pure identity. An SSCC encoded into the EPC-SSCC 96-bit format is an example of an encoding.

25.7.2.1.3 EPC Tag Bit-Level Encoding

EPC encoding on a tag is a string of bits, consisting of a tiered, variable length header followed by a series of numeric fields whose overall length, structure, and function are completely determined by the header value.

25.7.2.1.4 EPC Identity URI

The EPC identity URI is a representation of a pure identity as a Uniform Resource Identifier (URI).

25.7.2.1.5 EPC Tag URI Encoding

The EPC tag URI encoding represents a specific EPC tag bit-level encoding, for example, `urn:epc:tag:sgtin-64:3.0652642.800031.400`.

25.7.2.1.6 EPC Encoding Procedure

The EPC encoding procedure generates an EPC tag bit-level encoding using various information.

25.7.2.1.7 EPC Decoding Procedure

The EPC decoding procedure converts an EPC tag bit-level encoding to an EAN.UCC code.

25.7.2.2 Global Trade Identification Number (GTIN) and Serializable Global Trade Identification Number (SGTIN)

A Global Trade Identification Number (GTIN) is used for the unique identification of trade items worldwide within the EAN.UCC system. The Serialized Global Trade Identification Number (SGTIN) is an identity type in EPC standard version 1.1. It is based on the EAN.UCC GTIN code defined in the General EAN.UCC Specifications [GenSpec5.0]. A GTIN identifies a particular class of object, such as a particular kind of product or SKU. The combination of GTIN and a unique serial number is called a Serialized GTIN (SGTIN).

25.7.2.3 Serial Shipping Container Code (SSCC)

The Serial Shipping Container Code (SSCC) is defined by the General EAN.UCC Specifications [GenSpec5.0]. The unique identification of logistics units is achieved in the EAN.UCC system by the use of the SSCC. The SSCC is intended for assignment to individual objects.

25.7.2.4 Global Location Number (GLN) and Serializable Global Location Number (SGLN)

The Global Location Number (GLN) is defined by the General EAN.UCC Specifications [GenSpec5.0]. A GLN can represent either a discrete, unique physical location such as a dock door or a warehouse slot, or an aggregate physical location such as an entire warehouse. Also, a GLN can represent a logical entity such as an organization that performs a business function (for example, placing an order). The combination of GLN and a unique serial number is called a Serialized GLN (SGLN). However, until the EAN.UCC community determines the appropriate way to extend GLN, the serial number field is reserved and must not be used.

25.7.2.5 Global Returnable Asset Identifier (GRAI)

A returnable asset is a reusable package or transport equipment of a certain value. Global Returnable Asset Identifier (GRAI) is defined by the General EAN.UCC Specifications [GenSpec5.0] for the unique identification of a returnable asset.

25.7.2.6 Global Individual Asset Identifier (GIAI)

The Global Individual Asset Identifier (GIAI) is defined by the General EAN.UCC Specifications [GenSpec5.0]. Unlike the GTIN, the GIAI is intended for assignment to individual objects. Global Individual Asset Identifier (GIAI) uniquely identifies an entity that is part of the fixed inventory of a company. The GIAI identifies any fixed asset of an organization.

25.7.2.7 RFID EPC Network

The RFID EPC network identifies, tracks, and locates assets. Physical objects are identified by a unique RFID enabled EPC.

25.8 Oracle Database Tag Data Translation Schema

The Oracle Database Tag Data Translation Schema is closely related to the EPCglobal TDT schema, however it is not exact. The Oracle Database TDT is shown as follows:

```
<?xml version="1.0" encoding="UTF-8"?>
<xsd:schema targetNamespace="oracle.mgd.idcode"
  xmlns:xsd="http://www.w3.org/2001/XMLSchema"
  xmlns:tdt="oracle.mgd.idcode" elementFormDefault="qualified"
  attributeFormDefault="unqualified" version="1.0">

  <xsd:simpleType name="InputFormatList">
    <xsd:restriction base="xsd:string">
      <xsd:enumeration value="BINARY"/>
      <xsd:enumeration value="STRING"/>
    </xsd:restriction>
  </xsd:simpleType>

  <xsd:simpleType name="LevelTypeList">
    <xsd:restriction base="xsd:string">
    </xsd:restriction>
  </xsd:simpleType>

  <xsd:simpleType name="SchemeNameList">
    <xsd:restriction base="xsd:string">
    </xsd:restriction>
  </xsd:simpleType>

  <xsd:simpleType name="ModeList">
    <xsd:restriction base="xsd:string">
      <xsd:enumeration value="EXTRACT"/>
      <xsd:enumeration value="FORMAT"/>
    </xsd:restriction>
  </xsd:simpleType>

  <xsd:simpleType name="CompactionMethodList">
    <xsd:restriction base="xsd:string">
      <xsd:enumeration value="32-bit"/>
      <xsd:enumeration value="16-bit"/>
      <xsd:enumeration value="8-bit"/>
      <xsd:enumeration value="7-bit"/>
    </xsd:restriction>
  </xsd:simpleType>
```



```

    <xsd:enumeration value="6-bit"/>
    <xsd:enumeration value="5-bit"/>
  </xsd:restriction>
</xsd:simpleType>

<xsd:simpleType name="PadDirectionList">
  <xsd:restriction base="xsd:string">
    <xsd:enumeration value="LEFT"/>
    <xsd:enumeration value="RIGHT"/>
  </xsd:restriction>
</xsd:simpleType>

<xsd:complexType name="Field">
  <xsd:attribute name="seq" type="xsd:integer" use="required"/>
  <xsd:attribute name="name" type="xsd:string" use="required"/>
  <xsd:attribute name="bitLength" type="xsd:integer"/>
  <xsd:attribute name="characterSet" type="xsd:string" use="required"/>
  <xsd:attribute name="compaction" type="tdt:CompactionMethodList"/>
  <xsd:attribute name="compression" type="xsd:string"/>
  <xsd:attribute name="padChar" type="xsd:string"/>
  <xsd:attribute name="padDir" type="tdt:PadDirectionList"/>
  <xsd:attribute name="decimalMinimum" type="xsd:long"/>
  <xsd:attribute name="decimalMaximum" type="xsd:long"/>
  <xsd:attribute name="length" type="xsd:integer"/>
</xsd:complexType>

<xsd:complexType name="Option">
  <xsd:sequence>
    <xsd:element name="field" type="tdt:Field" maxOccurs="unbounded"/>
  </xsd:sequence>
  <xsd:attribute name="optionKey" type="xsd:string" use="required"/>
  <xsd:attribute name="pattern" type="xsd:string"/>
  <xsd:attribute name="grammar" type="xsd:string" use="required"/>
</xsd:complexType>

<xsd:complexType name="Rule">
  <xsd:attribute name="type" type="tdt:ModeList" use="required"/>
  <xsd:attribute name="inputFormat" type="tdt:InputFormatList" use="required"/>
  <xsd:attribute name="seq" type="xsd:integer" use="required"/>
  <xsd:attribute name="newFieldName" type="xsd:string" use="required"/>
  <xsd:attribute name="characterSet" type="xsd:string" use="required"/>
  <xsd:attribute name="padChar" type="xsd:string"/>
  <xsd:attribute name="padDir" type="tdt:PadDirectionList"/>
  <xsd:attribute name="decimalMinimum" type="xsd:long"/>
  <xsd:attribute name="decimalMaximum" type="xsd:long"/>
  <xsd:attribute name="length" type="xsd:string"/>
  <xsd:attribute name="function" type="xsd:string" use="required"/>
  <xsd:attribute name="tableURI" type="xsd:string"/>
  <xsd:attribute name="tableParams" type="xsd:string"/>
  <xsd:attribute name="tableXPath" type="xsd:string"/>
  <xsd:attribute name="tableSQL" type="xsd:string"/>
</xsd:complexType>

<xsd:complexType name="Level">
  <xsd:sequence>
    <xsd:element name="option" type="tdt:Option" minOccurs="1"
      maxOccurs="unbounded"/>
    <xsd:element name="rule" type="tdt:Rule" minOccurs="0"
      maxOccurs="unbounded"/>
  </xsd:sequence>
  <xsd:attribute name="type" type="tdt:LevelTypeList" use="required"/>

```

```
<xsd:attribute name="prefixMatch" type="xsd:string"/>
<xsd:attribute name="requiredParsingParameters" type="xsd:string"/>
<xsd:attribute name="requiredFormattingParameters" type="xsd:string"/>
</xsd:complexType>

<xsd:complexType name="Scheme">
  <xsd:sequence>
    <xsd:element name="level" type="tdt:Level" minOccurs="4" maxOccurs="5"/>
  </xsd:sequence>
  <xsd:attribute name="name" type="tdt:SchemeNameList" use="required"/>
  <xsd:attribute name="optionKey" type="xsd:string" use="required"/>
</xsd:complexType>
<xsd:complexType name="TagDataTranslation">
  <xsd:sequence>
    <xsd:element name="scheme" type="tdt:Scheme" maxOccurs="unbounded"/>
  </xsd:sequence>
  <xsd:attribute name="version" type="xsd:string" use="required"/>
  <xsd:attribute name="date" type="xsd:dateTime" use="required"/>
</xsd:complexType>
<xsd:element name="TagDataTranslation" type="tdt:TagDataTranslation"/>
</xsd:schema>
```

Understanding Schema Object Dependency

If the definition of object A references object B, then A depends on B. This chapter explains dependencies among schema objects, and how Oracle Database automatically tracks and manages these dependencies. Because of this automatic dependency management, A never uses an obsolete version of B, and you almost never have to explicitly recompile A after you change B.

Topics:

- [Overview of Schema Object Dependency](#) (page 26-1)
- [Querying Object Dependencies](#) (page 26-4)
- [Object Status](#) (page 26-4)
- [Invalidation of Dependent Objects](#) (page 26-5)
- [Guidelines for Reducing Invalidation](#) (page 26-9)
- [Object Revalidation](#) (page 26-10)
- [Name Resolution in Schema Scope](#) (page 26-11)
- [Local Dependency Management](#) (page 26-12)
- [Remote Dependency Management](#) (page 26-12)
- [Remote Procedure Call \(RPC\) Dependency Management](#) (page 26-13)
- [Shared SQL Dependency Management](#) (page 26-21)

26.1 Overview of Schema Object Dependency

Some types of schema objects can reference other objects in their definitions. For example, a view is defined by a query that references tables or other views, and the body of a subprogram can include SQL statements that reference other objects. If the definition of object A references object B, then A is a **dependent object** (of B) and B is a **referenced object** (of A).

26.1.1 Example: Displaying Dependent and Referenced Object Types

[Example 26-1](#) (page 26-1) shows how to display the dependent and referenced object types in your database (if you are logged in as DBA).

Example 26-1 *Displaying Dependent and Referenced Object Types*

Display dependent object types:

```
SELECT DISTINCT TYPE
FROM DBA_DEPENDENCIES
ORDER BY TYPE;
```

Result:

```
TYPE
-----
DIMENSION
EVALUATION CONTEXT
FUNCTION
INDEX
INDEXTYPE
JAVA CLASS
JAVA DATA
MATERIALIZED VIEW
OPERATOR
PACKAGE
PACKAGE BODY
PROCEDURE
RULE
RULE SET
SYNONYM
TABLE
TRIGGER
TYPE
TYPE BODY
UNDEFINED
VIEW
XML SCHEMA
```

22 rows selected.

Display referenced object types:

```
SELECT DISTINCT REFERENCED_TYPE
FROM DBA_DEPENDENCIES
ORDER BY REFERENCED_TYPE;
```

Result:

```
REFERENCED_TYPE
-----
EVALUATION CONTEXT
FUNCTION
INDEX
INDEXTYPE
JAVA CLASS
LIBRARY
OPERATOR
PACKAGE
PROCEDURE
SEQUENCE
SYNONYM
TABLE
TYPE
VIEW
XML SCHEMA
```

14 rows selected.

If you alter the definition of a referenced object, dependent objects might not continue to function without error, depending on the type of alteration. For example, if you drop a table, no view based on the dropped table is usable.

26.1.2 Example: Schema Object Change that Invalidates Some Dependents

As an example of a schema object change that invalidates some dependents but not others, consider the two views in the following example, which are based on the HR.EMPLOYEES table.

Example 26-2 (page 26-3) creates two views from the EMPLOYEES table: SIXFIGURES, which selects all columns in the table, and COMMISSIONED, which does not include the EMAIL column. As the example shows, changing the EMAIL column invalidates SIXFIGURES, but not COMMISSIONED.

Example 26-2 Schema Object Change That Invalidates Some Dependents

```
CREATE OR REPLACE VIEW sixfigures AS
SELECT * FROM employees
WHERE salary >= 100000;

CREATE OR REPLACE VIEW commissioned AS
SELECT first_name, last_name, commission_pct
FROM employees
WHERE commission_pct > 0.00;
```

SQL*Plus formatting command:

```
COLUMN object_name FORMAT A16
```

Query:

```
SELECT object_name, status
FROM user_objects
WHERE object_type = 'VIEW'
ORDER BY object_name;
```

Result:

OBJECT_NAME	STATUS
COMMISSIONED	VALID
EMP_DETAILS_VIEW	VALID
SIXFIGURES	INVALID

3 rows selected.

Lengthen EMAIL column of EMPLOYEES table:

```
ALTER TABLE employees MODIFY email VARCHAR2(100);
```

Query:

```
SELECT object_name, status
FROM user_objects
WHERE object_type = 'VIEW'
ORDER BY object_name;
```

Result:

OBJECT_NAME	STATUS
-----	-----
COMMISSIONED	VALID
EMP_DETAILS_VIEW	INVALID
SIXFIGURES	VALID

26.1.3 Example: View That Depends on Multiple Objects

A view depends on every object referenced in its query. The view in [Example 26-3](#) (page 26-4) depends on the tables `employees` and `departments`.

Example 26-3 View that Depends on Multiple Objects

```
CREATE OR REPLACE VIEW v AS
  SELECT last_name, first_name, department_name
  FROM employees e, departments d
  WHERE e.department_id = d.department_id
  ORDER BY last_name;
```

Note the following:

- `CREATE` statements automatically update all dependencies.
- Dynamic SQL statements do not create dependencies. For example, this statement does not create a dependency on `tab1`:

```
EXECUTE IMMEDIATE 'SELECT * FROM tab1'
```

26.2 Querying Object Dependencies

The static data dictionary views `USER_DEPENDENCIES`, `ALL_DEPENDENCIES`, and `DBA_DEPENDENCIES` describe dependencies between database objects.

The `utldtree.sql` SQL script creates the view `DEPTREE`, which contains information on the object dependency tree, and the view `IDEPTREE`, a presorted, pretty-print version of `DEPTREE`.

See Also:

Oracle Database Reference for more information about the `DEPTREE`, `IDEPTREE`, and `utldtree.sql` script

26.3 Object Status

Every database object has a status value described in [Table 26-1](#) (page 26-4).

Table 26-1 Database Object Status

Status	Meaning
Valid	The object was successfully compiled, using the current definition in the data dictionary.
Compiled with errors	The most recent attempt to compile the object produced errors.
Invalid	The object is marked invalid because an object that it references has changed. (Only a dependent object can be invalid.)

Table 26-1 (Cont.) Database Object Status

Status	Meaning
Unauthorized	An access privilege on a referenced object was revoked. (Only a dependent object can be unauthorized.)

Note:

The static data dictionary views `USER_OBJECTS`, `ALL_OBJECTS`, and `DBA_OBJECTS` do not distinguish between "Compiled with errors," "Invalid," and "Unauthorized"—they describe all of these as `INVALID`.

26.4 Invalidation of Dependent Objects

If object A depends on object B, which depends on object C, then A is a **direct dependent** of B, B is a direct dependent of C, and A is an **indirect dependent** of C.

Direct dependents are invalidated only by changes to the referenced object that affect them (changes to the signature of the referenced object).

Indirect dependents can be invalidated by changes to the reference object that do not affect them. If a change to C invalidates B, it invalidates A (and all other direct and indirect dependents of B). This is called **cascading invalidation**.

With **coarse-grained invalidation**, a data definition language (DDL) statement that changes a referenced object invalidates all of its dependents.

With **fine-grained invalidation**, a DDL statement that changes a referenced object invalidates only dependents for which either of these statements is true:

- The dependent relies on the attribute of the referenced object that the DDL statement changed.
- The compiled metadata of the dependent is no longer correct for the changed referenced object.

For example, if view `v` selects columns `c1` and `c2` from table `t`, a DDL statement that changes only column `c3` of `t` does not invalidate `v`.

The DDL statement `CREATE OR REPLACE object` has no effect under these conditions:

- `object` is a PL/SQL object, the new PL/SQL source text is identical to the existing PL/SQL source text, and the PL/SQL compilation parameter settings stored with `object` are identical to those in the session environment.

For information about PL/SQL compilation parameter settings, see *Oracle Database PL/SQL Language Reference*.

- `object` is a synonym and the statement does not change the target object.

The operations in the left column of [Table 26-2](#) (page 26-6) cause fine-grained invalidation, except in the cases in the right column. The cases in the right column, and all operations not listed in [Table 26-2](#) (page 26-6), cause coarse-grained invalidation.

Table 26-2 Operations that Cause Fine-Grained Invalidation

Operation	Exceptions
ALTER TABLE <i>table</i> ADD <i>column</i>	<ul style="list-style-type: none"> • Dependent object (except a view) uses SELECT * on <i>table</i>. • Dependent object uses <i>table</i> %rowtype. • Dependent object performs INSERT on <i>table</i> without specifying column list. • Dependent object references <i>table</i> in query that contains a join. • Dependent object references <i>table</i> in query that references a PL/SQL variable.
ALTER TABLE <i>table</i> {MODIFY RENAME DROP SET UNUSED} <i>column</i> ALTER TABLE <i>table</i> DROP CONSTRAINT <i>not_null_constraint</i>	<ul style="list-style-type: none"> • Dependent object directly references <i>column</i>. • Dependent object uses SELECT * on <i>table</i>. • Dependent object uses <i>table</i> %ROWTYPE. • Dependent object performs INSERT on <i>table</i> without specifying column list. • Dependent object is a trigger that depends on an entire row (that is, it does not specify a column in its definition). • Dependent object is a trigger that depends on a column to the right of the dropped column.
CREATE OR REPLACE VIEW <i>view</i> Online Table Redefinition (DBMS_REDEFINITION)	<p>Column lists of new and old definitions differ, and at least one of these is true:</p> <ul style="list-style-type: none"> • Dependent object references column that is modified or dropped in new view or table definition. • Dependent object uses <i>view</i> %rowtype or <i>table</i>%rowtype. • Dependent object performs INSERT on view or table without specifying column list. • New view definition introduces new columns, and dependent object references view or table in query that contains a join. • New view definition introduces new columns, and dependent object references view or table in query that references a PL/SQL variable. • Dependent object references view or table in RELIES ON clause.

Table 26-2 (Cont.) Operations that Cause Fine-Grained Invalidation

Operation	Exceptions
CREATE OR REPLACE SYNONYM <i>synonym</i>	<ul style="list-style-type: none"> • New and old <i>synonym</i> targets differ, and one is not a table. • Both old and new <i>synonym</i> targets are tables, and the tables have different column lists or different privilege grants. • Both old and new <i>synonym</i> targets are tables, and dependent object is a view that references a column that participates in a unique index on the old target but not in a unique index on the new target.
DROP INDEX	<ul style="list-style-type: none"> • The index is a function-based index and the dependent object is a trigger that depends either on an entire row or on a column that was added to <i>table</i> after a function-based index was created. • The index is a unique index, the dependent object is a view, and the view references a column participating in the unique index.
CREATE OR REPLACE {PROCEDURE FUNCTION}	<p>Call signature changes. Call signature is the parameter list (order, names, and types of parameters), return type, ACCESSIBLE BY clause ("white list"), purity¹, determinism, parallelism, pipelining, and (if the procedure or function is implemented in C or Java) implementation properties.</p>

Table 26-2 (Cont.) Operations that Cause Fine-Grained Invalidation

Operation	Exceptions
CREATE OR REPLACE PACKAGE	<ul style="list-style-type: none"> • ACCESSIBLE BY clause ("white list") changes. • Dependent object references a dropped or renamed package item. • Dependent object references a package procedure or function whose call signature or entry-point number², changed. If referenced procedure or function has multiple overload candidates, dependent object is invalidated if any overload candidate's call signature or entry point number changed, or if a candidate was added or dropped. • Dependent object references a package cursor whose call signature, rowtype, or entry point number changed. • Dependent object references a package type or subtype whose definition changed. • Dependent object references a package variable or constant whose name, data type, initial value, or offset number changed. • Package purity¹ changed.

¹ **Purity** refers to a set of rules for preventing side effects (such as unexpected data changes) when invoking PL/SQL functions within SQL queries. **Package purity** refers to the purity of the code in the package initialization block.

² The **entry-point number** of a procedure or function is determined by its location in the PL/SQL package code. A procedure or function added to the end of a PL/SQL package is given a new entry-point number.

Note:

A dependent object that is invalidated by an operation in [Table 26-2](#) (page 26-6) appears in the static data dictionary views *_OBJECTS and *_OBJECTS_AE only after an attempt to reference it (either during compilation or execution) or after invoking one of these subprograms:

- DBMS_UTILITY.COMPILE_SCHEMA (described in *Oracle Database PL/SQL Packages and Types Reference*)
 - Any UTL_RECOMP subprogram (described in *Oracle Database PL/SQL Packages and Types Reference*)
-
-

Topics:

- [Session State and Referenced Packages](#) (page 26-9)
- [Security Authorization](#) (page 26-9)

26.4.1 Session State and Referenced Packages

Each session that references a package construct has its own instantiation of that package, including a persistent state of any public and private variables, cursors, and constants. All of a session's package instantiations, including state, can be lost if any of the session's instantiated packages are subsequently invalidated and revalidated.

See Also:

- *Oracle Database PL/SQL Language Reference* for information about package instantiation
 - *Oracle Database PL/SQL Language Reference* for information about package state
-
-

26.4.2 Security Authorization

When a data manipulation language (DML) object or system privilege is granted to, or revoked from, a user or PUBLIC, Oracle Database invalidates all the owner's dependent objects, to verify that an owner of a dependent object continues to have the necessary privileges for all referenced objects.

26.5 Guidelines for Reducing Invalidation

To reduce invalidation of dependent objects, follow these guidelines:

- [Add Items to End of Package](#) (page 26-9)
- [Reference Each Table Through a View](#) (page 26-10)

26.5.1 Add Items to End of Package

When adding items to a package, add them to the end of the package. This preserves the entry point numbers of existing top-level package items, preventing their invalidation.

For example, consider this package:

```
CREATE OR REPLACE PACKAGE pkg1 AUTHID DEFINER IS
  FUNCTION get_var RETURN VARCHAR2;
END;
/
```

Adding an item to the end of `pkg1`, as follows, does not invalidate dependents that reference the `get_var` function:

```
CREATE OR REPLACE PACKAGE pkg1 AUTHID DEFINER IS
  FUNCTION get_var RETURN VARCHAR2;
  PROCEDURE set_var (v VARCHAR2);
END;
/
```

Inserting an item between the `get_var` function and the `set_var` procedure, as follows, invalidates dependents that reference the `set_var` function:

```
CREATE OR REPLACE PACKAGE pkg1 AUTHID DEFINER IS
  FUNCTION get_var RETURN VARCHAR2;
  PROCEDURE assert_var (v VARCHAR2);
  PROCEDURE set_var (v VARCHAR2);
END;
/
```

26.5.2 Reference Each Table Through a View

Reference tables indirectly, using views, enabling you to:

- Add columns to the table without invalidating dependent views or dependent PL/SQL objects
- Modify or delete columns not referenced by the view without invalidating dependent objects

The statement `CREATE OR REPLACE VIEW` does not invalidate an existing view or its dependents if the new `ROWTYPE` matches the old `ROWTYPE`.

26.6 Object Revalidation

An object that is not valid when it is referenced must be validated before it can be used. Validation occurs automatically when an object is referenced; it does not require explicit user action.

If an object is not valid, its status is either compiled with errors, unauthorized, or invalid. For definitions of these terms, see [Table 26-1](#) (page 26-4).

Topics:

- [Revalidation of Objects that Compiled with Errors](#) (page 26-10)
- [Revalidation of Unauthorized Objects](#) (page 26-10)
- [Revalidation of Invalid SQL Objects](#) (page 26-10)
- [Revalidation of Invalid PL/SQL Objects](#) (page 26-11)

26.6.1 Revalidation of Objects that Compiled with Errors

The compiler cannot automatically revalidate an object that compiled with errors. The compiler recompiles the object, and if it recompiles without errors, it is revalidated; otherwise, it remains invalid.

26.6.2 Revalidation of Unauthorized Objects

The compiler checks whether the unauthorized object has access privileges to all of its referenced objects. If so, the compiler revalidates the unauthorized object without recompiling it. If not, the compiler issues appropriate error messages.

26.6.3 Revalidation of Invalid SQL Objects

The SQL compiler recompiles the invalid object. If the object recompiles without errors, it is revalidated; otherwise, it remains invalid.

26.6.4 Revalidation of Invalid PL/SQL Objects

For an invalid PL/SQL program unit (procedure, function, or package), the PL/SQL compiler checks whether any referenced object changed in a way that affects the invalid object. If so, the compiler recompiles the invalid object. If the object recompiles without errors, it is revalidated; otherwise, it remains invalid. If not, the compiler revalidates the invalid object without recompiling it.

26.7 Name Resolution in Schema Scope

Object names referenced in SQL statements have one or more pieces. Pieces are separated by periods—for example, `hr.employees.department_id` has three pieces.

Oracle Database uses the following procedure to try to resolve an object name.

Note:

For the procedure to succeed, all pieces of the object name must be visible in the current edition. For more information, see [Name Resolution for Editioned and Noneditioned Objects](#) (page 27-3).

1. Try to qualify the first piece of the object name.

If the object name has only one piece, then that piece is the first piece. Otherwise, the first piece is the piece to the left of the leftmost period; for example, in `hr.employees.department_id`, the first piece is `hr`.

The procedure for trying to qualify the first piece is:

- a. If the object name is a table name that appears in the `FROM` clause of a `SELECT` statement, and the object name has multiple pieces, go to step d. Otherwise, go to step b.

Search the current schema for an object whose name matches the first piece.

If found, go to step 2. Otherwise, go to step c.

- b. Search for a public synonym that matches the first piece.

If found, go to step 2. Otherwise, go to step d.

- c. Search for a schema whose name matches the first piece.

If found, and if the object name has a second piece, go to step e. Otherwise, return an error—the object name cannot be qualified.

- d. Search the schema found at step d for a table or SQL function whose name matches the second piece of the object name.

If found, go to step 2. Otherwise, return an error—the object name cannot be qualified.

Note:

A SQL function found at this step has been redefined by the schema found at step d.

2. A schema object has been qualified. Any remaining pieces of the object name must match a valid part of this schema object.

For example, if the object name is `hr.employees.department_id`, `hr` is qualified as a schema. If `employees` is qualified as a table, `department_id` must correspond to a column of that table. If `employees` is qualified as a package, `department_id` must correspond to a public constant, variable, procedure, or function of that package.

Because of how Oracle Database resolves references, an object can depend on the nonexistence of other objects. This situation occurs when the dependent object uses a reference that would be interpreted differently if another object were present.

See Also:

- *Oracle Database PL/SQL Language Reference* for information about how name resolution differs in SQL and PL/SQL
 - *Oracle Database Administrator's Guide* for information about name resolution in a distributed database system
-

26.8 Local Dependency Management

Local dependency management occurs when Oracle Database manages dependencies among the objects in a single database. For example, a statement in a procedure can reference a table in the same database.

26.9 Remote Dependency Management

Remote dependency management occurs when Oracle Database manages dependencies in distributed environments across a network. For example, an Oracle Forms trigger can depend on a schema object in the database. In a distributed database, a local view can reference a remote table.

Oracle Database also manages distributed database dependencies. For example, an Oracle Forms application might contain a trigger that references a table. The database system must account for dependencies among such objects. Oracle Database uses different mechanisms to manage remote dependencies, depending on the objects involved.

Topics:

- [Dependencies Among Local and Remote Database Procedures](#) (page 26-12)
- [Dependencies Among Other Remote Objects](#) (page 26-13)
- [Dependencies of Applications](#) (page 26-13)

26.9.1 Dependencies Among Local and Remote Database Procedures

Dependencies among stored procedures (including functions, packages, and triggers) in a distributed database system are managed using either time-stamp checking (see [Time-Stamp Dependency Mode](#) (page 26-14)) or signature checking (see [RPC-Signature Dependency Mode](#) (page 26-15)).

The dynamic initialization parameter `REMOTE_DEPENDENCIES_MODE` determines whether time stamps or signatures govern remote dependencies.

See Also:*Oracle Database PL/SQL Language Reference*

26.9.2 Dependencies Among Other Remote Objects

Oracle Database does not manage dependencies among remote schema objects other than local-procedure-to-remote-procedure dependencies.

For example, assume that a local view is created and defined by a query that references a remote table. Also assume that a local procedure includes a SQL statement that references the same remote table. Later, the definition of the table is altered.

Therefore, the local view and procedure are never invalidated, even if the view or procedure is used after the table is altered, and even if the view or procedure now returns errors when used. In this case, the view or procedure must be altered manually so that errors are not returned. In such cases, lack of dependency management is preferable to unnecessary recompilations of dependent objects.

26.9.3 Dependencies of Applications

Code in database applications can reference objects in the connected database. For example, Oracle Call Interface (OCI) and precompiler applications can submit anonymous PL/SQL blocks. Triggers in Oracle Forms applications can reference a schema object.

Such applications are dependent on the schema objects they reference. Dependency management techniques vary, depending on the development environment. Oracle Database does not automatically track application dependencies.

See Also:

Manuals for your application development tools and your operating system for more information about managing the remote dependencies within database applications

26.10 Remote Procedure Call (RPC) Dependency Management

Remote procedure call (RPC) dependency management occurs when a local stored procedure calls a remote procedure in a distributed database system. The dynamic initialization parameter `REMOTE_DEPENDENCIES_MODE` controls the dependency mode. The choice is either time-stamp dependency mode or RPC-signature dependency mode.

Topics:

- [Time-Stamp Dependency Mode](#) (page 26-14)
- [RPC-Signature Dependency Mode](#) (page 26-15)
- [Controlling Dependency Mode](#) (page 26-19)

26.10.1 Time-Stamp Dependency Mode

Whenever a procedure is compiled, its **time stamp** is recorded in the data dictionary. The time stamp shows when the procedure was created, altered, or replaced.

A compiled procedure contains information about each remote procedure that it calls, including the schema, package name, procedure name, and time stamp of the remote procedure.

In time-stamp dependency mode, when a local stored procedure calls a remote procedure, Oracle Database compares the time stamp that the local procedure has for the remote procedure to the current time stamp of the remote procedure. If the two time stamps match, both the local and remote procedures run. Neither is recompiled.

If the two time stamps do not match, the local procedure is invalidated and an error is returned to the calling environment. All other local procedures that depend on the remote procedure with the new time stamp are also invalidated.

Time stamp comparison occurs when a statement in the body of the local procedure calls the remote procedure. Therefore, statements in the local procedure that precede the invalid call might run successfully. Statements after the invalid call do not run. The local procedure must be recompiled.

If DML statements precede the invalid call, they roll back only if they and the invalid call are in the same PL/SQL block. For example, the UPDATE statement rolls back in this code:

```
BEGIN

    UPDATE table SET ...
    invalid_proc;
    COMMIT;

END;
```

But the UPDATE statement does not roll back in this code:

```
UPDATE table SET ...
EXECUTE invalid_proc;
COMMIT;
```

The disadvantages of time-stamp dependency mode are:

- Dependent objects across the network are often recompiled unnecessarily, degrading performance.
- If the client-side application uses PL/SQL, this mode can cause situations that prevent the application from running on the client side.

An example of such an application is Oracle Forms. During installation, you must recompile the client-side PL/SQL procedures that Oracle Forms uses at the client site. Also, if a client-side procedure depends on a server procedure, and if the server procedure changes or is automatically recompiled, you must recompile the client-side PL/SQL procedure. However, no PL/SQL compiler is available on the client. Therefore, the developer of the client application must distribute new versions of the application to all customers.

26.10.2 RPC-Signature Dependency Mode

Oracle Database provides **RPC signatures** to handle remote dependencies. RPC signatures do not affect local dependencies, because recompilation is always possible in the local environment.

An RPC signature is associated with each compiled stored program unit. It identifies the unit by these characteristics:

- Name
- Number of parameters
- Data type class of each parameter
- Mode of each parameter
- Data type class of return value (for a function)

An RPC signature changes only when at least one of the preceding characteristics changes.

Note:

An RPC signature does not include `DETERMINISTIC`, `PARALLEL_ENABLE`, or purity information. If these settings change for a function on remote system, optimizations based on them are not automatically reconsidered. Therefore, calling the remote function in a SQL statement or using it in a function-based index might cause incorrect query results.

A compiled program unit contains the RPC signature of each remote procedure that it calls (and the schema, package name, procedure name, and time stamp of the remote procedure).

In RPC-signature dependency mode, when a local program unit calls a subprogram in a remote program unit, the database ignores time-stamp mismatches and compares the RPC signature that the local unit has for the remote subprogram to the current RPC signature of the remote subprogram. If the RPC signatures match, the call succeeds; otherwise, the database returns an error to the local unit, and the local unit is invalidated.

For example, suppose that this procedure, `get_emp_name`, is stored on a server in Boston (`BOSTON_SERVER`):

```
CREATE OR REPLACE PROCEDURE get_emp_name (
  emp_number IN NUMBER,
  hiredate   OUT VARCHAR2,
  emp_name   OUT VARCHAR2) AUTHID DEFINER AS
BEGIN
  SELECT last_name, TO_CHAR(hire_date, 'DD-MON-YY')
  INTO emp_name, hiredate
  FROM employees
  WHERE employee_id = emp_number;
END;
/
```

When `get_emp_name` is compiled on `BOSTON_SERVER`, Oracle Database records both its RPC signature and its time stamp.

Suppose that this PL/SQL procedure, `print_name`, which calls `get_emp_name`, is on a server in California:

```
CREATE OR REPLACE PROCEDURE print_ename (emp_number IN NUMBER) AUTHID DEFINER AS
  hiredate VARCHAR2(12);
  ename     VARCHAR2(10);
BEGIN
  get_emp_name@BOSTON_SERVER(emp_number, hiredate, ename);
  dbms_output.put_line(ename);
  dbms_output.put_line(hiredate);
END;
/
```

When `print_name` is compiled on the California server, the database connects to the Boston server, sends the RPC signature of `get_emp_name` to the California server, and records the RPC signature of `get_emp_name` in the compiled state of `print_ename`.

At runtime, when `print_name` calls `get_emp_name`, the database sends the RPC signature of `get_emp_name` that was recorded in the compiled state of `print_ename` to the Boston server. If the recorded RPC signature matches the current RPC signature of `get_emp_name` on the Boston server, the call succeeds; otherwise, the database returns an error to `print_name`, which is invalidated.

Topics:

- [Changing Names and Default Values of Parameters](#) (page 26-16)
- [Changing Specification of Parameter Mode IN](#) (page 26-16)
- [Changing Subprogram Body](#) (page 26-17)
- [Changing Data Type Classes of Parameters](#) (page 26-17)
- [Changing Package Types](#) (page 26-19)

26.10.2.1 Changing Names and Default Values of Parameters

Changing the name or default value of a subprogram parameter does not change the RPC signature of the subprogram. For example, procedure `P1` has the same RPC signature in these two examples:

```
PROCEDURE P1 (Param1 IN NUMBER := 100);
PROCEDURE P1 (Param2 IN NUMBER := 200);
```

However, if your application requires that callers get the new default value, you must recompile the called procedure.

26.10.2.2 Changing Specification of Parameter Mode IN

Because the subprogram parameter mode `IN` is the default, you can specify it either implicitly or explicitly. Changing its specification from implicit to explicit, or the reverse, does not change the RPC signature of the subprogram. For example, procedure `P1` has the same RPC signature in these two examples:

```
PROCEDURE P1 (Param1 NUMBER);      -- implicit specification
PROCEDURE P1 (Param1 IN NUMBER);   -- explicit specification
```

26.10.2.3 Changing Subprogram Body

Changing the body of a subprogram does not change the RPC signature of the subprogram.

[Example 26-4](#) (page 26-17) changes only the body of the procedure `get_hire_date`; therefore, it does not change the RPC signature of `get_hire_date`.

Example 26-4 Changing Body of Procedure `get_hire_date`

```
CREATE OR REPLACE PROCEDURE get_hire_date (
  emp_number IN NUMBER,
  hiredate   OUT VARCHAR2,
  emp_name   OUT VARCHAR2) AUTHID DEFINER AS
BEGIN
  SELECT last_name, TO_CHAR(hire_date, 'DD-MON-YY')
  INTO emp_name, hiredate
  FROM employees
  WHERE employee_id = emp_number;
END;
/

CREATE OR REPLACE PROCEDURE get_hire_date (
  emp_number IN NUMBER,
  hiredate   OUT VARCHAR2,
  emp_name   OUT VARCHAR2) AUTHID DEFINER AS
BEGIN
  -- Change date format model
  SELECT last_name, TO_CHAR(hire_date, 'DD/MON/YYYY')
  INTO emp_name, hiredate
  FROM employees
  WHERE employee_id = emp_number;
END;
/
```

26.10.2.4 Changing Data Type Classes of Parameters

Changing the data type of a parameter to another data type in the same class does not change the RPC signature, but changing the data type to a data type in another class does.

[Table 26-3](#) (page 26-17) lists the data type classes and the data types that comprise them. Data types not listed in [Table 26-3](#) (page 26-17), such as `NCHAR`, do not belong to a data type class. Changing their type always changes the RPC signature.

Table 26-3 Data Type Classes

Data Type Class	Data Types in Class
Character	CHAR CHARACTER
VARCHAR	VARCHAR VARCHAR2 STRING LONG ROWID

Table 26-3 (Cont.) Data Type Classes

Data Type Class	Data Types in Class
Raw	RAW LONG RAW
Integer	BINARY_INTEGER PLS_INTEGER SIMPLE_INTEGER BOOLEAN NATURAL NATURALN POSITIVE POSITIVEN
Number	NUMBER INT INTEGER SMALLINT DEC DECIMAL REAL FLOAT NUMERIC DOUBLE PRECISION
Datetime	DATE TIMESTAMP TIMESTAMP WITH TIME ZONE TIMESTAMP WITH LOCAL TIME ZONE INTERVAL YEAR TO MONTH INTERVAL DAY TO SECOND

[Example 26-5](#) (page 26-18) changes the data type of the parameter hiredate from VARCHAR2 to DATE. VARCHAR2 and DATE are not in the same data type class, so the RPC signature of the procedure get_hire_date changes.

Example 26-5 Changing Data Type Class of get_hire_date Parameter

```
CREATE OR REPLACE PROCEDURE get_hire_date (
  emp_number IN NUMBER,
  hiredate   OUT DATE,
  emp_name   OUT VARCHAR2) AS
BEGIN
  SELECT last_name, TO_CHAR(hire_date, 'DD/MON/YYYY')
  INTO emp_name, hiredate
  FROM employees
  WHERE employee_id = emp_number;
END;
/
```

26.10.2.5 Changing Package Types

Changing the name of a package type, or the names of its internal components, does not change the RPC signature of the package.

[Example 26-6](#) (page 26-19) defines a record type, `emp_data_type`, inside the package `emp_package`. Next, it changes the names of the record fields, but not their types. Finally, it changes the name of the type, but not its characteristics. The RPC signature of the package does not change.

Example 26-6 Changing Names of Fields in Package Record Type

```
CREATE OR REPLACE PACKAGE emp_package AUTHID DEFINER AS
  TYPE emp_data_type IS RECORD (
    emp_number NUMBER,
    hiredate   VARCHAR2(12),
    emp_name   VARCHAR2(10)
  );
  PROCEDURE get_emp_data (
    emp_data IN OUT emp_data_type
  );
END;
/

CREATE OR REPLACE PACKAGE emp_package AUTHID DEFINER AS
  TYPE emp_data_type IS RECORD (
    emp_num   NUMBER,
    hire_dat  VARCHAR2(12),
    empname   VARCHAR2(10)
  );
  PROCEDURE get_emp_data (
    emp_data IN OUT emp_data_type
  );
END;
/

CREATE OR REPLACE PACKAGE emp_package AUTHID DEFINER AS
  TYPE emp_data_record_type IS RECORD (
    emp_num   NUMBER,
    hire_dat  VARCHAR2(12),
    empname   VARCHAR2(10)
  );
  PROCEDURE get_emp_data (
    emp_data IN OUT emp_data_record_type
  );
END;
/
```

26.10.3 Controlling Dependency Mode

The dynamic initialization parameter `REMOTE_DEPENDENCIES_MODE` controls the dependency mode. If the initialization parameter file contains this specification, then only time stamps are used to resolve dependencies (if this is not explicitly overridden dynamically):

```
REMOTE_DEPENDENCIES_MODE = TIMESTAMP
```

If the initialization parameter file contains this parameter specification, then RPC signatures are used to resolve dependencies (if this not explicitly overridden dynamically):

```
REMOTE_DEPENDENCIES_MODE = SIGNATURE
```

You can alter the mode dynamically by using the DDL statements. For example, this example alters the dependency mode for the current session:

```
ALTER SESSION SET REMOTE_DEPENDENCIES_MODE = {SIGNATURE | TIMESTAMP}
```

This example alters the dependency mode systemwide after startup:

```
ALTER SYSTEM SET REMOTE_DEPENDENCIES_MODE = {SIGNATURE | TIMESTAMP}
```

If the `REMOTE_DEPENDENCIES_MODE` parameter is not specified, either in the `init.ora` parameter file or using the `ALTER SESSION` or `ALTER SYSTEM` statements, `TIMESTAMP` is the default value. Therefore, unless you explicitly use the `REMOTE_DEPENDENCIES_MODE` parameter, or the appropriate DDL statement, your server is operating using the time-stamp dependency mode.

When you use `REMOTE_DEPENDENCIES_MODE=SIGNATURE`:

- If you change the initial value of a parameter of a remote procedure, then the local procedure calling the remote procedure is not invalidated. If the call to the remote procedure does not supply the parameter, then the initial value is used. In this case, because invalidation and recompilation does not automatically occur, the old initial value is used. To see the new initial values, recompile the calling procedure manually.
- If you add an overloaded procedure in a package (a procedure with the same name as an existing one), then local procedures that call the remote procedure are not invalidated. If it turns out that this overloading results in a rebinding of existing calls from the local procedure under the time-stamp mode, then this rebinding does not happen under the RPC signature mode, because the local procedure does not get invalidated. You must recompile the local procedure manually to achieve the rebinding.
- If the types of parameters of an existing package procedure are changed so that the new types have the same shape as the old ones, then the local calling procedure is not invalidated or recompiled automatically. You must recompile the calling procedure manually to get the semantics of the new type.

Topics:

- [Dependency Resolution](#) (page 26-20)
- [Suggestions for Managing Dependencies](#) (page 26-21)

26.10.3.1 Dependency Resolution

When `REMOTE_DEPENDENCIES_MODE = TIMESTAMP` (the default value), dependencies among program units are handled by comparing time stamps at runtime. If the time stamp of a called remote procedure does not match the time stamp of the called procedure, then the calling (dependent) unit is invalidated and must be recompiled. In this case, if there is no local PL/SQL compiler, then the calling application cannot proceed.

In the time-stamp dependency mode, RPC signatures are not compared. If there is a local PL/SQL compiler, then recompilation happens automatically when the calling procedure is run.

When `REMOTE_DEPENDENCIES_MODE = SIGNATURE`, the recorded time stamp in the calling unit is first compared to the current time stamp in the called remote unit. If they match, then the call proceeds. If the time stamps do not match, then the RPC signature of the called remote subprogram, as recorded in the calling subprogram, is compared with the current RPC signature of the called subprogram. If they do not match (using the criteria described in [Changing Data Type Classes of Parameters](#) (page 26-17)), then an error is returned to the calling session.

26.10.3.2 Suggestions for Managing Dependencies

Follow these guidelines for setting the `REMOTE_DEPENDENCIES_MODE` parameter:

- Server-side PL/SQL users can set the parameter to `TIMESTAMP` (or let it default to that) to get the time-stamp dependency mode.
- Server-side PL/SQL users can use RPC-signature dependency mode if they have a distributed system and they want to avoid possible unnecessary recompilations.
- Client-side PL/SQL users must set the parameter to `SIGNATURE`. This allows:
 - Installation of applications at client sites without recompiling procedures.
 - Ability to upgrade the server, without encountering time stamp mismatches.
- When using RPC signature mode on the server side, add procedures to the end of the procedure (or function) declarations in a package specification. Adding a procedure in the middle of the list of declarations can cause unnecessary invalidation and recompilation of dependent procedures.

26.11 Shared SQL Dependency Management

In addition to managing dependencies among schema objects, Oracle Database also manages dependencies of each shared SQL area in the shared pool. If a table, view, synonym, or sequence is created, altered, or dropped, or a procedure or package specification is recompiled, all dependent shared SQL areas are invalidated. At a subsequent execution of the cursor that corresponds to an invalidated shared SQL area, Oracle Database reparses the SQL statement to regenerate the shared SQL area.

Using Edition-Based Redefinition

Edition-based redefinition (EBR) lets you upgrade the database component of an application while it is in use, thereby minimizing or eliminating downtime.

Topics:

- [Overview of Edition-Based Redefinition](#) (page 27-1)
- [Editions](#) (page 27-2)
- [Editioning Views](#) (page 27-22)
- [Crossedition Triggers](#) (page 27-25)
- [Displaying Information About EBR Features](#) (page 27-36)
- [Using EBR to Upgrade an Application](#) (page 27-38)

27.1 Overview of Edition-Based Redefinition

To upgrade an application while it is in use, you must copy the database objects that comprise the database component of the application and redefine the copied objects in isolation. Your changes do not affect users of the application—they can continue to run the unchanged application. When you are sure that your changes are correct, you make the upgraded application available to all users.

Using EBR means using one or more of its component features. The features you use, and the downtime, depend on these factors:

- What kind of database objects you redefine
- How available the database objects must be to users while you are redefining them
- Whether you make the upgraded application available to some users while others continue to use the older version of the application

You always use the **edition** feature to copy the database objects and redefine the copied objects in isolation; that is why the procedure that this chapter describes for upgrading applications online is called edition-based redefinition (EBR).

If every object that you will redefine is **editioned** (defined in [Editioned and Noneditioned Objects](#) (page 27-2)), then the edition is the only feature you use.

Tables are not editioned objects. If you change the structure of one or more tables, then you also use the **editioning view** feature.

If other users must be able to change data in the tables while you are changing their structure, then you also use **forward crossedition triggers**. If the pre- and post-upgrade applications will be in ordinary use at the same time (**hot rollover**), then you

also use **reverse crossedition triggers**. Crossedition triggers are not a permanent part of the application—you drop them when all users are using the post-upgrade application.

An EBR operation that you can perform on an application in one edition while the application runs in other editions is a **live operation**.

27.2 Editions

Editions are nonschema objects; as such, they do not have owners. Editions are created in a single namespace, and multiple editions can coexist in the database.

The database must have at least one edition. Every newly created or upgraded Oracle Database starts with one edition named `ora$base`.

Note:

In a multitenant container database (CDB), the scope of an edition, editioning view, or crossedition trigger is the pluggable database (PDB) in which the feature was created. In a non-CDB, the scope of each of these features is the entire database. For information about CDBs and PDBs, see *Oracle Database Administrator's Guide*.

Topics:

- [Editioned and Noneditioned Objects](#) (page 27-2)
- [Creating an Edition](#) (page 27-10)
- [Editioned Objects and Copy-on-Change](#) (page 27-11)
- [Making an Edition Available to Some Users](#) (page 27-15)
- [Making an Edition Available to All Users](#) (page 27-15)
- [Current Edition and Session Edition](#) (page 27-16)
- [Retiring an Edition](#) (page 27-20)
- [Dropping an Edition](#) (page 27-20)

27.2.1 Editioned and Noneditioned Objects

Note:

The terms **user** and **schema** are synonymous. The **owner** of a schema object is the user/schema that owns it.

An **editioned object** has both a schema object type that is editionable in its owner and the `EDITIONABLE` property. An edition has its own copy of an editioned object, and only that copy is visible to the edition.

A **noneditioned object** has either a schema object type that is noneditionable in its owner or the `NONEDITIONABLE` property. An edition cannot have its own copy of a noneditioned object. A noneditioned object is visible to all editions.

An object is **potentially editioned** if enabling editions for its type in its owner would make it an editioned object (for details, see [Enabling Editions for a User](#) (page 27-6)).

An editioned object belongs to both a schema and an edition, and is uniquely identified by its `OBJECT_NAME`, `OWNER`, and `EDITION_NAME`. A noneditioned object belongs only to a schema, and is uniquely identified by its `OBJECT_NAME` and `OWNER`—its `EDITION_NAME` is `NULL`. (Strictly speaking, the `NAMESPACE` of an object is also required to uniquely identify the object, but you can ignore this fact, because any statement that references the object implicitly or explicitly specifies its `NAMESPACE`.)

You can display the `OBJECT_NAME`, `OWNER`, and `EDITION_NAME` of an object with the static data dictionary views `*_OBJECTS` and `*_OBJECTS_AE`.

You need not know the `EDITION_NAME` of an object to refer to that object (and if you do know it, you cannot specify it). The context of the reference implicitly specifies the edition. If the context is a data definition language (DDL) statement, then the edition is the current edition of the session that issued the command (for information about the current edition, see [Current Edition and Session Edition](#) (page 27-16)). If the context is source code, then the edition is the one in which the object is actual (see [Editioned Objects and Copy-on-Change](#) (page 27-11)).

Topics:

- [Name Resolution for Editioned and Noneditioned Objects](#) (page 27-3)
- [Noneditioned Objects That Can Depend on Editioned Objects](#) (page 27-4)
- [Editionable and Noneditionable Schema Object Types](#) (page 27-5)
- [Enabling Editions for a User](#) (page 27-6)
- [EDITIONABLE and NONEDITIONABLE Properties](#) (page 27-8)
- [Rules for Editioned Objects](#) (page 27-10)

27.2.1.1 Name Resolution for Editioned and Noneditioned Objects

To try to resolve an object name, Oracle Database uses the procedure described in [Name Resolution in Schema Scope](#) (page 26-11). For the procedure to succeed, all pieces of the object name must be visible in the current edition.

During name resolution for an editioned object, both editioned objects in the current edition and noneditioned objects are visible.

During name resolution for a noneditioned object, only noneditioned objects are visible. Therefore, if you try to create a noneditioned object that references an editioned object (except in the cases described in [Noneditioned Objects That Can Depend on Editioned Objects](#) (page 27-4)), the creation fails with an error.

When you change a referenced editioned object, all of its dependents (direct and indirect) become invalid. When an invalid object is referenced, the database tries to validate that object.

See Also:

- [Current Edition and Session Edition](#) (page 27-16)
- [Understanding Schema Object Dependency](#) (page 26-1), for general information about dependencies among schema objects, including invalidation, revalidation, and name resolution

27.2.1.2 Noneditioned Objects That Can Depend on Editioned Objects

Ordinarily, a noneditioned object cannot depend on an editioned object, because the editioned object is invisible during name resolution. However, if a noneditioned object specifies an edition to search for editioned objects during name resolution—an **evaluation edition**—then it *can* depend on editioned objects. To specify an evaluation edition, a noneditioned object must be one of the following:

- Materialized view
- Virtual column

Topics:

- [Materialized Views](#) (page 27-4)
- [Virtual Columns](#) (page 27-5)

27.2.1.2.1 Materialized Views

A materialized view is a noneditioned object that can specify an evaluation edition, thereby enabling it to depend on editioned objects. A materialized view that depends on editioned objects may be eligible for query rewrite only in a specific range of editions, which you specify in the *query_rewrite_clause*.

The simplified syntax for creating a materialized view is:

```
CREATE MATERIALIZED VIEW [ schema.] materialized_view other_clauses
[ evaluation_edition_clause ] [ query_rewrite_clause ] AS subquery
```

Where *evaluation_edition_clause* is:

```
EVALUATE USING { CURRENT EDITION | EDITION edition | NULL EDITION }
```

And *query_rewrite_clause* is:

```
{ DISABLE | ENABLE } QUERY REWRITE
[ unusable_before_clause ] [ unusable_beginning_clause ]
```

Where *unusable_before_clause* is:

```
UNUSABLE BEFORE { CURRENT EDITION | EDITION edition }
```

And *unusable_beginning_clause* is:

```
UNUSABLE BEGINNING WITH { CURRENT EDITION | EDITION edition | NULL EDITION }
```

CURRENT EDITION is the edition in which the DDL statement runs. Specifying NULL EDITION is equivalent to omitting the clause that includes it. If you omit *evaluation_edition_clause*, then editioned objects are invisible during name resolution.

For the complete syntax and semantics of the `CREATE MATERIALIZED VIEW` statement, see *Oracle Database SQL Language Reference*.

To disable, enable, or change the evaluation edition or unusable editions, use the `ALTER MATERIALIZED VIEW` statement, described in *Oracle Database SQL Language Reference*.

To display the evaluation editions and unusable editions of materialized views, use the static data dictionary views `*_MVIEWS` (described in *Oracle Database Reference*).

Dropping the evaluation edition invalidates the materialized view. Dropping an edition where the materialized view is usable does not invalidate the materialized view.

27.2.1.2.2 Virtual Columns

A virtual column (also called a "generated column") does not consume disk space. The database generates the values in a virtual column on demand by evaluating an expression. The expression can invoke PL/SQL functions (which can be editioned objects). A virtual column can specify an evaluation edition, thereby enabling it to depend on an expression that invokes editioned PL/SQL functions.

The syntax for creating a virtual column is:

```
column [ datatype ] [ GENERATED ALWAYS ] AS ( column_expression )
[ VIRTUAL ] [ evaluation_edition_clause ]
[ unusable_before_clause ] [ unusable_beginning_clause ]
[ inline_constraint ]...
```

Where *evaluation_edition_clause* is as described in [Materialized Views](#) (page 27-4).

The database does not maintain dependencies on the functions that a virtual column invokes. Therefore, if you drop the evaluation edition, or if a virtual column depends on a noneditioned function and the function becomes editioned, then any of the following can raise an exception:

- Trying to query the virtual column
- Trying to update a row that includes the virtual column
- A trigger that tries to access the virtual column

For the complete syntax and semantics of the virtual column definition, see *Oracle Database SQL Language Reference*.

To display the evaluation editions of virtual columns, use the static data dictionary views `*_TAB_COLS` (described in *Oracle Database Reference*).

27.2.1.3 Editionable and Noneditionable Schema Object Types

Before a schema object type can be editionable in a schema, it must be editionable in the database. The schema object types that are editionable in the database are determined by the value of the `COMPATIBLE` initialization parameter (described in *Oracle Database Administrator's Guide*) and are shown by the dynamic performance view `V$EDITIONABLE_TYPES` (described in *Oracle Database Reference*).

If the value of `COMPATIBLE` is 12 or greater, then these schema object types are editionable in the database:

- `SYNONYM`

- VIEW
- SQL translation profile
- All PL/SQL object types:
 - FUNCTION
 - LIBRARY
 - PACKAGE and PACKAGE BODY
 - PROCEDURE
 - TRIGGER
 - TYPE and TYPE BODY

All other schema object types are noneditionable in the database and in every schema, and objects of that type are always noneditioned. TABLE is an example of a noneditionable schema object type. Tables are always noneditioned objects.

If a schema object type is editionable in the database, then it can be editionable in schemas. For details, see [Enabling Editions for a User](#) (page 27-6).

27.2.1.4 Enabling Editions for a User

Note:

- Enabling editions is not a live operation.
 - When a database is upgraded from Release 11.2 to Release 12.1, users who were enabled for editions in the pre-upgrade database are enabled for editions in the post-upgrade database and the default schema object types are editionable in their schemas. The default schema object types are displayed by the static data dictionary view DBA_EDITIONED_TYPES (described in *Oracle Database Reference*). Users who were not enabled for editions in the pre-upgrade database are not enabled for editions in the post-upgrade database and no schema object types are editionable in their schemas.
 - To see which users already have editions enabled, see the EDITIONS_ENABLED column of the static data dictionary view DBA_USERS (described in *Oracle Database Reference*) or USER_USERS (described in *Oracle Database Reference*).
-
-

To enable editions for a user, use the ENABLE EDITIONS clause of either the CREATE USER or ALTER USER statement.

With the ALTER USER statement, you can specify the schema object types that become editionable in the schema:

```
ALTER USER user ENABLE EDITIONS [ FOR type [, type ]... ]
```

Any type that you omit from the FOR list is noneditionable in the schema, despite being editionable in the database. (If a type is noneditionable in the database, then it is always noneditionable in every schema.)

If you omit the `FOR` list from the `ALTER USER` statement, or use the `CREATE USER` statement to enable editions for a user, then the types that become editionable in the schema are those shown for that schema by the static data dictionary view `DBA_EDITIONED_TYPES` (described in *Oracle Database Reference*).

See Also:

Oracle Database SQL Language Reference for the complete syntax and semantics of the `CREATE USER` and `ALTER USER` statements

Enabling editions is retroactive and irreversible. When you enable editions for a user, that user is editions-enabled forever. When you enable editions for a schema object type in a schema, that type is editions-enabled forever in that schema. Every object that an editions-enabled user owns or will own becomes an editioned object if its type is editionable in the schema and it has the `EDITIONABLE` property. For information about the `EDITIONABLE` property, see [EDITIONABLE and NONEDITIONABLE Properties](#) (page 27-8).

Topics:

- [Potentially Editioned Objects with Noneditioned Dependents](#) (page 27-7)
- [Users Who Cannot Have Editions Enabled](#) (page 27-8)

27.2.1.4.1 Potentially Editioned Objects with Noneditioned Dependents

If a potentially editioned object has a noneditioned dependent, then you can enable editions for the owner of the potentially editioned object only if one of the following is true:

- Enabling editions for the owner of the potentially editioned object would cause the noneditioned dependent to become editioned.
- You specify `FORCE`:

```
ALTER USER user ENABLE EDITIONS [ FOR type [, type ]... ] FORCE;
```

The preceding statement enables editions for the specified user and invalidates noneditioned dependents of editioned objects. For information about invalidation of dependent objects, see [Invalidation of Dependent Objects](#) (page 26-5).

Note:

If the preceding statement invalidates a noneditioned dependent object that contains an Abstract Data Type (ADT), and you drop the edition that contains the editioned object on which the invalidated object depends, then you cannot recompile the invalidated object. Therefore, the object remains invalid.

`FORCE` is useful in the following situation: You must editions-enable users A and B. User A owns potentially editioned objects a1 and a2. User B owns potentially editioned objects b1 and b2. Object a1 depends on object b1. Object b2 depends on object a2. Editions-enable users A and B like this:

1. Using `FORCE`, enable editions for user A:

```
ALTER USER A ENABLE EDITIONS FORCE;
```

Now a1 and a2 are editioned objects, and noneditioned object b2 (which depends on a2) is invalid.

2. Enable editions for user B:

```
ALTER USER B ENABLE EDITIONS;
```

Now b1 and b2 are editioned objects; however, b2 is still invalid.

3. Recompile b2, using the appropriate ALTER statement with COMPILER. For a PL/SQL object, also specify REUSE SETTINGS.

For example, if b2 is a procedure, use this statement:

```
ALTER PROCEDURE b2 COMPILER REUSE SETTINGS
```

For information about the ALTER statements for PL/SQL objects, see *Oracle Database PL/SQL Language Reference*.

For information about the ALTER statements for SQL objects, see *Oracle Database SQL Language Reference*.

FORCE is unnecessary in the following situation: You must editions-enable user C, who owns potentially editioned object c1. Object c1 has dependent d1, a potentially editioned object owned by user D. User D owns no potentially editioned objects that have dependents owned by C. If you editions-enable D first, making d1 an editioned object, then you can editions-enable C without violating the rule that a noneditioned object cannot depend on an editioned object.

27.2.1.4.2 Users Who Cannot Have Editions Enabled

You cannot enable editions for these users:

- Oracle-maintained users

For an Oracle-maintained user, the value of the column ORACLE_MAINTAINED is Y in the *_USERS views.

- Common users in a CDB

For information about common users in a CDB, see *Oracle Database Administrator's Guide*.

- A user who owns one or more evolved ADTs.

Trying to do so causes error ORA-38820. If an ADT has no table dependents, you can use the ALTER TYPE RESET statement to reset its version to 1, so that it is no longer considered to be evolved. (Resetting the version of an ADT to 1 invalidates its dependents.) For the syntax of the ALTER TYPE RESET statement, see *Oracle Database PL/SQL Language Reference*.

27.2.1.5 EDITIONABLE and NONEDITIONABLE Properties

Note:

When a database is upgraded from Release 11.2 to Release 12.1, objects in user-created schemas get the EDITIONABLE property and public synonyms get the NONEDITIONABLE property.

The CREATE and ALTER statements for the schema object types that are editionable in the database let you specify that the object you are creating or altering is EDITIONABLE or NONEDITIONABLE.

The DBMS_SQL_TRANSLATOR.CREATE_PROFILE procedure lets you specify that the SQL translation profile that you are creating is EDITIONABLE or NONEDITIONABLE.

To see which objects are EDITIONABLE, see the EDITIONABLE column of the static data dictionary view *_OBJECTS (described in *Oracle Database Reference*) or *_OBJECTS_AE (described in *Oracle Database Reference*).

Topics:

- [Creating New EDITIONABLE and NONEDITIONABLE Objects](#) (page 27-9)
- [Replacing or Altering EDITIONABLE and NONEDITIONABLE Objects](#) (page 27-10)

See Also:

- *Oracle Database PL/SQL Language Reference* for the syntax and semantics of the CREATE and ALTER statements for PL/SQL schema objects
 - *Oracle Database SQL Language Reference* for the syntax and semantics of the CREATE and ALTER statements for SQL schema objects
 - *Oracle Database PL/SQL Packages and Types Reference* for information about the DBMS_SQL_TRANSLATOR.CREATE_PROFILE procedure
-
-

27.2.1.5.1 Creating New EDITIONABLE and NONEDITIONABLE Objects

When you create a new schema object whose type is editionable in the database, you can specify the property EDITIONABLE or NONEDITIONABLE. If you omit the property, then the object is EDITIONABLE by default unless it is one of the following:

- PUBLIC SYNONYM, which is NONEDITIONABLE by default
- PACKAGE BODY, which inherits the property of the package specification
- TYPE BODY, which inherits the property of the type specification

For PACKAGE BODY or TYPE BODY, if you specify a property, then it must match the property of the corresponding package or type specification.

When you create an EDITIONABLE object of a type that is editionable in its schema, the new object is an editioned object that is visible only in the edition that is current when the object is created. (For information about the current edition, see [Current Edition and Session Edition](#) (page 27-16).) Creating an editioned object is a live operation with respect to the editions in which the new object is invisible.

When you create either an object with the NONEDITIONABLE property or an object whose type is noneditionable in its schema, the new object is a noneditioned object, which is visible to all editions.

Suppose that in the current edition, your schema has no schema object named obj, but in another edition, your schema has an editioned object named obj. You can create an object named obj in your schema in the current edition, but it must be an editioned object (that is, uniquely identified by its OBJECT_NAME, OWNER, and EDITION_NAME). The type of the new object (which can be different from the type of the existing

editioned object with the same name) must be editionable in your schema and the new object must have the `EDITIONABLE` property. See [Example: Dropping an Editioned Object](#) (page 27-13) and [Example: Creating an Object with the Name of a Dropped Inherited Object](#) (page 27-14).

27.2.1.5.2 Replacing or Altering `EDITIONABLE` and `NONEDITIONABLE` Objects

When you replace or alter an existing object (with the `CREATE OR REPLACE` or `ALTER` statement):

- If the schema is not enabled for editions, then you can change the property of the object from `EDITIONABLE` to `NONEDITIONABLE`, or the reverse.
- If the schema is enabled for editions for the type of the object being replaced or altered, then you cannot change the property of the object from `EDITIONABLE` to `NONEDITIONABLE`, or the reverse.

Altering an editioned object is a live operation with respect to the editions in which the altered object is invisible.

27.2.1.6 Rules for Editioned Objects

- A noneditioned object usually cannot depend on an editioned object (for more information, see [Name Resolution for Editioned and Noneditioned Objects](#) (page 27-3)).
- An Abstract Data Type (ADT) cannot be both editioned and evolved.
For information about type evolution, see *Oracle Database Object-Relational Developer's Guide*.
- An editioned object cannot be the starting or ending point of a `FOREIGN KEY` constraint.

This rule affects only editioned views. An editioned view can be either an ordinary view or an editioning view.

27.2.2 Creating an Edition

Note:

Oracle recommends against creating editions in the Root of a CDB. For information about CDBs, see *Oracle Database Administrator's Guide*.

To create an edition, use the SQL statement `CREATE EDITION`.

You must create the edition as the child of an existing edition. The parent of the first edition created with a `CREATE EDITION` statement is `ora$base`. This statement creates the edition `e2` as the child of `ora$base`:

```
CREATE EDITION e2
```

([Example: Editioned Objects and Copy-on-Change](#) (page 27-11) and others use the preceding statement.)

An edition can have at most one child.

The **descendents** of an edition are its child, its child's child, and so on. The **ancestors** of an edition are its parent, its parent's parent, and so on. The **root edition** has no parent, and a **leaf edition** has no child.

See Also:

Oracle Database SQL Language Reference for information about the CREATE EDITION statement, including the privileges required to use it

27.2.3 Editioned Objects and Copy-on-Change

When you create an edition, all editioned objects in its parent edition are copied to it. Changes to an editioned object in one edition do not affect copies of that editioned object in other editions.

The preceding paragraph describes what happens conceptually. In practice, to optimize performance, Oracle Database copies an editioned object from an ancestor edition to a descendent edition only when the descendent edition changes the object. This strategy is called **copy-on-change**.

An editioned object that was conceptually (but not actually) copied to a descendent edition is called an **inherited object**. When a user of the descendent edition references an inherited object in a DDL statement, Oracle Database actually copies the object to the descendent edition. This copying operation is called **actualization**, and it creates an **actual object** in the descendent edition.

Note:

There is one exception to the actualization rule in the preceding paragraph: When a CREATE OR REPLACE *object* statement replaces an inherited object with an identical object (that is, an object with the same source code and settings), Oracle Database *does not* create an actual object in the descendent edition.

27.2.3.1 Example: Editioned Objects and Copy-on-Change

[Example 27-1](#) (page 27-11) creates a procedure named `hello` in the edition `ora$base`, and then creates the edition `e2` as a child of `ora$base`. When `e2` invokes `hello`, it invokes the inherited procedure in `ora$base`. Then `e2` changes `hello`, actualizing it. Now when `e2` invokes `hello`, it invokes its own actual procedure. The procedure `hello` in the edition `ora$base` remains unchanged.

Example 27-1 *Editioned Objects and Copy-on-Change*

1. Assume that this procedure is an editioned object in `ora$base`:

```
CREATE OR REPLACE PROCEDURE hello IS
BEGIN
    DBMS_OUTPUT.PUT_LINE('Hello, edition 1.');
```

END hello;

/

2. In `ora$base`, invoke the procedure:

```
BEGIN hello(); END;
```

/

Result:

Hello, edition 1.

PL/SQL procedure successfully completed.

3. Create a child edition:

```
CREATE EDITION e2;
```

Conceptually, the procedure is copied to the child edition, and only the copy is visible in the child edition. The copy is an inherited object, not an actual object.

4. Use the child edition:

```
ALTER SESSION SET EDITION = e2;
```

For information about ALTER SESSION SET EDITION, see [Changing Your Session Edition](#) (page 27-17).

5. Invoke the procedure:

```
BEGIN hello(); END;  
/
```

Conceptually, the child edition invokes its own copy of the procedure (which is identical to the procedure in the parent edition, ora\$base). However, the child edition actually invokes the procedure in the parent edition. Result:

Hello, edition 1.

PL/SQL procedure successfully completed.

6. Change the procedure:

```
CREATE OR REPLACE PROCEDURE hello IS  
  BEGIN  
    DBMS_OUTPUT.PUT_LINE('Hello, edition 2.');
```

```
  END hello;  
/
```

Oracle Database actualizes the procedure in the child edition, and the change affects only the actual object in the child edition, not the procedure in the parent edition.

7. Invoke the procedure:

```
BEGIN hello(); END;  
/
```

The child edition invokes its own actual procedure:

Hello, edition 2.

PL/SQL procedure successfully completed.

8. Return to the parent edition:

```
ALTER SESSION SET EDITION = ora$base;
```

9. Invoke the procedure and see that it has not changed:

```
BEGIN hello(); END;
/
```

Result:

Hello, edition 1.

PL/SQL procedure successfully completed.

27.2.3.2 Example: Dropping an Editioned Object

[Example 27-2](#) (page 27-13) creates a procedure named `goodbye` in the edition `ora$base`, and then creates edition `e2` as a child of `ora$base`. After `e2` drops `goodbye`, it can no longer invoke it, but `ora$base` can still invoke it. (For more information about the `DROP PROCEDURE` statement, including the privileges required to use it, see *Oracle Database PL/SQL Language Reference*.)

Because `e2` dropped the procedure `goodbye`:

- Its descendents do not inherit the procedure `goodbye`.
- No object named `goodbye` is visible in `e2`, so `e2` can create an object named `goodbye`, but it must be an editioned object (for details, see [Creating New EDITIONABLE and NONEDITIONABLE Objects](#) (page 27-9)). If `e2` creates a new editioned object named `goodbye`, then the descendents of `e2` inherit that object.

Example 27-2 Dropping an Editioned Object

1. Assume that this procedure is an editioned object in `ora$base`:

```
CREATE OR REPLACE PROCEDURE goodbye IS
  BEGIN
    DBMS_OUTPUT.PUT_LINE('Good-bye! ');
  END goodbye;
/
```

2. Invoke the procedure:

```
BEGIN goodbye; END;
/
```

Result:

Good-bye!

PL/SQL procedure successfully completed.

3. Create edition `e2` as a child of `ora$base`:

```
CREATE EDITION e2;
```

In `e2`, the procedure is an inherited object.

4. Use edition `e2`:

```
ALTER SESSION SET EDITION = e2;
```

`ALTER SESSION SET EDITION` must be a top-level SQL statement. For more information, see [Changing Your Session Edition](#) (page 27-17).

5. In `e2`, invoke the procedure:

```
BEGIN goodbye; END;  
/
```

e2 invokes the procedure in ora\$base:

```
Good-bye!
```

```
PL/SQL procedure successfully completed.
```

6. In e2, drop the procedure:

```
DROP PROCEDURE goodbye;
```

7. In e2, try to invoke the dropped procedure:

```
BEGIN goodbye; END;  
/
```

Result:

```
BEGIN goodbye; END;  
*  
ERROR at line 1:  
ORA-06550: line 1, column 7:  
PLS-00201: identifier 'GOODBYE' must be declared  
ORA-06550: line 1, column 7:  
PL/SQL: Statement ignored
```

8. Return to ora\$base:

```
ALTER SESSION SET EDITION = ora$base;
```

9. In ora\$base, invoke the procedure:

```
BEGIN goodbye; END;  
/
```

Result:

```
Good-bye!
```

```
PL/SQL procedure successfully completed.
```

27.2.3.3 Example: Creating an Object with the Name of a Dropped Inherited Object

In [Example 27-3](#) (page 27-14), e2 creates a function named `goodbye` and then an edition named e3 as a child of e2. When e3 tries to invoke the *procedure* `goodbye` (which e2 dropped), an error occurs, but e3 successfully invokes the *function* `goodbye` (which e2 created).

Example 27-3 *Creating an Object with the Name of a Dropped Inherited Object*

1. Return to e2:

```
ALTER SESSION SET EDITION = e2;
```

For information about ALTER SESSION SET EDITION, see [Changing Your Session Edition](#) (page 27-17).

2. In e2, create a function named `goodbye`:

```
CREATE OR REPLACE FUNCTION goodbye  
RETURN BOOLEAN  
IS
```

```
BEGIN
  RETURN(TRUE);
END goodbye;
/
```

This function must be an editioned object. It has the `EDITIONABLE` property by default. If the type `FUNCTION` is not editionable in the schema, then you must use the `ALTER USER` statement to make it so (for instructions, see [Enabling Editions for a User](#) (page 27-6)).

3. Create edition e3:

```
CREATE EDITION e3 AS CHILD OF e2;
```

Edition e3 inherits the function `goodbye`.

4. Use edition e3:

```
ALTER SESSION SET EDITION = e3;
```

5. In e3, try to invoke the *procedure* `goodbye`:

```
BEGIN
  goodbye;
END;
/
```

Result:

```
ERROR at line 2:
ORA-06550: line 2, column 3:
PLS-00306: wrong number or types of arguments in call to 'GOODBYE'
ORA-06550: line 2, column 3:
PL/SQL: Statement ignored
```

6. In e3, invoke *function* `goodbye`:

```
BEGIN
  IF goodbye THEN
    DBMS_OUTPUT.PUT_LINE('Good-bye!');
  END IF;
END;
/
```

Result:

```
Good-bye!
```

```
PL/SQL procedure successfully completed.
```

27.2.4 Making an Edition Available to Some Users

As the creator of the edition, you automatically have the `USE` privilege `WITH GRANT OPTION` on it. To grant the `USE` privilege on the edition to other users, use the SQL statement `GRANT USE ON EDITION`. For information about the `GRANT` statement, see *Oracle Database SQL Language Reference*.

27.2.5 Making an Edition Available to All Users

To make an edition available to all users, either:

- Grant the `USE` privilege on the edition to `PUBLIC`:

```
GRANT USE ON EDITION edition_name TO PUBLIC
```

For information about the GRANT statement, see *Oracle Database SQL Language Reference*.

- Make the edition the database default edition:

```
ALTER DATABASE DEFAULT EDITION = edition_name
```

This has the side effect of allowing all users to use the edition, because it effectively grants the USE privilege on *edition_name* to PUBLIC.

For information about the ALTER DATABASE statement, see *Oracle Database SQL Language Reference*.

27.2.6 Current Edition and Session Edition

Each database session uses exactly one edition at a time. The edition that a database session is using at any one time is called its **current edition**. When a database session begins, its current edition is its **session edition**, which is the edition in which it begins. If you change the session edition, the current edition changes to the same thing. However, there are situations in which the current edition and session edition differ.

Topics:

- [Your Initial Session Edition](#) (page 27-16)
- [Changing Your Session Edition](#) (page 27-17)
- [Displaying the Names of the Current and Session Editions](#) (page 27-18)
- [When the Current Edition Might Differ from the Session Edition](#) (page 27-18)

27.2.6.1 Your Initial Session Edition

When you connect to the database, you can specify your initial session edition. Your initial session edition can be the database default edition or any edition on which you have the USE privilege. To see the names of the editions that are available to you, use this query:

```
SELECT EDITION_NAME FROM ALL_EDITIONS;
```

How you specify your initial session edition at connection time depends on how you connect to the database—see the documentation for your interface.

See Also:

- *Oracle Database Administrator's Guide* for information about setting the database default edition
 - *SQL*Plus User's Guide and Reference* for information about connecting to the database with SQL*Plus
 - *Oracle Call Interface Programmer's Guide* for information about connecting to the database with Oracle Call Interface (OCI)
 - *Oracle Database JDBC Developer's Guide* for information about connecting to the database with JDBC
-

As of Oracle Database 11g Release 2 (11.2.0.2), if you do not specify your session edition at connection time, then:

- If you use a database service to connect to the database, and an initial session edition was specified for that service, then the initial session edition for the service is your initial session edition.
- Otherwise, your initial session edition is the database default edition.

As of Release 11.2.0.2, when you create or modify a database service, you can specify its initial session edition.

To create or modify a database service, Oracle recommends using the `srvctl add service` or `srvctl modify service` command. To specify the default initial session edition of the service, use the `-edition` option.

Alternatively, you can create or modify a database service with the `DBMS_SERVICE.CREATE_SERVICE` or `DBMS_SERVICE.MODIFY_SERVICE` procedure, and specify the default initial session edition of the service with the `EDITION` attribute.

Note:

As of Oracle Database 11g Release 2 (11.2.0.1), the `DBMS_SERVICE.CREATE_SERVICE` and `DBMS_SERVICE.MODIFY_SERVICE` procedures are deprecated in databases managed by Oracle Clusterware and Oracle Restart.

See Also:

- *Oracle Database Administrator's Guide* for information about the `-edition` option of the `srvctl add service` command
 - *Oracle Database Administrator's Guide* for information about the `-edition` option of the `srvctl modify service` command
 - *Oracle Database PL/SQL Packages and Types Reference* for information about the `EDITION` attribute of the `DBMS_SERVICE.CREATE_SERVICE` procedure
 - *Oracle Database PL/SQL Packages and Types Reference* for information about the `EDITION` attribute of the `DBMS_SERVICE.MODIFY_SERVICE` procedure
-
-

27.2.6.2 Changing Your Session Edition

After connecting to the database, you can change your session edition with the SQL statement `ALTER SESSION SET EDITION`. You can change your session edition to the database default edition or any edition on which you have the `USE` privilege. When you change your session edition, your current edition changes to that same edition.

These statements from [Example: Editioned Objects and Copy-on-Change](#) (page 27-11) and [Example: Dropping an Editioned Object](#) (page 27-13) change the session edition (and current edition) first to `e2` and later to `ora$base`:

```
ALTER SESSION SET EDITION = e2
...
ALTER SESSION SET EDITION = ora$base
```

Note:

ALTER SESSION SET EDITION must be a top-level SQL statement. To defer an edition change (in a logon trigger, for example), use the DBMS_SESSION.SET_EDITION_DEFERRED procedure.

See Also:

- *Oracle Database SQL Language Reference* for more information about the ALTER SESSION SET EDITION statement
 - *Oracle Database PL/SQL Packages and Types Reference* for more information about the DBMS_SESSION.SET_EDITION_DEFERRED procedure
-

27.2.6.3 Displaying the Names of the Current and Session Editions

This statement returns the name of the current edition:

```
SELECT SYS_CONTEXT('USERENV', 'CURRENT_EDITION_NAME') FROM DUAL;
```

This statement returns the name of the session edition:

```
SELECT SYS_CONTEXT('USERENV', 'SESSION_EDITION_NAME') FROM DUAL;
```

See Also:

Oracle Database SQL Language Reference for more information about the SYS_CONTEXT function

27.2.6.4 When the Current Edition Might Differ from the Session Edition

The current edition might differ from the session edition in these situations:

- A crosedition trigger fires.
For details, see [Crosedition Trigger Interaction with Editions](#) (page 27-26).
- You run a statement by calling the DBMS_SQL.PARSE procedure, specifying the edition in which the statement is to run, as in [Example 27-4](#) (page 27-19).

While the statement is running, the current edition is the specified edition, but the session edition does not change. For information about the DBMS_SQL.PARSE procedure, see *Oracle Database PL/SQL Packages and Types Reference*.

[Example 27-4](#) (page 27-19) creates a function that returns the names of the session edition and current edition. Then it creates a child edition, which invokes the function twice. The first time, the session edition and current edition are the same. The second time, they are not, because a different edition is passed as a parameter to the DBMS_SQL.PARSE procedure.

Example 27-4 Current Edition Differs from Session Edition

1. Create function that returns the names of the session edition and current edition:

```
CREATE OR REPLACE FUNCTION session_and_current_editions
  RETURN VARCHAR2
IS
BEGIN
  RETURN
    'Session: ' || SYS_CONTEXT('USERENV', 'SESSION_EDITION_NAME') ||
    ' / ' ||
    'Current: ' || SYS_CONTEXT('USERENV', 'CURRENT_EDITION_NAME');
END session_and_current_editions;
/
```

2. Create child edition:

```
CREATE EDITION e2 AS CHILD OF ora$base;
```

3. Use child edition:

```
ALTER SESSION SET EDITION = e2;
```

4. Invoke function:

```
BEGIN
  DBMS_OUTPUT.PUT_LINE (session_and_current_editions());
END;
/
```

Result:

```
Session: E2 / Current: E2
```

PL/SQL procedure successfully completed.

5. Invoke function again:

```
DECLARE
  c    NUMBER := DBMS_SQL.OPEN_CURSOR();
  v    VARCHAR2(200);
  dummy NUMBER;
  stmt CONSTANT VARCHAR2(32767)
    := 'SELECT session_and_current_editions() FROM DUAL';
BEGIN
  DBMS_SQL.PARSE (c => c,
                 statement => stmt,
                 language_flag => DBMS_SQL.NATIVE,
                 edition => 'ora$base');

  DBMS_SQL.DEFINE_COLUMN (c, 1, v, 200);
  dummy := DBMS_SQL.EXECUTE_AND_FETCH (c, true);
  DBMS_SQL.COLUMN_VALUE (c, 1, v);
  DBMS_SQL.CLOSE_CURSOR(c);
  DBMS_OUTPUT.PUT_LINE (v);
END;
/
```

Result:

```
Session: E2 / Current: ORA$BASE
```

PL/SQL procedure successfully completed.

27.2.7 Retiring an Edition

After making a new edition (an upgraded application) available to all users, retire the old edition (the original application), so that no user except *SYS* can use the old edition.

Note:

If the old edition is the database default edition, make another edition the database default edition before you retire the old edition:

```
ALTER DATABASE DEFAULT EDITION = edition_name
```

For information about the `ALTER DATABASE` statement, see *Oracle Database SQL Language Reference*.

To retire an edition, you must revoke the `USE` privilege on the edition from every grantee. To list the grantees, use this query, where `:e` is a placeholder for the name of the edition to be dropped:

```
SELECT GRANTEE, PRIVILEGE
FROM DBA_TAB_PRIVS
WHERE TABLE_NAME = :e AND TYPE = 'EDITION'
/
```

For information about the `REVOKE` statement, see *Oracle Database SQL Language Reference*.

When you retire an edition, update the evaluation editions and unusable editions of noneditioned objects accordingly. For information about changing evaluation editions and unused editions, see [Noneditioned Objects That Can Depend on Editioned Objects](#) (page 27-4).

27.2.8 Dropping an Edition

Note:

If the edition includes crossedition triggers, see [Dropping the Crossedition Triggers](#) (page 27-35), before you drop the edition.

To drop an edition, use the `DROP EDITION` statement, described in *Oracle Database SQL Language Reference*. If the edition has actual objects, you must specify the `CASCADE` clause, which drops the actual objects.

If a `DROP EDITION edition CASCADE` statement is interrupted before finishing normally (from a power failure, for example), the static data dictionary view `*_EDITIONS` shows that the value of `USABLE` for *edition* is `NO`. The only operation that you can perform on such an unusable *edition* is `DROP EDITION CASCADE`.

You drop an edition in these situations:

- You want to roll back the application upgrade.
- (Optional) You have retired the edition.

You can drop an edition only if all of these statements are true:

- The edition is either the root edition or a leaf edition.
- The edition is not in use. (That is, it is not the current edition or session edition of a session.)
- The edition is not the database default edition.

If the edition is the root, and the COMPATIBLE parameter is set to 12.2.0 or higher, the edition is marked as unusable. Each editioned object in the unusable edition that is no longer inherited in any usable descendent edition is later dropped by an automated scheduled maintenance process. After there is no object left in the unusable edition, the edition itself is dropped automatically. If the COMPATIBLE is set to 12.1.0 or lower, the root edition must have no objects that its descendents inherit. Each object inherited from the root edition must either be actualized or dropped explicitly before the edition can be dropped.

If the edition is the leaf, every editioned object in the leaf is dropped, followed by the edition itself before the statement finishes execution.

Note:

After you have dropped an edition, you cannot recompile a noneditioned object that depends on an editioned object if both of the following are true:

- The noneditioned object contains an ADT.
 - The noneditioned object was invalidated when the owner of the editioned object on which it depends was enabled for editions using FORCE.
-
-

To explicitly actualize an inherited object in the child edition:

1. Make the child edition your session edition.

For instructions, see [Changing Your Session Edition](#) (page 27-17).

2. Recompile the object, using the appropriate ALTER statement with COMPILER. For a PL/SQL object, also specify REUSE SETTINGS.

For example, this statement actualizes the procedure p1:

```
ALTER PROCEDURE p1 COMPILER REUSE SETTINGS
```

For information about the ALTER statements for PL/SQL objects, see *Oracle Database PL/SQL Language Reference*.

For information about the ALTER statements for SQL objects, see *Oracle Database SQL Language Reference*.

When you drop an edition, update the evaluation editions and unusable editions of noneditioned objects accordingly. For information about changing evaluation editions and unused editions, see [Noneditioned Objects That Can Depend on Editioned Objects](#) (page 27-4).

See Also:

- *Oracle Database SQL Language Reference* for information about the ALTER LIBRARY statement
 - *Oracle Database SQL Language Reference* for information about the ALTER VIEW statement
 - *Oracle Database PL/SQL Language Reference* for information about the ALTER FUNCTION statement
 - *Oracle Database PL/SQL Language Reference* for information about the ALTER PACKAGE statement
 - *Oracle Database PL/SQL Language Reference* for information about the ALTER PROCEDURE statement
 - *Oracle Database PL/SQL Language Reference* for information about the ALTER TRIGGER statement
 - *Oracle Database PL/SQL Language Reference* for information about the ALTER TYPE statement
-

27.3 Editioning Views

On a noneditioning view, the only type of trigger that you can define is an INSTEAD OF trigger. On an editioning view, you can define every type of trigger that you can define on a table (except crossedition triggers, which are temporary, and INSTEAD OF triggers). Therefore, and because they can be editioned, editioning views let you treat their base tables as if the base tables were editioned. However, you cannot add indexes or constraints to an editioning view; if your upgraded application requires new indexes or constraints, you must add them to the base table.

Note:

If you will change a base table or an index on a base table, then see "[Nonblocking and Blocking DDL Statements](#) (page 8-37)."

An editioning view selects a subset of the columns from a single base table and, optionally, provides aliases for them. In providing aliases, the editioning view maps physical column names (used by the base table) to logical column names (used by the application). An editioning view is like an API for a table.

There is no performance penalty for accessing a table through an editioning view, rather than directly. That is, if a SQL SELECT, INSERT, UPDATE, DELETE, or MERGE statement uses one or more editioning views, one or more times, and you replace each editioning view name with the name of its base table and adjust the column names if necessary, performance does not change.

The static data dictionary view *_EDITIONING_VIEWS describes every editioning view in the database that is visible in the session edition. *_EDITIONING_VIEWS_AE describes every actual object in every editioning view in the database, in every edition.

Topics:

- [Creating an Editioning View](#) (page 27-23)
- [Partition-Extended Editioning View Names](#) (page 27-24)
- [Changing the Writability of an Editioning View](#) (page 27-24)
- [Replacing an Editioning View](#) (page 27-24)
- [Dropped or Renamed Base Tables](#) (page 27-24)
- [Adding Indexes and Constraints to the Base Table](#) (page 27-24)
- [SQL Optimizer Index Hints](#) (page 27-25)

See Also:

Oracle Database Reference for more information about the static data dictionary views *_EDITIONING_VIEWS and *_EDITIONING_VIEWS_AE.

27.3.1 Creating an Editioning View

Before an editioning view is created, its owner must be editions-enabled and the schema object type VIEW must be editionable in its owner. (For instructions, see [Enabling Editions for a User](#) (page 27-6).)

To create an editioning view, use the SQL statement CREATE VIEW with the keyword EDITIONING. To make the editioning view read-only, specify WITH READ ONLY; to make it read-write, omit WITH READ ONLY. Do not specify NONEDITIONABLE, or an error occurs.

If an editioning view is **read-only**, users of the unchanged application can see the data in the base table, but cannot change it. The base table has **semi-availability**. Semi-availability is acceptable for applications such as online dictionaries, which users read but do not change. Make the editioning view read-only if you do not define crossedition triggers on the base table.

If an editioning view is **read-write**, users of the unchanged application can both see and change the data in the base table. The base table has **maximum availability**. Maximum availability is required for applications such as online stores, where users submit purchase orders. If you define crossedition triggers on the base table, make the editioning view read-write.

Because an editioning view must do no more than select a subset of the columns from the base table and provide aliases for them, the CREATE VIEW statement that creates an editioning view has restrictions. Violating the restrictions causes the creation of the view to fail, even if you specify FORCE.

See Also:

Oracle Database SQL Language Reference for more information about using the CREATE VIEW statement to create editioning views, including the restrictions

27.3.2 Partition-Extended Editioning View Names

An editioning view defined on a partitioned table can have a partition-extended name, with partition and subpartition names that refer to the partitions and subpartitions of the base table.

The data manipulation language (DML) statements that support partition-extended table names also support partition-extended editioning view names. These statements are:

- DELETE
- INSERT
- SELECT
- UPDATE

See Also:

Oracle Database SQL Language Reference for information about referring to partitioned tables

27.3.3 Changing the Writability of an Editioning View

To change an existing editioning view from read-only to read-write, use the SQL statement `ALTER VIEW READ WRITE`. To change an existing editioning view from read-write to read-only, use the SQL statement `ALTER VIEW READ ONLY`.

See Also:

Oracle Database SQL Language Reference for more information about the `ALTER VIEW` statement

27.3.4 Replacing an Editioning View

To replace an editioning view, use the SQL statement `CREATE VIEW` with the `OR REPLACE` clause and the keyword `EDITIONING`.

You can replace an editioning view only with another editioning view. Any triggers defined on the replaced editioning view are retained.

27.3.5 Dropped or Renamed Base Tables

If you drop or rename the base table on which an editioning view is defined, the editioning view is not dropped, but the editioning view and its dependents become invalid. However, any triggers defined on the editioning view remain.

27.3.6 Adding Indexes and Constraints to the Base Table

If your upgraded application requires new indexes or constraints, you must add them to the base table. You cannot add them to the editioning view.

If the new indexes might negatively impact the old edition (the original application), make them invisible. In the crossedition triggers that must use the new indexes, specify them in `INDEX` hints.

When all users are using only the upgraded application:

- If the new indexes were used only by the crossedition triggers, drop them.
- If the new indexes are helpful in the upgraded application, make them visible.

See Also:

- [Guidelines for Managing Indexes](#) (page 11-1)
 - *Oracle Database SQL Language Reference* for information about `INDEX` hints
 - [SQL Optimizer Index Hints](#) (page 27-25)
-
-

27.3.7 SQL Optimizer Index Hints

SQL optimizer index hints are specified in terms of the logical names of the columns participating in the index. Any SQL optimizer index hints specified on an editioning view using logical column names must be mapped to an index on the corresponding physical column in the base table.

See Also:

Oracle Database SQL Language Reference for information about using hints

27.4 Crossedition Triggers

The most important difference between crossedition triggers and noncrossedition triggers is how they interact with editions. A crossedition trigger is visible only in the edition in which it is actual, never in a descendent edition. Forward crossedition triggers move data from columns used by the old edition to columns used by the new edition; reverse crossedition triggers do the reverse.

Other important differences are:

- Crossedition triggers can be ordered with triggers defined on other tables, while noncrossedition triggers can be ordered only with other triggers defined on the same table.
- Crossedition triggers are temporary—you drop them after you have made the restructured tables available to all users.

Topics:

- [Forward Crossedition Triggers](#) (page 27-26)
- [Reverse Crossedition Triggers](#) (page 27-26)
- [Crossedition Trigger Interaction with Editions](#) (page 27-26)
- [Creating a Crossedition Trigger](#) (page 27-30)

- [Transforming Data from Pre- to Post-Upgrade Representation](#) (page 27-33)
- [Dropping the Crossedition Triggers](#) (page 27-35)

See Also:

Oracle Database PL/SQL Language Reference for general information about triggers

27.4.1 Forward Crossedition Triggers

The DML changes that you make to the table in the post-upgrade edition are written only to new columns or new tables, never to columns that users of pre-upgrade (ancestor) editions might be reading or writing. However, if the user of an ancestor edition changes the table data, the editioning view that you see must accurately reflect these changes. This is accomplished with forward crossedition triggers.

A forward crossedition trigger defines a **transform**, which is a rule for transforming an old row to one or more new rows. An **old row** is a row of data in the pre-upgrade representation. A **new row** is a row of data in the post-upgrade representation. The name of the trigger refers to the trigger itself and to the transform that the trigger defines.

27.4.2 Reverse Crossedition Triggers

If the pre- and post-upgrade editions will be in ordinary use at the same time (hot rollover), use reverse crossedition triggers to ensure that when users of the post-upgrade edition make changes to the table data, the changes are accurately reflected in the pre-upgrade editions.

27.4.3 Crossedition Trigger Interaction with Editions

The most important difference between crossedition triggers and noncrossedition triggers is how they interact with editions.

In this topic, the **current edition** is the edition in which the triggering DML statement runs. The current edition might differ from the session edition (for details, see [When the Current Edition Might Differ from the Session Edition](#) (page 27-18)).

Topics:

- [Which Triggers Are Visible](#) (page 27-26)
- [What Kind of Triggers Can Fire](#) (page 27-27)
- [Firing Order](#) (page 27-28)
- [Crossedition Trigger Execution](#) (page 27-29)

27.4.3.1 Which Triggers Are Visible

Editions inherit noncrossedition triggers in the same way that they inherit other editioned objects (see [Editioned Objects and Copy-on-Change](#) (page 27-11)).

Editions do not inherit crossedition triggers. A crossedition trigger might fire in response to a DML statement that another edition runs, but its name is visible only in the edition in which it was created. Therefore, an edition can reuse the name of a

crossedition trigger created in an ancestor edition. Reusing the name of a crossedition trigger does not change the conditions under which the older trigger fires.

Crossedition triggers that appear in static data dictionary views are actual objects in the current edition.

27.4.3.2 What Kind of Triggers Can Fire

What kind of triggers can fire depends on the category of the triggering DML statement.

Categories:

- [Forward Crossedition Trigger SQL](#) (page 27-27)
- [Reverse Crossedition Trigger SQL](#) (page 27-28)
- [Application SQL](#) (page 27-28)

Note:

The APPEND hint on a SQL INSERT statement does not prevent crossedition triggers from firing. For information about the APPEND hint, see *Oracle Database SQL Language Reference*.

27.4.3.2.1 Forward Crossedition Trigger SQL

Forward crossedition trigger SQL is SQL that is executed in either of these ways:

- Directly from the body of a forward crossedition trigger

This category includes SQL in an invoked subprogram only if the subprogram is local to the forward crossedition trigger.
- By invoking the DBMS_SQL.PARSE procedure with a non-NULL value for the apply_crossedition_trigger parameter

The only valid non-NULL value for the apply_crossedition_trigger parameter is the unqualified name of a forward crossedition trigger. For more information about the DBMS_SQL.PARSE procedure, see *Oracle Database PL/SQL Packages and Types Reference*.

If a forward crossedition trigger invokes a subprogram in another compilation unit, the SQL in the subprogram is forward crossedition trigger SQL only if it is invoked by the DBMS_SQL.PARSE procedure with a non-NULL value for the apply_crossedition_trigger parameter.

Forward crossedition trigger SQL can fire only triggers that satisfy all of these conditions:

- They are forward crossedition triggers.
- They were created either in the current edition or in a descendent of the current edition.
- They explicitly follow the running forward crossedition trigger.

27.4.3.2.2 Reverse Crossedition Trigger SQL

Reverse crossedition trigger SQL is SQL that is executed directly from the body of a reverse crossedition trigger. This category includes SQL in an invoked subprogram only if the subprogram is local to the reverse crossedition trigger.

Reverse crossedition trigger SQL can fire only triggers that satisfy all of these conditions:

- They are reverse crossedition triggers.
- They were created either in the current edition or in an ancestor of the current edition.
- They explicitly precede the running reverse crossedition trigger.

27.4.3.2.3 Application SQL

Application SQL is all SQL except crossedition trigger SQL, including these DML statements:

- Dynamic SQL DML statements coded with the `DBMS_SQL` package (for information about these statements, see *Oracle Database PL/SQL Language Reference*).
- DML statements executed by Java stored procedures and external procedures (even when these procedures are invoked by `CALL` triggers)

Application SQL fires both noncrossedition and crossedition triggers, according to these rules:

Kind of Trigger	Conditions Under Which Trigger Can Fire
Noncrossedition	Trigger is both visible and enabled in the current edition.
Forward crossedition	Trigger was created in a descendent of the current edition.
Reverse crossedition	Trigger was created either in the current edition or in an ancestor of the current edition.

27.4.3.3 Firing Order

For a trigger to fire in response to a specific DML statement, the trigger must:

- Be the right kind (see [What Kind of Triggers Can Fire](#) (page 27-27))
- Satisfy the selection criteria (for example, the type of DML statement and the `WHEN` clause)
- Be enabled

For the triggers that meet these requirements, firing order depends on the `FOLLOWS` and `PRECEDES` clauses, the trigger type, and the edition.

Topics:

- [FOLLOWS and PRECEDES Clauses](#) (page 27-29)
- [Trigger Type and Edition](#) (page 27-29)

See Also:

Oracle Database PL/SQL Language Reference for general information about trigger firing order

27.4.3.3.1 FOLLOWS and PRECEDES Clauses

When triggers A and B are to be fired at the same timing point, A fires before B fires if either of these is true:

- A explicitly precedes B.
- B explicitly follows A.

This rule is independent of conditions such as:

- Whether the triggers are enabled or disabled
- Whether the columns specified in the UPDATE OF clause are modified
- Whether the WHEN clauses are satisfied
- Whether the triggers are associated with the same kinds of DML statements (INSERT, UPDATE, or DELETE)
- Whether the triggers have overlapping timing points

The firing order of triggers that do not explicitly follow or precede each other is unpredictable.

27.4.3.3.2 Trigger Type and Edition

For each timing point associated with a triggering DML statement, eligible triggers fire in this order. In categories 1 (page 27-29) through 3 (page 27-29), FOLLOWS relationships apply; in categories 4 (page 27-29) and 5 (page 27-29), PRECEDES relationships apply.

1. Noncrossedition triggers
2. Forward crossedition triggers created in the current edition
3. Forward crossedition triggers created in descendants of the current edition, in the order that the descendants were created (child, grandchild, and so on)
4. Reverse crossedition triggers created in the current edition
5. Reverse crossedition triggers created in the ancestors of the current edition, in the reverse order that the ancestors were created (parent, grandparent, and so on)

27.4.3.4 Crossedition Trigger Execution

A crossedition trigger runs using the edition in which it was created. Any code that the crossedition trigger calls (including package references, PL/SQL subprogram calls, and SQL statements) also runs in the edition in which the crossedition trigger was created.

If a PL/SQL package is actual in multiple editions, then the package variables and other state are private in each edition, even within a single session. Because each crossedition trigger and the code that it calls run using the edition in which the

crossedition trigger was created, the same session can instantiate two or more versions of the package, with the same name.

27.4.4 Creating a Crossedition Trigger

Before a crossedition trigger is created, its owner must be editions-enabled and the schema object type `TRIGGER` must be editionable in its owner. (For instructions, see [Enabling Editions for a User](#) (page 27-6).)

Create a crossedition trigger with the SQL statement `CREATE TRIGGER`, observing these rules:

- A crossedition trigger must be defined on a table, not a view.
- A crossedition trigger must have the `EDITIONABLE` property.
- A crossedition trigger must be a DML trigger (simple or compound).
The DML statement in a crossedition trigger body can be either a static SQL statement (described in *Oracle Database PL/SQL Language Reference*) or a native dynamic SQL statement (described in *Oracle Database PL/SQL Language Reference*).
- A crossedition trigger is forward unless you specify `REVERSE`. (Specifying `FORWARD` is optional.)
- The `FOLLOWS` clause is allowed only when creating a forward crossedition trigger or a noncrossedition trigger. (The `FOLLOWS` clause indicates that the trigger being created is to fire after the specified triggers fire.)
- The `PRECEDES` clause is allowed only when creating a reverse crossedition trigger. (The `PRECEDES` clause indicates that the trigger being created is to fire before the specified triggers fire.)
- The triggers specified in the `FOLLOWS` or `PRECEDES` clause must exist, but need not be enabled or successfully compiled.
- Like a noncrossedition trigger, a crossedition trigger is created in the enabled state unless you specify `DISABLE`. (Specifying `ENABLE` is optional.)

Tip:

Create crossedition triggers in the disabled state, and enable them after you are sure that they compile successfully. If you create them in the enabled state, and they fail to compile, the failure affects users of the existing application.

- The operation in a crossedition trigger body must be **idempotent** (that is, performing the operation multiple times is redundant; it does not change the result).

See Also:

Oracle Database PL/SQL Language Reference for more information about using the `CREATE TRIGGER` statement to create crossedition triggers

27.4.4.1 Coding the Forward Crossedition Trigger Body

The operation in the body of a forward crossedition trigger must be idempotent, because it is impossible to predict:

- The context in which the body will first run for an old row.

The possibilities are:

- When a user of an ancestor edition runs a DML statement that fires the trigger (a **serendipitous change**)
- When you **apply the transform** that the trigger defines (do a bulk upgrade of rows from old format to new format)

For information about applying transforms, see [Transforming Data from Pre- to Post-Upgrade Representation](#) (page 27-33).

- How many times the body will run for each old row.

Topics:

- [Handling Data Transformation Collisions](#) (page 27-31)
- [Handling Changes to Other Tables](#) (page 27-32)

27.4.4.1.1 Handling Data Transformation Collisions

If a forward crossedition trigger populates a new table (rather than new columns of a table), its body must handle data transformation collisions.

For example, suppose that a column of the new table has a `UNIQUE` constraint. A serendipitous change fires the forward crossedition trigger, which inserts a row in the new table. Later, another serendipitous change fires the forward crossedition trigger, or you apply the transform defined by the trigger. The trigger tries to insert a row in the new table, violating the `UNIQUE` constraint.

If your collision-handling strategy depends on why the trigger is running, you can determine the reason with the function `APPLYING_CROSSEDITION_TRIGGER`. When called directly from a trigger body, this function returns the `BOOLEAN` value `TRUE` if the trigger is running because of a serendipitous change and `FALSE` if the trigger is running because you are applying the transform in bulk. (`APPLYING_CROSSEDITION_TRIGGER` is defined in the package `DBMS_STANDARD`. It has no parameters.)

To ignore collisions and insert the rows that do not collide with existing rows, put the `IGNORE_ROW_ON_DUPKEY_INDEX` hint in the `INSERT` statement.

If you do not want to ignore such collisions, but want to know where they occur so that you can handle them, put the `CHANGE_DUPKEY_ERROR_INDEX` hint in the `INSERT` or `UPDATE` statement, specifying either an index or set of columns. Then, when a unique key violation occurs for that index or set of columns, `ORA-38911` is reported instead of `ORA-00001`. You can write an exception handler for `ORA-38911`.

Note:

Although they have the syntax of hints, `IGNORE_ROW_ON_DUPKEY_INDEX` and `CHANGE_DUPKEY_ERROR_INDEX` are mandates. The optimizer always uses them.

Example 27-5 (page 27-32) creates a crossedition trigger that uses the `APPLYING_CROSSEDITION_TRIGGER` function and the `IGNORE_ROW_ON_DUPKEY_INDEX` and `CHANGE_DUPKEY_ERROR_INDEX` hints to

handle data transformation collisions. The trigger transforms old rows in `table1` to new rows in `table2`. The tables were created as follows:

```
CREATE TABLE table1 (key NUMBER, value VARCHAR2(20));

CREATE TABLE table2 (key NUMBER, value VARCHAR2(20), last_updated TIMESTAMP);
CREATE UNIQUE INDEX i2 on table2(key);
```

See Also:

- *Oracle Database SQL Language Reference* for more information about `IGNORE_ROW_ON_DUPKEY_INDEX`
 - *Oracle Database SQL Language Reference* for more information about `CHANGE_DUPKEY_ERROR_INDEX`
 - *Oracle Database SQL Language Reference* for general information about hints
-
-

Example 27-5 Crossedition Trigger that Handles Data Transformation Collisions

```
CREATE OR REPLACE TRIGGER trigger1
  BEFORE INSERT OR UPDATE ON table1
  FOR EACH ROW
  CROSSEDITION
DECLARE
  row_already_present EXCEPTION;
  PRAGMA EXCEPTION_INIT(row_already_present, -38911);
BEGIN
  IF APPLYING_CROSSEDITION_TRIGGER THEN
    /* The trigger is running because of applying the transform.
       If the old edition of the app has already caused this trigger
       to insert a row, we do not modify the row as part of applying
       the transform. Therefore, insert the new row into table2 only if
       it is not already there. */
    INSERT /*+ IGNORE_ROW_ON_DUPKEY_INDEX(table2(key)) */
    INTO table2
    VALUES(:new.key, :new.value, to_date('1900-01-01', 'YYYY-MM-DD'));
  ELSE
    /* The trigger is running because of a serendipitous change.
       If no previous run of the trigger has already inserted
       the corresponding row into table2, insert the new row;
       otherwise, update the previously inserted row. */
    BEGIN
      INSERT /*+ CHANGE_DUPKEY_ERROR_INDEX(table2(key)) */
      INTO table2
      VALUES(:new.key, :new.value, SYSTIMESTAMP);
    EXCEPTION WHEN row_already_present THEN
      UPDATE table2
      SET value = :new.value, last_updated = SYSTIMESTAMP
      WHERE key = :new.key;
    END;
  END IF;
END;
```

27.4.4.1.2 Handling Changes to Other Tables

If the body of a forward crossedition trigger includes explicit SQL statements that change tables other than the one on which the trigger is defined, and if the rows of

those tables do not have a one-to-one correspondence with the rows of the table on which the trigger is defined, then the body code must implement a locking mechanism that correctly handles these situations:

- Two or more users of ancestor editions simultaneously issue DML statements for the table on which the trigger is defined.
- At least one user of an ancestor edition issues a DML statement for the table on which the trigger is defined.

27.4.5 Transforming Data from Pre- to Post-Upgrade Representation

After redefining the database objects that comprise the application that you are upgrading (in the new edition), you must transform the application data from its pre-upgrade representation (in the old edition) to its post-upgrade representation (in the new edition). The rules for this transformation are called **transforms**, and they are defined by forward crossedition triggers. (For general information about forward crossedition triggers, see [Forward Crossedition Triggers](#) (page 27-26).)

Some old rows might have been transformed to new rows by **serendipitous changes**; that is, by changes that users of the pre-upgrade application made, which fired forward crossedition triggers. However, any rows that were not transformed by serendipitous changes are still in their pre-upgrade representation. To ensure that all old rows are transformed to new rows, you must **apply the transforms** that you defined on the tables that store the application data.

There are three ways to apply a transform:

- Fire the trigger that defines the transform on every row of the table, one row at a time.
- Instead of firing the trigger, run a SQL statement that does what the trigger would do, but faster, and then fire any triggers that follow that trigger.

This second way is recommended over the first way if you have replaced an entire table or created a new table.

- Invoke the procedure `DBMS_EDITIONS_UTILITIES.SET_NULL_COLUMN_VALUES_TO_EXPR` to use a metadata operation to apply the transform to the new column.

This third way has the fastest installation time, but there are restrictions on the expression that represents the transform, and queries of the new column are slower until the metadata is replaced by actual data.

Metadata is replaced by actual data:

- In an individual column element that is updated.
- In every element of a column whose table is "compacted" using online table redefinition.

For the syntax, semantics, and restrictions of the `DBMS_EDITIONS_UTILITIES.SET_NULL_COLUMN_VALUES_TO_EXPR` procedure, see *Oracle Database PL/SQL Packages and Types Reference*.

For the first two ways of applying the transform, invoke either the `DBMS_SQL.PARSE` procedure or the subprograms in the `DBMS_PARALLEL_EXECUTE` package. The latter is recommended if you have a lot of data. The subprograms enable you to incrementally update the data in a large table in parallel, in two high-level steps:

1. Group sets of rows in the table into smaller chunks.
2. Apply the desired UPDATE statement to the chunks in parallel, committing each time you have finished processing a chunk.

The advantages are:

- You lock only one set of rows at a time, for a relatively short time, instead of locking the entire table.
- You do not lose work that has been done if something fails before the entire operation finishes.

For both the DBMS_SQL.PARSE procedure and the DBMS_PARALLEL_EXECUTE subprograms, the actual parameter values for `apply_crossedition_trigger`, `fire_apply_trigger`, and `sql_stmt` are the same:

- For `apply_crossedition_trigger`, specify the name of the forward crossedition trigger that defines the transform to be applied.
- To fire the trigger on every row of the table, one row at a time:
 - For the value of `fire_apply_trigger`, specify TRUE.
 - For `sql_stmt`, supply a SQL statement whose only significant effect is to select the forward crossedition trigger to be fired; for example, an UPDATE statement that sets some column to its own existing value in each row.
- To run a SQL statement that does what the trigger would do, and then fire any triggers that follow that trigger:
 - For the value of `fire_apply_trigger`, specify FALSE.
 - For `sql_stmt`, supply a SQL statement that does what the forward crossedition trigger would do, but faster—for example, a PL/SQL anonymous block that calls one or more PL/SQL subprograms.

See Also:

- *Oracle Database PL/SQL Packages and Types Reference* for more information about the DBMS_SQL.PARSE procedure
 - *Oracle Database PL/SQL Packages and Types Reference* for more information about the DBMS_PARALLEL_EXECUTE package
-
-

27.4.5.1 Preventing Lost Updates

To prevent lost updates when applying a transform, use this procedure:

1. Enable crossedition triggers.
2. Wait until pending changes to the affected tables are either committed or rolled back.

Use the procedure DBMS_UTILITY.WAIT_ON_PENDING_DML, described in *Oracle Database PL/SQL Packages and Types Reference*.

3. Apply the transform.

Note:

This scenario, where the forward crossedition trigger changes only the table on which it is defined, is sufficient to illustrate the risk. Suppose that Session One issues an `UPDATE` statement against the table when the crossedition trigger is not yet enabled; and that Session Two then enables the crossedition trigger and immediately applies the transformation.

A race condition can now occur when both Session One and Session Two will change the same row (row n). Chance determines which session reaches row n first. Both updates succeed, even if the session that reaches row n second must wait until the session that reached it first commits its change and releases its lock.

The problem occurs when Session Two wins the race. Because its SQL statement was compiled after the trigger was enabled, the program that implements the statement also implements the trigger action; therefore, the intended post-upgrade column values are set for row n . Now Session One reaches row n , and because its SQL statement was compiled before the trigger was enabled, the program that implements the statement does not implement the trigger action. Therefore, the values that Session Two set in the post-upgrade columns do not change—they reflect the values that the source columns had before Session One updated row n . That is, the intended side-effect of Session One's update is lost.

27.4.6 Dropping the Crossedition Triggers

To drop a crossedition trigger, use the `DROP TRIGGER` statement, described in *Oracle Database PL/SQL Language Reference*. Alternatively, you can drop crossedition triggers by dropping the edition in which they are actual, by using the `DROP EDITION` statement with the `CASCADE` clause. For information about dropping editions, see [Dropping an Edition](#) (page 27-20).

You drop crossedition triggers in these situations:

- You are rolling back the application upgrade (dropping the post-upgrade edition).

Before dropping the post-upgrade edition, you must disable or drop any constraints on the new columns.

- You have finished the application upgrade and made the post-upgrade edition available to all users.

When all sessions are using the post-upgrade edition, you can drop the forward crossedition triggers. However, before dropping the reverse crossedition triggers, you must disable or drop any constraints on the old columns.

To disable or drop constraints, use the `ALTER TABLE` statement with the `DISABLE CONSTRAINT` or `DROP CONSTRAINT` clause. For information about the `ALTER TABLE` statement, see *Oracle Database SQL Language Reference*.

27.5 Displaying Information About EBR Features

Topics:

- [Displaying Information About Editions](#) (page 27-36)
- [Displaying Information About Editioning Views](#) (page 27-37)
- [Displaying Information About Crossedition Triggers](#) (page 27-38)

27.5.1 Displaying Information About Editions

[Table 27-1](#) (page 27-36) briefly describes the static data dictionary views that display information about editions. For more information about a specific view, see *Oracle Database Reference*.

Table 27-1 * _ Dictionary Views with Edition Information

View	Description
*_EDITIONS	Describes every edition in the database.
*_EDITION_COMMENTS	Shows the comments associated with every edition in the database.
*_EDITIONED_TYPES	Lists the schema object types that are editioned by default in each schema.
*_OBJECTS	Describes every object in the database that is visible in the current edition. For each object, this view shows whether it is editionable.
*_OBJECTS_AE	Describes every object in the database, in every edition. For each object, this view shows whether it is editionable.
*_ERRORS	Describes every error in the database in the current edition.
*_ERRORS_AE	Describes every error in the database, in every edition.
*_USERS	Describes every user in the database. Useful for showing which users have editions enabled.
*_SERVICES	Describes every service in the database. The EDITIONS column shows the default initial current edition.
*_MIEWS	Describes every materialized view. If the materialized view refers to editioned objects, then this view shows the evaluation edition and the range of editions where the materialized view is eligible for query rewrite.
*_TAB_COLS	Describes every column of every table, view, and cluster. For each virtual column, this view shows the evaluation edition and the usable range.

Note:

*_OBJECTS and *_OBJECTS_AE include dependent objects that are invalidated by operations in [Table 26-2](#) (page 26-6) only after one of the following:

- A reference to the object (either during compilation or execution)
- An invocation of DBMS_UTILITY.COMPILE_SCHEMA (described in *Oracle Database PL/SQL Packages and Types Reference*)
- An invocation of any UTL_RECOMP subprogram (described in *Oracle Database PL/SQL Packages and Types Reference*)

27.5.2 Displaying Information About Editioning Views

[Table 27-2](#) (page 27-37) briefly describes the static data dictionary views that display information about editioning views. For more information about a specific view, see *Oracle Database Reference*.

Table 27-2 *_ Dictionary Views with Editioning View Information

View	Description
*_VIEWS	Describes every view in the database that is visible in the current edition, including editioning views.
*_EDITIONING_VIEWS	Describes every editioning view in the database that is visible in the current edition. Useful for showing relationships between editioning views and their base tables. Join with *_OBJECTS_AE (page 27-36) for additional information.
*_EDITIONING_VIEWS_AE	Describes every actual object in every editioning view in the database, in every edition.
*_EDITIONING_VIEW_COLUMNS	Describes the columns of every editioning view in the database that is visible in the current edition. Useful for showing relationships between the columns of editioning views and the table columns to which they map. Join with *_OBJECTS_AE (page 27-36), *_TAB_COLS, or both, for additional information.
*_EDITIONING_VIEW_COLUMNS_AE	Describes the columns of every editioning view in the database, in every edition.

Each row of *_EDITIONING_VIEWS matches exactly one row of *_VIEWS, and each row of *_VIEWS that has EDITIONING_VIEW = 'Y' matches exactly one row of *_EDITIONING_VIEWS. Therefore, in this example, the WHERE clause is redundant:

```
SELECT ...
  FROM DBA_EDITIONING_VIEWS INNER JOIN DBA_VIEWS
    USING (OWNER, VIEW_NAME)
 WHERE EDITIONING_VIEW = 'Y'
 AND ...
```

The row of *_VIEWS that matches a row of *_EDITIONING_VIEWS has EDITIONING_VIEW = 'Y' by definition. Conversely, no row of *_VIEWS that has EDITIONING_VIEW = 'N' has a counterpart in *_EDITIONING_VIEWS.

27.5.3 Displaying Information About Crossedition Triggers

The static data dictionary views that display information about triggers are described in *Oracle Database Reference*. Crossedition triggers that appear in static data dictionary views are actual objects in the current edition.

Child cursors cannot be shared if the set of crossedition triggers that might run differs. The dynamic performance views V\$SQL_SHARED_CURSOR and GV_\$SQL_SHARED_CURSOR have a CROSSEDITION_TRIGGER_MISMATCH column that tells whether this is true. For information about V\$SQL_SHARED_CURSOR, see *Oracle Database Reference*.

27.6 Using EBR to Upgrade an Application

To use EBR to upgrade your application online, you must first ready your application:

1. Editions-enable the appropriate users and the appropriate schema object types in their schemas.

In schemas where you will create editioning views (in the next step), the type VIEW must be editionable.

For instructions, see [Enabling Editions for a User](#) (page 27-6).

2. Prepare your application to use editioning views.

For instructions, see [Preparing Your Application to Use Editioning Views](#) (page 27-39).

With the editioning views in place, you can use EBR to upgrade your application online as often as necessary. For each upgrade:

- If the type of every object that you will redefine is editionable (tables are not editionable), then use the procedure in [Procedure for EBR Using Only Editions](#) (page 27-40).
- If you will change the structure of one or more tables, and while you are doing so, other users *need not* be able to change data in those tables, then use the procedure in [Procedure for EBR Using Editioning Views](#) (page 27-42).
- If you will change the structure of one or more tables, and while you are doing so, other users must be able to change data in those tables, then use the procedure in [Procedure for EBR Using Crossedition Triggers](#) (page 27-43).

Topics:

- [Preparing Your Application to Use Editioning Views](#) (page 27-39)
- [Procedure for EBR Using Only Editions](#) (page 27-40)
- [Procedure for EBR Using Editioning Views](#) (page 27-42)
- [Procedure for EBR Using Crossedition Triggers](#) (page 27-43)
- [Rolling Back the Application Upgrade](#) (page 27-44)

- [Reclaiming Space Occupied by Unused Table Columns](#) (page 27-45)
- [Example: Using EBR to Upgrade an Application](#) (page 27-45)

27.6.1 Preparing Your Application to Use Editioning Views

An application that uses one or more tables must cover each table with an editioning view. An editioning view **covers** a table when all of these statements are true:

- Every ordinary object in the application references the table only through the editioning view. (An **ordinary object** is any object except an editioning view or crossedition trigger. Editioning views and crossedition triggers must reference tables.)
- Application users are granted object privileges only on the editioning view, not on the table.
- Oracle Virtual Private Database (VPD) policies are attached only to the editioning view, not to the table. (Regular auditing and fine-grained auditing (FGA) policies are attached only to the table.)

When the editioning view is actualized, a copy of the VPD policy is attached to the actualized editioning view. (A policy is uniquely identified by its name and the object to which it is attached.) If the policy function is also actualized, the copy of the policy uses the actualized policy function; otherwise, it uses the original policy function.

The static data dictionary views `*_POLICIES`, which describe the VPD policies, can have different results in different editions.

See Also:

- *Oracle Database Security Guide* for information about VPD, including that static data dictionary views that show information about VPD policies
 - *Oracle Database Reference* for information about `*_POLICIES`
-
-

If an existing application does not use editioning views, prepare it to use them by following this procedure for each table that it uses:

1. Give the table a new name (so that you can give its current name to its editioning view).

Oracle recommends choosing a new name that is related to the original name and reflects the change history. For example, if the original table name is `Data`, the new table name might be `Data_1`.

2. (Optional) Give each column of the table a new name.

Again, Oracle recommends choosing new names that are related to the original names and reflect the change history. For example, `Name` and `Number` might be changed to `Name_1` and `Number_1`.

Any triggers that depend on renamed columns are now invalid. For details, see the entry for `ALTER TABLE table RENAME column` in [Table 26-2](#) (page 26-6).

3. Create the editioning view, giving it the original name of the table.

For instructions, see [Creating an Editioning View](#) (page 27-23).

Because the editioning view has the name that the table had, objects that reference that name now reference the editioning view.

4. If triggers are defined on the table, drop them, and rerun the code that created them.

Now the triggers that were defined on the table are defined on the editioning view.

5. If VPD policies are attached to the table, drop the policies and policy functions and rerun the code that created them.

Now the VPD policies that were attached to the table are attached to the editioning view.

6. Revoke all object privileges on the table from all application users.

To see which application users have which object privileges on the table, use this query:

```
SELECT GRANTEE, PRIVILEGE
FROM DBA_TAB_PRIVS
WHERE TABLE_NAME='table_name';
```

7. For every privilege revoked in step 6 (page 27-40), grant the same privilege on the editioning view.
8. For each user who owns a private synonym that refers to the table, enable editions, specifying that the type `SYNONYM` is editionable in the schema (for instructions, see [Enabling Editions for a User](#) (page 27-6)).
9. Notify the owners of private synonyms that refer to the table that they must re-create those synonyms.

27.6.2 Procedure for EBR Using Only Editions

Use this procedure only if every object that you will redefine is editioned (as defined in [Editioned and Noneditioned Objects](#) (page 27-2)). Tables are never editioned objects.

1. Create a new edition.

For instructions, see [Creating an Edition](#) (page 27-10).

2. Make the new edition your session edition.

For instructions, see [Changing Your Session Edition](#) (page 27-17).

3. Make the necessary changes to the editioned objects of the application.
4. Ensure that all objects are valid.

Query the static data dictionary `*_OBJECTS_AE`, which describes every actual object in the database, in every edition. If invalid objects remain, recompile them, using any `UTL_RECOMP` subprogram (described in *Oracle Database PL/SQL Packages and Types Reference*).

5. Check that the changes work as intended.

If so, go to step 6 (page 27-41).

If not, either make further changes (return to step3 (page 27-40)) or roll back the application upgrade (for instructions, see [Rolling Back the Application Upgrade](#) (page 27-44)).

6. Make the new edition (the upgraded application) available to all users.

For instructions, see [Making an Edition Available to All Users](#) (page 27-15).

7. Retire the old edition (the original application), so that all users except SYS use only the upgraded application.

For instructions, see [Retiring an Edition](#) (page 27-20).

[Example 27-6](#) (page 27-41) shows how to use the preceding procedure to change a very simple PL/SQL procedure.

Example 27-6 EBR of Very Simple Procedure

1. Create PL/SQL procedure for this example:

```
CREATE OR REPLACE PROCEDURE hello IS
BEGIN
  DBMS_OUTPUT.PUT_LINE('Hello, edition 1. ');
END hello;
/
```

2. Invoke PL/SQL procedure:

```
BEGIN hello(); END;
/
```

Result:

```
Hello, edition 1.
```

```
PL/SQL procedure successfully completed.
```

3. Do EBR of procedure:

- a. Create new edition:

```
CREATE EDITION e2 AS CHILD OF ora$base;
```

Result:

```
Edition created.
```

- b. Make new edition your session edition:

```
ALTER SESSION SET EDITION = e2;
```

Result:

```
Session altered.
```

- c. Change procedure:

```
CREATE OR REPLACE PROCEDURE hello IS
BEGIN
  DBMS_OUTPUT.PUT_LINE('Hello, edition 2. ');
END hello;
/
```

Result:

```
Procedure created.
```

- d. Check that change works as intended:

```
BEGIN hello(); END;
/
```

Result:

```
Hello, edition 2.
PL/SQL procedure successfully completed.
```

- e. Make new edition available to all users (requires system privileges):

```
ALTER DATABASE DEFAULT EDITION = e2;
```

- f. Retire old edition (requires system privileges):

List grantees:

```
SELECT GRANTEE, PRIVILEGE
FROM DBA_TAB_PRIVS
WHERE TABLE_NAME = UPPER('ora$base')
/
```

Result:

GRANTEE	PRIVILEGE
-----	-----
PUBLIC	USE

```
1 row selected.
```

Revoke use on old edition from all grantees:

```
REVOKE USE ON EDITION ora$base FROM PUBLIC;
```

27.6.3 Procedure for EBR Using Editioning Views

Use this procedure only if you will change the structure of one or more tables, and while you are doing so, other users *need not* be able to change data in those tables.

1. Create a new edition.

For instructions, see [Creating an Edition](#) (page 27-10).

2. Make the new edition your session edition.

For instructions, see [Changing Your Session Edition](#) (page 27-17).

3. In the new edition, if the editioning views are read-only, make them read-write.

For instructions, see [Changing the Writability of an Editioning View](#) (page 27-24).

4. In every edition except the new edition, make the editioning views read-only.

5. Make the necessary changes to the objects of the application.

6. Ensure that all objects are valid.

Query the static data dictionary `*_OBJECTS_AE`, which describes every actual object in the database, in every edition. If invalid objects remain, recompile them,

using any `UTL_RECOMP` subprogram (described in *Oracle Database PL/SQL Packages and Types Reference*).

7. Check that the changes work as intended.

If so, go to step 8 (page 27-43).

If not, either make further changes (return to step 5 (page 27-42)) or roll back the application upgrade (for instructions, see [Rolling Back the Application Upgrade](#) (page 27-44)).

8. Make the upgraded application available to all users.

For instructions, see [Making an Edition Available to All Users](#) (page 27-15).

9. Retire the old edition (the original application), so that all users except `SYS` use only the upgraded application.

For instructions, see [Retiring an Edition](#) (page 27-20).

27.6.4 Procedure for EBR Using Crossedition Triggers

Use this procedure only if you will change the structure of one or more tables, and while you are doing so, other users must be able to change data in those tables.

1. Create a new edition.

For instructions, see [Creating an Edition](#) (page 27-10).

2. Make the new edition your session edition.

For instructions, see [Changing Your Session Edition](#) (page 27-17).

3. Make the permanent changes to the objects of the application.

For example, add new columns to the tables and create any new permanent subprograms.

Objects that depend on objects that you changed might now be invalid. For more information, see [Table 26-2](#) (page 26-6).

4. Ensure that all objects are valid.

Query the static data dictionary `*_OBJECTS_AE`, which describes every actual object in the database, in every edition. If invalid objects remain, recompile them, using any `UTL_RECOMP` subprogram (described in *Oracle Database PL/SQL Packages and Types Reference*).

5. Create the temporary objects—the crossedition triggers (in the disabled state) and any subprograms that they need.

For instructions, see [Creating a Crossedition Trigger](#) (page 27-30).

You need reverse crossedition triggers only if you do step 10 (page 27-44), which is optional.

6. When the crossedition triggers compile successfully, enable them.

Use the `ALTER TRIGGER` statement with the `ENABLE` option. For information about this statement, see *Oracle Database PL/SQL Language Reference*.

7. Wait until pending changes are either committed or rolled back.

Use the procedure `DBMS_UTILITY.WAIT_ON_PENDING_DML`, described in *Oracle Database PL/SQL Packages and Types Reference*.

8. Apply the transforms.

For instructions, see [Transforming Data from Pre- to Post-Upgrade Representation](#) (page 27-33).

Note:

It is impossible to predict whether this step visits an existing row before a user of an ancestor edition updates, inserts, or deletes data from that row.

9. Check that the changes work as intended.

If so, go to step 10 (page 27-44).

If not, either make further changes (return to step 3 (page 27-43)) or roll back the application upgrade (for instructions, see [Rolling Back the Application Upgrade](#) (page 27-44)).

10. (Optional) Grant the `USE` privilege on your session edition to the early users of the upgraded application.

For instructions, see [Making an Edition Available to Some Users](#) (page 27-15).

11. Make the upgraded application available to all users.

For instructions, see [Making an Edition Available to All Users](#) (page 27-15).

12. Disable or drop the constraints and then drop the crossedition triggers.

For instructions, see [Dropping the Crossedition Triggers](#) (page 27-35).

13. Retire the old edition (the original application), so that all users except `SYS` use only the upgraded application.

For instructions, see [Retiring an Edition](#) (page 27-20).

27.6.5 Rolling Back the Application Upgrade

To roll back the application upgrade:

1. Change your session edition to something other than the new edition that you created for the upgrade.

For instructions, see [Changing Your Session Edition](#) (page 27-17).

2. Drop the new edition that you created for the upgrade.

For instructions, see [Dropping an Edition](#) (page 27-20).

3. If you created new table columns during the upgrade, reclaim the space that they occupy (for instructions, see [Reclaiming Space Occupied by Unused Table Columns](#) (page 27-45)).

27.6.6 Reclaiming Space Occupied by Unused Table Columns

If you roll back an upgrade for which you created new table columns, To reclaim the space that unused columns occupy:

1. Set the values of the unused columns to NULL.

To avoid locking out other users while doing this operation, use the `DBMS_PARALLEL_EXECUTE` procedure (described in *Oracle Database PL/SQL Packages and Types Reference*).

2. Set the unused columns to UNUSED.

Use the `ALTER TABLE` statement (described in *Oracle Database SQL Language Reference*) with the `SET UNUSED` clause (described in *Oracle Database SQL Language Reference*).

3. Shrink the table.

Use the `ALTER TABLE` statement (described in *Oracle Database SQL Language Reference*) with the `SHRINK SPACE` clause (described in *Oracle Database SQL Language Reference*).

27.6.7 Example: Using EBR to Upgrade an Application

This example uses an edition, an editioning view, a forward crossedition trigger, and a reverse crossedition trigger.

Topics:

- [Existing Application](#) (page 27-45)
- [Preparing the Application to Use Editioning Views](#) (page 27-47)
- [Using EBR to Upgrade the Application](#) (page 27-48)

Note:

Before you can use EBR to upgrade an application, you must enable editions for every schema that the application uses. For instructions, see [Enabling Editions for a User](#) (page 27-6).

27.6.7.1 Existing Application

The existing application—the application to be upgraded—consists of a single table on which a trigger is defined.

The existing application has a trigger, which you can check. The following examples show the existing application:

- [Example: Creating the Existing Application](#) (page 27-45)
- [Example: Viewing Data in Existing Table](#) (page 27-46)

27.6.7.1.1 Example: How the Existing Application Was Created

The application was created as in [Example 27-7](#) (page 27-46).

Example 27-7 Creating the Existing Application

1. Create table:

```
CREATE TABLE Contacts(
  ID          NUMBER(6,0) CONSTRAINT Contacts_PK PRIMARY KEY,
  Name        VARCHAR2(47),
  Phone_Number VARCHAR2(20)
);
```

2. Populate table (not shown).

3. Prepare to create trigger on table:

```
ALTER TABLE Contacts ENABLE VALIDATE CONSTRAINT Contacts_PK;

DECLARE Max_ID INTEGER;
BEGIN
  SELECT MAX(ID) INTO Max_ID FROM Contacts;
  EXECUTE IMMEDIATE '
    CREATE SEQUENCE Contacts_Seq
      START WITH ' || To_Char(Max_ID + 1);
END;
/
```

4. Create trigger:

```
CREATE TRIGGER Contacts_BI
  BEFORE INSERT ON Contacts FOR EACH ROW
BEGIN
  :NEW.ID := Contacts_Seq.NEXTVAL;
END;
/
```

27.6.7.1.2 Example: Viewing Data in the Existing Table

[Example 27-8](#) (page 27-46) shows how the table `Contacts` looks after being populated with data.

Example 27-8 Viewing Data in the Existing Table

Query:

```
SELECT * FROM Contacts
ORDER BY Name;
```

Result:

ID	NAME	PHONE_NUMBER
174	Abel, Ellen	011.44.1644.429267
166	Ande, Sundar	011.44.1346.629268
130	Atkinson, Mozhe	650.124.6234
105	Austin, David	590.423.4569
204	Baer, Hermann	515.123.8888
116	Baida, Shelli	515.127.4563
167	Banda, Amit	011.44.1346.729268
172	Bates, Elizabeth	011.44.1343.529268
192	Bell, Sarah	650.501.1876
151	Bernstein, David	011.44.1344.345268
129	Bissot, Laura	650.124.5234

```

169 Bloom, Harrison          011.44.1343.829268
185 Bull, Alexis            650.509.2876
187 Cabrio, Anthony         650.509.4876
148 Cambrault, Gerald      011.44.1344.619268
154 Cambrault, Nanette     011.44.1344.987668
110 Chen, John              515.124.4269
...
120 Weiss, Matthew         650.123.1234
200 Whalen, Jennifer       515.123.4444
149 Zlotkey, Eleni         011.44.1344.429018

```

107 rows selected.

Suppose that you must redefine `Contacts`, replacing the `Name` column with the columns `First_Name` and `Last_Name`, and adding the column `Country_Code`. Also suppose that while you are making this structural change, other users must be able to change the data in `Contacts`.

You need all features of EBR: the edition, which is always needed; the editioning view, because you are redefining a table; and crossedition triggers, because other users must be able to change data in the table while you are redefining it.

27.6.7.2 Preparing the Application to Use Editioning Views

[Example 27-9](#) (page 27-47) shows how to create the editioning view from which other users will access the table `Contacts` while you are redefining it in the new edition.

Example 27-9 *Creating an Editioning View for the Existing Table*

1. Give table a new name (so that you can give its current name to editioning view):

```
ALTER TABLE Contacts RENAME TO Contacts_Table;
```

2. (Optional) Give columns of table new names:

```
ALTER TABLE Contacts_Table
  RENAME COLUMN Name TO Name_1;

ALTER TABLE Contacts_Table
  RENAME COLUMN Phone_Number TO Phone_Number_1;
```

3. Create editioning view:

```
CREATE OR REPLACE EDITIONING VIEW Contacts AS
  SELECT
    ID              ID,
    Name_1          Name,
    Phone_Number_1 Phone_Number
  FROM Contacts_Table;
```

4. Move trigger `Contacts_BI` from table to editioning view:

```
DROP TRIGGER Contacts_BI;

CREATE TRIGGER Contacts_BI
  BEFORE INSERT ON Contacts FOR EACH ROW
  BEGIN
    :NEW.ID := Contacts_Seq.NEXTVAL;
  END;
/
```

27.6.7.3 Using EBR to Upgrade the Example Application

You can use triggers to upgrade an existing application.

The following examples show how to use triggers to updated the example application:

- [Example: Creating Edition in Which to Upgrade the Example Application](#) (page 27-48)
- [Example: Changing the Table and Replacing the Editioning View](#) (page 27-49)
- [Example: Creating and Enabling the Crossedition Triggers](#) (page 27-49)
- [Example: Applying the Transforms](#) (page 27-52)
- [Example: Viewing Data in the Changed Table](#) (page 27-52)

27.6.7.3.1 Example: Creating an Edition in Which to Upgrade the Example Application

[Example 27-10](#) (page 27-48) shows how to create an edition in which to upgrade the existing application (in [Existing Application](#) (page 27-45)), make the new edition the session edition, and check that the new edition really is the session edition.

Example 27-10 *Creating an Edition in Which to Upgrade the Example Application*

1. Create the new edition:

```
CREATE EDITION Post_Upgrade AS CHILD OF Ora$Base;
```

2. Make new edition your session edition:

```
ALTER SESSION SET EDITION = Post_Upgrade;
```

3. Check session edition:

```
SELECT  
SYS_CONTEXT('Userenv', 'Current_Edition_Name') "Current_Edition"  
FROM DUAL;
```

Result:

```
Current_Edition  
-----
```

```
POST_UPGRADE
```

```
1 row selected.
```

In the `Post_Upgrade` edition, [Example: Creating an Edition in Which to Upgrade the Example Application](#) (page 27-48) shows how to add the new columns to the physical table and recompile the trigger that was invalidated by adding the columns. Then, it shows how to replace the editioning view `Contacts` so that it selects the columns of the table by their desired logical names.

Note:

Because you will change the base table, see "[Nonblocking and Blocking DDL Statements](#) (page 8-37)."

27.6.7.3.2 Example: Changing the Table and Replacing the Editioning View

In the `Post_Upgrade` edition, [Example 27-11](#) (page 27-49) shows how to create two procedures for the forward crossedition trigger to use, create both the forward and reverse crossedition triggers in the disabled state, and enable them.

Example 27-11 *Changing the Table and Replacing the Editioning View*

1. Add new columns to physical table:

```
ALTER TABLE Contacts_Table ADD (
  First_Name_2    varchar2(20),
  Last_Name_2     varchar2(25),
  Country_Code_2  varchar2(20),
  Phone_Number_2  varchar2(20)
);
```

(This is nonblocking DDL.)

2. Recompile invalidated trigger:

```
ALTER TRIGGER Contacts_BI COMPILE REUSE SETTINGS;
```

3. Replace editioning view so that it selects replacement columns with their desired logical names:

```
CREATE OR REPLACE EDITIONING VIEW Contacts AS
SELECT
  ID                ID,
  First_Name_2      First_Name,
  Last_Name_2       Last_Name,
  Country_Code_2    Country_Code,
  Phone_Number_2    Phone_Number
FROM Contacts_Table;
```

27.6.7.3.3 Example: Creating and Enabling the Crossedition Triggers

In the `Post_Upgrade` edition, [Example 27-12](#) (page 27-49) shows how to apply the transforms.

Example 27-12 *Creating and Enabling the Crossedition Triggers*

1. Create first procedure that forward crossedition trigger uses:

```
CREATE OR REPLACE PROCEDURE Set_First_And_Last_Name (
  Name          IN  VARCHAR2,
  First_Name    OUT VARCHAR2,
  Last_Name     OUT VARCHAR2)
IS
  Comma_Pos NUMBER := INSTR(Name, ',');
BEGIN
  IF Comma_Pos IS NULL OR Comma_Pos < 2 THEN
    RAISE Program_Error;
  END IF;

  Last_Name := SUBSTR(Name, 1, Comma_Pos-1);
  Last_Name := RTRIM(Ltrim(Last_Name));

  First_Name := SUBSTR(Name, Comma_Pos+1);
  First_Name := RTRIM(LTRIM(First_Name));
END Set_First_And_Last_Name;
/
```

2. Create second procedure that forward crossedition trigger uses:

```

CREATE OR REPLACE PROCEDURE Set_Country_Code_And_Phone_No (
    Phone_Number    IN VARCHAR2,
    Country_Code    OUT VARCHAR2,
    Phone_Number_V2 OUT VARCHAR2)
IS
    Char_To_Number_Error EXCEPTION;
    PRAGMA EXCEPTION_INIT(Char_To_Number_Error, -06502);
    Bad_Phone_Number EXCEPTION;
    Nmbr VARCHAR2(30) := REPLACE(Phone_Number, '.', '-');

    FUNCTION Is_US_Number(Nmbr IN VARCHAR2)
        RETURN BOOLEAN
    IS
        Len NUMBER := LENGTH(Nmbr);
        Dash_Pos NUMBER := INSTR(Nmbr, '-');
        n PLS_INTEGER;
    BEGIN
        IF Len IS NULL OR Len <> 12 THEN
            RETURN FALSE;
        END IF;
        IF Dash_Pos IS NULL OR Dash_Pos <> 4 THEN
            RETURN FALSE;
        END IF;
        BEGIN
            n := TO_NUMBER(SUBSTR(Nmbr, 1, 3));
        EXCEPTION WHEN Char_To_Number_Error THEN
            RETURN FALSE;
        END;

        Dash_Pos := INSTR(Nmbr, '-', 5);

        IF Dash_Pos IS NULL OR Dash_Pos <> 8 THEN
            RETURN FALSE;
        END IF;

        BEGIN
            n := TO_NUMBER(SUBSTR(Nmbr, 5, 3));
        EXCEPTION WHEN Char_To_Number_Error THEN
            RETURN FALSE;
        END;

        BEGIN
            n := TO_NUMBER(SUBSTR(Nmbr, 9));
        EXCEPTION WHEN Char_To_Number_Error THEN
            RETURN FALSE;
        END;

        RETURN TRUE;
    END Is_US_Number;

    BEGIN
        IF Nmbr LIKE '011-%' THEN
            DECLARE
                Dash_Pos NUMBER := INSTR(Nmbr, '-', 5);
            BEGIN
                Country_Code := '+' || TO_NUMBER(SUBSTR(Nmbr, 5, Dash_Pos-5));
                Phone_Number_V2 := SUBSTR(Nmbr, Dash_Pos+1);
            EXCEPTION WHEN Char_To_Number_Error THEN
                raise Bad_Phone_Number;
        END;
    END;

```

```

        END;
    ELSIF Is_US_Number(Nmbr) THEN
        Country_Code := '+1';
        Phone_Number_V2 := Nmbr;
    ELSE
        RAISE Bad_Phone_Number;
    END IF;
EXCEPTION WHEN Bad_Phone_Number THEN
    Country_Code := '+0';
    Phone_Number_V2 := '000-000-0000';
END Set_Country_Code_And_Phone_No;
/

```

3. Create forward crossedition trigger in disabled state:

```

CREATE OR REPLACE TRIGGER Contacts_Fwd_Xed
BEFORE INSERT OR UPDATE ON Contacts_Table
FOR EACH ROW
FORWARD_CROSSEDITION
DISABLE
BEGIN
    Set_First_And_Last_Name(
        :NEW.Name_1,
        :NEW.First_Name_2,
        :NEW.Last_Name_2
    );
    Set_Country_Code_And_Phone_No(
        :NEW.Phone_Number_1,
        :NEW.Country_Code_2,
        :NEW.Phone_Number_2
    );
END Contacts_Fwd_Xed;
/

```

4. Enable forward crossedition trigger:

```
ALTER TRIGGER Contacts_Fwd_Xed ENABLE;
```

5. Create reverse crossedition trigger in disabled state:

```

CREATE OR REPLACE TRIGGER Contacts_Rvrs_Xed
BEFORE INSERT OR UPDATE ON Contacts_Table
FOR EACH ROW
REVERSE_CROSSEDITION
DISABLE
BEGIN
    :NEW.Name_1 := :NEW.Last_Name_2 || ', ' || :NEW.First_Name_2;
    :NEW.Phone_Number_1 :=
    CASE :New.Country_Code_2
        WHEN '+1' THEN
            REPLACE(:NEW.Phone_Number_2, '-', '.')
        ELSE
            '011.' || LTRIM(:NEW.Country_Code_2, '+') || '.' ||
            REPLACE(:NEW.Phone_Number_2, '-', '.')
    END;
END Contacts_Rvrs_Xed;
/

```

6. Enable reverse crossedition trigger:

```
ALTER TRIGGER Contacts_Rvrs_Xed ENABLE;
```

7. Wait until pending changes are either committed or rolled back:

```

DECLARE
    scn          NUMBER := NULL;
    timeout CONSTANT INTEGER := NULL;
BEGIN
    IF NOT DBMS_UTILITY.WAIT_ON_PENDING_DML(Tables => 'Contacts_Table',
                                           timeout => timeout,
                                           scn      => scn)

    THEN
        RAISE_APPLICATION_ERROR(-20000,
            'Wait_On_Pending_DML() timed out. CETs were enabled before SCN: '||SCN);
    END IF;
END;
/

```

For information about the `DBMS_UTILITY.WAIT_ON_PENDING_DML` procedure, see *Oracle Database PL/SQL Packages and Types Reference*.

27.6.7.3.4 Example: Applying the Transforms

In the `Post_Upgrade` edition, [Example 27-13](#) (page 27-52) example shows how to apply the transforms.

Example 27-13 *Applying the Transforms*

```

DECLARE
    c NUMBER := DBMS_SQL.OPEN_CURSOR();
    x NUMBER;
BEGIN
    DBMS_SQL.PARSE(
        c                => c,
        Language_Flag   => DBMS_SQL.NATIVE,
        Statement        => 'UPDATE Contacts_Table SET ID = ID',
        Apply_Crossedition_Trigger => 'Contacts_Fwd_Xed'
    );
    x := DBMS_SQL.EXECUTE(c);
    DBMS_SQL.CLOSE_CURSOR(c);
    COMMIT;
END;
/

```

27.6.7.3.5 Example: Viewing Data in the Changed Table

In the `Post_Upgrade` edition, [Example 27-14](#) (page 27-52) shows how to check that the change worked as intended. Compare [Example: Viewing Data in the Changed Table](#) (page 27-52) to [Example: Viewing Data in the Existing Table](#) (page 27-46).

Example 27-14 *Viewing Data in the Changed Table*

1. Format columns for readability:

```

COLUMN ID FORMAT 999
COLUMN Last_Name FORMAT A15
COLUMN First_Name FORMAT A15
COLUMN Country_Code FORMAT A12
COLUMN Phone_Number FORMAT A12

```

2. Query:

```

SELECT * FROM Contacts
ORDER BY Last_Name;

```

Result:

ID	FIRST_NAME	LAST_NAME	COUNTRY_CODE	PHONE_NUMBER
174	Ellen	Abel	+44	1644-429267
166	Sundar	Ande	+44	1346-629268
130	Mozhe	Atkinson	+1	650-124-6234
105	David	Austin	+1	590-423-4569
204	Hermann	Baer	+1	515-123-8888
116	Shelli	Baida	+1	515-127-4563
167	Amit	Banda	+44	1346-729268
172	Elizabeth	Bates	+44	1343-529268
192	Sarah	Bell	+1	650-501-1876
151	David	Bernstein	+44	1344-345268
129	Laura	Bissot	+1	650-124-5234
169	Harrison	Bloom	+44	1343-829268
185	Alexis	Bull	+1	650-509-2876
187	Anthony	Cabrio	+1	650-509-4876
154	Nanette	Cambrault	+44	1344-987668
148	Gerald	Cambrault	+44	1344-619268
110	John	Chen	+1	515-124-4269
	...			
120	Matthew	Weiss	+1	650-123-1234
200	Jennifer	Whalen	+1	515-123-4444
149	Eleni	Zlotkey	+44	1344-429018

107 rows selected.

If the change worked as intended, you can now follow steps [10](#) (page 27-44) through [13](#) (page 27-44) of the procedure in [Procedure for EBR Using Crossedition Triggers](#) (page 27-43).

Using Transaction Guard

Transaction Guard provides a generic tool for applications to use for at-most-once execution in case of planned and unplanned outages. Applications use the logical transaction ID to determine the commit outcome of the last transaction open in a database session following an outage. Without Transaction Guard, applications that attempt to replay operations following outages can cause logical corruption by committing duplicate transactions. Transaction Guard is used by Application Continuity for automatic and transparent transaction replay.

Transaction Guard provides these benefits:

- Preserves the returned outcome - committed or uncommitted so that it can be relied on
- Ensures a known commit outcome for every transaction
- Can be used to provide at-most-once transaction execution for applications that wish to resubmit themselves
- Is used by Application Continuity for automatic and transparent transaction replay

This chapter assumes that you are familiar with the major relevant concepts and techniques of the technology or product environment in which you are using Transaction Guard.

Topics:

- [Problem that Transaction Guard Solves](#) (page 28-2)
- [Solution that Transaction Guard Provides](#) (page 28-2)
- [Transaction Guard Concepts and Scope](#) (page 28-3)
- [Database Configuration for Transaction Guard](#) (page 28-7)
- [Developing Applications that Use Transaction Guard](#) (page 28-10)
- [Transaction Guard and Its Relationship to Application Continuity](#) (page 28-14)

See Also:

- *Oracle Database JDBC Developer's Guide* for more information about using Transaction Guard with Oracle Java Database Connectivity (JDBC)
 - *Oracle Call Interface Programmer's Guide* for more information about using Transaction Guard with OCI
-

28.1 Problem That Transaction Guard Solves

In applications without Transaction Guard, a fundamental problem for recovering applications after an outage is that the commit message that is sent back to the client is not durable. If there is a break between the client and the server, the client sees an error message indicating that the communication failed. This error does not inform the application if the submission executed any commit operations, if a procedural call completed and executed all expected commits and session state changes, or if a call failed part way through or, yet worse, is still running disconnected from the client.

Without Transaction Guard, it is impossible or extremely difficult to determine the outcome of the last commit operation, in a guaranteed and scalable manner, after a communication failure to the server. If an application must determine whether the submission to the database was committed, the application must add custom exception code to query the outcome for every possible commit point in the application. Given that a system can fail anywhere, this is almost impractical because the query must be specific to each submission. After an application is built and is in production, this is completely impractical. Moreover, a query cannot give the correct answer because the transaction could commit immediately after that query executed. Indeed, after a communication failure the server may still be running the submission not yet aware that the client has disconnected. For PL/SQL or Java in the database, for a procedural submission, there is also no record as to whether that submission ran to completion or was aborted part way through. While such a procedure may have committed, subsequent work may not have been done for the procedure.

Failing to recognize that the last submission has committed, or will commit sometime soon or has not run to completion, can lead applications that attempt to replay, thus causing duplicate transaction submissions and other forms of "logical corruption" because the software might try to reissue already persisted changes.

Without Transaction Guard, if a transaction has been started and commit has been issued, the commit message that is sent back to the client is not durable. The client is left not knowing whether the transaction committed. The transaction cannot be validly resubmitted if the nontransactional state is incorrect or if it already committed. In the absence of guaranteed commit and completion information, resubmission can lead to transactions applied more than once and in a session with the incorrect state.

28.2 Solution That Transaction Guard Provides

Effective with Oracle Database 12c Release 1 (12.1.0.1), Transaction Guard provides new, integrated tools for applications to use to achieve idempotence automatically and transparently, and in a manner that scales. Its key features are the following:

- Durability of COMMIT outcome by saving a logical transaction identifier (LTXID) at commit for all supported transaction types against the database (Oracle Database 12c Release 1 (12.1.0.1) or later). This includes idempotence for transactions executed using autocommit, from inside PL/SQL, from remote transactions, One-Phase XA transactions, and from callouts that cannot otherwise be identified using generic means.
- Use of the LTXID to support at-most-once execution semantics, such that database transactions protected by logical transaction identifiers cannot be duplicated when there are multiple copies of that transaction in flight identified by the LTXID.

- Blocking of a commit of in-flight work to ensure that regardless of the outage situation, another submission of the same transaction protected by that LTXID cannot commit.
- Identification of whether work committed at an LTXID was committed as part of a top-level call (client to server), or was embedded in a procedure (such as PL/SQL) at the server. An embedded commit state indicates that while a commit completed, the entire procedure in which the commit executed has not yet run to completion. Any work beyond the commit cannot be guaranteed to have completed until that procedure itself returns to the database engine.
- Identification of whether the database to which the commit resolution is directed is ahead of, in sync with, or behind the original submission, and rejection when there are gaps in the submission sequence of transactions from a client. It is considered an error to attempt to obtain an outcome if the server or client are not in sync on an LTXID sequence.
- A callback on the JDBC Thin client driver that fires when the LTXID changes. This can be used by higher layer applications such as WebLogic Server and third parties to maintain the current LTXID ready to use if needed.
- Namespace uniqueness across globally disparate databases and across databases that are consolidated into a Multitenant infrastructure. This includes Oracle Real Application Clusters (Oracle RAC) and RAC One, Data Guard, and Multitenant databases.
- Service name uniqueness across global databases and across databases that are consolidated into a Multitenant infrastructure. This ensures that connections are properly directed to the transaction information.

28.3 Transaction Guard Concepts and Scope

This section explains some key concepts for Transaction Guard, and what Transaction Guard covers and does not cover.

Topics:

- [Logical Transaction Identifier \(LTXID\)](#) (page 28-4)
- [At-Most-Once Execution](#) (page 28-4)
- [Transaction Guard Coverage](#) (page 28-5)
- [Transaction Guard Exclusions](#) (page 28-6)

See Also:

- *Oracle Database Concepts* for more information about how Transaction Guard works
 - *Oracle Database JDBC Developer's Guide* for more information about using Transaction Guard with Oracle Java Database Connectivity (JDBC)
-
-

28.3.1 Logical Transaction Identifier (LTXID)

Applications use a concept called the **logical transaction identifier (LTXID)** to determine the outcome of the last transaction open in a database session following an outage. The logical transaction ID is stored in the OCI session handle and in a connection object for the JDBC Thin and ODP.NET drivers. The logical transaction ID is the foundation of the at-most-once semantics.

The Transaction Guard protocol ensures that:

- Execution of each logical transaction is unique.
- Duplication is detected at supported commit time to ensure that for all commit points, the protocol must not be circumvented.
- When the transaction is committed, the logical transaction ID is persisted for the duration of the retention period for retries (default = 24 hours, maximum = 30 days).
- When obtaining the outcome, an LTXID is blocked to ensure that an earlier in-flight version of that LTXID cannot commit, by enforcing the uncommitted status. If the earlier version with the same LTXID was already committed or forced, then blocking the LTXID returns the same result.

The logical session number is automatically assigned at session establishment. It is an opaque structure that cannot be read by an application. For scalability, each LTXID carries a running number called the commit number, which is increased when a database transaction is committed for each round trip to the database. This running commit number is zero-based.

28.3.2 At-Most-Once Execution

Transaction Guard uses the logical transaction identifier (LTXID) to avoid duplicate transactions. This ability to ensure at most one execution of a transaction is referred to as *transaction idempotence*. The LTXID is persisted on commit and is reused following a rollback. During normal runtime, an LTXID is automatically held in the session at both the client and server for each database transaction. At commit, the LTXID is persisted as part of committing the transaction.

The at-most-once protocol requires that the database maintain the LTXID for the retention period agreed for replay. The default retention period is 24 hours, although you might need a shorter or longer period, conceivably even a week or longer. The longer the retention period, the longer the at-most-once check blocks an old transaction using an old LTXID from replay. The setting is available on each service. When multiple databases are involved, as is the case when using Data Guard and Active Data Guard, the LTXID is replicated to each database involved through the use of redo.

The `getLTXID` API, provided for Oracle JDBC Thin (with similar APIs for OCI, OCCI, and ODP.NET clients), lets an application retrieve the logical transaction identifier that was in use on the dead session. This is needed to determine the status of this last transaction.

The `DBMS_APP_CONT.GET_LTXID_OUTCOME` PL/SQL subprogram (described in *Oracle Database PL/SQL Packages and Types Reference*) lets an application find the outcome of an action for a specified logical transaction identifier. Calling `DBMS_APP_CONT.GET_LTXID_OUTCOME` may involve the server blocking the LTXID from committing so that the outcome is known. This is a requirement if a transaction

using that LTXID is in flight or is about to commit. An application using Transaction Guard obtains the LTXID following a recoverable error, and then calls `DBMS_APP_CONT.GET_LTXID_OUTCOME` before attempting a replay.

28.3.3 Transaction Guard Coverage

You may use Transaction Guard on each database in your system, including restarting on and failing over between single instance database, Real Application Clusters, Data Guard and Active Data Guard.

Transaction Guard is supported with the following Oracle Database 12c configurations:

- Single Instance Oracle RDBMS
- Real Application Clusters
- Data Guard
- Active Data Guard
- Multitenant including unplug/plug and for 12.2 relocates across the PDB/CDB, but excludes "with clone" option
- Global Data Services for the above database configurations

Transaction Guard supports the following transaction types against Oracle Database 12c:

- Local transactions
- Data definition language (DDL) transactions
- Data control language (DCL) transactions
- Distributed transactions
- Remote transactions
- Parallel transactions
- Commit on success (auto-commit)
- PL/SQL with embedded commit-supported client drivers
- Starting with Oracle Database 12c Release 2 (12.2.0.1), XA transactions using One Phase Optimizations including XA commit flag `TMONEPHASE` and read optimizations
- `ALTER SESSION SET Container` with Service clause, where the service uses Transaction Guard

Transaction Guard supports the following client drivers :

- 12c JDBC type 4 driver
- 12c OCI and OCCI client drivers
- 12c Oracle Data Provider for .NET (ODP.NET), Unmanaged Driver
- 12c ODP.NET, Managed Driver in ODAC 12c Release 4 or higher

28.3.4 Transaction Guard with XA Transactions

Starting with Oracle Database 12.2 Release, Transaction Guard supports XA transactions to determine the outcome of one phase transactions. Transaction Guard supports local transactions and XA transactions that use `TMONEPHASE` during the `commit` operation. When the application issues an XA transaction that uses `TMTWOPHASE`, the Transaction Guard disables itself for that transaction and automatically re-enables to prepare itself for the next transaction. This allows Transaction Guard to support the following XA transactions:

1. Local transactions that use `autocommit`
2. Local transactions that use an explicit `commit`
3. XA transactions that commit with `TMONEPHASE` flag

TP Monitors and Applications can use Transaction Guard to obtain the outcome of `commit` operation for these transaction types. Transaction Guard disables itself for externally-managed `TMTWOPHASE` commit operations and automatically re-enables for the next transaction. If the Transaction Guard APIs are used with a `TMTWOPHASE` transaction, a warning message is returned as Transaction Guard is disabled. The TP monitors own the commit outcome for `TMTWOPHASE` transactions. This functionality allows TP monitors to return an unambiguous outcome for `TMONEPHASE` operations.

28.3.5 Transaction Guard Exclusions

Transaction Guard intentionally excludes recursive transactions and autonomous transactions so that they can be re-executed.

As of Oracle Database 12c Release 2, Transaction Guard also excludes:

- Two Phase XA transactions are managed externally. When using XA transactions, Transaction Guard maintains the commit outcome for one-phase XA transactions, and silently disables itself for externally-managed two-phase transactions because this outcome is owned by the TP monitor.
- Active Data Guard with read/write database links for forwarding transactions
- Golden Gate and Logical Standby for determining the outcome when failing across logical databases. Golden Gate and Logical Standby endpoints can use Transaction Guard
- Full database import cannot be executed with Transaction Guard enabled. Use an admin service without Transaction Guard for full database imports. User and object imports are not excluded.
- TAF and Application Continuity handle Transaction Guard internally. Do not code Transaction Guard in your application in the following places:
 - A failed return from TAF
 - TAF Callback for TAF or for Application Continuity for OCI and ODP.NET
 - JDBC initialization callback for Application Continuity for Java

Transaction Guard excludes failover across databases maintained by replication technology:

- Replication to Golden Gate
- Replication to Logical Standby
- PDB clones clause (excluding PDB online relocation 12c Release 2 and later)
- All third party replication solutions

If you are using a database replica using any replication technology such as Golden Gate, or Logical Standby, or 3rd party replication, you may not use Transaction Guard between the primary and the secondary databases in this configuration.

You may use Transaction Guard on each database that participates in the replication. In this case, each database must use a different database unique identifier. Use V \$DATABASE to obtain the DBID for each database.

28.4 Database Configuration for Transaction Guard

This section contains information relevant to configuring the database for using Transaction Guard.

Topics:

- [Configuration Checklist](#) (page 28-7)
- [Transaction History Table](#) (page 28-8)
- [Service Parameters](#) (page 28-8)

28.4.1 Configuration Checklist

To use Transaction Guard with an application, you must do the following:

- Use Oracle Database 12c Release 1 (12.1.0.1) or later.
- Use an application service for all database work. Create the service using the `srvctl` command if you are using Oracle RAC, or using the `DBMS_SERVICE.CREATE_SERVICE` PL/SQL subprogram if you are not using Oracle RAC.

Do *not* use the default database services, because these services are for administration purposes and cannot be manipulated. That is, do not use a service name that is set to `db_name` or `db_unique_name`.

- Grant permission on the `DBMS_APP_CONT` package to the database users who will call `GET_LTXID_OUTCOME`:

```
GRANT EXECUTE ON DBMS_APP_CONT TO <user-name>;
```

- Increase `DDL_LOCK_TIMEOUT` if using Transaction Guard with DDL statements. See *Oracle Database Reference*, for more information about `DDL_LOCK_TIMEOUT`.

To use Transaction Guard with an application, Oracle recommends that you do the following:

- Locate and define the transaction history table for optimal performance. (The transaction history table is described in [Transaction History Table](#) (page 28-8).)
- If you are using Oracle RAC or Oracle Data Guard, ensure that FAN is configured to communicate to interrupt clients fast on error.

- Set the following parameter: `AQ_HA_NOTIFICATIONS = TRUE` (if using OCI FAN).

28.4.2 Transaction History Table

The transaction history table maintains the mapping of logical transaction identifiers (LTXIDs) to database transaction. This table can be accessed only by databases users with DBA privileges. It is maintained automatically by Oracle Database, and users must not issue DDL or DML statements directly against the transaction history table.

The transaction history table (LTXID_TRANS) is created by default in the SYSAUX tablespace at database creation and upgrade. New partitions are added when instances are added, using the storage of the last partition. However, if the location of this tablespace is not optimal for performance, the DBA can move partitions to another tablespace. For example, the following statement alters the transaction history table to move it to a tablespace named `FastPace`:

```
ALTER TABLE LTXID_TRANS move partition LTXID_TRANS_4
tablespace FastPace
storage ( initial 10G next 10G
minextents 1 maxextents 121 );
```

See Also:

- *Oracle Database SQL Language Reference* for information about the ALTER TABLE statement
-
-

28.4.3 Service Parameters

Configure the services for commit outcome and retention.

For example:

```
COMMIT_OUTCOME = TRUE
RETENTION_TIMEOUT = <retention-value>
```

COMMIT_OUTCOME determines whether transaction commit outcome is accessible after the commit has executed. This feature makes the outcome of the commit durable, and it is used by applications to enforce the status of the last transaction executed before an outage. The feature is used internally by the Oracle replay driver and by WebLogic Server, and it is available for use by other applications to determine an outcome. The COMMIT_OUTCOME possible values are FALSE (the default) and TRUE, and the value must be TRUE for Transaction Guard to be in effect.

The following considerations apply to COMMIT_OUTCOME:

- Using the `DBMS_APP_CONT.GET_LTXID_OUTCOME` PL/SQL procedure requires that COMMIT_OUTCOME be TRUE.
- COMMIT_OUTCOME has no effect on Active Data Guard and read-only databases. Using Transaction Guard with read/write Active Data Guard combined with database links that forward DMLs is not supported.
- COMMIT_OUTCOME is allowed on user-defined database services. Use on the database service is excluded because this service does not switch across Data Guard and cannot be started, stopped, or disabled for planned outages at the primary database.

RETENTION_TIMEOUT is used in conjunction with COMMIT_OUTCOME to set the amount of time that the commit outcome is retained. The retention timeout value is specified in seconds; the default is 86400 (24 hours), and the maximum is 2592000 (30 days). You can use the `srvctl` command or the `DBMS_SERVICE` PL/SQL package to specify the retention timeout value.

See Also:

- *Oracle Database Administrator's Guide* for information about the `srvctl add service` and `srvctl modify service` commands
 - *Oracle Database PL/SQL Packages and Types Reference* for information about the `DBMS_SERVICE` package.
 - *Oracle Database 2 Day + Real Application Clusters Guide* for information about configuring OCI clients for high availability
-
-

28.4.3.1 Example: Adding and Modifying a Service for a Server Pool

If you are using Oracle RAC or Oracle RAC One, then use the `srvctl` command to create and modify services.

[Example 28-1](#) (page 28-9) shows the use of `srvctl`. You can also use Global Data Services (GDSCTL).

Example 28-1 Adding and Modifying a Service for a Server Pool

```
srvctl add service -database orcl -service GOLD -poolname ora.Srvpool -
commit_outcome TRUE -retention 604800
srvctl modify service -database orcl -service GOLD -commit_outcome TRUE -retention
604800
```

28.4.3.2 Example: Adding an Administrator-Managed Service

If you are using Oracle RAC or Oracle RAC One, then use the `srvctl` command to create and modify services.

[Example 28-2](#) (page 28-9) shows the use of `srvctl`. You can also use Global Data Services (GDSCTL)

Example 28-2 Adding an Administrator-Managed Service

```
srvctl add service -database codedb -service GOLD -preferred serv1 -available serv2 -
commit_outcome TRUE -retention 604800
```

28.4.3.3 Example: Modifying a Service (PL/SQL)

If you are using a single-instance database, use the `DBMS_SERVICE.MODIFY_SERVICE` PL/SQL procedure to modify services and use FAN.

[Example 28-3](#) (page 28-9) modifies a service (but substitute the actual service name for `<service-name>`).

Example 28-3 Modifying a Service (PL/SQL)

```
DECLARE
  params dbms_service.svc_parameter_array;
BEGIN
  params('COMMIT_OUTCOME') := 'true';
```

```

params('RETENTION_TIMEOUT'):=604800;
params('aq_ha_notifications'):= 'true';
dbms_service.modify_service('<service-name>',params);
END;
/

```

28.5 Developing Applications That Use Transaction Guard

To use Transaction Guard, review the requirements and recommendations in [Configuration Checklist](#) (page 28-7), and follow these steps in the error handling when a recoverable error occurs:

Note: If you are using TAF, skip to [Transaction Guard and Transparent Application Failover](#) (page 28-12).

1. Check that the error is a recoverable error that has made the database session unavailable.
2. Acquire the LTXID from the previous failed session using the client driver provided APIs (`getLTXID` for JDBC, `OCI_ATTR_GET` with LTXID for OCI, and `LogicalTransactionId` for ODP.NET).
3. Acquire a new session with that sessions' own LTXID.
4. Invoke the `DBMS_APP_CONT.GET_LTXID_OUTCOME` PL/SQL procedure with the LTXID obtained from the API. The return state tells the driver if the last transaction was `COMMITTED` (`TRUE/FALSE`) and `USER_CALL_COMPLETED` (`TRUE/FALSE`). This PL/SQL function returns an error if the client and database are out of sync (for example, not the same database or restored database).
5. The application can return the result to the user to decide. An application can replay itself. If the replay itself incurs an outage, then the LTXID for the replaying session is used for the `DBMS_APP_CONT.GET_LTXID_OUTCOME` procedure.

28.5.1 Typical Transaction Guard Usage

The following pseudocode shows a typical usage of Transaction Guard:

```
Receive a FAN down event (or recoverable error)
```

```
FAN aborts the dead session
```

```

If recoverable error (new OCI_ATTRIBUTE for OCI, isRecoverable for JDBC)
  Get last LTXID from dead session using getLTXID or from your callback
  Obtain a new session
  Call GET_LTXID_OUTCOME with last LTXID to obtain COMMITTED and
  USER_CALL_COMPLETED status

```

```

If COMMITTED and USER_CALL_COMPLETED
  Then return result

```

```

ELSEIF COMMITTED and NOT USER_CALL_COMPLETED
  Then return result with a warning (that details such as out binds or row count
  were not returned)

```

```

ELSEIF NOT COMMITTED
  Cleanup and resubmit request, or return uncommitted result to the client

```

28.5.2 Details for Using the LTXID

For replay and returning results, the application or third party container needs access to the next LTXID to be committed at the server for each session. The LTXID can be obtained using APIs (`getLTXID` for JDBC and `OCI_ATTR_GET` with LTXID for OCI) from a failed session after a recoverable outage.

The JDBC Thin driver also provides a callback that executes on each commit number change received from the database. A third party container can use this callback to save the current LTXID in preparation to use if failover is needed. Within each session, the current LTXID is in use, so the callback can override earlier ones.

If failovers cascade without completing (that is, if during recovery from one failure, another failure occurs), the application *must* obtain and then pass the LTXID in effect on the current session into `GET_LTXID_OUTCOME`.

Table 28-1 (page 28-11) shows several conditions or situations that require some LTXID-related action, and for each the application action and next LTXID to use.

Table 28-1 LTXID Condition or Situation, Application Actions, and Next LTXID to Use

Condition or Situation	Application Action	Next LTXID to Use (Callback on LTXID Change for Containers - JDBC Thin Only)
Application receives a recoverable error and calls <code>GET_LTXID_OUTCOME</code> to determine the transaction status.	Application takes a new connection (with its own LTXID-B 0) and calls <code>GET_LTXID_OUTCOME</code> with the LTXID of the last failed session (LTXID-A).	New LTXID-B 0 Also set using the JDBC callback when registered
Application finds that the last session transaction status is <code>COMMITTED</code> and <code>USER_CALL_COMPLETED</code> .	Returns committed status to client; the application may be able to continue.	(Not applicable)
Application finds that the last session transaction status is <code>COMMITTED</code> and <code>NOT USER_CALL_COMPLETED</code> .	Returns committed status to client and exits - some applications cannot progress as the work in the call is not complete. (for example, an out bind or row count was not returned). Whether the application can continue is application dependent.	(Not applicable)
Application finds that the last session transaction status is <code>NOT COMMITTED</code> .	Application returns the result to the user, or cleans up if needed, and resubmits with the LTXID on the new session in effect, LTXID-B 0. If the new request executes any commits, server returns commit messages with LTXID-B 2 and increasing.	New LTXID-B 2 .. N Also set using the JDBC callback when registered

Table 28-1 (Cont.) LTXID Condition or Situation, Application Actions, and Next LTXID to Use

Condition or Situation	Application Action	Next LTXID to Use (Callback on LTXID Change for Containers - JDBC Thin Only)
Application receives a recoverable error if it has decided to replay.	Application takes a new connection (with LTXID-C 0) and calls <code>GET_LTXID_OUTCOME</code> with the LTXID of LAST session (LTXID-B N).	LTXID-C 0 on the new session. Also set using the JDBC callback when registered
Application receives another recoverable error if it has decided to replay.	Application takes a new connection (with LTXID-D 0) and calls <code>GET_LTXID_OUTCOME</code> again with the LTXID of LAST session (LTXID-C N).	LTXID-D 0 on the new session. Also set using the JDBC callback when registered

28.5.3 Transaction Guard and Transparent Application Failover

When Transparent Application Failover (TAF) is enabled with Transaction Guard, TAF handles the errors for developers. Do not code Transaction Guard when you are using TAF because it has embedded the Transaction Guard code starting with Oracle Database 12c Release 1 (12.1.0.1). When both TAF and Transaction Guard are used, developers can use the following TAF errors to rollback and safely resubmit, or return uncommitted.

- ORA-25402
- ORA-25408
- ORA-25405

Developers must not use `GET_LTXID_OUTCOME` procedure directly when TAF is enabled because TAF is already processing Transaction Guard.

Note:

TAF is not invoked on session failure (this includes “kill -9” at operating system level, or `ALTER SYSTEM KILL session`). TAF is invoked on the following conditions:

- `INSTANCE` failure
 - `FAN NODE DOWN` event
 - `SHUTDOWN transactional`
 - `Disconnect POST_TRANSACTION`
-

28.5.4 Using Transaction Guard with ODP.NET

The following rules apply to using Transaction Guard with ODP.NET:

- The LTXID is not available after promoting to XA in both the ODP.NET providers.
- Starting with Oracle Database 12c Release 2 (12.2.0.1), ODP.NET handles Transaction Guard for application based on its availability and handling abilities. When using ODP.NET, the LTXID is exposed to the application only when ODP.NET is unable to obtain the commit outcome on behalf of the application. For example, during an extended failover to Data Guard.
- Developers must not code Transaction Guard in the TAF callback or JDBC initialization callback. Transaction Guard is handled for you.

28.5.5 Connection-Pool LTXID Usage

Connection pools create a different use case for managing LTXIDs because connections and sessions are preestablished and shared. In the simplest model for connection pools and middle tiers, an LTXID exists on each session handle (client-side session). It is associated with an application request at check-out from the connection pool, and is disassociated from the application request at check-in back to the pool. Between check-out and check-in, the LTXID on the session is exclusively held by that application request. After check-in, the LTXID belongs to an idle, pooled session. It is associated with the next application request that checks-out that connection.

Using Transaction Guard in this way:

- Can support duplicate detection and failover for the present HTTP request
- Allows to cancel (real `Cancel` operation and not `Ctrl-C`) timed out requests, and optional re-submission by the application

28.5.6 Improved Commit Outcome for XA One Phase Optimizations

Starting with Oracle Database 12c Release 2 (12.2.0.1), Transaction Guard is used with Transaction Processing Monitors (TPM) to determine the outcome of a commit operation when using one-phase optimizations (TMONEPLHASE flag). The Transaction Guard uses the `GET_LTXID_OUTCOME` package to help the TPM to determine if the connection to the resource manager is lost or if an ambiguous error is returned.

Table 28-2 Transaction Manager Conditions/ Situations and Actions

Condition or Situation	Transaction Manager Action
Commit has not been issued, and if the transaction has rolled back.	Transaction Manager returns a <code>rollback</code> .
Commit has been issued and if an ambiguous result is returned.	Transaction Manager can use Transaction Guard (XA) to determine the outcome when the error is recoverable.
If the transaction is <code>COMMITTED</code> .	Transaction Manager returns <code>COMMITTED</code> .
If the transaction is <code>UNCOMMITTED</code> .	The Transaction Manager borrows a new connection and reissues the <code>COMMIT</code> . The original LTXID is blocked by calling <code>GET_LTXID_OUTCOME</code> .

28.5.7 Additional Requirements for Transaction Guard Development

Transaction Guard is a tool for developers to use after recoverable errors to provide a known outcome. It must be used when an error is returned indicating that the last session is dead.

The Transaction Guard APIs must *not* be used in the following cases:

- Do not use `GET_LTXID_OUTCOME` on the current session. It will return an error.
- Do not use `GET_LTXID_OUTCOME` against a session that did not receive a recoverable error—that is, a live session. It will block that session from committing.
- Do not use `GET_LTXID_OUTCOME` from a different user or to a different database. It will return an error.
- Do not obtain the LTXID and save it for use later, as opposed to using it immediately. The result of `GET_LTXID_OUTCOME` is valid only for the last open or completed transaction. If it is used with an earlier transaction on the same session, it will return an error.
- Do not code Transaction Guard if the application is using TAF. Use the new TAF error codes to return the results instead. See [Transaction Guard and Transparent Application Failover](#) (page 28-12) for more information about TAF.

Note: This rule does not apply to Application Continuity.

28.6 Transaction Guard and Its Relationship to Application Continuity

Transaction Guard provides a unique identifier (LTXID) for each database transaction. This identifier can be used to query the commit outcome of the transaction, and can also be used to ensure that the transaction is applied only once. Transaction Guard is used by Application Continuity and automatically enabled by it, but it can also be enabled independently. Transaction Guard prevents the transaction being replayed by Application Continuity from being applied more than once. If the application has implemented an application-level replay, then it requires the application to be integrated with transaction guard to provide idempotence.

For a solution that does not require coding, configure your application to use Application Continuity. For developing your own replay, the application developer codes using Transaction Guard. You can have an application coded for both Transaction Guard and Application Continuity. The Application Continuity takes effect first and the custom Transaction Guard code takes effect only when the Application Continuity is unable to replay. It is not required to use both, but, they are compatible if an application uses both Transaction Guard and Application Continuity. If an application wishes to add Transaction Guard API's in addition to Application Continuity, Transaction Guard can return the commit outcome when replay is disabled or unsuccessful.

See Also:

- *Oracle Real Application Clusters Administration and Deployment Guide* for information about Transaction Guard and Application Continuity with Oracle RAC
 - *Oracle Database JDBC Developer's Guide* for information about connecting to the database with JDBC
 - *Oracle Call Interface Programmer's Guide* for information about connecting to the database with Oracle Call Interface (OCI)
 - *Oracle Data Provider for .NET Developer's Guide for Microsoft Windows* for more information about ODP.Net Driver
-
-

Symbols

32-bit IEEE 754 format, [9-8](#)

64-bit IEEE 754 format, [9-8](#)

A

Abstract Data Type (ADT)

native floating-point data types in, [9-13](#)

resetting evolved, [27-8](#)

ACCESSIBLE BY clause

in package specification, [13-2](#)

stored subprogram and, [13-2](#)

actual object, [27-11](#)

actualization, [27-11](#)

ADDM (Automatic Database Diagnostic Monitor), [3-8](#)

address of row (rowid), [9-24](#)

administrators, restricting with Oracle Database Vault,
[5-3](#)

ADT

See Abstract Data Type (ADT)

AFTER SUSPEND trigger, [8-46](#)

agent, [23-3](#)

aggregate function, [13-1](#)

ALL_ARGUMENTS, [14-16](#)

ALL_DEPENDENCIES, [14-16](#)

ALL_ERRORS, [14-16](#)

ALL_IDENTIFIERS, [14-16](#)

ALL_STATEMENTS, [14-16](#)

altering application online

See edition-based redefinition (EBR)

analytic function, [1-8](#)

ancestor edition, [27-10](#)

ANSI data type, [9-24](#)

ANYDATA data type, [9-22](#)

ANYDATASET data type, [9-22](#)

AP (application program), [22-3](#)

application architecture, [20-2](#)

application domain index, [11-2](#)

application program (AP), [22-3](#)

application SQL, [27-28](#)

APPLYING_CROSSEDITION_TRIGGER function,
[27-31](#)

AQ (Oracle Advanced Queuing), [23-2](#)

archive

See Flashback Data Archive, [19-18](#)

ARGn data type, [9-27](#)

arithmetic operation

with datetime data type, [9-18](#)

with native floating-point data type, [9-11](#)

assignment, reported by PL/Scope, [14-6](#)

auditing

available options, [5-7](#)

unified auditing, [5-7](#)

auditing policy, editioning view and, [27-39](#)

AUTHID clause

in package specification, [13-2](#)

stored subprogram and, [13-2](#)

AUTHID property

of invoked subprogram, [13-21](#)

of PL/SQL unit, [13-4](#), [13-28](#)

auto-tuning OCI client statement cache, [3-25](#)

Automatic Database Diagnostic Monitor (ADDM), [3-8](#)

Automatic Undo Management system, [19-1](#)

Automatic Workload Repository (AWR), [3-21](#)

autonomous transaction

nonblocking DDL statement in, [8-38](#)

trigger as, [8-46](#)

B

backward compatibility

LONG and LONG RAW data types for, [9-21](#)

RESTRICT_REFERENCES pragma for, [13-32](#)

BATCH commit redo option, [8-6](#)

benchmark, [3-4](#)

binary floating-point number, [9-8](#)

binary format, [9-9](#)

binary large object (BLOB) data type, [9-20](#)

BINARY_DOUBLE data type, [9-7](#)

BINARY_FLOAT data type, [9-7](#)

BINARY_INTEGER data type

See PLS_INTEGER data type

bind variables, [4-1](#)

block, PL/SQL, [13-2](#)

blocking DDL statement, [8-37](#)

BOOLEAN data type, [13-9](#)
branch, [22-3](#)
built-in data type
 See SQL data type
built-in function
 See SQL function
bulk binding, [13-16](#)
business rule, [12-1](#)

C

C external subprogram
 callback with, [21-40](#)
 global variable in, [21-44](#)
 interface between PL/SQL and, [21-11](#)
 invoking, [21-33](#)
 loading, [21-4](#)
 passing parameter to, [21-16](#)
 publishing, [21-13](#)
 running, [21-30](#)
 service routine and, [21-34](#)
 See also external subprogram
call specification
 for external subprogram, [21-3](#)
 in package, [13-2](#)
 location of, [21-13](#)
CALL statement, [21-30](#)
calling subprogram
 See invoking subprogram
cascading invalidation, [26-5](#)
CHANGE_DUPKEY_ERROR_INDEX hint, [27-31](#)
CHAR data type, [9-5](#)
character data type class, [26-17](#)
character data types, [9-5](#)
character large object (CLOB) data type, [9-20](#)
CHECK constraint
 compared to NOT NULL constraint, [12-16](#)
 designing, [12-16](#)
 multiple, [12-16](#)
 naming, [12-18](#)
 restrictions on, [12-15](#)
 when to use, [12-15](#)
client configuration parameter, [3-20](#)
client notification, [23-3](#)
client result cache, [3-11](#)
client statement cache auto-tuning (OCI client session feature), [3-25](#)
CLIENT_RESULT_CACHE_LAG server initialization parameter, [3-20](#)
CLIENT_RESULT_CACHE_SIZE server initialization parameter, [3-19](#)
client/server architecture, [20-2](#)
CLOB data type, [9-5](#)
coarse-grained invalidation, [26-5](#)
collection
 referenced by DML statement, [13-17](#)
 referenced by FOR loop, [13-19](#)

collection (*continued*)
 referenced by SELECT statement, [13-18](#)
column
 generated, [27-5](#)
 multiple foreign key constraints on, [12-11](#)
 virtual, [27-5](#)
 when to use default value for, [12-6](#)
commit redo management, [8-6](#)
COMPATIBLE server initialization parameter, [3-19](#)
compilation parameter, [13-4](#)
composite PL/SQL data type, [13-10](#)
concurrency
 serializable transaction for, [8-29](#)
 under explicit locking, [8-19](#)
conditional compilation, [7-2](#)
connection class, [3-31](#)
connection pool, [20-15](#)
connection pools
 connection storms, [2-2](#)
 design guidelines for logins, [2-3](#)
 design guidelines, [2-1](#)
 drained, [2-4](#)
 guideline for preventing connection storms, [2-2](#)
 guidelines for preventing programmatic session leaks, [2-4](#)
 lock leaks, [2-4](#)
 logical corruption, [2-5](#)
constraint
 altering, [12-22](#)
 CHECK
 See CHECK constraint, [12-15](#)
 compared to trigger, [12-2](#)
 crossedition trigger and
 collisions, [27-31](#)
 dropping, [27-35](#)
 deferring checking of, [12-11](#)
 disabling
 effect of, [12-19](#)
 existing, [12-21](#)
 new, [12-20](#)
 reasons for, [12-19](#)
 dropping, [12-24](#)
 editioning view and, [27-24](#)
 enabling
 effect of, [12-19](#)
 existing, [12-21](#)
 new, [12-19](#)
 exception to, [12-22](#)
 FOREIGN KEY
 See FOREIGN KEY constraint, [12-8](#)
 minimizing overhead of, [12-14](#)
 naming, [12-18](#)
 on view, [12-1](#)
 PRIMARY KEY
 See PRIMARY KEY constraint, [12-7](#)
 privileges needed for defining, [12-18](#)
 referential integrity

- constraint (*continued*)
 - referential integrity (*continued*)
 - See FOREIGN KEY constraint, [12-8](#)
 - renaming, [12-23](#)
 - UNIQUE
 - See UNIQUE constraint, [12-7](#)
 - viewing definition of, [12-27](#)
 - violation of, [12-22](#)
- Continuous Query Notification (CQN)
 - example, [18-37](#)
- converting data types
 - See data type conversion
- copy-on-change strategy, [27-11](#)
- coupling, [22-3](#)
- CQ_NOTIFICATION\$_DESCRIPTOR object, [18-48](#)
- CQ_NOTIFICATION\$_QUERY object, [18-50](#)
- CQ_NOTIFICATION\$_REG_INFO object, [18-20](#)
- CQ_NOTIFICATION\$_ROW object, [18-50](#)
- CQ_NOTIFICATION\$_TABLE object, [18-49](#)
- CQN (Continuous Query Notification), [18-1](#)
- CREATE OR REPLACE optimization
 - actualization and, [27-11](#)
- CREATE_COVERAGE_TABLES procedure, [16-2](#)
- cross-session PL/SQL function result cache, [13-16](#)
- crossedition trigger
 - creating, [27-30](#)
 - displaying information about, [27-38](#)
 - dropping, [27-35](#)
 - execution of, [27-29](#)
 - forward, [27-26](#)
 - interaction with editions, [27-26](#)
 - read-only editioning view and, [27-23](#)
 - read-write editioning view and, [27-23](#)
 - reverse, [27-26](#)
 - scope of, [27-2](#)
 - sharing child cursor and, [27-38](#)
- crossedition trigger SQL
 - forward, [27-27](#)
 - reverse, [27-28](#)
- current date and time, displaying, [9-15](#)
- current edition, [27-16](#)
- cursor
 - crossedition trigger and, [27-38](#)
 - explicit, [13-11](#)
 - implicit, [13-11](#)
 - Oracle XA application and, [22-13](#)
 - schema object dependency and, [26-21](#)
 - session, [13-11](#)
- cursor variable
 - advantages of, [13-12](#)
 - disadvantages of, [13-13](#)

D

- data cartridge, [1-3](#)
- data definition language statement
 - See DDL statement

- data integrity
 - data type and, [9-2](#)
 - See also constraint
- data modeling, [3-1](#)
- data type
 - ANSI, [9-24](#)
 - BOOLEAN, [13-9](#)
 - DB2, [9-24](#)
 - dynamic, [9-22](#)
 - external, [9-1](#)
 - for character data, [9-5](#)
 - for datetime data, [9-13](#)
 - for geographic data, [9-20](#)
 - for large amount of data, [9-20](#)
 - for multimedia data, [9-20](#)
 - for numeric data, [9-7](#)
 - for spatial data, [9-20](#)
 - for XML data, [9-22](#)
 - importance of correct, [9-1](#)
 - PL/SQL, [13-8](#)
 - PLS_INTEGER, [13-9](#)
 - REF CURSOR, [13-10](#)
 - SQL, [9-1](#)
 - SQL/DS, [9-24](#)
- data type class, [26-17](#)
- data type conversion
 - of ANSI and IBM data types, [9-24](#)
 - of datetime data types, [9-18](#)
 - of native floating-point data types, [9-12](#)
- data type family
 - PL/SQL, [13-9](#)
 - SQL, [9-27](#)
- database hardening, [19-18](#)
- database logins, automated, [5-2](#)
- Database Resident Connection Pool (DRCP), [3-26](#)
- date
 - default format for, [9-15](#)
 - displaying
 - current, [9-15](#)
 - inserting, [9-16](#)
 - See also datetime data types
- datetime data type class, [26-17](#)
- datetime data types
 - arithmetic operations with, [9-18](#)
 - conversion functions for, [9-18](#)
 - importing, exporting, and comparing, [9-19](#)
- day, default value for, [9-17](#)
- DB2 data type, [9-24](#)
- DBA_STATEMENTS, [14-12](#)
- DBA_STATEMENTS.SIGNATURE, [14-15](#)
- DBA_STATEMENTS.TYPE Column, [14-13](#)
- DBA_STATEMENTS.USAGE_CONTEXT_ID, [14-14](#)
- DBA_STATEMENTS.USAGE_ID, [14-13](#)
- DBMS_APPLICATION_INFO package, [3-5](#)
- DBMS_DEBUG_JDWP, [13-37](#)
- DBMS_DEBUG_JDWP package, [13-36](#)

- DBMS_FLASHBACK package, [19-14](#)
- DBMS_FLASHBACK_ARCHIVE procedures, [19-18](#)
- DBMS_FLASHBACK.TRANSACTION_BACKOUT procedure, [19-15](#)
- DBMS_HPROF package, [15-2](#)
- DBMS_HPROF.ANALYZE, [15-21](#)
- DBMS_LOCK package, [8-27](#)
- DBMS_OUTPUT package, [13-36](#)
- DBMS_PARALLEL_EXECUTE package, [27-33](#)
- DBMS_PLSQL_CODE_COVERAGE, [16-1](#), [16-2](#)
- DBMS_SQL.RETURN_RESULT procedure, [13-15](#)
- DBMS_STATS package, [19-29](#)
- DBMS_TYPES package, [9-22](#)
- DBMS_XA package, [22-19](#)
- DDL statement
 - blocking, [8-37](#)
 - Flashback Data Archive and, [19-23](#)
 - for creating package, [13-7](#)
 - for creating subprogram, [13-7](#)
 - ineffective, [26-5](#)
 - nonblocking
 - in autonomous transaction, [8-38](#)
 - Oracle XA and, [22-30](#)
 - processing, [8-2](#)
 - that generates notification, [18-5](#)
- DDL_LOCK_TIMEOUT parameter, [8-37](#)
- deadlock, undetected, [8-27](#)
- debugging
 - compiling PL/SQL unit for, [13-37](#)
 - external subprogram, [21-43](#)
 - subprogram, [13-36](#)
 - wrap utility and, [13-37](#)
- decimal floating-point number, [9-8](#)
- default column value, [12-6](#)
- deferring constraint checks, [12-11](#)
- definer's rights, [5-4](#)
- denormal floating-point number, [9-9](#)
- dependency mode, [26-13](#)
- dependent object
 - See* schema object dependency
- dependent transaction, [19-16](#)
- DEPRECATE PRAGMA, [13-20](#)
- descendent edition, [27-10](#)
- design
 - physical, [3-2](#), [3-3](#)
- DETERMINISTIC function
 - function-based index and, [11-4](#)
 - RPC signature and, [26-15](#)
- dirty read, [8-30](#)
- disabling constraint
 - effect of, [12-19](#)
 - existing, [12-21](#)
 - new, [12-20](#)
 - reasons for, [12-19](#)
- distributed database
 - FOREIGN KEY constraint and, [12-14](#)
 - distributed database (*continued*)
 - remote dependency management and, [26-12](#)
- distributed transaction
 - remote subprogram and, [13-27](#)
- DLL (dynamic link library), [21-3](#)
- DML statement
 - bulk binding for, [13-17](#)
 - that references collection, [13-17](#)
- DML_LOCKS initialization parameter, [8-14](#)
- domain index, [11-2](#)
- double-precision IEEE 754 format, [9-8](#)
- drivers, Oracle JDBC, [20-6](#)
- DTP (X/Open Distributed Transaction architecture), [22-2](#)
- dynamic link library (DLL), [21-3](#)
- dynamic registration, [22-3](#)
- dynamic SQL
 - implicit query results and, [13-15](#)
 - RESTRICT_REFERENCES pragma and, [13-35](#)
- dynamically typed data, [9-22](#)

E

- EBR (edition-based redefinition), [27-1](#)
- edition
 - ancestor, [27-10](#)
 - creating, [27-10](#)
 - crossedition triggers and, [27-26](#)
 - current, [27-16](#)
 - descendent, [27-10](#)
 - displaying information about, [27-36](#)
 - dropping, [27-20](#)
 - enabling for user and types, [27-6](#)
 - evaluation
 - See* evaluation edition, [27-4](#)
 - leaf, [27-10](#)
 - making available
 - to all users, [27-15](#)
 - to some users, [27-15](#)
 - ora\$base, [27-2](#), [27-10](#)
 - retiring, [27-20](#)
 - root, [27-10](#)
 - scope of, [27-2](#)
 - session, [27-16](#)
 - unusable
 - See* unusable edition, [27-4](#)
 - visibility of trigger in, [27-26](#)
- edition-based redefinition (EBR), [27-1](#)
- EDITIONABLE property, [27-8](#)
- editionable schema object type, [27-5](#)
- editioned object
 - creating or replacing, [27-9](#)
 - name resolution and, [27-3](#)
- editioning view
 - auditing policy and, [27-39](#)
 - changing base table of, [27-24](#)

- editioning view (*continued*)
 - changing writability of, [27-24](#)
 - covering table with, [27-39](#)
 - creating, [27-23](#)
 - displaying information about, [27-37](#)
 - partition-extended name for, [27-24](#)
 - preparing application for, [27-39](#)
 - read-only, [27-23](#)
 - read-write, [27-23](#)
 - replacing, [27-24](#)
 - scope of, [27-2](#)
 - SQL optimizer hint and, [27-25](#)
- Electronic Product Code (EPC), [25-24](#)
- embedded PL/SQL gateway
 - how to use, [17-5](#)
- enabling constraint
 - effect of, [12-19](#)
 - existing, [12-21](#)
 - new, [12-19](#)
- enabling editions, [27-6](#)
- encoding scheme, adding, [25-14](#)
- environment, programming, [20-1](#)
- EPC (Electronic Product Code), [25-24](#)
- evaluation edition
 - dropping edition and, [27-21](#)
 - for materialized view, [27-4](#)
 - for virtual column, [27-5](#)
 - retiring edition and, [27-20](#)
- exception
 - IEEE 754 standard
 - not raised, [9-10](#)
 - raised during conversion, [9-12](#)
 - in multilanguage program, [21-33](#)
 - to constraint, [12-22](#)
- exception handling
 - for storage allocation error, [8-45](#)
- EXCLUSIVE MODE option of LOCK TABLE
 - statement, [8-18](#)
- EXECUTE privilege, [13-7](#)
- execution plan
 - data type and, [9-3](#)
- EXPLAIN PLAN statement, [3-7](#)
- explicit cursor, [13-11](#)
- EXPR data type, [9-27](#)
- expression
 - index built on
 - See* function-based index, [11-2](#)
 - regular
 - See* regular expression, [10-1](#)
- extensibility, [1-2](#)
- external data type, [9-1](#)
- external large object (BFILE) data type, [9-20](#)
- external subprogram
 - call specification for, [21-3](#)
 - debugging, [21-43](#)
 - loading, [21-4](#)
 - managing for applications, [5-6](#)

- external subprogram (*continued*)
 - publishing, [21-9](#)
- external transaction manager, [22-3](#)

F

- family of data types
 - PL/SQL, [13-9](#)
 - SQL, [9-27](#)
- FAN event, load balancing advisory, [2-8](#)
- Fast Application Notification (FAN), [2-5](#)
- fine-grained access control, [5-3](#)
- fine-grained auditing (FGA) policy, editioning view
 - and, [27-39](#)
- fine-grained invalidation, [26-5](#)
- firing order of triggers, [27-28](#)
- FIXED_DATE initialization parameter, [9-15](#)
- fixed-point data type, [9-7](#)
- Flashback Data Archive, [19-18](#)
- Flashback Transaction, [19-15](#)
- FLOAT data type, [9-7](#)
- floating-point data type
 - range and precision of, [9-8](#)
 - See also* native floating-point data type
- floating-point number
 - binary, [9-8](#)
 - components of, [9-8](#)
 - decimal, [9-8](#)
 - denormal, [9-9](#)
 - format of, [9-8](#)
 - rounding, [9-8](#)
 - subnormal, [9-9](#)
- FOR loop
 - bulk binding for, [13-19](#)
 - that references collection, [13-19](#)
- FORCE option of ALTER USER statement, [27-7](#)
- FOREIGN KEY constraint
 - distributed databases and, [12-14](#)
 - dropping, [12-24](#)
 - editioned view and, [27-10](#)
 - enabling, [12-25](#)
 - Flashback Transaction and, [19-16](#)
 - indexing, [12-14](#)
 - multiple, [12-11](#)
 - naming, [12-18](#)
 - NOT NULL constraint on, [12-10](#)
 - NULL value and, [12-10](#)
 - privileges needed to create, [12-26](#)
 - referential integrity enforced by, [12-26](#)
 - UNIQUE constraint on, [12-10](#)
 - without other constraints, [12-10](#)
- foreign key dependency, [19-16](#)
- forward compatibility, [1-2](#)
- forward crossedition trigger, [27-26](#)
- forward crossedition trigger SQL, [27-27](#)
- function

function (*continued*)

- aggregate, [13-1](#)
- analytic, [1-8](#)
- built-in
 - See SQL function, [9-26](#)
- DETERMINISTIC
 - function-based index and, [11-4](#)
 - RPC signature and, [26-15](#)
- invoking from SQL statement, [13-28](#)
- MGD_ID ADT, [25-11](#)
- OCI or OCCL, [20-21](#)
- PARALLEL_ENABLE, RPC signature and, [26-15](#)
- PL/SQL, invoked by SQL statement, [13-28](#)
- purity of
 - RPC signature and, [26-15](#)
- result-cached, [13-16](#)
- returning large amount of data from, [13-16](#)
- SQL
 - See SQL function, [9-18](#)
 - SQL analytic, [1-8](#)
 - See also subprogram

function result cache, [13-16](#)

function-based index

- example for faster case-insensitive searches, [11-7](#)
- example for object columns, [11-6](#)
- example for precomputing arithmetic expressions, [11-5](#)
- optimizer and, [11-2, 11-3](#)

G

generated column, [27-5](#)

Geographic Information System (GIS) data, [9-20](#)

GET_LTXID_OUTCOME procedure, [8-10](#)

global transaction, [22-3](#)

global variable, in C external subprogram, [21-44](#)

greedy operator in regular expression, [10-5](#)

group commit, [8-6](#)

H

hierarchical profiler, [15-1](#)

historical data, importing and exporting, [19-18](#)

host language, [20-15](#)

host program, [20-15](#)

hot rollover, [27-1](#)

I

IA-32 and IA-64 instruction set architecture, [9-11](#)

IBM CICS, [22-3](#)

IBM Transarc Encina, [22-3](#)

Identity Code Package, [25-1](#)

IEEE 754 standard

- exception
 - not raised, [9-10](#)

IEEE 754 standard (*continued*)

- exception (*continued*)
 - raised during conversion, [9-12](#)
 - special values supported by, [9-10](#)
 - See also native floating-point data type

IGNORE_ROW_ON_DUPKEY_INDEX hint, [27-31](#)

IMMEDIATE commit redo option, [8-6](#)

implementing database application, [3-3](#)

implicit cursor, [13-11](#)

in-flight transaction, [8-8](#)

independent transaction

- See autonomous transaction

index

- domain, [11-2](#)
- edition-based redefinition and, [27-24](#)
- function-based
 - See function-based index, [11-2](#)
 - on MGD_ID column, [25-10](#)

infinity, [9-10](#)

INHERIT ANY PRIVILEGES system privilege, [5-5](#)

INHERIT PRIVILEGES privilege, [5-5](#)

inherited object, [27-11](#)

initialization parameter

- DML_LOCKS, [8-14](#)
- FIXED_DATE, [9-15](#)
- NLS_DATE_FORMAT, [9-15](#)

instrumentation, [4-2](#)

integer data type class, [26-17](#)

integrity constraint

- See constraint

integrity of data

- See data integrity

interface

- between PL/SQL and C, [21-11](#)
- between PL/SQL and Java, [21-10](#)
- program, [20-3](#)
- TX, [22-3](#)
- user
 - stateful or stateless, [20-3](#)
 - See also Oracle C++ Call Interface

invalidation

- cascading, [26-5](#)
- coarse-grained, [26-5](#)
- fine-grained, [26-5](#)
- of dependent object, [26-5](#)
- of package, [13-38](#)

invoker's rights

- affect on invoker's privileges, [5-5](#)
- Java stored procedures, [5-6](#)

invoking subprogram

- from subprogram, [13-24](#)
- from trigger, [13-24](#)
- interactively from Oracle Database tools, [13-22](#)
- through embedded PL/SQL gateway, [17-19](#)

isolation level

- See transaction isolation level

iterative data processing

iterative data processing (*continued*)
about, [4-3](#)
arrays, [4-5](#)
manual parallelism, [4-6](#)
row by row, [4-3](#)

J

Java class method
calling, [21-32](#)
interface between PL/SQL and, [21-10](#)
publishing, [21-12](#)
See also external subprogram
Java Database Connectivity
See Oracle JDBC
Java language
compared to PL/SQL, [20-13](#)
Oracle Database support for, [20-4](#)
Java stored procedures, [5-6](#)
Java Virtual Machine
See Oracle JVM
JDBC
See Oracle JDBC
JVM
See Oracle JVM

K

key
foreign
See FOREIGN KEY constraint, [12-8](#)
primary
See PRIMARY KEY constraint, [12-7](#)
unique
See UNIQUE constraint, [12-7](#)

L

Large Object (LOB), [9-20](#)
leaf edition, [27-10](#)
LGWR (log writer process), [8-6](#)
lightweight queue, [23-3](#)
live operation, [27-1](#)
load balancing advisory FAN event, [2-8](#)
LOB
See Large Object (LOB)
LOCK TABLE statement
SELECT FOR UPDATE statement with, [8-19](#)
locking row explicitly, [8-18](#)
locking table
explicitly, [8-14](#)
implicitly, [8-18](#)
log writer process (LGWR), [8-6](#)
logical design, [3-2](#)
logical transaction identifier (LTXID), [8-8](#)
logical value, [13-9](#)
LONG and LONG RAW data types, [9-21](#)
LONG data type, [9-5](#)

loose coupling, [22-3](#)
LTXID (logical transaction identifier), [8-8](#)

M

main transaction, [8-38](#)
maintaining database and application, [3-4](#)
managing default rights, [5-6](#)
materialized view
that depends on editioned object, [27-4](#)
maximum availability of table, [27-23](#)
memory advisor, [3-9](#)
metacharacter in regular expression, [10-1](#)
metadata for SQL operator or function, [9-26](#)
metrics, [3-4](#)
MGD_ID ADT, [25-1](#)
MGD_ID database ADT function, [25-11](#)
mod_plsql module, [17-2](#)
mode
dependency, [26-13](#)
lock, [8-15](#)
serialized
See serializable transaction, [8-29](#)
MODIFY CONSTRAINT clause of ALTER TABLE
statement, [12-22](#)
modifying
See altering
monitoring database performance, [3-8](#)
multilanguage program
error or exception in, [21-33](#)
multiline mode, [10-2](#)
multilingual data, [10-8](#)
multimedia data, [9-20](#)

N

name resolution
editions and, [27-3](#)
NaN (not a number), [9-10](#)
national character large object (NCLOB) data type,
[9-20](#)
native execution, [13-21](#)
native floating-point data type
arithmetic operation with, [9-11](#)
binary format for, [9-9](#)
conversion functions for, [9-12](#)
in client interfaces, [9-13](#)
special values for, [9-10](#)
NCHAR data type, [9-5](#)
NCLOB data type, [9-5](#)
negative infinity, [9-10](#)
negative zero, [9-10](#)
nested subprogram, [13-2](#)
NLS_DATE_FORMAT initialization parameter, [9-15](#)
NO_RESULT_CACHE hint, [3-14](#)
nonblocking DDL statement
in autonomous transaction, [8-38](#)

NONEDITIONABLE property, [27-8](#)
 noneditionable schema object type, [27-5](#)
 noneditioned object
 creating or replacing, [27-9](#)
 name resolution and, [27-3](#)
 that can depend on editioned object
 dropping edition and, [27-21](#)
 FORCE and, [27-7](#)
 nongreedy operator in regular expression, [10-9](#)
 nonpersistent queue, [23-3](#)
 normalized significand, [9-9](#)
 NOT NULL
 See NOT NULL constraint, [12-5](#)
 NOT NULL constraint
 compared to CHECK constraint, [12-16](#)
 naming, [12-18](#)
 on FOREIGN KEY constraint, [12-10](#)
 when to use, [12-5](#)
 NOWAIT commit redo option, [8-6](#)
 NOWAIT option of LOCK TABLE statement, [8-15](#)
 NULL value
 FOREIGN KEY constraint and, [12-10](#)
 function-based index and, [11-2](#)
 indexing and, [12-5](#)
 NUMBER data type, [9-7](#)
 number data type class, [26-17](#)
 numeric data types, [9-7](#)
 NVARCHAR2 data type, [9-5](#)

O

object
 actual, [27-11](#)
 dependent
 See schema object dependency, [26-1](#)
 editioned
 See editioned object, [27-2](#)
 inherited, [27-11](#)
 large
 See Large Object (LOB), [9-20](#)
 noneditioned
 See noneditioned object, [27-2](#)
 potentially editioned
 with noneditioned dependents, [27-7](#)
 referenced
 See schema object dependency, [26-1](#)
 size limit for PL/SQL stored, [13-8](#)
 object change notification, [18-2](#)
 OCCI
 See Oracle C++ Call Interface
 OCI
 See Oracle Call Interface
 OCI_ATTR_CHDES_DBNAME, [18-35](#)
 OCI_ATTR_CHDES_NFTYPE, [18-35](#)
 OCI_ATTR_CHDES_TABLE_CHANGES, [18-35](#)
 OCI_ATTR_CHDES_TABLE_NAME, [18-36](#)
 OCI_ATTR_CHDES_TABLE_OPFLAGS, [18-36](#)

OCI_ATTR_CHDES_TABLE_ROW_CHANGES, [18-36](#)
 OCI_ATTR_CHDES_XID, [18-35](#)
 OCI_ATTR_CHNF_CHANGELAG, [18-33](#)
 OCI_ATTR_CHNF_ROWIDS, [18-33](#)
 OCI_ATTR_CQ_QUERYID, [18-35](#)
 OCI_ATTR_CQDES_OPERATION, [18-36](#)
 OCI_ATTR_CQDES_QUERYID, [18-36](#)
 OCI_ATTR_CQDES_TABLE_CHANGES, [18-36](#)
 OCI_ATTR_SESSION_STATE attribute, [3-36](#)
 OCI_ATTR_SUBSCR_CALLBACK, [18-33](#)
 OCI_ATTR_SUBSCR_CQ_CHNF_QOSFLAGS, [18-33](#)
 OCI_ATTR_SUBSCR_TIMEOUT, [18-33](#)
 OCI_DTYPE_CQDES, [18-36](#)
 OCI_SESSGET_PURITY_NEW attribute, [3-30](#)
 OCI_SESSGET_PURITY_SELF attribute, [3-30](#)
 OCI_SESSION_STATELESS attribute, [3-36](#)
 OCI_SUBSCR_QOS_PURGE_ON_NTFN, [18-33](#)
 OCIAnyData and OCIAnyDataSet interfaces, [9-22](#)
 ODP.NET, [20-23](#)
 online application upgrade
 See edition-based redefinition (EBR)
 operator
 in regular expression
 greedy, [10-5](#)
 nongreedy, [10-9](#)
 metadata for, [9-26](#)
 optimizer
 editioning view and, [27-25](#)
 function-based index and, [11-2](#), [11-3](#)
 RPC signature and, [26-15](#)
 ORA_SDZ system variable
 effect of setting, [24-43](#)
 ora\$base edition, [27-2](#), [27-10](#)
 Oracle Advanced Queuing (AQ), [23-2](#)
 Oracle C++ Call Interface
 building application with, [20-22](#)
 kinds of functions in, [20-21](#)
 native floating-point data types in, [9-13](#)
 procedural and nonprocedural elements of, [20-21](#)
 Oracle Call Interface
 building application with, [20-22](#)
 commit redo action in, [8-6](#)
 compared to precompiler, [20-22](#)
 kinds of functions in, [20-21](#)
 native floating-point data types in, [9-13](#)
 procedural and nonprocedural elements of, [20-21](#)
 with Oracle XA, [22-15](#)
 Oracle Data Provider for .NET, [20-23](#)
 Oracle Data Redaction, [5-3](#)
 Oracle data type
 See SQL data type
 Oracle Database Tuning Pack, [3-9](#)
 Oracle Database Vault, [5-3](#)
 Oracle Extensibility Architecture framework, user-defined aggregate functions and, [1-3](#)
 Oracle Extensibility Architecture, data cartridges and, [1-3](#)

- Oracle Flashback Query, [19-7](#)
- Oracle Flashback Technology
 - application development features, [19-2](#)
 - configuring database for, [19-4](#)
 - database administration features, [19-3](#)
 - performance guidelines for, [19-29](#)
- Oracle Flashback Transaction Query, [19-11](#)
- Oracle Flashback Version Query, [19-9](#)
- Oracle JDBC
 - compared to Oracle SQLJ, [20-11](#)
 - native floating-point data types in, [9-13](#)
 - sample program
 - 2.0, [20-8](#)
 - pre-2.0, [20-8](#)
- Oracle JDeveloper, Oracle SQLJ and, [20-11](#)
- Oracle JVM, [20-5](#)
- Oracle Label Security, [5-3](#)
- Oracle Lock Management services, [8-27](#)
- Oracle Multimedia, [9-20](#)
- Oracle Real Application Clusters (Oracle RAC)
 - client result cache and, [3-19](#)
 - DRCP and, [3-37](#)
 - load balancing advisory FAN events and, [2-8](#)
 - Oracle XA and, [22-25](#)
 - runtime connection load balancing and, [2-5](#)
- Oracle SQLJ
 - compared to Oracle JDBC, [20-11](#)
 - Oracle JDeveloper and, [20-11](#)
- Oracle Text, [9-22](#)
- Oracle Total Recall, [19-18](#)
- Oracle Tuxedo, [22-3](#)
- Oracle Virtual Private Database (VPD)
 - editioning view and, [27-39](#)
- Oracle XA
 - Oracle RAC and, [22-25](#)
 - subprograms, [22-6](#)
 - when to use, [22-1](#)
- out-of-space error, [8-45](#)
- overloaded subprogram, [13-2](#)

P

- package
 - creating, [13-7](#)
 - dropping, [13-20](#)
 - invalidation of, [13-38](#)
 - session state and, [26-9](#)
 - size limit for, [13-8](#)
 - synonym for, [13-26](#)
- package body, [13-2](#)
- package invalidation and, [13-38](#)
- package specification, [13-2](#)
- package subprogram, [13-2](#)
- PARALLEL_ENABLE function
 - RPC signature and, [26-15](#)
- parallelized SQL statement, [13-32](#)

- parameter
 - compilation
 - See compilation parameter, [13-4](#)
 - initialization, [13-4](#)
- partition-extended editioning view name, [27-24](#)
- partitioning, [1-10](#)
- performance, [3-1](#)
- performance goals, [3-4](#)
- performance testing, [3-10](#)
- performance, data type and, [9-3](#)
- persistent LOB instance, [9-20](#)
- persistent queue, [23-3](#)
- phantom read, [8-30](#)
- physical design, [3-3](#)
- PL/Scope, [13-36](#), [14-1](#)
- PL/Scope security model, [14-2](#)
- PL/Scope tool, [14-1](#)
- PL/SQL block, [13-2](#)
- PL/SQL data type, [13-8](#)
- PL/SQL function result cache, [13-16](#)
- PL/SQL gateway, [17-2](#)
- PL/SQL hierarchical profiler, [15-1](#)
- PL/SQL Hierarchical Profiler, [13-36](#)
- PL/SQL language
 - compared to Java, [20-13](#)
- PL/SQL object
 - See PL/SQL unit
- PL/SQL optimize level, [13-4](#)
- PL/SQL optimizer level, [7-2](#)
- PL/SQL unit
 - compiling for debugging, [13-37](#)
 - CREATE OR REPLACE and, [26-5](#)
- PL/SQL Web Toolkit, [17-3](#)
- PLS_INTEGER data type, [13-9](#)
- plshprof utility, [15-15](#)
- PLSQL_CODE_COVERAGE package, [16-2](#)
- pool, connection, [20-15](#)
- positive infinity, [9-10](#)
- positive zero, [9-10](#)
- POSIX standard for regular expressions
 - operators defined in, [10-5](#)
 - Oracle SQL and, [10-4](#)
 - Oracle SQL multilingual extensions to, [10-8](#)
 - Oracle SQL PERL-influenced extensions to, [10-9](#)
- potentially editioned object
 - with noneditioned dependents, [27-7](#)
- precompiler
 - compared to Oracle Call Interface, [20-22](#)
 - Oracle XA and, [22-13](#)
- PRIMARY KEY constraint
 - dropping, [12-24](#)
 - Flashback Transaction and, [19-16](#)
 - naming, [12-18](#)
- primary key dependency, [19-16](#)
- privileges
 - for debugging subprogram, [13-37](#)

- privileges (*continued*)
 - for defining constraint, [12-18](#)
 - for Oracle Flashback Technology, [19-6](#)
 - for running subprogram, [13-22](#)
 - granting secure application roles, [5-1](#)
 - grouped into roles, [5-1](#)
 - INHERIT ANY PRIVILEGES system privilege, [5-5](#)
 - INHERIT PRIVILEGES privilege, [5-5](#)
 - revoked, object dependency and, [26-9](#)
- Pro*C/C++ precompiler
 - native floating-point data types in, [9-13](#)
- Pro*COBOL precompiler, [20-18](#)
- procedure, [13-2](#)
 - See also* subprogram
- product code, [25-23](#)
- profiler, [15-1](#)
- program interface, [20-3](#)
- programming environment, [20-1](#)
- public information, required, [22-5](#)
- publish-subscribe model, [23-1](#)
- purity of function
 - RPC signature and, [26-15](#)

Q

- quality-of-service flag, [18-20](#)
- query
 - registering for Continuous Query Notification, [18-10](#)
 - returning results to client implicitly, [13-15](#)
- Query Result Change Notification (QRCN), [18-2](#)
- query rewrite, [1-9](#)
- queue, [23-3](#)

R

- Radio Frequency Identification (RFID) technology, [25-23](#)
- RAW data type, [9-21](#)
- raw data type class, [26-17](#)
- READ COMMITTED transaction isolation level
 - compared to SERIALIZABLE, [8-36](#)
 - in Oracle Database, [8-30](#)
 - transaction interactions with, [8-30](#)
- read consistency
 - statement-level, [8-13](#)
 - transaction-level
 - locking tables explicitly for, [8-14](#)
 - read-only transaction for, [8-13](#)
- read lock, [8-33](#)
- READ UNCOMMITTED transaction isolation level
 - in Oracle Database, [8-30](#)
 - transaction interactions with, [8-30](#)
- read-only editioning view, [27-23](#)
- read-only transaction, [8-13](#)
- read-write editioning view, [27-23](#)

- record, [13-10](#)
- redefinition, edition-based (EBR), [27-1](#)
- redo information for transaction, [8-6](#)
- redo management, [8-6](#)
- REF CURSOR data type, [13-10](#)
- referenced object
 - See* schema object dependency
- referential integrity
 - serializable transactions and, [8-33](#)
 - trigger for enforcing, [8-33](#)
- referential integrity constraint
 - See* FOREIGN KEY constraint
- REGEXP_COUNT function, [10-2](#)
- REGEXP_INSTR function, [10-2](#)
- REGEXP_LIKE condition, [10-2](#)
- REGEXP_REPLACE function
 - back reference operator in, [10-5](#)
- REGEXP_SUBSTR function, [10-2](#)
- registration
 - dynamic, [22-3](#)
 - for Continuous Query Notification, [18-10](#)
 - in publish-subscribe model, [23-3](#)
 - static, [22-3](#)
- regular expression
 - in Oracle SQL, [10-2](#)
 - in SQL statement, [10-11](#)
 - metacharacter in, [10-1](#)
 - POSIX standard and
 - See* POSIX standard for regular expressions, [10-4](#)
 - Unicode and, [10-4](#)
- remote dependency management, [26-12](#)
- remote procedure call dependency management, [26-13](#)
- remote subprogram, [13-25](#)
- repeatable read
 - locking tables explicitly for, [8-14](#)
 - read-only transaction for, [8-13](#)
- REPEATABLE READ transaction isolation level
 - in Oracle Database, [8-30](#)
 - transaction interactions with, [8-30](#)
- required public information, [22-5](#)
- resource manager (RM), [22-3](#)
- RESTRICT_REFERENCES pragma
 - for backward compatibility, [13-32](#)
 - static and dynamic SQL and, [13-35](#)
- result cache, [13-16](#)
- RESULT_CACHE hint, [3-14](#)
- RESULT_CACHE_MODE session parameter, [3-15](#)
- resumable storage allocation, [8-45](#)
- RETENTION GUARANTEE clause for undo
 - tables, [19-4](#)
- RETENTION option of ALTER TABLE statement, [19-5](#)
- RETURN_RESULT procedure, [13-15](#)
- reverse crossedition trigger, [27-26](#)
- reverse crossedition trigger SQL, [27-28](#)

RFID (Radio Frequency Identification) technology, 25-23

RM (resource manager), 22-3

roles, 5-1

root edition, 27-10

rounding floating-point numbers, 9-8

row

- address of (rowid), 9-24
- locking explicitly, 8-18

ROW EXCLUSIVE MODE option of LOCK TABLE statement, 8-16

ROW SHARE MODE option of LOCK TABLE statement, 8-16

rowid, 9-24

ROWID data type

- ROWID pseudocolumn and, 9-24

ROWID pseudocolumn

- CQN and, 18-12
- See also* rowid

RPC dependency management

- RPC signature and, 26-15

RR datetime format element, 9-15

rule on queue, 23-3

rules engine, 23-3

runtime connection load balancing, 2-5

runtime error

- See* exception

S

scalability, 3-1

scalar PL/SQL data type, 13-9

schema object dependency

- in distributed database, 26-12
- invalidation and, 26-5
- on nonexistence of other objects, 26-11
- revoked privileges and, 26-9
- shared pool and, 26-21

schema object type

- editionable, 27-5
- enabling for editions, 27-6
- noneditionable, 27-5

searchable text, 9-22

secure application roles, 5-1

security

- auditing, 5-7
- external procedures for applications, 5-6
- invoker's rights and definer's rights, 5-4
- Java stored procedures default rights, 5-6
- logon triggers and, 5-2
- Oracle Data Redaction, 5-3
- Oracle Database Vault, 5-3
- Oracle Label Security, 5-3
- Oracle Virtual Private Database, 5-3
- privilege use, 5-1
- privileges of invoking user, 5-5
- role use, 5-1

security (*continued*)

- secure application roles, 5-1

SELECT FOR UPDATE statement

- LOCK TABLE statement with, 8-19
- referential integrity and
 - inside trigger, 8-33
 - outside trigger, 8-33

SELECT statement

- bulk binding for, 13-18
- referencing collection with, 13-18
- with AS OF clause, 19-7
- with FOR UPDATE clause
 - See* SELECT FOR UPDATE statement, 8-18
- with VERSIONS BETWEEN clause, 19-9

semi-available table, 27-23

serendipitous change

- data transformation collisions and, 27-31
- identifying, 27-31

serializable transaction

- for concurrency control, 8-29
- interaction with, 8-30
- referential integrity and, 8-33

SERIALIZABLE transaction isolation level

- compared to READ COMMITTED, 8-36
- in Oracle Database, 8-30
- transaction interactions with, 8-30
- See also* serializable transaction

server-side programming, 20-2

service routine, C external subprogram and, 21-34

session cursor, 13-11

session edition, 27-16

session purity, 3-30

session state, 26-9

session variable, 13-22

set based processing, 4-9

SET CONSTRAINTS statement, 12-11

SET TRANSACTION statement with READ ONLY option, 8-13

Setting ORA_SDTZ system variable

- effect of, 24-43

SHARE MODE option of LOCK TABLE statement, 8-16

SHARE ROW EXCLUSIVE MODE option of LOCK TABLE statement, 8-17

shared SQL area, 8-4

side effects of subprogram, 13-30

signature checking, 26-12

single-precision IEEE 754 format, 9-8

spatial data, 9-20

specification, package

- See* package specification

SQL Access Advisor, 3-9

SQL advisor, 3-9

SQL analytic function, 1-8

SQL area, shared, 8-4

SQL data type, 9-1

SQL function

- SQL function (*continued*)
 - analytic, [1-8](#)
 - display type of, [9-27](#)
 - for data type conversion, [9-18](#)
 - metadata for, [9-26](#)
- SQL optimizer hint and editioning view, [27-25](#)
- SQL statement
 - application, [27-28](#)
 - crossedition trigger
 - forward, [27-27](#)
 - reverse, [27-28](#)
 - invoking PL/SQL function from, [13-28](#)
 - parallelized, [13-32](#)
 - processing
 - DDL statement, [8-2](#)
 - stages of, [8-1](#)
 - system management statement, [8-2](#)
- SQL Trace facility (SQL_TRACE), [3-6](#)
- SQL Tuning Advisor, [3-9](#)
- SQL, dynamic
 - See* dynamic SQL
- SQL/DS data type, [9-24](#)
- SQLJ
 - See* Oracle SQLJ
- standalone subprogram, [13-2](#)
- state
 - session, [26-9](#)
 - user interface and, [20-3](#)
 - web application and, [17-27](#)
- stateful session, [3-36](#)
- stateless session, [3-36](#)
- statement
 - See* SQL statement
- statement caching, [3-24](#)
- statement-level read consistency, [8-13](#), [8-14](#)
- static pools
 - used to prevent connection storms, [2-2](#)
- static registration, [22-3](#)
- static SQL, RESTRICT_REFERENCES pragma and, [13-35](#)
- static variable, in C external subprogram, [21-44](#)
- statistics
 - for application, [15-1](#)
 - for identifier, [14-1](#)
- storage allocation error, [8-45](#)
- storage requirements, decreasing, [9-2](#)
- stored standalone subprogram, dropping, [13-20](#)
- stored subprogram, [13-2](#)
- subnormal floating-point number, [9-9](#)
- subprogram
 - creating, [13-7](#)
 - external
 - See* external subprogram, [21-1](#)
 - invoking
 - See* invoking subprogram, [13-21](#)
 - Oracle XA, [22-6](#)
 - overloaded, [13-2](#)

- subprogram (*continued*)
 - privileges needed to debug, [13-37](#)
 - privileges needed to run, [13-22](#)
 - remote, [13-25](#)
 - size limit for, [13-8](#)
 - synonym for, [13-26](#)
- subscriber, [23-3](#)
- subscription services, [23-3](#)
- subtype
 - user-defined, [13-10](#)
- synonym
 - CREATE OR REPLACE and, [26-5](#)
 - for package, [13-26](#)
 - for subprogram, [13-26](#)
- SYSDATE function, [9-15](#)
- system management statement, [8-2](#)

T

- table
 - controlling user access to, [5-3](#)
 - locking
 - choosing strategy for, [8-15](#)
 - explicitly, [8-14](#)
 - implicitly, [8-18](#)
 - with maximum availability, [27-23](#)
 - with semi-availability, [27-23](#)
- table annotation, [3-15](#)
- table result cache mode
 - annotation, [3-15](#)
 - effective
 - determining, [3-16](#)
 - displaying, [3-16](#)
- Tag Data Translation Markup Language Schema, [25-1](#)
- Temporal Validity Support, [1-11](#)
- temporary LOB instance, [9-20](#)
- thin client configuration, [20-2](#)
- thread-safe application, [22-18](#)
- three-tier architecture, [20-2](#)
- tight coupling, [22-3](#)
- time
 - default value for, [9-17](#)
 - displaying
 - current, [9-15](#)
 - inserting, [9-17](#)
 - See also* datetime data types
- time-stamp checking, [26-12](#)
- time-stamp dependency mode, [26-14](#)
- TIMESTAMP WITH LOCAL TIME ZONE
 - examples, [24-41](#)
- TIMESTAMP WITH TIME ZONE
 - examples, [24-41](#)
- TM (transaction manager), [22-3](#)
- TPM (transaction processing monitor), [22-3](#)
- tracing tools, [13-1](#)
- transaction
 - autonomous

transaction (*continued*)
 autonomous (*continued*)
 trigger as, 8-46
 choosing isolation level for, 8-36
 dependent, 19-16
 determining outcome after outage, 8-8
 distributed
 remote subprogram and, 13-27
 ensuring idempotence of, 8-8
 global, 22-3
 grouping operations into, 8-4
 improving performance of, 8-5
 in-flight, 8-8
 main, 8-38
 read-only, 8-13
 redo entry for, 8-6
 serializable
 See serializable transaction, 8-29
 that invokes remote subprogram, 13-27
Transaction Guard, 8-8, 28-1
transaction history table, 28-8
transaction interaction
 kinds of, 8-30
 serializable transaction and, 8-30
 transaction isolation level and, 8-30
transaction isolation level
 choosing, 8-36
 setting, 8-32
 transaction interaction and, 8-30
transaction manager (TM), 22-3
transaction processing monitor (TPM), 22-3
transaction set consistency, 8-35
transaction-level read consistency
 locking tables explicitly for, 8-14
 read-only transaction for, 8-13
transform
 applying, 27-33
trigger
 AFTER SUSPEND, 8-46
 as autonomous transaction, 8-46
 automating database login with, 5-2
 compared to constraint, 12-2
 crossedition
 See crossedition trigger, 27-25
 enforcing referential integrity with, 8-33
 in edition
 firing order of, 27-28
 visibility of, 27-26
 what kind can fire, 27-27
 invoking subprogram from, 13-24
 size limit for, 13-8
TRUST assertion (deprecated), 13-34
TRUST keyword in RESTRICT_REFERENCES pragma,
 13-34
two-phase commit protocol, 22-3
two-tier architecture, 20-2
TX interface, 22-3

U

undetected deadlock, 8-27
undo data, 19-1
UNDO_RETENTION parameter, 8-13
Unicode
 data types for, 9-5
 regular expressions and, 10-4
unified auditing, 5-7
UNIQUE constraint
 crossedition trigger and, 27-31
 dropping, 12-24
 naming, 12-18
 on FOREIGN KEY constraint, 12-10
 when to use, 12-7
unrepeatable read, 8-30
unusable edition
 dropping edition and, 27-21
 for materialized view, 27-4
 retiring edition and, 27-20
upgrading applications online
 See edition-based redefinition (EBR)
UROWID data type, 9-24
user access
 See security
user interface
 stateful and stateless, 20-3
user lock, 8-27
user-defined subtype, 13-10
UTLLOCKT.SQL script, 8-29

V

VARCHAR data type, 9-5
VARCHAR data type class, 26-17
VARCHAR2 data type, 9-5
variable
 cursor
 See cursor variable, 13-10, 13-11
 in C external subprogram
 global, 21-44
 static, 21-44
view
 constraint on, 12-1
 editioned, FOREIGN KEY constraint and, 27-10
 editioning
 See editioning view, 27-22
 materialized
 that depends on editioned object, 27-4
virtual column, 27-5
VPD policy, editioning view and, 27-39

W

WAIT commit redo option, 8-6
WAIT option of LOCK TABLE statement, 8-15
web application

web application (*continued*)
 implementing, [17-2](#)
 state and, [17-27](#)
web services, [20-12](#)
web toolkit
 See PL/SQL Web Toolkit
white list
 See ACCESSIBLE BY clause
wrap utility, debugging and, [13-37](#)
writability of editioning view, [27-24](#)
write-after-write dependency, [19-16](#)

X

X/Open Distributed Transaction Processing (DTP)
 architecture, [22-2](#)
xa_open string, [22-9](#)
XMLType data type, [9-22](#)

Y

YY datetime format element, [9-16](#)