

Oracle® XML DB

Developer's Guide

12c Release 2 (12.2)

E41485-09

January 2017

Oracle XML DB Developer's Guide, 12c Release 2 (12.2)

E41485-09

Copyright © 2002, 2017, Oracle and/or its affiliates. All rights reserved.

Primary Author: Drew Adams

Contributors: Oracle XML DB development, product management, and quality assurance teams.

This software and related documentation are provided under a license agreement containing restrictions on use and disclosure and are protected by intellectual property laws. Except as expressly permitted in your license agreement or allowed by law, you may not use, copy, reproduce, translate, broadcast, modify, license, transmit, distribute, exhibit, perform, publish, or display any part, in any form, or by any means. Reverse engineering, disassembly, or decompilation of this software, unless required by law for interoperability, is prohibited.

The information contained herein is subject to change without notice and is not warranted to be error-free. If you find any errors, please report them to us in writing.

If this is software or related documentation that is delivered to the U.S. Government or anyone licensing it on behalf of the U.S. Government, then the following notice is applicable:

U.S. GOVERNMENT END USERS: Oracle programs, including any operating system, integrated software, any programs installed on the hardware, and/or documentation, delivered to U.S. Government end users are "commercial computer software" pursuant to the applicable Federal Acquisition Regulation and agency-specific supplemental regulations. As such, use, duplication, disclosure, modification, and adaptation of the programs, including any operating system, integrated software, any programs installed on the hardware, and/or documentation, shall be subject to license terms and license restrictions applicable to the programs. No other rights are granted to the U.S. Government.

This software or hardware is developed for general use in a variety of information management applications. It is not developed or intended for use in any inherently dangerous applications, including applications that may create a risk of personal injury. If you use this software or hardware in dangerous applications, then you shall be responsible to take all appropriate fail-safe, backup, redundancy, and other measures to ensure its safe use. Oracle Corporation and its affiliates disclaim any liability for any damages caused by use of this software or hardware in dangerous applications.

Oracle and Java are registered trademarks of Oracle and/or its affiliates. Other names may be trademarks of their respective owners.

Intel and Intel Xeon are trademarks or registered trademarks of Intel Corporation. All SPARC trademarks are used under license and are trademarks or registered trademarks of SPARC International, Inc. AMD, Opteron, the AMD logo, and the AMD Opteron logo are trademarks or registered trademarks of Advanced Micro Devices. UNIX is a registered trademark of The Open Group.

This software or hardware and documentation may provide access to or information about content, products, and services from third parties. Oracle Corporation and its affiliates are not responsible for and expressly disclaim all warranties of any kind with respect to third-party content, products, and services unless otherwise set forth in an applicable agreement between you and Oracle. Oracle Corporation and its affiliates will not be responsible for any loss, costs, or damages incurred due to your access to or use of third-party content, products, or services, except as set forth in an applicable agreement between you and Oracle.

Contents

Preface	xxxv
Audience	xxxv
Documentation Accessibility	xxxv
Related Documents.....	xxxvi
Conventions.....	xxxviii
Code Examples.....	xxxviii
Standard Database Schemas	xxxviii
Pretty Printing of XML Data.....	xxxviii
Execution Plans.....	xxxix
Reminder About Case Sensitivity	xxxix
Syntax Descriptions.....	xxxix
Changes in This Release for Oracle XML DB Developer's Guide.....	xli
Changes in Oracle Database 12c Release 2 (12.2.0.1) for Oracle Database	xli
New Features	xli
Deprecated Features.....	xlii
Desupported Features	xliv
Changes in Oracle Database 12c Release 1 (12.1.0.2) for Oracle Database	xliv
New Features	xliv
Changes in Oracle Database 12c Release 1 (12.1.0.1) for Oracle XML DB.....	xlv
New Features	xlv
Deprecated Features.....	xlviii
Desupported Features	li
Part I Oracle XML DB Basics	
1 Introduction to Oracle XML DB	
1.1 Overview of Oracle XML DB	1-1
1.2 Oracle XML DB Benefits	1-2
1.2.1 Data and Content Unified	1-3
1.2.2 Data Duality: XML and Relational.....	1-7

1.2.3	Efficient Storage and Retrieval of Complex XML Documents	1-8
1.3	Oracle XML DB Architecture	1-8
1.4	Oracle XML DB Features	1-10
1.4.1	XMLType Data Type.....	1-10
1.4.2	XMLType Storage Models.....	1-11
1.4.3	XML Schema Support in Oracle XML DB	1-12
1.4.4	DTD Support in Oracle XML DB	1-13
1.4.5	Static Data Dictionary Views Related to XML	1-14
1.4.6	SQL/XML Standard Functions	1-15
1.4.7	Programmatic Access to Oracle XML DB (Java, PL/SQL, and C)	1-16
1.4.8	Oracle XML DB Repository: Overview	1-16
1.5	Standards Supported by Oracle XML DB	1-18
1.6	Oracle XML DB Technical Support.....	1-19
1.7	Oracle XML DB Examples	1-20
1.8	Oracle XML DB Case Studies and Demonstrations on OTN	1-20
2	Getting Started with Oracle XML DB	
2.1	Oracle XML DB Installation	2-1
2.2	Oracle XML DB Use Cases	2-1
2.3	Application Design Considerations for Oracle XML DB.....	2-2
2.3.1	XML Data Storage	2-3
2.3.2	The Structure of Your XML Data	2-4
2.3.3	Languages Used to Implement Your Application.....	2-4
2.3.4	XML Processing Options.....	2-4
2.3.5	Oracle XML DB Repository Access.....	2-5
2.3.6	Oracle XML DB Cooperates with Other Database Options and Features	2-6
3	Overview of How To Use Oracle XML DB	
3.1	Creating XMLType Tables and Columns.....	3-2
3.2	Creating Virtual Columns on XMLType Data Stored as Binary XML.....	3-2
3.3	Partitioning Tables That Contain XMLType Data Stored as Binary XML	3-3
3.4	Enforcing XML Data Integrity Using the Database.....	3-5
3.4.1	Enforcing Referential Integrity Using SQL Constraints	3-6
3.5	Loading XML Content into Oracle XML DB	3-9
3.5.1	Loading XML Content Using SQL or PL/SQL	3-10
3.5.2	Loading XML Content Using Java	3-11
3.5.3	Loading XML Content Using C.....	3-11
3.5.4	Loading Large XML Files that Contain Small XML Documents.....	3-13
3.5.5	Loading Large XML Files Using SQL*Loader.....	3-13
3.5.6	Loading XML Documents into the Repository Using DBMS_XDB_REPOS	3-14
3.5.7	Loading Documents into the Repository Using Protocols	3-14
3.6	Querying XML Content Stored in Oracle XML DB	3-15
3.6.1	PurchaseOrder XML Document Used in Examples.....	3-15

3.6.2 Retrieving the Content of an XML Document Using Pseudocolumn OBJECT_VALUE.....	3-16
3.6.3 Accessing Fragments or Nodes of an XML Document Using XMLQUERY	3-17
3.6.4 Accessing Text Nodes and Attribute Values Using XMLCAST and XMLQUERY ...	3-18
3.6.5 Searching an XML Document Using XMLEXISTS, XMLCAST, and XMLQUERY ...	3-19
3.6.6 Performing SQL Operations on XMLType Fragments Using XMLTABLE.....	3-22
3.7 Updating XML Content Stored in Oracle XML DB	3-25
3.8 Generating XML Data from Relational Data	3-27
3.8.1 Generating XML Data from Relational Data Using SQL/XML Functions.....	3-28
3.8.2 Generating XML Data from Relational Data Using DBURITYPE.....	3-32
3.9 Character Sets of XML Documents	3-33
3.9.1 XML Encoding Declaration.....	3-34
3.9.2 Character-Set Determination When Loading XML Documents into the Database...	3-34
3.9.3 Character-Set Determination When Retrieving XML Documents from the Database	3-35

Part II Manipulation of XML Data in Oracle XML DB

4 XQuery and Oracle XML DB

4.1 Overview of the XQuery Language	4-1
4.1.1 XPath Expressions Are XQuery Expressions	4-1
4.1.2 XQuery: A Functional Language Based on Sequences	4-2
4.1.3 XQuery Expressions.....	4-5
4.1.4 FLWOR Expressions	4-7
4.2 Overview of XQuery in Oracle XML DB.....	4-8
4.2.1 When To Use XQuery	4-8
4.2.2 Predefined XQuery Namespaces and Prefixes	4-9
4.3 SQL/XML Functions XMLQUERY, XMLTABLE, XMLEXISTS, and XMLCast	4-9
4.3.1 XMLQUERY SQL/XML Function in Oracle XML DB.....	4-10
4.3.2 XMLTABLE SQL/XML Function in Oracle XML DB.....	4-11
4.3.3 XMLEXISTS SQL/XML Function in Oracle XML DB.....	4-15
4.3.4 Using XMLEXISTS to Find a Node.....	4-16
4.3.5 XMLCAST SQL/XML Function in Oracle XML DB	4-16
4.3.6 Using XMLCAST to Extract the Scalar Value of an XML Fragment.....	4-17
4.4 URI Scheme oradb: Querying Table or View Data with XQuery	4-18
4.5 Oracle XQuery Extension Functions	4-20
4.5.1 ora:contains XQuery Function (Deprecated).....	4-20
4.5.2 ora:sqrt XQuery Function.....	4-20
4.5.3 ora:tokenize XQuery Function	4-20
4.5.4 ora:matches XQuery Function (Deprecated).....	4-21
4.5.5 ora:replace XQuery Function (Deprecated).....	4-21
4.6 Oracle XQuery Extension-Expression Pragmas	4-22
4.7 XQuery Static Type-Checking in Oracle XML DB	4-25

4.8	Oracle XML DB Support for XQuery	4-26
4.8.1	Support for XQuery and SQL	4-26
4.8.2	Support for XQuery Functions and Operators	4-28
4.8.3	Support for XQuery Full Text.....	4-28

5 Query and Update of XML Data

5.1	Using XQuery with Oracle XML DB.....	5-1
5.1.1	XQuery Sequences Can Contain Data of Any XQuery Type.....	5-2
5.1.2	Querying XML Data in Oracle XML DB Repository Using XQuery	5-3
5.1.3	Querying Relational Data Using XQuery and URI Scheme oradb	5-5
5.1.4	Querying XMLType Data Using XQuery	5-9
5.1.5	Using Namespaces with XQuery	5-16
5.2	Querying XML Data Using SQL and PL/SQL	5-18
5.3	Using the SQL*Plus XQUERY Command.....	5-22
5.4	Using XQuery with XQJ to Access Database Data	5-23
5.5	Using XQuery with PL/SQL, JDBC, and ODP.NET to Access Database Data	5-23
5.6	Updating XML Data	5-27
5.6.1	Updating an Entire XML Document	5-27
5.6.2	Replacing XML Nodes.....	5-28
5.6.3	Inserting Child XML Nodes.....	5-36
5.6.4	Deleting XML Nodes	5-39
5.6.5	Creating XML Views of Modified XML Data	5-39
5.7	Performance Tuning for XQuery	5-40
5.7.1	Rule-Based and Cost-Based XQuery Optimization.....	5-41
5.7.2	XQuery Optimization over Relational Data	5-42
5.7.3	XQuery Optimization over XML Schema-Based XMLType Data.....	5-43
5.7.4	Diagnosis of XQuery Optimization: XMLOptimizationCheck.....	5-46
5.7.5	Performance Improvement for fn:doc and fn:collection on Repository Data	5-46

6 Indexes for XMLType Data

6.1	Oracle XML DB Tasks Involving Indexes	6-1
6.2	Overview of Indexing XMLType Data	6-4
6.2.1	XMLIndex Addresses the Fine-Grained Structure of XML Data	6-5
6.2.2	Oracle Text Indexes for XML Data	6-5
6.2.3	Optimization Chooses the Right Indexes to Use	6-6
6.2.4	Function-Based Indexes Are Deprecated for XMLType.....	6-6
6.3	XMLIndex	6-7
6.3.1	Advantages of XMLIndex	6-7
6.3.2	Structured and Unstructured XMLIndex Components.....	6-8
6.3.3	XMLIndex Structured Component	6-9
6.3.4	XMLIndex Unstructured Component	6-15
6.3.5	Creating, Dropping, Altering, and Examining an XMLIndex Index	6-20
6.3.6	Using XMLIndex with an Unstructured Component	6-22

6.3.7	Use of XMLIndex with a Structured Component.....	6-26
6.3.8	How to Tell Whether XMLIndex is Used	6-31
6.3.9	Turning Off Use of XMLIndex	6-36
6.3.10	XMLIndex Path Subsetting: Specifying the Paths You Want to Index.....	6-37
6.3.11	Guidelines for Using XMLIndex with an Unstructured Component.....	6-39
6.3.12	Guidelines for Using XMLIndex with a Structured Component.....	6-40
6.3.13	XMLIndex Partitioning and Parallelism	6-41
6.3.14	Asynchronous (Deferred) Maintenance of XMLIndex Indexes.....	6-42
6.3.15	Collecting Statistics on XMLIndex Objects for the Cost-Based Optimizer	6-44
6.3.16	Data Dictionary Static Public Views Related to XMLIndex	6-45
6.3.17	PARAMETERS Clause for CREATE INDEX and ALTER INDEX.....	6-46
6.4	Indexing XML Data for Full-Text Queries	6-56
6.4.1	Creating and Using an XML Search Index	6-56
6.4.2	What To Do If an XML Search Index Is Not Picked Up	6-58
6.4.3	Pragma ora:no_schema: Using XML Schema-Based Data with XQuery Full Text....	6-58
6.4.4	Pragma ora:use_xmltext_idx: Forcing the Use of an XML Search Index	6-59
6.4.5	Migrating from Using Oracle Text Index to XML Search Index	6-60
6.5	Indexing XMLType Data Stored Object-Relationally.....	6-62
6.5.1	Indexing Non-Repeating Text Nodes or Attribute Values.....	6-62
6.5.2	Indexing Repeating (Collection) Elements	6-63

7 Transformation and Validation of XMLType Data

7.1	XSL Transformation and Oracle XML DB.....	7-1
7.1.1	SQL Function XMLTRANSFORM and XMLType Method TRANSFORM()	7-3
7.1.2	XSL Transformation Using DBUri Servlet.....	7-9
7.2	Validation of XMLType Instances.....	7-11
7.2.1	Partial and Full XML Schema Validation	7-12
7.2.2	Validating XML Data Stored as XMLType: Examples.....	7-14

Part III Relational Data To and From XML Data

8 Generation of XML Data from Relational Data

8.1	Overview of Generating XML Data	8-1
8.2	Generation of XML Data Using SQL Functions	8-2
8.2.1	XMLELEMENT and XMLATTRIBUTES SQL/XML Functions.....	8-3
8.2.2	XMLFOREST SQL/XML Function	8-9
8.2.3	XMLCONCAT SQL/XML Function.....	8-11
8.2.4	XMLAGG SQL/XML Function.....	8-12
8.2.5	XMLPI SQL/XML Function.....	8-15
8.2.6	XMLCOMMENT SQL/XML Function.....	8-16
8.2.7	XMLSERIALIZE SQL/XML Function.....	8-17
8.2.8	XMLPARSE SQL/XML Function.....	8-18
8.2.9	XMLCOLATTVAL Oracle SQL Function	8-19

8.2.10 XMLCDATA Oracle SQL Function	8-20
8.3 Generation of XML Data Using DBMS_XMLGEN	8-21
8.3.1 Using PL/SQL Package DBMS_XMLGEN.....	8-21
8.3.2 Functions and Procedures of Package DBMS_XMLGEN.....	8-23
8.3.3 DBMS_XMLGEN Examples.....	8-28
8.4 SYS_XMLAGG Oracle SQL Function	8-46
8.5 Ordering Query Results Before Aggregating, Using XMLAGG ORDER BY Clause	8-46
8.6 Returning a Rowset Using XMLTABLE.....	8-47

9 Relational Views over XML Data

9.1 Introduction to Creating and Using Relational Views over XML Data.....	9-1
9.2 Creating a Relational View over XML: One Row for Each XML Document	9-1
9.3 Creating a Relational View over XML: Mapping XML Nodes to Columns.....	9-2
9.4 Indexing Binary XML Data Exposed Using a Relational View.....	9-4
9.5 Querying XML Content As Relational Data	9-5

10 XMLType Views

10.1 What Are XMLType Views?	10-1
10.2 CREATE VIEW for XMLType Views: Syntax.....	10-2
10.3 Creating Non-Schema-Based XMLType Views	10-2
10.4 Creating XML Schema-Based XMLType Views.....	10-3
10.4.1 Creating XML Schema-Based XMLType Views Using SQL/XML Publishing Functions.....	10-4
10.4.2 Creating XML Schema-Based XMLType Views Using Object Types or Object Views	10-10
10.5 Creating XMLType Views from XMLType Tables.....	10-17
10.6 Referencing XMLType View Objects Using SQL Function REF.....	10-17
10.7 Using DML (Data Manipulation Language) on XMLType Views	10-18

Part IV XMLType APIs

11 PL/SQL APIs for XMLType

11.1 Overview of PL/SQL APIs for XMLType.....	11-1
11.1.1 PL/SQL APIs for XMLType: Features	11-1
11.1.2 PL/SQL APIs for XMLType: References	11-2
11.2 PL/SQL DOM API for XMLType (DBMS_XMLDOM)	11-4
11.2.1 Overview of the W3C Document Object Model (DOM) Recommendation	11-5
11.2.2 PL/SQL DOM API for XMLType (DBMS_XMLDOM): Features.....	11-6
11.2.3 Application Design Using Oracle XML Developer's Kit and Oracle XML DB	11-7
11.2.4 Preparing XML Data to Use the PL/SQL DOM API for XMLType	11-8
11.2.5 XML Schema Types Are Mapped to SQL Object Types.....	11-9
11.2.6 Wrap Existing Data as XML with XMLType Views.....	11-10
11.2.7 DBMS_XMLDOM Methods Supported by Oracle XML DB.....	11-10

11.2.8	PL/SQL DOM API for XMLType: Node Types	11-10
11.2.9	PL/SQL Function NEWDOMDOCUMENT and DOMDOCUMENT Nodes.....	11-12
11.2.10	DOM NodeList and NamedNodeMap Objects	11-12
11.2.11	Overview of Using the PL/SQL DOM API for XMLType (DBMS_XMLDOM)..	11-13
11.2.12	PL/SQL DOM API for XMLType – Examples.....	11-14
11.2.13	Large Node Handling Using DBMS_XMLDOM.....	11-15
11.2.14	Get-Push Model for Large Node Handling.....	11-17
11.2.15	Get-Pull Model for Large Node Handling.....	11-18
11.2.16	Set-Pull Model for Large Node Handling	11-20
11.2.17	Set-Push Model for Large Node Handling.....	11-21
11.2.18	Determining Binary Stream or Character Stream for Large Node Handling.....	11-22
11.3	PL/SQL Parser API for XMLType (DBMS_XMLPARSER).....	11-22
11.4	PL/SQL XSLT Processor for XMLType (DBMS_XSLPROCESSOR).....	11-24
11.4.1	PL/SQL XSLT Processor for XMLType: Features	11-24
11.4.2	Using the PL/SQL XSLT Processor API for XMLType (DBMS_XSLPROCESSOR)	11-25
12	PL/SQL Package DBMS_XMLSTORE	
12.1	Using Package DBMS_XMLSTORE	12-1
12.2	Inserting an XML Document Using DBMS_XMLSTORE	12-2
12.3	Updating XML Data Using DBMS_XMLSTORE	12-3
12.4	Deleting XML Data Using DBMS_XMLSTORE	12-4
13	Java DOM API for XMLType	
13.1	Overview of Java DOM API for XMLType.....	13-1
13.2	Access to XMLType Data Using JDBC	13-2
13.2.1	Using JDBC to Access XML Documents in Oracle XML DB.....	13-2
13.3	Manipulating XML Database Documents Using JDBC	13-4
13.4	Loading a Large XML Document into the Database Using JDBC.....	13-8
13.5	MS Windows Java Security Manager Permissions for Java DOM API with a Thick Connection	13-9
13.6	Creating XML Schema-Based Documents	13-10
13.7	XMLType Instance Representation in Java (JDBC or SQLJ).....	13-11
13.8	Classes of Java DOM API for XMLType	13-11
13.9	Using the Java DOM API for XMLType.....	13-12
13.10	Large XML Node Handling with Java.....	13-13
13.10.1	Stream Extensions to Java DOM	13-14
13.11	Using the Java DOM API and JDBC with Binary XML	13-17
14	C DOM API for XMLType	
14.1	Overview of the C API for XML.....	14-1
14.2	Access to XMLType Data Stored in the Database Using OCI.....	14-2
14.3	Creating XMLType Instances on the Client.....	14-2
14.4	XML Context Parameter for C DOM API Functions	14-3

14.4.1	OCIXmlDbInitXmlCtx() Syntax.....	14-3
14.4.2	OCIXmlDbFreeXmlCtx() Syntax	14-3
14.5	Initializing and Terminating an XML Context.....	14-3
14.6	Using the C API for XML with Binary XML.....	14-7
14.7	Using the Oracle XML Developer's Kit Pull Parser with Oracle XML DB.....	14-10
14.8	Common XMLType Operations in C.....	14-15
15	Oracle XML DB and Oracle Data Provider for .NET	
15.1	Oracle XML DB and ODP.NET XML.....	15-1
15.2	Using XMLType Data with ODP.NET	15-1
Part V	XML Schema and Object-Relational XMLType	
16	Choice of XMLType Storage and Indexing	
16.1	Introduction to Choosing an XMLType Storage Model and Indexing Approaches.....	16-1
16.2	XMLType Use Case Spectrum: Data-Centric to Document-Centric	16-2
16.3	Common Use Cases for XML Data Stored as XMLType	16-3
16.3.1	XMLType Use Case: No XML Fragment Updating or Querying.....	16-4
16.3.2	XMLType Use Case: Data Integration from Diverse Sources with Different XML Schemas	16-4
16.3.3	XMLType Use Case: Staged XML Data for ETL	16-4
16.3.4	XMLType Use Case: Semi-Structured XML Data.....	16-5
16.3.5	XMLType Use Case: Business Intelligence Queries	16-5
16.3.6	XMLType Use Case: XML Queries Involving Full-Text Search	16-6
16.4	XMLType Storage Model Considerations.....	16-6
16.5	XMLType Indexing Considerations.....	16-8
16.6	XMLType Storage Options: Relative Advantages	16-8
17	XML Schema Storage and Query: Basic	
17.1	Overview of XML Schema.....	17-1
17.1.1	XML Schema for Schemas.....	17-2
17.1.2	XML Schema Features	17-2
17.1.3	XML Instance Documents.....	17-2
17.1.4	XML Namespaces and XML Schemas.....	17-2
17.1.5	Overview of Editing XML Schemas	17-2
17.2	Overview of Using XML Schema with Oracle XML DB.....	17-3
17.2.1	Why Use XML Schema with Oracle XML DB?	17-4
17.2.2	Overview of Annotating an XML Schema to Control Naming, Mapping, and Storage	17-5
17.2.3	DOM Fidelity	17-6
17.2.4	XMLType Methods Related to XML Schema.....	17-7
17.3	XML Schema Registration with Oracle XML DB	17-7
17.3.1	XML Schema Registration Actions	17-8

17.3.2	Registering an XML Schema with Oracle XML DB.....	17-8
17.3.3	SQL Types and Tables Created During XML Schema Registration	17-10
17.3.4	Default Tables for Global Elements	17-11
17.3.5	Database Objects That Depend on Registered XML Schemas	17-12
17.3.6	Local and Global XML Schemas.....	17-12
17.3.7	Fully Qualified XML Schema URLs.....	17-14
17.3.8	Deletion of an XML Schema	17-15
17.3.9	Listing All Registered XML Schemas	17-16
17.4	Creation of XMLType Tables and Columns Based on XML Schemas	17-17
17.4.1	Specification of XMLType Storage Options for XML Schema-Based Data	17-20
17.5	Ways to Identify XML Schema Instance Documents	17-24
17.5.1	Attributes noNamespaceSchemaLocation and schemaLocation	17-25
17.5.2	XML Schema and Multiple Namespaces	17-26
17.6	XML Schema Data Types Are Mapped to Oracle XML DB Storage	17-26

18 XML Schema Storage and Query: Object-Relational Storage

18.1	Object-Relational Storage of XML Documents.....	18-2
18.1.1	How Collections Are Stored for Object-Relational XMLType Storage	18-2
18.1.2	SQL Types Created during XML Schema Registration for Object-Relational Storage	18-3
18.1.3	Default Tables Created during XML Schema Registration	18-5
18.1.4	Do Not Use Internal Constructs Generated during XML Schema Registration	18-5
18.1.5	Generated Names are Case Sensitive	18-5
18.1.6	SYS_XDBPD\$ and DOM Fidelity for Object-Relational Storage	18-6
18.2	Oracle XML Schema Annotations	18-7
18.2.1	Common Uses of XML Schema Annotations	18-7
18.2.2	XML Schema Annotation Example.....	18-8
18.2.3	Annotating an XML Schema Using DBMS_XMLSCHEMA_ANNOTATE	18-12
18.2.4	Available Oracle XML DB XML Schema Annotations	18-13
18.2.5	XML Schema Annotation Guidelines for Object-Relational Storage	18-16
18.2.6	Querying a Registered XML Schema to Obtain Annotations	18-19
18.3	Use DBMS_XMLSCHEMA to Map XML Schema Data Types to SQL Data Types	18-20
18.3.1	Example of Mapping XML Schema Data Types to SQL.....	18-20
18.3.2	XML Schema Attribute Data Types Mapped to SQL.....	18-22
18.3.3	XML Schema Element Data Types Mapped to SQL.....	18-22
18.3.4	How XML Schema simpleType Is Mapped to SQL	18-23
18.3.5	How XML Schema complexType Is Mapped to SQL	18-27
18.4	complexType Extensions and Restrictions in Oracle XML DB	18-29
18.4.1	complexType Declarations in XML Schema: Handling Inheritance	18-29
18.4.2	How a complexType Based on simpleContent Is Mapped to an Object Type.....	18-31
18.4.3	How any and anyAttribute Declarations Are Mapped to Object Type Attributes	18-31
18.5	Creating XML Schema-Based XMLType Columns and Tables	18-32
18.6	Overview of Partitioning XMLType Tables and Columns Stored Object-Relationally ...	18-34

18.6.1	Examples of Partitioning XMLType Data Stored Object-Relationally	18-35
18.6.2	Partition Maintenance for XMLType Data Stored Object-Relationally	18-36
18.7	Specification of Relational Constraints on XMLType Tables and Columns	18-37
18.7.1	Adding Unique Constraints to the Parent Element of an Attribute	18-38
18.8	Out-Of-Line Storage of XMLType Data	18-40
18.8.1	Setting Annotation Attribute xdb:SQLInline to false for Out-Of-Line Storage.....	18-40
18.8.2	Storing Collections in Out-Of-Line Tables.....	18-43
18.9	Considerations for Working with Complex or Large XML Schemas	18-45
18.9.1	Circular and Cyclical Dependencies Among XML Schemas	18-45
18.9.2	Support for Recursive Schemas.....	18-51
18.9.3	XML Fragments Can Be Mapped to Large Objects (LOBs).....	18-55
18.9.4	ORA-01792 and ORA-04031: Issues with Large XML Schemas	18-56
18.9.5	Considerations for Loading and Retrieving Large Documents with Collections..	18-57
18.10	Debugging XML Schema Registration for XML Data Stored Object-Relationally.....	18-59

19 XPath Rewrite for Object-Relational Storage

19.1	Overview of XPath Rewrite for Object-Relational Storage.....	19-1
19.2	Common XPath Expressions that Are Rewritten.....	19-2
19.3	XPath Rewrite for Out-Of-Line Tables	19-3
19.4	Guidelines for Using Execution Plans to Analyze and Optimize XPath Queries	19-4
19.4.1	Guideline: Look for underlying tables versus XML functions in execution plans..	19-5
19.4.2	Guideline: Name the object-relational tables, so you recognize them in execution plans.....	19-6
19.4.3	Guideline: Create an index on a column targeted by a predicate	19-6
19.4.4	Guideline: Create indexes on ordered collection tables	19-8
19.4.5	Guideline: Use XMLOptimizationCheck to determine why a query is not rewritten.....	19-10

20 XML Schema Evolution

20.1	Overview of XML Schema Evolution	20-1
20.2	Copy-Based Schema Evolution.....	20-2
20.2.1	Scenario for Copy-Based Evolution.....	20-2
20.2.2	COPYEVOLVE Parameters and Errors.....	20-5
20.2.3	Limitations of Procedure COPYEVOLVE.....	20-7
20.2.4	Guidelines for Using Procedure COPYEVOLVE	20-8
20.2.5	Update of Existing XML Instance Documents Using an XSLT Stylesheet.....	20-10
20.2.6	Examples of Using Procedure COPYEVOLVE	20-12
20.3	In-Place XML Schema Evolution	20-15
20.3.1	Restrictions for In-Place XML Schema Evolution.....	20-16
20.3.2	Supported Operations for In-Place XML Schema Evolution	20-18
20.3.3	Guidelines for Using In-Place XML Schema Evolution.....	20-19
20.3.4	inPlaceEvolve Parameters	20-20
20.3.5	The diffXML Parameter Document	20-21

Part VI Oracle XML DB Repository

21 Access to Oracle XML DB Repository Data

21.1 Overview of Oracle XML DB Repository	21-1
21.1.1 Oracle XML DB Provides Name-Level Locking	21-3
21.1.2 Two Ways to Access Oracle XML DB Repository Resources	21-4
21.1.3 Database Schema (User Account) XDB and Oracle XML DB Repository	21-4
21.2 Repository Terminology and Supplied Resources	21-5
21.2.1 Repository Terminology	21-5
21.2.2 Predefined Repository Files and Folders	21-7
21.3 Oracle XML DB Repository Resources	21-7
21.3.1 Where Is Repository Data Stored?	21-8
21.3.2 How Documents are Stored in Oracle XML DB Repository	21-9
21.3.3 Repository Data Access Control	21-9
21.3.4 Repository Path-Name Resolution	21-10
21.3.5 Link Types	21-11
21.4 Navigational or Path Access to Repository Resources	21-14
21.4.1 Access to Oracle XML DB Resources Using Internet Protocols	21-15
21.4.2 Access to Oracle ASM Files Using Protocols and Resource APIs – For DBAs	21-17
21.5 Query-Based Access to Repository Resources	21-19
21.6 Servlet Access to Repository Resources	21-20
21.7 Operations on Repository Resources	21-20
21.8 Accessing the Content of Repository Resources Using SQL	21-28
21.9 Access to the Content of XML Schema-Based Documents	21-29
21.9.1 Accessing Resource Content Using Element XMLRef in Joins	21-29
21.10 Update of the Content of Repository Documents	21-30
21.10.1 Update of Repository Content Using Internet Protocols	21-30
21.10.2 Update of Repository Content Using SQL	21-31
21.11 Querying Resources in RESOURCE_VIEW and PATH_VIEW	21-34
21.12 Oracle XML DB Hierarchical Repository Index	21-37

22 Configuration of Oracle XML DB Repository

22.1 Resource Configuration Files	22-1
22.2 Configuring a Resource	22-2
22.3 Common Configuration Parameters	22-3
22.3.1 Configuration Element ResConfig	22-4
22.3.2 Configuration Elements defaultChildConfig and configuration	22-4
22.3.3 Configuration Element applicationData	22-5

23 Use of XLink and XInclude with Oracle XML DB

23.1 Overview of XLink and XInclude	23-1
23.2 Link Types for XLink and XInclude	23-2

23.2.1	XLink and XInclude Links Model Document Relationships	23-2
23.2.2	XLink Link Types and XInclude Link Types.....	23-3
23.3	XInclude: Compound Documents.....	23-3
23.4	Oracle XML DB Support for XLink.....	23-4
23.5	Oracle XML DB Support for XInclude.....	23-5
23.5.1	Expanding Compound-Document Inclusions	23-5
23.5.2	Validation of Compound Documents	23-7
23.5.3	Update of a Compound Document	23-7
23.5.4	Compound Document Versioning, Locking, and Access Control.....	23-7
23.6	Use View DOCUMENT_LINKS to Examine XLink and XInclude Links.....	23-8
23.6.1	Querying DOCUMENT_LINKS for XLink Information	23-8
23.6.2	Querying DOCUMENT_LINKS for XInclude Information	23-9
23.7	Configuration of Repository Resources for XLink and XInclude.....	23-10
23.7.1	Configure the Treatment of Unresolved Links: Attribute UnresolvedLink.....	23-11
23.7.2	Configure the Type of Document Links to Create: Element LinkType.....	23-11
23.7.3	Configure the Path Format for Retrieval: Element PathFormat	23-12
23.7.4	Configure Conflict-Resolution for XInclude: Element ConflictRule	23-12
23.7.5	Configure the Decomposition of Documents Using XInclude: Element SectionConfig	23-13
23.7.6	XLink and XInclude Configuration Examples	23-14
23.8	Manage XLink and XInclude Links Using DBMS_XDB_REPOS.processLinks	23-16

24 Repository Access Using RESOURCE_VIEW and PATH_VIEW

24.1	Overview of Oracle XML DB RESOURCE_VIEW and PATH_VIEW	24-1
24.1.1	RESOURCE_VIEW Definition and Structure.....	24-3
24.1.2	PATH_VIEW Definition and Structure.....	24-4
24.1.3	The Difference Between RESOURCE_VIEW and PATH_VIEW	24-4
24.1.4	Operations You Can Perform Using UNDER_PATH and EQUALS_PATH	24-5
24.2	Oracle SQL Functions That Use RESOURCE_VIEW and PATH_VIEW	24-5
24.2.1	UNDER_PATH SQL Function.....	24-5
24.2.2	EQUALS_PATH SQL Function.....	24-7
24.2.3	PATH SQL Function	24-8
24.2.4	DEPTH SQL Function.....	24-8
24.3	Accessing Repository Data Paths, Resources and Links: Examples	24-8
24.4	Deleting Repository Resources: Examples.....	24-14
24.4.1	Deleting Nonempty Folder Resources	24-15
24.5	Updating Repository Resources: Examples.....	24-16
24.6	Working with Multiple Oracle XML DB Resources	24-18
24.7	Performance Guidelines for Oracle XML DB Repository Operations	24-20
24.8	Searching for Resources Using Oracle Text	24-21

25 Resource Versions

25.1	Overview of Oracle XML DB Repository Resource Versioning	25-1
------	--	------

25.2	Overview of PL/SQL Package DBMS_XDB_VERSION	25-2
25.3	Resource Versions and Resource IDs.....	25-4
25.4	Resource Versions and ACLs.....	25-5
25.5	Resource Versioning Examples	25-6
26	PL/SQL Access to Oracle XML DB Repository	
26.1	DBMS_XDB_REPOS: Access and Manage Repository Resources.....	26-1
26.2	DBMS_XDB_REPOS: ACL-Based Security Management.....	26-3
26.3	DBMS_XDB_CONFIG: Configuration Management	26-7
27	Repository Access Control	
27.1	Access Control Concepts	27-1
27.1.1	Authentication and Authorization	27-2
27.1.2	Principal: A User or Role.....	27-2
27.1.3	Privilege: A Permission	27-3
27.1.4	Access Control Entry (ACE)	27-4
27.1.5	Access Control List (ACL).....	27-4
27.2	Database Privileges for Repository Operations	27-5
27.3	Privileges.....	27-5
27.3.1	Atomic Privileges	27-6
27.3.2	Aggregate Privileges.....	27-7
27.4	ACLs and ACEs	27-7
27.4.1	System ACLs.....	27-8
27.4.2	ACL and ACE Evaluation.....	27-9
27.4.3	ACL Validation.....	27-9
27.4.4	Element invert: Complement the Principals in an ACE	27-10
27.5	Overview of Working with Access Control Lists (ACLs).....	27-10
27.5.1	Creating an ACL Using DBMS_XDB_REPOS.CREATERESOURCE.....	27-10
27.5.2	Retrieving an ACL Document, Given its Repository Path.....	27-11
27.5.3	Setting the ACL of a Resource.....	27-12
27.5.4	Deleting an ACL	27-12
27.5.5	Updating an ACL	27-12
27.5.6	Retrieving the ACL Document that Protects a Given Resource.....	27-14
27.5.7	Retrieving Privileges Granted to the Current User for a Particular Resource	27-15
27.5.8	Checking Whether the Current User Has Privileges on a Resource.....	27-15
27.5.9	Checking Whether a User Has Privileges Using the ACL and Resource Owner ..	27-16
27.5.10	Retrieving the Path of the ACL that Protects a Given Resource	27-16
27.5.11	Retrieving the Paths of All Resources Protected by a Given ACL.....	27-17
27.6	ACL Caching	27-18
27.7	Repository Resources and Database Table Security	27-18
27.7.1	Optimization: Do not enforce ACL-based security if you do not need it.....	27-19
27.8	Integration Of Oracle XML DB with LDAP	27-20

28	Repository Access Using Protocols	
28.1	Overview of Oracle XML DB Protocol Server	28-1
28.1.1	Session Pooling	28-2
28.2	Oracle XML DB Protocol Server Configuration Management.....	28-2
28.2.1	Protocol Server Configuration Parameters.....	28-3
28.2.2	Configuring Secure HTTP (HTTPS)	28-7
28.2.3	Using Listener Status to Check Port Configuration	28-9
28.2.4	Configuring Protocol Port Parameters after Database Consolidation.....	28-9
28.2.5	Configuration and Management of Authentication Mechanisms for HTTP.....	28-10
28.2.6	Oracle XML DB Repository and File-System Resources	28-11
28.2.7	Protocol Server Handles XML Schema-Based or Non-Schema-Based XML Documents	28-11
28.2.8	Event-Based Logging	28-12
28.3	FTP and the Oracle XML DB Protocol Server.....	28-12
28.3.1	Oracle XML DB Protocol Server: FTP Features.....	28-12
28.4	HTTP(S) and Oracle XML DB Protocol Server.....	28-20
28.4.1	Oracle XML DB Protocol Server: HTTP(S) Features	28-20
28.5	WebDAV and Oracle XML DB	28-26
28.5.1	Oracle XML DB WebDAV Features.....	28-27
28.5.2	WebDAV and Microsoft Windows XP SP2	28-28
28.5.3	Creating a WebFolder in Microsoft Windows For Use With Oracle XML DB Repository	28-28
29	User-Defined Repository Metadata	
29.1	Overview of Metadata and XML.....	29-1
29.1.1	Kinds of Metadata – Uses of the Term	29-2
29.1.2	User-Defined Resource Metadata	29-2
29.1.3	Scenario: Metadata for a Photo Collection.....	29-3
29.2	Using XML Schemas to Define Resource Metadata	29-3
29.3	Addition, Modification, and Deletion of Resource Metadata	29-5
29.3.1	Adding Metadata Using APPENDRESOURCEMETADATA	29-6
29.3.2	Deleting Metadata Using DELETERESOURCEMETADATA	29-7
29.3.3	Adding Metadata Using SQL DML.....	29-7
29.3.4	Adding Metadata Using WebDAV PROPPATCH.....	29-9
29.4	Querying XML Schema-Based Resource Metadata	29-9
29.5	XML Image Metadata from Binary Image Metadata	29-11
29.6	Adding Non-Schema-Based Resource Metadata	29-11
29.7	PL/SQL Procedures Affecting Resource Metadata	29-13
30	Oracle XML DB Repository Events	
30.1	Overview of Repository Events.....	30-1
30.1.1	Repository Events: Use Cases.....	30-1

30.1.2	Repository Events and Database Triggers.....	30-2
30.1.3	Repository Event Listeners and Event Handlers.....	30-2
30.1.4	Repository Event Configuration	30-2
30.2	Possible Repository Events.....	30-3
30.3	Repository Operations and Events.....	30-6
30.4	Repository Event Handler Considerations	30-7
30.5	Configuration of Repository Events	30-9
30.5.1	Configuration Element event-listeners	30-10
30.5.2	Configuration Element listener	30-10
30.5.3	Repository Events Configuration Examples	30-11
31	Guidelines for Oracle XML DB Applications in Java	
31.1	Overview of Oracle XML DB Java Applications.....	31-1
31.2	HTTP(S): Access Java Servlets or Directly Access XMLType Resources.....	31-2
31.3	Use JDBC XMLType Support to Access Many XMLType Object Elements	31-2
31.4	Use Servlets to Manipulate and Write Out Data Quickly as XML.....	31-2
31.5	Oracle XML DB Java Servlet Support Restrictions	31-2
31.6	Configuration of Oracle XML DB Servlets.....	31-3
31.7	HTTP Request Processing for Oracle XML DB Servlets	31-7
31.8	Session Pool and Oracle XML DB Servlets.....	31-7
31.9	Native XML Stream Support.....	31-7
31.10	Oracle XML DB Servlet APIs	31-8
31.11	Oracle XML DB Servlet Example.....	31-8
32	Data Access Using URIs	
32.1	Overview of Oracle XML DB URI Features.....	32-1
32.2	URIs and URLs.....	32-1
32.3	URIType and its Subtypes	32-2
32.3.1	Overview of DBUris and XDBUris	32-4
32.3.2	URIType PL/SQL Methods	32-4
32.4	Accessing Data Using URIType Instances	32-7
32.5	XDBUris: Pointers to Repository Resources	32-10
32.5.1	XDBUri URI Syntax.....	32-11
32.5.2	Using XDBUri: Examples	32-11
32.6	DBUris: Pointers to Database Data.....	32-13
32.6.1	View the Database as XML Data.....	32-13
32.6.2	DBUri URI Syntax	32-15
32.6.3	DBUris are Scoped to a Database and Session.....	32-16
32.6.4	Using DBUris —Examples	32-17
32.7	Create New Subtypes of URIType Using Package URIFACTORY	32-21
32.7.1	Registering New URIType Subtypes with Package URIFACTORY	32-22
32.8	SYS_DBURIGEN SQL Function.....	32-23
32.8.1	Rules for Passing Columns or Object Attributes to SYS_DBURIGEN	32-24

32.8.2	Using SQL Function SYS_DBURIGEN: Examples	32-25
32.9	DBUriServlet.....	32-27
32.9.1	Overriding the MIME Type Using a URL	32-29
32.9.2	Customizing DBUriServlet	32-29
32.9.3	Using Roles for DBUriServlet Security.....	32-30
32.9.4	Configuring Package URIFACTORY to Handle DBUris.....	32-31
32.9.5	Table or View Access from a Web Browser Using DBUri Servlet	32-32

33 Native Oracle XML DB Web Services

33.1	Overview of Native Oracle XML DB Web Services.....	33-1
33.2	Configuring and Enabling Web Services for Oracle XML DB	33-2
33.2.1	Configuring Web Services for Oracle XML DB	33-2
33.2.2	Enabling Web Services for a Specific User	33-3
33.3	Query Oracle XML DB Using a Web Service.....	33-4
33.4	Access to PL/SQL Stored Procedures Using a Web Service	33-6
33.4.1	Using a PL/SQL Function with a Web Service: Example	33-8

Part VII Oracle Tools that Support Oracle XML DB

34 Administration of Oracle XML DB

34.1	Upgrade or Downgrade of an Existing Oracle XML DB Installation.....	34-1
34.1.1	Authentication Considerations for Database Installation, Upgrade and Downgrade	34-2
34.1.2	Automatic Installation of Oracle XML DB.....	34-3
34.1.3	Validation of ACL Documents and Configuration File.....	34-3
34.2	Administration of Oracle XML DB Using Oracle Enterprise Manager	34-4
34.3	Configuration of Oracle XML DB Using xdbconfig.xml.....	34-5
34.3.1	Oracle XML DB Configuration File, xdbconfig.xml.....	34-5
34.4	Oracle XML DB and Database Consolidation	34-13
34.5	Package DBMS_XDB_ADMIN	34-14

35 How to Load XML Data

35.1	Overview of Loading XMLType Data Into Oracle Database	35-1
35.2	Load XMLType Data Using SQL*Loader.....	35-2
35.2.1	Load XMLType LOB Data Using SQL*Loader	35-2
35.2.2	Load XMLType Data Directly from a Control File Using SQL*Loader	35-4
35.2.3	Loading Large XML Documents Using SQL*Loader	35-4

36 Export and Import of Oracle XML DB Data

36.1	Overview of Exporting and Importing XMLType Tables	36-1
36.2	Export/Import Limitations for Oracle XML DB Repository.....	36-3
36.3	Export/Import Syntax and Examples	36-3
36.3.1	Performing a Table-Mode Export /Import	36-3

36.3.2 Performing a Schema-Mode Export/Import.....	36-4
--	------

37 XML Data Exchange Using Oracle Streams AQ

37.1 XML and Oracle Streams Advanced Queuing.....	37-1
37.1.1 Oracle Streams Advanced Queuing and XML Message Payloads	37-1
37.1.2 Advantages of Using Oracle Streams Advanced Queuing.....	37-2
37.2 Oracle Streams and Advanced Queuing.....	37-3
37.2.1 Oracle Streams Message Queuing	37-3
37.3 XMLType Attributes in Object Types.....	37-4
37.4 Internet Data Access Presentation (iDAP): SOAP for AQ	37-4
37.5 iDAP Architecture	37-4
37.5.1 XMLType Queue Payloads	37-5
37.6 Guidelines for Using XML and Oracle Streams Advanced Queuing.....	37-7
37.6.1 Store Oracle Streams AQ XML Messages with Many PDFs as One Record	37-7
37.6.2 Add New Recipients After Messages Are Enqueued	37-8
37.6.3 Enqueue and Dequeue XML Messages.....	37-8
37.6.4 Parse Messages with XML Content from Oracle Streams AQ Queues	37-8
37.6.5 Prevent the Listener from Stopping Until an XML Document Is Processed	37-8
37.6.6 HTTPS with AQ.....	37-9
37.6.7 Store XML in Oracle Streams AQ Message Payloads	37-9
37.6.8 iDAP and SOAP.....	37-9

Part VIII Appendixes

A Oracle-Supplied XML Schemas and Examples

A.1 XDBResource.xsd: XML Schema for Oracle XML DB Resources	A-1
A.2 XDBResConfig.xsd: XML Schema for Resource Configuration.....	A-10
A.3 acl.xsd: XML Schema for ACLs	A-13
A.4 xdbconfig.xsd: XML Schema for Configuring Oracle XML DB.....	A-16
A.5 xdiff.xsd: XML Schema for Comparing Schemas for In-Place Evolution.....	A-29
A.6 Purchase-Order XML Schemas	A-31
A.7 XSLT Stylesheet Example, PurchaseOrder.xsl	A-41
A.8 Loading XML Data Using C (OCI).....	A-46
A.9 Initializing and Terminating an XML Context (OCI).....	A-49

B Oracle XML DB Restrictions

C Deprecated Functions for Updating XML Data

C.1 Migration from Oracle Functions for Updating XML Data to XQuery Update	C-1
C.2 Deprecated Oracle SQL Functions for Updating XML Data	C-5
C.2.1 Insertion of XML Elements Using Deprecated Oracle SQL Functions.....	C-6
C.3 UPDATEXML Deprecated Oracle SQL Function.....	C-7
C.3.1 Deprecated Oracle SQL Function UPDATEXML and NULL Values	C-11

C.3.2 Update of the Same XML Node More Than Once Using UPDATEXML (Deprecated)	C-13
C.3.3 Guidelines for DOM Fidelity When Using UPDATEXML (Deprecated)	C-13
C.4 Optimization of Deprecated Oracle SQL Functions that Modify XML Data	C-14
C.5 Creating XML Views Using Deprecated Oracle SQL Functions that Modify XML Data ..	C-16
C.6 INSERTCHILDXML Deprecated Oracle SQL Function	C-16
C.7 INSERTCHILDXMLBEFORE Deprecated Oracle SQL Function	C-19
C.8 INSERTCHILDXMLAFTER Deprecated Oracle SQL Function	C-20
C.9 INSERTXMLBEFORE Deprecated Oracle SQL Function	C-21
C.10 INSERTXMLAFTER Deprecated Oracle SQL Function	C-23
C.11 APPENDCHILDXML Deprecated Oracle SQL Function	C-24
C.12 DELETXML Deprecated Oracle SQL Function	C-25

D Deprecated Constructs for XML Translation

D.1 XML Translations (Deprecated)	D-1
D.1.1 Changes to an XML Schema and XML Instance Documents for Translation (Deprecated)	D-1
D.1.2 Making XML Documents Translatable (Deprecated)	D-2
D.1.3 Operations on Translated Documents (Deprecated)	D-8
D.2 PL/SQL Package DBMS_XMLTRANSLATIONS (Deprecated)	D-12
D.2.1 DBMS_XMLTRANSLATIONS Methods (Deprecated)	D-12

E Deprecated Content Repository API for Java

E.1 About the Content Repository API for Java (JCR)	E-1
E.2 About Oracle XML DB Content Connector	E-2
E.3 How Oracle XML DB Repository Is Exposed in JCR	E-2
E.4 CLASSPATH for Oracle XML DB Content Connector	E-3
E.5 Obtaining the JCR Repository Object	E-3
E.6 Java Code to Upload a File to the Repository using Oracle XML DB Content Connector....	E-4
E.7 Additional JCR Code Examples	E-5
E.8 Oracle XML DB Content Connector Uses the Standard Java Logging API	E-5
E.9 Supported JCR Compliance Levels	E-6
E.10 Oracle XML DB Content Connector Restrictions	E-6
E.11 XML Schemas and JCR	E-6

Index

List of Examples

3-1	Creating a Table with an XMLType Column.....	3-2
3-2	Creating a Table of XMLType.....	3-2
3-3	Creating a Virtual Column for an XML Attribute in an XMLType Table.....	3-3
3-4	Creating a Virtual Column for an XML Attribute in an XMLType Column.....	3-3
3-5	Partitioning a Relational Table That Has an XMLType Column	3-5
3-6	Partitioning an XMLType Table.....	3-5
3-7	Error From Attempting to Insert an Incorrect XML Document.....	3-6
3-8	Constraining a Binary XML Table Using a Virtual Column.....	3-7
3-9	Constraining a Binary XML Column Using a Virtual Column: Uniqueness.....	3-7
3-10	Constraining a Binary XML Column Using a Virtual Column: Foreign Key.....	3-8
3-11	Enforcing Database Integrity When Loading XML Using FTP.....	3-8
3-12	Creating a Database Directory.....	3-11
3-13	Inserting XML Content into an XMLType Table.....	3-11
3-14	Inserting Content into an XMLType Table Using Java.....	3-11
3-15	Inserting Content into an XMLType Table Using C.....	3-12
3-16	Inserting XML Content into the Repository Using CREATERESOURCE.....	3-14
3-17	PurchaseOrder XML Instance Document.....	3-15
3-18	Retrieving an Entire XML Document Using OBJECT_VALUE.....	3-16
3-19	Accessing XML Fragments Using XMLQUERY.....	3-17
3-20	Accessing a Text Node Value Using XMLCAST and XMLQuery.....	3-18
3-21	Searching XML Content Using XMLEExists, XMLCast, and XMLQuery.....	3-19
3-22	Joining Data from an XMLType Table and a Relational Table.....	3-22
3-23	Accessing Description Nodes Using XMLTABLE.....	3-23
3-24	Counting the Number of Elements in a Collection Using XMLTABLE.....	3-24
3-25	Counting the Number of Child Elements in an Element Using XMLTABLE.....	3-25
3-26	Updating a Text Node.....	3-25
3-27	Replacing an Entire Element Using XQuery Update.....	3-26
3-28	Changing Text Node Values Using XQuery Update.....	3-27
3-29	Generating XML Data Using SQL/XML Functions.....	3-29
3-30	Creating XMLType Views Over Conventional Relational Tables.....	3-30
3-31	Querying XMLType Views.....	3-30
3-32	Generating XML Data from a Relational Table Using DBURITYPE and getXML().....	3-33
3-33	Restricting Rows Using an XPath Predicate.....	3-33
3-34	Restricting Rows and Columns Using an XPath Predicate.....	3-33
4-1	Chaining XMLTable Calls.....	4-14
4-2	Finding a Node Using SQL/XML Function XMLEExists.....	4-16
4-3	Extracting the Scalar Value of an XML Fragment Using XMLCAST.....	4-18
4-4	Static Type-Checking of XQuery Expressions: oradb URI scheme.....	4-26
4-5	Static Type-Checking of XQuery Expressions: XML Schema-Based Data.....	4-26
5-1	Creating Resources for Examples.....	5-2
5-2	XMLQuery Applied to a Sequence of Items of Different Types.....	5-3
5-3	FLOWR Expression Using for, let, order by, where, and return.....	5-3
5-4	FLOWR Expression Using Built-In Functions.....	5-4
5-5	Querying Relational Data as XML Using XMLQuery.....	5-6
5-6	Querying Relational Data as XML Using a Nested FLWOR Expression.....	5-7
5-7	Querying Relational Data as XML Using XMLTable.....	5-9
5-8	Querying an XMLType Column Using XMLQuery PASSING Clause.....	5-12
5-9	Using XMLTABLE with XML Schema-Based Data.....	5-13
5-10	Using XMLQUERY with XML Schema-Based Data.....	5-13
5-11	Using XMLTABLE with PASSING and COLUMNS Clauses.....	5-13
5-12	Using XMLTABLE with RETURNING SEQUENCE BY REF.....	5-14

5-13	Using Chained XMLTABLE with Access by Reference.....	5-15
5-14	Using XMLTABLE to Decompose XML Collection Elements into Relational Data.....	5-15
5-15	Using XMLQUERY with a Namespace Declaration.....	5-16
5-16	Using XMLTABLE with the XMLNAMESPACES Clause.....	5-17
5-17	Querying XMLTYPE Data.....	5-18
5-18	Querying Transient XMLTYPE Data Using a PL/SQL Cursor	5-19
5-19	Extracting XML Data and Inserting It into a Relational Table Using SQL.....	5-20
5-20	Extracting XML Data and Inserting It into a Table Using PL/SQL.....	5-21
5-21	Searching XML Data Using SQL/XML Functions.....	5-21
5-22	Extracting Fragments Using XMLQUERY.....	5-22
5-23	Using the SQL*Plus XQUERY Command.....	5-22
5-24	Using XQuery with PL/SQL.....	5-24
5-25	Using XQuery with JDBC.....	5-25
5-26	Using XQuery with ODP.NET and C#.....	5-26
5-27	Updating XMLType Data Using SQL UPDATE.....	5-27
5-28	Updating XMLTYPE Data Using SQL UPDATE and XQuery Update.....	5-29
5-29	Updating Multiple Text Nodes and Attribute Nodes.....	5-29
5-30	Updating Selected Nodes within a Collection.....	5-30
5-31	Incorrectly Updating a Node That Occurs Multiple Times in a Collection.....	5-32
5-32	Correctly Updating a Node That Occurs Multiple Times in a Collection.....	5-32
5-33	NULL Updates – Element and Attribute.....	5-34
5-34	NULL Updates – Text Node.....	5-35
5-35	Inserting an Element into a Collection.....	5-36
5-36	Inserting an Element that Uses a Namespace.....	5-37
5-37	Inserting an Element Before an Element.....	5-37
5-38	Inserting an Element as the Last Child Element.....	5-38
5-39	Deleting an Element.....	5-39
5-40	Creating a View Using Updated XML Data.....	5-39
5-41	Optimization of XMLQuery over Relational Data.....	5-42
5-42	Optimization of XMLTable over Relational Data.....	5-42
5-43	Optimization of XMLQuery with Schema-Based XMLType Data.....	5-43
5-44	Optimization of XMLTable with Schema-Based XMLType Data.....	5-44
5-45	Unoptimized Repository Query Using fn:doc.....	5-47
5-46	Optimized Repository Query Using EQUALS_PATH.....	5-47
5-47	Repository Query Using Oracle XQuery Pragma ora:defaultTable.....	5-48
6-1	Making Query Data Compatible with Index Data – SQL Cast.....	6-13
6-2	Making Query Data Compatible with Index Data – XQuery Cast.....	6-13
6-3	Exchange-Partitioning Tables That Have an XMLIndex Structured Component.....	6-14
6-4	Exchange-Partitioning Reference-Partitioned Tables That Use XMLIndex.....	6-14
6-5	Data Used in Example of Exchange-Partitioning for Reference-Partitioned Tables.....	6-15
6-6	Path Table Contents for Two Purchase Orders.....	6-17
6-7	Creating an XMLIndex Index.....	6-21
6-8	Obtaining the Name of an XMLIndex Index on a Particular Table.....	6-21
6-9	Renaming and Dropping an XMLIndex Index.....	6-22
6-10	Naming the Path Table of an XMLIndex Index.....	6-23
6-11	Determining the System-Generated Name of an XMLIndex Path Table.....	6-23
6-12	Specifying Storage Options When Creating an XMLIndex Index.....	6-23
6-13	Dropping an XMLIndex Unstructured Component.....	6-23
6-14	Determining the Names of the Secondary Indexes of an XMLIndex Index.....	6-23
6-15	Creating a Function-Based Index on Path-Table Column VALUE.....	6-25
6-16	Trying to Create a Numeric Index on Path-Table Column VALUE Directly.....	6-25
6-17	Creating a Numeric Index on Column VALUE with Procedure createNumberIndex...	6-25
6-18	Creating a Date Index on Column VALUE with Procedure createDateIndex.....	6-25
6-19	Creating an Oracle Text CONTEXT Index on Path-Table Column VALUE.....	6-25

6-20	Showing All Secondary Indexes on an XMLIndex Path Table.....	6-25
6-21	XMLIndex with a Structured Component, Using Namespaces and Storage Options....	6-27
6-22	XMLIndex with a Structured Component, Specifying TABLESPACE at the Index Level.....	6-27
6-23	XMLIndex Index: Adding a Structured Component.....	6-28
6-24	Using DBMS_XMLINDEX.PROCESS_PENDING To Index XML Data.....	6-30
6-25	Dropping an XMLIndex Structured Component.....	6-31
6-26	Creating a B-tree Index on an XMLIndex Index Content Table.....	6-31
6-27	Checking Whether an XMLIndex Unstructured Component Is Used.....	6-33
6-28	Obtaining the Name of an XMLIndex Index from Its Path-Table Name.....	6-34
6-29	Extracting Data from an XML Fragment Using XMLIndex.....	6-34
6-30	Using a Structured XMLIndex Component for a Query with Two Predicates.....	6-35
6-31	Using a Structured XMLIndex Component for a Query with Multilevel Chaining.....	6-36
6-32	Turning Off XMLIndex Using Optimizer Hints.....	6-37
6-33	XMLIndex Path Subsetting with CREATE INDEX.....	6-38
6-34	XMLIndex Path Subsetting with ALTER INDEX.....	6-38
6-35	XMLIndex Path Subsetting Using a Namespace Prefix.....	6-38
6-36	Creating an XMLIndex Index in Parallel.....	6-42
6-37	Using Different PARALLEL Degrees for XMLIndex Internal Objects.....	6-42
6-38	Specifying Deferred Synchronization for XMLIndex.....	6-44
6-39	Manually Synchronizing an XMLIndex Index Using SYNCINDEX.....	6-44
6-40	Automatic Collection of Statistics on XMLIndex Objects.....	6-45
6-41	Creating an XML Search Index.....	6-57
6-42	XQuery Full Text Query.....	6-57
6-43	Execution Plan for XQuery Full Text Query.....	6-58
6-44	XQuery Full Text Query with XML Schema-Based Data: Error ORA-18177.....	6-59
6-45	Using XQuery Pragma ora:no_schema with XML Schema-Based Data.....	6-59
6-46	Full-Text Query with XQuery Pragma ora:use_xmltext_idx.....	6-60
6-47	CREATE INDEX Using XMLCAST and XMLQUERY on a Singleton Element.....	6-63
6-48	CREATE INDEX Using EXTRACTVALUE on a Singleton Element.....	6-63
7-1	XSLT Stylesheet Example: PurchaseOrder.xml.....	7-2
7-2	Registering an XML Schema and Inserting XML Data.....	7-4
7-3	Using SQL Function XMLTRANSFORM to Apply an XSL Stylesheet.....	7-6
7-4	Using XMLType Method TRANSFORM() with a Transient XSL Stylesheet.....	7-7
7-5	Using XMLTRANSFORM to Apply an XSL Stylesheet Retrieved Using XDBURITYPE..	7-8
7-6	Error When Inserting Incorrect XML Document (Partial Validation).....	7-13
7-7	Forcing Full XML Schema Validation Using a CHECK Constraint.....	7-14
7-8	Enforcing Full XML Schema Validation Using a BEFORE INSERT Trigger.....	7-14
7-9	Validating XML Using Method ISSCHEMAVALID() in SQL.....	7-15
7-10	Validating XML Using Method ISSCHEMAVALID() in PL/SQL.....	7-15
7-11	Validating XML Using Method SCHEMAVALIDATE() within Triggers.....	7-15
7-12	Checking XML Validity Using XMLISVALID Within CHECK Constraints.....	7-15
8-1	XMLELEMENT: Formatting a Date.....	8-7
8-2	XMLELEMENT: Generating an Element for Each Employee.....	8-7
8-3	XMLELEMENT: Generating Nested XML	8-7
8-4	XMLELEMENT: Generating Employee Elements with Attributes ID and Name.....	8-8
8-5	XMLELEMENT: Characters in Generated XML Data Are Not Escaped.....	8-8
8-6	Creating a Schema-Based XML Document Using XMLELEMENT with Namespaces....	8-8
8-7	XMLELEMENT: Generating an Element from a User-Defined Data-Type Instance.....	8-9
8-8	XMLFOREST: Generating Elements with Attribute and Child Elements.....	8-10
8-9	XMLFOREST: Generating an Element from a User-Defined Data-Type Instance.....	8-11
8-10	XMLCONCAT: Concatenating XMLType Instances from a Sequence.....	8-12
8-11	XMLCONCAT: Concatenating XML Elements	8-12
8-12	XMLAGG: Generating a Department Element with Child Employee Elements.....	8-13

8-13	XMLAGG: Using GROUP BY to Generate Multiple Department Elements.....	8-13
8-14	XMLAGG: Generating Nested Elements.....	8-14
8-15	Using SQL/XML Function XMLPI.....	8-16
8-16	Using SQL/XML Function XMLCOMMENT.....	8-16
8-17	Using SQL/XML Function XMLSERIALIZE.....	8-18
8-18	Using SQL/XML Function XMLPARSE.....	8-19
8-19	XMLCOLATTVAL: Generating Elements with Attribute and Child Elements.....	8-20
8-20	Using Oracle SQL Function XMLCDATA.....	8-21
8-21	DBMS_XMLGEN: Generating Simple XML.....	8-30
8-22	DBMS_XMLGEN: Generating Simple XML with Pagination (Fetch).....	8-31
8-23	DBMS_XMLGEN: Generating XML Using Object Types.....	8-32
8-24	DBMS_XMLGEN: Generating XML Using User-Defined Data-Type Instances.....	8-34
8-25	DBMS_XMLGEN: Generating an XML Purchase Order.....	8-35
8-26	DBMS_XMLGEN: Generating a New Context Handle from a REF Cursor.....	8-39
8-27	DBMS_XMLGEN: Specifying NULL Handling.....	8-40
8-28	DBMS_XMLGEN: Generating Recursive XML with a Hierarchical Query.....	8-42
8-29	DBMS_XMLGEN: Binding Query Variables Using SETBINDVALUE()	8-44
8-30	Using XMLAGG ORDER BY Clause.....	8-46
8-31	Returning a Rowset Using XMLTABLE.....	8-47
9-1	Creating a Relational View of XML Content.....	9-2
9-2	Accessing Individual Members of a Collection Using a View.....	9-3
9-3	XMLIndex Index that Matches Relational View Columns.....	9-4
9-4	XMLTable Expression Returned by PL/SQL Function getSIDXDefFromView.....	9-4
9-5	Querying Master Relational View of XML Data.....	9-5
9-6	Querying Master and Detail Relational Views of XML Data.....	9-5
9-7	Business-Intelligence Query of XML Data Using a View.....	9-6
10-1	Creating an XMLType View Using XMLELEMENT	10-3
10-2	Registering XML Schema emp_simple.xsd.....	10-5
10-3	Creating an XMLType View Using SQL/XML Publishing Functions.....	10-5
10-4	Querying an XMLType View.....	10-6
10-5	Using Namespace Prefixes with SQL/XML Publishing Functions.....	10-6
10-6	XML Schema with No Target Namespace.....	10-7
10-7	Creating a View for an XML Schema with No Target Namespace.....	10-8
10-8	Using SQL/XML Functions in XML Schema-Based XMLType Views.....	10-8
10-9	Creating Object Types for Schema-Based XMLType Views.....	10-11
10-10	Creating and Registering XML Schema emp_complex.xsd.....	10-12
10-11	Creating XMLType View emp_xml Using Object Type emp_t.....	10-13
10-12	Creating an Object View and an XMLType View Based on the Object View.....	10-13
10-13	Creating Object Types.....	10-14
10-14	Registering XML Schema dept_complex.xsd.....	10-14
10-15	Creating XMLType View dept_xml Using Object Type dept_t.....	10-16
10-16	Creating XMLType View dept_xml Using Relational Data Directly.....	10-16
10-17	Creating an XMLType View by Restricting Rows from an XMLType Table.....	10-17
10-18	Creating an XMLType View by Transforming an XMLType Table.....	10-17
10-19	Determining Whether an XMLType View Is Implicitly Updatable, and Updating It..	10-18
11-1	Creating and Manipulating a DOM Document.....	11-14
11-2	Creating an Element Node and Obtaining Information About It.....	11-15
11-3	Creating a User-Defined Subtype of SYS.util_BinaryOutputStream().....	11-18
11-4	Retrieving Node Value with a User-Defined Stream.....	11-18
11-5	Get-Pull of Binary Data.....	11-19
11-6	Get-Pull of Character Data.....	11-19
11-7	Set-Pull of Binary Data.....	11-21
11-8	Set-Push of Binary Data.....	11-22
11-9	Parsing an XML Document.....	11-23

11-10	Transforming an XML Document Using an XSL Stylesheet.....	11-26
12-1	Inserting Data with Specified Columns.....	12-2
12-2	Updating Data with Key Columns.....	12-4
12-3	DBMS_XMLSTORE.DELETXML Example.....	12-4
13-1	Querying an XMLType Table Using JDBC.....	13-2
13-2	Selecting XMLType Data Using getString() and getCLOB().....	13-3
13-3	Returning XMLType Data Using getSQLXML().....	13-3
13-4	Returning XMLType Data Using an Output Parameter.....	13-3
13-5	Updating an XMLType Column Using SQL Constructor XMLType and Java String....	13-5
13-6	Updating an XMLType Column Using SQLXML.....	13-5
13-7	Retrieving Metadata About an XMLType Column Using JDBC.....	13-5
13-8	Updating an XMLType Column Using JDBC.....	13-5
13-9	Updated Purchase-Order Document.....	13-7
13-10	Inserting an XMLType column using JDBC.....	13-9
13-11	Converting an XML String to an OracleClob Instance.....	13-9
13-12	Policy File Granting Permissions for Java DOM API.....	13-10
13-13	Creating a DOM Object with the Java DOM API.....	13-10
13-14	Using the Java DOM API with a Binary XML Column.....	13-18
14-1	Using OCIXMLDBINITXMLCTX() and OCIXMLDBFREEXMLCTX().....	14-4
14-2	Using the C API for XML with Binary XML.....	14-8
14-3	Using the Oracle XML DB Pull Parser.....	14-10
14-4	Using the DOM to Count Ordered Parts.....	14-15
15-1	Retrieve XMLType Data to .NET.....	15-2
17-1	Registering an XML Schema Using DBMS_XMLSCHEMA.REGISTERSCHEMA.....	17-10
17-2	Objects Created During XML Schema Registration.....	17-10
17-3	Registering a Local XML Schema.....	17-13
17-4	Registering a Global XML Schema.....	17-14
17-5	Deleting an XML Schema with DBMS_XMLSCHEMA.DELETESCHEMA.....	17-16
17-6	Data Dictionary Table for Registered Schemas.....	17-16
17-7	Creating XML Schema-Based XMLType Tables and Columns.....	17-19
17-8	Creating an Object-Relational XMLType Table with Default Storage.....	17-24
17-9	Specifying Object-Relational Storage Options for XMLType Tables and Columns.....	17-24
17-10	Using STORE ALL VARRAYS AS.....	17-24
18-1	SQL Object Types for Storing XMLType Tables.....	18-4
18-2	Default Table for Global Element PurchaseOrder.....	18-5
18-3	Using Common Schema Annotations.....	18-9
18-4	Registering an Annotated XML Schema.....	18-10
18-5	Using DBMS_XMLSCHEMA_ANNOTATE.....	18-13
18-6	Querying View USER_XML_SCHEMAS for a Registered XML Schema.....	18-19
18-7	Querying Metadata from a Registered XML Schema.....	18-19
18-8	Mapping XML Schema Data Types to SQL Data Types Using Attribute SQLType....	18-20
18-9	XML Schema Inheritance: complexContent as an Extension of complexTypes.....	18-30
18-10	Inheritance in XML Schema: Restrictions in complexTypes.....	18-30
18-11	XML Schema complexType: Mapping complexType to simpleContent.....	18-31
18-12	XML Schema: Mapping complexType to any/anyAttribute.....	18-32
18-13	Creating an XMLType Table that Conforms to an XML Schema.....	18-34
18-14	Creating an XMLType Table for Nested Collections.....	18-34
18-15	Using DESCRIBE with an XML Schema-Based XMLType Table.....	18-34
18-16	Specifying Partitioning Information During XML Schema Registration.....	18-36
18-17	Specifying Partitioning Information During Table Creation.....	18-36
18-18	Integrity Constraints and Triggers for an XMLType Table Stored Object-Relationally	18-38
18-19	Adding a Unique Constraint to the Parent Element of an Attribute.....	18-39
18-20	Setting SQLInline to False for Out-Of-Line Storage.....	18-41
18-21	Generated XMLType Tables and Types.....	18-42

18-22	Querying an Out-Of-Line Table.....	18-42
18-23	Storing a Collection Out of Line.....	18-43
18-24	Generated Out-Of-Line Collection Type.....	18-44
18-25	Renaming an Intermediate Table of REF Values.....	18-44
18-26	XPath Rewrite for an Out-Of-Line Collection.....	18-44
18-27	XPath Rewrite for an Out-Of-Line Collection, with Index on REFS.....	18-45
18-28	An XML Schema with Circular Dependency.....	18-45
18-29	XML Schema: Cycling Between complexTypes.....	18-48
18-30	XML Schema: Cycling Between complexTypes, Self-Reference.....	18-48
18-31	An XML Schema that Includes a Non-Existent XML Schema.....	18-50
18-32	Using the FORCE Option to Register XML Schema xm40.xsd.....	18-50
18-33	Trying to Create a Table Using a Cyclic XML Schema.....	18-50
18-34	Using the FORCE Option to Register XML Schema xm40a.xsd.....	18-51
18-35	Recursive XML Schema.....	18-52
18-36	Out-of-line Table.....	18-52
18-37	Invalid Default Table Sharing.....	18-53
18-38	Oracle XML DB XML Schema: Mapping complexType XML Fragments to LOBs.....	18-55
19-1	XPath Rewrite.....	19-2
19-2	XPath Rewrite for an Out-Of-Line Table.....	19-4
19-3	Using an Index with an Out-Of-Line Table.....	19-4
19-4	Execution Plan Generated When XPath Rewrite Does Not Occur.....	19-5
19-5	Analyzing an Execution Plan to Determine a Column to Index.....	19-7
19-6	Using DBMS_XMLSTORAGE_MANAGE.XPATH2TABCOLMAPPING.....	19-7
19-7	Creating an Index on a Column Targeted by a Predicate.....	19-8
19-8	Creating a Function-Based Index for a Column Targeted by a Predicate.....	19-8
19-9	Execution Plan Showing that Index Is Picked Up.....	19-8
19-10	Creating a Function-Based Index for a Column Targeted by a Predicate.....	19-8
19-11	Execution Plan for a Selection of Collection Elements.....	19-9
19-12	Creating an Index for Direct Access to an Ordered Collection Table.....	19-10
20-1	Revised Purchase-Order XML Schema.....	20-2
20-2	evolvePurchaseOrder.xsl: XSLT Stylesheet to Update Instance Documents.....	20-10
20-3	Loading Revised XML Schema and XSLT Stylesheet.....	20-15
20-4	Updating an XML Schema Using DBMS_XMLSCHEMA.COPYEVOLVE.....	20-15
20-5	Splitting a Complex Type into Two Complex Types.....	20-17
20-6	diffXML Parameter Document.....	20-22
21-1	Querying PATH_VIEW to Determine Link Type.....	21-12
21-2	Obtaining the OID Path of a Resource.....	21-13
21-3	Creating a Weak Link Using an OID Path.....	21-13
21-4	Accessing a Text Document in the Repository Using XDBURITYPE.....	21-28
21-5	Accessing Resource Content Using RESOURCE_VIEW.....	21-28
21-6	Accessing XML Documents Using Resource and Namespace Prefixes.....	21-29
21-7	Querying Repository Resource Data Using SQL Function REF and Element XMLRef.....	21-30
21-8	Selecting XML Document Fragments Based on Metadata, Path, and Content.....	21-30
21-9	Updating a Text Document Using UPDATE and XQuery Update on the Resource....	21-32
21-10	Updating an XML Node Using UPDATE and XQuery Update on the Resource.....	21-32
21-11	Updating XML Schema-Based Documents in the Repository.....	21-33
21-12	Accessing Resources Using EQUALS_PATH and RESOURCE_VIEW.....	21-35
21-13	Determining the Path to XSLT Stylesheets Stored in the Repository.....	21-36
21-14	Counting Resources Under a Path.....	21-36
21-15	Listing the Folder Contents in a Path.....	21-36
21-16	Listing the Links Contained in a Folder.....	21-37
21-17	Finding Paths to Resources that Contain Purchase-Order XML Documents.....	21-37
21-18	Execution Plan Output for a Folder-Restricted Query.....	21-38
22-1	Resource Configuration File.....	22-5

22-2	applicationData Element.....	22-5
23-1	XInclude Used in a Book Document to Include Parts and Chapters.....	23-4
23-2	Expanding Document Inclusions Using XDBURITYPE.....	23-6
23-3	Querying Document Links Mapped From XLink Links	23-9
23-4	Querying Document Links Mapped From XInclude Links	23-9
23-5	Mapping XInclude Links to Hard Document Links, with OID Retrieval.....	23-15
23-6	Mapping XLink Links to Weak Links, with Named-Path Retrieval.....	23-15
23-7	Configuring XInclude Document Decomposition.....	23-15
23-8	Repository Document, Showing Generated xi:include Elements.....	23-15
24-1	Determining Paths Under a Path: Relative.....	24-9
24-2	Determining Paths Under a Path: Absolute.....	24-9
24-3	Determining Paths Not Under a Path.....	24-9
24-4	Determining Paths Using Multiple Correlations	24-10
24-5	Relative Path Names for Three Levels of Resources.....	24-10
24-6	Extracting Resource Metadata Using UNDER_PATH.....	24-10
24-7	Using Functions PATH and DEPTH with PATH_VIEW.....	24-11
24-8	Extracting Link and Resource Information from PATH_VIEW	24-11
24-9	All Repository Paths to a Certain Depth Under a Path	24-12
24-10	Locating a Repository Path Using EQUALS_PATH.....	24-13
24-11	Retrieve RESID of a Given Resource.....	24-13
24-12	Obtaining the Path Name of a Resource from its RESID.....	24-13
24-13	Folders Under a Given Path.....	24-13
24-14	Joining RESOURCE_VIEW with an XMLType Table.....	24-14
24-15	Deleting Resources.....	24-15
24-16	Deleting Links to Resources.....	24-15
24-17	Deleting a Nonempty Folder.....	24-15
24-18	Updating a Resource.....	24-17
24-19	Updating a Path in the PATH_VIEW	24-18
24-20	Updating Resources Based on Attributes.....	24-19
24-21	Finding Resources Inside a Folder.....	24-19
24-22	Copying Resources.....	24-19
24-23	Find All Resources Containing "Paper".....	24-22
24-24	Find All Resources Containing "Paper" that are Under a Specified Path.....	24-22
25-1	Creating a Repository Resource.....	25-7
25-2	Creating a Version-Controlled Resource.....	25-7
25-3	Retrieving Resource Content by Referencing the Resource ID.....	25-8
25-4	Checking Out a Version-Controlled Resource.....	25-8
25-5	Updating Resource Content.....	25-8
25-6	Checking In a Version-Controlled Resource.....	25-9
25-7	Retrieving Resource Version Content Using XDBURITYPE and CREATEOIDPATH..	25-9
25-8	Retrieving Resource Version Content Using GETCONTENTSLOBBYRESID.....	25-9
25-9	Retrieving Resource Version Metadata Using GETRESOURCEBYRESID.....	25-10
25-10	Canceling a Check-Out Using UNCHECKOUT.....	25-11
26-1	Managing Resources Using DBMS_XDB_REPOS.....	26-3
26-2	Using DBMS_XDB_REPOS.GETACLDOCUMENT.....	26-4
26-3	Using DBMS_XDB_REPOS.SETACL.....	26-5
26-4	Using DBMS_XDB_REPOS.CHANGEPRIVILEGES.....	26-6
26-5	Using DBMS_XDB_REPOS.GETPRIVILEGES.....	26-7
26-6	Using DBMS_XDB_CONFIG.CFG_GET.....	26-9
26-7	Using DBMS_XDB_CONFIG.CFG_UPDATE.....	26-10
27-1	Simple Access Control Entry (ACE) that Grants a Privilege.....	27-4
27-2	Simple Access Control List (ACL) that Grants a Privilege.....	27-5
27-3	Complementing a Set of Principals with Element invert.....	27-10
27-4	Creating an ACL Using CREATERESOURCE.....	27-11

27-5	Retrieving an ACL Document, Given its Repository Path.....	27-11
27-6	Setting the ACL of a Resource.....	27-12
27-7	Deleting an ACL.....	27-12
27-8	Updating (Replacing) an Access Control List.....	27-13
27-9	Appending ACEs to an Access Control List.....	27-13
27-10	Deleting an ACE from an Access Control List.....	27-14
27-11	Retrieving the ACL Document for a Resource.....	27-14
27-12	Retrieving Privileges Granted to the Current User for a Particular Resource.....	27-15
27-13	Checking If a User Has a Certain Privileges on a Resource.....	27-15
27-14	Checking User Privileges Using ACLCheckPrivileges.....	27-16
27-15	Retrieving the Path of the ACL that Protects a Given Resource.....	27-17
27-16	Retrieving the Paths of All Resources Protected by a Given ACL.....	27-17
27-17	ACL Referencing an LDAP User.....	27-21
27-18	ACL Referencing an LDAP Group.....	27-21
28-1	Listener Status with FTP and HTTP(S) Protocol Support Enabled.....	28-9
28-2	Uploading Content to the Repository Using FTP.....	28-15
28-3	Navigating Oracle ASM Folders.....	28-17
28-4	Transferring Oracle ASM Files Between Databases with FTP proxy Method.....	28-17
28-5	FTP Connection Using IPv6.....	28-19
28-6	Modifying the Default Timeout Value of an FTP Session.....	28-20
29-1	Registering an XML Schema for Technical Photo Information.....	29-4
29-2	Registering an XML Schema for Photo Categorization.....	29-4
29-3	Add Metadata to a Resource – Technical Photo Information.....	29-6
29-4	Add Metadata to a Resource – Photo Content Categories.....	29-6
29-5	Delete Specific Metadata from a Resource.....	29-7
29-6	Adding Metadata to a Resource Using DML with RESOURCE_VIEW.....	29-7
29-7	Adding Metadata Using WebDAV PROPPATCH.....	29-9
29-8	Query XML Schema-Based Resource Metadata.....	29-10
29-9	Add Non-Schema-Based Metadata to a Resource.....	29-12
30-1	Resource Configuration File for Java Event Listeners with Preconditions.....	30-12
30-2	Resource Configuration File for PL/SQL Event Listeners with No Preconditions.....	30-13
30-3	PL/SQL Code Implementing Event Listeners.....	30-14
30-4	Java Code Implementing Event Listeners.....	30-15
30-5	Invoking Event Handlers.....	30-17
31-1	An Oracle XML DB Servlet.....	31-8
31-2	Registering and Mapping an Oracle XML DB Servlet.....	31-9
32-1	Using HTTPURIType PL/SQL Method GETCONTENTTYPE().....	32-6
32-2	Creating and Querying a URI Column.....	32-8
32-3	Using Different Kinds of URI, Created in Different Ways.....	32-9
32-4	Access a Repository Resource by URI Using an XDBUri.....	32-12
32-5	Using PL/SQL Method GETXML with XMLCAST and XMLQUERY	32-13
32-6	Targeting a Complete Table Using a DBUri.....	32-17
32-7	Targeting a Particular Row in a Table Using a DBUri.....	32-18
32-8	Targeting a Specific Column Using a DBUri.....	32-19
32-9	Targeting an Object Column with Specific Attribute Values Using a DBUri.....	32-19
32-10	Retrieve Only the Text Value of a Node Using a DBUri.....	32-20
32-11	Targeting a Collection Using a DBUri.....	32-21
32-12	URIFACTORY: Registering the ECOM Protocol	32-23
32-13	SYS_DBURIGEN: Generating a DBUri that Targets a Column.....	32-24
32-14	Passing Columns with Single Arguments to SYS_DBURIGEN.....	32-25
32-15	Inserting Database References Using SYS_DBURIGEN.....	32-25
32-16	Creating the Travel Story Table.....	32-26
32-17	A Function that Returns the First 20 Characters.....	32-26
32-18	Creating a Travel View for Use with SYS_DBURIGEN.....	32-26

32-19	Retrieving a URL Using SYS_DBURIGEN in RETURNING Clause.....	32-27
32-20	Changing the Installation Location of DBUriServlet.....	32-30
32-21	Restricting Servlet Access to a Database Role.....	32-31
32-22	Registering a Handler for a DBUri Prefix	32-32
33-1	Adding a Web Services Configuration Servlet.....	33-3
33-2	Verifying Addition of Web Services Configuration Servlet.....	33-3
33-3	XML Schema for Database Queries To Be Processed by Web Service.....	33-5
33-4	Input XML Document for SQL Query Using Query Web Service.....	33-6
33-5	Output XML Document for SQL Query Using Query Web Service.....	33-6
33-6	Definition of PL/SQL Function Used for Web-Service Access.....	33-8
33-7	WSDL Document Corresponding to a Stored PL/SQL Function.....	33-9
33-8	Input XML Document for PL/SQL Query Using Web Service.....	33-10
33-9	Output XML Document for PL/SQL Query Using Web Service.....	33-10
34-1	Oracle XML DB Configuration File.....	34-8
34-2	Updating the Configuration File Using CFG_UPDATE and CFG_GET.....	34-11
35-1	Data File filelist.dat: List of XML Files to Load.....	35-4
35-2	Control File load_datra.ctl, for Loading Purchase-Order XML Documents.....	35-5
35-3	Loading XML Data Using Shell Command sqlldr.....	35-5
36-1	Exporting XMLType Data in TABLE Mode.....	36-4
36-2	Importing XMLType Data in TABLE Mode.....	36-4
36-3	Creating Table po2.....	36-5
36-4	Exporting XMLType Data in SCHEMA Mode.....	36-5
36-5	Importing XMLType Data in SCHEMA Mode	36-5
36-6	Importing XMLType Data in SCHEMA Mode, Remapping Schema.....	36-5
37-1	Creating a Queue Table and Queue.....	37-6
37-2	Creating a Transformation to Convert Message Data to XML.....	37-6
37-3	Applying a Transformation before Sending Messages Overseas.....	37-6
37-4	XMLType and AQ: Dequeuing Messages.....	37-7
A-1	Unannotated Purchase-Order XML Schema.....	A-31
A-2	Annotated Purchase-Order XML Schema.....	A-34
A-3	Revised Annotated Purchase-Order XML Schema.....	A-36
A-4	PurchaseOrder.xsl XSLT Stylesheet.....	A-41
A-5	Inserting XML Data into an XMLType Table Using C.....	A-46
A-6	Using OCIXmlDbInitXmlCtx() and OCIXmlDbFreeXmlCtx().....	A-50
C-1	Updating XMLTYPE Using UPDATE and UPDATEXML (Deprecated).....	C-8
C-2	Updating Multiple Text Nodes and Attribute Values Using UPDATEXML (Deprecated).....	C-9
C-3	Updating Selected Nodes within a Collection Using UPDATEXML (Deprecated).....	C-10
C-4	NULL Updates with UPDATEXML (Deprecated) – Element and Attribute.....	C-12
C-5	NULL Updates with UPDATEXML (Deprecated) – Text Node.....	C-13
C-6	XPath Expressions in UPDATEXML Expression.....	C-15
C-7	Object Relational Equivalent of UPDATEXML Expression.....	C-15
C-8	Creating a View Using UPDATEXML (Deprecated).....	C-16
C-9	Insertion into a Collection Using INSERTCHILDXML (Deprecated).....	C-18
C-10	Inserting an Element that Uses a Namespace.....	C-19
C-11	Insertion Before an Element Using INSERTXMLBEFORE (Deprecated).....	C-22
C-12	Insertion as the Last Child Using APPENDCHILDXML (Deprecated).....	C-25
C-13	Deletion of an Element Using DELETXML (Deprecated).....	C-26
D-1	XML Schema Defining Documents with a Title To Be Translated.....	D-2
D-2	Untranslated Instance Document.....	D-4
D-3	XML Schema with Attribute xdb:translate for a Single-Valued Element.....	D-4
D-4	Translated Document.....	D-6
D-5	XML Schema with Attribute xdb:translate for a Multi-Valued Element.....	D-6
D-6	Translated Document for an XML Schema with Multiple-Valued Elements.....	D-8

D-7	Inserting a Document with No Language Information.....	D-10
D-8	Document After Insertion into the Repository.....	D-11
D-9	Inserting a Document with Language Information.....	D-11
D-10	Document After Insertion.....	D-11
E-1	Code Fragment Showing How to Get a Repository Object.....	E-3
E-2	Uploading a File Using Oracle XML DB Content Connector.....	E-4
E-3	Uploading a File Using the Command Line.....	E-5

List of Figures

1-1	Oracle XML DB Benefits.....	1-3
1-2	Unifying Data and Content: Some Common XML Architectures.....	1-4
1-3	XMLType Storage.....	1-9
1-4	Oracle XML DB Repository Architecture.....	1-18
2-1	Oracle XML DB Storage Options for XML Data.....	2-3
3-1	Loading Content into the Repository Using Windows Explorer.....	3-14
4-1	XMLQUERY Syntax.....	4-10
4-2	XMLTABLE Syntax.....	4-11
4-3	XMLExists Syntax.....	4-15
4-4	XMLCast Syntax.....	4-16
6-1	XML Use Cases and XML Indexing.....	6-9
7-1	XMLTRANSFORM Syntax.....	7-3
7-2	Using XMLTRANSFORM.....	7-4
7-3	Database XSL Transformation of a PurchaseOrder Using DBUri Servlet.....	7-10
7-4	Database XSL Transformation of Departments Table Using DBUri Servlet.....	7-11
8-1	XMLELEMENT Syntax.....	8-3
8-2	XMLAttributes Clause Syntax (XMLATTRIBUTES).....	8-4
8-3	XMLFOREST Syntax.....	8-10
8-4	XMLCONCAT Syntax.....	8-11
8-5	XMLAGG Syntax.....	8-12
8-6	XMLPI Syntax.....	8-15
8-7	XMLComment Syntax.....	8-16
8-8	XMLSerialize Syntax.....	8-17
8-9	XMLParse Syntax.....	8-18
8-10	XMLCOLATTVAL Syntax.....	8-19
8-11	XMLCDATA Syntax.....	8-20
8-12	Using PL/SQL Package DBMS_XMLGEN.....	8-22
8-13	SYS_XMLAGG Syntax.....	8-46
10-1	Creating XMLType Views Clause: Syntax.....	10-2
11-1	Using the PL/SQL DOM API for XMLType.....	11-13
11-2	Using the PL/SQL Parser API for XMLType.....	11-23
11-3	Using the PL/SQL XSLT Processor for XMLType.....	11-25
13-1	Using the Java DOM API for XMLType.....	13-13
16-1	XML Use Cases and XMLType Storage Models.....	16-3
17-1	XMLSpy Graphical Representation of a Purchase-Order XML Schema.....	17-3
17-2	XMLSpy Support for Oracle XML DB Schema Annotations.....	17-6
17-3	Creating an XMLType Table – CREATE TABLE Syntax.....	17-18
17-4	Creating an XMLType Table – XMLType_table Syntax.....	17-18
17-5	Creating an XMLType Table – table_properties Syntax.....	17-18
17-6	Creating an XMLType Table – XMLType_virtual_columns Syntax.....	17-18
17-7	How Oracle XML DB Maps XML Schema-Based XMLType Tables.....	17-27
18-1	simpleType Mapping: XML Strings to SQL VARCHAR2 or CLOB.....	18-24
18-2	Mapping complexType to SQL for Out-Of-Line Storage.....	18-40
18-3	Cross Referencing Between Different complexTypes in the Same XML Schema.....	18-47
18-4	Self-Referencing Complex Type within an XML Schema.....	18-48
18-5	Cyclical References Between XML Schemas.....	18-49
18-6	Mapping complexType XML Fragments to CLOB Instances.....	18-55
21-1	A Folder Tree, Showing Hierarchical Structures in the Repository.....	21-2
21-2	Oracle XML DB Folders in Windows Explorer.....	21-14
21-3	Accessing Repository Data Using HTTP(S)/WebDAV and a Web Browser.....	21-15
21-4	Path-Based Access Using HTTP and a URL.....	21-15

21-5	Oracle ASM Virtual Folder Hierarchy.....	21-18
21-6	Updating and Editing Content Stored in Oracle XML DB Using Microsoft Word.....	21-31
24-1	Accessing Repository Resources Using RESOURCE_VIEW and PATH_VIEW.....	24-2
24-2	RESOURCE_VIEW and PATH_VIEW Structure.....	24-3
24-3	RESOURCE_VIEW and PATH_VIEW Explained.....	24-5
24-4	UNDER_PATH Syntax.....	24-6
24-5	EQUALS_PATH Syntax.....	24-7
24-6	PATH Syntax.....	24-8
28-1	Oracle XML DB Architecture: Protocol Server	28-2
28-2	Creating a WebFolder in Microsoft Windows.....	28-29
28-3	Copying Files into Oracle XML DB Repository.....	28-30
32-1	A DBUri Corresponds to an XML Visualization of Relational Data.....	32-14
32-2	SYS_DBURIGEN Syntax.....	32-24
37-1	Oracle Streams Advanced Queuing and XML Message Payloads.....	37-2
37-2	iDAP Architecture for Performing AQ Operations Using HTTP(S).....	37-5
C-1	UPDATEXML Syntax.....	C-8
C-2	INSERTCHILDXML Syntax.....	C-18
C-3	INSERTCHILDXMLBEFORE Syntax.....	C-20
C-4	INSERTCHILDXMLAFTER Syntax.....	C-21
C-5	INSERTXMLBEFORE Syntax.....	C-22
C-6	INSERTXMLAFTER Syntax.....	C-24
C-7	APPENDCHILDXML Syntax.....	C-25
C-8	DELETXML Syntax.....	C-26

List of Tables

1	XMLType Java Constructors and Methods Deprecated in Oracle Database 12c Release 2 (12.2.0.1).....	xliii
1-1	Static Data Dictionary Views Related to XML.....	1-14
3-1	SQL*Loader – Conventional and Direct-Path Load Modes.....	3-13
4-1	Common XPath Constructs.....	4-2
4-2	Predefined Namespaces and Prefixes.....	4-9
4-3	oradb Expressions: Column Types for Comparisons.....	4-19
6-1	Basic XML Indexing Tasks.....	6-1
6-2	Tasks Involving XMLIndex Indexes with a Structured Component.....	6-2
6-3	Tasks Involving XMLIndex Indexes with an Unstructured Component.....	6-2
6-4	Miscellaneous Tasks Involving XMLIndex Indexes.....	6-3
6-5	XML and SQL Data Type Correspondence for XMLIndex.....	6-11
6-6	XMLIndex Path Table.....	6-16
6-7	Index Synchronization.....	6-43
6-8	XMLIndex Static Public Views.....	6-45
6-9	Migrating Oracle-Specific XML Queries to XQuery Full Text.....	6-61
8-1	DBMS_XMLGEN Functions and Procedures.....	8-23
11-1	PL/SQL APIs Related to XML.....	11-3
11-2	XML and HTML DOM Node Types and Their Child Node Types	11-11
13-1	Java DOM API for XMLType: Classes.....	13-11
14-1	OCIXmlDbInitXMLCtx() Parameters	14-3
14-2	Common XMLType Operations in C	14-15
16-1	XMLType Storage Model Considerations.....	16-7
16-2	XMLType Indexing Considerations.....	16-8
16-3	XMLType Storage Models: Relative Advantages.....	16-8
17-1	XMLType Methods Related to XML Schema	17-7
17-2	CREATE TABLE Encoding Options for Binary XML.....	17-21
18-1	Annotations in Elements	18-14
18-2	Annotations in Elements Declaring Global complexType Elements.....	18-16
18-3	Annotations in XML Schema Declarations.....	18-16
18-4	XML Schema String Data Types Mapped to SQL	18-24
18-5	XML Schema Binary Data Types (hexBinary/base64Binary) Mapped to SQL	18-24
18-6	Default Mapping of Numeric XML Schema Primitive Types to SQL.....	18-25
18-7	XML Schema Date and Time Data Types Mapped to SQL	18-25
18-8	Default Mapping of Other XML Schema Primitive and Derived Data Types to SQL..	18-26
19-1	Sample of XPath Expressions that Are Rewritten to Underlying SQL Constructs.....	19-3
20-1	Parameters of Procedure DBMS_XMLSCHEMA.COPYEVOLVE.....	20-6
20-2	Errors Associated with Procedure DBMS_XMLSCHEMA.COPYEVOLVE.....	20-7
20-3	XML Schema Evolution: XMLType Table Temporary Table Columns	20-13
20-4	XML Schema Evolution: XMLType Column Temporary Table Columns.....	20-14
20-5	Procedure COPYEVOLVE Mapping Table	20-14
20-6	Parameters of Procedure DBMS_XMLSCHEMA.INPLACEEVOLVE.....	20-20
21-1	Synonyms for Oracle XML DB Repository Terms	21-6
21-2	Differences Between PATH_VIEW and RESOURCE_VIEW.....	21-19
21-3	Accessing Oracle XML DB Repository: API Options.....	21-21
24-1	Structure of RESOURCE_VIEW.....	24-3
24-2	Structure of PATH_VIEW.....	24-4
24-3	UNDER_PATH SQL Function Signature.....	24-6
25-1	Oracle XML DB Versioning Terms	25-1
25-2	PL/SQL Functions and Procedures in Package DBMS_XDB_VERSION.....	25-3
26-1	DBMS_XDB_REPOS Resource Access and Management Subprograms.....	26-1

26-2	DBMS_XDB_REPOS: Security Management Subprograms.....	26-4
26-3	DBMS_XDB_CONFIG: Configuration Management Subprograms.....	26-8
27-1	Database Privileges Needed for Operations on Oracle XML DB Resources	27-5
27-2	Atomic Privileges.....	27-6
27-3	Aggregate Privileges.....	27-7
28-1	Common Protocol Configuration Parameters.....	28-3
28-2	Configuration Parameters Specific to FTP.....	28-5
28-3	Configuration Parameters Specific to HTTP(S)/WebDAV (Except Servlet).....	28-5
30-1	Predefined Repository Events.....	30-4
30-2	Oracle XML DB Repository Operations and Events.....	30-6
31-1	XML Elements Defined for Servlet Deployment Descriptors	31-3
31-2	Java Servlet 2.2 Methods that Are Not Implemented.....	31-8
32-1	URIType PL/SQL Methods	32-5
32-2	URIFACTORY PL/SQL Methods.....	32-21
32-3	DBUriServlet: Optional Arguments	32-28
33-1	Web Service Mapping Between XML and Oracle Database Data Types.....	33-7
34-1	DBMS_XDB_ADMIN Management Procedures.....	34-14
C-1	Migrating Oracle-Specific XML Updating Queries to XQuery Update.....	C-2

Preface

This manual describes Oracle XML DB, and how you can use it to store, generate, manipulate, manage, and query XML data in the database.

After introducing you to the heart of Oracle XML DB, namely the `XMLType` framework and Oracle XML DB Repository, the manual provides a brief introduction to design criteria to consider when planning your Oracle XML DB application. It provides examples of how and where you can use Oracle XML DB.

The manual then describes ways you can store and retrieve XML data using Oracle XML DB, APIs for manipulating `XMLType` data, and ways you can view, generate, transform, and search on existing XML data. The remainder of the manual discusses how to use Oracle XML DB Repository, including versioning and security, how to access and manipulate repository resources using protocols, SQL, PL/SQL, or Java, and how to manage your Oracle XML DB application using Oracle Enterprise Manager. It also introduces you to XML messaging and Oracle Streams Advanced Queuing `XMLType` support.

Topics

- [Audience](#) (page xxxv)
- [Documentation Accessibility](#) (page xxxv)
- [Related Documents](#) (page xxxvi)
- [Conventions](#) (page xxxviii)

Audience

Oracle XML DB Developer's Guide is intended for developers building XML Oracle Database applications.

An understanding of XML, XML Schema, XQuery, XPath, and XSL is helpful when using this manual.

Many examples provided here are in SQL, PL/SQL, Java, or C. A working knowledge of one of these languages is presumed.

Documentation Accessibility

For information about Oracle's commitment to accessibility, visit the Oracle Accessibility Program website at <http://www.oracle.com/pls/topic/lookup?ctx=acc&id=docacc>.

Access to Oracle Support

Oracle customers that have purchased support have access to electronic support through My Oracle Support. For information, visit <http://www.oracle.com/pls/topic/lookup?ctx=acc&id=info> or visit <http://www.oracle.com/pls/topic/lookup?ctx=acc&id=trs> if you are hearing impaired.

Related Documents

For more information, see these Oracle resources:

- *Oracle Database New Features Guide* for information about the differences between Oracle Database 12c and Oracle Database 12c Enterprise Edition with respect to available features and options. This book also describes features new to Oracle Database 12c Release 1 (12.1).
- *Oracle Database XML Java API Reference*
- *Oracle XML Developer's Kit Programmer's Guide*
- *Oracle Database Error Messages*. Oracle Database error message documentation is available only as HTML. If you have access to only printed or PDF Oracle Database documentation, you can browse the error messages by range. Once you find the specific range, use the search (find) function of your Web browser to locate the specific message. When connected to the Internet, you can search for a specific error message using the error message search feature of the Oracle Database online documentation.
- *Oracle Text Application Developer's Guide*
- *Oracle Text Reference*
- *Oracle Database Concepts*
- *Oracle Database Java Developer's Guide*
- *Oracle Database Development Guide*
- *Oracle Database Advanced Queuing User's Guide*
- *Oracle Database PL/SQL Packages and Types Reference*

Many of the examples in this book use the Oracle Database sample schemas. Refer to *Oracle Database Sample Schemas* for information about how these database schemas were created and how you can use them yourself.

To download free release notes, installation documentation, white papers, or other collateral, please visit the Oracle Technology Network (OTN). You must register online before using OTN; registration is free and can be done at

<http://www.oracle.com/technetwork/community/join/overview/index.html>

If you already have a user name and password for OTN, then you can go directly to the documentation section of the OTN website at

<http://www.oracle.com/technetwork/indexes/documentation/>

For additional information, see:

- <http://www.w3.org/TR/xml/> – XML (language)

- <http://www.xml.com/pub/a/98/10/guide0.html> – XML introduction
- <http://www.w3.org/XML/Schema> – XML Schema
- <http://www.w3.org/2001/XMLSchema> – XML Schema
- <http://www.w3.org/TR/xmlschema-0/> – XML Schema: primer
- <http://www.w3.org/TR/xmlschema-1/> – XML Schema: structures
- <http://www.w3.org/TR/xmlschema-2/> – XML Schema: data types
- <http://www.oasis-open.org/cover/schemas.html> – XML Schema
- <http://www.xml.com/pub/a/2000/11/29/schemas/part1.html> – XML Schema
- <http://xml.coverpages.org/xmlMediaMIME.html> – media/MIME types
- <http://www.w3.org/TR/xptr/> – XPointer
- <http://www.w3.org/TR/xpath> – XPath 1.0
- <http://www.w3.org/TR/xpath20/> – XPath 2.0
- <http://www.zvon.org/xxl/XPathTutorial/General/examples.html> – XPath
- *XML In a Nutshell*, by Elliotte Rusty Harold and W. Scott Means, O'Reilly, January 2001
- <http://www.w3.org/TR/2002/NOTE-unicode-xml-20020218/> – Unicode in XML
- <http://www.w3.org/TR/xml-names/> – XML namespaces
- <http://www.w3.org/TR/xml-infoset/> – information sets
- <http://www.w3.org/DOM/> – Document Object Model (DOM)
- <http://www.w3.org/TR/xslt> – XSLT
- <http://www.w3.org/TR/xsl> – XSL
- <http://www.oasis-open.org/cover/xsl.html> – XSL
- <http://www.zvon.org/xxl/XSLTutorial/Output/index.html> – XSL
- <http://www.w3.org/2002/ws/Activity.html> – Web services
- <http://www.ietf.org/rfc/rfc959.txt> – RFC 959: FTP Protocol Specification
- ISO/IEC 13249-2:2000, Information technology - Database languages - SQL Multimedia and Application Packages - Part 2: Full-Text, International Organization For Standardization, 2000
- <http://download.oracle.com/javase/1.2.1/api/index.html> – XML and Java

Note:

Throughout this manual, **XML Schema** refers to the XML Schema 1.0 recommendation, <http://www.w3.org/XML/Schema>.

Conventions

The following text conventions are used in this document:

Convention	Meaning
boldface	Boldface type indicates graphical user interface elements associated with an action, or terms defined in text or the glossary.
<i>italic</i>	Italic type indicates book titles, emphasis, or placeholder variables for which you supply particular values.
<code>monospace</code>	Monospace type indicates commands within a paragraph, URLs, code in examples, text that appears on the screen, or text that you enter.

Code Examples

The code examples in this book are for illustration only. In many cases, however, you can copy and paste parts of examples and run them in your environment.

Standard Database Schemas

Many of the examples in this book use the standard database schemas that are included in your database. In particular, database schema OE contains XML purchase-order documents in XMLType table `purchaseorder`, and XML documents with warehouse information in XMLType column `warehouse_spec` of table `warehouses`.

The purchase-order documents are also contained in Oracle XML DB Repository, under the repository path `/home/OE/PurchaseOrders/2002/`. The XML schema that governs these documents is file `purchaseorder.xsd`, at repository location `/home/OE/purchaseorder.xsd`. An XSLT stylesheet that is used in some examples to transform purchase-order documents is file `purchaseorder.xsl`, at repository location `/home/OE/purchaseorder.xsl`. This XML schema and stylesheet can also be found in [Oracle-Supplied XML Schemas and Examples](#) (page A-1).

See Also:

- *Oracle Database Sample Schemas* for information about database schema HR
 - *Oracle Database Sample Schemas* for information about database schema OE
-
-

Pretty Printing of XML Data

To promote readability, especially of lengthy or complex XML data, output is sometimes shown pretty-printed (formatted) in code examples.

Execution Plans

Some of the code examples in this book present execution plans. These are for illustration only. Running examples that are presented here in your environment is likely to result in different execution plans from those presented here.

Reminder About Case Sensitivity

SQL is case-insensitive. XML is case-sensitive. Keep this in mind when you mix SQL and XML.

When examining the examples in this book, keep in mind the following:

- SQL is case-insensitive, but names in SQL code are implicitly uppercase, unless you enclose them in double quotation marks ("").
- XML is case-sensitive. You must refer to SQL names in XML code using the correct case: uppercase SQL names must be written as uppercase.

For example, if you create a table named `my_table` in SQL without using double quotation marks, then you must refer to it in XML code as "MY_TABLE".

Syntax Descriptions

Syntax descriptions are provided for various SQL, PL/SQL, or other command-line constructs in graphic form or Backus Naur Form (BNF).

See *Oracle Database SQL Language Reference* for information about how to interpret these descriptions.

Changes in This Release for Oracle XML DB Developer's Guide

This preface contains descriptions of changes in Oracle XML DB for the last two major database releases.

- [Changes in Oracle Database 12c Release 2 \(12.2.0.1\) for Oracle Database](#) (page xli)
- [Changes in Oracle Database 12c Release 1 \(12.1.0.2\) for Oracle Database](#) (page xliv)
- [Changes in Oracle Database 12c Release 1 \(12.1.0.1\) for Oracle XML DB](#) (page xlv)

Changes in Oracle Database 12c Release 2 (12.2.0.1) for Oracle Database

The following are changes in *Oracle XML DB Developer's Guide* for Oracle Database 12c Release 2 (12.2.0.1).

New Features

The following features are new in this release.

Improved Partitioning Support for XMLIndex

The use of partitioned XMLType data with XMLIndex indexing has been improved.

- You can now create an XMLIndex index on XMLType data in a table that is interval-partitioned or reference-partitioned.
- New PL/SQL procedures in package DBMS_XMLSTORAGE_MANAGE perform exchange partitioning for reference-partitioned tables that use XMLIndex: refPartitionExchangeIn and refPartitionExchangeOut.
- You can now specify TABLESPACE for XMLIndex at the index level, as well as at the table level and the partition level.

See Also:

- [Using Namespaces and Storage Clauses with an XMLIndex Structured Component](#) (page 6-27)
 - [Exchange Partitioning and XMLIndex](#) (page 6-13)
-
-

Client-Side Decoding of Binary XML Data

You can now specify client-side decoding for binary XML data, using property `ORACLE.XDB.XMLType.decode_on_client` on a JDBC connection. By default, client-side decoding is enabled. To disable it, set the property value to `FALSE` using method `setClientInfo`.

Change XMLType Storage Model Using Online Redefinition

You can now use online redefinition to move `XMLType` data to or from the binary XML storage format.

XML Pushdown with Exadata

When XML data is stored using a SecureFiles LOB of less than 4K bytes, the evaluation in a SQL `WHERE` clause of Oracle SQL condition `XMLExists` or Oracle SQL function `XMLCast` applied to the return value of Oracle SQL function `XMLQuery` can sometimes be offloaded to an Exadata Storage Server.

Hierarchy-Enabled Table Support for Replication

Hierarchy-enabled `XMLType` tables are now supported for Oracle Data Guard SQL Apply (logical standby) and Oracle GoldenGate replication.

SCAN Listener Balances HTTP Requests Across Nodes of a RAC Cluster

A Single Client Access Name (SCAN) Listener now balances HTTP requests across the nodes of a RAC Cluster. However, you cannot use privileged ports (port number less than 1024) with a SCAN Listener.

Load Subdocuments From XML Documents Using Access Driver ORACLE_LOADER

You can now use the `XMLTAG` clause of access driver `ORACLE_LOADER` to specify XML tags that are used to load subdocuments from an XML document.

See Also:

Oracle Database Utilities

Deprecated Features

The following features are deprecated in this release, and may be desupported in a future release.

- Oracle XQuery function `ora:contains`. Use XQuery Full Text instead. See [Migrating from Using Oracle Text Index to XML Search Index](#) (page 6-60).
- Oracle SQL function `XMLRoot`. Use SQL/XML function `XMLSerialize()` with a version number instead.
- Nested tables stored as index-ordered tables (IOTs). This includes both the use of option `DBMS_XMLSCHEMA.REGISTER_NT_AS_IOT` and the use of clause `NESTED TABLE N STORE AS ... (ORGANIZATION INDEX)` when creating a table with nested-table column `N`.

Instead, store nested-table columns using heap storage (the default behavior for PL/SQL procedure `DBMS_XMLSCHEMA.registerSchema`).

- PL/SQL procedure `DBMS_XSLPROCESSOR.CLOB2FILE`. Use the new procedure `DBMS_LOB.CLOB2FILE` instead.
- PL/SQL function `DBMS_XSLPROCESSOR.READ2CLOB`. Use `DBMS_LOB.LOADCLOBFROMFILE` instead.
- Use of XLink with Oracle XML DB. See [Use of XLink and XInclude with Oracle XML DB](#) (page 23-1)
- Oracle XML DB Content Connector, which implements Content Repository API for Java (also known as JCR), a Java API standard developed by the Java community as JSR-170. See [Deprecated Content Repository API for Java](#) (page E-1).
- The XMLType Java constructors and methods that are listed in [Table 1](#) (page xliii).

Table 1 XMLType Java Constructors and Methods Deprecated in Oracle Database 12c Release 2 (12.2.0.1)

Deprecated XMLType Constructor or Method	Replacement
<code>createXML(java.sql.Connection conn, java.lang.String xmlval)</code>	<code>java.sql.Connection conn; SQLXML newXML = conn.createSQLXML(); newXML.setString(xmlval);</code>
<code>createXML(Connection conn, Document dom)</code>	<code>java.sql.Connection conn; SQLXML newXML = conn.createSQLXML(); DOMResult dom = newXML.setResult(DOMResult.class);</code>
<code>getDocument()</code> or <code>getDOM()</code>	<code>SQLXML sx; DOMSource ds; sx.getSource(DOMSource.class); Document doc = (Document) ds.getNode();</code>
<code>getStringVal()</code>	<code>SQLXML sx; String str = sx.getString();</code>
<code>existsNode(java.lang.String xpath, java.lang.String nsmmap)</code> or <code>extract(java.lang.String xpath, java.lang.String nsmmap)</code>	No replacement.
<code>getBytesValue()</code>	No replacement.
<code>close()</code>	<code>SQLXML sx; sx.free();</code>

See Also:

Oracle Database Upgrade Guide

Desupported Features

The following features are desupported in this release.

- Oracle XPath function `ora:instanceof` – Use XQuery operator `instance of` instead.
- Oracle XPath function `ora:instanceof-only` – Use XML Schema attribute `xsi:type` instead.
- Oracle XQuery function `ora:view` – Use XQuery functions `fn:doc` and `fn:collection` instead.
- XMLIndex index on CLOB XMLType data that is embedded within object-relational XMLType data.
- Function-based indexes on XMLType – Use XMLIndex index with a structured component instead.
- XML Schema annotation (attribute) `csx:encodingType`.
- The Java classes in package `oracle.xdb.dom`.
- The following PL/SQL procedures in package `DBMS_XDB_ADMIN`:
 - `createRepositoryXMLIndex`
 - `XMLIndexAddPath`
 - `XMLIndexRemovePath`
 - `dropRepositoryXMLIndex`

See Also:

Oracle Database Upgrade Guide

Changes in Oracle Database 12c Release 1 (12.1.0.2) for Oracle Database

The following are changes in *Oracle XML DB Developer's Guide* for Oracle Database 12c Release 1 (12.1.0.2).

New Features

The following features are new in this release.

JSON Support

Oracle Database now supports JavaScript Object Notation (JSON).

PL/SQL Subprograms For Realm Configuration

PL/SQL subprograms `getHTTPConfigRealm` and `setHTTPConfigRealm` have been added to package `DBMS_XDB_CONFIG`.

Changes in Oracle Database 12c Release 1 (12.1.0.1) for Oracle XML DB

The following are changes in *Oracle XML DB Developer's Guide* for Oracle Database 12c Release 1 (12.1.0.1).

New Features

The following features are new in this release.

Oracle XML DB is Mandatory – You Cannot Uninstall it

Oracle XML DB is now a mandatory component of Oracle Database. You cannot uninstall it, and there is no option not to include it when you create Oracle Database. It is automatically installed when you create a new database or when you upgrade an existing database to Oracle Database 12c.

See also [Automatic Installation of Oracle XML DB](#) (page 34-3).

XQuery Update Support

Oracle XML DB now supports XQuery Update. The Oracle-specific SQL functions for updating XML data are deprecated.

See Also:

- [XQuery and Oracle XML DB](#) (page 4-1)
 - [Updating XML Data](#) (page 5-27)
 - [Deprecated Features](#) (page xlviii) regarding deprecated Oracle SQL functions for updating XML data
-
-

XQuery Full Text Support

Oracle XML DB now supports XQuery Full Text.

See Also:

- [XQuery and Oracle XML DB](#) (page 4-1)
 - [Indexing XML Data for Full-Text Queries](#) (page 6-56)
-
-

New XQuery Extension-Expression Pragmas

New XQuery extension-expression pragmas are described.

The following XQuery extension-expression pragmas are new:

- `(#ora:child-element-name name #)` – Specify the name to use for a child element that is inserted.

- (`#ora:no_schema #`) – Do not raise an error if an XQuery Full Text expression is used with XML Schema-based XMLType data.
- (`#ora:use_xmltext_idx #`) – Use an XML search index, if available, to evaluate the query. Do not use an XMLIndex index or streaming evaluation.

See Also:

[Oracle XQuery Extension-Expression Pragmas](#) (page 4-22)

Replication and Rolling Upgrade Support

The following new features provide better support for replication and rolling upgrade.

Oracle GoldenGate and Oracle Data Guard SQL Apply Support for XMLType

Oracle GoldenGate replication and Oracle Data Guard SQL Apply (logical standby) are now supported for all XMLType storage models.

See Also:

- *Oracle GoldenGate Oracle Installation and Setup* for information about replication of XMLType data using Oracle GoldenGate
 - *Oracle GoldenGate* for information about Oracle GoldenGate
 - *Oracle Data Guard Concepts and Administration* for information about data types supported by SQL Apply
-
-

Rolling Upgrade Supports Oracle XML DB Repository

When you perform a rolling upgrade, Oracle XML DB Repository operations are applied on the standby database as part of the SQL apply step.

See [Upgrade or Downgrade of an Existing Oracle XML DB Installation](#) (page 34-1) for applicable restrictions.

Parallel DML Support for XMLType

Support for parallel DML has been improved for XMLType storage model binary XML using SecureFiles LOBs. The performance and scalability have been improved for both `CREATE TABLE AS SELECT` and `INSERT AS SELECT`.

See Also:

Oracle Database SecureFiles and Large Objects Developer's Guide

XMLIndex Improvements

Indexing XML data using XMLIndex has been improved in the following ways.

XMLIndex Index Synchronization Improvements

XMLIndex index synchronization has been improved in two ways.

- Less undo space is used.

- If an error is raised during indexing then most of the index synchronization work is saved.

XMLIndex Support for Hash Partitioning

You can create a locally partitioned XMLIndex index on XMLType tables and columns that you have partitioned using hash partitioning (in addition to range and list partitioning).

See Also:

[XMLIndex Partitioning and Parallelism](#) (page 6-41)

PL/SQL Package DBMS_XDB Is Split

The subprograms and constants of PL/SQL package DBMS_XDB have been divided among the following packages:

- DBMS_XDB_ADMIN
- DBMS_XDB_CONFIG
- DBMS_XDB_REPOS

Packages DBMS_XDB_CONFIG and DBMS_XDB_REPOS are new in Oracle Database 12c Release 1 (12.1.0.1). Package DBMS_XDB continues to exist for backward compatibility.

See Also:

- *Oracle Database PL/SQL Packages and Types Reference*, Chapter "DBMS_XDB_CONFIG"
 - [Deprecated Features](#) (page xlviii) regarding deprecated PL/SQL subprograms and constants moved from DBMS_XDB to DBMS_XDB_CONFIG
 - *Oracle Database PL/SQL Packages and Types Reference*, Chapter "DBMS_XDB_REPOS"
-
-

Access to the Repository Using Digest Access Authentication

Users can now access Oracle XML DB Repository using digest access authentication (also known as digest authentication), in addition to basic authentication. This provides encryption of user credentials (name, password, etc.) without the overhead of complete data encryption.

User credentials are case-sensitive. In particular, a user name to be authenticated must exactly match the name as it was created (which by default is all uppercase).

See Also:

- [Configuration and Management of Authentication Mechanisms for HTTP](#) (page 28-10) for how to configure digest authentication
 - [Upgrade or Downgrade of an Existing Oracle XML DB Installation](#) (page 34-1) for installation, upgrade, and downgrade considerations
-
-

DBFS Support

You can now access Oracle Database File System (DBFS) files and folders from Oracle XML DB Repository, under the repository path `/dbfs`. This new feature provides you with FTP and HTTP(S)/WebDAV access to DBFS files and folders.

See Also:

- *Oracle Database SecureFiles and Large Objects Developer's Guide*
 - *Oracle Database Upgrade Guide*
-
-

XQuery API for Java (XQJ) Support

You can now use Oracle XML Developer's Kit and XQuery API for Java (XQJ) to access XML data in the database using XQuery expressions from Java programs. In particular, you can access XML data stored in remote databases from a local Java program.

See Also:

- [Using XQuery with XQJ to Access Database Data](#) (page 5-23)
 - *Oracle XML Developer's Kit Programmer's Guide* for complete information about using XQJ
-
-

Deprecated Features

The following features are deprecated in this release, and may be desupported in a future release.

- CLOB storage of `XMLType`, also known as unstructured storage, is deprecated. Use binary XML storage of `XMLType` instead.

If you need to preserve insignificant whitespace then store two copies of your original XML document: one as an `XMLType` instance for database use and XML processing, the other as a CLOB instance to provide document fidelity.

- Creation of an `XMLIndex` index over an XML fragment stored as a CLOB instance embedded in object-relational `XMLType` data is deprecated. If you need to index the data in such a fragment then store the document using binary XML storage, not object-relational storage.
- The following PL/SQL subprograms in package `DBMS_XMLSCHEMA` are deprecated:

- generateSchema
- generateSchemas

There are no replacements for these constructs and there is no workaround for this change.

- PL/SQL package DBMS_XDB_CONFIG is new. All Oracle XML DB configuration functions, procedures, and constants have been moved from package DBMS_XDB to DBMS_XDB_CONFIG. They are *deprecated* for package DBMS_XDB. Oracle recommends that you use them in package DBMS_XDB_CONFIG instead.

These are the subprograms that are deprecated in package DBMS_XDB:

- ADDHTTPEXPIREMAPPING
- ADDMIMEMAPPING
- ADDSCHEMALOCMAPPING
- ADDSERVLET
- ADDSERVLETMAPPING
- ADDSERVLETSECROLE
- ADDXMLEXTENSION
- CFG_GET
- CFG_REFRESH
- CFG_UPDATE
- DELETEHTTPEXPIREMAPPING
- DELETEMIMEMAPPING
- DELETESCHEMALOCMAPPING
- DELETESERVLET
- DELETESERVLETMAPPING
- DELETESERVLETSECROLE
- DELETEXMLEXTENSION
- GETFTPPORT
- GETHTTTPORT
- GETLISTENERENDPOINT
- SETFTPPORT
- SETHTTTPORT
- SETLISTENERENDPOINT
- SETLISTENERLOCALACCESS

These are the constants that are deprecated in package DBMS_XDB:

- XDB_ENDPOINT_HTTP
- XDB_ENDPOINT_HTTP2
- XDB_PROTOCOL_TCP
- XDB_PROTOCOL_TCPS

See Also:

Oracle Database PL/SQL Packages and Types Reference, Chapter "DBMS_XDB_CONFIG"

- All Oracle SQL functions for updating XML data are deprecated. Oracle recommends that you use XQuery Update instead. These are the deprecated XML updating functions:

- updateXML
- insertChildXML
- insertChildXMLbefore
- insertChildXMLafter
- insertXMLbefore
- insertXMLafter
- appendChildXML
- deleteXML

See Also:

[Deprecated Functions for Updating XML Data](#) (page C-1)

- Oracle SQL function `sys_xmlgen` is deprecated. Oracle recommends that you use the SQL/XML generation functions instead.

See Also:

[Generation of XML Data Using SQL Functions](#) (page 8-2)

- The following Oracle XQuery functions are deprecated. Use the corresponding standard XQuery functions instead, that is, the functions with the same names but with namespace prefix `fn`.

- `ora:matches` - use `fn:matches` instead
- `ora:replace` - use `fn:replace` instead

- The following Oracle constructs that provide support for XML translations are deprecated.

- PL/SQL package `DBMS_XMLTRANSLATIONS`

- Oracle XPath function `ora:translate`
- XML Schema annotations `xdb:maxOccurs`, `xdb:srclang`, and `xdb:translate`

There are no replacements for these constructs and there is no workaround for this change.

See Also:

[Deprecated Constructs for XML Translation](#) (page D-1)

- The following XML Schema annotations are deprecated:
 - `xdb:defaultTableSchema`
 - `xdb:maintainOrder`
 - `xdb:mapUnboundedStringToLob`
 - `xdb:maxOccurs`¹
 - `xdb:SQLCollSchema`
 - `xdb:SQLSchema`
 - `xdb:srclang`¹
 - `xdb:storeVarrayAsTable`
 - `xdb:translate`¹

There are no replacements for these constructs, and there is no workaround for this change.

- The value `xml_clobs` for export parameter `data_options` is *deprecated* starting with Oracle Database 12c Release 1 (12.1).

See Also:

[Overview of Exporting and Importing XMLType Tables](#) (page 36-1)

Desupported Features

The following features are no longer supported by Oracle.

See *Oracle Database Upgrade Guide* for a complete list of desupported features in this release.

- `CTXSYS.CTXXPATH` index is desupported. Use `XMLIndex` indexes instead

¹ See also [Deprecated Features](#) (page xlviii) regarding deprecated support for XML translations.

Part I

Oracle XML DB Basics

The basics of Oracle XML DB are introduced.

- [Introduction to Oracle XML DB](#) (page 1-1)
- [Getting Started with Oracle XML DB](#) (page 2-1)
- [Overview of How To Use Oracle XML DB](#) (page 3-1)

Introduction to Oracle XML DB

Oracle XML DB provides Oracle Database with native XML support by encompassing both the SQL and XML data models in an interoperable way.

- [Overview of Oracle XML DB](#) (page 1-1)
- [Oracle XML DB Benefits](#) (page 1-2)
- [Oracle XML DB Architecture](#) (page 1-8)
- [Oracle XML DB Features](#) (page 1-10)
- [Standards Supported by Oracle XML DB](#) (page 1-18)
- [Oracle XML DB Technical Support](#) (page 1-19)
- [Oracle XML DB Examples](#) (page 1-20)
- [Oracle XML DB Case Studies and Demonstrations on OTN](#) (page 1-20)

1.1 Overview of Oracle XML DB

Oracle XML DB is a set of Oracle Database technologies related to high-performance handling of XML data: storing, generating, accessing, searching, validating, transforming, evolving, and indexing. It provides native XML support by encompassing both the SQL and XML data models in an interoperable way.

Oracle XML DB is included as part of Oracle Database starting with Oracle9i Release 2 (9.2).

Oracle XML DB and the `XMLType` abstract data type make Oracle Database XML-aware. Storing XML data as an `XMLType` column or table lets the database perform XML-specific operations on the content. This includes XML validation and optimization. `XMLType` storage allows highly efficient processing of XML content in the database.

Oracle XML DB includes the following features:

- An abstract SQL data type, `XMLType`, for XML data.
- Enterprise-level Oracle Database features for XML content: reliability, availability, scalability, and security. XML-specific memory management and optimizations.
- Industry-standard ways to access and update XML data. You can use FTP, HTTP(S), and WebDAV to move XML content into and out of Oracle Database. Industry-standard APIs provide programmatic access and manipulation of XML content using Java, C, and PL/SQL.
- Ways to store, query, update, and transform XML data while accessing it using SQL and XQuery.

- Ways to perform XML operations on SQL data.
- Oracle XML DB Repository: a simple, lightweight repository where you can organize and manage database content, including XML content, using a file/folder/URL metaphor.
- Ways to access and combine data from disparate systems through gateways, using a single, common data model. This reduces the complexity of developing applications that must deal with data from different stores.
- Ways to use Oracle XML DB in conjunction with Oracle XML Developer's Kit (XDK) to build applications that run in the middle tier in either Oracle Fusion Middleware or Oracle Database.

Oracle XML DB functionality is partially based on the Oracle XML Developer's Kit C implementations of the relevant XML standards, such as XML Parser, XSLT Virtual Machine, XML DOM, and XML Schema Validator.

See Also:

- [XMLType Data Type](#) (page 1-10)
 - <http://www.oracle.com/technetwork/database-features/xmldb/overview/index.html> for the latest news and white papers about Oracle XML DB
 - *Oracle XML Developer's Kit Programmer's Guide*
-
-

1.2 Oracle XML DB Benefits

Oracle XML DB supports all major XML, SQL, Java, and Internet standards. It provides high performance and scalability for XML operations. It brings database features such as transaction control, data integrity, replication, reliability, availability, security, and scalability to the world of XML.

[Figure 1-1](#) (page 1-3) presents an overview of the standards supported by Oracle XML DB.

Figure 1-1 Oracle XML DB Benefits

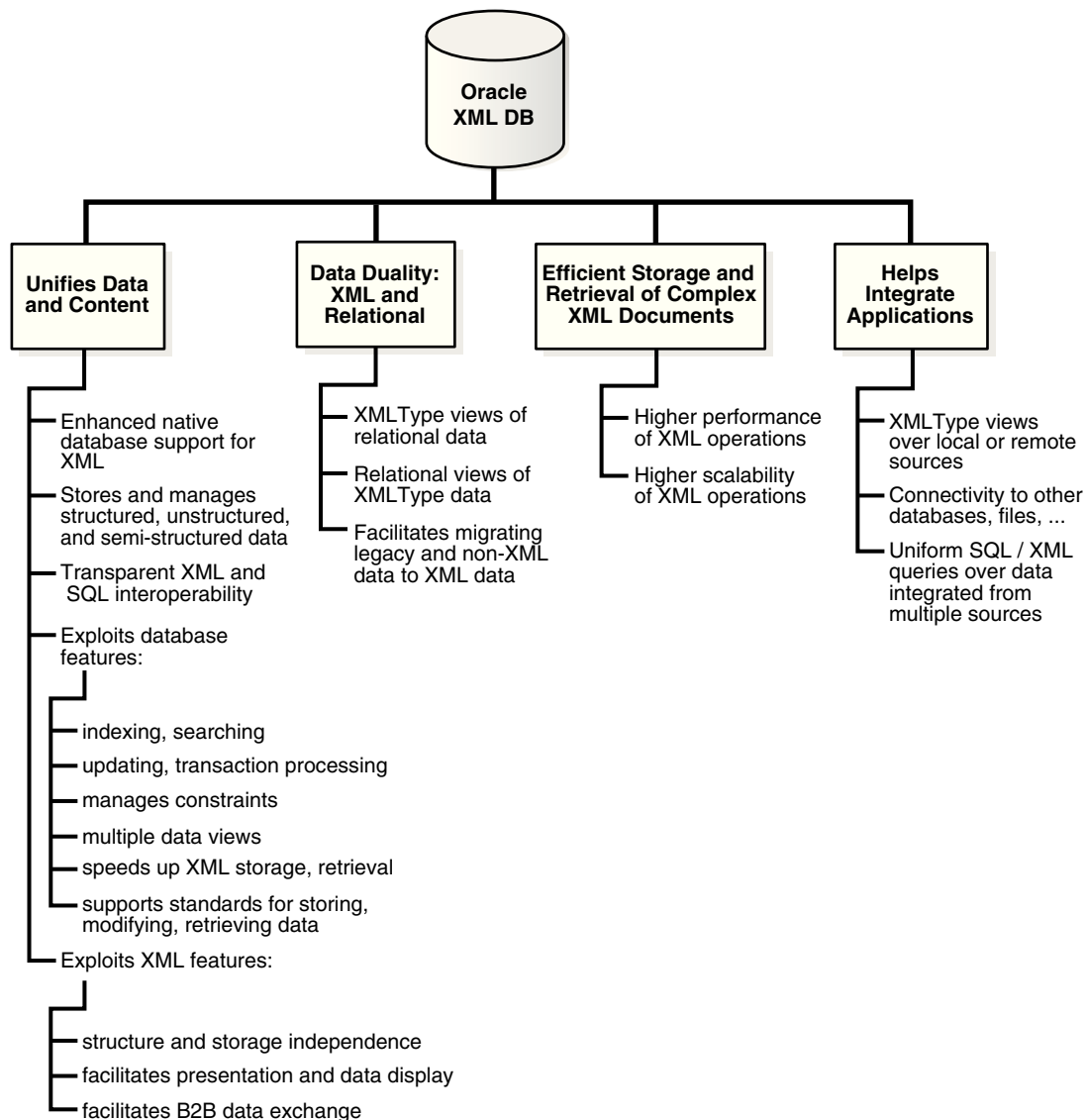

1.2.1 Data and Content Unified

With Oracle XML DB, you can store and manage data that is structured, unstructured, and semi-structured using a standard data model and standard SQL and XML. You can perform SQL operations on XML documents and XML operations on object-relational (such as table) data.

Most application data and Web content is stored in a relational database, a file system, or both. XML data is often used for data exchange, and it can be generated from a relational database or a file system. As the volume of XML data exchanged grows, the cost of regenerating this data grows, and these storage methods become less effective at accommodating XML content.

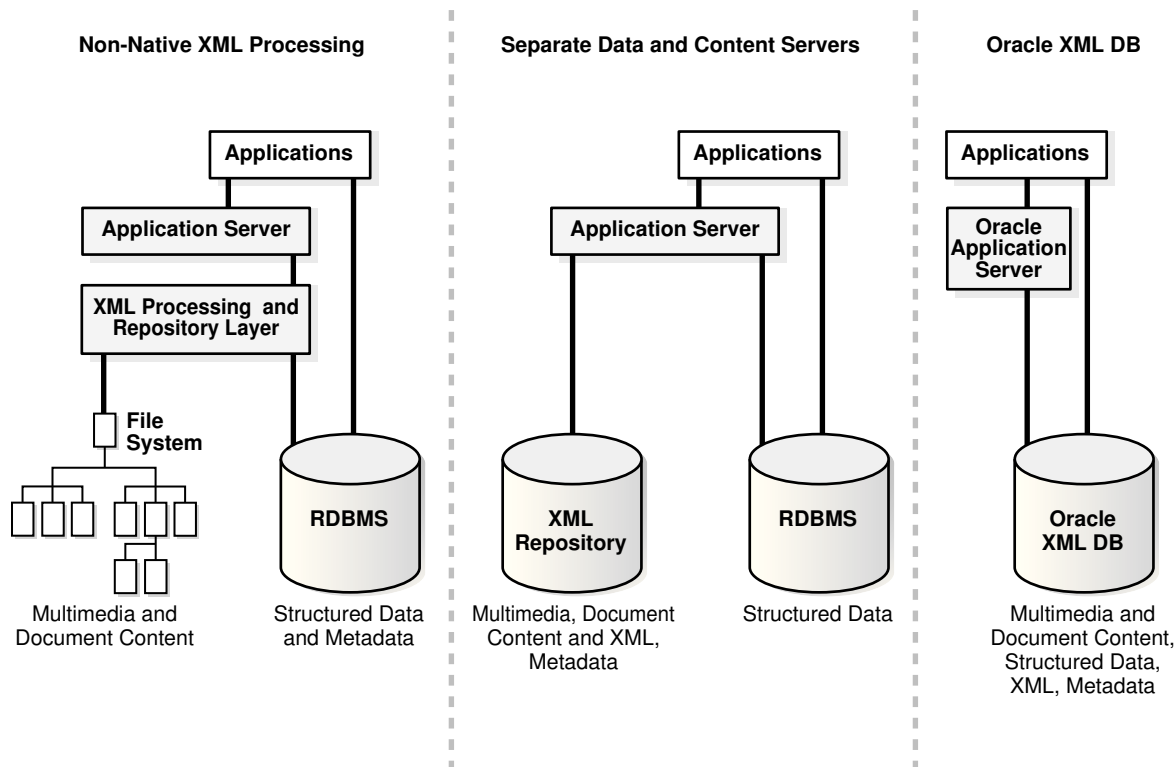
Figure 1-2 Unifying Data and Content: Some Common XML Architectures

Organizations often manage their structured data and unstructured data differently:

- Unstructured data, stored in tables, makes document access transparent and table access complex.
- Structured data, often stored in binary large objects (such as in BLOB instances), makes access more complex and table access transparent.

1.2.1.1 Database Capabilities for Working with XML

Oracle Database provides database capabilities for working with XML: indexing and search; updates and transaction processing; managing relationships using constraints; multiple data views; high performance and scalability. It supports XML Schema, XQuery, XPath, and DOM.

- Indexing and search – Just as your database data can be more or less structured, so can your queries. One query can look for all product definitions created between March and April 2014. Another query can look for products whose descriptions contain the words "wireless" and "router" but not the term "wireless router".

A query such as the former targets structured data, and it is typically supported by a B-tree index on a date column. A query such as the latter targets unstructured data, and for Oracle Database it is typically supported by an Oracle Text (full-text) index. Applications can of course combine structured and unstructured queries, and targeted data can be a mix of structured and unstructured data.

For XML data the situation is similar. Oracle XML DB provides indexing features that let you target the gamut of XML possibilities, from data and queries that are highly structured to those that are highly unstructured.

See Also:

- [Query and Update of XML Data](#) (page 5-1)
 - [Generation of XML Data from Relational Data](#) (page 8-1)
 - [Indexing XML Data for Full-Text Queries](#) (page 6-56)
 - *Oracle Text Application Developer's Guide*
 - *Oracle Text Reference*
-
-

- Updates and transaction processing – Commercial relational databases use fast updates of subparts of records, with minimal contention between users trying to update. As traditionally document-centric data participate in collaborative environments through XML, this requirement becomes more important. File or CLOB storage cannot provide the granular concurrency control that Oracle XML DB does.
-
-

See Also:

[Query and Update of XML Data](#) (page 5-1)

- Managing relationships – Data with any structure typically has foreign-key constraints. XML data stores generally lack this feature, so you must implement any constraints in application code. Oracle XML DB enables you to constrain XML data according to XML schema definitions, and hence achieve control over relationships that structured data has always enjoyed.
-
-

See Also:

- [XML Schema Storage and Query: Basic](#) (page 17-1)
 - The purchase-order examples in [Query and Update of XML Data](#) (page 5-1)
-
-

- Multiple views of data – Most enterprise applications need to group data together in different ways for different modules. This is why relational views are necessary—to allow for these multiple ways to combine data. By allowing views on XML, Oracle XML DB creates different logical abstractions on XML for, say, consumption by different types of applications.
-
-

See Also:

[XMLType Views](#) (page 10-1)

- Performance and scalability – Users expect data storage, retrieval, and query to be fast. Loading a file or CLOB value, and parsing, are typically slower than relational data access. Oracle XML DB dramatically speeds up XML storage and retrieval.

See Also:

- [Getting Started with Oracle XML DB](#) (page 2-1)
 - [Overview of How To Use Oracle XML DB](#) (page 3-1)
-

- Ease of development – Databases are foremost an application platform that provides standard, easy ways to manipulate, transform, and modify individual data elements. While typical XML parsers give standard read access to XML data they do not provide an easy way to modify and store individual XML elements. Oracle XML DB supports several standard ways to store, modify, and retrieve data. These include XML Schema, XQuery, XPath, DOM, and Java.
-

See Also:

- [XQuery and Oracle XML DB](#) (page 4-1)
 - [Java DOM API for XMLType](#) (page 13-1)
 - [Repository Access Using RESOURCE_VIEW and PATH_VIEW](#) (page 24-1)
 - [PL/SQL Access to Oracle XML DB Repository](#) (page 26-1)
-

1.2.1.2 Advantages of Storing Data as XML in the Database

Storing data as XML in the database provides these advantages: storage independence, ease of presentation, and ease of interchange.

- Storage independence: When you use relational design, your client programs must know where your data is stored, in what format, what table, and what the relationships are among those tables. XMLType enables you to write applications without that knowledge and lets database administrators map structured data to physical table and column storage.
-

See Also:

[Access to Oracle XML DB Repository Data](#) (page 21-1)

- Ease of presentation: XML is understood natively by Web browsers, many popular desktop applications, and most Internet applications. Relational data is generally not accessible directly from applications. Additional programming is required to make relational data accessible to standard clients. Oracle XML DB stores data as XML and makes it available as XML outside the database. No extra programming is required to display database content.
-

See Also:

- [Transformation and Validation of XMLType Data](#) (page 7-1).
 - [Generation of XML Data from Relational Data](#) (page 8-1).
 - [XMLType Views](#) (page 10-1).
-

- Ease of interchange – XML is the language of choice in business-to-business (B2B) data exchange. If you are forced to store XML in an arbitrary table structure, you are using some kind of proprietary translation. Whenever you translate a language, information is lost and interchange suffers. By natively understanding XML and providing DOM fidelity in the storage/retrieval process, Oracle XML DB enables a clean interchange.

See Also:

- [Transformation and Validation of XMLType Data](#) (page 7-1)
 - [XMLType Views](#) (page 10-1)
-
-

1.2.2 Data Duality: XML and Relational

Oracle XML DB presents a symmetric, dual view of data: as XML and as relational.

A key feature of Oracle XML DB is that it lets you work with XML data as if it were relational data and relational data as if it were XML data. You can leverage the power of the relational model when working with XML content, and you can leverage the flexibility of XML when working with relational content. You can use the most appropriate tools for different aspects of a particular business problem.

This duality means that the same data can be exposed as rows in a table and manipulated using SQL or exposed as nodes in an XML document and manipulated using XQuery, the DOM, or XSL transformation. Access and processing techniques are independent of the underlying storage method.

These features can provide simple solutions to common business problems:

- You can generate XML data directly from a SQL query. You can transform the XML data into other formats, such as HTML, using the database-resident XSLT processor.
- You can access XML content without converting between different data formats, using SQL queries, on-line analytical processing (OLAP), and business-intelligence/data warehousing operations.
- You can perform text, spatial data, and multimedia operations on XML content.

1.2.2.1 Use XMLType Views If Your Data Is Not XML

XMLType views provide a way for you to wrap existing relational or object-relational data in XML format.

This can be especially useful if your legacy data is not in XML format but you must migrate it to XML format. Using XMLType views, you need not alter your application code or the stored data.

To use XMLType views, you must first register an XML schema with annotations that represent a bidirectional mapping between XML Schema data types and either SQL data types or binary XML encoding types. You can then create an XMLType view conforming to this mapping, by providing an underlying query that constructs instances of the appropriate types.

See Also:[XMLType Views](#) (page 10-1)

1.2.3 Efficient Storage and Retrieval of Complex XML Documents

Oracle XML DB provides high performance and scalability for XML operations, letting you manage the storage and retrieval of complex, large, or many XML documents.

These are the major performance features of Oracle XML DB:

- Native XMLType. Abstract data type XMLType has two storage models, each optimized to work efficiently for a particular set of use cases. See [Query and Update of XML Data](#) (page 5-1) and [Choice of XMLType Storage and Indexing](#) (page 16-1)
- Optimized processing of XQuery, XPath, and XSLT. See [Performance Tuning for XQuery](#) (page 5-40) and [Transformation and Validation of XMLType Data](#) (page 7-1).
- Indexing XML data for structured or full-text search. See [Indexes for XMLType Data](#) (page 6-1).
- A lazily evaluated virtual DOM. See [PL/SQL DOM API for XMLType \(DBMS_XMLDOM\)](#) (page 11-4).
- A hierarchical index over Oracle XML DB Repository. See [Performance Guidelines for Oracle XML DB Repository Operations](#) (page 24-20).
- Parallelism and Oracle Exadata Smart Scan. Query and update of XML data can be carried out in parallel. Oracle Exadata Smart Scan is enabled automatically for XML data.

1.3 Oracle XML DB Architecture

Oracle XML DB gives you protocol and programmatic access to XML data in the form of local and remote XMLType tables and views. It provides a WebDAV repository with resource versioning and access control.

[Figure 1-3](#) (page 1-9) shows the software architecture of Oracle XML DB. The main features are:

- Storage of XMLType tables and views.
 - You can index XMLType tables and views using XMLIndex, B-tree, and Oracle Text indexes.
 - You can store data that is in XMLType views in local or remote tables. You can access remote tables using database links.
- Support for XQuery, including XQuery Update and XQuery Full Text.
- Oracle XML DB Repository. You can store any kind of documents in the repository, including XML documents that are associated with an XML schema that is registered with Oracle XML DB. You can access documents in the repository in any of the following ways:
 - HTTP(S), through the HTTP protocol handler

- WebDAV and FTP, through the WebDAV and FTP protocol handlers
- SQL, through Oracle Net Services, including Java Database Connectivity (JDBC)

Figure 1-3 XMLType Storage

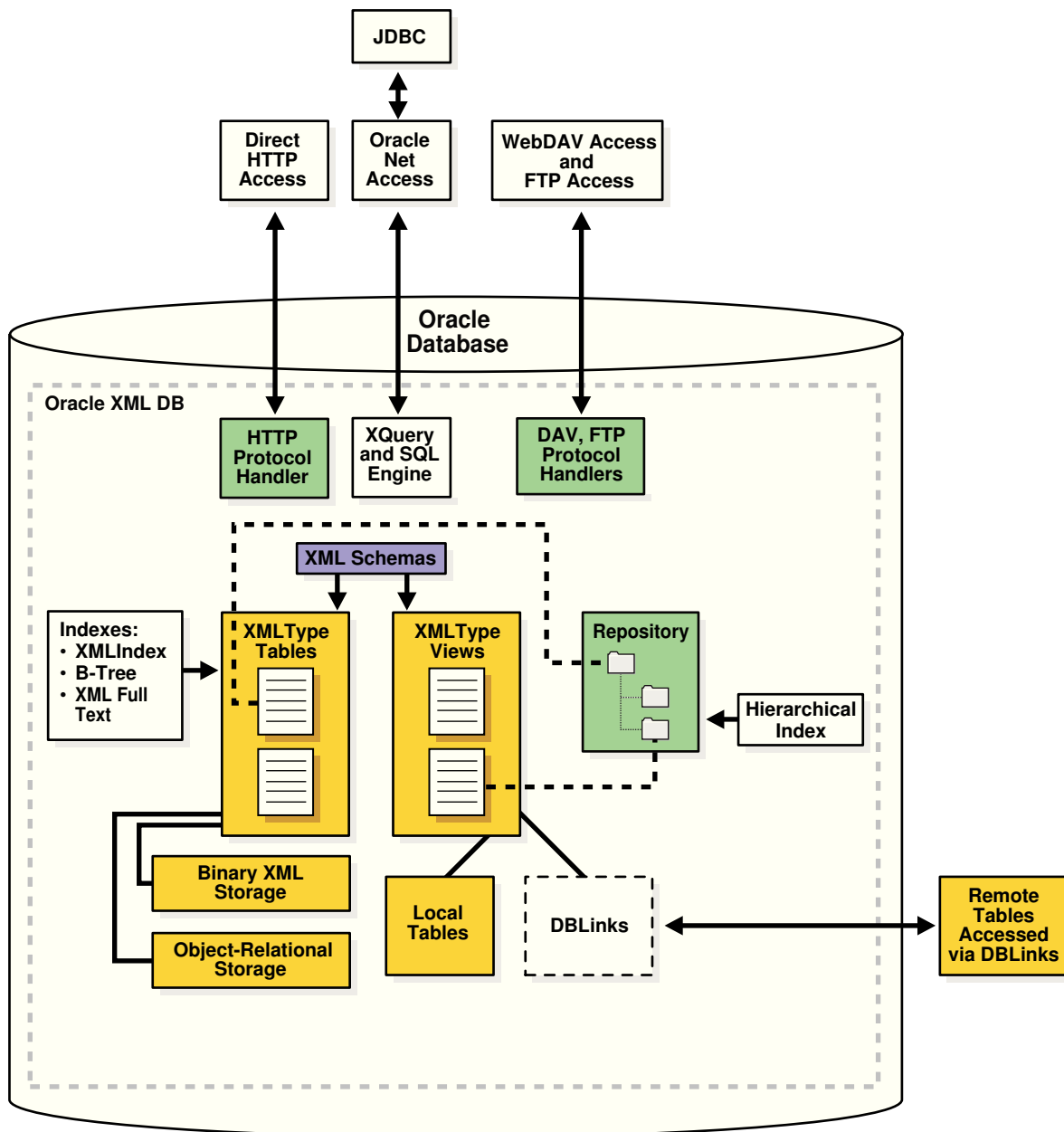

See Also:

- [Manipulation of XML Data in Oracle XML DB](#) (page 1)
- [Repository Access Using Protocols](#) (page 28-1)
- [XML Data Exchange Using Oracle Streams AQ](#) (page 37-1)

1.4 Oracle XML DB Features

Oracle XML DB provides standard database features such as transaction control, data integrity, replication, reliability, availability, security, and scalability, while also allowing for efficient indexing, querying, updating, and searching of XML documents in an XML-centric manner.

The hierarchical nature of XML presents a traditional relational database with some challenges:

- In a relational database, the *table-row* metaphor locates content. Primary-Key Foreign-Key relationships help define the relationships between content. Content is accessed and updated using the table-row-column metaphor.
- XML, on the other hand, uses *hierarchical* techniques to achieve the same functionality. A URL is used to locate an XML document. URL-based standards such as XLink are used to define relationships between XML documents. W3C Recommendations such as XPath are used to access and update content contained within XML documents. Both URLs and XPath expressions are based on *hierarchical* metaphors. A URL uses a path through a *folder hierarchy* to identify a document, whereas XPath uses a path through the *node hierarchy* of an XML document to access part of an XML document.

Oracle XML DB addresses these challenges by introducing SQL functions and methods that allow the use of XML-centric metaphors, such as XQuery and XPath expressions for querying and updating XML Documents.

The following sections describe the major features of Oracle XML DB:

- [XMLType Data Type](#) (page 1-10)
- [XMLType Storage Models](#) (page 1-11)
- [XML Schema Support in Oracle XML DB](#) (page 1-12)
- [Static Data Dictionary Views Related to XML](#) (page 1-14)
- [SQL/XML Standard Functions](#) (page 1-15)
- [Programmatic Access to Oracle XML DB \(Java, PL/SQL, and C\)](#) (page 1-16)
- [Oracle XML DB Repository: Overview](#) (page 1-16)

1.4.1 XMLType Data Type

Using XMLType, XML developers can leverage the power of XML standards while working in the context of a relational database, and SQL developers can leverage the power of a relational database while working with XML data.

XMLType is an abstract native SQL data type for XML data. It provides PL/SQL and Java constructors for creating an XMLType instance from a VARCHAR2, CLOB, BLOB, or BFILE instance. And it provides PL/SQL methods for various XML operations.

You can use XMLType as you would any other SQL data type. For example, you can create an XMLType table or view, or an XMLType column in a relational table.

You can use XMLType in PL/SQL stored procedures for parameters, return values, and variables.

You can also manipulate `XMLType` data using application programming interfaces (APIs) for the Java and C languages, including Java Database Connectivity (JDBC), XQuery for Java (XQJ), and Oracle Data Provider for .NET (ODP.NET).

`XMLType` is an Oracle Database *object type*, so you can also create a table of `XMLType` object instances. By default, an `XMLType` table or column can contain any well-formed XML document.

You can constrain `XMLType` tables or columns to conform to an XML schema, in which case the database ensures that only XML data that validates against the XML schema is stored in the column or table. Invalid documents are excluded.

See Also:

- *Oracle Database Object-Relational Developer's Guide* for information about Oracle Database object types and object-relational storage
 - *Oracle XML Developer's Kit Programmer's Guide* for information about using XQJ
 - *Oracle Database PL/SQL Packages and Types Reference* for information about `XMLType` constructors and methods
-
-

1.4.2 XMLType Storage Models

`XMLType` is an *abstract data type* that provides different *storage models* to best fit your data and your use of it. As an abstract data type, your applications and database queries gain in flexibility: the same interface is available for all `XMLType` operations.

`XMLType` tables and columns can be stored in these ways:

- **Binary XML** storage (the default) – `XMLType` data is stored in a post-parse, binary format designed specifically for XML data. Binary XML is compact, post-parse, XML schema-aware XML data. This is also referred to as **post-parse persistence**.
- **Object-relational** storage – `XMLType` data is stored as a set of objects. This is also referred to as **structured storage** and **object-based persistence**.

Note:

- Starting with Oracle Database 12c Release 1 (12.1.0.1), the unstructured (CLOB) storage model for `XMLType` is *deprecated*. Use binary XML storage instead.
 - The only storage format allowed for `XMLType` data in a shard table is CLOB storage.
-
-

With the use of appropriate indexes, binary XML storage offers good performance for most use cases. However, some advanced use cases can benefit from using object-relational storage.

You can change `XMLType` storage from one model to another using database import/export. Your application code need not change. You can change XML storage options when tuning your application.

For binary XML storage, SecureFiles is the default storage option.¹¹ However, if either of the following is true then it is not possible to use SecureFiles LOB storage. In that case, BasicFiles is the default option for binary XML data:

- The tablespace for the XMLType table does not use automatic segment space management.
- A setting in file `init.ora` prevents SecureFiles LOB storage. For example, see parameter `DB_SECUREFILE`.

See Also:

- [Choice of XMLType Storage and Indexing](#) (page 16-1)
 - [Export and Import of Oracle XML DB Data](#) (page 36-1)
 - *Oracle Database SQL Language Reference*, section "CREATE TABLE", clause "LOB_storage_clause"
 - *Oracle Database SecureFiles and Large Objects Developer's Guide* for information about LOB storage options SecureFiles and BasicFiles
 - *Oracle Database Administrator's Guide* for information about automatic segment space management
 - *Oracle Database Reference* for information about parameter `DB_SECUREFILE`
-
-

1.4.3 XML Schema Support in Oracle XML DB

Support for the World Wide Web Consortium (W3C) XML Schema Recommendation is a key feature in Oracle XML DB.

XML Schema specifies the structure, content, and certain semantics of XML documents. It is described in detail at <http://www.w3.org/TR/xmlschema-0/>.

The W3C Schema Working Group publishes a particular XML schema, often referred to as the **schema for schemas**, that provides the definition, or vocabulary, of the XML Schema language. An **XML schema definition (XSD²²)**, also called an **XML schema**, is an XML document that is compliant with the vocabulary defined by the schema for schemas.

An XML schema uses vocabulary defined by the schema for schemas to create a collection of XML Schema type definitions and element declarations that comprise a vocabulary for describing the contents and structure of a new class of XML documents, the **XML instance documents** that conform to that XML schema.

¹ Prior to Oracle Database 11g Release 2 (11.2.0.2) the BasicFiles option was the default for binary XML storage. Use of the BasicFiles option for binary XML data is *deprecated*.

² `xsd` is the prefix used in the schema of schemas for the XML Schema namespace, hence it is also the namespace prefix used for the XML Schema data types, such as `xsd:string`. `xsd` is also used often as the file extension of XML schema files.

Note:

This manual uses the term "XML schema" (lower-case "s") to reference any XML schema that conforms to the W3C XML Schema (upper-case "S") Recommendation. Since an XML schema is used to define a class of XML documents, the term "instance document" is often used to describe an XML document that conforms to a particular XML schema.

The XML Schema language provides strong typing of elements and attributes. It defines numerous scalar data types. This base set of data types can be extended to define more complex types, using object-oriented techniques such as inheritance and extension. The XML Schema vocabulary also includes constructs that you can use to define complex types, substitution groups, repeating sets, nesting, ordering, and so on. Oracle XML DB supports all of the constructs defined by the XML Schema Recommendation, except for `redefines`.

XML schemas are commonly used as a mechanism for checking (validating) whether XML instance documents conform with their specifications. Oracle XML DB includes `XMLType` methods and SQL functions that you can use to validate XML documents against an XML schema.

In Oracle XML DB, you can use a standard data model for all of your data, regardless of how structured it is. You can use XML Schema to automatically create database tables for storing your XML data. XML schema-based data maintains DOM fidelity and allows for significant database optimizations.

XML schema-based data can be stored using either Oracle XML DB `XMLType` storage model: binary XML storage or object-relational storage. Non-schema-based XML data can be stored only using binary XML storage.

You can also wrap existing relational and object-relational data as `XMLType` views, which can optionally be XML schema-based. You can map from incoming XML documents to `XMLType` storage, specifying the mapping using a registered XML schema.

See Also:

- [Choice of XMLType Storage and Indexing](#) (page 16-1) for information about `XMLType` storage models
 - [XML Schema Storage and Query: Basic](#) (page 17-1) for more information about using XML schemas with Oracle XML DB
-
-

1.4.4 DTD Support in Oracle XML DB

An XML schema is in general a much more powerful way to define XML document structure than is a DTD. You can nevertheless use DTDs to some extent with Oracle XML DB.

Like an XML schema, A **DTD** is a set of rules that define the allowable structure of an XML document. DTDs are text files that derive their format from SGML. They can be associated with an XML document by using DTD element `DOCTYPE` or by using an external file through a `DOCTYPE` reference.

Oracle XML DB uses XML Schema, not DTDs, to define structured mappings to `XMLType` storage, but XML processors can still access and interpret your DTDs.

Note:

You can use a DTD to obtain the XML entities defined in it. The entities are the only information used from the DTD. The structural and type information in the DTD is not used by Oracle XML DB.

Inline DTD Definitions

When an XML instance document has an inline DTD definition, that definition is used during document parsing. Any DTD validations and entity declaration handling are done at this point. However, once parsed, the entity references are replaced with actual values and the original entity reference is lost.

External DTD Definitions

Oracle XML DB supports external DTD definitions if they are stored in Oracle XML DB Repository. Applications needing to process an XML document containing an external DTD definition such as `/public/flights.dtd` must first ensure that the DTD document is stored in Oracle XML DB at path `/public/flights.dtd`.

See Also:

[Access to Oracle XML DB Repository Data](#) (page 21-1)

1.4.5 Static Data Dictionary Views Related to XML

Several static data dictionary views are related to XML.

[Table 1-1](#) (page 1-14) lists these views. Information about a given view can be obtained by using SQL command `DESCRIBE`:

```
DESCRIBE USER_XML_SCHEMAS
```

Table 1-1 Static Data Dictionary Views Related to XML

Schema	Description
USER_XML_SCHEMAS	Registered XML schemas <i>owned</i> by the current user
ALL_XML_SCHEMAS	Registered XML schemas <i>usable</i> by the current user
DBA_XML_SCHEMAS	Registered XML schemas in Oracle XML DB
USER_XML_TABLES	XMLType tables <i>owned</i> by the current user
ALL_XML_TABLES	XMLType tables <i>usable</i> by the current user
DBA_XML_TABLES	XMLType tables in Oracle XML DB
USER_XML_TABLE_COLUMNS	XMLType table columns <i>owned</i> by the current user
ALL_XML_TABLE_COLUMNS	XMLType table columns <i>usable</i> by the current user

Table 1-1 (Cont.) Static Data Dictionary Views Related to XML

Schema	Description
DBA_XML_TAB_COLS	XMLType table columns in Oracle XML DB
USER_XML_VIEWS	XMLType views <i>owned</i> by the current <i>user</i>
ALL_XML_VIEWS	XMLType views <i>usable</i> by the current <i>user</i>
DBA_XML_VIEWS	XMLType views in Oracle XML DB
USER_XML_VIEW_COLS	XMLType view columns <i>owned</i> by the current <i>user</i>
ALL_XML_VIEW_COLS	XMLType view columns <i>usable</i> by the current <i>user</i>
DBA_XML_VIEW_COLS	XMLType view columns in Oracle XML DB

In addition to the views ALL_XML_TABLES, DBA_XML_TABLES, and USER_XML_TABLES, views ALL_OBJECT_TABLES, DBA_OBJECT_TABLES, and USER_OBJECT_TABLES provide tablespace and other storage information for XMLType data stored object-rationally.

See Also:

- *Oracle Database Reference*
 - *Oracle Database PL/SQL Packages and Types Reference*
-
-

1.4.6 SQL/XML Standard Functions

Oracle XML DB provides the SQL functions that are defined in the SQL/XML standard.

SQL/XML functions fall into two groups:

- Functions that you can use to *generate* XML data from the result of a SQL query. In this book, these are called **SQL/XML publishing functions**. They are also sometimes called **SQL/XML generation functions**.
- Functions that you can use to *query* and *update* XML content as part of normal SQL operations. In this book, these are called **SQL/XML query and update functions**.

Using SQL/XML functions you can address XML content in any part of a SQL statement. These functions use XQuery or XPath expressions to traverse the XML structure and identify the nodes on which to operate. The ability to embed XQuery and XPath expressions in SQL statements greatly simplifies XML access.

See Also:

- *Oracle Database SQL Language Reference* for information about Oracle support for the SQL/XML standard
 - [Query and Update of XML Data](#) (page 5-1) and [XQuery and Oracle XML DB](#) (page 4-1) for detailed descriptions of the SQL/XML standard functions for *querying* XML data
 - [Generation of XML Data Using SQL Functions](#) (page 8-2) for information about SQL/XML standard functions for *generating* XML data
 - [Overview of How To Use Oracle XML DB](#) (page 3-1) for additional examples that use SQL/XML standard functions
 - [Standards Supported by Oracle XML DB](#) (page 1-18)
-

1.4.7 Programmatic Access to Oracle XML DB (Java, PL/SQL, and C)

All Oracle XML DB functionality is accessible from C, PL/SQL, and Java.

You can build Web-based applications that take advantage of Oracle XML DB in various ways, including these:

- Using servlets and Java Server Pages (JSP). A typical API accesses data using Java Database Connectivity (JDBC).
- Using Extensible Stylesheet Language (XSL) plus XML Server Pages (XSP). A typical API accesses data in the form of XML documents that are processed using a Document Object Model (DOM) API implementation.

Oracle XML DB supports such styles of application development. It provides Java, PL/SQL, and C implementations of the DOM API. Applications that use JDBC, such as those based on servlets, need prior knowledge of the data structure they are processing. Oracle JDBC drivers allow you to access and update `XMLType` tables and columns, and call PL/SQL procedures that access Oracle XML DB Repository. Applications that use DOM, such as those based on XSLT transformations, typically require less knowledge of the data structure. DOM-based applications use string names to identify pieces of content, and must dynamically walk through the DOM tree to find the required information. For this, Oracle XML DB supports the use of the DOM API to access and update `XMLType` columns and tables. Programming to a DOM API is more flexible than programming through JDBC, but it may require more resources at run time.

1.4.8 Oracle XML DB Repository: Overview

Oracle XML DB Repository is a component of Oracle Database that lets you handle XML data using a file/folder/URL metaphor.

Oracle XML DB Repository contains **resources**, which can be either **folders** (directories, containers) or files.

A resource, whether folder or file, has these properties:

- It is identified by a *path* and *name*.
- It has *content* (data), which can be XML data but need not be.

- It has a set of **system-defined metadata** (properties), such as `Owner` and `CreationDate`, in addition to its content. Oracle XML DB uses this information to manage the resource.
- It might also have **user-defined metadata**. Like system-defined metadata, this is information that is not part of the content, but is associated with it.
- It has an associated **access control list** that determines who can access the resource, and for what operations.

Although Oracle XML DB Repository treats XML content specially, you can use the repository to store other kinds of data besides XML. You can use the repository to access any data that is stored in Oracle Database.

You can access data in the repository in the following ways:

- SQL – Using views `RESOURCE_VIEW` and `PATH_VIEW`
- Standard protocols – FTP, HTTP(S), and WebDAV
- PL/SQL – Using PL/SQL package `DBMS_XDB_REPOS`
- Java – Using the Oracle XML DB resource API for Java

Besides providing APIs for accessing and manipulating repository data, Oracle XML DB provides APIs for the following repository services, which are based on IETF WebDAV:

- Versioning – Using PL/SQL package `DBMS_XDB_VERSION`
- ACL Security – Using access control lists (ACLs)
- Foldering – Using repository path names

[Figure 1-4](#) (page 1-18) illustrates the architecture of Oracle XML DB Repository.

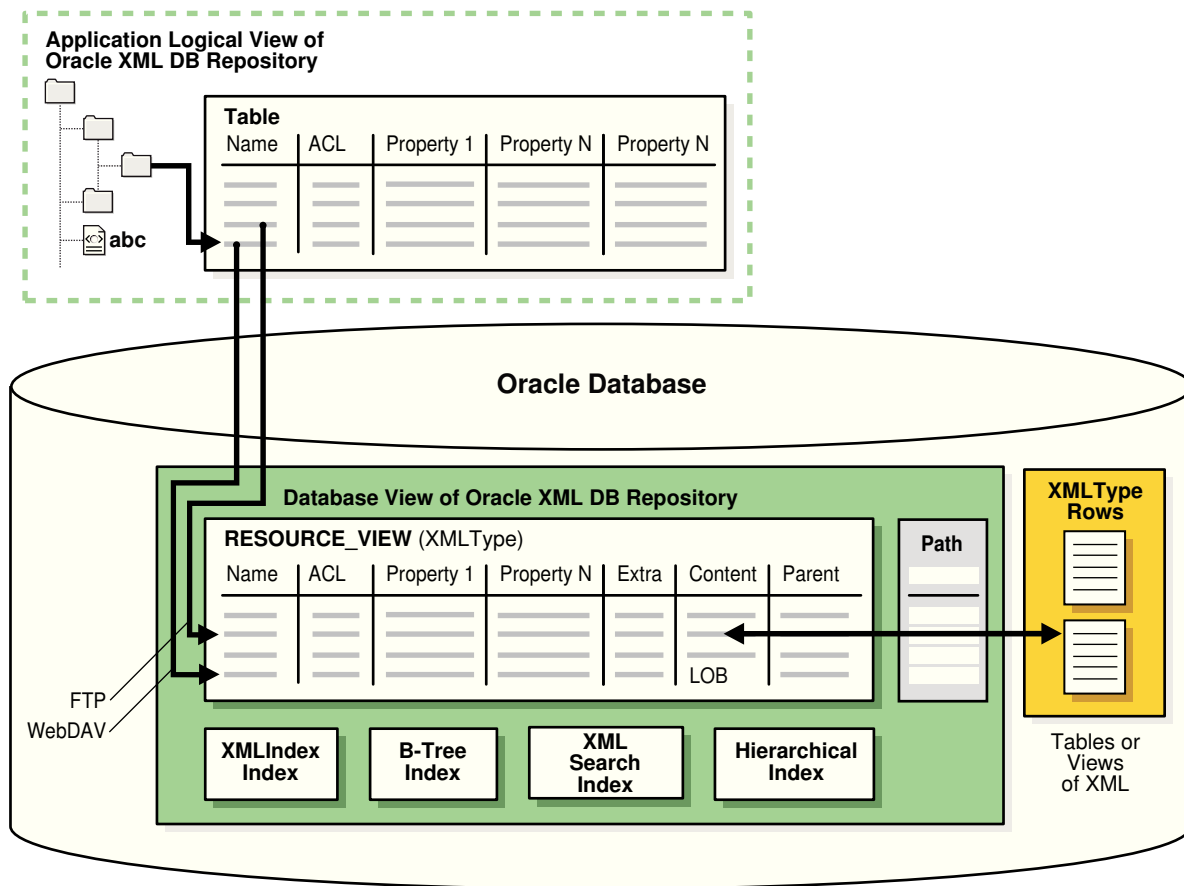
Figure 1-4 Oracle XML DB Repository Architecture

See Also:

[Oracle XML DB Repository](#) (page 1)

1.5 Standards Supported by Oracle XML DB

Oracle XML DB supports all major XML, SQL, Java, and Internet standards.

These include the following:

- W3C XML Schema 1.0 Recommendation. You can register XML schemas, validate stored XML content against XML schemas, or constrain XML stored in the server to XML schemas.
- W3C XQuery 1.0 Recommendation and W3C XPath 2.0 Recommendation. You can search or traverse XML stored inside the database using XQuery and XPath, either from HTTP(S) requests or from SQL.
- ANSI/ISO/IEC 9075-14:2011, Information technology—Database languages—SQL—Part 14: XML-Related Specifications (SQL/XML).
- W3C DOM Recommendation Levels 1.0 and 2.0 Core. You can retrieve XML stored in the server as an XML DOM, for dynamic access.
- Java Database Connectivity (JDBC) API. Provides Java access to XML data.

- XQuery API for Java (XQJ). Provides Java access to XML data using XQuery.
- W3C XSL 1.0 Recommendation. You can transform XML documents at the server using XSLT.
- Protocol support. You can store or retrieve XML data from Oracle XML DB using Oracle Net or standard protocols such as HTTP(S), FTP, and IETF WebDAV.
- Java Servlet version 2.2, (except: the servlet WAR file, `web.xml`, is not supported in its entirety; only one `ServletContext`; one `web-app` are currently supported; and stateful servlets are not supported).
- Web services: SOAP 1.1. You can access XML stored in the server from SOAP requests. You can build, publish, or find Web Services using Oracle XML DB and Oracle Fusion Middleware, using WSDL and UDDI. You can use Oracle Streams Advanced Queuing IDAP, the SOAP specification for queuing operations, on XML stored in Oracle Database.
- W3C XML Linking Language (Xlink) 1.0 Recommendation. You can define various types of links between XML documents.
- W3C XML Pointer Language (XPointer) Recommendation and XPointer Framework. You can include the content of multiple XML documents or fragments in a single infoset.

See Also:

- [SQL/XML Standard Functions](#) (page 1-15) for more information about the SQL/XML functions
- *Oracle XML Developer's Kit Programmer's Guide* for information about using XQJ
- *Oracle Database SQL Language Reference* for information about Oracle support for the SQL/XML standard
- [Use of XLink and XInclude with Oracle XML DB](#) (page 23-1) for more information about XLink and XPointer support
- [Repository Access Using Protocols](#) (page 28-1) for more information about protocol support
- [Guidelines for Oracle XML DB Applications in Java](#) (page 31-1) for information about using the Java servlet
- [XML Data Exchange Using Oracle Streams AQ](#) (page 37-1) and *Oracle Database Advanced Queuing User's Guide* for information about using SOAP

1.6 Oracle XML DB Technical Support

Besides the regular channels of support through your customer representative or consultant, technical support for Oracle Database XML-enabled technologies is available free through the discussion forums Oracle Technology Network (OTN).

The URL for the discussion forums is as follows: <https://community.oracle.com/community/database>

1.7 Oracle XML DB Examples

The examples that illustrate the use of Oracle XML DB and `XMLType` are based on various database schemas, sample XML documents, and sample XML schemas.

See Also:

[Oracle-Supplied XML Schemas and Examples](#) (page A-1)

1.8 Oracle XML DB Case Studies and Demonstrations on OTN

Visit OTN to view Oracle XML DB examples, white papers, case studies, and demonstrations.

This is the URL for OTN:<http://www.oracle.com/technetwork/database-features/xmldb/overview/index.html>

Comprehensive XML classes on how to use Oracle XML DB are also available. See the Oracle University link on OTN.

Detailed Oracle XML DB case studies available on OTN include the following:

- Oracle XML DB Downloadable Demonstration. This detailed demonstration illustrates how to use many Oracle XML DB features. Parts of this demonstration are also included in [Overview of How To Use Oracle XML DB](#) (page 3-1).
- SAX Loader Application. This demonstrates an efficient way to break up large files containing multiple XML documents outside the database and insert them into the database as a set of separate documents. This is provided as a standalone and a Web-based application.

Getting Started with Oracle XML DB

Some preliminary design criteria are presented for consideration when planning your Oracle XML DB solution.

- [Oracle XML DB Installation](#) (page 2-1)
- [Oracle XML DB Use Cases](#) (page 2-1)
- [Application Design Considerations for Oracle XML DB](#) (page 2-2)

2.1 Oracle XML DB Installation

Oracle XML DB is installed automatically if Database Configuration Assistant (DBCA) is used to build Oracle Database using the general-purpose template.

You can determine whether or not Oracle XML DB is already installed. If it is installed, then the following are true:

- Database schema (user account) XDB exists. To check that, run this query:

```
SELECT * FROM ALL_USERS;
```

- View RESOURCE_VIEW exists. To check that, use this command:

```
DESCRIBE RESOURCE_VIEW
```

See Also:

- [Administration of Oracle XML DB](#) (page 34-1) for information about installing Oracle XML DB *manually*
 - *Oracle Database 2 Day + Security Guide* for information about database schema XDB
-

2.2 Oracle XML DB Use Cases

Oracle XML DB is suited for any application where some or all of the data processed is represented using XML.

Oracle XML DB provides for high-performance database ingestion, storage, processing and retrieval of XML data. It also lets you quickly and easily generate XML from existing relational data. Applications for which Oracle XML DB is particularly suited include the following:

- Business-to-business (B2B) and application-to-application (A2A) integration
- Internet
- Content-management

- Messaging
- Web Services

A typical Oracle XML DB application has at least one of the following characteristics:

- Large numbers of XML documents must be ingested or generated
- Large XML documents must be processed or generated
- High-performance searching is needed, both within a document and across large collections of documents
- High levels of security are needed
- Fine-grained security is needed
- Data processing must use XML documents, and data must be stored in relational tables
- Programming must support open standards such as SQL, XML, XQuery, XPath, and XSL
- Information must be accessed using standard Internet protocols such as FTP, HTTP(S)/WebDAV, and Java Database Connectivity (JDBC)
- XML data must be queried from SQL
- Analytic capabilities must be applied to XML data
- XML documents must be validated against an XML schema

2.3 Application Design Considerations for Oracle XML DB

When planning an Oracle XML DB application it can be worthwhile to consider some preliminary design criteria.

These include the following:

- The ways that you intend to store your XML data
- The structure of your XML data
- The languages used to implement your application
- The ways you intend to process your XML data

However, in general Oracle recommends that you start with the following Oracle XML DB features. For most use cases they are all that you need to consider.

- Storage model – binary XML
- Indexing – XML search index, XMLIndex with structured component
- Database language – SQL, with SQL/XML functions
- XML languages – XQuery and XSLT
- Client APIs – OCI, thin JDBC, SQL .NET

See Also:

- [Choice of XMLType Storage and Indexing](#) (page 16-1)
- [SQL/XML Standard Functions](#) (page 1-15)
- [XQuery and Oracle XML DB](#) (page 4-1)
- [Transformation and Validation of XMLType Data](#) (page 7-1)
- [C DOM API for XMLType](#) (page 14-1)
- [Java DOM API for XMLType](#) (page 13-1)
- [Oracle XML DB and Oracle Data Provider for .NET](#) (page 15-1)

2.3.1 XML Data Storage

There are several ways to store XML data in Oracle Database.

Storage of XMLType tables and views is outlined in [Figure 2-1](#) (page 2-3).

Figure 2-1 Oracle XML DB Storage Options for XML Data

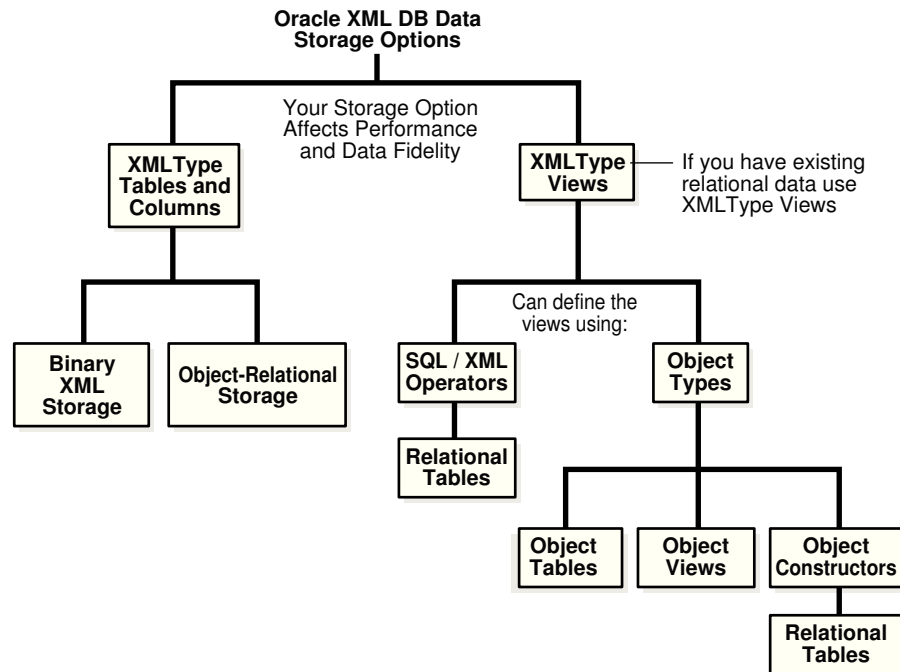

If you have existing relational data, you can access it as XML data by creating XMLType views over it. You can use the following to define the XMLType views:

- SQL/XML functions. See [Generation of XML Data from Relational Data](#) (page 8-1) and [XQuery and Oracle XML DB](#) (page 4-1).
- Object types: object tables, object constructors, and object views.

Regardless of which storage options you choose for your application, Oracle XML DB provides the same functionality. Though the storage model you use can affect your application performance and XML data fidelity, it is totally independent of how frequently you query or update your data and what APIs your application uses.

See Also:

[XMLType Storage Models](#) (page 1-11)

2.3.2 The Structure of Your XML Data

How structured your XML data is, and whether it is based on an XML schema, can influence how you store it.

If your XML data is *not* XML Schema-based, then, regardless of how structured it is, you can store it in an XMLType table or view as binary XML, or you can store it as a file in an Oracle XML DB Repository folder. You cannot store it object-relationally.

If your XML data is XML Schema-based then you must store it as binary XML or object-relationally.

See Also:

[Choice of XMLType Storage and Indexing](#) (page 16-1)

2.3.3 Languages Used to Implement Your Application

You can program your Oracle XML DB applications in Java or PL/SQL.

- Java (JDBC, Java Servlets)

See Also:

- [Java DOM API for XMLType](#) (page 13-1)
 - [Guidelines for Oracle XML DB Applications in Java](#) (page 31-1)
-
-

- PL/SQL

See Also:

- [PL/SQL APIs for XMLType](#) (page 11-1)
 - [PL/SQL Access to Oracle XML DB Repository](#) (page 26-1)
-
-

2.3.4 XML Processing Options

Oracle XML DB offers a full range of XML processing options.

The following are available and should be considered when designing your Oracle XML DB application:

- XML Generation and XMLType views. Whether you need to generate (or regenerate) XML data. See [Generation of XML Data from Relational Data](#) (page 8-1).
- Whether your application is data-centric or document-centric, or both. See [Overview of How To Use Oracle XML DB](#) (page 3-1).

- DOM fidelity, document fidelity. XMLType storage, whether object-relational or binary XML, preserves *DOM fidelity*. That is, A DOM created from an XML document stored as XMLType is identical to a DOM created from the original document. However, there could be differences in insignificant whitespace. See [DOM Fidelity](#) (page 17-6), [SYS_XDBPD\\$ and DOM Fidelity for Object-Relational Storage](#) (page 18-6), and [PL/SQL APIs for XMLType](#) (page 11-1).

If you need to preserve *document fidelity* (insignificant whitespace) in addition to DOM fidelity, then store two copies of your original document: one as an XMLType instance for database use and XML processing, the other as a CLOB instance to provide document fidelity.

- XPath searching. You can use XPath syntax embedded in a SQL statement to query XML content in the database. See [Query and Update of XML Data](#) (page 5-1), [Access to Oracle XML DB Repository Data](#) (page 21-1), and [Repository Access Using RESOURCE_VIEW and PATH_VIEW](#) (page 24-1).
- How often XML documents are accessed, updated, and manipulated. See [Query and Update of XML Data](#) (page 5-1).
- Whether you need to update fragments or whole documents. You can use XPath expressions to specify individual elements and attributes of your document during updates, without rewriting the entire document. This is more efficient, especially for large XML documents. See [Updating XML Data](#) (page 5-27).
- Which kinds of indexing best suit your application and data. See [Indexes for XMLType Data](#) (page 6-1).
- XSLT. Whether you need to transform the XML data to HTML, WML, or other languages, and, if so, how your application does this. While storing XML documents in Oracle XML DB, you can optionally ensure that their structure complies with (validates against) specific XML schemas. See [Transformation and Validation of XMLType Data](#) (page 7-1).

2.3.5 Oracle XML DB Repository Access

Design considerations for applications that use Oracle XML DB Repository include access method, security needs, and whether you need versioning.

There are two main repository access methods:

- Navigation-based access or path-based access. This is suitable for both content/document and data oriented applications. Oracle XML DB provides the following languages and access APIs:
 - SQL access through resource and path views. See [Repository Access Using RESOURCE_VIEW and PATH_VIEW](#) (page 24-1).
 - PL/SQL access using package DBMS_XDB or packages DBMS_XDB_ADMIN, DBMS_XDB_CONFIG and DBMS_XDB_REPOS. See [PL/SQL Access to Oracle XML DB Repository](#) (page 26-1).
 - Protocol-based access using HTTP(S)/WebDAV or FTP, most suited to content-oriented applications. See [Repository Access Using Protocols](#) (page 28-1).
- Query-based access. This can be most suited to data oriented applications. Oracle XML DB provides access using SQL queries through the following APIs:
 - Java access (through JDBC). See [Java DOM API for XMLType](#) (page 13-1).

- PL/SQL access. See [PL/SQL APIs for XMLType](#) (page 11-1).

These options for accessing repository data are also discussed in [Access to Oracle XML DB Repository Data](#) (page 21-1).

You can also consider the following access criteria:

- What levels of security you need. See [Repository Access Control](#) (page 27-1).
- Whether you need to version the data. See [Resource Versions](#) (page 25-1).

2.3.6 Oracle XML DB Cooperates with Other Database Options and Features

Oracle XML DB is an integrated part of Oracle Database, and works well with other database options and features.

- Oracle Streams Advanced Queuing (AQ) – merge XML payloads. See [XML Data Exchange Using Oracle Streams AQ](#) (page 37-1) and *Oracle Database Advanced Queuing User's Guide*
- Oracle GoldenGate and Oracle Active Data Guard – replicate and safeguard XML data, or perform a rolling upgrade. See *Oracle GoldenGate* and *Oracle Data Guard Concepts and Administration*
- Oracle Exadata Storage Server Software – high-performance, scalable, and highly available use of XML data. See *Oracle Exadata Storage Server Software User's Guide*.
- Oracle Real Application Clusters (Oracle RAC) – Use XML data with clusters of database instances. See *Oracle Real Application Clusters Administration and Deployment Guide*
- Oracle Multitenant option – Use XML data with a multitenant architecture, where each pluggable database has its own Oracle XML DB Repository. See *Oracle Database Concepts*
- Compression and Encryption – You can compress or encrypt binary XML data that uses SecureFiles LOB storage. For XML data stored object-relationally, you can compress or encrypt XML elements and attributes individually.
- Parallel Execution – Execution of the following operations can be carried out in parallel:
 - A query of XMLType data
 - DML for XMLType data stored as binary XML using SecureFiles LOBs
 - A direct load for an XMLType table on which an Oracle Text CONTEXT index is defined

See Also:

Oracle Database Concepts

Overview of How To Use Oracle XML DB

An overview of the various ways of using Oracle XML DB is presented.

This overview illustrates how to do the following: create and partition `XMLType` tables and columns; enforce data integrity, load, query, and update database XML content; and generate XML data from relational data. It also explains how Oracle XML DB determines which character sets are used for XML documents.

Purchase Order Documents Illustrate Key XML Schema Features

Many of the examples presented in this chapter illustrate techniques for accessing and managing XML content in purchase-order documents. Purchase orders are highly structured documents, but you can also use the techniques shown here to work with XML documents that have little structure.

The purchase-order documents used for the examples here conform to a purchase-order XML schema that demonstrates some key features of a typical XML document:

- Global element `PurchaseOrder` is an instance of the `complexType` `PurchaseOrderType`
- `PurchaseOrderType` defines the set of nodes that make up a `PurchaseOrder` element
- `LineItems` element consists of a collection of `LineItem` elements
- Each `LineItem` element consists of two elements: `Description` and `Part`
- `Part` element has attributes `Id`, `Quantity`, and `UnitPrice`

See Also:

- [Application Design Considerations for Oracle XML DB](#) (page 2-2) for recommended Oracle XML DB features for most uses
 - [XMLType APIs](#) (page 1), [XML Schema and Object-Relational XMLType](#) (page 1), and [Oracle XML DB Repository](#) (page 1) for information about more advanced Oracle XML DB features
 - [Purchase-Order XML Schemas](#) (page A-31) for the purchase-order XML schemas used for examples in this chapter
-

This chapter contains these topics:

- [Creating XMLType Tables and Columns](#) (page 3-2)
- [Creating Virtual Columns on XMLType Data Stored as Binary XML](#) (page 3-2)

- [Partitioning Tables That Contain XMLType Data Stored as Binary XML](#) (page 3-3)
- [Enforcing XML Data Integrity Using the Database](#) (page 3-5)
- [Loading XML Content into Oracle XML DB](#) (page 3-9)
- [Querying XML Content Stored in Oracle XML DB](#) (page 3-15)
- [Updating XML Content Stored in Oracle XML DB](#) (page 3-25)
- [Generating XML Data from Relational Data](#) (page 3-27)
- [Character Sets of XML Documents](#) (page 3-33)

3.1 Creating XMLType Tables and Columns

Creating a table or column of XMLType is straightforward because it is an abstract data type.

The basic CREATE TABLE statement, specifying no storage options and no XML schema, stores XMLType data as binary XML.¹¹

[Example 3-1](#) (page 3-2) creates an XMLType column, and [Example 3-2](#) (page 3-2) creates an XMLType table.

See Also:

[Creation of XMLType Tables and Columns Based on XML Schemas](#)
(page 17-17)

Example 3-1 *Creating a Table with an XMLType Column*

```
CREATE TABLE mytable1 (key_column VARCHAR2(10) PRIMARY KEY, xml_column XMLType);
```

Example 3-2 *Creating a Table of XMLType*

```
CREATE TABLE mytable2 OF XMLType;
```

3.2 Creating Virtual Columns on XMLType Data Stored as Binary XML

You can create virtual columns only for XMLType data that is stored as binary XML. Such columns are useful for partitioning or constraining the data.

You create virtual columns for XML data the same way you create them for other data types, but you use a slightly different syntax. (In particular, you cannot specify constraints in association with the column definition.)

You create a virtual column based on an XML element or attribute by defining it in terms of a SQL expression that involves that element or attribute. The column is thus function-based.

You use SQL/XML functions XMLCast and XMLQuery to do this, as shown in [Example 3-3](#) (page 3-3) and [Example 3-4](#) (page 3-3). The XQuery expression argument to function XMLQuery must be a simple XPath expression that uses only the child and attribute axes.

¹¹ The XMLType storage model for XML schema-based data is whatever was specified during registration of the referenced XML schema. If no storage model was specified during registration, then object-relational storage is used.

[Example 3-3](#) (page 3-3) creates XMLType table `po_binaryxml`, stored as binary XML. It creates virtual column `date_col`, which represents the XML data in attribute `/PurchaseOrder/@orderDate`.

[Example 3-4](#) (page 3-3) creates relational table `rel_tab`, which has two columns: VARCHAR2 column `key_col` for the primary key, and XMLType column `xml_col` for the XML data.

Because XMLType is an abstract data type, if you create virtual columns on an XMLType table or column then those columns are *hidden*. They do not show up in DESCRIBE statements, for example. This hiding enables tools that use operations such as DESCRIBE to function normally and not be misled by the virtual columns.

Note:

If you use a virtual column for interval partitioning then it *must* have data type NUMBER or DATE, otherwise an error is raised. Use SQL/XML functions XMLCast and XMLQuery to cast to the proper data type.

See Also:

- [Partitioning Tables That Contain XMLType Data Stored as Binary XML](#) (page 3-3)
 - [Enforcing Referential Integrity Using SQL Constraints](#) (page 3-6)
 - *Oracle Database SQL Language Reference* for information about creating tables with virtual columns
-
-

Example 3-3 Creating a Virtual Column for an XML Attribute in an XMLType Table

```
CREATE TABLE po_binaryxml OF XMLType
XMLTYPE STORE AS BINARY XML
VIRTUAL COLUMNS
(date_col AS (XMLCast(XMLQuery('/PurchaseOrder/@orderDate'
                             PASSING OBJECT_VALUE RETURNING CONTENT)
                             AS DATE)));
```

Example 3-4 Creating a Virtual Column for an XML Attribute in an XMLType Column

```
CREATE TABLE reltab (key_col VARCHAR2(10) PRIMARY KEY,
                    xml_col XMLType)
XMLTYPE xml_col STORE AS BINARY XML
VIRTUAL COLUMNS
(date_col AS (XMLCast(XMLQuery('/PurchaseOrder/@orderDate'
                             PASSING xml_col RETURNING CONTENT)
                             AS DATE)));
```

3.3 Partitioning Tables That Contain XMLType Data Stored as Binary XML

You can partition a table that contains XMLType data stored as binary XML.

There are two possibilities:

- The table is relational, with an XMLType column and a non-XMLType column.

- The table is of data type XMLType.

In the case of an XMLType column, you use the non-XMLType column as the partitioning key. This is illustrated in [Example 3-5](#) (page 3-5).

This case presents nothing new or specific with respect to XML data. The fact that one of the columns contains XMLType data is irrelevant. Things are different for the other case: partitioning an XMLType table.

XML data has its own structure, which (except for object-relational storage of XMLType) is not reflected directly in database data structure. For XMLType data stored as binary XML, individual XML elements and attributes are not mapped to individual database columns or tables.

Therefore, to partition binary XML data according to the values of individual elements or attributes, the standard approach for relational data does not apply. Instead, you must create *virtual columns* that represent the XML data of interest, and then use those virtual columns to define the constraints or partitions that you need.

The technique is as follows:

1. Define virtual columns that correspond to the XML elements or attributes that you are interested in.
2. Use those columns to partition the XMLType data as a whole.

This is illustrated in [Example 3-6](#) (page 3-5): virtual column `date_col` targets the `orderDate` attribute of element `PurchaseOrder` in a purchase-order document. This column is used as the partitioning key.

For best performance using a partitioned table containing XML data, Oracle recommends that you use an XMLType column rather than an XMLType table, and you therefore partition using a non-XMLType column.

Note:

- You can partition an XMLType table using a virtual column only if the storage model is binary XML. Range, hash, and list partitioning are supported.
 - Partitioning of XMLType tables stored as XML is supported starting with 11g Release 2 (11.2). It is supported only if the database compatibility (parameter `compatible` in file `init.ora`) is 11.2 or higher.
 - If a relational table has an XMLType *column*, you cannot partition the table using that column to define virtual columns of XML data.
-
-

See Also:

- [XMLIndex Partitioning and Parallelism](#) (page 6-41)
 - [Overview of Partitioning XMLType Tables and Columns Stored Object-Relationally](#) (page 18-34)
-
-

Example 3-5 Partitioning a Relational Table That Has an XMLType Column

```
CREATE TABLE reltab (key_col VARCHAR2(10) PRIMARY KEY,
                    xml_col XMLType)
XMLTYPE xml_col STORE AS BINARY XML
PARTITION BY RANGE (key_col)
(PARTITION P1 VALUES LESS THAN ('abc'),
 PARTITION P2 VALUES LESS THAN (MAXVALUE));
```

Example 3-6 Partitioning an XMLType Table

```
CREATE TABLE po_binaryxml OF XMLType
XMLTYPE STORE AS BINARY XML
VIRTUAL COLUMNS
(date_col AS (XMLCast(XMLQuery('/PurchaseOrder/@orderDate'
                              PASSING OBJECT_VALUE RETURNING CONTENT)
                        AS DATE)))
PARTITION BY RANGE (date_col)
(PARTITION orders2001 VALUES LESS THAN (to_date('01-JAN-2002')),
 PARTITION orders2002 VALUES LESS THAN (MAXVALUE));
```

3.4 Enforcing XML Data Integrity Using the Database

You can combine the power of SQL and XML with the ability of the database to enforce rules.

You can use SQL to supplement the functionality provided by XML schema. Only well-formed XML documents can be stored in XMLType tables or columns. A **well-formed** XML document is one that conforms to the syntax of the XML version declared in its XML declaration. This includes having a single root element, properly nested tags, and so forth. Additionally, if the XMLType table or column is constrained to an XML schema then only documents that conform to that XML schema can be stored in that table or column. Any attempt to store or insert any other kind of XML document in an XML schema-based XMLType raises an error. [Example 3-7](#) (page 3-6) illustrates this.

Such an error occurs only when content is inserted directly into an XMLType table. It indicates that Oracle XML DB did not recognize the document as a member of the class defined by the XML schema. For a document to be recognized as a member of the class defined by the schema, the following conditions must be true:

- The name of the XML document root element must match the name of global element used to define the XMLType table or column.
- The XML document must include the appropriate attributes from the XMLSchema-instance namespace, or the XML document must be explicitly associated with the XML schema using the XMLType constructor or XMLType method `createSchemaBasedXML()`.

If the constraining XML schema declares a `targetNamespace`, then the instance documents must contain the appropriate namespace declarations to place the root element of the document in the `targetNamespace` defined by the XML schema.

Note:

XML constraints are enforced only within individual XML documents. Database (SQL) constraints are enforced across sets of XML documents.

See Also:

[Partial and Full XML Schema Validation](#) (page 7-12)

Example 3-7 Error From Attempting to Insert an Incorrect XML Document

```
INSERT INTO purchaseorder
VALUES (XMLType(bfilename('XMLDIR', 'Invoice.xml'), nls_charset_id('AL32UTF8')))
VALUES (XMLType(bfilename('XMLDIR', 'Invoice.xml'), nls_charset_id('AL32UTF8')))
*
```

ERROR at line 2:
ORA-19007: Schema - does not match expected
<http://localhost:8080/source/schemas/poSource/xsd/purchaseOrder.xsd>.

3.4.1 Enforcing Referential Integrity Using SQL Constraints

You can use SQL constraints and database triggers to ensure data-integrity properties such as uniqueness and foreign-key relations.

The W3C XML Schema Recommendation defines a powerful language for defining the contents of an XML document. However, there are some simple data management concepts that are not currently addressed by the W3C XML Schema Recommendation. These include the ability to ensure that the value of an element or attribute has either of these properties:

- It is unique across a set of XML documents (a `UNIQUE` constraint).
- It exists in a particular data source that is outside of the current document (`FOREIGN KEY` constraint).

With Oracle XML DB, however, you can enforce such constraints. The mechanisms that you use to enforce integrity on XML data are the same as those you use to enforce integrity on relational data. Simple rules, such as uniqueness and foreign-key relationships, can be enforced by specifying SQL constraints. More complex rules can be enforced by specifying database triggers.

Oracle XML DB lets you use the database to enforce business rules on XML content, in addition to enforcing rules that can be specified using XML Schema constructs. The database enforces these business rules regardless of whether XML is inserted directly into a table or uploaded using one of the protocols supported by Oracle XML DB Repository.

XML data has its own structure, which (except for object-relational storage of `XMLType`) is not reflected directly in database data structure. For `XMLType` data stored as binary XML, individual XML elements and attributes are not mapped to individual database columns or tables.

Therefore, to constrain binary XML data according to the values of individual elements or attributes, the standard approach for relational data does not apply. Instead, you must create *virtual columns* that represent the XML data of interest, and then use those virtual columns to define the constraints that you need.

The technique is as follows:

1. Define virtual columns that correspond to the XML elements or attributes that you are interested in.
2. Use those columns to constrain the `XMLType` data as a whole.

The binary XML data can be in an XMLType table or an XMLType column of a relational table. In the former case, you can include creation of the constraint as part of the CREATE TABLE statement, if you like. For the latter case, you must create the constraint using an ALTER TABLE statement, after the relational table has been created.

See also:

- [Specification of Relational Constraints on XMLType Tables and Columns](#) (page 18-37)
 - [Creating Virtual Columns on XMLType Data Stored as Binary XML](#) (page 3-2)
 - *Oracle Database Error Messages Reference*
-
-

Example 3-8 Constraining a Binary XML Table Using a Virtual Column

This example illustrates the technique for an XMLType table. It defines virtual column `c_xtabref` using the Reference element in a purchase-order document. It defines uniqueness constraint `reference_is_unique` on that column, which ensures that the value of node `/PurchaseOrder/Reference/text()` is unique across all documents that are stored in the table. It fills the table with the data from `OE.purchaseorder`. It then tries to insert a duplicate document, `DuplicateReference.xml`, which violates the uniqueness constraint, raising an error.

```
CREATE TABLE po_binaryxml OF XMLType
  (CONSTRAINT reference_is_unique UNIQUE (c_xtabref))
 XMLTYPE STORE AS BINARY XML
 VIRTUAL COLUMNS
  (c_xtabref AS (XMLCast(XMLQuery('/PurchaseOrder/Reference'
                                PASSING OBJECT_VALUE RETURNING CONTENT)
                          AS VARCHAR2(32))));

INSERT INTO po_binaryxml SELECT OBJECT_VALUE FROM OE.purchaseorder;

132 rows created.

INSERT INTO po_binaryxml
  VALUES (XMLType(bfilename('XMLDIR', 'DuplicateReference.xml'),
                  nls_charset_id('AL32UTF8')));
INSERT INTO po_binaryxml
*
ERROR at line 1:
ORA-00001: unique constraint (OE.REFERENCE_IS_UNIQUE) violated
```

Example 3-9 Constraining a Binary XML Column Using a Virtual Column: Uniqueness

This example illustrates the technique for an XMLType column of a relational table. It defines virtual column `c_xcolref` and uniqueness constraint `fk_ref`, which references the uniqueness constraint defined in [Example 3-8](#) (page 3-7). As in [Example 3-8](#) (page 3-7), this ensures that the value of node `/PurchaseOrder/Reference/text()` is unique across all documents that are stored in XMLType column `po_binxml_col`.

The example fills the XMLType column with the same data from OE.purchaseorder. It then tries to insert duplicate document, DuplicateReference.xml, which violates the uniqueness constraint, raising an error.

```
CREATE TABLE po_reltab (po_binxml_col XMLType)
  XMLTYPE po_binxml_col STORE AS BINARY XML
  VIRTUAL COLUMNS
    (c_xcolref AS (XMLCast (XMLQuery('/PurchaseOrder/Reference'
      PASSING po_binxml_col RETURNING CONTENT)
      AS VARCHAR2(32))));

ALTER TABLE po_reltab ADD CONSTRAINT reference_is_unique UNIQUE (c_xcolref));

INSERT INTO po_reltab SELECT OBJECT_VALUE FROM OE.purchaseorder;
INSERT INTO po_reltab
  VALUES (XMLType(bfilename('XMLDIR', 'DuplicateReference.xml'),
    nls_charset_id('AL32UTF8')));
INSERT INTO po_reltab
*
ERROR at line 1:
ORA-00001: unique constraint (OE.REFERENCE_IS_UNIQUE) violated
```

Example 3-10 Constraining a Binary XML Column Using a Virtual Column: Foreign Key

This example is similar to [Example 3-9](#) (page 3-7), but it uses a foreign-key constraint, fk_ref, which references the column with the uniqueness constraint defined in [Example 3-8](#) (page 3-7). Insertion of the document in file DuplicateReference.xml succeeds here, since that document is in (virtual) column c_tabref of table po_binaryxml. Insertion of a document that does not match any document in table po_binaryxml.

```
CREATE TABLE po_reltab (po_binxml_col XMLType)
  XMLTYPE po_binxml_col STORE AS BINARY XML
  VIRTUAL COLUMNS
    (c_xcolref AS (XMLCast (XMLQuery('/PurchaseOrder/Reference'
      PASSING po_binxml_col RETURNING CONTENT)
      AS VARCHAR2(32))));

ALTER TABLE po_reltab ADD CONSTRAINT fk_ref FOREIGN KEY (c_xcolref)
  REFERENCES po_binaryxml(c_xtabref);

INSERT INTO po_reltab
  VALUES (XMLType(bfilename('XMLDIR', 'DuplicateReference.xml'),
    nls_charset_id('AL32UTF8')));

INSERT INTO po_reltab
  VALUES ('<PurchaseOrder><Reference>Not Compliant</Reference></PurchaseOrder>');
INSERT INTO po_reltab VALUES ('<PurchaseOrder><Reference>Not Compliant
</Reference></PurchaseOrder>')
*
ERROR at line 1:
ORA-02291: integrity constraint (OE.FK_REF) violated - parent key not found
```

Example 3-11 Enforcing Database Integrity When Loading XML Using FTP

Integrity rules defined using constraints and triggers are also enforced when XML schema-based XML content is loaded into Oracle XML DB Repository. This example shows that database integrity is also enforced when a protocol, such as FTP, is used to upload XML schema-based XML content into Oracle XML DB Repository. In this case, additional constraints, besides uniqueness, were also violated.

```

$ ftp localhost 2100
Connected to localhost.
220 mdrake-sun FTP Server (Oracle XML DB/Oracle Database 10g Enterprise Edition
Release 10.1.0.0.0 - Beta) ready.
Name (localhost:oracle10): QUINE
331 Password required for QUINE
Password: password
230 QUINE logged in
ftp> cd /source/schemas
250 CWD Command successful
ftp> put InvalidReference.xml
200 PORT Command successful
150 ASCII Data Connection
550- Error Response
ORA-00604: error occurred at recursive SQL level 1
ORA-31154: invalid XML document
ORA-19202: Error occurred in XML processing
LSX-00221: "SBELL-20021009" is too short (minimum length is 18)
ORA-06512: at "SYS.XMLTYPE", line 333
ORA-06512: at "QUINE.VALIDATE_PURCHASEORDER", line 3
ORA-04088: error during execution of trigger 'QUINE.VALIDATE_PURCHASEORDER'
550 End Error Response
ftp> put InvalidElement.xml
200 PORT Command successful
150 ASCII Data Connection
550- Error Response
ORA-30937: No schema definition for 'UserName' (namespace '##local') in parent
'PurchaseOrder'
550 End Error Response
ftp> put DuplicateReference.xml
200 PORT Command successful
150 ASCII Data Connection
550- Error Response
ORA-00604: error occurred at recursive SQL level 1
ORA-00001: unique constraint (QUINE.REFERENCE_IS_UNIQUE) violated
550 End Error Response
ftp> put InvalidUser.xml
200 PORT Command successful
150 ASCII Data Connection
550- Error Response
ORA-00604: error occurred at recursive SQL level 1
ORA-02291: integrity constraint (QUINE.USER_IS_VALID) violated - parent key not
found
550 End Error Response

```

When an error occurs while a document is being uploaded using a protocol, Oracle XML DB provides the client with the full SQL error trace. How the error is interpreted and reported to you is determined by the error-handling built into the client application. Some clients, such as a command line FTP tool, report the error returned by Oracle XML DB, while others, such as Microsoft Windows Explorer, report a generic error message.

3.5 Loading XML Content into Oracle XML DB

There are several ways to load XML content into Oracle XML DB.

- Table-based loading:
 - [Loading XML Content Using SQL or PL/SQL](#) (page 3-10)

- [Loading XML Content Using Java](#) (page 3-11)
- [Loading XML Content Using C](#) (page 3-11)
- [Loading Large XML Files that Contain Small XML Documents](#) (page 3-13)
- [Loading Large XML Files Using SQL*Loader](#) (page 3-13)
- Path-based repository loading techniques:
 - [Loading XML Documents into the Repository Using DBMS_XDB_REPOS](#) (page 3-14)
 - [Loading Documents into the Repository Using Protocols](#) (page 3-14)

3.5.1 Loading XML Content Using SQL or PL/SQL

You can use a simple `INSERT` operation in SQL or PL/SQL to load an XML document into the database.

Before the document can be stored as an `XMLType` column or table, you must convert it into an `XMLType` instance using one of the `XMLType` constructors.

See Also:

- [Query and Update of XML Data](#) (page 5-1)
 - [PL/SQL APIs for XMLType: References](#) (page 11-2)
 - *Oracle Database PL/SQL Packages and Types Reference* for a description of the `XMLType` constructors
-
-

`XMLType` **constructors** allow an `XMLType` instance to be created from different sources, including `VARCHAR`, `CLOB`, and `BFILE` values. The constructors accept additional arguments that reduce the amount of processing associated with `XMLType` creation. For example, if you are sure that a given source XML document is valid, you can provide an argument to the constructor that disables the type-checking that is otherwise performed.

In addition, if the source data is not encoded in the database character set, an `XMLType` instance can be constructed using a `BFILE` or `BLOB` value. The encoding of the source data is specified through the character set id (`csid`) argument of the constructor.

When you use SQL `INSERT` to insert a large document containing collections into `XMLType` tables (but not into `XMLType` columns), Oracle XML DB optimizes load time and memory usage.

Example 3-13 (page 3-11) shows how to insert XML content into an `XMLType` table. Before making this insertion, you must create a database directory object that points to the directory containing the file to be processed. To do this, you must have the `CREATE ANY DIRECTORY` privilege.

See Also:

- *Oracle Database SQL Language Reference*, under GRANT
- [Considerations for Loading and Retrieving Large Documents with Collections](#) (page 18-57)

Example 3-12 Creating a Database Directory

```
CREATE DIRECTORY xmldir AS path_to_folder_containing_XML_file;
```

Example 3-13 Inserting XML Content into an XMLType Table

```
INSERT INTO mytable2 VALUES (XMLType(bfilename('XMLDIR', 'purchaseOrder.xml'),
                                     nls_charset_id('AL32UTF8')));
```

The value passed to `nls_charset_id` indicates that the encoding for the file to be read is UTF-8.

3.5.2 Loading XML Content Using Java

With a DOM you can use Java to load a SQLXML instance.

[Example 3-14](#) (page 3-11) shows how to load XML content into Oracle XML DB by first creating a SQLXML instance in Java, given a Document Object Model (DOM).

A simple bulk loader application is available on the Oracle Technology Network (OTN) site at <http://www.oracle.com/technetwork/database-features/xmlldb/overview/index.html>. It shows how to load a directory of XML files into Oracle XML DB using Java Database Connectivity (JDBC). JDBC is a set of Java interfaces to Oracle Database.

Example 3-14 Inserting Content into an XMLType Table Using Java

```
public void doInsert(Connection conn, Document doc)
throws Exception
{
    String query = "INSERT INTO purchaseorder VALUES (?)";
    SQLXML sx = conn.createSQLXML();
    DOMResult dom = sx.setResult(DOMResult.class);
    dom.setNode(doc);
    PreparedStatement statement = conn.prepareStatement(query);
    statement.setSQLXML(1, sx);
    statement.execute();
}
```

3.5.3 Loading XML Content Using C

With a DOM you can use C code to load an XMLType instance.

[Example 3-15](#) (page 3-12) shows how to insert XML content into an XMLType table using C code, by creating an XMLType instance given a DOM (see *Oracle XML Developer's Kit Programmer's Guide*). See [Loading XML Data Using C \(OCI\)](#) (page A-46) for a complete listing of this example.

Note:

For simplicity in demonstrating this feature, this example does not perform the password management techniques that a deployed system normally uses. In a production environment, follow the Oracle Database password management guidelines, and disable any sample accounts. See *Oracle Database Security Guide* for password management guidelines and other security recommendations.

Example 3-15 Inserting Content into an XMLType Table Using C

```

. . .
void main()
{
    OCIType *xmltdo;
    xmldocnode *doc;
    ocixmlbparam params[1];
    xmlerr      err;
    xmlctx      *xctx;
    oratext     *ins_stmt;
    sword       status;
    xmlnode     *root;
    oratext     buf[10000];

    /* Initialize envhp, svchp, errhp, dur, stmthp */
    init_oci_connect();

    /* Get an XML context */
    params[0].name_ocixmlbparam = XCTXINIT_OCIDUR;
    params[0].value_ocixmlbparam = &dur;
    xctx = OCIXmlDbInitXmlCtx(envhp, svchp, errhp, params, 1);
    if (!(doc = XmlLoadDom(xctx, &err, "file", filename,
                          "schema_location", schemaloc, NULL)))
    {
        printf("Parse failed.\n");
        return;
    }
    else
        printf("Parse succeeded.\n");
    root = XmlDomGetDocElem(xctx, doc);
    printf("The xml document is :\n");
    XmlSaveDom(xctx, &err, (xmlnode *)doc, "buffer", buf, "buffer_length", 10000, NULL);
    printf("%s\n", buf);

    /* Insert the document into my_table */
    ins_stmt = (oratext *)"insert into purchaseorder values (:1)";
    status = OCITypeByName(envhp, errhp, svchp, (const text *) "SYS",
                          (ub4) strlen((const char *)"SYS"), (const text *) "XMLTYPE",
                          (ub4) strlen((const char *)"XMLTYPE"), (CONST text *) 0,
                          (ub4) 0, OCI_DURATION_SESSION, OCI_TYPEGET_HEADER,
                          (OCIType **) &xmltdo);
    if (status == OCI_SUCCESS)
    {
        status = exec_bind_xml(svchp, errhp, stmthp, (void *)doc,
                              xmltdo, ins_stmt);
    }
    if (status == OCI_SUCCESS)
        printf ("Insert successful\n");
    else
        printf ("Insert failed\n");

    /* Free XML instances */
    if (doc)
        XmlFreeDocument((xmlctx *)xctx, (xmldocnode *)doc);
    /* Free XML CTX */
}

```

```

OCIXmlDbFreeXmlCtx(xctx);
free_oci();
}

```

3.5.4 Loading Large XML Files that Contain Small XML Documents

When loading large XML files consisting of a collection of smaller XML documents, it is often more efficient to use Simple API for XML (SAX) parsing to break the file into a set of smaller documents, and then insert those documents.

SAX is an XML standard interface provided by XML parsers for event-based applications. You can use SAX to load a database table from very large XML files in the order of 30 MB or larger, by creating individual documents from a collection of nodes. You can also bulk load XML files.

See Also:

- <http://www.saxproject.org/> for information about SAX
 - <http://www.oracle.com/technetwork/database-features/xmldb/overview/index.html>, for an application example that loads large files using SAX
-
-

3.5.5 Loading Large XML Files Using SQL*Loader

You can use SQL*Loader to load large amounts of XML data into Oracle Database.

SQL*Loader loads in one of two modes, conventional or direct path. [Table 3-1](#) (page 3-13) compares these modes.

Table 3-1 SQL*Loader – Conventional and Direct-Path Load Modes

Conventional Load Mode	Direct-Path Load Mode
Uses SQL to load data into Oracle Database. This is the <i>default</i> mode.	Bypasses SQL and streams the data directly into Oracle Database.
<i>Advantage:</i> Follows SQL semantics. For example triggers are fired and constraints are checked.	<i>Advantage:</i> This loads data much faster than the conventional load mode.
<i>Disadvantage:</i> This loads data slower than with the direct load mode.	<i>Disadvantage:</i> SQL semantics is not obeyed. For example triggers are not fired and constraints are not checked.

When loading LOBs with SQL*Loader direct-path load, much memory can be used. If the message SQL*Loader 700 (out of memory) appears, then it is likely that more rows are being included in each load call than can be handled by your operating system and process memory. *Workaround:* use the ROWS option to read a smaller number of rows in each data save.

See Also:

[How to Load XML Data](#) (page 35-1)

3.5.6 Loading XML Documents into the Repository Using DBMS_XDB_REPOS

You can use PL/SQL package `DBMS_XDB_REPOS` to load XML documents into Oracle XML DB Repository. You can access repository documents (resources) using path-based rather than table-based techniques.

To load an XML document into the repository under a given path, use PL/SQL function `DBMS_XDB_REPOS.createResource`. [Example 3-16](#) (page 3-14) illustrates this.

Many operations for configuring and using Oracle XML DB are based on processing one or more XML documents. Examples include registering an XML schema and performing an XSL transformation. The easiest way to make these XML documents available to Oracle Database is to load them into Oracle XML DB Repository.

Example 3-16 Inserting XML Content into the Repository Using CREATERESOURCE

```
DECLARE
    res BOOLEAN;
BEGIN
    res := DBMS_XDB_REPOS.createResource('/home/QUINE/purchaseOrder.xml',
                                         bfilename('XMLDIR', 'purchaseOrder.xml'),
                                         nls_charset_id('AL32UTF8'));
END;/
```

3.5.7 Loading Documents into the Repository Using Protocols

You can load documents, including XML documents, from a local file system into Oracle XML DB Repository using popular protocols.

Oracle XML DB Repository can store XML documents that are either XML schema-based or non-schema-based. It can also store content that is not XML data, such as HTML files, image files, and Microsoft Word documents.

You can load XML documents from a local file system into Oracle XML DB Repository using protocols such as WebDAV, from Windows Explorer or other tools that support WebDAV. [Figure 3-1](#) (page 3-14) shows a simple drag and drop operation for copying the contents of the `SCOTT` folder from the local hard drive to folder `poSource` in Oracle XML DB Repository.

Figure 3-1 Loading Content into the Repository Using Windows Explorer

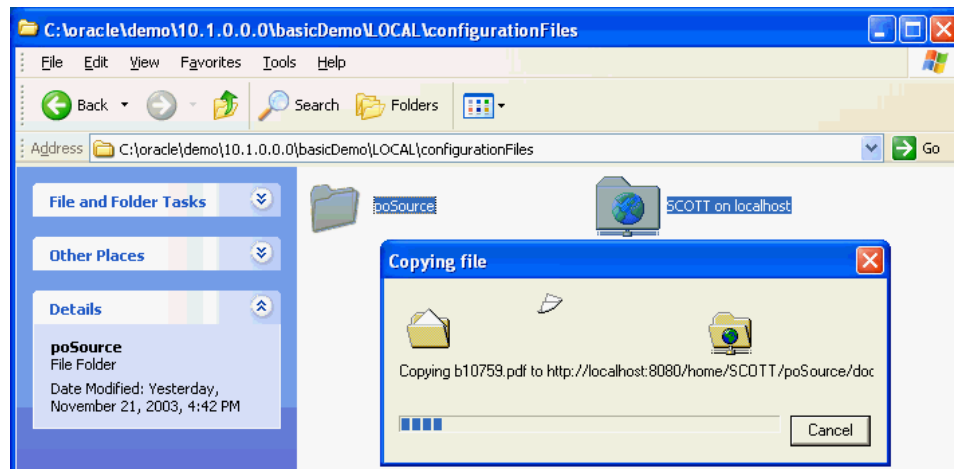

The copied folder might contain, for example, an XML schema document, an HTML page, and some XSLT stylesheets.

3.6 Querying XML Content Stored in Oracle XML DB

There are many ways to query XML content in Oracle XML DB and retrieve it.

- [PurchaseOrder XML Document Used in Examples](#) (page 3-15)
- [Retrieving the Content of an XML Document Using Pseudocolumn OBJECT_VALUE](#) (page 3-16)
- [Accessing Fragments or Nodes of an XML Document Using XMLQUERY](#) (page 3-17)
- [Accessing Text Nodes and Attribute Values Using XMLCAST and XMLQUERY](#) (page 3-18)
- [Searching an XML Document Using XMLEXISTS, XMLCAST, and XMLQUERY](#) (page 3-19)
- [Performing SQL Operations on XMLType Fragments Using XMLTABLE](#) (page 3-22)

Note:

For efficient query performance you typically need to create indexes. For information about indexing XML data, see [Indexes for XMLType Data](#) (page 6-1).

3.6.1 PurchaseOrder XML Document Used in Examples

An XML schema defines the purchase-order documents used in examples.

Examples presented here are based on the `PurchaseOrder` XML document shown in [Example 3-17](#) (page 3-15).

Example 3-17 *PurchaseOrder XML Instance Document*

```
<PurchaseOrder
  xmlns:xsi="http://www.w3.org/2001/XMLSchema-instance"
  xsi:noNamespaceSchemaLocation=
    "http://localhost:8080/source/schemas/poSource/xsd/purchaseOrder.xsd">
  <Reference>SBELL-2002100912333601PDT</Reference>
  <Actions>
    <Action>
      <User>SVOLLMAN</User>
    </Action>
  </Actions>
  <Reject/>
  <Requestor>Sarah J. Bell</Requestor>
  <User>SBELL</User>
  <CostCenter>S30</CostCenter>
  <ShippingInstructions>
    <name>Sarah J. Bell</name>
    <address>400 Oracle Parkway
      Redwood Shores
      CA
      94065
```

```

        USA</address>
    <telephone>650 506 7400</telephone>
</ShippingInstructions>
<SpecialInstructions>Air Mail</SpecialInstructions>
<LineItems>
    <LineItem ItemNumber="1">
        <Description>A Night to Remember</Description>
        <Part Id="715515009058" UnitPrice="39.95" Quantity="2"/>
    </LineItem>
    <LineItem ItemNumber="2">
        <Description>The Unbearable Lightness Of Being</Description>
        <Part Id="37429140222" UnitPrice="29.95" Quantity="2"/>
    </LineItem>
    <LineItem ItemNumber="3">
        <Description>Sisters</Description>
        <Part Id="715515011020" UnitPrice="29.95" Quantity="4"/>
    </LineItem>
</LineItems>
</PurchaseOrder>

```

3.6.2 Retrieving the Content of an XML Document Using Pseudocolumn OBJECT_VALUE

Pseudocolumn OBJECT_VALUE can be used as an alias for the value of an object table.

For an XMLType table that consists of a single column of XMLType, the entire XML document is retrieved. (OBJECT_VALUE replaces the value(x) and SYS_NC_ROWINFO\$ aliases used in releases prior to Oracle Database 10g Release 1.)

In [Example 3-18](#) (page 3-16), the SQL*Plus settings PAGESIZE and LONG are used to ensure that the entire document is printed correctly, without line breaks. (The output has been formatted for readability.)

Example 3-18 Retrieving an Entire XML Document Using OBJECT_VALUE

```
SELECT OBJECT_VALUE FROM purchaseorder;
```

```

OBJECT_VALUE
-----
<PurchaseOrder xmlns:xsi="http://www.w3.org/2001/XMLSchema-instance"
  xsi:noNamespaceSchemaLocation="http://localhost:8080/source/schemas
/poSource/xsd/purchaseOrder.xsd">
  <Reference>SBELL-2002100912333601PDT</Reference>
  <Actions>
    <Action>
      <User>SVOLLMAN</User>
    </Action>
  </Actions>
  <Reject/>
  <Requestor>Sarah J. Bell</Requestor>
  <User>SBELL</User>
  <CostCenter>S30</CostCenter>
  <ShippingInstructions>
    <name>Sarah J. Bell</name>
    <address>400 Oracle Parkway
Redwood Shores
CA
94065
USA</address>
    <telephone>650 506 7400</telephone>
  </ShippingInstructions>

```



```

<SpecialInstructions>Air Mail</SpecialInstructions>
<LineItems>
  <LineItem ItemNumber="1">
    <Description>A Night to Remember</Description>
    <Part Id="715515009058" UnitPrice="39.95" Quantity="2"/>
  </LineItem>
  <LineItem ItemNumber="2">
    <Description>The Unbearable Lightness Of Being</Description>
    <Part Id="37429140222" UnitPrice="29.95" Quantity="2"/>
  </LineItem>
  <LineItem ItemNumber="3">
    <Description>Sisters</Description>
    <Part Id="715515011020" UnitPrice="29.95" Quantity="4"/>
  </LineItem>
</LineItems>
</PurchaseOrder>

```

1 row selected.

3.6.3 Accessing Fragments or Nodes of an XML Document Using XMLQUERY

You can use SQL/XML function `XMLQuery` to extract the nodes that match an XQuery expression. The result is returned as an instance of `XMLType`.

[Example 3-19](#) (page 3-17) illustrates this with several queries.

See Also:

[Performing SQL Operations on XMLType Fragments Using XMLTABLE](#)
(page 3-22)

Example 3-19 Accessing XML Fragments Using XMLQUERY

The following query returns an `XMLType` instance containing the `Reference` element that matches the XPath expression.

```

SELECT XMLQuery('/PurchaseOrder/Reference' PASSING OBJECT_VALUE RETURNING CONTENT)
       FROM purchaseorder;

```

```

XMLQUERY('/PURCHASEORDER/REFERENCE' PASSINGOBJECT_
-----
<Reference>SBELL-2002100912333601PDT</Reference>

```

1 row selected.

The following query returns an `XMLType` instance containing the first `LineItem` element in the `LineItems` collection:

```

SELECT XMLQuery('/PurchaseOrder/LineItems/LineItem[1]'
               PASSING OBJECT_VALUE RETURNING CONTENT)
       FROM purchaseorder;

```

```

XMLQUERY('/PURCHASEORDER/LINEITEMS/LINEITEM[1]' PASSINGOBJECT_
-----
<LineItem ItemNumber="1">
  <Description>A Night to Remember</Description>
  <Part Id="715515009058" UnitPrice="39.95" Quantity="2"/>
</LineItem>

```

1 row selected.

The following query returns an XMLType instance that contains the three Description elements that match the XPath expression. These elements are returned as nodes in a single XMLType instance. The XMLType instance does not have a single root node; it is an XML *fragment*.

```
SELECT XMLQuery('/PurchaseOrder/LineItems/LineItem/Description'
              PASSING OBJECT_VALUE RETURNING CONTENT)
       FROM purchaseorder;

XMLQUERY('/PURCHASEORDER/LINEITEMS/LINEITEM/DESCRIPTION' PASSINGOBJECT_
-----)
<Description>A Night to Remember</Description>
<Description>The Unbearable Lightness Of Being</Description>
<Description>Sisters</Description>

1 row selected.
```

3.6.4 Accessing Text Nodes and Attribute Values Using XMLCAST and XMLQUERY

You can access text node and attribute values using SQL/XML standard functions XMLQuery and XMLCast.

To do this, the XQuery expression passed to XMLQuery must uniquely identify a *single* text node or attribute value within the document – that is, a *leaf* node. [Example 3-20](#) (page 3-18) illustrates this using several queries.

See Also:

[XQuery and Oracle XML DB](#) (page 4-1) for information on SQL/XML functions XMLQuery and XMLCast

Example 3-20 Accessing a Text Node Value Using XMLCAST and XMLQuery

The following query returns the value of the text node associated with the Reference element that matches the target XPath expression. The value is returned as a VARCHAR2 value.

```
SELECT XMLCast(XMLQuery('$p/PurchaseOrder/Reference/text()')
              PASSING OBJECT_VALUE AS "p" RETURNING CONTENT)
       AS VARCHAR2(30)
       FROM purchaseorder;

XMLCAST(XMLQUERY('$P/PURCHASEO
-----)
SBELL-2002100912333601PDT

1 row selected.
```

The following query returns the value of the text node associated with a Description element contained in a LineItem element. The particular LineItem element is specified by its Id attribute value. The predicate that identifies the LineItem element is [Part/@Id="715515011020"]. The at-sign character (@) specifies that Id is an attribute rather than an element. The value is returned as a VARCHAR2 value.

```
SELECT XMLCast(
      XMLQuery('$p/PurchaseOrder/LineItems/LineItem[Part/@Id="715515011020"]/Description/text()')
      PASSING OBJECT_VALUE AS "p" RETURNING CONTENT)
       AS VARCHAR2(30)
```

```

FROM purchaseorder;

XMLCAST(XMLQUERY('$P/PURCHASEO
-----
Sisters

1 row selected.

```

The following query returns the value of the text node associated with the `Description` element contained in the first `LineItem` element. The first `LineItem` element is indicated by the position predicate `[1]`.

```

SELECT XMLCast(XMLQuery('$p/PurchaseOrder/LineItems/LineItem[1]/Description'
      PASSING OBJECT_VALUE AS "p" RETURNING CONTENT)
      AS VARCHAR2(4000))
FROM purchaseorder;

XMLCAST(XMLQUERY('$P/PURCHASEORDER/LINEITEMS/LINEITEM[1]/DESCRIPTION' PASSINGOBJECT_VALUEAS"P"
-----
A Night to Remember

1 row selected.

```

3.6.5 Searching an XML Document Using `XMLEXISTS`, `XMLCAST`, and `XMLQUERY`

You can use SQL/XML standard functions `XMLEXISTS`, `XMLCAST`, and `XMLQUERY` in a SQL `WHERE` clause to limit query results.

SQL/XML standard function `XMLEXISTS` evaluates whether or not a given document contains a node that matches a W3C XPath expression. It returns a Boolean value of `true` if the document contains the node specified by the XPath expression supplied to the function and a value of `false` if it does not. Since XPath expressions can contain predicates, `XMLEXISTS` can determine whether or not a given node exists in the document, and whether or not a node with the specified value exists in the document.

Similarly, functions `XMLCAST` and `XMLQUERY` let you limit query results to documents that satisfy some property. [Example 3-21](#) (page 3-19) illustrates the use of `XMLEXISTS`, `XMLCAST`, and `XMLQUERY` to search for documents.

[Example 3-22](#) (page 3-22) performs a join based on the values of a node in an XML document and data in another, relational table.

See Also:

[XQuery and Oracle XML DB](#) (page 4-1) for information about SQL/XML functions `XMLQUERY`, `XMLEXISTS`, and `XMLCAST`

Example 3-21 Searching XML Content Using `XMLEXISTS`, `XMLCAST`, and `XMLQUERY`

The following query uses `XMLEXISTS` to check if the XML document contains an element named `Reference` that is a child of the root element `PurchaseOrder`:

```

SELECT count(*) FROM purchaseorder
      WHERE XMLEXISTS('$p/PurchaseOrder/Reference' PASSING OBJECT_VALUE AS "p");

COUNT(*)
-----
132

```

1 row selected.

The following query checks if the value of the text node associated with the Reference element is SBELL-2002100912333601PDT:

```
SELECT count(*) FROM purchaseorder
  WHERE XMLExists('$p/PurchaseOrder[Reference="SBELL-2002100912333601PDT"]'
    PASSING OBJECT_VALUE AS "p");

COUNT(*)
-----
1
1 row selected.
```

This query checks whether the XML document contains a root element PurchaseOrder that contains a LineItems element that contains a LineItem element that contains a Part element with an Id attribute.

```
SELECT count(*) FROM purchaseorder
  WHERE XMLExists('$p/PurchaseOrder/LineItems/LineItem/Part/@Id'
    PASSING OBJECT_VALUE AS "p");

COUNT(*)
-----
132
1 row selected.
```

The following query checks whether the XML document contains a root element PurchaseOrder that contains a LineItems element that contains a LineItem element that contains a Part element with Id attribute value 715515009058.

```
SELECT count(*) FROM purchaseorder
  WHERE XMLExists('$p/PurchaseOrder/LineItems/LineItem/Part[@Id="715515009058"]'
    PASSING OBJECT_VALUE AS "p");

COUNT(*)
-----
21
```

The following query checks whether the XML document contains a root element PurchaseOrder that contains a LineItems element whose *third* LineItem element contains a Part element with Id attribute value 715515009058.

```
SELECT count(*) FROM purchaseorder
  WHERE XMLExists(
    '$p/PurchaseOrder/LineItems/LineItem[3]/Part[@Id="715515009058"]'
    PASSING OBJECT_VALUE AS "p");

COUNT(*)
-----
1
1 row selected.
```

The following query limits the results of the SELECT statement to rows where the text node associated with element User starts with the letter S. XQuery does not include support for LIKE-based queries.

```
SELECT XMLCast(XMLQuery('$p/PurchaseOrder/Reference' PASSING OBJECT_VALUE AS "p"
  RETURNING CONTENT)
```

```

        AS VARCHAR2(30))
FROM purchaseorder
WHERE XMLCast(XMLQuery('$p/PurchaseOrder/User' PASSING OBJECT_VALUE AS "p"
        RETURNING CONTENT)
        AS VARCHAR2(30))
        LIKE 'S%';

XMLCAST(XMLQUERY('$P/PURCHASEORDER
-----
SBELL-20021009123336231PDT
SBELL-20021009123336331PDT
SKING-20021009123336321PDT
...
36 rows selected.

```

The following query uses `XMLExists` to limit the results of a `SELECT` statement to rows where the text node of element `User` contains the value `SBELL`.

```

SELECT XMLCast(XMLQuery('$p/PurchaseOrder/Reference' PASSING OBJECT_VALUE AS "p"
        RETURNING CONTENT)
        AS VARCHAR2(30)) "Reference"
FROM purchaseorder
WHERE XMLExists('$p/PurchaseOrder[User="SBELL"]' PASSING OBJECT_VALUE AS "p");

Reference
-----
SBELL-20021009123336231PDT
SBELL-20021009123336331PDT
SBELL-20021009123337353PDT
SBELL-20021009123338304PDT
SBELL-20021009123338505PDT
SBELL-20021009123335771PDT
SBELL-20021009123335280PDT
SBELL-2002100912333763PDT
SBELL-2002100912333601PDT
SBELL-20021009123336362PDT
SBELL-20021009123336532PDT
SBELL-20021009123338204PDT
SBELL-20021009123337673PDT

13 rows selected.

```

The following query uses `SQL/XML` functions `XMLQuery` and `XMLExists` to find the `Reference` element for any `PurchaseOrder` element whose first `LineItem` element contains an order for the item with `Id` 715515009058. Function `XMLExists` is used in the `WHERE` clause to determine which rows are selected, and `XMLQuery` is used in the `SELECT` list to control which part of the selected documents appears in the result.

```

SELECT XMLCast(XMLQuery('$p/PurchaseOrder/Reference' PASSING OBJECT_VALUE AS "p"
        RETURNING CONTENT)
        AS VARCHAR2(30)) "Reference"
FROM purchaseorder
WHERE XMLExists('$p/PurchaseOrder/LineItems/LineItem[1]/Part[@Id="715515009058"]'
        PASSING OBJECT_VALUE AS "p");

Reference
-----
SBELL-2002100912333601PDT

1 row selected.

```

Example 3-22 Joining Data from an XMLType Table and a Relational Table

```

SELECT XMLCast(XMLQuery('$p/PurchaseOrder/Reference' PASSING OBJECT_VALUE AS "p"
                      RETURNING CONTENT)
           AS VARCHAR2(30))
FROM purchaseorder p, hr.employees e
WHERE XMLCast(XMLQuery('$p/PurchaseOrder/User' PASSING OBJECT_VALUE AS "p"
                      RETURNING CONTENT)
           AS VARCHAR2(30)) = e.email
AND e.employee_id = 100;

```

```

XMLCAST(XMLQUERY('$P/PURCHASEOREDER
-----

```

```

SKING-20021009123336321PDT
SKING-20021009123337153PDT
SKING-20021009123335560PDT
SKING-20021009123336952PDT
SKING-20021009123336622PDT
SKING-20021009123336822PDT
SKING-20021009123336131PDT
SKING-20021009123336392PDT
SKING-20021009123337974PDT
SKING-20021009123338294PDT
SKING-20021009123337703PDT
SKING-20021009123337383PDT
SKING-20021009123337503PDT

```

13 rows selected.

3.6.6 Performing SQL Operations on XMLType Fragments Using XMLTABLE

You can use SQL/XML function `XMLTable` to perform SQL operations on a set of nodes that match an XQuery expression.

[Example 3-19](#) (page 3-17) demonstrates how to extract an XMLType instance that contains the node or nodes that match an XPath expression. When the document contains *multiple* nodes that match the supplied XPath expression, such a query returns an XML *fragment* that contains all of the matching nodes. Unlike an XML document, an XML **fragment** has no single element that is the *root* element.

This kind of result is common in these cases:

- When you retrieve the set of elements contained in a *collection*, in which case all nodes in the fragment are of the same type – see [Example 3-23](#) (page 3-23)
- When the target XPath expression ends in a *wildcard*, in which case the nodes in the fragment can be of different types – see [Example 3-25](#) (page 3-25)

You can use SQL/XML function `XMLTable` to break up an XML fragment contained in an XMLType instance, inserting the collection-element data into a new, virtual table, which you can then query using SQL — in a join expression, for example. In particular, converting an XML fragment into a virtual table makes it easier to process the result of evaluating an XQuery expression that returns multiple nodes.

See Also:

[XQuery and Oracle XML DB](#) (page 4-1) for more information about SQL/XML function `XMLTable`

[Example 3-23](#) (page 3-23) shows how to access the text nodes for each `Description` element in the `PurchaseOrder` document. It breaks up the single XML Fragment output from [Example 3-19](#) (page 3-17) into multiple text nodes.

[Example 3-24](#) (page 3-24) counts the number of elements in a collection. It also shows how SQL keywords such as `ORDER BY` and `GROUP BY` can be applied to the virtual table data created by SQL/XML function `XMLTable`.

[Example 3-25](#) (page 3-25) shows how to use SQL/XML function `XMLTable` to count the number of *child* elements of a given element. The XPath expression passed to `XMLTable` contains a wildcard (*) that matches all elements that are direct descendants of a `PurchaseOrder` element. Each row of the virtual table created by `XMLTable` contains a node that matches the XPath expression. Counting the number of rows in the virtual table provides the number of element children of element `PurchaseOrder`.

Example 3-23 Accessing Description Nodes Using XMLTABLE

```
SELECT des.COLUMN_VALUE
   FROM purchaseorder p,
        XMLTable('/PurchaseOrder/LineItems/LineItem/Description'
                 PASSING p.OBJECT_VALUE) des
   WHERE XMLElementExists('$p/PurchaseOrder[Reference="SBELL-2002100912333601PDT"]'
                          PASSING OBJECT_VALUE AS "p");
```

```
COLUMN_VALUE
-----
<Description>A Night to Remember</Description>
<Description>The Unbearable Lightness Of Being</Description>
<Description>Sisters</Description>
```

3 rows selected.

To use SQL to process the contents of the text nodes, the example converts the collection of `Description` nodes into a *virtual table*, using SQL/XML function `XMLTable`. The virtual table has three rows, each of which contains a single `XMLType` instance with a single `Description` element.

The XPath expression targets the `Description` elements. The `PASSING` clause says to use the contents (`OBJECT_VALUE`) of `XMLType` table `purchaseorder` as the context for evaluating the XPath expression.

The `XMLTable` expression thus *depends* on the `purchaseorder` table. This is a *left lateral join*. This correlated join ensures a one-to-many (1:N) relationship between the `purchaseorder` row accessed and the rows generated from it by `XMLTable`. Because of this correlated join, the `purchaseorder` table *must appear before* the `XMLTable` expression in the `FROM` list. This is a general requirement in any situation where the `PASSING` clause refers to a column of the table.

Each `XMLType` instance in the virtual table contains a single `Description` element. You can use the `COLUMNS` clause of `XMLTable` to break up the data targeted by the XPath expression '`Description`' into a column named `description` of SQL data type `VARCHAR2(256)`. The '`Description`' expression that defines this column is *relative* to the *context* XPath expression, '`/PurchaseOrder/LineItems/LineItem`'.

```
SELECT des.description
   FROM purchaseorder p,
        XMLTable('/PurchaseOrder/LineItems/LineItem' PASSING p.OBJECT_VALUE
                 COLUMNS description VARCHAR2(256) PATH 'Description') des
   WHERE XMLElementExists('$p/PurchaseOrder[Reference="SBELL-2002100912333601PDT"]');
```

```

        PASSING OBJECT_VALUE AS "p");

DESCRIPTION
-----
A Night to Remember
The Unbearable Lightness Of Being
Sisters
    
```

3 rows selected.

The COLUMNS clause lets you specify precise SQL data types, which can make static type-checking more helpful. This example uses only a single column (description). To expose data that is contained at multiple levels in an XMLType table as individual rows in a relational view, apply XMLTable to each document level to be broken up and stored in relational columns. See [Example 9-2](#) (page 9-3) for an example.

Example 3-24 Counting the Number of Elements in a Collection Using XMLTABLE

```

SELECT reference, count(*)
  FROM purchaseorder,
       XMLTable('/PurchaseOrder' PASSING OBJECT_VALUE
               COLUMNS reference VARCHAR2(32) PATH 'Reference',
                       lineitem XMLType      PATH 'LineItems/LineItem'),
       XMLTable('LineItem' PASSING lineitem)
 WHERE XMLEExists('$p/PurchaseOrder[User="SBELL"]'
                 PASSING OBJECT_VALUE AS "p")
    GROUP BY reference
    ORDER BY reference;
    
```

REFERENCE	COUNT(*)
SBELL-20021009123335280PDT	20
SBELL-20021009123335771PDT	21
SBELL-2002100912333601PDT	3
SBELL-20021009123336231PDT	25
SBELL-20021009123336331PDT	10
SBELL-20021009123336362PDT	15
SBELL-20021009123336532PDT	14
SBELL-20021009123337353PDT	10
SBELL-2002100912333763PDT	21
SBELL-20021009123337673PDT	10
SBELL-20021009123338204PDT	14
SBELL-20021009123338304PDT	24
SBELL-20021009123338505PDT	20

13 rows selected.

The query in this example locates the set of XML documents that match the XPath expression to SQL/XML function XMLEExists. It generates a virtual table with two columns:

- `reference`, containing the Reference node for each document selected
- `lineitem`, containing the set of LineItem nodes for each document selected

It counts the number of LineItem nodes for each document. A correlated join ensures that the GROUP BY correctly determines which LineItem elements belong to which PurchaseOrder element.

Example 3-25 Counting the Number of Child Elements in an Element Using XMLTABLE

```

SELECT count(*)
   FROM purchaseorder p, XMLTable('/PurchaseOrder/*' PASSING p.OBJECT_VALUE)
   WHERE XMLEExists('$p/PurchaseOrder[Reference="SBELL-2002100912333601PDT"]'
                    PASSING OBJECT_VALUE AS "p");

COUNT(*)
-----
          9

1 row selected.

```

3.7 Updating XML Content Stored in Oracle XML DB

You can update XML content, replacing either the entire contents of a document or only particular parts of a document.

The ability to perform partial updates on XML documents is very powerful, particularly when you make small changes to large documents, as it can significantly reduce the amount of network traffic and disk input-output required to perform the update.

You can make multiple changes to a document in a single operation. Each change uses an XQuery expression to identify a node to be updated, and specifies the new value for that node.

[Example 3-26](#) (page 3-25) updates the text node associated with element `User`.

[Example 3-27](#) (page 3-26) replaces an entire element within an XML document. The XQuery expression references the element, and the replacement value is passed as an `XMLType` object.

You can make multiple changes to a document in one statement. [Example 3-28](#) (page 3-27) changes the values of text nodes belonging to elements `CostCenter` and `SpecialInstructions` in a single SQL UPDATE statement.

Example 3-26 Updating a Text Node

```

SELECT XMLCast(XMLQuery('$p/PurchaseOrder/User' PASSING OBJECT_VALUE AS "p"
                        RETURNING CONTENT)
             AS VARCHAR2(60))
   FROM purchaseorder
   WHERE XMLEExists('$p/PurchaseOrder[Reference="SBELL-2002100912333601PDT"]'
                    PASSING OBJECT_VALUE AS "p");

XMLCAST(XMLQUERY('$P/PURCHAS
-----
SBELL

1 row selected.

UPDATE purchaseorder
SET OBJECT_VALUE =
   XMLQuery('copy $i := $p1 modify
            (for $j in $i/PurchaseOrder/User
             return replace value of node $j with $p2)
            return $i'
            PASSING OBJECT_VALUE AS "p1", 'SKING' AS "p2" RETURNING CONTENT)
   WHERE XMLEExists('$p/PurchaseOrder[Reference="SBELL-2002100912333601PDT"]'
                    PASSING OBJECT_VALUE AS "p");

```

1 row updated.

```
SELECT XMLCast(XMLQuery('$p/PurchaseOrder/User' PASSING OBJECT_VALUE AS "p"
                        RETURNING CONTENT)
              AS VARCHAR2(60))
FROM purchaseorder
WHERE XMLEExists('$p/PurchaseOrder[Reference="SBELL-2002100912333601PDT"]'
                PASSING OBJECT_VALUE AS "p");
```

```
XMLCAST(XMLQUERY('$P/PURCHAS
-----
SKING
```

1 row selected.

Example 3-27 Replacing an Entire Element Using XQuery Update

```
SELECT XMLQuery('$p/PurchaseOrder/LineItems/LineItem[1]'
                PASSING OBJECT_VALUE AS "p" RETURNING CONTENT)
FROM purchaseorder
WHERE XMLEExists('$p/PurchaseOrder[Reference="SBELL-2002100912333601PDT"]'
                PASSING OBJECT_VALUE AS "p");
```

```
XMLQUERY('$P/PURCHAS
-----
<LineItem ItemNumber="1">
  <Description>A Night to Remember</Description>
  <Part Id="715515009058" UnitPrice="39.95" Quantity="2"/>
</LineItem>
```

1 row selected.

```
UPDATE purchaseorder
SET OBJECT_VALUE =
  XMLQuery('copy $i := $p1 modify
            (for $j in $i/PurchaseOrder/LineItems/LineItem[1]
             return replace node $j with $p2)
            return $i'
          PASSING OBJECT_VALUE AS "p1",
          XMLType('<LineItem ItemNumber="1">
                  <Description>The Lady Vanishes</Description>
                  <Part Id="37429122129" UnitPrice="39.95"
                    Quantity="1"/>
                  </LineItem>') AS "p2"
          RETURNING CONTENT)
WHERE XMLEExists('$p/PurchaseOrder[Reference="SBELL-2002100912333601PDT"]'
                PASSING OBJECT_VALUE AS "p");
```

1 row updated.

```
SELECT XMLQuery('$p/PurchaseOrder/LineItems/LineItem[1]'
                PASSING OBJECT_VALUE AS "p" RETURNING CONTENT)
FROM purchaseorder
WHERE XMLEExists('$p/PurchaseOrder[Reference="SBELL-2002100912333601PDT"]'
                PASSING OBJECT_VALUE AS "p");
```

```
XMLQUERY('$P/PURCHAS
-----
<LineItem ItemNumber="1">
  <Description>The Lady Vanishes</Description>
  <Part Id="37429122129" UnitPrice="39.95" Quantity="1"/>
```

```
</LineItem>
```

```
1 row selected.
```

Example 3-28 Changing Text Node Values Using XQuery Update

```
SELECT XMLCast(XMLQuery('$p/PurchaseOrder/CostCenter'
    PASSING OBJECT_VALUE AS "p" RETURNING CONTENT)
    AS VARCHAR2(4)) "Cost Center",
    XMLCast(XMLQuery('$p/PurchaseOrder/SpecialInstructions'
    PASSING OBJECT_VALUE AS "p" RETURNING CONTENT)
    AS VARCHAR2(2048)) "Instructions"
FROM purchaseorder
WHERE XMLEExists('$p/PurchaseOrder[Reference="SBELL-2002100912333601PDT"]'
    PASSING OBJECT_VALUE AS "p");
```

```
Cost Center  Instructions
-----
S30          Air Mail
```

```
1 row selected.
```

```
UPDATE purchaseorder
SET OBJECT_VALUE =
    XMLQuery('copy $i := $p1 modify
    ((for $j in $i/PurchaseOrder/CostCenter
    return replace value of node $j with $p2)
    (for $j in $i/PurchaseOrder/SpecialInstructions
    return replace value of node $j with $p3))
    return $i'
    PASSING OBJECT_VALUE AS "p1",
    'B40' AS "p2",
    'Priority Overnight Service' AS "p3"
    RETURNING CONTENT)
WHERE XMLEExists('$p/PurchaseOrder[Reference="SBELL-2002100912333601PDT"]'
    PASSING OBJECT_VALUE AS "p");
```

```
1 row updated.
```

```
SELECT XMLCast(XMLQuery('$p/PurchaseOrder/CostCenter'
    PASSING OBJECT_VALUE AS "p" RETURNING CONTENT)
    AS VARCHAR2(4)) "Cost Center",
    XMLCast(XMLQuery('$p/PurchaseOrder/SpecialInstructions'
    PASSING OBJECT_VALUE AS "p" RETURNING CONTENT)
    AS VARCHAR2(2048)) "Instructions"
FROM purchaseorder
WHERE XMLEExists('$p/PurchaseOrder[Reference="SBELL-2002100912333601PDT"]'
    PASSING OBJECT_VALUE AS "p");
```

```
Cost Center  Instructions
-----
B40          Priority Overnight Service
```

```
1 row selected.
```

3.8 Generating XML Data from Relational Data

You can use Oracle XML DB to generate XML data from relational data.

See Also:

- [XQuery and Oracle XML DB](#) (page 4-1)
 - [Generation of XML Data from Relational Data](#) (page 8-1)
-

3.8.1 Generating XML Data from Relational Data Using SQL/XML Functions

You can use standard SQL/XML functions to generate one or more XML documents.

SQL/XML function `XMLQuery` is the most general way to do this. Other SQL/XML functions that you can use for this are the following:

- `XMLElement` creates a element
- `XMLAttributes` adds attributes to an element
- `XMLForest` creates forest of elements
- `XMLAgg` creates a single element from a collection of elements

The query in [Example 3-29](#) (page 3-29) uses these functions to generate an XML document that contains information from the tables `departments`, `locations`, `countries`, `employees`, and `jobs`.

This query generates element `Department` for each row in the `departments` table.

- Each `Department` element contains attribute `DepartmentID`. The value of `DepartmentID` comes from the `department_id` column. The `Department` element contains sub-elements `Name`, `Location`, and `EmployeeList`.
- The text node associated with the `Name` element comes from the `name` column in the `departments` table.
- The `Location` element has child elements `Address`, `City`, `State`, `Zip`, and `Country`. These elements are constructed by creating a forest of named elements from columns in the `locations` and `countries` tables. The values in the columns become the text node for the named element.
- The `EmployeeList` element contains an aggregation of `Employee` Elements. The content of the `EmployeeList` element is created by a subquery that returns the set of rows in the `employees` table that correspond to the current department. Each `Employee` element contains information about the employee. The contents of the elements and attributes for each `Employee` element is taken from tables `employees` and `jobs`.

The output generated by SQL/XML functions is generally *not* pretty-printed. The only exception is function `XMLSerialize` — use `XMLSerialize` to pretty-print. This lets the other SQL/XML functions (1) avoid creating a full DOM when generating the required output, and (2) reduce the size of the generated document. This lack of pretty-printing by most SQL/XML functions does not matter to most applications. However, it makes verifying the generated output manually more difficult.

You can also create and query an `XMLType` view that is built using the SQL/XML generation functions. [Example 3-30](#) (page 3-30) and [Example 3-31](#) (page 3-30) illustrate this. Such an `XMLType` view has the effect of persisting relational data as XML content. Rows in `XMLType` views can also be persisted as documents in Oracle XML DB Repository.

In [Example 3-31](#) (page 3-30), the XPath expression passed to SQL/XML function `XMLExists` restricts the query result set to the node that contains the `Executive` department information. The result is shown pretty-printed here for clarity.

Note:

XPath rewrite on XML expressions that operate on `XMLType` views is only supported when nodes referenced in the XPath expression are *not* descendants of an element created using SQL function `XMLAgg`.

Example 3-29 Generating XML Data Using SQL/XML Functions

```
SELECT XMLElement(
  "Department",
  XMLAttributes(d.Department_id AS "DepartmentId"),
  XMLForest(d.department_name AS "Name"),
  XMLElement(
    "Location",
    XMLForest(street_address AS "Address",
      city AS "City",
      state_province AS "State",
      postal_code AS "Zip",
      country_name AS "Country")),
  XMLElement(
    "EmployeeList",
    (SELECT XMLAgg(
      XMLElement(
        "Employee",
        XMLAttributes(e.employee_id AS "employeeNumber"),
        XMLForest(
          e.first_name AS "FirstName",
          e.last_name AS "LastName",
          e.email AS "EmailAddress",
          e.phone_number AS "PHONE_NUMBER",
          e.hire_date AS "StartDate",
          j.job_title AS "JobTitle",
          e.salary AS "Salary",
          m.first_name || ' ' || m.last_name AS "Manager"),
        XMLElement("Commission", e.commission_pct))
      FROM hr.employees e, hr.employees m, hr.jobs j
      WHERE e.department_id = d.department_id
      AND j.job_id = e.job_id
      AND m.employee_id = e.manager_id)))
  AS XML
FROM hr.departments d, hr.countries c, hr.locations l
WHERE department_name = 'Executive'
  AND d.location_id = l.location_id
  AND l.country_id = c.country_id;
```

The query returns the following XML:

```
XML
-----
<Department DepartmentId="90"><Name>Executive</Name><Location><Address>2004
Charade Rd</Address><City>Seattle</City><State>Washingto
n</State><Zip>98199</Zip><Country>United States of
America</Country></Location><EmployeeList><Employee
employeeNumber="101"><FirstNa
me>Neena</FirstName><LastName>Kochhar</LastName><EmailAddress>NKOCHHAR</EmailAdd
```

```

ess><PHONE_NUMBER>515.123.4568</PHONE_NUMBER><Start
Date>2005-09-21</StartDate><JobTitle>Administration Vice
President</JobTitle><Salary>17000</Salary><Manager>Steven King</Manager><Com
mission></Commission></Employee><Employee
employeeNumber="102"><FirstName>Lex</FirstName><LastName>De
Haan</LastName><EmailAddress>L
DEHAAN</EmailAddress><PHONE_NUMBER>515.123.4569</PHONE
NUMBER><StartDate>2001-01-13</StartDate><JobTitle>Administration Vice Presiden
t</JobTitle><Salary>17000</Salary><Manager>Steven
King</Manager><Commission></Commission></Employee></EmployeeList></Department>

```

Example 3-30 Creating XMLType Views Over Conventional Relational Tables

```

CREATE OR REPLACE VIEW department_xml OF XMLType
WITH OBJECT ID (substr(
    XMLCast(
        XMLQuery('$p/Department/Name'
            PASSING OBJECT_VALUE AS "p" RETURNING CONTENT)
        AS VARCHAR2(30)),
    1,
    128))
AS
SELECT XMLElement(
    "Department",
    XMLAttributes(d.department_id AS "DepartmentId"),
    XMLForest(d.department_name AS "Name"),
    XMLElement("Location", XMLForest(street_address AS "Address",
        city AS "City",
        state_province AS "State",
        postal_code AS "Zip",
        country_name AS "Country")),
    XMLElement(
        "EmployeeList",
        (SELECT XMLAgg(
            XMLElement(
                "Employee",
                XMLAttributes(e.employee_id AS "employeeNumber"),
                XMLForest(e.first_name AS "FirstName",
                    e.last_name AS "LastName",
                    e.email AS "EmailAddress",
                    e.phone_number AS "PHONE_NUMBER",
                    e.hire_date AS "StartDate",
                    j.job_title AS "JobTitle",
                    e.salary AS "Salary",
                    m.first_name || ' ' ||
                    m.last_name AS "Manager"),
                XMLElement("Commission", e.commission_pct)))
            FROM hr.employees e, hr.employees m, hr.jobs j
            WHERE e.department_id = d.department_id
            AND j.job_id = e.job_id
            AND m.employee_id = e.manager_id)).extract('/*')
        AS XML
    FROM hr.departments d, hr.countries c, hr.locations l
    WHERE d.location_id = l.location_id
        AND l.country_id = c.country_id;

```

Example 3-31 Querying XMLType Views

```

SELECT OBJECT_VALUE FROM department_xml
WHERE XMLElementExists('$p/Department[Name="Executive"]' PASSING OBJECT_VALUE AS "p");

OBJECT_VALUE

```

```

-----
<Department DepartmentId="90">
  <Name>Executive</Name>
  <Location>
    <Address>2004 Charade Rd</Address>
    <City>Seattle</City>
    <State>Washington</State>
    <Zip>98199</Zip>
    <Country>United States of America</Country>
  </Location>
  <EmployeeList>
    <Employee employeeNumber="101">
      <FirstName>Neena</FirstName>
      <LastName>Kochhar</LastName>
      <EmailAddress>NKOCHHAR</EmailAddress>
      <PHONE_NUMBER>515.123.4568</PHONE_NUMBER>
      <StartDate>2005-09-21</StartDate>
      <JobTitle>Administration Vice President</JobTitle>
      <Salary>17000</Salary>
      <Manager>Steven King</Manager>
      <Commission/>
    </Employee>
    <Employee employeeNumber="102">
      <FirstName>Lex</FirstName>
      <LastName>De Haan</LastName>
      <EmailAddress>LDEHAAN</EmailAddress>
      <PHONE_NUMBER>515.123.4569</PHONE_NUMBER>
      <StartDate>2001-01-13</StartDate>
      <JobTitle>Administration Vice President</JobTitle>
      <Salary>17000</Salary>
      <Manager>Steven King</Manager>
      <Commission/>
    </Employee>
  </EmployeeList>
</Department>

```

1 row selected.

As can be seen from the following execution plan output, Oracle XML DB is able to correctly rewrite the XPath-expression argument in the XMLExists expression into a SELECT statement on the underlying relational tables.

```

SELECT OBJECT_VALUE FROM department_xml
  WHERE XMLExists('$p/Department[Name="Executive"]' PASSING OBJECT_VALUE AS "p");

```

PLAN_TABLE_OUTPUT

Plan hash value: 2414180351

```

-----

```

Id	Operation	Name	Rows	Bytes	Cost (%CPU)	Time
0	SELECT STATEMENT		1	80	3 (0)	00:00:01
1	SORT AGGREGATE		1	115		
* 2	HASH JOIN		10	1150	7 (15)	00:00:01
* 3	HASH JOIN		10	960	5 (20)	00:00:01
4	TABLE ACCESS BY INDEX ROWID BATCHED	EMPLOYEES	10	690	2 (0)	00:00:01
* 5	INDEX RANGE SCAN	EMP_DEPARTMENT_IX	10		1 (0)	00:00:01
6	TABLE ACCESS FULL	JOBS	19	513	2 (0)	00:00:01
7	TABLE ACCESS FULL	EMPLOYEES	107	2033	2 (0)	00:00:01
8	NESTED LOOPS		1	80	3 (0)	00:00:01
9	NESTED LOOPS		1	68	3 (0)	00:00:01
* 10	TABLE ACCESS FULL	DEPARTMENTS	1	19	2 (0)	00:00:01
11	TABLE ACCESS BY INDEX ROWID	LOCATIONS	1	49	1 (0)	00:00:01

* 12	INDEX UNIQUE SCAN	LOC_ID_PK	1		0	(0)	00:00:01
* 13	INDEX UNIQUE SCAN	COUNTRY_C_ID_PK	1	12	0	(0)	00:00:01

Predicate Information (identified by operation id):

- 2 - access("M"."EMPLOYEE_ID"="E"."MANAGER_ID")
- 3 - access("J"."JOB_ID"="E"."JOB_ID")
- 5 - access("E"."DEPARTMENT_ID"=:B1)
- 10 - filter("D"."DEPARTMENT_NAME"='Executive')
- 12 - access("D"."LOCATION_ID"="L"."LOCATION_ID")
- 13 - access("L"."COUNTRY_ID"="C"."COUNTRY_ID")

30 rows selected.

3.8.2 Generating XML Data from Relational Data Using DBURITYPE

You can generate XML data from relational data using SQL function `DBURITYPE`.

Function `DBURITYPE` exposes one or more rows in a given table or view as a single XML document. The name of the root element is derived from the name of the table or view. The root element contains a set of `ROW` elements. There is one `ROW` element for each row in the table or view. The children of each `ROW` element are derived from the columns in the table or view. Each child element contains a text node with the value of the column for the given row.

[Example 3-32](#) (page 3-33) shows how to use SQL function `DBURITYPE` to access the contents of table `departments` in database schema `HR`. It uses method `getXML()` to return the resulting document as an `XMLType` instance.

[Example 3-33](#) (page 3-33) shows how to use an XPath predicate to restrict the rows that are included in an XML document generated using `DBURITYPE`. The XPath expression in the example restricts the XML document to `DEPARTMENT_ID` columns with value 10.

SQL function `DBURITYPE` provides a simple way to expose some or all rows in a relational table as one or more XML documents. The URL passed to function `DBURITYPE` can be extended to return a single column from the view or table, but in that case the URL must also include predicates that identify a single row in the target table or view.

[Example 3-34](#) (page 3-33) illustrates this. The predicate `[DEPARTMENT_ID="10"]` causes the query to return the value of column `department_name` for the `departments` row where column `department_id` has the value 10.

SQL function `DBURITYPE` is less flexible than the SQL/XML functions:

- It provides no way to control the shape of the generated document.
- The data can come only from a single table or view.
- The generated document consists of one or more `ROW` elements. Each `ROW` element contains a child for each column in the target table.
- The names of the child elements are derived from the column names.

To control the names of the XML elements, to include columns from more than one table, or to control which columns from a table appear in the generated document, create a relational view that exposes the desired set of columns as a single row, and then use function `DBURITYPE` to generate an XML document from the contents of that view.

Example 3-32 Generating XML Data from a Relational Table Using DBURITYPE and getXML()

```
SELECT DBURITYPE('/HR/DEPARTMENTS').getXML() FROM DUAL;
```

```
DBURITYPE('/HR/DEPARTMENTS').GETXML()
-----
<?xml version="1.0"?>
<DEPARTMENTS>
  <ROW>
    <DEPARTMENT_ID>10</DEPARTMENT_ID>
    <DEPARTMENT_NAME>Administration</DEPARTMENT_NAME>
    <MANAGER_ID>200</MANAGER_ID>
    <LOCATION_ID>1700</LOCATION_ID>
  </ROW>
  ...
  <ROW>
    <DEPARTMENT_ID>20</DEPARTMENT_ID>
    <DEPARTMENT_NAME>Marketing</DEPARTMENT_NAME>
    <MANAGER_ID>201</MANAGER_ID>
    <LOCATION_ID>1800</LOCATION_ID>
  </ROW>
</DEPARTMENTS>
```

Example 3-33 Restricting Rows Using an XPath Predicate

```
SELECT DBURITYPE('/HR/DEPARTMENTS/ROW[DEPARTMENT_ID="10"]').getXML()
       FROM DUAL;
```

```
DBURITYPE('/HR/DEPARTMENTS/ROW[DEPARTMENT_ID="10"]').GETXML()
-----
<?xml version="1.0"?>
<ROW>
  <DEPARTMENT_ID>10</DEPARTMENT_ID>
  <DEPARTMENT_NAME>Administration</DEPARTMENT_NAME>
  <MANAGER_ID>200</MANAGER_ID>
  <LOCATION_ID>1700</LOCATION_ID>
</ROW>
```

1 row selected.

Example 3-34 Restricting Rows and Columns Using an XPath Predicate

```
SELECT DBURITYPE(
       '/HR/DEPARTMENTS/ROW[DEPARTMENT_ID="10"]/DEPARTMENT_NAME').getXML()
       FROM DUAL;
```

```
DBURITYPE('/HR/DEPARTMENTS/ROW[DEPARTMENT_ID="10"]/DEPARTMENT_NAME').GETXML()
-----
<?xml version="1.0"?>
  <DEPARTMENT_NAME>Administration</DEPARTMENT_NAME>
```

1 row selected.

3.9 Character Sets of XML Documents

There are a few ways in which Oracle XML DB determines which character sets are used for XML documents

Caution:

AL32UTF8 is the Oracle Database character set that is appropriate for `XMLType` data. It is equivalent to the IANA registered standard UTF-8 encoding, which supports all valid XML characters.

Do not confuse Oracle Database database character set UTF8 (no hyphen) with database character set AL32UTF8 or with character *encoding* UTF-8. Database character set UTF8 has been *superseded* by AL32UTF8. Do *not* use UTF8 for XML data. Character set UTF8 supports only Unicode version 3.1 and earlier. It does not support all valid XML characters. AL32UTF8 has no such limitation.

Using database character set UTF8 for XML data could potentially *stop a system or affect security negatively*. If a character that is not supported by the database character set appears in an input-document element name, a replacement character (usually "?") is substituted for it. This terminates parsing and raises an exception. It can cause an irrecoverable error.

3.9.1 XML Encoding Declaration

You can use an XML encoding declaration to explicitly specify the character encoding to use for a given XML entity.

Each XML document is composed of units called entities. Each entity in an XML document can use a different encoding for its characters. Entities that are stored in an encoding other than UTF-8 or UTF-16 must begin with an XML declaration containing an encoding specification indicating the character encoding in use. For example:

```
<?xml version='1.0' encoding='EUC-JP' ?>
```

Entities encoded in UTF-16 must begin with the Byte Order Mark (BOM), as described in Appendix F of the XML 1.0 Reference. For example, on big-endian platforms, the BOM required of a UTF-16 data stream is `#xFEFF`.

In the absence of both the encoding declaration and the BOM, the XML entity is assumed to be encoded in UTF-8. Because ASCII is a subset of UTF-8, ASCII entities do not require an encoding declaration.

In many cases, external sources of information are available, besides the XML data, to provide the character encoding in use. For example, the encoding of the data can be obtained from the `charset` parameter of the `Content-Type` field in an HTTP(S) request as follows:

```
Content-Type: text/xml; charset=ISO-8859-4
```

3.9.2 Character-Set Determination When Loading XML Documents into the Database

Except for XML data obtained from a CLOB or VARCHAR value, character encoding is determined by an encoding declaration when a document is loaded into the database.

For XML data obtained from a CLOB or VARCHAR value, any encoding declaration present is *ignored*, because these two data types are *always encoded in the database character set*.

In addition, when loading data into Oracle XML DB, either through programmatic APIs or transfer protocols, you can provide external encoding to override the document encoding declaration. An error is raised if you try to load a schema-based XML document that contains characters that are not legal in the determined encoding.

The following examples show different ways to specify external encoding:

- Using PL/SQL function `DBMS_XDB_REPOS.createResource` to create a file resource from a `BFILE`, you can specify the file encoding with the `CSID` argument. If a zero `CSID` is specified then the file encoding is auto-detected from the document encoding declaration.

```
CREATE DIRECTORY xmldir AS '/private/xmldir';
CREATE OR REPLACE PROCEDURE loadXML(filename VARCHAR2, file_csid NUMBER) IS
  xbfile BFILE;
  RET    BOOLEAN;
BEGIN
  xbfile := bfilename('XMLDIR', filename);
  ret := DBMS_XDB_REPOS.createResource('/public/mypurchaseorder.xml',
                                       xbfile,
                                       file_csid);
END;
```

- Use the FTP protocol to load documents into Oracle XML DB. Use the `quote set_charset FTP` command to indicate the encoding of the files to be loaded.

```
ftp> quote set_charset Shift_JIS
ftp> put mypurchaseorder.xml
```

- Use the HTTP(S) protocol to load documents into Oracle XML DB. Specify the encoding of the data to be transmitted to Oracle XML DB in the request header.

```
Content-Type: text/xml; charset= EUC-JP
```

3.9.3 Character-Set Determination When Retrieving XML Documents from the Database

Except for XML data stored in a `CLOB` or `VARCHAR` value, you can specify the encoding to be used when it is retrieved from Oracle XML DB using a SQL client, programmatic APIs, or transfer protocols.

When XML data is stored as a `CLOB` or `VARCHAR2` value, the encoding declaration, if present, is always *ignored* for retrieval, just as for storage. The encoding of a retrieved document can thus be different from the encoding explicitly declared in that document.

The character set for an XML document retrieved from the database is determined in the following ways:

- SQL client – If a SQL client (such as SQL*Plus) is used to retrieve XML data, then the character set is determined by the client-side environment variable `NLS_LANG`. In particular, this setting overrides any explicit character-set declarations in the XML data itself.

For example, if you set the client side `NLS_LANG` variable to `AMERICAN_AMERICA.AL32UTF8` and then retrieve an XML document with encoding `EUC_JP` provided by declaration `<?xml version="1.0" encoding="EUC-JP" ?>`, the character set of the retrieved document is `AL32UTF8`, *not* `EUC_JP`.

See Also:

Oracle Database Globalization Support Guide for information about `NLS_LANG`

- PL/SQL and APIs – Using PL/SQL or programmatic APIs, you can retrieve XML data into VARCHAR, CLOB, or XMLType data types. As for SQL clients, you can control the encoding of the retrieved data by setting NLS_LANG.

You can also retrieve XML data into a BLOB value using XMLType and URIType methods. These let you specify the character set of the returned BLOB value. Here is an example:

```
CREATE OR REPLACE FUNCTION getXML(pathname VARCHAR2, charset VARCHAR2)
  RETURN BLOB IS
  xblob BLOB;
BEGIN
  SELECT XMLSERIALIZE(DOCUMENT e.RES AS BLOB ENCODING charset) INTO xblob
    FROM RESOURCE_VIEW e WHERE equals_path(e.RES, pathname) = 1;
  RETURN xblob;
END;
/
```

- FTP – You can use the FTP quote set_nls_locale command to set the character set:

```
ftp> quote set_nls_locale EUC-JP
ftp> get mypurchaseorder.xml
```

See Also:

[FTP Quote Methods](#) (page 28-13)

- HTTP(S) – You can use the Accept-Charset parameter in an HTTP(S) request:

```
/httpstest/mypurchaseorder.xml 1.1 HTTP/Host: localhost:2345
Accept: text/*
Accept-Charset: iso-8859-1, utf-8
```

See Also:

[Character Sets for HTTP\(S\)](#) (page 28-26)

Part II

Manipulation of XML Data in Oracle XML DB

The following are covered here: XQuery, XMLType operations, and indexing of XML data.

- [XQuery and Oracle XML DB](#) (page 4-1)
- [Query and Update of XML Data](#) (page 5-1)
- [Indexes for XMLType Data](#) (page 6-1)
- [Transformation and Validation of XMLType Data](#) (page 7-1)

XQuery and Oracle XML DB

The XQuery language is one of the main ways that you interact with XML data in Oracle XML DB. Support for the language includes SQL*Plus command `XQUERY` and SQL/XML functions `XMLQuery`, `XMLTable`, `XMlexists`, and `XMLCast`.

- [Overview of the XQuery Language](#) (page 4-1)
- [Overview of XQuery in Oracle XML DB](#) (page 4-8)
- [SQL/XML Functions XMLQUERY, XMLTABLE, XMlexists, and XMLCast](#) (page 4-9)
- [URI Scheme oradb: Querying Table or View Data with XQuery](#) (page 4-18)
- [Oracle XQuery Extension Functions](#) (page 4-20)
- [Oracle XQuery Extension-Expression Pragmas](#) (page 4-22)
- [XQuery Static Type-Checking in Oracle XML DB](#) (page 4-25)
- [Oracle XML DB Support for XQuery](#) (page 4-26)

4.1 Overview of the XQuery Language

XQuery is the W3C language designed for querying and updating XML data.

Oracle XML DB supports the following W3C XQuery standards:

- XQuery 1.0 Recommendation
- XQuery Update Facility 1.0 Recommendation
- XQuery and XPath Full Text 1.0 Recommendation

This section presents an overview of the XQuery language. For more information, consult a recent book on the language or refer to the standards documents that define it, all of which are available at <http://www.w3c.org/>.

4.1.1 XPath Expressions Are XQuery Expressions

The XPath language is a W3C Recommendation for navigating XML documents. It is a subset of the XQuery language: an XPath expression is also an XQuery expression.

XPath models an XML document as a tree of nodes. It provides a set of operations that walk this tree and apply predicates and node-test functions. Applying an XPath expression to an XML document results in a set of nodes. For example, the expression `/PO/PONO` selects all PONO child elements under the PO root element of a document.

[Table 4-1](#) (page 4-2) lists some common constructs used in XPath.

Table 4-1 Common XPath Constructs

XPath Construct	Description
/	Denotes the root of the tree in an XPath expression. For example, /PO refers to the child of the root node whose name is PO.
/	Used as a path separator to identify the child element nodes of a given element node. For example, /PurchaseOrder/Reference identifies Reference elements that are children of PurchaseOrder elements that are children of the root element.
//	Used to identify all descendants of the current node. For example, PurchaseOrder//ShippingInstructions matches any ShippingInstructions element under the PurchaseOrder element.
*	Used as a wildcard to match any child node. For example, /PO/*/STREET matches any street element that is a grandchild of the PO element.
[]	Used to denote predicate expressions. XPath supports a rich list of binary operators such as or, and, and not. For example, /PO[PONO = 20 and PNAME = "PO_2"]/SHIPADDR selects the shipping address element of all purchase orders whose purchase-order number is 20 and whose purchase-order name is PO_2. Brackets are also used to denote a position (index). For example, /PO/PONO[2] identifies the second purchase-order number element under the PO root element.
Functions	XPath and XQuery support a set of built-in functions such as substring, round, and not. In addition, these languages provide for extension functions through the use of namespaces. Oracle XQuery extension functions use the namespace prefix ora, for namespace http://xmlns.oracle.com/xdb . See Oracle XQuery Extension Functions (page 4-20).

An XPath expression must identify a single node or a set of element, text, or attribute nodes. The result of evaluating an XPath expression is never a Boolean expression.

You can select XMLType data using PL/SQL, C, or Java. You can also use XMLType method `getNumberVal()` to retrieve XML data as a NUMBER value.

Note:

Oracle SQL functions and XMLType methods respect the W3C XPath recommendation, which states that if an XPath expression targets *no nodes* when applied to XML data, then an empty sequence must be returned. An error must *not* be raised in this case.

4.1.2 XQuery: A Functional Language Based on Sequences

XQuery is similar to SQL in many ways, but just as SQL is designed for querying structured, relational data, XQuery is designed especially for querying semi-structured, XML data from a variety of data sources.

You can use XQuery to query XML data wherever it is found, whether it is stored in database tables, available through Web Services, or otherwise created on the fly. In addition to querying XML data, XQuery can be used to *construct* XML data. In this regard, XQuery can serve as an alternative or a complement to both XSLT and the other SQL/XML publishing functions, such as XMLElement.

XQuery builds on the Post-Schema-Validation Infoset (PSVI) data model, which unites the XML Information Set (Infoset) data model and the XML Schema type system. XQuery defines a new data model, the **XQuery Data Model (XDM)**, which is based on *sequences*. Another name for an XQuery sequence is an **XDM instance**.

4.1.2.1 XQuery Is About Sequences

XQuery is all about manipulating sequences. This makes XQuery similar to a set-manipulation language, except that sequences are ordered and can contain duplicate items. XQuery sequences differ from the sequences in some other languages in that nested XQuery sequences are always *flattened* in their effect.

In many cases, sequences can be treated as unordered, to maximize optimization – where this is available, it is under your control. This **unordered mode** can be applied to join order in the treatment of nested iterations (`for`), and it can be applied to the treatment of XPath expressions (for example, in `/a/b`, the matching `b` elements can be processed without regard to document order).

An XQuery **sequence** consists of zero or more **items**, which can be either *atomic* (scalar) values or XML *nodes*. Items are typed using a rich type system that is based upon the types of XML Schema. This type system is a major change from that of XPath 1.0, which is limited to simple scalar types such as Boolean, number, and string.

4.1.2.2 XQuery Is Referentially Transparent

XQuery is a *functional* language. As such, it consists of a set of possible *expressions* that are *evaluated* and whose evaluation returns *values* (results).

The result of evaluating an XQuery expression has two parts, at least one of which is empty: (a) a sequence (an XDM instance) and (b) a **pending update list**. Informally, the sequence is sometimes spoken of as the expression value, especially when the pending update list is empty, meaning that no data updates are involved.

As a functional language, XQuery is also **referentially transparent**. This means that the *same expression* evaluated in the *same context* returns the *same value*.

Exceptions to this desirable mathematical property include the following:

- XQuery expressions that derive their value from interaction with the external environment. For example, an expression such as `fn:current-time(...)` or `fn:doc(...)` does not necessarily always return the same value, since it depends on external conditions that can change (the time changes; the content of the target document might change).

In some cases, like that of `fn:doc`, XQuery is defined to be referentially transparent within the execution of a single query: within a query, each invocation of `fn:doc` with the same argument results in the same document.

- XQuery expressions that are defined to be dependent on the particular XQuery language implementation. The result of evaluating such expressions might vary between implementations. Function `fn:doc` is an example of a function that is essentially implementation-defined.

XQuery Update is not in the list; it does *not* present an exception to referential transparency. See [XQuery Update Has Side Effects on Your Data](#) (page 4-4).

Referential transparency applies also to XQuery *variables*: the same variable in the same context has the same value. Functional languages are like mathematics formalisms in this respect and unlike procedural, or imperative, programming languages. A variable in a procedural language is really a name for a memory location;

it has a *current* value, or state, as represented by its content at any time. A variable in a declarative language such as XQuery is really a name for a *static* value.

4.1.2.3 XQuery Update Has Side Effects on Your Data

Referential transparency applies to the evaluation of XQuery expressions. It does not imply that this evaluation never has a *side effect* on your *data*. In particular, you use XQuery Update to modify your data. That modification is a side effect of evaluating an XQuery updating expression.

The side effect is one thing; the expression value is another. The value returned from evaluation includes the pending update list that describes the updates to carry out. For a given XQuery expression, this description is the same regardless of the context in which evaluation occurs (with the above-mentioned exceptions).

The XQuery Update standard defines how the XDM instances of your data are updated. How those updates are propagated to persistent data stores (for example `XMLType` tables and columns) is implementation-dependent.

4.1.2.4 XQuery Update Snapshots

An XQuery expression (query) can call for more than one update operation. XQuery Update performs all such operations for the same query as an *atomic* operation: either they all succeed or none of them do (if an error is raised).

The unit of change is thus an entire XQuery query. To effect this atomic update behavior, before evaluating your query XQuery Update takes a **snapshot** of the data (XDM instances) whose modification is called for by the query. It also adds the update operations called for by the query to the pending update list. The snapshot is an evaluation context for an XDM instance that is the update target.

As the last step of XQuery expression evaluation, the pending update list is processed, applying the indicated update operations in an atomic fashion, and terminating the snapshot.

The atomic nature of snapshot semantics means that a set of update operations used in a given query are not necessarily applied in the order written. In fact, the order of applying update operations is fixed and specified by the XQuery Update Feature standard.

This means that *an update operation does not see the result of any other update operation for the same query*. There is no notion of an intermediate or interim update state – all updates for a query are applied together, atomically.

4.1.2.4.1 Oracle XML Update Functions (Deprecated) Do Not Use Snapshot Semantics

The deprecated Oracle SQL functions for updating XML data do *not* use snapshot semantics. This means that if an expression has multiple such function calls they are processed in applicative order (innermost first), and the result of applying one such function is seen by the updating functions applied after it.

This is an important behavior difference between the Oracle updating functions (`updateXML` and so on) and XQuery Update functions. Besides the semantic difference, there is also a performance difference: in general, the atomic updating of XQuery Update performs better than the incremental updating of the Oracle-specific functions.

4.1.2.5 XQuery Full Text Provides Full-Text Search

The XQuery and XPath Full Text 1.0 Recommendation (XQuery Full Text) defines XQuery support for full-text searches in queries. It defines full-text selection operators

that perform the search and return instances of the AllMatches model, which complements the XQuery Data Model (XDM).

An AllMatches instance describes all possible solutions to a full-text query for a given search context item. Each solution is described by a Match instance, which contains the search-context tokens (StringInclude instances) that must be included and those (StringExclude instances) that must be excluded.

In short, XQuery Full Text adds a full-text contains expression to the XQuery language. You use such an expression in your query to search the text of element nodes and their descendent elements (you can also search the text of attribute nodes).

4.1.3 XQuery Expressions

XQuery expressions are case-sensitive. An XQuery expression is either a *simple* expression or an *updating* expression, the latter being an expression that represents data modification. More precisely, these are the possible XQuery expressions:

- **Basic updating expression** – an insert, delete, replace, or rename expression, or a call to an *updating function* (see the XQuery Update Facility 1.0 Recommendation).
- **Updating expression** – a basic updating expression or an expression (other than a transform expression) that contains another updating expression (this is a recursive definition).
- **Simple expression** – An XQuery 1.0 expression. It does not call for any updating.

The pending update list that results from evaluating a simple expression is empty. The sequence value that results from evaluating an updating expression is empty.

Simple expressions include the following:

- **Primary expression** – literal, variable, or function application. A variable name starts with a dollar-sign (\$) – for example, \$foo. Literals include numerals, strings, and character or entity references.
- **XPath expression** – Any XPath expression. The XPath 2.0 standard is a subset of XQuery.
- **FLWOR expression** – The most important XQuery expression, composed of the following, in order, from which FLWOR takes its name: *for*, *let*, *where*, *order by*, *return*.
- **XQuery sequence** – The comma (,) constructor creates sequences. Sequence-manipulating functions such as *union* and *intersect* are also available. All XQuery sequences are effectively **flat**: a nested sequence is treated as its flattened equivalent. Thus, for instance, (1, 2, (3, 4, (5), 6), 7) is treated as (1, 2, 3, 4, 5, 6, 7). A singleton sequence, such as (42), acts the same in most XQuery contexts as does its single item, 42. Remember that the result of any XQuery expression is a sequence.
- **Direct (literal) constructions** – XML element and attribute syntax automatically constructs elements and attributes: what you see is what you get. For example, the XQuery expression <a>33 constructs the XML element <a>33.
- **Computed (dynamic) constructions** – You can construct XML data at run time using computed values. For example, the following XQuery expression constructs this XML data: <foo toto="5"><bar>tata titi</bar> why? </foo>.

```
<foo>attribute toto {2+3},
  element bar {"tata", "titi"},
  text {" why? "}</foo>
```

In this example, element `foo` is a direct construction; the other constructions are computed. In practice, the arguments to computed constructors are not literals (such as `toto` and `"tata"`), but expressions to be evaluated (such as `2+3`). Both the name and the value arguments of an element or attribute constructor can be computed. Braces (`{, }`) are used to mark off an XQuery expression to be evaluated.

- **Conditional expression** – As usual, but remember that each part of the expression is itself an arbitrary expression. For instance, in this conditional expression, each of these subexpressions can be any XQuery expression: `something`, `somethingElse`, `expression1`, and `expression2`.

```
if (something < somethingElse) then expression1 else expression2
```

- **Arithmetic, relational expression** – As usual, but remember that each relational expression returns a (Boolean¹¹) value. Examples:

```
2 + 3
42 < $a + 5
(1, 4) = (1, 2)
5 > 3 eq true()
```

- **Quantifier expression** – Universal (every) and existential (some) quantifier functions provide shortcuts to using a FLWOR expression in some cases. Examples:

```
every $foo in doc("bar.xml")//Whatever satisfies $foo/@bar > 42
some $toto in (42, 5), $titi in (123, 29, 5) satisfies $toto = $titi
```

- **Regular expression** – XQuery regular expressions are based on XML Schema 1.0 and Perl. (See [Support for XQuery Functions and Operators](#) (page 4-28).)

- **Type expression** – An XQuery expression that represents an XQuery type. Examples: `item()`, `node()`, `attribute()`, `element()`, `document-node()`, `namespace()`, `text()`, `xs:integer`, `xs:string`.²²

Type expressions can have **occurrence indicators**: `?` (optional: zero or one), `*` (zero or more), `+` (one or more). Examples: `document-node(element()*), item()+, attribute()?`.

XQuery also provides operators for working with types. These include `cast as`, `castable as`, `treat as`, `instance of`, `typeswitch`, and `validate`. For example, `"42" cast as xs:integer` is an expression whose value is the integer 42. (It is not, strictly speaking, a type expression, because its value does not represent a type.)

- **Full-text contains expression** – An XQuery expression that represents a full-text search. This expression is provided by the XQuery and XPath Full Text 1.0 Recommendation. A full-text contains expression (FTContainsExpr) supported by Oracle has these parts: a **search context** that specifies the items to search, and a **full-text selection** that filters those items, selecting matches.

The selection part is itself composed of the following:

¹ The value returned is a sequence, as always. However, in XQuery, a sequence of one item is equivalent to that item itself. In this case, the single item is a Boolean value.

² Namespace prefix `xs` is predefined for the XML Schema namespace, <http://www.w3.org/2001/XMLSchema>.

- **Tokens and phrases** used for matching.
- Optional **match options**, such as the use of stemming.
- Optional **Boolean operators** for combining full-text selections.
- Optional constraint operators, such as **positional filters** (e.g. ordered window).

See [Support for XQuery Full Text](#) (page 4-28).

4.1.4 FLWOR Expressions

Just as for XQuery in general, there is a lot to learn about FLWOR expressions in particular. This section provides a brief overview.

FLWOR is the most general expression syntax in XQuery. FLWOR (pronounced "flower") stands for *for*, *let*, *where*, *order by*, and *return*. A FLWOR expression has at least one *for* or *let* clause and a *return* clause; single *where* and *order by* clauses are optional. Only the *return* clause can contain an updating expression; the other clauses cannot.

- **for** – Bind one or more variables each to any number of values, in turn. That is, for each variable, iterate, binding the variable to a different value for each iteration.

At each iteration, the variables are bound in the order they appear, so that the value of a variable `$earlier` that is listed before a variable `$later` in the *for* list, can be used in the binding of variable `$later`. For example, during its second iteration, this expression binds `$i` to 4 and `$j` to 6 (2+4):

```
for $i in (3, 4), $j in ($i, 2+$i)
```

- **let** – Bind one or more variables.

Just as with *for*, a variable can be bound by *let* to a value computed using another variable that is listed previously in the binding list of the *let* (or an enclosing *for* or *let*). For example, this expression binds `$j` to 5 (3+2):

```
let $i := 3, $j := $i + 2
```

- **where** – Filter the *for* and *let* variable bindings according to some condition. This is similar to a SQL `WHERE` clause.
- **order by** – Sort the result of *where* filtering.

- **return** – Construct a result from the ordered, filtered values. This is the result of the FLWOR expression as a whole. It is a flattened sequence.

If the *return* clause contains an updating expression then that expression is evaluated for each tuple generated by the other clauses. The pending update lists from these evaluations are then merged as the result of the FLWOR expression.

Expressions *for* and *let* act similarly to a SQL `FROM` clause. Expression *where* acts like a SQL `WHERE` clause. Expression *order by* is similar to `ORDER BY` in SQL. Expression *return* is like `SELECT` in SQL. Except for the two keywords whose names are the same in both languages (*where*, *order by*), FLWOR clause *order* is more or less opposite to the SQL clause *order*, but the meanings of the corresponding clauses are quite similar.

Using a FLWOR expression (with *order by*) is the *only* way to construct an XQuery sequence in any order other than document order.

4.2 Overview of XQuery in Oracle XML DB

Oracle XML DB support for the XQuery language is provided through a native implementation of SQL/XML functions `XMLQuery`, `XMLTable`, `XMLExists`, and `XMLCast`. As a convenience, SQL*Plus command `XQUERY` is also provided, which lets you enter XQuery expressions directly — in effect, this command turns SQL*Plus into an XQuery command-line interpreter.

Oracle XML DB compiles XQuery expressions that are passed as arguments to SQL/XML functions `XMLQuery`, `XMLTable`, `XMLExists`, and `XMLCast`. This compilation produces SQL query blocks and operator trees that use SQL/XML functions and XPath functions. A SQL statement that includes `XMLQuery`, `XMLTable`, `XMLExists`, or `XMLCast` is compiled and optimized as a whole, leveraging both relational database and XQuery-specific optimization technologies. Depending on the XML storage and indexing methods used, XPath functions can be further optimized. The resulting optimized operator tree is executed in a streaming fashion.

Note:

Oracle XML Developer's Kit (XDK) supports XQuery on the mid-tier. You do not need access to Oracle Database to use XQuery. XDK lets you evaluate XQuery expressions using XQuery API for Java (XQJ).

See Also:

- [SQL/XML Functions XMLQUERY, XMLTABLE, XMLExists, and XMLCast](#) (page 4-9) and [Using the SQL*Plus XQUERY Command](#) (page 5-22)
 - [Oracle XQuery Extension Functions](#) (page 4-20) for Oracle-specific XQuery functions that extend the language
 - [Oracle XML DB Support for XQuery](#) (page 4-26) for details about Oracle XML DB support for XQuery
 - [Query and Update of XML Data](#) (page 5-1)
 - *Oracle XML Developer's Kit Programmer's Guide* for information about using XQJ
-
-

4.2.1 When To Use XQuery

You can use XQuery to do many of the same things that you might do using the SQL/XML generation functions or XSLT; there is a great deal of overlap. The decision to use one or the other tool to accomplish a given task can be based on many considerations, most of which are not specific to Oracle Database. Please consult external documentation on this general question.

A general pattern of use is that XQuery is often used when the focus is the world of XML data, and the SQL/XML generation functions (`XMLElement`, `XMLAgg`, and so on) are often used when the focus is the world of relational data.

Other things being equal, if a query constructs an XML document from fragments extracted from existing XML documents, then it is likely that an XQuery FLOWR expression is simpler (simplifying code maintenance) than extracting scalar values

from relational data and constructing appropriate XML data using SQL/XML generation functions. If, instead, a query constructs an XML document from existing relational data, the SQL/XML generation functions can often be more suitable.

With respect to Oracle XML DB, you can expect the same general level of performance using the SQL/XML generation functions as with `XMLQuery` and `XMLTable` — all are subject to rewrite optimizations.

4.2.2 Predefined XQuery Namespaces and Prefixes

Several namespaces and prefixes are predefined for use with XQuery in Oracle XML DB.

Table 4-2 Predefined Namespaces and Prefixes

Prefix	Namespace	Description
ora	<code>http://xmlns.oracle.com/xdb</code>	Oracle XML DB namespace
locaxml	<code>http://www.w3.org/2003/11/xpath-local-functions</code>	XPath local function declaration namespace
fn	<code>http://www.w3.org/2003/11/xpath-functions</code>	XPath function namespace
xml	<code>http://www.w3.org/XML/1998/namespace</code>	XML namespace
xs	<code>http://www.w3.org/2001/XMLSchema</code>	XML Schema namespace
xsi	<code>http://www.w3.org/2001/XMLSchema-instance</code>	XML Schema instance namespace

You can use these prefixes in XQuery expressions without first declaring them in the XQuery-expression prolog. You can redefine any of them *except* `xml` in the prolog. All of these prefixes except `ora` are predefined in the XQuery standard.

4.3 SQL/XML Functions XMLQUERY, XMLTABLE, XMlexists, and XMLCast

SQL/XML functions `XMLQuery`, `XMLTable`, `XMlexists`, and `XMLCast` are defined by the SQL/XML standard as a general interface between the SQL and XQuery languages.

They are referred to in this book as SQL/XML *query and update* functions. As is the case for the other SQL/XML functions, these functions let you take advantage of the power and flexibility of both SQL and XML. Using these functions, you can construct XML data using relational data, query relational data as if it were XML, and construct relational data from XML data.

SQL functions `XMlexists` and `XMLCast` are documented elsewhere in this chapter. This section presents functions `XMLQuery` and `XMLTable`, but many of the examples in this chapter use also `XMlexists` and `XMLCast`. In terms of typical use:

- `XMLQuery` and `XMLCast` are typically used in a `SELECT` list.
- `XMLTable` is typically used in a `SQL FROM` clause.
- `XMlexists` is typically used in a `SQL WHERE` clause.

Both `XMLQuery` and `XMLTable` evaluate an XQuery expression. In the XQuery language, an expression always returns a sequence of items. Function `XMLQuery`

aggregates the items in this sequence to return a single XML document or fragment. Function `XMLTABLE` returns a SQL table whose rows each contain one item from the XQuery sequence.

See Also:

- *Oracle Database SQL Language Reference* for information about Oracle support for the SQL/XML standard
 - <http://www.w3.org/> for information about the XQuery language
 - [Generation of XML Data Using SQL Functions](#) (page 8-2) for information about using other SQL/XML functions with Oracle XML DB
-
-

4.3.1 XMLQUERY SQL/XML Function in Oracle XML DB

Use SQL/XML function `XMLQuery` to construct or query XML data.

The function takes as arguments an *XQuery expression*, as a string literal, and an optional *XQuery context item*, as a SQL expression. The context item establishes the XPath context in which the XQuery expression is evaluated. Additionally, `XMLQuery` accepts as arguments any number of SQL expressions whose values are bound to XQuery variables during the XQuery expression evaluation.

The function returns the result of evaluating the XQuery expression, as an `XMLType` instance.

Figure 4-1 XMLQUERY Syntax

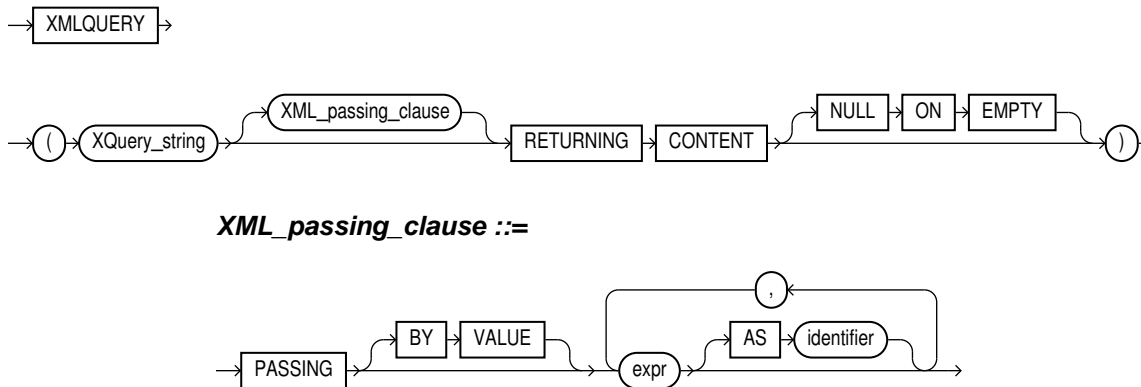

- *XQuery_string* is a complete XQuery expression, possibly including a prolog, as a literal string.
- The *XML_passing_clause* is the keyword `PASSING` followed by one or more SQL expressions (*expr*) that each return an `XMLType` instance or an instance of a SQL scalar data type (that is, not an object or collection data type). Each expression (*expr*) can be a table or view column value, a PL/SQL variable, or a bind variable with proper casting. All but possibly one of the expressions must each be followed by the keyword `AS` and an XQuery *identifier*. The result of evaluating each *expr* is bound to the corresponding *identifier* for the evaluation of *XQuery_string*. If there is an *expr* that is not followed by an `AS` clause, then the result of evaluating that *expr* is used as the *context* item for evaluating *XQuery_string*. Oracle XML DB supports only passing `BY VALUE`, not passing `BY REFERENCE`, so the clause `BY VALUE` is implicit and can be omitted.

- RETURNING CONTENT indicates that the value returned by an application of XMLQuery is an instance of parameterized XML type XML (CONTENT), not parameterized type XML (SEQUENCE). It is a document fragment that conforms to the *extended* Infoset data model. As such, it is a single document node with any number of children. The children can each be of any XML node type; in particular, they can be text nodes.

Oracle XML DB supports only the RETURNING CONTENT clause of SQL/XML function XMLQuery; it does *not* support the RETURNING SEQUENCE clause.

You can pass an XMLType column, table, or view as the context-item argument to function XMLQuery — see, for example, [Example 5-8](#) (page 5-12).

To query a relational table or view as if it were XML data, without having to first create a SQL/XML view on top of it, use XQuery function `fn:collection` within an XQuery expression, passing as argument a URI that uses the URI-scheme name `oradb` together with the database location of the data. See [URI Scheme oradb: Querying Table or View Data with XQuery](#) (page 4-18).

Note:

Prior to Oracle Database 11g Release 2, some users employed Oracle SQL functions `extract` and `extractValue` to do some of what can be done better using SQL/XML functions XMLQuery and XMLCast. SQL functions `extract` and `extractValue` are *deprecated* in Oracle Database 11g Release 2.

See Also:

Oracle Database SQL Language Reference for reference information about SQL/XML function XMLQuery in Oracle Database

4.3.2 XMLTABLE SQL/XML Function in Oracle XML DB

You use SQL/XML function XMLTable to decompose the result of an XQuery-expression evaluation into the relational rows and columns of a new, virtual table. You can insert this data into a pre-existing database table, or you can query it using SQL — in a join expression, for example.

See [Example 5-9](#) (page 5-13).

You use XMLTable in a SQL FROM clause.

Figure 4-2 XMLTABLE Syntax

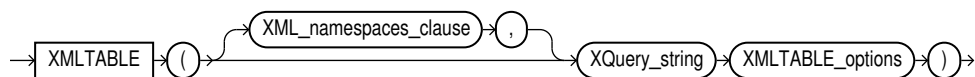

XML_namespaces_clause ::=

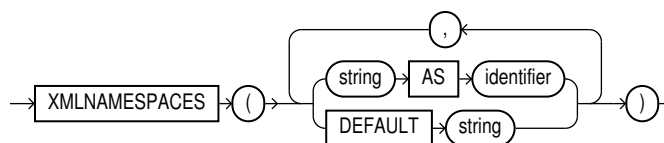

Note: You can specify at most one DEFAULT *string* clause.

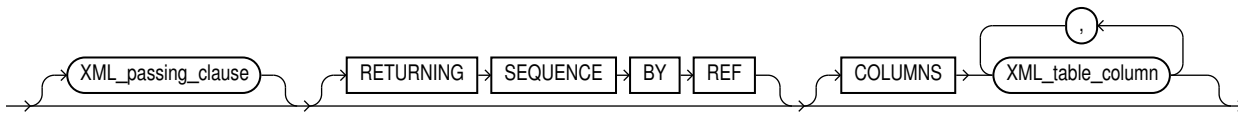
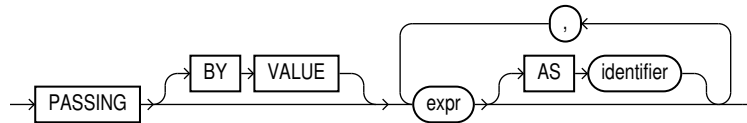
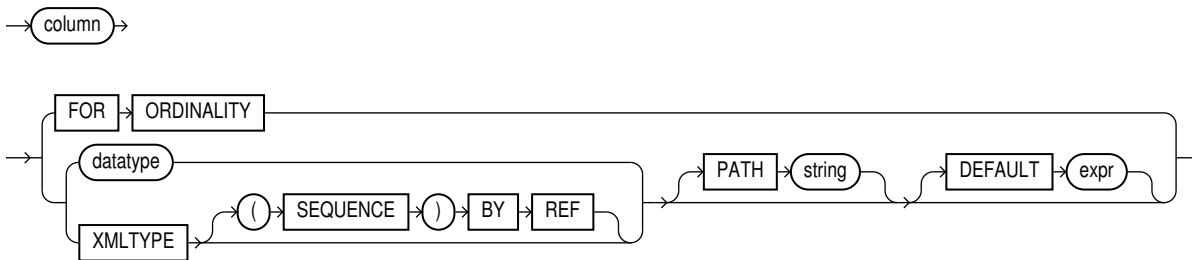
XMLTABLE_options ::=**XML_passing_clause ::=****XML_table_column ::=**

- *XQuery_string* is sometimes called the **row pattern** of the XMLTable call. It is a complete XQuery expression, possibly including a prolog, as a literal string. The value of the expression serves as input to the XMLTable function; it is this XQuery result that is decomposed and stored as relational data.
- The optional XMLNAMESPACES clause contains XML namespace declarations that are referenced by *XQuery_string* and by the XPath expression in the PATH clause of *XML_table_column*.
- The *XML_passing_clause* is the keyword **PASSING** followed by one or more SQL expressions (*expr*) that each return an XMLType instance or an instance of a SQL scalar data type (that is, not an object or collection data type). Each expression (*expr*) can be a table or view column value, a PL/SQL variable, or a bind variables with proper casting. All but possibly one of the expressions must each be followed by the keyword **AS** and an XQuery *identifier*. The result of evaluating each *expr* is bound to the corresponding *identifier* for the evaluation of *XQuery_string*. If there is an *expr* that is not followed by an **AS** clause, then the result of evaluating that *expr* is used as the *context* item for evaluating *XQuery_string*. Oracle XML DB supports only passing **BY VALUE**, not passing **BY REFERENCE**, so the clause **BY VALUE** is implicit and can be omitted.
- The optional **COLUMNS** clause defines the columns of the virtual table to be created by XMLTable.
 - If you omit the **COLUMNS** clause, then XMLTable returns a row with a single XMLType pseudo-column, named **COLUMN_VALUE**.
 - **FOR ORDINALITY** specifies that *column* is to be a column of generated row numbers (SQL data type NUMBER). The row numbers start with 1. There must be at most one **FOR ORDINALITY** clause.

- For each resulting *column* except the FOR ORDINALITY column, you must specify the column data type, which can be XMLType or any other SQL data type (called *datatype* in the syntax description).
- For data type XMLType, if you also include the specification (SEQUENCE) BY REF then a *reference* to the source data targeted by the PATH expression (*string*) is returned as the *column* content. Otherwise, *column* contains a *copy* of that targeted data.

Returning the XMLType data by reference lets you specify other columns whose paths target nodes in the source data that are outside those targeted by the PATH expression for *column*. See [Example 5-13](#) (page 5-15).

- The optional PATH clause specifies that the portion of the XQuery result that is addressed by XQuery expression *string* is to be used as the *column* content. This XQuery expression is sometimes called the **column pattern**. You can use multiple PATH clauses to split the XQuery result into different virtual-table columns.

If you omit PATH, then the XQuery expression *column* is assumed. For example, these two expressions are equivalent:

```
XMLTable(... COLUMNS foo)
XMLTable(... COLUMNS foo PATH 'FOO')
```

The XQuery expression *string* must represent a *relative* path; it is relative to the path *XQuery_string*.

- The optional DEFAULT clause specifies the value to use when the PATH expression results in an empty sequence (or NULL). Its *expr* is an XQuery expression that is evaluated to produce the default value.

See Also:

Oracle Database SQL Language Reference for reference information about SQL/XML function XMLTable in Oracle Database

Note:

Prior to Oracle Database 11g Release 2, some users employed Oracle SQL function XMLSequence within a SQL TABLE collection expression, that is, TABLE (XMLSequence(. . .)), to do some of what can be done better using SQL/XML function XMLTable. Function XMLSequence is *deprecated* in Oracle Database 11g Release 2.

See *Oracle Database SQL Language Reference* for information about the SQL TABLE collection expression.

4.3.2.1 Chaining Calls to SQL/XML Function XMLTABLE

When you need to expose data contained at multiple levels in an XMLType table as individual rows in a relational table (or view), you use the same general approach as for breaking up a single level: Use SQL/XML function XMLTable to define the columns making up the table and map the XML nodes to those columns.

But in this case you apply function XMLTable to each document level that is to be broken up and stored in relational columns. Use this technique of **chaining** multiple

XMLTable calls whenever there is a one-to-many (1:N) relationship between documents in the XMLType table and the rows in the relational table.

You pass one level of XMLType data from one XMLTable call to the next, specifying its column type as XMLType.

When you chain two XMLTable calls, the *row pattern* of each call should target the *deepest node that is a common ancestor* to all of the nodes that are referenced in the *column patterns* of that call.

This is illustrated in [Example 4-1](#) (page 4-14).

Each PurchaseOrder element in XMLType table po_binaryxml contains a LineItems element, which in turn contains one or more LineItem elements. Each LineItem element has child elements, such as Description, and an ItemNumber attribute. To make such lower-level data accessible as a relational value, you use XMLTable to project the collection of LineItem elements.

When element PurchaseOrder is decomposed by the first call to XMLTable, its descendant LineItem element is mapped to a column of type XMLType, which contains an XML fragment. That column is then passed to a second call to XMLTable to be broken by it into its various parts as multiple columns of relational values.

The first call to XMLTable uses /PurchaseOrder as the row pattern, because PurchaseOrder is the deepest common ancestor node for the column patterns, Reference and LineItems/LineItem.

The second call to XMLTable uses /LineItem as its row pattern, because that node is the deepest common ancestor node for each of its column patterns (@ItemNumber, Description, Part/@Id, and so on).

The *column pattern* (LineItems/LineItem) for the column (po.lineitem) that is passed from the first XMLTable call to the second *ends with the repeating element* (LineItem) that the second XMLTable call decomposes. That repeating element, written with a leading slash (/), is used as the first element of the *row pattern* for the second XMLTable call.

The row pattern in each case is thus expressed as an *absolute* path; that is, it starts with /. It is the starting point for decomposition by XMLTable. Column patterns, on the other hand, *never* start with a slash (/); they are always relative to the row pattern of the same XMLTable call.

Example 4-1 Chaining XMLTable Calls

```
SELECT po.reference, li.*
FROM po_binaryxml p,
     XMLTable('/PurchaseOrder' PASSING p.OBJECT_VALUE
             COLUMNS
               reference VARCHAR2(30) PATH 'Reference',
               lineitem XMLType      PATH 'LineItems/LineItem') po,
     XMLTable('/LineItem' PASSING po.lineitem
             COLUMNS
               itemno      NUMBER(38)   PATH '@ItemNumber',
               description VARCHAR2(256) PATH 'Description',
               partno      VARCHAR2(14)  PATH 'Part/@Id',
               quantity    NUMBER(12, 2) PATH 'Part/@Quantity',
               unitprice   NUMBER(8, 4)  PATH 'Part/@UnitPrice') li;
```

4.3.3 XMLEXISTS SQL/XML Function in Oracle XML DB

SQL/XML standard function `XMLEXISTS` checks whether a given XQuery expression returns a non-empty XQuery sequence. If so, the function returns `TRUE`. Otherwise, it returns `FALSE`.

Figure 4-3 (page 4-15) describes the syntax for function `XMLEXISTS`.

Figure 4-3 *XMLEXISTS Syntax*

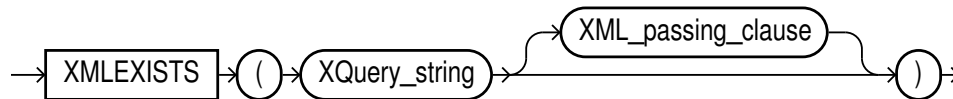

XML_passing_clause ::=

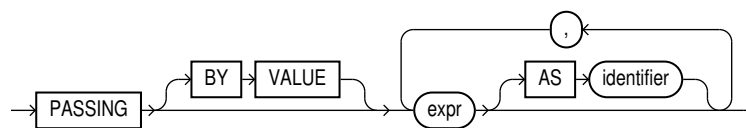

- *XQuery_string* is a complete XQuery expression, possibly including a prolog, as a literal string. It can contain XQuery variables that you bind using the XQuery `PASSING` clause (*XML_passing_clause* in the syntax diagram). The predefined namespace prefixes recognized for SQL/XML function `XMLQuery` are also recognized in *XQuery_string* — see [Predefined XQuery Namespaces and Prefixes](#) (page 4-9).
- The *XML_passing_clause* is the keyword `PASSING` followed by one or more SQL expressions (*expr*) that each return an `XMLType` instance or an instance of a SQL scalar data type. All but possibly one of the expressions must each be followed by the keyword `AS` and an XQuery *identifier*. The result of evaluating each *expr* is bound to the corresponding *identifier* for the evaluation of *XQuery_string*. If there is an *expr* that is not followed by an `AS` clause, then the result of evaluating that *expr* is used as the *context* item for evaluating *XQuery_string*. Oracle XML DB supports only passing `BY VALUE`, not passing `BY REFERENCE`, so the clause `BY VALUE` is implicit and can be omitted.

If an XQuery expression such as `/PurchaseOrder/Reference` or `/PurchaseOrder/Reference/text()` targets a single node, then `XMLEXISTS` returns `true` for that expression. If `XMLEXISTS` is called with an XQuery expression that locates no nodes, then `XMLEXISTS` returns `false`.

Function `XMLEXISTS` can be used in queries, and it can be used to create function-based indexes to speed up evaluation of queries.

Note:

Oracle XML DB limits the use of `XMLEXISTS` to a SQL `WHERE` clause or `CASE` expression. If you need to use `XMLEXISTS` in a `SELECT` list, then wrap it in a `CASE` expression:

```
CASE WHEN XMLEXISTS(...) THEN 'TRUE' ELSE 'FALSE' END
```

Note:

Prior to Oracle Database 11g Release 2, some users employed Oracle SQL function `existsNode` to do some of what can be done better using SQL/XML function `XMLEExists`. Function `existsNode` is *deprecated* in Oracle Database 11g Release 2. The two functions differ in these important ways:

- Function `existsNode` returns 0 or 1. Function `XMLEExists` returns a Boolean value, `TRUE` or `FALSE`.
- You can use `existsNode` in a query `SELECT` list. You cannot use `XMLEExists` directly in a `SELECT` list, but you can use `XMLEExists` within a `CASE` expression in a `SELECT` list.

4.3.4 Using XMLEExists to Find a Node

You can use SQL/XML standard function `XMLEExists` to find a given node. You can create function-based indexes using `XMLEExists`. You can also create an `XMLIndex` index to help speed up arbitrary XQuery searching.

[Example 4-2](#) (page 4-16) uses `XMLEExists` to select rows with `SpecialInstructions` set to `Expedite`.

Example 4-2 Finding a Node Using SQL/XML Function XMLEExists

```
SELECT OBJECT_VALUE
   FROM purchaseorder
  WHERE XMLEExists('/PurchaseOrder[SpecialInstructions="Expedite"]'
                  PASSING OBJECT_VALUE);
```

```
OBJECT_VALUE
```

```
-----
<PurchaseOrder xmlns:xsi="http://www.w3.org/2001/XMLSchema-instance"
<PurchaseOrder xmlns:xsi="http://www.w3.org/2001/XMLSchema-instance"
<PurchaseOrder xmlns:xsi="http://www.w3.org/2001/XMLSchema-instance"
<PurchaseOrder xmlns:xsi="http://www.w3.org/2001/XMLSchema-instance"
<PurchaseOrder xmlns:xsi="http://www.w3.org/2001/XMLSchema-instance"
<PurchaseOrder xmlns:xsi="http://www.w3.org/2001/XMLSchema-instance"
<PurchaseOrder xmlns:xsi="http://www.w3.org/2001/XMLSchema-instance"
<PurchaseOrder xmlns:xsi="http://www.w3.org/2001/XMLSchema-instance"
<PurchaseOrder xmlns:xsi="http://www.w3.org/2001/XMLSchema-instance"
<PurchaseOrder xmlns:xsi="http://www.w3.org/2001/XMLSchema-instance"
<PurchaseOrder xmlns:xsi="http://www.w3.org/2001/XMLSchema-instance"
<PurchaseOrder xmlns:xsi="http://www.w3.org/2001/XMLSchema-instance"
<PurchaseOrder xmlns:xsi="http://www.w3.org/2001/XMLSchema-instance"
```

13 rows selected.

4.3.5 XMLCAST SQL/XML Function in Oracle XML DB

You can use SQL/XML function `XMLCast` to cast an XQuery value to a SQL data type.

[Figure 4-4](#) (page 4-16) describes the syntax for SQL/XML standard function `XMLCast`.

Figure 4-4 XMLCast Syntax

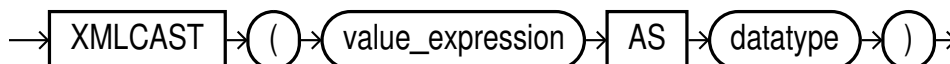

SQL/XML standard function `XMLCast` casts its first argument to the scalar SQL data type specified by its second argument. The first argument is a SQL expression that is evaluated. Any of the following SQL data types can be used as the second argument:

- NUMBER
- VARCHAR2
- CHAR
- CLOB
- BLOB
- REF XMLTYPE
- any SQL date or time data type

Note:

Unlike the SQL/XML standard, Oracle XML DB limits the use of `XMLCast` to cast XML to a SQL scalar data type. Oracle XML DB does not support casting XML to XML or from a scalar SQL type to XML.

The result of evaluating the first `XMLCast` argument is an XML value. It is converted to the target SQL data type by using the XQuery atomization process and then casting the XQuery atomic values to the target data type. If this conversion fails, then an error is raised. If conversion succeeds, the result returned is an instance of the target data type.

Note:

- Prior to Oracle Database 11g Release 2, some users employed Oracle SQL function `extractValue` to do some of what can be done better using SQL/XML functions `XMLQuery` and `XMLCast`. Function `extractValue` is *deprecated* in Oracle Database 11g Release 2.
 - Function `extractValue` raises an error when its XPath expression argument matches multiple text nodes. `XMLCast` applied to an `XMLQuery` result returns the concatenation of the text nodes — it does *not* raise an error.
-
-

See Also:

- [Indexing XMLType Data Stored Object-Relationally](#) (page 6-62)
 - [XMLIndex](#) (page 6-7)
-
-

4.3.6 Using XMLCAST to Extract the Scalar Value of an XML Fragment

You can use standard SQL/XML function `XMLCast` to extract the scalar value of an XML fragment.

The query in [Example 4-3](#) (page 4-18) extracts the scalar value of node Reference.

Example 4-3 Extracting the Scalar Value of an XML Fragment Using XMLCAST

```
SELECT XMLCast(XMLQuery('/PurchaseOrder/Reference' PASSING OBJECT_VALUE
                        RETURNING CONTENT)
              AS VARCHAR2(100)) "REFERENCE"
FROM purchaseorder
WHERE XMLEExists('/PurchaseOrder[SpecialInstructions="Expedite"]'
                 PASSING OBJECT_VALUE);
```

```
REFERENCE
-----
AMCEWEN-20021009123336271PDT
SKING-20021009123336321PDT
AWALSH-20021009123337303PDT
JCHEN-20021009123337123PDT
AWALSH-20021009123336642PDT
SKING-20021009123336622PDT
SKING-20021009123336822PDT
AWALSH-20021009123336101PDT
WSMITH-20021009123336412PDT
AWALSH-20021009123337954PDT
SKING-20021009123338294PDT
WSMITH-20021009123338154PDT
TFOX-20021009123337463PDT
```

13 rows selected.

4.4 URI Scheme oradb: Querying Table or View Data with XQuery

You can use XQuery function `fn:collection` to query data that is in database tables and views.

Besides using XQuery functions `fn:doc` and `fn:collection` to query resources in Oracle XML DB Repository (see [Querying XML Data in Oracle XML DB Repository Using XQuery](#) (page 5-3)), you can use `fn:collection` to query data in database tables and views.

To do this, you pass function `fn:collection` a URI argument that specifies the table or view to query. The Oracle URI scheme `oradb` identifies this usage: without it, the argument is treated as a repository location.

The table or view that is queried can be relational or of type `XMLType`. If relational, its data is converted on the fly and treated as XML. The result returned by `fn:collection` is always an XQuery sequence.

- For an `XMLType` table, the root element of each XML document returned by `fn:collection` is the same as the root element of an XML document in the table.
- For a relational table, the root element of each XML document returned by `fn:collection` is `ROW`. The children of the `ROW` element are elements with the same names (uppercase) as columns of the table. The content of a child element corresponds to the column data. That content is an XML element if the column is of type `XMLType`; otherwise (the column is a scalar type), the content is of type `xs:string`.

The format of the URI argument passed to `fn:collection` is as follows:

- For an `XMLType` or relational table or view, `TABLE`, in database schema `DB-SCHEMA`:

oradb: /DB-SCHEMA/TABLE/

You can use **PUBLIC** for *DB-SCHEMA* if *TABLE* is a public synonym or *TABLE* is a table or view that is accessible to the database user currently logged in.

- For an XMLType column in a *relational* table or view:

oradb: /DB-SCHEMA/REL-TABLE/ROWPRED/X-COL

REL-TABLE is a relational table or view; *PRED* is an XPath predicate that does not involve any XMLType columns; and *X-COL* is an XMLType column in *REL-TABLE*. *PRED* is optional; *DB-SCHEMA*, *REL-TABLE*, and *X-COL* are required.

Optional XPath predicate *PRED* must satisfy the following conditions:

- It does not involve any XMLType columns.
- It involves only conjunctions (and) and disjunctions (or) of general equality and inequality comparisons (=, !=, >, <, >=, and <=).
- For each comparison operation: Either both sides name (non-XML) columns in *REL-TABLE* or one side names such a column and the other is a value of the proper type, as specified in [Table 4-3](#) (page 4-19). Use of any other type raises an error.

Table 4-3 oradb Expressions: Column Types for Comparisons

Relational Column Type	XQuery Value Type
VARCHAR2, CHAR	xs:string or string literal
NUMBER, FLOAT, BINARY_FLOAT, BINARY_DOUBLE	xs:decimal, xs:float, xs:double, or numeric literal
DATE, TIMESTAMP, TIMESTAMP WITH TIMEZONE, TIMESTAMP WITH LOCAL TIMEZONE	xs:date, xs:time, or xs:dateTime
INTERVAL YEAR TO MONTH	xs:yearMonthDuration
INTERVAL DAY TO SECOND	xs:dayTimeDuration
RAW	xs:hexBinary
ROWID	xs:string or string literal

For example, this XQuery expression represents all XML documents in XMLType column `warehouse_spec` of table `oe.warehouses`, for the rows where column `warehouse_id` has a value less than 6:

```
fn:collection('oradb:/OE/WAREHOUSES/ROW[WAREHOUSE_ID < 6]/WAREHOUSE_SPEC')
```

See Also:

[Querying Relational Data Using XQuery and URI Scheme oradb](#) (page 5-5)

4.5 Oracle XQuery Extension Functions

Oracle XML DB adds some XQuery functions to those provided in the W3C standard. These additional functions are in the Oracle XML DB namespace, `http://xmlns.oracle.com/xdb`, which uses the predefined prefix **ora**.

Note:

- Prior to Oracle Database 12c Release 1, standard XQuery functions `fn:matches` and `fn:replace` were not supported, and Oracle XML DB provided these Oracle XQuery functions to use in their stead: `ora:matches` and `ora:replace`. These Oracle XQuery functions are *deprecated* in Oracle Database 12c Release 1 – use the standard XQuery functions (namespace prefix `fn`) instead.
 - Oracle XQuery function `ora:contains` is *deprecated* in Oracle Database 12c Release 2 (12.2.0.1). Use XQuery Full Text instead.
-
-

4.5.1 ora:contains XQuery Function (Deprecated)

Oracle XQuery and XPath function `ora:contains` is described. This function is *deprecated* in Oracle Database 12c Release 2 (12.2.0.1). Use XQuery Full Text instead.

ora:contains Syntax

```
ora:contains (input_text, text_query [, policy_name] [, policy_owner])
```

Deprecated Oracle XQuery and XPath function `ora:contains` can be used in an XQuery expression in a call to SQL/XML function `XMLQuery`, `XMLTable`, or `XMLExists`. It is used to restrict a structural search with a full-text predicate. Function `ora:contains` returns a positive integer when the `input_text` matches `text_query` (the higher the number, the more relevant the match), and zero otherwise. When used in an XQuery expression (that is not also an XPath expression), the XQuery return type is `xs:integer()`; when used in an XPath expression outside of an XQuery expression, the XPath return type is `number`.

Argument `input_text` must evaluate to a single text node or an attribute. The syntax and semantics of `text_query` in `ora:contains` are the same as `text_query` in `contains`, with a few restrictions.

4.5.2 ora:sqrt XQuery Function

Oracle XQuery function `ora:sqrt` returns the square root of its numeric argument, which can be of XQuery type `xs:decimal`, `xs:float`, or `xs:double`. The returned value is of the same XQuery type as the argument.

ora:sqrt Syntax

```
ora:sqrt (number)
```

4.5.3 ora:tokenize XQuery Function

Oracle XQuery function `ora:tokenize` lets you use a regular expression to split the input string `target_string` into a sequence of strings.

ora:tokenize Syntax

```
ora:tokenize (target_string, match_pattern [, match_parameter])
```

Function `ora:tokenize` treats each substring that matches the regular-expression `match_pattern` as a separator indicating where to split. It returns the sequence of tokens as an XQuery value of type `xs:string*` (a sequence of `xs:string` values). If `target_string` is the empty sequence, it is returned. Optional argument `match_parameter` is a code that qualifies matching: case-sensitivity and so on.

The argument types are as follows:

- `target_string` – `xs:string?`³³
- `match_pattern` – `xs:string`
- `match_parameter` – `xs:string`

4.5.4 ora:matches XQuery Function (Deprecated)

Oracle XQuery function `ora:matches` is *deprecated*, starting with Oracle Database 12c Release 1 (12.1.0.1) – use standard XQuery function `fn:matches` instead.

ora:matches Syntax

```
ora:matches (target_string, match_pattern [, match_parameter])
```

Oracle XQuery function `ora:matches` lets you use a regular expression to match text in a string. It returns `true()` if its `target_string` argument matches its regular-expression `match_pattern` argument and `false()` otherwise. If `target_string` is the empty sequence, `false()` is returned. Optional argument `match_parameter` is a code that qualifies matching: case-sensitivity and so on.

The behavior of XQuery function `ora:matches` is the same as that of SQL condition `REGEXP_LIKE`, but the types of its arguments are XQuery types instead of SQL data types. The argument types are as follows:

- `target_string` – `xs:string?`⁴⁴
- `match_pattern` – `xs:string`
- `match_parameter` – `xs:string`

See Also:

Oracle Database SQL Language Reference for information about SQL condition `REGEXP_LIKE`

4.5.5 ora:replace XQuery Function (Deprecated)

Oracle XQuery function `ora:replace` is *deprecated*, starting with Oracle Database 12c Release 1 (12.1.0.1) – use standard XQuery function `fn:replace` instead.

³ The question mark (?) here is a zero-or-one occurrence indicator that indicates that the argument can be the empty sequence. See [XQuery Expressions](#) (page 4-5).

⁴ The question mark (?) here is a zero-or-one occurrence indicator that indicates that the argument can be the empty sequence. See [XQuery Expressions](#) (page 4-5).

ora:replace Syntax

```
ora:replace (target_string, match_pattern, replace_string [, match_parameter])
```

Oracle XQuery function `ora:replace` lets you use a regular expression to replace matching text in a string. Each occurrence in `target_string` that matches regular-expression `match_pattern` is replaced by `replace_string`. It returns the new string that results from the replacement. If `target_string` is the empty sequence, then the empty string (" ") is returned. Optional argument `match_parameter` is a code that qualifies matching: case-sensitivity and so on.

The behavior of XQuery function `ora:replace` is the same as that of SQL function `regexp_replace`, but the types of its arguments are XQuery types instead of SQL data types. The argument types are as follows:

- `target_string` – `xs:string?`⁵⁵
- `match_pattern` – `xs:string`
- `replace_string` – `xs:string`
- `match_parameter` – `xs:string`

In addition, `ora:replace` requires argument `replace_string` (it is optional in `regexp_replace`) and it does not use arguments for position and number of occurrences – search starts with the first character and all occurrences are replaced.

See Also:

Oracle Database SQL Language Reference for information about SQL function `regexp_replace`

4.6 Oracle XQuery Extension-Expression Pragmas

The W3C XQuery specification lets an implementation provide implementation-defined extension expressions. An XQuery extension expression is an XQuery expression that is enclosed in braces (`{, }`) and prefixed by an implementation-defined pragma. The Oracle implementation provides several such pragmas.

No other pragmas are recognized than those listed here. Use of any other pragma, or use of any of these pragmas with incorrect pragma content (for example, `(#ora:view_on_null something_else #)`), raises an error.

In the `ora:view_on_null` examples here, assume that table `null_test` has columns `a` and `b` of type `VARCHAR2(10)`, and that column `b` (but not `a`) is empty.

- `(#ora:child-element-name name #)` – Specify the name to use for a child element that is inserted. In general, without this pragma the name of the element to be inserted is unknown at compile time. Specifying the name allows for compile-time optimization, to improve runtime performance.

As an example, the following SQL statement specifies `LineItem` as the name of the element node that is inserted as a child of element `LineItems`. The element data to be inserted is the value of XQuery variable `p2`, which comes from bind variable `:1`.

⁵ The question mark (?) here is a zero-or-one occurrence indicator that indicates that the argument can be the empty sequence. See [XQuery Expressions](#) (page 4-5).

```

UPDATE oe.purchaseorder p SET p.OBJECT_VALUE =
  XMLQuery(
    'copy $i :=
      $p1 modify (for $j in $i/PurchaseOrder/LineItems
        return (#ora:child-element-name LineItem #)
          {insert node $p2 into $j})
      return $i'
    PASSING p.OBJECT_VALUE AS "p1", :1 AS "p2" RETURNING CONTENT)
WHERE XMLQuery(
  '/PurchaseOrder/Reference/text()'
  PASSING p.OBJECT_VALUE RETURNING CONTENT).getStringVal() =
  'EMPTY_LINES';

```

This pragma applies to XMLType data stored either object-relationally or as binary XML.

- (**#ora:defaultTable #**) – Specify the default table used to store repository data. Use this to improve the performance of repository queries that use Query function `fn:doc` or `fn:collection`. See [Using Oracle XQuery Pragma ora:defaultTable](#) (page 5-47).
- (**#ora:invalid_path empty #**) – Treat an invalid XPath expression as if its targeted nodes do not exist. For example:

```

SELECT XMLQuery('#ora:invalid_path empty #)
  {exists($p/PurchaseOrder//NotInTheSchema)}'
  PASSING OBJECT_VALUE AS "p" RETURNING CONTENT)
FROM oe.purchaseorder p;

```

The XML schema for table `oe.purchaseorder` does not allow any such node `NotInTheSchema` as a descendant of node `PurchaseOrder`. Without the pragma, the use of this invalid XPath expression would raise an error. But with the pragma, the calling context acts just as if the XPath expression had targeted no nodes. That calling context in this example is XQuery function `exists`, which returns XQuery Boolean value `false` when passed an empty node sequence. (XQuery function `exists` is used in this example only to illustrate the behavior; the pragma is not especially related to function `exists`.)

- (**#ora:view_on_null empty #**) – XQuery function `fn:collection` returns an empty XML element for each NULL column. For example, the following query returns `<ROW><A>x</ROW>`:

```

SELECT XMLQuery('#ora:view_on_null empty #)
  {for $i in fn:collection("oradb:/PUBLIC/NULL_TEST")/ROW
    return $i}'
  RETURNING CONTENT)
FROM DUAL;

```

- (**#ora:view_on_null null #**) – XQuery function `fn:collection` returns no element for a NULL column. For example, the following query returns `<ROW><A>x</ROW>`:

```

SELECT XMLQuery('#ora:view_on_null null #)
  {for $i in fn:collection("oradb:/PUBLIC/NULL_TEST")/ROW
    return $i}'
  RETURNING CONTENT)
FROM DUAL;

```

- (`#ora:no_xmlquery_rewrite #`)⁶ – Do not optimize XQuery procedure calls in the XQuery expression that follows the pragma; use functional evaluation instead.

This has the same effect as the SQL hint `/*+ NO_XML_QUERY_REWRITE */`, but the scope of the pragma is only the XQuery expression that follows it (not an entire SQL statement).

See Also:

[Turning Off Use of XMLIndex](#) (page 6-36) for information about optimizer hint `NO_XML_QUERY_REWRITE`

- (`#ora:xmlquery_rewrite #`)⁶ – Try to optimize the XQuery expression that follows the pragma. That is, if possible, do not evaluate it functionally.

As an example of using both `ora:no_xmlquery_rewrite` and `ora:xmlquery_rewrite`, in the following query the XQuery expression argument to `XMLQuery` will in general be evaluated functionally, but the `fn:collection` subexpressions that are preceded by pragma `ora:xmlquery_rewrite` will be optimized, if possible.

```
SELECT XMLQuery('(#ora:no_xmlquery_rewrite#) (: Do not optimize expression :)
               {for $i in (#ora:xmlquery_rewrite#) (: Optimize subexp. :)
                 {fn:collection("oradb:/HR/REGIONS")},
                 $j in (#ora:xmlquery_rewrite#) (: Optimize subexpr. :)
                 {fn:collection("oradb:/HR/COUNTRIES")}}
               where $i/ROW/REGION_ID = $j/ROW/REGION_ID
                 and $i/ROW/REGION_NAME = $regionname
               return $j}')
       PASSING CAST('&REGION' AS VARCHAR2(40)) AS "regionname"
       RETURNING CONTENT
AS asian_countries FROM DUAL;
```

- (`#ora:no_schema #`) – Do not raise an error if an XQuery Full Text expression is used with XML Schema-based `XMLType` data. Instead, implicitly cast the data to non XML-Schema-based data. In particular, this means ignore XML Schema data types.

Oracle supports XQuery Full Text only for `XMLType` data stored as binary XML, so this pragma applies only for the same case.

- (`#ora:use_xmltext_idx #`) – Use an XML search index, if available, to evaluate the query. Do not use an `XMLIndex` index or streaming evaluation.

An XML search index applies only to `XMLType` data stored as binary XML, so this pragma does also.

- (`#ora:transform_keep_schema #`) – Retain XML Schema information for the documents returned by the XQuery expression that follows the pragma. This is useful for XQuery Update, which uses copy semantics.

Without the pragma, when XML schema-based data is copied during an XQuery Update operation, the XML schema information is lost. This is the behavior specified by the XQuery Update standard. If you then try to insert the updated data

⁶ Prior to Oracle Database 12c Release 1 (12.1.0.1), pragmas `ora:no_xmlquery_rewrite` and `ora:xmlquery_rewrite` were named `ora:xq_proc` and `ora:xq_qry`, respectively. They were renamed for readability, with no change in meaning.

into an XML schema-based column or table then an error is raised: the data to be inserted is untyped, so it does not conform to the XML schema.

If you use the pragma then the data retains its XML schema information, preventing the insertion error. Here is an example of using the pragma:

```
SELECT XMLQuery('declare default element namespace
                "http://xmlns.oracle.com/xdb/xdbconfig.xsd"; (: :)
                (#ora:transform_keep_schema#)
                {copy $NEWXML :=
                  $XML modify (for $CFG in $NEWXML/xdbconfig/httpconfig
                              return (replace value of node
                                      $CFG/http-port with xs:int($PORTNO)))
                  return $NEWXML}')
        PASSING CFG AS "XML", 81 as "PORTNO" RETURNING CONTENT)
FROM DUAL;
```

4.7 XQuery Static Type-Checking in Oracle XML DB

When possible, Oracle XML DB performs static (compile time) type-checking of queries.

Oracle XML DB type-checks *all* XQuery expressions. Doing this at run time can be costly, however. As an optimization technique, whenever there is sufficient static type information available for a given query at compile time, Oracle XML DB performs *static* (compile time) type-checking of that query. Whenever sufficient static type information is not available for a given query at compile time, Oracle XML DB uses dynamic (run-time) type checking for that query.

Static type-checking can save execution time by raising errors at compile time. Static type-checking errors include both data-type errors and the use of XPath expressions that are invalid with respect to an XML schema.

Typical ways of providing sufficient static type information at query compile time include the following:

- Using XQuery with `fn:doc` or `fn:collection` over relational data.
- Using XQuery to query an `XMLType` table, column, or view whose XML Schema information is available at query compile time.
- Using XQuery Update with a transform expression whose input is from an `XMLType` table or column that is based on an XML schema.

This section presents examples that demonstrate the utility of static type-checking and the use of these two means of communicating type information.

The XML data produced on the fly by `fn:collection` together with URI scheme `oradb` has `ROW` as its top-level element, but the query of [Example 4-4](#) (page 4-26) incorrectly lacks that `ROW` wrapper element. This omission raises a query compile-time error. Forgetting that `fn:collection` with `oradb` wraps relational data in this way is an easy mistake to make, and one that could be difficult to diagnose without static type-checking. [Example 5-5](#) (page 5-6) shows the correct code.

In [Example 4-5](#) (page 4-26), XQuery static type-checking finds a mismatch between an XPath expression and its target XML schema-based data. Element `CostCenter` is misspelled here as `costcenter` (XQuery and XPath are case-sensitive). [Example 5-11](#) (page 5-13) shows the correct code.

Example 4-4 Static Type-Checking of XQuery Expressions: oradb URI scheme

```
-- This produces a static-type-check error, because "ROW" is missing.
SELECT XMLQuery('for $i in fn:collection("oradb:/HR/REGIONS"),
               $j in fn:collection("oradb:/HR/COUNTRIES")
               where $i/REGION_ID = $j/REGION_ID and $i/REGION_NAME = "Asia"
               return $j'
               RETURNING CONTENT) AS asian_countries
FROM DUAL;
SELECT XMLQuery('for $i in fn:collection("oradb:/HR/REGIONS"),
*
ERROR at line 1:
ORA-19276: XPST0005 - XPath step specifies an invalid element/attribute name:
(REGION_ID)
```

Example 4-5 Static Type-Checking of XQuery Expressions: XML Schema-Based Data

```
-- This results in a static-type-check error: CostCenter is not the right case.
SELECT xtab.poref, xtab.usr, xtab.requestor
FROM purchaseorder,
XMLTable('for $i in /PurchaseOrder where $i/costcenter eq "A10" return $i'
        PASSING OBJECT_VALUE
        COLUMNS poref VARCHAr2(20) PATH 'Reference',
                 usr VARCHAr2(20) PATH 'User' DEFAULT 'Unknown',
                 requestor VARCHAr2(20) PATH 'Requestor') xtab;
FROM purchaseorder,
*
ERROR at line 2:
ORA-19276: XPST0005 - XPath step specifies an invalid element/attribute name:
(costcenter)
```

4.8 Oracle XML DB Support for XQuery

Oracle XML DB support for the XQuery language includes SQL support and support for XQuery functions and operators.

4.8.1 Support for XQuery and SQL

Support for the XQuery language in Oracle XML DB is designed to provide the best fit between the worlds of relational storage and querying XML data. Oracle XML DB is a general XQuery implementation, but it is in addition specifically designed to make relational and XQuery queries work well together.

The specific properties of the Oracle XML DB XQuery implementation are described in this section. The XQuery standard explicitly calls out certain aspects of the language processing as implementation-defined or implementation-dependent. There are also some features that are specified by the XQuery standard but are not supported by Oracle XML DB.

See Also:

[Support for XQuery Full Text](#) (page 4-28)

4.8.1.1 Implementation Choices Specified in the XQuery Standards

The XQuery standards specify several aspects of language processing that are to be defined by the implementation.

- *Implicit time zone support* – In Oracle XML DB, the implicit time zone is always assumed to be Z, and instances of `xs:date`, `xs:time`, and `xs:datetime` that are missing time zones are automatically converted to UTC.
- *copy-namespaces default value* – The default value for a `copy-namespaces` declaration (used in XQuery Update) is `inherit`.
- *Revalidation mode* – The default mode for XQuery Update transform expression revalidation is `skip`. However, if the result of a transform expression is an update to XML schema-based data in an `XMLType` table or column, then XML schema validation is enforced.

4.8.1.2 XQuery Features Not Supported by Oracle XML DB

The features specified by the XQuery standard that are not supported by Oracle XML DB are specified.

- *Copy-namespace mode* – Oracle XML DB supports only `preserve` and `inherit` for a `copy-namespaces` declaration. If an existing element node is copied by an element constructor or a document constructor, all in-scope namespaces of the original element are retained in the copy. Otherwise, the copied node inherits all in-scope namespaces of the constructed node. An error is raised if you specify `no-preserve` or `no-inherit`.
- *Version encoding* – Oracle XML DB does not support an optional encoding declaration in a version declaration. That is, you cannot include `(encoding an-encoding)` in a declaration `xquery version a-version;`. In particular, you cannot specify an encoding used in the query. An error is raised if you include an encoding declaration.
- *xml:id* – Oracle XML DB does not support use of `xml:id`. If you use `xml:id`, then an error is raised.
- XQuery prolog `default-collation` declaration.
- XQuery prolog `boundary-space` declaration.
- XQuery data type `xs:duration`. Use either `xs:yearMonthDuration` or `xs:DayTimeDuration` instead.
- XQuery Update function `fn:put`.

4.8.1.3 XQuery Optional Features

The optional XQuery features that are not supported by Oracle XML DB are specified.

The XQuery standard specifies that some features are *optional* for a given implementation. The following optional XQuery features are *not* supported by Oracle XML DB:

- Schema Validation Feature
- Module Feature

The following optional XQuery features are supported by Oracle XML DB:

- XQuery Static Typing Feature
- XQuery Update Static Typing Feature

See Also:[XQuery Static Type-Checking in Oracle XML DB](#) (page 4-25)

4.8.2 Support for XQuery Functions and Operators

Oracle XML DB supports all of the XQuery functions and operators included in the latest *XQuery 1.0 and XPath 2.0 Functions and Operators* specification, with a few exceptions.

Oracle XML DB does *not* support the following XQuery functions and operators:

- Function `fn:tokenize`. Use Oracle XQuery function `ora:tokenize` instead.
- Functions `fn:id` and `fn:idref`.
- Function `fn:collection` without arguments.
- Optional collation parameters for XQuery functions.

4.8.2.1 XQuery Functions `fn:doc`, `fn:collection`, and `fn:doc-available`

Oracle XML DB supports XQuery functions `fn:doc`, `fn:collection`, and `fn:doc-available` for all resources in Oracle XML DB Repository.

Function `fn:doc` returns the repository *file* resource that is targeted by its URI argument; it must be a file of well-formed XML data. Function `fn:collection` is similar, but works on repository *folder* resources (each file in the folder must contain well-formed XML data).

When used with Oracle URI scheme `oradb`, `fn:collection` can return XML data derived on the fly from existing relational data that is not in the repository.

XQuery function `fn:collection` raises an error when used with URI scheme `oradb`, if its targeted table or view, or a targeted column, does not exist. Functions `fn:doc` and `fn:collection` do *not* raise an error if the repository resource passed as argument is not found. Instead, they return an empty sequence.

You can determine whether a given document exists using XQuery function `fn:doc-available`. It returns `true` if its document argument exists, `false` if not.

See Also:<http://www.w3.org/> for the definitions of XQuery functions and operators

4.8.3 Support for XQuery Full Text

Oracle XML DB supports XQuery Full Text for `XMLType` data that is stored as binary XML. Oracle Text technology provides the full-text indexing and search that is the basis of this support.

Refer to the XQuery and XPath Full Text 1.0 Recommendation (hereafter XQuery Full Text, or XQFT) for information about any terms that are not detailed here.

Oracle supports XQuery Full Text *only* for `XMLType` data that is stored as *binary XML*. You can perform a full-text search of `XMLType` data that is stored object-rationally using an Oracle Text index, but not using XQuery Full Text.

A general rule for understanding Oracle support for XQuery Full Text is that the Oracle implementation of XQFT is based on Oracle Text, which provides full-text indexing and search for Oracle products and for applications developed using them. The XQFT support details provided in this section are a consequence of this Oracle Text based implementation.

See Also:

- *Oracle Text Application Developer's Guide*
 - *Oracle Text Reference*
-
-

4.8.3.1 XQuery Full Text, XML Schema-Based Data, and Pragma ora:no_schema

Use Oracle pragma `ora:no_schema` with XQuery Full Text to query XML Schema-based `XMLType` data that is stored as binary XML. The data is treated as if it were non XML Schema-based.

You can use XQuery Full Text to query `XMLType` data that is stored as binary XML. However, if you use it with XML Schema-based data then you must also use the XQuery extension-expression pragma `ora:no_schema` in your query, or else an error is raised.

And if you use `ora:no_schema` then, for purposes of XQuery Full Text, the XML data is implicitly cast to non XML Schema-based data. In other words, Oracle support of XQuery Full Text treats all XML data as if it were not based on an XML schema.

In particular, this means that if you include in your query an XQuery Full Text condition that makes use of XML Schema data types, such type considerations are ignored. A comparison of two XML Schema date values, for instance, is handled as a simple string comparison. Oracle support for XQuery Full Text is not XML Schema-aware.

See Also:

[Pragma ora:no_schema: Using XML Schema-Based Data with XQuery Full Text](#) (page 6-58)

4.8.3.2 Restrictions on Using XQuery Full Text with XMLExists

Restrictions are specified for using XQuery Full Text with SQL/XML function `XMLExists`.

You can pass only one `XMLType` instance as a SQL expression in the `PASSING` clause of SQL/XML function `XMLExists`, and each of the other, non-`XMLType` SQL expressions in that clause must be either a *compile-time constant* of a SQL built-in data type or a *bind variable* that is bound to an instance of such a data type. If this restriction is not respected then compile-time error ORA-18177 is raised.

4.8.3.3 Supported XQuery Full Text FTSelection Operators

Oracle XML DB supports a subset of the XQuery Full Text FTSelection operators.

Oracle XML DB supports *only* the following XQuery Full Text FTSelection operators. Any applicable restrictions are noted. Use of the terms "must" and "must not" means

that an error is raised if the specified restriction is not respected. Use of any operators not listed here raises an error.

- FTAnd (`ftand`)
- FTMildNot (`not in`)

Each operand for operator FTMildNot must be either a term or a phrase, that is, an instance of FTWords. It must not be an expression. Oracle handles FTMildNot the same way it handles Oracle Text operator MNOT.

- FTOr (`ftor`)
- FTOrder (`ordered`)

Oracle supports the use of FTOrder *only* when used in the context of a window (FTWindow). Otherwise, it is not supported. For example, you can use `ordered window 5 words`, but you cannot use `only ordered` without also `window`. Oracle handles FTOrder the same way it handles Oracle Text operator NEAR with a TRUE value for option ORDER.

- FTUnaryNot (`ftnot`)

FTUnaryNot must be used with FTAnd. You cannot use FTUnaryNot by itself. For example, you can use `ftand ftnot`, but you cannot use `only ftnot` without also `ftand`. Oracle handles FTUnaryNot the same way it handles Oracle Text operator NOT.

- FTWindow (`window`)

Oracle handles FTWindow the same way it handles Oracle Text operator NEAR. You must specify the window size *only* in words, not in sentences or paragraphs (for example, `window 2 paragraphs`), and you must specify it as a numeric constant that is less than or equal to 100.

- FTWords

FTWordsValue must be an XQuery literal string or a SQL bind variable whose value is passed to SQL function `XMLExists` or `XMLQuery` from a SQL expression whose evaluation returns a non-XMLType value.

In addition, FTAnyallOption, if present, must be `any`. That is, FTWords must correspond to a sequence with only one item.

Note:

Even though FTWords corresponds to a sequence of only one item, you can still search for a phrase of multiple words, by using a single string for the entire phrase. So for example, although Oracle XML DB does not support using `{ "found" "necklace" }` for FTWords, you can use `"found necklace"`.

4.8.3.4 Supported XQuery Full Text Match Options

Oracle XML DB supports a subset of the XQuery Full Text match options.

Oracle XML DB supports *only* the following XQuery Full Text match options. Any applicable restrictions are noted. Use of the terms "must" and "must not" means that an error is raised if the specified restriction is not respected. Use of any match options not listed here raises an error.

- FTStemOption (stemming, no stemming)

The default behavior specified in the XQuery and XPath Full Text 1.0 Recommendation is used for each unsupported match option, with the following exceptions:

- FTLanguage (unsupported) – The language used is the language defined by the *default lexer*, which means the language that was used when the database was installed.
- FTStopWordOption (unsupported) – The stoplist used is the stoplist defined for that language.

See Also:

- *Oracle Text Reference* for information about the default lexer
 - *Oracle Text Reference* for information about the stoplist used for each supported language
-
-

4.8.3.5 Unsupported XQuery Full Text Features

The XQuery Full Text features that are not supported by Oracle XML DB are specified.

In addition to all FTSelection operators not mentioned in [Supported XQuery Full Text FTSelection Operators](#) (page 4-29) and all match options not mentioned in [Supported XQuery Full Text Match Options](#) (page 4-30), Oracle XML DB does *not* support the following XQuery Full Text features:

- FTIgnoreOption
- FTWeight (weight declarations, used with FTPrimaryWithOptions)
- FTScoreVar (score variables, used with XQuery ForClause and LetClause or with XPath 2.0 SimpleForClause)

4.8.3.6 XQuery Full Text Errors

Compile-time errors that can be raised when you use XQuery Full Text are described.

A compile-time error is raised whenever you use an XQuery Full Text (XQFT) feature that Oracle does not support.

In addition, compile-time error ORA-18177 is raised whenever you use a supported XQFT expression in a SQL WHERE clause (typically in XMLExists), if you did not create a corresponding XML search index or if that index is not picked up.

See Also:

- [Unsupported XQuery Full Text Features](#) (page 4-31)
 - [Indexing XML Data for Full-Text Queries](#) (page 6-56) for information about creating an XML search index and handling error ORA-18177
 - [Performance Tuning for XQuery](#) (page 5-40) for information about axes other than forward and descendent
 - *Oracle Database SQL Language Reference* for information about SQL built-in data types
-
-

Query and Update of XML Data

There are many ways for applications to query and update XML data that is in Oracle Database, both XML schema-based and non-schema-based.

- [Using XQuery with Oracle XML DB](#) (page 5-1)
- [Querying XML Data Using SQL and PL/SQL](#) (page 5-18)
- [Using the SQL*Plus XQUERY Command](#) (page 5-22)
- [Using XQuery with XQJ to Access Database Data](#) (page 5-23)
- [Using XQuery with PL/SQL, JDBC, and ODP.NET to Access Database Data](#) (page 5-23)
- [Updating XML Data](#) (page 5-27)
- [Performance Tuning for XQuery](#) (page 5-40)

See Also:

- [Overview of How To Use Oracle XML DB](#) (page 3-1) for XMLType storage recommendations
 - [XML Schema Storage and Query: Basic](#) (page 17-1) for how to work with XML schema-based XMLType tables and columns
 - [XQuery and Oracle XML DB](#) (page 4-1) for information about updating XML data using XQuery Update
-

5.1 Using XQuery with Oracle XML DB

XQuery is a very general and expressive language, and SQL/XML functions XMLQuery, XMLTable, XMLEExists, and XMLCast combine that power of expression and computation with the strengths of SQL.

You typically use XQuery with Oracle XML DB in the following ways. The examples here are organized to reflect these different uses.

- Query XML data in Oracle XML DB Repository.
See [Querying XML Data in Oracle XML DB Repository Using XQuery](#) (page 5-3).
- Query a relational table or view as if it were XML data. To do this, you use XQuery function fn:collection, passing as argument a URI that uses the URI-scheme name oradb together with the database location of the data.
See [Querying Relational Data Using XQuery and URI Scheme oradb](#) (page 5-5).

- Query XMLType data, possibly decomposing the resulting XML into relational data using function XMLTable.

See [Querying XMLType Data Using XQuery](#) (page 5-9).

Example 5-1 (page 5-2) creates Oracle XML DB Repository resources that are used in some of the other examples in this chapter.

Example 5-1 Creating Resources for Examples

```

DECLARE
  res BOOLEAN;
  empsxmlstring VARCHAR2(300):=
    '<?xml version="1.0"?>
      <emps>
        <emp empno="1" deptno="10" ename="John" salary="21000"/>
        <emp empno="2" deptno="10" ename="Jack" salary="310000"/>
        <emp empno="3" deptno="20" ename="Jill" salary="100001"/>
      </emps>';
  empsxmlnsstring VARCHAR2(300):=
    '<?xml version="1.0"?>
      <emp xmlns="http://example.com">
        <emp empno="1" deptno="10" ename="John" salary="21000"/>
        <emp empno="2" deptno="10" ename="Jack" salary="310000"/>
        <emp empno="3" deptno="20" ename="Jill" salary="100001"/>
      </emp>';
  deptsxmlstring VARCHAR2(300):=
    '<?xml version="1.0"?>
      <depts>
        <dept deptno="10" dname="Administration"/>
        <dept deptno="20" dname="Marketing"/>
        <dept deptno="30" dname="Purchasing"/>
      </depts>';
BEGIN
  res := DBMS_XDB_REPOS.createResource('/public/emps.xml', empsxmlstring);
  res := DBMS_XDB_REPOS.createResource('/public/empsns.xml', empsxmlnsstring);
  res := DBMS_XDB_REPOS.createResource('/public/depts.xml', deptsxmlstring);
END;
/

```

5.1.1 XQuery Sequences Can Contain Data of Any XQuery Type

XQuery is a general *sequence*-manipulation language. Its expressions and their results are not necessarily XML data. An XQuery sequence can contain items of any XQuery type, which includes numbers, strings, Boolean values, dates, and various types of XML node (document-node(), element(), attribute(), text(), namespace(), and so on).

Example 5-2 (page 5-3) provides a sampling. It applies SQL/XML function XMLQuery to an XQuery sequence that contains items of several different kinds:

- an integer literal: 1
- a arithmetic expression: 2 + 3
- a string literal: "a"
- a sequence of integers: 100 to 102
- a constructed XML element node: <A>33

[Example 5-2](#) (page 5-3) also shows construction of a sequence using the comma operator (,) and parentheses ((),) for grouping.

The sequence expression `100 to 102` evaluates to the sequence (100, 101, 102), so the argument to `XMLQuery` here is a sequence that contains a nested sequence. The sequence argument is automatically flattened, as is always the case for XQuery sequences. The argument is, in effect, (1, 5, "a", 100, 101, 102, <A>33).

Example 5-2 XMLQuery Applied to a Sequence of Items of Different Types

```
SELECT XMLQuery('1, 2 + 3, "a", 100 to 102, <A>33</A>')
      RETURNING CONTENT) AS output
FROM DUAL;
```

OUTPUT

```
-----
1 5 a 100 101 102<A>33</A>
```

1 row selected.

5.1.2 Querying XML Data in Oracle XML DB Repository Using XQuery

Examples are presented that use XQuery with XML data in Oracle XML DB Repository. You use XQuery functions `fn:doc` and `fn:collection` to query file and folder resources in the repository, respectively.

The examples here use XQuery function `fn:doc` to obtain a repository file that contains XML data, and then bind XQuery variables to parts of that data using `for` and `let` FLWOR-expression clauses.

See Also:

[XQuery Functions `fn:doc`, `fn:collection`, and `fn:doc-available`](#) (page 4-28)

[Example 5-3](#) (page 5-3) queries two XML-document resources in Oracle XML DB Repository: `/public/emp.xml` and `/public/depts.xml`. It illustrates the use of `fn:doc` and each of the possible FLWOR-expression clauses.

[Example 5-4](#) (page 5-4) also uses each of the FLWOR-expression clauses. It shows the use of XQuery functions `doc`, `count`, `avg`, and `integer`, which are in the namespace for built-in XQuery functions, `http://www.w3.org/2003/11/xpath-functions`. This namespace is bound to the prefix `fn`.

Example 5-3 FLOWR Expression Using `for`, `let`, `order by`, `where`, and `return`

```
SELECT XMLQuery('for $e in doc("/public/emp.xml")/emp/emp
      let $d :=
        doc("/public/depts.xml")//dept[@deptno = $e/@deptno]/@dname
      where $e/@salary > 100000
      order by $e/@empno
      return <emp ename="{ $e/@ename}" dept="{ $d}"/>'
      RETURNING CONTENT) FROM DUAL;
```

```
XMLQUERY('FOR$EINDOC("/PUBLIC/EMPS.XML")/EMPS/EMPLET$D:=DOC("/PUBLIC/DEPTS.XML")
-----
<emp ename="Jack" dept="Administration"></emp><emp ename="Jill" dept="Marketing"
></emp>
```

1 row selected.

In this example, the various FLWOR clauses perform these operations:

- **for** iterates over the `emp` elements in `/public/emp.xml`, binding variable `$e` to the value of each such element, in turn. That is, it iterates over a general list of employees, binding `$e` to each employee.
- **let** binds variable `$d` to a *sequence* consisting of all of the values of `dname` attributes of those `dept` elements in `/public/emp.xml` whose `deptno` attributes have the same value as the `deptno` attribute of element `$e` (this is a join operation). That is, it binds `$d` to the names of all of the departments that have the same department number as the department of employee `$e`. (It so happens that the `dname` value is unique for each `deptno` value in `depts.xml`.) Unlike `for`, `let` never iterates over values; `$d` is bound only once in this example.
- Together, `for` and `let` produce a stream of tuples (`$e`, `$d`), where `$e` represents an employee and `$d` represents the names of all of the departments to which that employee belongs—in this case, the unique name of the employee's unique department.
- **where** filters this tuple stream, keeping only tuples with employees whose salary is greater than 100,000.
- **order by** sorts the filtered tuple stream by employee number, `empno` (in ascending order, by default).
- **return** constructs `emp` elements, one for each tuple. Attributes `ename` and `dept` of these elements are constructed using attribute `ename` from the input and `$d`, respectively. The element and attribute names `emp` and `ename` in the output have no necessary connection with the same names in the input document `emp.xml`.

Example 5-4 FLOWR Expression Using Built-In Functions

```
SELECT XMLQuery('for $d in fn:doc("/public/depts.xml")/depts/dept/@deptno
let $e := fn:doc("/public/emp.xml")/emp/emp[@deptno = $d]
where fn:count($e) > 1
order by fn:avg($e/@salary) descending
return
  <big-dept>{$d,
    <headcount>{fn:count($e)}</headcount>,
    <avgsal>{xs:integer(fn:avg($e/@salary))}</avgsal>}
  </big-dept>'
RETURNING CONTENT) FROM DUAL;
```

```
XMLQUERY('FOR$DINFN:DOC("/PUBLIC/DEPTS.XML")/DEPTS/DEPT/@DEPTNOLET$E:=FN:DOC("/P
-----
<big-dept deptno="10"><headcount>2</headcount><avgsal>165500</avgsal></big-dept>
```

1 row selected.

In this example, the various FLWOR clauses perform these operations:

- **for** iterates over `deptno` attributes in input document `/public/depts.xml`, binding variable `$d` to the value of each such attribute, in turn.
- **let** binds variable `$e` to a sequence consisting of all of the `emp` elements in input document `/public/emp.xml` whose `deptno` attributes have value `$d` (this is a join operation).

- Together, `for` and `let` produce a stream of tuples ($\$d$, $\$e$), where $\$d$ represents a department number and $\$e$ represents the set of employees in that department.
- **where** filters this tuple stream, keeping only tuples with more than one employee.
- **order by** sorts the filtered tuple stream by average salary in descending order. The average is computed by applying XQuery function `avg` (in namespace `fn`) to the values of attribute `salary`, which is attached to the `emp` elements of $\$e$.
- **return** constructs `big-dept` elements, one for each tuple produced by `order by`. The `text()` node of `big-dept` contains the department number, bound to $\$d$. A `headcount` child element contains the number of employees, bound to $\$e$, as determined by XQuery function `count`. An `avgsal` child element contains the computed average salary.

5.1.3 Querying Relational Data Using XQuery and URI Scheme `oradb`

Examples are presented that use XQuery to query relational table or view data as if it were XML data. The examples use XQuery function `fn:collection`, passing as argument a URI that uses the URI-scheme name `oradb` together with the database location of the data.

[Example 5-5](#) (page 5-6) uses Oracle XQuery function `fn:collection` in a FLWOR expression to query two relational tables, `regions` and `countries`. Both tables belong to sample database schema `HR`. The example also passes scalar SQL value `Asia` to XQuery variable $\$regionname$. Any SQL expression can be evaluated to produce a value passed to XQuery using `PASSING`. In this case, the value comes from a SQL*Plus variable, `REGION`. You must cast the value to the scalar SQL data type expected, in this case, `VARCHAR2(40)`.

In [Example 5-5](#) (page 5-6), the various FLWOR clauses perform these operations:

- **for** iterates over sequences of XML elements returned by calls to `fn:collection`. In the first call, each element corresponds to a row of relational table `hr.regions` and is bound to variable $\$i$. Similarly, in the second call to `fn:collection`, $\$j$ is bound to successive rows of table `hr.countries`. Since `regions` and `countries` are not XMLType tables, the top-level element corresponding to a row in each table is `ROW` (a wrapper element). Iteration over the row elements is unordered.
- **where** filters the rows from both tables, keeping only those pairs of rows whose `region_id` is the same for each table (it performs a join on `region_id`) and whose `region_name` is `Asia`.
- **return** returns the filtered rows from table `hr.countries` as an XML document containing XML fragments with `ROW` as their top-level element.

[Example 5-6](#) (page 5-7) uses `fn:collection` within nested FLWOR expressions to query relational data.

In [Example 5-6](#) (page 5-7), the various FLWOR clauses perform these operations:

- The outer **for** iterates over the sequence of XML elements returned by `fn:collection`: each element corresponds to a row of relational table `oe.warehouses` and is bound to variable $\$i$. Since `warehouses` is not an XMLType table, the top-level element corresponding to a row is `ROW`. The iteration over the row elements is unordered.

- The inner **for** iterates, similarly, over a sequence of XML elements returned by `fn:collection`: each element corresponds to a row of relational table `hr.locations` and is bound to variable `$j`.
- **where** filters the tuples (`$i`, `$j`), keeping only those whose `location_id` child is the same for `$i` and `$j` (it performs a join on `location_id`).
- The inner **return** constructs an XQuery sequence of elements `STREET_ADDRESS`, `CITY`, and `STATE_PROVINCE`, all of which are children of `locations-table` ROW element `$j`; that is, they are the values of the `locations-table` columns of the same name.
- The outer **return** wraps the result of the inner `return` in a `Location` element, and wraps that in a `Warehouse` element. It provides the `Warehouse` element with an `id` attribute whose value comes from the `warehouse_id` column of table `warehouses`.

See Also:

[Example 5-41](#) (page 5-42) for the execution plan of [Example 5-6](#) (page 5-7)

[Example 5-7](#) (page 5-9) uses SQL/XML function `XMLTable` to decompose the result of an XQuery query to produce virtual relational data. The XQuery expression used in this example is identical to the one used in [Example 5-6](#) (page 5-7); the result of evaluating the XQuery expression is a sequence of `Warehouse` elements. Function `XMLTable` produces a virtual relational table whose rows are those `Warehouse` elements. More precisely, in this example the value of pseudocolumn `COLUMN_VALUE` for each virtual-table row is an XML fragment (of type `XMLType`) with a single `Warehouse` element.

See Also:

[Example 5-42](#) (page 5-42) for the execution plan of [Example 5-7](#) (page 5-9)

Example 5-5 Querying Relational Data as XML Using XMLQuery

```
DEFINE REGION = 'Asia'
SELECT XMLQuery('for $i in fn:collection("oradb:HR/REGIONS"),
               $j in fn:collection("oradb:HR/COUNTRIES")
               where $i/ROW/REGION_ID = $j/ROW/REGION_ID
                  and $i/ROW/REGION_NAME = $regionname
               return $j'
           PASSING CAST('&REGION' AS VARCHAR2(40)) AS "regionname"
           RETURNING CONTENT) AS asian_countries

FROM DUAL;
```

This produces the following result. (The result is shown here pretty-printed, for clarity.)

```
ASIAN_COUNTRIES
-----
<ROW>
  <COUNTRY_ID>AU</COUNTRY_ID>
  <COUNTRY_NAME>Australia</COUNTRY_NAME>
  <REGION_ID>3</REGION_ID>
</ROW>
```

```

<ROW>
  <COUNTRY_ID>CN</COUNTRY_ID>
  <COUNTRY_NAME>China</COUNTRY_NAME>
  <REGION_ID>3</REGION_ID>
</ROW>
<ROW>
  <COUNTRY_ID>HK</COUNTRY_ID>
  <COUNTRY_NAME>HongKong</COUNTRY_NAME>
  <REGION_ID>3</REGION_ID>
</ROW>
<ROW>
  <COUNTRY_ID>IN</COUNTRY_ID>
  <COUNTRY_NAME>India</COUNTRY_NAME>
  <REGION_ID>3</REGION_ID>
</ROW>
<ROW>
  <COUNTRY_ID>JP</COUNTRY_ID>
  <COUNTRY_NAME>Japan</COUNTRY_NAME>
  <REGION_ID>3</REGION_ID>
</ROW>
<ROW>
  <COUNTRY_ID>SG</COUNTRY_ID>
  <COUNTRY_NAME>Singapore</COUNTRY_NAME>
  <REGION_ID>3</REGION_ID>
</ROW>

```

1 row selected.

Example 5-6 Querying Relational Data as XML Using a Nested FLWOR Expression

```

CONNECT hr
Enter password: password

Connected.

GRANT SELECT ON LOCATIONS TO oe
/
CONNECT oe
Enter password: password

Connected.

SELECT XMLQuery(
  'for $i in fn:collection("oradb:/OE/WAREHOUSES")/ROW
  return <Warehouse id="{ $i/WAREHOUSE_ID }">
    <Location>
      {for $j in fn:collection("oradb:/HR/LOCATIONS")/ROW
      where $j/LOCATION_ID eq $i/LOCATION_ID
      return ($j/STREET_ADDRESS, $j/CITY, $j/STATE_PROVINCE)}
    </Location>
  </Warehouse>'
  RETURNING CONTENT) FROM DUAL;

```

This query is an example of using nested FLWOR expressions. It accesses relational table `warehouses`, which is in sample database schema `oe`, and relational table `locations`, which is in sample database schema `HR`. To run this example as user `oe`, you must first connect as user `hr` and grant permission to user `oe` to perform `SELECT` operations on table `locations`.

This produces the following result. (The result is shown here pretty-printed, for clarity.)

```
XMLQUERY( 'FOR$IINFN:COLLECTION( "ORADB:/OE/WAREHOUSES" )/ROWRETURN<WAREHOUSEID="{ $
-----
<Warehouse id="1">
  <Location>
    <STREET_ADDRESS>2014 Jabberwocky Rd</STREET_ADDRESS>
    <CITY>Southlake</CITY>
    <STATE_PROVINCE>Texas</STATE_PROVINCE>
  </Location>
</Warehouse>
<Warehouse id="2">
  <Location>
    <STREET_ADDRESS>2011 Interiors Blvd</STREET_ADDRESS>
    <CITY>South San Francisco</CITY>
    <STATE_PROVINCE>California</STATE_PROVINCE>
  </Location>
</Warehouse>
<Warehouse id="3">
  <Location>
    <STREET_ADDRESS>2007 Zagora St</STREET_ADDRESS>
    <CITY>South Brunswick</CITY>
    <STATE_PROVINCE>New Jersey</STATE_PROVINCE>
  </Location>
</Warehouse>
<Warehouse id="4">
  <Location>
    <STREET_ADDRESS>2004 Charade Rd</STREET_ADDRESS>
    <CITY>Seattle</CITY>
    <STATE_PROVINCE>Washington</STATE_PROVINCE>
  </Location>
</Warehouse>
<Warehouse id="5">
  <Location>
    <STREET_ADDRESS>147 Spadina Ave</STREET_ADDRESS>
    <CITY>Toronto</CITY>
    <STATE_PROVINCE>Ontario</STATE_PROVINCE>
  </Location>
</Warehouse>
<Warehouse id="6">
  <Location>
    <STREET_ADDRESS>12-98 Victoria Street</STREET_ADDRESS>
    <CITY>Sydney</CITY>
    <STATE_PROVINCE>New South Wales</STATE_PROVINCE>
  </Location>
</Warehouse>
<Warehouse id="7">
  <Location>
    <STREET_ADDRESS>Mariano Escobedo 9991</STREET_ADDRESS>
    <CITY>Mexico City</CITY>
    <STATE_PROVINCE>Distrito Federal,</STATE_PROVINCE>
  </Location>
</Warehouse>
<Warehouse id="8">
  <Location>
    <STREET_ADDRESS>40-5-12 Laogianggen</STREET_ADDRESS>
    <CITY>Beijing</CITY>
  </Location>
</Warehouse>
<Warehouse id="9">
  <Location>
    <STREET_ADDRESS>1298 Vileparle (E)</STREET_ADDRESS>
    <CITY>Bombay</CITY>
```

```

    <STATE_PROVINCE>Maharashtra</STATE_PROVINCE>
  </Location>
</Warehouse>

```

1 row selected.

Example 5-7 Querying Relational Data as XML Using XMLTable

```

SELECT *
FROM XMLTable(
  'for $i in fn:collection("oradb:/OE/WAREHOUSES")/ROW
  return <Warehouse id="{ $i/WAREHOUSE_ID }">
    <Location>
      {for $j in fn:collection("oradb:/HR/LOCATIONS")/ROW
       where $j/LOCATION_ID eq $i/LOCATION_ID
       return ($j/STREET_ADDRESS, $j/CITY, $j/STATE_PROVINCE)}
    </Location>
  </Warehouse>' );

```

This produces the same result as [Example 5-6](#) (page 5-7), except that each Warehouse element is output as a separate row, instead of all Warehouse elements being output together in a single row.

```

COLUMN_VALUE
-----
<Warehouse id="1">
  <Location>
    <STREET_ADDRESS>2014 Jabberwocky Rd</STREET_ADDRESS>
    <CITY>Southlake</CITY>
    <STATE_PROVINCE>Texas</STATE_PROVINCE>
  </Location>
</Warehouse>
<Warehouse id="2">
  <Location>
    <STREET_ADDRESS>2011 Interiors Blvd</STREET_ADDRESS>
    <CITY>South San Francisco</CITY>
    <STATE_PROVINCE>California</STATE_PROVINCE>
  </Location>
</Warehouse>
. . .

9 rows selected.

```

5.1.4 Querying XMLType Data Using XQuery

Examples are presented that use XQuery to query XMLType data.

The query in [Example 5-8](#) (page 5-12) passes an XMLType column, `warehouse_spec`, as *context* item to XQuery, using function `XMLQuery` with the `PASSING` clause. It constructs a `Details` element for each of the warehouses whose area is greater than 80,000: `/Warehouse/Area > 80000`.

In [Example 5-8](#) (page 5-12), function `XMLQuery` is applied to the `warehouse_spec` column in each row of table `warehouses`. The various FLWOR clauses perform these operations:

- **for** iterates over the Warehouse elements in each row of column `warehouse_spec` (the passed context item): each such element is bound to variable `$i`, in turn. The iteration is unordered.

- **where** filters the Warehouse elements, keeping only those whose Area child has a value greater than 80,000.
- **return** constructs an XQuery sequence of Details elements, each of which contains a Docks and a Rail child elements. The num attribute of the constructed Docks element is set to the text () value of the Docks child of Warehouse. The text () content of Rail is set to true or false, depending on the value of the RailAccess attribute of element Warehouse.

The SELECT statement in [Example 5-8](#) (page 5-12) applies to each row in table warehouses. The XMLQuery expression returns the *empty sequence* for those rows that do not match the XQuery expression. Only the warehouses in New Jersey and Seattle satisfy the XQuery query, so they are the only warehouses for which <Details>...</Details> is returned.

[Example 5-9](#) (page 5-13) uses SQL/XML function XMLTable to query an XMLType table, oe.purchaseorder, which contains XML Schema-based data. It uses the PASSING clause to provide the purchaseorder table as the context item for the XQuery-expression argument to XMLTable. Pseudocolumn COLUMN_VALUE of the resulting virtual table holds a constructed element, A10po, which contains the Reference information for those purchase orders whose CostCenter element has value A10 and whose User element has value SMCCAIN. The query performs a join between the virtual table and database table purchaseorder.

The PASSING clause of function XMLTable passes the OBJECT_VALUE of XMLType table purchaseorder, to serve as the XPath context. The XMLTable expression thus *depends* on the purchaseorder table. Because of this, table purchaseorder must appear *before* the XMLTable expression in the FROM list. This is a general requirement in any situation involving data dependence.

Note:

Whenever a PASSING clause refers to a column of an XMLType table in a query, that table *must appear before* the XMLTable expression in the query FROM list. This is because the XMLTable expression *depends* on the XMLType table — a *left lateral* (correlated) join is needed, to ensure a one-to-many (1:N) relationship between the XMLType table row accessed and the rows generated from it by XMLTable.

[Example 5-10](#) (page 5-13) is similar to [Example 5-9](#) (page 5-13) in its effect. It uses XMLQuery, instead of XMLTable, to query oe.purchaseorder. These two examples differ in their treatment of the empty sequences returned by the XQuery expression. In [Example 5-9](#) (page 5-13), these empty sequences are not joined with the purchaseorder table, so the overall SQL-query result set has only ten rows. In [Example 5-10](#) (page 5-13), these empty sequences are part of the overall result set of the SQL query, which contains 132 rows, one for each of the rows in table purchaseorder. All but ten of those rows are empty, and show up in the output as empty lines. To save space here, those empty lines have been removed.

See Also:

[Example 5-43](#) (page 5-43) for the execution plan of [Example 5-10](#) (page 5-13)

[Example 5-11](#) (page 5-13) uses `XMLTable` clauses `PASSING` and `COLUMNS`. The XQuery expression iterates over top-level `PurchaseOrder` elements, constructing a `PO` element for each purchase order with cost center `A10`. The resulting `PO` elements are then passed to `XMLTable` for processing.

In [Example 5-11](#) (page 5-13), data from the children of `PurchaseOrder` is used to construct the children of `PO`, which are `Ref`, `Type`, and `Name`. The content of `Type` is taken from the content of `/PurchaseOrder/SpecialInstructions`, but the classes of `SpecialInstructions` are divided up differently for `Type`.

Function `XMLTable` breaks up the result of XQuery evaluation, returning it as three `VARCHAR2` columns of a virtual table: `poref`, `priority`, and `contact`. The `DEFAULT` clause is used to supply a default `priority` of `Regular`.

[Example 5-11](#) (page 5-13) does not use the clause `RETURNING SEQUENCE BY REF`, which means that the XQuery sequence returned and then used by the `COLUMNS` clause is passed by *value*, not by reference. That is, a copy of the targeted nodes is returned, not a reference to the actual nodes.

When the returned sequence is passed by value, the columns specified in a `COLUMNS` clause cannot refer to any data that is not in that returned copy. In particular, they cannot refer to data that *precedes* the targeted nodes in the source data.

To be able to refer to an arbitrary part of the source data from column specifications in a `COLUMNS` clause, you need to use the clause `RETURNING SEQUENCE BY REF`, which causes the sequence resulting from the XQuery expression to be returned by *reference*.

[Example 5-12](#) (page 5-14) shows the use of clause `RETURNING SEQUENCE BY REF`, which allows column *reference* to refer to a node that is outside the nodes targeted by the XQuery expression. Because the sequence of `LineItem` nodes is returned by reference, the code has access to the complete tree of nodes, so it can navigate upward and then back down to node `Reference`.

Clause `RETURNING SEQUENCE BY REF` lets you specify that the result of evaluating the top-level XQuery expression used to generate rows for `XMLTable` be returned by reference. The same kind of choice is available for the result of evaluating a `PATH` expression in a `COLUMNS` clause. To specify that such a result be returned by reference you use `XMLType (SEQUENCE) BY REF` as the column data type.

[Example 5-13](#) (page 5-15) illustrates this. It chains together two `XMLTable` tables, `t1` and `t2`, returning XML data from the source document by reference:

- For column *reference* of the top-level table, `t1`, because it corresponds to a node outside element `LineItem` (just as in [Example 5-12](#) (page 5-14))
- For column *part* of table `t1`, because it is passed to table `t2`, whose column `item` targets data outside node `Part`

In table `t1`, the type used for column `part` is `XMLType (SEQUENCE) BY REF`, so that the `part` data is a reference to the source data targeted by its `PATH` expression, `LineItem/Part`. This is needed because the `PATH` expression for column `item` in table `t2` targets attribute `ItemNumber` of the parent of element `Part`, `LineItem`. Without specifying that `part` is a reference, it would be a copy of just the `Part` element, so that using `PATH` expression `../@ItemNumber` would raise an error.

[Example 5-14](#) (page 5-15) uses SQL/XML function `XMLTable` to break up the XML data in an `XMLType` collection element, `LineItem`, into separate columns of a virtual table.

See Also:

- [Example 5-44](#) (page 5-44) for the execution plan of [Example 5-14](#) (page 5-15)
- [Creating a Relational View over XML: Mapping XML Nodes to Columns](#) (page 9-2), for an example of applying `XMLTable` to multiple document levels (multilevel chaining)

Example 5-8 Querying an XMLType Column Using XMLQuery PASSING Clause

```
SELECT warehouse_name,
       XMLQuery(
         'for $i in /Warehouse
         where $i/Area > 80000
         return <Details>
           <Docks num="{ $i/Docks }"/>
           <Rail>{if ( $i/RailAccess = "Y" ) then "true" else "false"}
         </Rail>
         </Details>'
         PASSING warehouse_spec RETURNING CONTENT) big_warehouses
FROM oe.warehouses;
```

This produces the following output:

```
WAREHOUSE_NAME
-----
BIG_WAREHOUSES
-----
Southlake, Texas

San Francisco

New Jersey
<Details><Docks num=" "></Docks><Rail>>false</Rail></Details>

Seattle, Washington
<Details><Docks num="3"></Docks><Rail>>true</Rail></Details>

Toronto

Sydney

Mexico City

Beijing

Bombay

9 rows selected.
```

Example 5-9 Using XMLTABLE with XML Schema-Based Data

```
SELECT xtab.COLUMN_VALUE
      FROM purchaseorder, XMLTable('for $i in /PurchaseOrder
                                   where $i/CostCenter eq "A10"
                                   and $i/User eq "SMCCAIN"
                                   return <A10po pono="{ $i/Reference}"/>'
                                   PASSING OBJECT_VALUE) xtab;
```

```
COLUMN_VALUE
-----
<A10po pono="SMCCAIN-20021009123336151PDT"></A10po>
<A10po pono="SMCCAIN-20021009123336341PDT"></A10po>
<A10po pono="SMCCAIN-20021009123337173PDT"></A10po>
<A10po pono="SMCCAIN-20021009123335681PDT"></A10po>
<A10po pono="SMCCAIN-20021009123335470PDT"></A10po>
<A10po pono="SMCCAIN-20021009123336972PDT"></A10po>
<A10po pono="SMCCAIN-20021009123336842PDT"></A10po>
<A10po pono="SMCCAIN-20021009123336512PDT"></A10po>
<A10po pono="SMCCAIN-2002100912333894PDT"></A10po>
<A10po pono="SMCCAIN-20021009123337403PDT"></A10po>
```

10 rows selected.

Example 5-10 Using XMLQUERY with XML Schema-Based Data

```
SELECT XMLQuery('for $i in /PurchaseOrder
                 where $i/CostCenter eq "A10"
                 and $i/User eq "SMCCAIN"
                 return <A10po pono="{ $i/Reference}"/>'
                 PASSING OBJECT_VALUE
                 RETURNING CONTENT)
      FROM purchaseorder;
```

```
XMLQUERY('FOR$IIN/PURCHASEORDERWHERE$I/COSTCENTEREQ"A10"AND$I/USEREQ"SMCCAIN"RET
```

```
-----
<A10po pono="SMCCAIN-20021009123336151PDT"></A10po>
<A10po pono="SMCCAIN-20021009123336341PDT"></A10po>
<A10po pono="SMCCAIN-20021009123337173PDT"></A10po>
<A10po pono="SMCCAIN-20021009123335681PDT"></A10po>
<A10po pono="SMCCAIN-20021009123335470PDT"></A10po>
<A10po pono="SMCCAIN-20021009123336972PDT"></A10po>
<A10po pono="SMCCAIN-20021009123336842PDT"></A10po>
<A10po pono="SMCCAIN-20021009123336512PDT"></A10po>
<A10po pono="SMCCAIN-2002100912333894PDT"></A10po>
<A10po pono="SMCCAIN-20021009123337403PDT"></A10po>
```

132 rows selected.

Example 5-11 Using XMLTABLE with PASSING and COLUMNS Clauses

```
SELECT xtab.poref, xtab.priority, xtab.contact
      FROM purchaseorder,
           XMLTable('for $i in /PurchaseOrder
                     let $spl := $i/SpecialInstructions
                     where $i/CostCenter eq "A10"
                     return <PO>
                               <Ref>{ $i/Reference}</Ref>
                               {if ($spl eq "Next Day Air" or $spl eq "Expedite") then
                                 <Type>Fastest</Type>
                               else if ($spl eq "Air Mail") then
                                 <Type>Fast</Type>
                               }') xtab;
```

```

        else ()
        <Name>{$i/Requestor}</Name>
    </PO>'
PASSING OBJECT_VALUE
COLUMNS poref    VARCHAR2(20) PATH 'Ref',
         priority VARCHAR2(8)  PATH 'Type' DEFAULT 'Regular',
         contact  VARCHAR2(20) PATH 'Name') xtab;

```

POREF	PRIORITY	CONTACT
SKING-20021009123336	Fastest	Steven A. King
SMCCAIN-200210091233	Regular	Samuel B. McCain
SMCCAIN-200210091233	Fastest	Samuel B. McCain
JCHEN-20021009123337	Fastest	John Z. Chen
JCHEN-20021009123337	Regular	John Z. Chen
SKING-20021009123337	Regular	Steven A. King
SMCCAIN-200210091233	Regular	Samuel B. McCain
JCHEN-20021009123338	Regular	John Z. Chen
SMCCAIN-200210091233	Regular	Samuel B. McCain
SKING-20021009123335	Regular	Steven X. King
SMCCAIN-200210091233	Regular	Samuel B. McCain
SKING-20021009123336	Regular	Steven A. King
SMCCAIN-200210091233	Fast	Samuel B. McCain
SKING-20021009123336	Fastest	Steven A. King
SKING-20021009123336	Fastest	Steven A. King
SMCCAIN-200210091233	Regular	Samuel B. McCain
JCHEN-20021009123335	Regular	John Z. Chen
SKING-20021009123336	Regular	Steven A. King
JCHEN-20021009123336	Regular	John Z. Chen
SKING-20021009123336	Regular	Steven A. King
SMCCAIN-200210091233	Regular	Samuel B. McCain
SKING-20021009123337	Regular	Steven A. King
SKING-20021009123338	Fastest	Steven A. King
SMCCAIN-200210091233	Regular	Samuel B. McCain
JCHEN-20021009123337	Regular	John Z. Chen
JCHEN-20021009123337	Regular	John Z. Chen
JCHEN-20021009123337	Regular	John Z. Chen
SKING-20021009123337	Regular	Steven A. King
JCHEN-20021009123337	Regular	John Z. Chen
SKING-20021009123337	Regular	Steven A. King
SKING-20021009123337	Regular	Steven A. King
SMCCAIN-200210091233	Fast	Samuel B. McCain

32 rows selected.

Example 5-12 Using XMLTABLE with RETURNING SEQUENCE BY REF

```

SELECT t.*
   FROM purchaseorder,
        XMLTable('/PurchaseOrder/LineItems/LineItem' PASSING OBJECT_VALUE
                RETURNING SEQUENCE BY REF
                COLUMNS reference  VARCHAR2(30) PATH '../..//Reference',
                        item        VARCHAR2(4)  PATH '@ItemNumber',
                        description  VARCHAR2(45) PATH 'Description') t
 WHERE item = 5;

```

REFERENCE	ITEM	DESCRIPTION
AMCEWEN-20021009123336171PDT	5	Coup De Torchon (Clean Slate)
AMCEWEN-20021009123336271PDT	5	The Unbearable Lightness Of Being
PTUCKER-20021009123336191PDT	5	The Scarlet Empress

```

PTUCKER-20021009123336291PDT    5    The Unbearable Lightness Of Being
SBELL-20021009123336231PDT     5    Black Narcissus
SBELL-20021009123336331PDT     5    Fishing With John 1 -3
SKING-20021009123336321PDT     5    The Red Shoes
SMCCAIN-20021009123336151PDT    5    Wages of Fear
SMCCAIN-20021009123336341PDT    5    The Most Dangerous Game
VJONES-20021009123336301PDT     5    Le Trou

```

10 rows selected.

Example 5-13 Using Chained XMLTABLE with Access by Reference

```

SELECT t1.reference, t2.id, t2.item
FROM purchaseorder,
XMLTable('/PurchaseOrder/LineItems' PASSING OBJECT_VALUE
RETURNING SEQUENCE BY REF
COLUMNS part XMLType (SEQUENCE) BY REF PATH 'LineItem/Part',
reference VARCHAR2(30) PATH '../Reference') t1,
XMLTable('.') PASSING t1.part
RETURNING SEQUENCE BY REF
COLUMNS id VARCHAR2(12) PATH '@Id',
item NUMBER PATH '@ItemNumber') t2;

```

Example 5-14 Using XMLTABLE to Decompose XML Collection Elements into Relational Data

```

SELECT lines.lineitem, lines.description, lines.partid,
lines.unitprice, lines.quantity
FROM purchaseorder,
XMLTable('for $i in /PurchaseOrder/LineItems/LineItem
where $i/@ItemNumber >= 8
and $i/Part/@UnitPrice > 50
and $i/Part/@Quantity > 2
return $i'
PASSING OBJECT_VALUE
COLUMNS lineitem NUMBER PATH '@ItemNumber',
description VARCHAR2(30) PATH 'Description',
partid NUMBER PATH 'Part/@Id',
unitprice NUMBER PATH 'Part/@UnitPrice',
quantity NUMBER PATH 'Part/@Quantity') lines;

```

LINEITEM	DESCRIPTION	PARTID	UNITPRICE	QUANTITY
11	Orphic Trilogy	37429148327	80	3
22	Dreyer Box Set	37429158425	80	4
11	Dreyer Box Set	37429158425	80	3
16	Dreyer Box Set	37429158425	80	3
8	Dreyer Box Set	37429158425	80	3
12	Brazil	37429138526	60	3
18	Eisenstein: The Sound Years	37429149126	80	4
24	Dreyer Box Set	37429158425	80	3
14	Dreyer Box Set	37429158425	80	4
10	Brazil	37429138526	60	3
17	Eisenstein: The Sound Years	37429149126	80	3
16	Orphic Trilogy	37429148327	80	4
13	Orphic Trilogy	37429148327	80	4
10	Brazil	37429138526	60	4
12	Eisenstein: The Sound Years	37429149126	80	3
12	Dreyer Box Set	37429158425	80	4
13	Dreyer Box Set	37429158425	80	4

17 rows selected.

5.1.5 Using Namespaces with XQuery

You can use the XQuery `declare namespace` declaration in the prolog of an XQuery expression to define a namespace prefix. You can use `declare default namespace` to establish the namespace as the default namespace for the expression.

Note:

Be aware of the following pitfall, if you use SQL*Plus: If the semicolon (;) at the end of a namespace declaration terminates a line, SQL*Plus interprets it as a SQL terminator. To avoid this, you can do one of the following:

- Place the text that follows the semicolon on the same line.
 - Place a comment, such as (`: :`), after the semicolon, on the same line.
 - Turn off the recognition of the SQL terminator with SQL*Plus command `SET SQLTERMINATOR`.
-
-

[Example 5-15](#) (page 5-16) illustrates use of a namespace declaration in an XQuery expression.

An XQuery namespace declaration has no effect outside of its XQuery expression. To declare a namespace prefix for use in an `XMLTable` expression outside of the XQuery expression, use the `XMLNAMESPACES` clause. This clause also covers the XQuery expression argument to `XMLTable`, eliminating the need for a separate declaration in the XQuery prolog.

In [Example 5-16](#) (page 5-17), `XMLNAMESPACES` is used to define the prefix `e` for the namespace `http://example.com`. This namespace is used in the `COLUMNS` clause and the XQuery expression of the `XMLTable` expression.

Example 5-15 Using XMLQUERY with a Namespace Declaration

```
SELECT XMLQuery('declare namespace e = "http://example.com";
ERROR:
ORA-01756: quoted string not properly terminated

      for $i in doc("/public/empns.xml")/e:emps/e:emp
SP2-0734: unknown command beginning "for $i in ..." - rest of line ignored.
...

-- This works - do not end the line with ";".
SELECT XMLQuery('declare namespace e = "http://example.com"; for
      $i in doc("/public/empns.xml")/e:emps/e:emp
      let $d :=
      doc("/public/depts.xml")//dept[@deptno=$i/@deptno]/@dname
      where $i/@salary > 100000
      order by $i/@empno
      return <emp ename="{ $i/@ename}" dept="{ $d}" />'
RETURNING CONTENT) FROM DUAL;

XMLQUERY('DECLARENAMESPACEE="HTTP://EXAMPLE.COM";FOR$IINDOC('/PUBLIC/EMPSNS.XML"
-----
<emp ename="Jack" dept=""></emp><emp ename="Jill" dept=""></emp>

-- This works too - add a comment after the ";".
SELECT XMLQuery('declare namespace e = "http://example.com"; (: :)
```

```

for $i in doc("/public/empns.xml")/e:emps/e:emp
let $d := doc("/public/depts.xml")//dept[@deptno=$i/@deptno]/@dname
where $i/@salary > 100000
order by $i/@empno
return <emp ename="{ $i/@ename}" dept="{ $d}"/>'
RETURNING CONTENT) FROM DUAL;

```

```

XMLQUERY('DECLARENAMESPACEE="HTTP://EXAMPLE.COM";(:: )FOR$IINDOC("/PUBLIC/EMPSNS.
-----
<emp ename="Jack" dept=""></emp><emp ename="Jill" dept=""></emp>

```

1 row selected.

-- This works too - tell SQL*Plus to ignore the ";".

SET SQLTERMINATOR OFF

```

SELECT XMLQuery('declare namespace e = "http://example.com";
for $i in doc("/public/empns.xml")/e:emps/e:emp
let $d :=
doc("/public/depts.xml")//dept[@deptno=$i/@deptno]/@dname
where $i/@salary > 100000
order by $i/@empno
return <emp ename="{ $i/@ename}" dept="{ $d}"/>'
RETURNING CONTENT) FROM DUAL

```

/

```

XMLQUERY('DECLARENAMESPACEE="HTTP://EXAMPLE.COM";FOR$IINDOC("/PUBLIC/EMPSNS.XML"
-----
<emp ename="Jack" dept=""></emp><emp ename="Jill" dept=""></emp>

```

Example 5-16 Using XMLTABLE with the XMLNAMESPACES Clause

```

SELECT * FROM XMLTable(XMLNAMESPACES ('http://example.com' AS "e"),
'for $i in doc("/public/empns.xml")
return $i/e:emps/e:emp'
COLUMNS name VARCHAR2(6) PATH '@ename',
id NUMBER PATH '@empno');

```

This produces the following result:

NAME	ID
John	1
Jack	2
Jill	3

3 rows selected.

It is the presence of qualified names `e:ename` and `e:empno` in the `COLUMNS` clause that necessitates using the `XMLNAMESPACES` clause. Otherwise, a prolog namespace declaration (`declare namespace e = "http://example.com"`) would suffice for the XQuery expression itself.

Because the same namespace is used throughout the `XMLTable` expression, a default namespace could be used: `XMLNAMESPACES (DEFAULT 'http://example.com')`. The qualified name `$i/e:emps/e:emp` could then be written without an explicit prefix: `$i/emp/emp`.

5.2 Querying XML Data Using SQL and PL/SQL

You can query XML data from XMLType columns and tables in various ways.

- Select XMLType data using SQL, PL/SQL, or Java.
- Query XMLType data using SQL/XML functions such as XMLQuery. See [Querying XMLType Data Using XQuery](#) (page 5-9).
- Perform full-text search using XQuery Full Text. See [Support for XQuery Full Text](#) (page 4-28) and [Indexes for XMLType Data](#) (page 6-1).

The examples in this section illustrate different ways you can use SQL and PL/SQL to query XML data. [Example 5-17](#) (page 5-18) inserts two rows into table `purchaseorder`, then queries data in those rows using SQL/XML functions `XMLCast`, `XMLQuery`, and `XMLExists`.

[Example 5-18](#) (page 5-19) uses a PL/SQL cursor to query XML data. It uses a local XMLType instance to store transient data.

[Example 5-19](#) (page 5-20) and [Example 5-20](#) (page 5-21) both use SQL/XML function `XMLTable` to extract data from an XML purchase-order document. They then insert that data into a relational table. [Example 5-19](#) (page 5-20) uses SQL; [Example 5-20](#) (page 5-21) uses PL/SQL.

[Example 5-20](#) (page 5-21) defines and uses a PL/SQL procedure to extract data from an XML purchase-order document and insert it into a relational table.

[Example 5-21](#) (page 5-21) tabulates the purchase orders whose shipping address contains the string "Shores" and which were requested by customers whose names contain the string "ll" (double L). These purchase orders are grouped by customer and counted. The example uses XQuery Full Text to perform full-text search.

[Example 5-22](#) (page 5-22) extracts the fragments of a document that are identified by an XPath expression. The XMLType instance returned by `XMLQuery` can be a set of nodes, a singleton node, or a text value. [Example 5-22](#) (page 5-22) uses XMLType method `isFragment()` to determine whether the result is a fragment.

Note:

You cannot insert fragments into XMLType columns. You can use SQL/XML function `XMLQuery` to convert a fragment into a well-formed document.

Example 5-17 Querying XMLTYPE Data

```
INSERT INTO purchaseorder
VALUES (XMLType(bfilename('XMLDIR', 'SMCCAIN-2002091213000000PDT.xml'),
               nls_charset_id('AL32UTF8')));

INSERT INTO purchaseorder
VALUES (XMLType(bfilename('XMLDIR', 'VJONES-2002091614000000PDT.xml'),
               nls_charset_id('AL32UTF8')));

SELECT XMLCast(XMLQuery('$p/PurchaseOrder/Reference'
                       PASSING po.OBJECT_VALUE AS "p" RETURNING CONTENT)
           AS VARCHAR2(30)) reference,
       XMLCast(XMLQuery('$p/PurchaseOrder/*/User'
                       PASSING po.OBJECT_VALUE AS "p" RETURNING CONTENT)
           AS VARCHAR2(30)) userid,
```



```

CASE
  WHEN XMLEExists('$p/PurchaseOrder/Reject/Date'
    PASSING po.OBJECT_VALUE AS "p")
  THEN 'Rejected'
  ELSE 'Accepted'
END "STATUS",
XMLCast(XMLQuery('$p//Date'
  PASSING po.OBJECT_VALUE AS "p" RETURNING CONTENT)
  AS VARCHAR2(12)) status_date
FROM purchaseorder po
WHERE XMLEExists('$p//Date' PASSING po.OBJECT_VALUE AS "p")
ORDER BY XMLCast(XMLQuery('$p//Date' PASSING po.OBJECT_VALUE AS "p"
  RETURNING CONTENT)
  AS VARCHAR2(12));

```

REFERENCE	USERID	STATUS	STATUS_DATE
VJONES-2002091614000000PDT	SVOLLMAN	Accepted	2002-10-11
SMCCAIN-2002091213000000PDT	SKING	Rejected	2002-10-12

2 rows selected.

Example 5-18 Querying Transient XMLTYPE Data Using a PL/SQL Cursor

```

DECLARE
  xNode XMLType;
  vText VARCHAR2(256);
  vReference VARCHAR2(32);
  CURSOR getPurchaseOrder(reference IN VARCHAR2) IS
    SELECT OBJECT_VALUE XML
    FROM purchaseorder
    WHERE XMLEExists('$p/PurchaseOrder[Reference=$r]'
      PASSING OBJECT_VALUE AS "p",
      reference AS "r");
BEGIN
  vReference := 'EABEL-20021009123335791PDT';
  FOR c IN getPurchaseOrder(vReference) LOOP
    xNode := c.XML.extract('//Requestor');
    SELECT XMLSerialize(CONTENT
      XMLQuery('//text()' PASSING xNode RETURNING CONTENT))
    INTO vText FROM DUAL;
    DBMS_OUTPUT.put_line('The Requestor for Reference '
      || vReference || ' is ' || vText);
  END LOOP;
  vReference := 'PTUCKER-20021009123335430PDT';
  FOR c IN getPurchaseOrder(vReference) LOOP
    xNode := c.XML.extract('//LineItem[@ItemNumber="1"]/Description');
    SELECT XMLSerialize(CONTENT
      XMLQuery('//text()' PASSING xNode RETURNING CONTENT))
    INTO vText FROM DUAL;
    DBMS_OUTPUT.put_line('The Description of LineItem[1] for Reference '
      || vReference || ' is ' || vText);
  END LOOP;
END;
/
The Requestor for Reference EABEL-20021009123335791PDT is Ellen S. Abel
The Description of LineItem[1] for Reference PTUCKER-20021009123335430PDT is
Picnic at
Hanging Rock

```

PL/SQL procedure successfully completed.

Example 5-19 Extracting XML Data and Inserting It into a Relational Table Using SQL

```

CREATE TABLE purchaseorder_table (reference          VARCHAR2(28) PRIMARY KEY,
                                   requestor         VARCHAR2(48),
                                   actions            XMLType,
                                   userid             VARCHAR2(32),
                                   costcenter          VARCHAR2(3),
                                   shiptoname         VARCHAR2(48),
                                   address             VARCHAR2(512),
                                   phone              VARCHAR2(32),
                                   rejectedby         VARCHAR2(32),
                                   daterejected       DATE,
                                   comments            VARCHAR2(2048),
                                   specialinstructions VARCHAR2(2048));

CREATE TABLE purchaseorder_lineitem (reference,
                                       FOREIGN KEY ("REFERENCE")
                                       REFERENCES "PURCHASEORDER_TABLE" ("REFERENCE") ON DELETE CASCADE,
                                       lineno          NUMBER(10), PRIMARY KEY ("REFERENCE", "LINENO"),
                                       upc            VARCHAR2(14),
                                       description    VARCHAR2(128),
                                       quantity       NUMBER(10),
                                       unitprice      NUMBER(12,2));

INSERT INTO purchaseorder_table (reference, requestor, actions, userid, costcenter, shiptoname, address,
                                phone, rejectedby, daterejected, comments, specialinstructions)
SELECT t.reference, t.requestor, t.actions, t.userid, t.costcenter, t.shiptoname, t.address,
       t.phone, t.rejectedby, t.daterejected, t.comments, t.specialinstructions
FROM purchaseorder p,
     XMLTable('/PurchaseOrder' PASSING p.OBJECT_VALUE
              COLUMNS reference VARCHAR2(28) PATH 'Reference',
                       requestor VARCHAR2(48) PATH 'Requestor',
                       actions XMLType PATH 'Actions',
                       userid VARCHAR2(32) PATH 'User',
                       costcenter VARCHAR2(3) PATH 'CostCenter',
                       shiptoname VARCHAR2(48) PATH 'ShippingInstructions/name',
                       address VARCHAR2(512) PATH 'ShippingInstructions/address',
                       phone VARCHAR2(32) PATH 'ShippingInstructions/telephone',
                       rejectedby VARCHAR2(32) PATH 'Reject/User',
                       daterejected DATE PATH 'Reject/Date',
                       comments VARCHAR2(2048) PATH 'Reject/Comments',
                       specialinstructions VARCHAR2(2048) PATH 'SpecialInstructions') t
WHERE t.reference = 'EABEL-20021009123336251PDT';

INSERT INTO purchaseorder_lineitem (reference, lineno, upc, description, quantity, unitprice)
SELECT t.reference, li.lineno, li.upc, li.description, li.quantity, li.unitprice
FROM purchaseorder p,
     XMLTable('/PurchaseOrder' PASSING p.OBJECT_VALUE
              COLUMNS reference VARCHAR2(28) PATH 'Reference',
                       lineitem XMLType PATH 'LineItems/LineItem') t,
     XMLTable('LineItem' PASSING t.lineitem
              COLUMNS lineno NUMBER(10) PATH '@ItemNumber',
                       upc VARCHAR2(14) PATH 'Part/@Id',
                       description VARCHAR2(128) PATH 'Description',
                       quantity NUMBER(10) PATH 'Part/@Quantity',
                       unitprice NUMBER(12,2) PATH 'Part/@UnitPrice') li
WHERE t.reference = 'EABEL-20021009123336251PDT';

SELECT reference, userid, shiptoname, specialinstructions FROM purchaseorder_table;

REFERENCE          USERID  SHIPTONAME          SPECIALINSTRUCTIONS
-----
EABEL-20021009123336251PDT  EABEL  Ellen S. Abel      Counter to Counter

```

```
SELECT reference, lineno, upc, description, quantity FROM purchaseorder_lineitem;
```

REFERENCE	LINENO	UPC	DESCRIPTION	QUANTITY
EABEL-20021009123336251PDT	1	37429125526	Samurai 2: Duel at Ichijoji Temple	3
EABEL-20021009123336251PDT	2	37429128220	The Red Shoes	4
EABEL-20021009123336251PDT	3	715515009058	A Night to Remember	1

Example 5-20 Extracting XML Data and Inserting It into a Table Using PL/SQL

```
CREATE OR REPLACE PROCEDURE insertPurchaseOrder(purchaseorder XMLType) AS reference VARCHAR2(28);
BEGIN
  INSERT INTO purchaseorder_table (reference, requestor, actions, userid, costcenter, shiptoname, address,
    phone, rejectedby, daterejected, comments, specialinstructions)
  SELECT * FROM XMLTable('$p/PurchaseOrder' PASSING purchaseorder AS "p"
    COLUMNS reference VARCHAR2(28) PATH 'Reference',
      requestor VARCHAR2(48) PATH 'Requestor',
      actions XMLType PATH 'Actions',
      userid VARCHAR2(32) PATH 'User',
      costcenter VARCHAR2(3) PATH 'CostCenter',
      shiptoname VARCHAR2(48) PATH 'ShippingInstructions/name',
      address VARCHAR2(512) PATH 'ShippingInstructions/address',
      phone VARCHAR2(32) PATH 'ShippingInstructions/telephone',
      rejectedby VARCHAR2(32) PATH 'Reject/User',
      daterejected DATE PATH 'Reject/Date',
      comments VARCHAR2(2048) PATH 'Reject/Comments',
      specialinstructions VARCHAR2(2048) PATH 'SpecialInstructions');

  INSERT INTO purchaseorder_lineitem (reference, lineno, upc, description, quantity, unitprice)
  SELECT t.reference, li.lineno, li.upc, li.description, li.quantity, li.unitprice
  FROM XMLTable('$p/PurchaseOrder' PASSING purchaseorder AS "p"
    COLUMNS reference VARCHAR2(28) PATH 'Reference',
      lineitem XMLType PATH 'LineItems/LineItem') t,
  XMLTable('LineItem' PASSING t.lineitem
    COLUMNS lineno NUMBER(10) PATH '@ItemNumber',
      upc VARCHAR2(14) PATH 'Part/@Id',
      description VARCHAR2(128) PATH 'Description',
      quantity NUMBER(10) PATH 'Part/@Quantity',
      unitprice NUMBER(12,2) PATH 'Part/@UnitPrice') li;

END;

CALL insertPurchaseOrder(XMLType(bfilename('XMLDIR', 'purchaseOrder.xml'), nls_charset_id('AL32UTF8')));
```

```
SELECT reference, userid, shiptoname, specialinstructions FROM purchaseorder_table;
```

REFERENCE	USERID	SHIPTONAME	SPECIALINSTRUCTIONS
SBELL-2002100912333601PDT	SBELL	Sarah J. Bell	Air Mail

```
SELECT reference, lineno, upc, description, quantity FROM purchaseorder_lineitem;
```

REFERENCE	LINENO	UPC	DESCRIPTION	QUANTITY
SBELL-2002100912333601PDT	1	715515009058	A Night to Remember	2
SBELL-2002100912333601PDT	2	37429140222	The Unbearable Lightness Of Being	2
SBELL-2002100912333601PDT	3	715515011020	Sisters	4

Example 5-21 Searching XML Data Using SQL/XML Functions

```
SELECT XMLCast(XMLQuery('$p/PurchaseOrder/Requestor'
  PASSING po.OBJECT_VALUE AS "p" RETURNING CONTENT)
  AS VARCHAR2(128)) name,
  count(*)
FROM purchaseorder po
WHERE
  XMlexists(
    'declare namespace ora="http://xmlns.oracle.com/xdb"; (: :)
```

```

        $p/PurchaseOrder/ShippingInstructions[address/text() contains text "Shores"]'
        PASSING po.OBJECT_VALUE AS "p")
    AND XMLCast(XMLQuery('$p/PurchaseOrder/Requestor/text()'
        PASSING po.OBJECT_VALUE AS "p" RETURNING CONTENT)
        AS VARCHAR2(128))
        LIKE '%11%'
    GROUP BY XMLCast(XMLQuery('$p/PurchaseOrder/Requestor'
        PASSING po.OBJECT_VALUE AS "p" RETURNING CONTENT)
        AS VARCHAR2(128));

```

NAME	COUNT(*)
-----	-----
Allan D. McEwen	9
Ellen S. Abel	4
Sarah J. Bell	13
William M. Smith	7

Example 5-22 Extracting Fragments Using XMLQUERY

```

SELECT XMLCast(XMLQuery('$p/PurchaseOrder/Reference' PASSING po.OBJECT_VALUE AS "p"
        RETURNING CONTENT)
        AS VARCHAR2(30)) reference,
        count(*)
FROM purchaseorder po, XMLTable('$p//LineItem[Part/@Id="37429148327"]' PASSING OBJECT_VALUE AS "p")
WHERE XMLQuery('$p/PurchaseOrder/LineItems/LineItem[Part/@Id="37429148327"]'
        PASSING po.OBJECT_VALUE AS "p" RETURNING CONTENT).isFragment() = 1
GROUP BY XMLCast(XMLQuery('$p/PurchaseOrder/Reference' PASSING po.OBJECT_VALUE AS "p" RETURNING CONTENT)
        AS VARCHAR2(30))
ORDER BY XMLCast(XMLQuery('$p/PurchaseOrder/Reference' PASSING po.OBJECT_VALUE AS "p" RETURNING CONTENT)
        AS VARCHAR2(30));

```

REFERENCE	COUNT(*)
-----	-----
TFOX-20021009123337784PDT	3

5.3 Using the SQL*Plus XQUERY Command

You can evaluate an XQuery expression using the SQL*Plus XQUERY command.

[Example 5-23](#) (page 5-22) shows how you can enter an XQuery expression directly at the SQL*Plus command line, by preceding the expression with the SQL*Plus command **XQUERY** and following it with a slash (/) on a line by itself. Oracle Database treats XQuery expressions submitted with this command the same way it treats XQuery expressions in SQL/XML functions XMLQuery and XMLTable. Execution is identical, with the same optimizations.

There are also a few SQL*Plus SET commands that you can use for settings that are specific to XQuery. Use SHOW XQUERY to see the current settings.

- **SET XQUERY BASEURI** – Set the base URI for XQUERY. URIs in XQuery expressions are relative to this URI.
- **SET XQUERY CONTEXT** – Specify a context item for subsequent XQUERY evaluations.

See Also:

*SQL*Plus User's Guide and Reference*

Example 5-23 Using the SQL*Plus XQUERY Command

```

SQL> XQUERY for $i in fn:collection("oradb:/HR/DEPARTMENTS")
      2 where $i/ROW/DEPARTMENT_ID < 50

```

```

3 return $i
4 /

```

Result Sequence

```

-----
<ROW><DEPARTMENT_ID>10</DEPARTMENT_ID><DEPARTMENT_NAME>Administration</DEPARTMEN
T_NAME><MANAGER_ID>200</MANAGER_ID><LOCATION_ID>1700</LOCATION_ID></ROW>

```

```

<ROW><DEPARTMENT_ID>20</DEPARTMENT_ID><DEPARTMENT_NAME>Marketing</DEPARTMENT_NAM
E><MANAGER_ID>201</MANAGER_ID><LOCATION_ID>1800</LOCATION_ID></ROW>

```

```

<ROW><DEPARTMENT_ID>30</DEPARTMENT_ID><DEPARTMENT_NAME>Purchasing</DEPARTMENT_NA
ME><MANAGER_ID>114</MANAGER_ID><LOCATION_ID>1700</LOCATION_ID></ROW>

```

```

<ROW><DEPARTMENT_ID>40</DEPARTMENT_ID><DEPARTMENT_NAME>Human Resources</DEPARTME
NT_NAME><MANAGER_ID>203</MANAGER_ID><LOCATION_ID>2400</LOCATION_ID></ROW>

```

5.4 Using XQuery with XQJ to Access Database Data

XQuery API for Java (XQJ), also known as JSR-225, provides an industry-standard way for Java programs to access XML data using XQuery. It lets you evaluate XQuery expressions against XML data sources and process the results as XML data.

Oracle provides two XQuery engines for evaluating XQuery expressions: one in Oracle XML DB, for use with XML data in the database, and one in Oracle XML Developer's Kit, for use with XML data outside the database.

Similarly, Oracle provides two mid-tier XQJ implementations for accessing these two XQuery engines. Both implementations are part of Oracle XML Developer's Kit (XDK). You use XDK to access XML data with XQJ, regardless of whether that data resides in the database or elsewhere.

In particular, you can use XDK and XQJ to access XML data in Oracle XML DB. A typical use case for this feature is to access data stored in remote databases from a local Java program.

See Also:

- XQuery API for Java (XQJ) 1.0 Specification, March 2009, <https://jcp.org/aboutjava/communityprocess/final/jsr225/index.html>

This specification is quite concrete and helpful, with understandable examples.

- *Oracle XML Developer's Kit Programmer's Guide* for complete information about using XQJ with Oracle XML Developer's Kit
 - *Oracle XML Developer's Kit Programmer's Guide* for information, including examples, about using XQJ with XDK to access XML data in the database
-

5.5 Using XQuery with PL/SQL, JDBC, and ODP.NET to Access Database Data

You can use XQuery with the Oracle APIs for PL/SQL, JDBC, and Oracle Data Provider for .NET (ODP.NET).

Example 5-24 (page 5-24) shows how to use XQuery with PL/SQL, in particular, how to bind *dynamic variables* to an XQuery expression using the XMLQuery PASSING

clause. The bind variables `:1` and `:2` are bound to the PL/SQL bind arguments `nbitems` and `partid`, respectively. These are then passed to XQuery as XQuery variables `itemno` and `id`, respectively.

[Example 5-25](#) (page 5-25) shows how to use XQuery with JDBC, binding variables by position with the `PASSING` clause of SQL/XML function `XMLTable`.

[Example 5-26](#) (page 5-26) shows how to use XQuery with ODP.NET and the C# language. The C# input parameters `:nbitems` and `:partid` are passed to XQuery as XQuery variables `itemno` and `id`, respectively.

See Also:

- [PL/SQL APIs for XMLType](#) (page 11-1)
 - [Java DOM API for XMLType](#) (page 13-1)
 - [Oracle XML DB and Oracle Data Provider for .NET](#) (page 15-1)
-
-

Example 5-24 Using XQuery with PL/SQL

```

DECLARE
  sql_stmt VARCHAR2(2000); -- Dynamic SQL statement to execute
  nbitems  NUMBER := 3; -- Number of items
  partid   VARCHAR2(20) := '715515009058'; -- Part ID
  result   XMLType;
  doc      DBMS_XMLDOM.DOMDocument;
  ndoc     DBMS_XMLDOM.DOMNode;
  buf      VARCHAR2(20000);
BEGIN
  sql_stmt :=
    'SELECT XMLQuery(
      ''for $i in fn:collection("oradb:/OE/PURCHASEORDER") ' ||
      ''where count($i/PurchaseOrder/LineItems/LineItem) = $itemno ' ||
      ''and $i/PurchaseOrder/LineItems/LineItem/Part/@Id = $id ' ||
      ''return $i/PurchaseOrder/LineItems'' ' ||
      ''PASSING :1 AS "itemno", :2 AS "id" ' ||
      ''RETURNING CONTENT) FROM DUAL';

  EXECUTE IMMEDIATE sql_stmt INTO result USING nbitems, partid;
  doc := DBMS_XMLDOM.newDOMDocument(result);
  ndoc := DBMS_XMLDOM.makeNode(doc);
  DBMS_XMLDOM.writeToBuffer(ndoc, buf);
  DBMS_OUTPUT.put_line(buf);
END;
/

```

This produces the following output:

```

<LineItems>
  <LineItem ItemNumber="1">
    <Description>Samurai 2: Duel at Ichijoji Temple</Description>
    <Part Id="37429125526" UnitPrice="29.95" Quantity="3"/>
  </LineItem>
  <LineItem ItemNumber="2">
    <Description>The Red Shoes</Description>
    <Part Id="37429128220" UnitPrice="39.95" Quantity="4"/>
  </LineItem>
  <LineItem ItemNumber="3">

```

```

        <Description>A Night to Remember</Description>
        <Part Id="715515009058" UnitPrice="39.95" Quantity="1"/>
    </LineItem>
</LineItems>
<LineItems>
    <LineItem ItemNumber="1">
        <Description>A Night to Remember</Description>
        <Part Id="715515009058" UnitPrice="39.95" Quantity="2"/>
    </LineItem>
    <LineItem ItemNumber="2">
        <Description>The Unbearable Lightness Of Being</Description>
        <Part Id="37429140222" UnitPrice="29.95" Quantity="2"/>
    </LineItem>
    <LineItem ItemNumber="3">
        <Description>Sisters</Description>
        <Part Id="715515011020" UnitPrice="29.95" Quantity="4"/>
    </LineItem>
</LineItems>

```

PL/SQL procedure successfully completed.

Example 5-25 Using XQuery with JDBC

```

import java.sql.*;
import oracle.sql.*;
import oracle.jdbc.*;
import oracle.xdb.XMLType;
import java.util.*;

public class QueryBindByPos
{
    public static void main(String[] args) throws Exception, SQLException
    {
        System.out.println("*** JDBC Access of XQuery using Bind Variables ***");
        DriverManager.registerDriver(new oracle.jdbc.driver.OracleDriver());
        OracleConnection conn
            = (OracleConnection)
                DriverManager.getConnection("jdbc:oracle:oci8:@localhost:1521:orallgr1", "oe", "oe");
        String xqString
            = "SELECT COLUMN_VALUE " +
                "FROM XMLTable('for $i in fn:collection(\"oradb:/OE/PURCHASEORDER\") " +
                    "where $i/PurchaseOrder/Reference= $ref " +
                    "return $i/PurchaseOrder/LineItems' " +
                    "PASSING ? AS \"ref\")";
        OraclePreparedStatement stmt = (OraclePreparedStatement)conn.prepareStatement(xqString);
        String refString = "EABEL-20021009123336251PDT"; // Set the filter value
        stmt.setString(1, refString); // Bind the string
        ResultSet rs = stmt.executeQuery();
        while (rs.next())
        {
            SQLXML sqlXml = rs.getSQLXML(1);
            System.out.println("LineItem Description: " + sqlXml.getString());
            sqlXml.free();
        }
        rs.close();
        stmt.close();
    }
}

```

This produces the following output:

```
*** JDBC Access of Database XQuery with Bind Variables ***
LineItem Description: Samurai 2: Duel at Ichijoji Temple
LineItem Description: The Red Shoes
LineItem Description: A Night to Remember
```

Example 5-26 Using XQuery with ODP.NET and C#

```
using System;
using System.Data;
using System.Text;
using System.IO;
using System.Xml;
using Oracle.DataAccess.Client;
using Oracle.DataAccess.Types;

namespace XQuery
{
    /// <summary>
    /// Demonstrates how to bind variables for XQuery calls
    /// </summary>
    class XQuery
    {
        /// <summary>
        /// The main entry point for the application.
        /// </summary>
        static void Main(string[] args)
        {
            int rows = 0;
            StreamReader sr = null;

            // Create the connection.
            string constr = "User Id=oe;Password=*****;Data Source=orallgr2"; // Replace with real password.
            OracleConnection con = new OracleConnection(constr);
            con.Open();

            // Create the command.
            OracleCommand cmd = new OracleCommand("", con);

            // Set the XML command type to query.
            cmd.CommandType = CommandType.Text;

            // Create the SQL query with the XQuery expression.
            StringBuilder blr = new StringBuilder();
            blr.Append("SELECT COLUMN_VALUE FROM XMLTable");
            blr.Append("(\'for $i in fn:collection(\\"oradb:/OE/PURCHASEORDER\\") \");");
            blr.Append("  where count($i/PurchaseOrder/LineItems/LineItem) = $itemno ");
            blr.Append("    and $i/PurchaseOrder/LineItems/LineItem/Part/@Id = $id ");
            blr.Append("    return $i/PurchaseOrder/LineItems\' ");
            blr.Append("  PASSING :nbitems AS \\'itemno\\', :partid AS \\'id\\'");

            cmd.CommandText = blr.ToString();
            cmd.Parameters.Add(":nbitems", OracleDbType.Int16, 3, ParameterDirection.Input);
            cmd.Parameters.Add(":partid", OracleDbType.Varchar2, "715515009058", ParameterDirection.Input);

            // Get the XML document as an XmlReader.
            OracleDataReader dr = cmd.ExecuteReader();
            dr.Read();

            // Get the XMLType column as an OracleXmlType
            OracleXmlType xml = dr.GetOracleXmlType(0);

            // Print the XML data in the OracleXmlType object
            Console.WriteLine(xml.Value);
            xml.Dispose();

            // Clean up.
            cmd.Dispose();
            con.Close();
        }
    }
}
```



```

        con.Dispose();
    }
}
}

```

This produces the following output:

```

<LineItems>
  <LineItem ItemNumber="1">
    <Description>Samurai 2: Duel at Ichijoji Temple</Description>
    <Part Id="37429125526" UnitPrice="29.95" Quantity="3"/>
  </LineItem>
  <LineItem ItemNumber="2">
    <Description>The Red Shoes</Description>
    <Part Id="37429128220" UnitPrice="39.95" Quantity="4"/>
  </LineItem>
  <LineItem ItemNumber="3">
    <Description>A Night to Remember</Description>
    <Part Id="715515009058" UnitPrice="39.95" Quantity="1"/>
  </LineItem>
</LineItems>

```

5.6 Updating XML Data

There are several ways you can use Oracle XML DB features to update XML data, whether it is transient or stored in database tables.

5.6.1 Updating an Entire XML Document

To update an entire XML document, use a SQL UPDATE statement.

The right side of the UPDATE statement SET clause must be an XMLType instance. This can be created in any of the following ways:

- Use SQL functions or XML constructors that return an XML instance.
- Use the PL/SQL DOM APIs for XMLType that change and bind an existing XML instance.
- Use the Java DOM API that changes and binds an existing XML instance.

Updates for non-schema-based documents stored as binary XML can be made in a piecewise manner.

[Example 5-27](#) (page 5-27) updates an XMLType instance using a SQL UPDATE statement.

Example 5-27 Updating XMLType Data Using SQL UPDATE

```

SELECT t.reference, li.lineno, li.description
FROM purchaseorder po,
XMLTable('$p/PurchaseOrder' PASSING po.OBJECT_VALUE AS "p"
COLUMNS reference VARCHAR2(28) PATH 'Reference',
lineitem XMLType PATH 'LineItems/LineItem') t,
XMLTable('$l/LineItem' PASSING t.lineitem AS "l"
COLUMNS lineno NUMBER(10) PATH '@ItemNumber',
description VARCHAR2(128) PATH 'Description') li
WHERE t.reference = 'DAUSTIN-20021009123335811PDT' AND ROWNUM < 6;

```

REFERENCE	LINENO	DESCRIPTION
DAUSTIN-20021009123335811PDT	1	Nights of Cabiria
DAUSTIN-20021009123335811PDT	2	For All Mankind
DAUSTIN-20021009123335811PDT	3	Dead Ringers

```
DAUSTIN-20021009123335811PDT      4 Hearts and Minds
DAUSTIN-20021009123335811PDT      5 Rushmore
```

```
UPDATE purchaseorder po
  SET po.OBJECT_VALUE = XMLType(bfilename('XMLDIR','NEW-DAUSTIN-20021009123335811PDT.xml'),
                                nls_charset_id('AL32UTF8'))
  WHERE XMLExists('$p/PurchaseOrder[Reference="DAUSTIN-20021009123335811PDT"]'
                 PASSING po.OBJECT_VALUE AS "p");
```

```
SELECT t.reference, li.lineno, li.description
  FROM purchaseorder po,
       XMLTable('$p/PurchaseOrder' PASSING po.OBJECT_VALUE AS "p"
                COLUMNS reference VARCHAR2(28) PATH 'Reference',
                lineitem XMLType      PATH 'LineItems/LineItem') t,
       XMLTable('$l/LineItem' PASSING t.lineitem AS "l"
                COLUMNS lineno      NUMBER(10)  PATH '@ItemNumber',
                description VARCHAR2(128) PATH 'Description') li
  WHERE t.reference = 'DAUSTIN-20021009123335811PDT';
```

REFERENCE	LINENO	DESCRIPTION
DAUSTIN-20021009123335811PDT	1	Dead Ringers
DAUSTIN-20021009123335811PDT	2	Getrud
DAUSTIN-20021009123335811PDT	3	Branded to Kill

5.6.2 Replacing XML Nodes

You can use XQuery Update with a SQL UPDATE statement to update an existing XML document instead of creating a new document. The entire document is updated, not just the part of it that is selected.

In [Example 5-28](#) (page 5-29) we pass the SQL string literal **'SKING'** to the XQuery expression as a variable (`$p2`). In this simple example, since the value is a string literal, we could have simply used `replace value of node $j with "SKING"`. That is, you can just use a literal XQuery string here, instead of passing a literal string from SQL to XQuery. In real-world examples you will typically pass a value that is available only at runtime; [Example 5-28](#) (page 5-29) shows how to do that. This is also true of other examples.

[Example 5-29](#) (page 5-29) updates multiple text nodes and attribute nodes.

[Example 5-30](#) (page 5-30) updates selected nodes within a collection.

[Example 5-31](#) (page 5-32) illustrates the common mistake of using an XQuery Update `replace-value` operation to update a *node that occurs multiple times* in a collection. The UPDATE statement sets the value of the text node of a `Description` element to `The Wizard of Oz`, where the current value of the text node is `Sisters`. The statement includes an `XMLExists` expression in the WHERE clause that identifies the set of nodes to be updated.

Instead of updating only the intended node, [Example 5-31](#) (page 5-32) updates the values of *all* text nodes that belong to the `Description` element. This is not what was intended.

A WHERE clause can be used only to identify which documents must be updated, not which nodes within a document must be updated.

After the document has been selected, the XQuery expression passed to XQuery Update determines which nodes within the document must be updated. In this case, the XQuery expression identifies all three `Description` nodes, so all three of the associated text nodes were updated.

To correctly update a node that occurs multiple times within a collection, use the XQuery expression passed XQuery Update to identify which nodes in the XML document to update. By introducing the appropriate predicate into the XQuery expression, you can limit which nodes in the document are updated. [Example 5-32](#) (page 5-32) illustrates the correct way to update one node within a collection.

Example 5-28 Updating XMLTYPE Data Using SQL UPDATE and XQuery Update

```
SELECT XMLQuery('$p/PurchaseOrder/Actions/Action[1]' PASSING po.OBJECT_VALUE AS "p"
              RETURNING CONTENT) action
FROM purchaseorder po
WHERE XMLExists('$p/PurchaseOrder[Reference="SBELL-2002100912333601PDT"]'
              PASSING po.OBJECT_VALUE AS "p");
```

ACTION

```
-----
<Action>
  <User>SVOLLMAN</User>
</Action>
```

```
UPDATE purchaseorder po
SET po.OBJECT_VALUE =
  XMLQuery('copy $i := $p1 modify
          (for $j in $i/PurchaseOrder/Actions/Action[1]/User
           return replace value of node $j with $p2)
          return $i' PASSING po.OBJECT_VALUE AS "p1",
          'SKING' AS "p2" RETURNING CONTENT)
WHERE XMLExists('$p/PurchaseOrder[Reference="SBELL-2002100912333601PDT"]'
              PASSING po.OBJECT_VALUE AS "p");
```

```
SELECT XMLQuery('$p/PurchaseOrder/Actions/Action[1]' PASSING po.OBJECT_VALUE AS "p"
              RETURNING CONTENT) action
FROM purchaseorder po
WHERE XMLExists('$p/PurchaseOrder[Reference="SBELL-2002100912333601PDT"]'
              PASSING po.OBJECT_VALUE AS "p");
```

ACTION

```
-----
<Action>
  <User>SKING</User>
</Action>
```

Example 5-29 Updating Multiple Text Nodes and Attribute Nodes

```
SELECT XMLCast(XMLQuery('$p/PurchaseOrder/Requestor'
                      PASSING po.OBJECT_VALUE AS "p" RETURNING CONTENT)
          AS VARCHAR2(30)) name,
XMLQuery('$p/PurchaseOrder/LineItems'
          PASSING po.OBJECT_VALUE AS "p" RETURNING CONTENT) lineitems
FROM purchaseorder po
WHERE XMLExists('$p/PurchaseOrder[Reference="SBELL-2002100912333601PDT"]'
              PASSING po.OBJECT_VALUE AS "p");
```

NAME

LINEITEMS

```
-----
Sarah J. Bell  <LineItems>
               <LineItem ItemNumber="1">
                 <Description>A Night to Remember</Description>
                 <Part Id="715515009058" UnitPrice="39.95" Quantity="2"/>
               </LineItem>
               <LineItem ItemNumber="2">
                 <Description>The Unbearable Lightness Of Being</Description>
                 <Part Id="37429140222" UnitPrice="29.95" Quantity="2"/>
               </LineItem>
```

```

    <LineItem ItemNumber="3">
      <Description>Sisters</Description>
      <Part Id="715515011020" UnitPrice="29.95" Quantity="4"/>
    </LineItem>
  </LineItems>

```

```

UPDATE purchaseorder
SET OBJECT_VALUE =
  XMLQuery('copy $i := $p1 modify
    ((for $j in $i/PurchaseOrder/Requestor
      return replace value of node $j with $p2),
    (for $j in $i/PurchaseOrder/LineItems/LineItem[1]/Part/@Id
      return replace value of node $j with $p3),
    (for $j in $i/PurchaseOrder/LineItems/LineItem[1]/Description
      return replace value of node $j with $p4),
    (for $j in $i/PurchaseOrder/LineItems/LineItem[3]
      return replace node $j with $p5))
  return $i'
  PASSING OBJECT_VALUE AS "p1",
    'Stephen G. King' AS "p2",
    '786936150421' AS "p3",
    'The Rock' AS "p4",
    XMLType('<LineItem ItemNumber="99">
      <Description>Dead Ringers</Description>
      <Part Id="715515009249" UnitPrice="39.95" Quantity="2"/>
    </LineItem>') AS "p5"
  RETURNING CONTENT)
WHERE XMLEExists('$p/PurchaseOrder[Reference="SBELL-2002100912333601PDT"]')
  PASSING OBJECT_VALUE AS "p");

SELECT XMLCast(XMLQuery('$p/PurchaseOrder/Requestor'
  PASSING po.OBJECT_VALUE AS "p" RETURNING CONTENT)
  AS VARCHAR2(30)) name,
  XMLQuery('$p/PurchaseOrder/LineItems'
  PASSING po.OBJECT_VALUE AS "p" RETURNING CONTENT) lineitems
FROM purchaseorder po
WHERE XMLEExists('$p/PurchaseOrder[Reference="SBELL-2002100912333601PDT"]')
  PASSING po.OBJECT_VALUE AS "p");

```

```

NAME          LINEITEMS
-----
Stephen G. King <LineItems>
                <LineItem ItemNumber="1">
                  <Description>The Rock</Description>
                  <Part Id="786936150421" UnitPrice="39.95" Quantity="2"/>
                </LineItem>
                <LineItem ItemNumber="2">
                  <Description>The Unbearable Lightness Of Being</Description>
                  <Part Id="37429140222" UnitPrice="29.95" Quantity="2"/>
                </LineItem>
                <LineItem ItemNumber="99">
                  <Description>Dead Ringers</Description>
                  <Part Id="715515009249" UnitPrice="39.95" Quantity="2"/>
                </LineItem>
                </LineItems>

```

Example 5-30 Updating Selected Nodes within a Collection

```

SELECT XMLCast(XMLQuery('$p/PurchaseOrder/Requestor'
  PASSING po.OBJECT_VALUE AS "p" RETURNING CONTENT)
  AS VARCHAR2(30)) name,
  XMLQuery('$p/PurchaseOrder/LineItems'
  PASSING po.OBJECT_VALUE AS "p" RETURNING CONTENT) lineitems
FROM purchaseorder po
WHERE XMLEExists('$p/PurchaseOrder[Reference="SBELL-2002100912333601PDT"]')
  PASSING po.OBJECT_VALUE AS "p");

```

```

NAME          LINEITEMS

```

```

-----
Sarah J. Bell <LineItems>
  <LineItem ItemNumber="1">
    <Description>A Night to Remember</Description>
    <Part Id="715515009058" UnitPrice="39.95" Quantity="2"/>
  </LineItem>
  <LineItem ItemNumber="2">
    <Description>The Unbearable Lightness Of Being</Description>
    <Part Id="37429140222" UnitPrice="29.95" Quantity="2"/>
  </LineItem>
  <LineItem ItemNumber="3">
    <Description>Sisters</Description>
    <Part Id="715515011020" UnitPrice="29.95" Quantity="4"/>
  </LineItem>
</LineItems>

```

```

UPDATE purchaseorder
SET OBJECT_VALUE =
XMLQuery(
'copy $i := $p1 modify
  ((for $j in $i/PurchaseOrder/Requestor
    return replace value of node $j with $p2),
  (for $j in $i/PurchaseOrder/LineItems/LineItem/Part[@Id="715515009058"]/@Quantity
    return replace value of node $j with $p3),
  (for $j in $i/PurchaseOrder/LineItems/LineItem
    [Description/text()="The Unbearable Lightness Of Being"]
    return replace node $j with $p4))
return $i'
PASSING OBJECT_VALUE AS "p1",
  'Stephen G. King' AS "p2",
  25 AS "p3",
  XMLType('<LineItem ItemNumber="99">
  <Part Id="786936150421" Quantity="5" UnitPrice="29.95"/>
  <Description>The Rock</Description>
</LineItem>') AS "p4"
RETURNING CONTENT)
WHERE XMLExists('$p/PurchaseOrder[Reference="SBELL-2002100912333601PDT"]'
  PASSING OBJECT_VALUE AS "p");

SELECT XMLCast(XMLQuery('$p/PurchaseOrder/Requestor'
  PASSING po.OBJECT_VALUE AS "p" RETURNING CONTENT)
  AS VARCHAR2(30)) name,
XMLQuery('$p/PurchaseOrder/LineItems'
  PASSING po.OBJECT_VALUE AS "p" RETURNING CONTENT) lineitems
FROM purchaseorder po
WHERE XMLExists('$p/PurchaseOrder[Reference="SBELL-2002100912333601PDT"]'
  PASSING po.OBJECT_VALUE AS "p");

```

```

NAME          LINEITEMS
-----

```

```

Stephen G. King <LineItems>
  <LineItem ItemNumber="1">
    <Description>A Night to Remember</Description>
    <Part Id="715515009058" UnitPrice="39.95" Quantity="25"/>
  </LineItem>
  <LineItem ItemNumber="99">
    <Part Id="786936150421" Quantity="5" UnitPrice="29.95"/>
    <Description>The Rock</Description>
  </LineItem>
  <LineItem ItemNumber="3">
    <Description>Sisters</Description>

```

```

    <Part Id="715515011020" UnitPrice="29.95" Quantity="4"/>
  </LineItem>
</LineItems>

```

Example 5-31 *Incorrectly Updating a Node That Occurs Multiple Times in a Collection*

```

SELECT XMLCast(des.COLUMN_VALUE AS VARCHAR2(256))
  FROM purchaseorder,
       XMLTable('$p/PurchaseOrder/LineItems/LineItem/Description'
                PASSING OBJECT_VALUE AS "p") des
 WHERE XMLEExists('$p/PurchaseOrder[Reference="SBELL-2002100912333601PDT"]'
                 PASSING OBJECT_VALUE AS "p");

XMLCAST(DES.COLUMN_VALUEASVARCHAR2(256))
-----
The Lady Vanishes
The Unbearable Lightness Of Being
Sisters

3 rows selected.

UPDATE purchaseorder
  SET OBJECT_VALUE =
      XMLQuery('copy $i := $p1 modify
              (for $j in $i/PurchaseOrder/LineItems/LineItem/Description
               return replace value of node $j with $p2)
              return $i'
              PASSING OBJECT_VALUE AS "p1", 'The Wizard of Oz' AS "p2"
              RETURNING CONTENT)
 WHERE XMLEExists('$p/PurchaseOrder/LineItems/LineItem[Description="Sisters"]'
                 PASSING OBJECT_VALUE AS "p")
        AND XMLEExists('$p/PurchaseOrder[Reference="SBELL-2002100912333601PDT"]'
                       PASSING OBJECT_VALUE AS "p");

```

1 row updated.

```

SELECT XMLCast(des.COLUMN_VALUE AS VARCHAR2(256))
  FROM purchaseorder,
       XMLTable('$p/PurchaseOrder/LineItems/LineItem/Description'
                PASSING OBJECT_VALUE AS "p") des
 WHERE XMLEExists('$p/PurchaseOrder[Reference="SBELL-2002100912333601PDT"]'
                 PASSING OBJECT_VALUE AS "p");

```

```

XMLCAST(DES.COLUMN_VALUEASVARCHAR2(256))
-----

```

```

The Wizard of Oz
The Wizard of Oz
The Wizard of Oz

```

3 rows selected.

Example 5-32 *Correctly Updating a Node That Occurs Multiple Times in a Collection*

```

SELECT XMLCast(des.COLUMN_VALUE AS VARCHAR2(256))
  FROM purchaseorder,
       XMLTable('$p/PurchaseOrder/LineItems/LineItem/Description'
                PASSING OBJECT_VALUE AS "p") des
 WHERE XMLEExists('$p/PurchaseOrder[Reference="SBELL-2002100912333601PDT"]'
                 PASSING OBJECT_VALUE AS "p");

```

```

XMLCAST(DES.COLUMN_VALUEASVARCHAR2(256))
-----

A Night to Remember
The Unbearable Lightness Of Being
Sisters

3 rows selected.

UPDATE purchaseorder
SET OBJECT_VALUE =
    XMLQuery('copy $i := $p1 modify
              (for $j in $i/PurchaseOrder/LineItems/LineItem/Description
                [text()="Sisters"]
              return replace value of node $j with $p2)
            return $i'
            PASSING OBJECT_VALUE AS "p1",
                  'The Wizard of Oz' AS "p2" RETURNING CONTENT)
WHERE XMLElementExists('$p/PurchaseOrder[Reference="SBELL-2002100912333601PDT"]'
                       PASSING OBJECT_VALUE AS "p");

1 row updated.

SELECT XMLCast(des.COLUMN_VALUE AS VARCHAR2(256))
FROM purchaseorder,
     XMLTable('$p/PurchaseOrder/LineItems/LineItem/Description'
              PASSING OBJECT_VALUE AS "p") des
WHERE XMLElementExists('$p/PurchaseOrder[Reference="SBELL-2002100912333601PDT"]'
                       PASSING OBJECT_VALUE AS "p");

```

```

XMLCAST(DES.COLUMN_VALUEASVARCHAR2(256))
-----

```

```

A Night to Remember
The Unbearable Lightness Of Being
The Wizard of Oz

```

```

3 rows selected.

```

5.6.2.1 Updating XML Data to NULL Values

Certain considerations apply to updating XML data to NULL values.

- If you update an XML *element* to NULL, the attributes and children of the element are removed, and the element becomes empty. The type and namespace properties of the element are retained. See [Example 5-33](#) (page 5-34).
- If you update an *attribute* value to NULL, the value appears as the empty string. See [Example 5-33](#) (page 5-34).
- If you update the *text* node of an element to NULL, the content (text) of the element is removed. The element itself remains, but it is empty. See [Example 5-34](#) (page 5-35).

[Example 5-33](#) (page 5-34) updates all of the following to NULL:

- The `Description` element and the `Quantity` attribute of the `LineItem` element whose `Part` element has attribute `Id` value 715515009058.

- The `LineItem` element whose `Description` element has the content (text) "The Unbearable Lightness Of Being".

[Example 5-33](#) (page 5-34) shows two different but equivalent ways to remove the value of a node. For element `Description` and attribute `Quantity`, a literal XQuery empty sequence, `()`, replaces the existing value directly. For element `LineItem`, SQL `NULL` is passed into the XQuery expression to provide the empty node value. Since the value used is literal, it is simpler not to pass it from SQL to XQuery. But in real-world examples you will often pass a value that is available only at runtime. [Example 5-33](#) (page 5-34) shows how to do this for an empty XQuery sequence: pass a SQL `NULL` value.

[Example 5-34](#) (page 5-35) updates the text node of a `Part` element whose `Description` attribute has value "A Night to Remember" to `NULL`. The XML data for this example corresponds to a different, revised purchase-order XML schema – see [Scenario for Copy-Based Evolution](#) (page 20-2). In that XML schema, `Description` is an attribute of the `Part` element, not a sibling element.

See Also:

[Example 3-26](#) (page 3-25)

Example 5-33 NULL Updates – Element and Attribute

```
SELECT XMLCast(XMLQuery('$p/PurchaseOrder/Requestor'
                      PASSING po.OBJECT_VALUE AS "p" RETURNING CONTENT)
          AS VARCHAR2(30)) name,
       XMLQuery('$p/PurchaseOrder/LineItems'
               PASSING po.OBJECT_VALUE AS "p" RETURNING CONTENT) lineitems
FROM purchaseorder po
WHERE XMLExists('$p/PurchaseOrder[Reference="SBELL-2002100912333601PDT"]'
               PASSING po.OBJECT_VALUE AS "p");
```

NAME	LINEITEMS
Sarah J. Bell	<pre><LineItems> <LineItem ItemNumber="1"> <Description>A Night to Remember</Description> <Part Id="715515009058" UnitPrice="39.95" Quantity="2"/> </LineItem> <LineItem ItemNumber="2"> <Description>The Unbearable Lightness Of Being</Description> <Part Id="37429140222" UnitPrice="29.95" Quantity="2"/> </LineItem> <LineItem ItemNumber="3"> <Description>Sisters</Description> <Part Id="715515011020" UnitPrice="29.95" Quantity="4"/> </LineItem> </LineItems></pre>

```
UPDATE purchaseorder
SET OBJECT_VALUE =
XMLQuery(
'copy $i := $pl modify
  ((for $j in $i/PurchaseOrder/LineItems/LineItem[Part/@Id="715515009058"]/Description
   return replace value of node $j with ()) ,
  (for $j in $i/PurchaseOrder/LineItems/LineItem/Part[@Id="715515009058"]/@Quantity
   return replace value of node $j with ()) ,
  (for $j in $i/PurchaseOrder/LineItems/LineItem
```



```

        [Description/text()= "The Unbearable Lightness Of Being"]
    return replace node $j with $p2)
return $i'
PASSING OBJECT_VALUE AS "p1", NULL AS "p2"
RETURNING CONTENT)
WHERE XMLEExists('$p/PurchaseOrder[Reference="SBELL-2002100912333601PDT"]'
    PASSING OBJECT_VALUE AS "p");

SELECT XMLCast(XMLQuery('$p/PurchaseOrder/Requestor'
    PASSING po.OBJECT_VALUE AS "p" RETURNING CONTENT)
    AS VARCHAR2(30)) name,
    XMLQuery('$p/PurchaseOrder/LineItems'
    PASSING po.OBJECT_VALUE AS "p" RETURNING CONTENT) lineitems
FROM purchaseorder po
WHERE XMLEExists('$p/PurchaseOrder[Reference="SBELL-2002100912333601PDT"]'
    PASSING po.OBJECT_VALUE AS "p");

```

NAME	LINEITEMS
Sarah J. Bell	<pre> <LineItems> <LineItem ItemNumber="1"> <Description/> <Part Id="715515009058" UnitPrice="39.95" Quantity=""/> </LineItem> <LineItem/> <LineItem ItemNumber="3"> <Description>Sisters</Description> <Part Id="715515011020" UnitPrice="29.95" Quantity="4"/> </LineItem> </LineItems> </pre>

Example 5-34 NULL Updates – Text Node

```

SELECT XMLCast(XMLQuery('$p/PurchaseOrder/LineItems/LineItem/Part[@Description="A Night to Remember"]'
    PASSING po.OBJECT_VALUE AS "p" RETURNING CONTENT)
    AS VARCHAR2(128)) part
FROM purchaseorder po
WHERE XMLEExists('$p/PurchaseOrder[@Reference="SBELL-2003030912333601PDT"]'
    PASSING po.OBJECT_VALUE AS "p");

```

PART

```
<Part Description="A Night to Remember" UnitCost="39.95">715515009058</Part>
```

```

UPDATE purchaseorder
SET OBJECT_VALUE =
XMLQuery(
    'copy $i := $p1 modify
    (for $j in $i/PurchaseOrder/LineItems/LineItem/Part[@Description="A Night to Remember"]
    return replace value of node $j with $p2)
    return $i
    PASSING OBJECT_VALUE AS "p1", NULL AS "p2" RETURNING CONTENT)
WHERE XMLEExists('$p/PurchaseOrder[@Reference="SBELL-2003030912333601PDT"]'
    PASSING OBJECT_VALUE AS "p");

```

```

SELECT XMLCast(XMLQuery('$p/PurchaseOrder/LineItems/LineItem/Part[@Description="A Night to Remember"]'
    PASSING po.OBJECT_VALUE AS "p" RETURNING CONTENT)
    AS VARCHAR2(128)) part
FROM purchaseorder po
WHERE XMLEExists('$p/PurchaseOrder[@Reference="SBELL-2003030912333601PDT"]'
    PASSING po.OBJECT_VALUE AS "p");

```

PART

```
<Part Description="A Night to Remember" UnitCost="39.95"/>
```

5.6.3 Inserting Child XML Nodes

You can use XQuery Update to insert new children (either a single attribute or one or more elements of the same type) under parent XML elements. The XML document that is the target of the insertion can be schema-based or non-schema-based.

[Example 5-35](#) (page 5-36) inserts a new `LineItem` element as a child of element `LineItems`. It uses the Oracle XQuery pragma `ora:child-element-name` to specify the name of the inserted child element as `LineItem`.

If the XML data to be updated is XML schema-based and it refers to a namespace, then the data to be inserted must also refer to the same namespace. Otherwise, an error is raised because the inserted data does not conform to the XML schema.

Note:

Be aware that using XQuery Update to update XML schema-based data results in an error being raised if you try to store the updated data back into an XML schema-based column or table. To prevent this, use XQuery pragma `ora:transform_keep_schema`. See [Oracle XQuery Extension-Expression Pragmas](#) (page 4-22).

[Example 5-36](#) (page 5-37) is the same as [Example 5-35](#) (page 5-36), except that the `LineItem` element to be inserted refers to a namespace. This assumes that the relevant XML schema requires a namespace for this element.

[Example 5-37](#) (page 5-37) inserts a `LineItem` element before the first `LineItem` element.

[Example 5-38](#) (page 5-38) inserts a `Date` element as the last child of an `Action` element.

Example 5-35 Inserting an Element into a Collection

```
SELECT XMLQuery('$p/PurchaseOrder/LineItems/LineItem[@ItemNumber=222]'
  PASSING po.OBJECT_VALUE AS "p" RETURNING CONTENT)
FROM purchaseorder po
WHERE XMLExists('$p/PurchaseOrder[Reference="AMCEWEN-20021009123336171PDT"]'
  PASSING po.OBJECT_VALUE AS "p");

XMLQUERY('$P/PURCHASEORDER/LINEITEMS/LINEITEM[@ITEMNUMBER=222]')
-----

1 row selected.

UPDATE purchaseorder
SET OBJECT_VALUE =
  XMLQuery('copy $i := $p1 modify
    (for $j in $i/PurchaseOrder/LineItems
      return (# ora:child-element-name LineItem #)
        {insert node $p2 into $j})
    return $i'
  PASSING OBJECT_VALUE AS "p1",
  XMLType('<LineItem ItemNumber="222">
    <Description>The Harder They Come</Description>
    <Part Id="953562951413" UnitPrice="22.95" Quantity="1"/>
  </LineItem>') AS "p2"
RETURNING CONTENT)
```

```

WHERE XMLExists('$p/PurchaseOrder[Reference="AMCEWEN-20021009123336171PDT"]'
                PASSING OBJECT_VALUE AS "p");

SELECT XMLQuery('$p/PurchaseOrder/LineItems/LineItem[@ItemNumber=222]'
                PASSING po.OBJECT_VALUE AS "p" RETURNING CONTENT)
FROM purchaseorder po
WHERE XMLExists('$p/PurchaseOrder[Reference="AMCEWEN-20021009123336171PDT"]'
                PASSING po.OBJECT_VALUE AS "p");

XMLQUERY('$P/PURCHASEORDER/LINEITEMS/LINEITEM[@ITEMNUMBER=222]'
-----
<LineItem ItemNumber="222">
  <Description>The Harder They Come</Description>
  <Part Id="953562951413" UnitPrice="22.95" Quantity="1"/>
</LineItem>

1 row selected.

```

Example 5-36 Inserting an Element that Uses a Namespace

```

UPDATE purchaseorder
SET OBJECT_VALUE =
XMLQuery('declare namespace e = "films.xsd"; (: :)
copy $i := $p1 modify
(for $j in $i/PurchaseOrder/LineItems
return (# ora:child-element-name e:LineItem #)
{insert node $p2 into $j})
return $i'
PASSING OBJECT_VALUE AS "p1",
XMLType('<e:LineItem ItemNumber="222">
  <Description>The Harder They Come</Description>
  <Part Id="953562951413" UnitPrice="22.95" Quantity="1"/>
</e:LineItem>') AS "p2"
RETURNING CONTENT)
WHERE XMLExists('$p/PurchaseOrder[Reference="AMCEWEN-20021009123336171PDT"]'
                PASSING OBJECT_VALUE AS "p");

```

Example 5-37 Inserting an Element Before an Element

```

SELECT XMLQuery('$p/PurchaseOrder/LineItems/LineItem[1]'
                PASSING po.OBJECT_VALUE AS "p" RETURNING CONTENT)
FROM purchaseorder po
WHERE XMLExists('$p/PurchaseOrder[Reference="AMCEWEN-20021009123336171PDT"]'
                PASSING po.OBJECT_VALUE AS "p");

XMLQUERY('$P/PURCHASEORDER/LINEITEMS/LINEITEM[1]' PASSING PO.OBJECT_
-----
<LineItem ItemNumber="1">
  <Description>Salesman</Description>
  <Part Id="37429158920" UnitPrice="39.95" Quantity="2"/>
</LineItem>

UPDATE purchaseorder
SET OBJECT_VALUE =
XMLQuery('copy $i := $p1 modify
(for $j in $i/PurchaseOrder/LineItems/LineItem[1]
return insert node $p2 before $j)
return $i'
PASSING OBJECT_VALUE AS "p1",
XMLType('<LineItem ItemNumber="314">
  <Description>Brazil</Description>
  <Part Id="314159265359" UnitPrice="69.95"

```

```

                Quantity="2"/>
            </LineItem>') AS "p2"
        RETURNING CONTENT)
    WHERE XMLExists('$p/PurchaseOrder[Reference="AMCEWEN-20021009123336171PDT"]'
        PASSING OBJECT_VALUE AS "p");

SELECT XMLQuery('$p/PurchaseOrder/LineItems/LineItem[position() <= 2]'
    PASSING po.OBJECT_VALUE AS "p" RETURNING CONTENT)
    FROM purchaseorder po
    WHERE XMLExists('$p/PurchaseOrder[Reference="AMCEWEN-20021009123336171PDT"]'
        PASSING po.OBJECT_VALUE AS "p");

```

```
XMLQUERY('$P/PURCHASEORDER/LINEITEMS/LINEITEM[POSITION()<=2]'PASSINGPO.OBJECT_
```

```

-----
<LineItem ItemNumber="314">
  <Description>Brazil</Description>
  <Part Id="314159265359" UnitPrice="69.95" Quantity="2"/>
</LineItem>
<LineItem ItemNumber="1">
  <Description>Salesman</Description>
  <Part Id="37429158920" UnitPrice="39.95" Quantity="2"/>
</LineItem>

```

Example 5-38 Inserting an Element as the Last Child Element

```

SELECT XMLQuery('$p/PurchaseOrder/Actions/Action[1]'
    PASSING po.OBJECT_VALUE AS "p" RETURNING CONTENT)
    FROM purchaseorder po
    WHERE XMLExists('$p/PurchaseOrder[Reference="AMCEWEN-20021009123336171PDT"]'
        PASSING po.OBJECT_VALUE AS "p");

XMLQUERY('$P/PURCHASEORDER/ACTIONS/ACTION[1]'PASSINGPO.OBJECT_VALUE
-----
<Action>
  <User>KPARTNER</User>
</Action>

UPDATE purchaseorder
  SET OBJECT_VALUE =
    XMLQuery('copy $i := $p1 modify
      (for $j in $i/PurchaseOrder/Actions/Action[1]
        return insert nodes $p2 as last into $j)
      return $i'
    PASSING OBJECT_VALUE AS "p1",
      XMLType('<Date>2002-11-04</Date>') AS "p2"
    RETURNING CONTENT)
  WHERE XMLExists('$p/PurchaseOrder[Reference="AMCEWEN-20021009123336171PDT"]'
    PASSING OBJECT_VALUE AS "p");

SELECT XMLQuery('$p/PurchaseOrder/Actions/Action[1]'
    PASSING po.OBJECT_VALUE AS "p" RETURNING CONTENT)
    FROM purchaseorder po
    WHERE XMLExists('$p/PurchaseOrder[Reference="AMCEWEN-20021009123336171PDT"]'
        PASSING po.OBJECT_VALUE AS "p");

XMLQUERY('$P/PURCHASEORDER/ACTIONS/ACTION[1]'PASSINGPO.OBJECT_VALUE
-----
<Action>
  <User>KPARTNER</User>
  <Date>2002-11-04</Date>
</Action>

```

5.6.4 Deleting XML Nodes

An example uses XQuery Update to delete XML nodes.

[Example 5-39](#) (page 5-39) deletes the `LineItem` element whose `ItemNumber` attribute has value 222.

Example 5-39 Deleting an Element

```
SELECT XMLQuery('$p/PurchaseOrder/LineItems/LineItem[@ItemNumber=222]'
               PASSING po.OBJECT_VALUE AS "p" RETURNING CONTENT)
FROM purchaseorder po
WHERE XMLExists('$p/PurchaseOrder[Reference="AMCEWEN-20021009123336171PDT"]'
               PASSING po.OBJECT_VALUE AS "p");

XMLQUERY('$P/PURCHASEORDER/LINEITEMS/LINEITEM[@ITEMNUMBER=222]' PASSINGPO
-----)
<LineItem ItemNumber="222">
  <Description>The Harder They Come</Description>
  <Part Id="953562951413" UnitPrice="22.95" Quantity="1"/>
</LineItem>

UPDATE purchaseorder
SET OBJECT_VALUE =
  XMLQuery('copy $i := $p modify
           delete nodes $i/PurchaseOrder/LineItems/LineItem[@ItemNumber="222"]
           return $i'
           PASSING OBJECT_VALUE AS "p" RETURNING CONTENT)
WHERE XMLExists('$p/PurchaseOrder[Reference="AMCEWEN-20021009123336171PDT"]'
               PASSING OBJECT_VALUE AS "p");

SELECT XMLQuery('$p/PurchaseOrder/LineItems/LineItem[@ItemNumber=222]'
               PASSING po.OBJECT_VALUE AS "p" RETURNING CONTENT)
FROM purchaseorder po
WHERE XMLExists('$p/PurchaseOrder[Reference="AMCEWEN-20021009123336171PDT"]'
               PASSING po.OBJECT_VALUE AS "p");

XMLQUERY('$P/PURCHASEORDER/LINEITEMS/LINEITEM[@ITEMNUMBER=222]' PASSINGPO
-----)

1 row selected.
```

5.6.5 Creating XML Views of Modified XML Data

You can use XQuery Update to create new views of XML data.

[Example 5-40](#) (page 5-39) creates a view of table `purchaseorder`.

Example 5-40 Creating a View Using Updated XML Data

```
CREATE OR REPLACE VIEW purchaseorder_summary OF XMLType AS
SELECT XMLQuery('copy $i := $p1 modify
               ((for $j in $i/PurchaseOrder/Actions
                 return replace value of node $j with ()),
                (for $j in $i/PurchaseOrder/ShippingInstructions
                 return replace value of node $j with ()),
                (for $j in $i/PurchaseOrder/LineItems
                 return replace value of node $j with ()))
               return $i'
               PASSING OBJECT_VALUE AS "p1" RETURNING CONTENT)
FROM purchaseorder p;
```

```
SELECT OBJECT_VALUE FROM purchaseorder_summary
WHERE XMLExists('$p/PurchaseOrder[Reference="DAUSTIN-20021009123335811PDT"]'
PASSING OBJECT_VALUE AS "p");
```

```
OBJECT_VALUE
```

```
-----
<PurchaseOrder
  xmlns:xsi="http://www.w3.org/2001/XMLSchema-instance"
  xsi:noNamespaceSchemaLocation=
    "http://localhost:8080/source/schemas/poSource/xsd/purchaseOrder.xsd">
<Reference>DAUSTIN-20021009123335811PDT</Reference>
<Actions/>
<Reject/>
<Requestor>David L. Austin</Requestor>
<User>DAUSTIN</User>
<CostCenter>S30</CostCenter>
<ShippingInstructions/>
<SpecialInstructions>Courier</SpecialInstructions>
<LineItems/>
</PurchaseOrder>
```

5.7 Performance Tuning for XQuery

A SQL query that involves XQuery expressions can often be automatically rewritten (optimized) in one or more ways. This optimization is referred to as **XML query rewrite** or optimization. When this happens, the XQuery expression is, in effect, evaluated directly against the XML document without constructing a DOM in memory.

XPath expressions are a proper subset of XQuery expressions. **XPath rewrite** is a subset of XML query rewrite that involves rewriting queries that involve XPath expressions.

XPath rewrite includes all of the following:

- Single-pass streaming of XMLType data stored as binary XML – A set of XPath expressions is evaluated in a single scan of the data.
- XMLIndex optimizations – A SQL statement that uses an XPath expression is rewritten to an equivalent SQL statement that does not use it but which instead references the relational XMLIndex tables. The rewritten SQL statement can also make use of any B-tree indexes on the underlying XMLIndex tables.
- Optimizations for XMLType data stored object-rationally and for XMLType views – A SQL statement that uses an XPath expression is rewritten to an equivalent SQL statement that does not use it but which instead references the object-relational or relational data structures that underly the XMLType data. The rewritten SQL statement can also make use of any B-tree indexes on the underlying data structures. This can take place for both queries and update operations.

Just as query tuning can improve SQL performance, so it can improve XQuery performance. You tune XQuery performance by choosing appropriate XML storage models and indexes.

As with database queries generally, you determine whether tuning is required by examining the execution plan for a query. If the plan is not optimal, then consult the following documentation for specific tuning information:

- For object-relational storage: [XPath Rewrite for Object-Relational Storage](#) (page 19-1)

- For binary XML storage: [Indexes for XMLType Data](#) (page 6-1)

In addition, be aware that the following expressions can be expensive to process, so they might add performance overhead when processing large volumes of data:

- SQL expressions that use the following *deprecated* Oracle SQL functions, which accept XPath expression arguments:
 - `appendChildXML` (use `insertChildXMLafter` instead)
 - `insertXMLafter` (use `insertChildXMLafter` instead)
 - `insertXMLbefore` (use `insertChildXMLbefore` instead)
- XQuery expressions that use the following axes (use forward and descendent axes instead):
 - `ancestor`
 - `ancestor-or-self`
 - `descendant-or-self`
 - `following`
 - `following-sibling`
 - `namespace`
 - `parent`
 - `preceding`
 - `preceding-sibling`
- XQuery expressions that involve node identity (for example, using the order-comparison operators `<<` and `>>`)

See Also:

[Oracle XML DB Support for XQuery](#) (page 4-26)

The following sections present the execution plans for some of the examples shown in [XQuery and Oracle XML DB](#) (page 4-1), to indicate how they are executed.

- [XQuery Optimization over Relational Data](#) (page 5-42): examples with XQuery expressions that target XML data created on the fly using `fn:collection` together with URI scheme `oradb`.
- [XQuery Optimization over XML Schema-Based XMLType Data](#) (page 5-43): examples with XQuery expressions that target an XML schema-based XMLType table stored object-rationally

5.7.1 Rule-Based and Cost-Based XQuery Optimization

Several competing optimization possibilities can exist for queries with XQuery expressions, depending on various factors such as the XMLType storage model and indexing that are used.

By default, Oracle XML DB follows a prioritized set of rules to determine which of the possible optimizations should be used for any given query and context. This behavior is referred to as **rule-based** XML query rewrite.

Alternatively, Oracle XML DB can use **cost-based** XML query rewrite. In this mode, Oracle XML DB estimates the performance of the various XML optimization possibilities for a given query and chooses the combination that is expected to be most performant.

You can impose cost-based optimization for a given SQL statement by using the optimizer hint `/*+ COST_XML_QUERY_REWRITE */`.

5.7.2 XQuery Optimization over Relational Data

Use of SQL/XML functions `XMLQuery` and `XMLTable` over relational data can be optimized.

[Example 5-41](#) (page 5-42) shows the optimization of `XMLQuery` over relational data accessed as XML. [Example 5-42](#) (page 5-42) shows the optimization of `XMLTable` in the same context.

Example 5-41 Optimization of XMLQuery over Relational Data

Here again is the query of [Example 5-6](#) (page 5-7), together with its execution plan, which shows that the query has been optimized.

```
SELECT XMLQuery(
  'for $i in fn:collection("oradb:/OE/WAREHOUSES")/ROW
   return <Warehouse id="{ $i/WAREHOUSE_ID }">
     <Location>
       {for $j in fn:collection("oradb:/HR/LOCATIONS")/ROW
        where $j/LOCATION_ID eq $i/LOCATION_ID
         return ($j/STREET_ADDRESS, $j/CITY, $j/STATE_PROVINCE)}
     </Location>
  </Warehouse>'
  RETURNING CONTENT) FROM DUAL;
```

PLAN_TABLE_OUTPUT

Plan hash value: 3341889589

Id	Operation	Name	Rows	Bytes	Cost (%CPU)	Time
0	SELECT STATEMENT		1		2 (0)	00:00:01
1	SORT AGGREGATE		1	41		
2	TABLE ACCESS BY INDEX ROWID	LOCATIONS	1	41	1 (0)	00:00:01
* 3	INDEX UNIQUE SCAN	LOC_ID_PK	1		0 (0)	00:00:01
4	SORT AGGREGATE		1	6		
5	TABLE ACCESS FULL	WAREHOUSES	9	54	2 (0)	00:00:01
6	FAST DUAL		1		2 (0)	00:00:01

Predicate Information (identified by operation id):

3 - access("LOCATION_ID"=:B1)

18 rows selected.

Example 5-42 Optimization of XMLTable over Relational Data

Here again is the query of [Example 5-7](#) (page 5-9), together with its execution plan, which shows that the query has been optimized.

```

SELECT *
FROM XMLTable(
  'for $i in fn:collection("oradb:/OE/WAREHOUSES")/ROW
  return <Warehouse id="{ $i/WAREHOUSE_ID }">
    <Location>
      {for $j in fn:collection("oradb:/HR/LOCATIONS")/ROW
       where $j/LOCATION_ID eq $i/LOCATION_ID
       return ($j/STREET_ADDRESS, $j/CITY, $j/STATE_PROVINCE)}
    </Location>
  </Warehouse>');

```

PLAN_TABLE_OUTPUT

Plan hash value: 1021775546

Id	Operation	Name	Rows	Bytes	Cost (%CPU)	Time
0	SELECT STATEMENT		9	54	2 (0)	00:00:01
1	SORT AGGREGATE		1	41		
2	TABLE ACCESS BY INDEX ROWID	LOCATIONS	1	41	1 (0)	00:00:01
* 3	INDEX UNIQUE SCAN	LOC_ID_PK	1		0 (0)	00:00:01
4	TABLE ACCESS FULL	WAREHOUSES	9	54	2 (0)	00:00:01

Predicate Information (identified by operation id):

3 - access("LOCATION_ID"=:B1)

16 rows selected.

5.7.3 XQuery Optimization over XML Schema-Based XMLType Data

Use of SQL/XML functions `XMLQuery` and `XMLTable` XML Schema-based data can be optimized.

[Example 5-43](#) (page 5-43) shows the optimization of `XMLQuery` over an XML schema-based XMLType table. [Example 5-44](#) (page 5-44) shows the optimization of `XMLTable` in the same context.

Example 5-43 Optimization of XMLQuery with Schema-Based XMLType Data

Here again is the query of [Example 5-10](#) (page 5-13), together with its execution plan, which shows that the query has been optimized.

```

SELECT XMLQuery('for $i in /PurchaseOrder
  where $i/CostCenter eq "A10"
  and $i/User eq "SMCCAIN"
  return <A10po pono="{ $i/Reference }"/>'
  PASSING OBJECT_VALUE
  RETURNING CONTENT)
FROM purchaseorder;

```

PLAN_TABLE_OUTPUT

Plan hash value: 3611789148

Id	Operation	Name	Rows	Bytes	Cost (%CPU)	Time
----	-----------	------	------	-------	-------------	------

0	SELECT STATEMENT		1	530	5 (0)	00:00:01
1	SORT AGGREGATE		1			
* 2	FILTER					
3	FAST DUAL		1		2 (0)	00:00:01
* 4	TABLE ACCESS FULL	PURCHASEORDER	1	530	5 (0)	00:00:01

Predicate Information (identified by operation id):

```

2 - filter(:B1='SMCCAIN' AND :B2='A10')
4 - filter(SYS_CHECKACL("ACLOID", "OWNERID", xmltype('<privilege
      xmlns="http://xmlns.oracle.com/xdb/acl.xsd"
      xmlns:xsi="http://www.w3.org/2001/XMLSchema-instance"
      xsi:schemaLocation="http://xmlns.oracle.com/xdb/acl.xsd
      http://xmlns.oracle.com/xdb/acl.xsd DAV:http://xmlns.oracle.com/xdb/dav.xsd">
      <read-properties/><read-contents/></privilege>'))=1)

```

22 rows selected.

Example 5-44 Optimization of XMLTable with Schema-Based XMLType Data

Here again is the query of [Example 5-14](#) (page 5-15), together with its execution plan, which shows that the query has been optimized. The XQuery result is never materialized. Instead, the underlying storage columns for the XML collection element `LineItem` are used to generate the overall result set.

```

SELECT lines.lineitem, lines.description, lines.partid,
       lines.unitprice, lines.quantity
FROM purchaseorder,
     XMLTable('for $i in /PurchaseOrder/LineItems/LineItem
              where $i/@ItemNumber >= 8
                 and $i/Part/@UnitPrice > 50
                 and $i/Part/@Quantity > 2
              return $i'
              PASSING OBJECT_VALUE
              COLUMNS lineitem    NUMBER          PATH '@ItemNumber',
                       description VARCHAR2(30)    PATH 'Description',
                       partid      NUMBER          PATH 'Part/@Id',
                       unitprice   NUMBER          PATH 'Part/@UnitPrice',
                       quantity    NUMBER          PATH 'Part/@Quantity') lines;

```

Id	Operation	Name	Rows	Bytes	Cost (%CPU)	Time
0	SELECT STATEMENT		4	384	7 (0)	00:00:01
1	NESTED LOOPS					
2	NESTED LOOPS		4	384	7 (0)	00:00:01
* 3	TABLE ACCESS FULL	PURCHASEORDER	1	37	5 (0)	00:00:01
* 4	INDEX RANGE SCAN	SYS_C005478	17		1 (0)	00:00:01
* 5	TABLE ACCESS BY INDEX ROWID	LINEITEM_TABLE	3	177	2 (0)	00:00:01

Predicate Information (identified by operation id):

```

3 - filter(SYS_CHECKACL("ACLOID", "OWNERID", xmltype('<privilege
      xmlns="http://xmlns.oracle.com/xdb/acl.xsd"
      xmlns:xsi="http://www.w3.org/2001/XMLSchema-instance"
      xsi:schemaLocation="http://xmlns.oracle.com/xdb/acl.xsd

```

```

http://xmlns.oracle.com/xdb/acl.xsd
DAV:http://xmlns.oracle.com/xdb/dav.xsd"><read-prop
erties/><read-contents/></privilege>')=1)
4 - access("NESTED_TABLE_ID"="PURCHASEORDER"."SYS_NC0003400035$")
5 - filter("SYS_NC00013$">50 AND "SYS_NC00012$">2 AND "ITEMNUMBER">=8 AND
"SYS_NC_TYPEID$" IS NOT NULL)

```

25 rows selected.

This example traverses table `oe.purchaseorder` completely. The `XMLTable` expression is evaluated for each purchase-order document. It is more efficient to have the `XMLTable` expression, not the `purchaseorder` table, drive the SQL-query execution.

Although the XQuery expression has been rewritten to relational expressions, you can improve this optimization by creating an *index* on the underlying relational data — you can optimize this query in the same way that you would optimize a purely SQL query. That is always the case with XQuery in Oracle XML DB: the optimization techniques you use are the same as those you use in SQL.

The `UnitPrice` attribute of collection element `LineItem` is an appropriate index target. The governing XML schema specifies that an ordered collection table (OCT) is used to store the `LineItem` elements.

However, the name of this OCT was generated by Oracle XML DB when the XML purchase-order documents were decomposed as XML schema-based data. Instead of using table `purchaseorder` from sample database schema `HR`, you could manually create a new `purchaseorder` table (in a different database schema) with the same properties and same data, but having OCTs with user-friendly names.

Assuming that this has been done, the following statement creates the appropriate index:

```
CREATE INDEX unitprice_index ON lineitem_table("PART"."UNITPRICE");
```

With this index defined, the query of [Example 5-14](#) (page 5-15) results in the following execution plan, which shows that the `XMLTable` expression has driven the overall evaluation.

PLAN_TABLE_OUTPUT

Plan hash value: 1578014525

Id	Operation	Name	Rows	Bytes	Cost (%CPU)	Time
0	SELECT STATEMENT		3	624	8 (0)	00:00:01
1	NESTED LOOPS		3	624	8 (0)	00:00:01
* 2	INDEX UNIQUE SCAN	SYS_IOT_TOP_49323	3	564	5 (0)	00:00:01
* 3	INDEX RANGE SCAN	UNITPRICE_INDEX	20		2 (0)	00:00:01
* 4	INDEX UNIQUE SCAN	SYS_C004411	1		0 (0)	00:00:01

Predicate Information (identified by operation id):

```

-----
2 - access("SYS_NC00013$">50)
   filter("ITEMNUMBER">=8 AND "SYS_NC00012$">2)
3 - access("SYS_NC00013$">50)
4 - access("NESTED_TABLE_ID"="PURCHASEORDER"."SYS_NC0003400035$")

```

Note

- dynamic sampling used for this statement

23 rows selected.

5.7.4 Diagnosis of XQuery Optimization: XMLOptimizationCheck

You can examine an execution plan for your SQL code to determine whether XQuery optimization occurs or the plan is instead suboptimal.

In the latter case, a note such as the following appears immediately after the plan:

```
Unoptimized XML construct detected (enable XMLOptimizationCheck
for more information)
```

You can also compare the execution plan output with the plan output that you see after you use the optimizer hint `NO_XML_QUERY_REWRITE`, which turns off XQuery optimization.

In addition, you can use the SQL*Plus `SET` command with system variable `XMLOptimizationCheck` to turn on an **XML diagnosability mode** for SQL:

```
SET XMLOptimizationCheck ON
```

When this mode is on, the plan of execution is automatically checked for XQuery optimization, and if the plan is suboptimal then an error is raised and diagnostic information is written to the trace file indicating which operators are not rewritten.

The main advantage of `XMLOptimizationCheck` is that it brings a potential problem to your attention immediately. For this reason, you might find it preferable to leave it turned on at all times. Then, if an application change or a database change for some reason prevents a SQL operation from rewriting, execution is stopped instead of performance being negatively impacted without your being aware of the cause.

Note:

- `XMLOptimizationCheck` was not available prior to Oracle Database 11g Release 2 (11.2.0.2). Users of older releases directly manipulated event 19201 to obtain XQuery optimization information.
- OCI users can use `OCIStmtExecute` or event 19201. Only the event is available to Java users.

See Also:

[Turning Off Use of XMLIndex](#) (page 6-36) for information about optimizer hint `NO_XML_QUERY_REWRITE`

5.7.5 Performance Improvement for `fn:doc` and `fn:collection` on Repository Data

You can improve the performance of `fn:doc` and `fn:collection` queries over the Oracle XML DB Repository, by linking them to the actual database tables that hold the repository data being queried.

In Oracle XML DB, you can use XQuery functions `fn:doc` and `fn:collection` to reference documents and collections in Oracle XML DB Repository.

When repository XML data is stored object-relationally or as binary XML, queries that use `fn:doc` and `fn:collection` are evaluated functionally; that is, they are not

optimized to access the underlying storage tables directly. To improve the performance of such queries, you must link them to the actual database tables that hold the repository data being queried. You can do that in either of the following ways:

- Join view `RESOURCE_VIEW` with the `XMLType` table that holds the data, and then use the Oracle SQL functions `equals_path` and `under_path` instead of the XQuery functions `fn:doc` and `fn:collection`, respectively. These SQL functions reference repository resources in a performant way.
- Use the Oracle XQuery extension-expression pragma `ora:defaultTable`.

Both methods have the same effect. Oracle recommends that you use the `ora:defaultTable` pragma because it lets you continue to use the XQuery standard functions `fn:doc` and `fn:collection` and it simplifies your code.

These two methods are illustrated in the examples of this section.

5.7.5.1 Use `EQUALS_PATH` and `UNDER_PATH` Instead of `fn:doc` and `fn:collection`

Using Oracle SQL functions `equals_path` and `under_path` instead of XQuery functions `fn:doc` and `fn:collection` can improve performance.

SQL function `equals_path` references a resource located at a specified repository path, and SQL function `under_path` references a resource located under a specified repository path. [Example 5-45](#) (page 5-47) and [Example 5-46](#) (page 5-47) illustrate this for functions `fn:doc` and `equals_path`; functions `fn:collection` and `under_path` are treated similarly.

Example 5-45 Unoptimized Repository Query Using `fn:doc`

```
SELECT XMLQuery('let $val :=
    fn:doc("/home/OE/PurchaseOrders/2002/Sep/VJONES-20021009123337583PDT.xml")
    /PurchaseOrder/LineItems/LineItem[@ItemNumber =19]
    return $val' RETURNING CONTENT)
FROM DUAL;
```

Example 5-46 Optimized Repository Query Using `EQUALS_PATH`

```
SELECT XMLQuery('let $val := $DOC/PurchaseOrder/LineItems/LineItem[@ItemNumber = 19]
    return $val' PASSING OBJECT_VALUE AS "DOC" RETURNING CONTENT)
FROM RESOURCE_VIEW rv, purchaseorder p
WHERE ref(p) = XMLCast(XMLQuery('declare default element namespace
    "http://xmlns.oracle.com/xdm/XDBResource.xsd"; (: :)
    fn:data1(/Resource/XMLRef)' PASSING rv.RES RETURNING CONTENT)
    AS REF XMLType)
AND equals_path(rv.RES, '/home/OE/PurchaseOrders/2002/Sep/VJONES-20021009123337583PDT.xml')
= 1;
```

5.7.5.2 Using Oracle XQuery Pragma `ora:defaultTable`

You can use Oracle XQuery extension-expression pragma `ora:defaultTable` to improve the performance of querying repository data.

Oracle XQuery extension-expression pragma `ora:defaultTable` lets you specify the default table used to store repository data that you query. The query is rewritten to automatically join the default table to view `RESOURCE_VIEW` and use Oracle SQL functions `equals_path` and `under_path` instead of XQuery functions `fn:doc` and `fn:collection`, respectively. The effect is thus the same as coding the query

¹ XQuery function `fn:data` is used here to atomize its argument, in this case returning the `XMLRef` node's typed atomic value.

manually to use an explicit join and `equals_path` or `under_path`. [Example 5-47](#) (page 5-48) illustrates this; the query is rewritten automatically to what is shown in [Example 5-46](#) (page 5-47).

For clarity of scope Oracle recommends that you apply `pragma ora:defaultTable` directly to the relevant document or collection expression, `fn:doc` or `fn:collection`, rather than to a larger expression.

Example 5-47 Repository Query Using Oracle XQuery Pragma `ora:defaultTable`

```
SELECT XMLQuery('for $doc in (#ora:defaultTable PURCHASEORDER #)
                {fn:doc("/home/OE/PurchaseOrders/2002/Sep/VJONES-20021009123337583PDT.xml")}'
                let $val := $doc/PurchaseOrder/LineItems/LineItem[@ItemNumber = 19]
                return $val}'
        RETURNING CONTENT)
FROM DUAL;
```

Indexes for XMLType Data

You can create indexes on your XML data, to focus on particular parts of it that you query often and thus improve performance. There are various ways that you can index XMLType data, whether it is XML schema-based or non-schema-based, and regardless of the XMLType storage model you use.

- [Oracle XML DB Tasks Involving Indexes](#) (page 6-1)
- [Overview of Indexing XMLType Data](#) (page 6-4)
- [XMLIndex](#) (page 6-7)
- [Indexing XML Data for Full-Text Queries](#) (page 6-56)
- [Indexing XMLType Data Stored Object-Relationally](#) (page 6-62)

Note:

The execution plans shown here are for illustration only. If you run the examples presented here in your environment then your execution plans might not be identical.

See Also:

- *Oracle Database Concepts* for an overview of indexing
 - *Oracle Database Development Guide* for information about using indexes in application development
-
-

6.1 Oracle XML DB Tasks Involving Indexes

Common tasks involving indexes for XML data are described.

[Table 6-1](#) (page 6-1) identifies the documentation for some basic user tasks involving indexes for XML data.

Table 6-1 Basic XML Indexing Tasks

For information about how to...	See...
Choose an indexing approach	Overview of Indexing XMLType Data (page 6-4)

Table 6-1 (Cont.) Basic XML Indexing Tasks

For information about how to...	See...
Index XMLType data stored object-rationally	Indexing XMLType Data Stored Object-Relationally (page 6-62), Guideline: Create indexes on ordered collection tables (page 19-8)
Create, drop, or rename an XMLIndex index	Example 6-7 (page 6-21), Example 6-9 (page 6-22)
Obtain the name of an XMLIndex index for a given table or column	Example 6-8 (page 6-21)
Determine whether a given XMLIndex index is used in evaluating a query	How to Tell Whether XMLIndex is Used (page 6-31)
Turn off use of an XMLIndex index	Turning Off Use of XMLIndex (page 6-36)

[Table 6-2](#) (page 6-2) identifies the documentation for some user tasks involving XMLIndex indexes that have a *structured* component.

Table 6-2 Tasks Involving XMLIndex Indexes with a Structured Component

For information about how to...	See...
Create an XMLIndex index with a structured component	Example 6-23 (page 6-28), Example 6-21 (page 6-27)
Drop the structured component of an XMLIndex index (drop all structure groups)	Example 6-25 (page 6-31)
Ensure data type correspondence between a query and an XMLIndex index with a structured component	Data Type Considerations for XMLIndex Structured Component (page 6-11)
Create a B-tree index on a content table of an XMLIndex structured component	Example 6-26 (page 6-31)
Create an Oracle Text CONTEXT index on a content table of an XMLIndex structured component	Example 6-46 (page 6-60)

[Table 6-3](#) (page 6-2) identifies the documentation for some user tasks involving XMLIndex indexes that have an *unstructured* component.

Table 6-3 Tasks Involving XMLIndex Indexes with an Unstructured Component

For information about how to...	See...
Create an XMLIndex index with an unstructured component	Example 6-10 (page 6-23), Example 6-12 (page 6-23), Example 6-33 (page 6-38), Example 6-35 (page 6-38), Example 6-36 (page 6-42), Example 6-37 (page 6-42), Example 6-38 (page 6-44)
Drop the unstructured component of an XMLIndex index (drop the path table)	Example 6-13 (page 6-23)
Name the path table when creating an XMLIndex index	Example 6-10 (page 6-23)

Table 6-3 (Cont.) Tasks Involving XMLIndex Indexes with an Unstructured Component

For information about how to...	See...
Specify storage options when creating an XMLIndex index	Example 6-12 (page 6-23)
Show all existing secondary indexes on an XMLIndex path table	Example 6-14 (page 6-23), Example 6-20 (page 6-25)
Obtain the name of a path table for an XMLIndex index	Example 6-11 (page 6-23)
Obtain the name of an XMLIndex index with an unstructured component, given its path table	Example 6-28 (page 6-34)
Create a secondary index on an XMLIndex path table	Using XMLIndex with an Unstructured Component (page 6-22)
Obtain information about all of the secondary indexes on an XMLIndex path table	Example 6-20 (page 6-25)
Create a function-based index on a path-table VALUE column	Example 6-15 (page 6-25)
Create a numeric index on a path-table VALUE column	Example 6-17 (page 6-25)
Create a date index on a path-table VALUE column	Example 6-18 (page 6-25)
Create an Oracle Text CONTEXT index on a path-table VALUE column	Example 6-19 (page 6-25)
Exclude or include particular XPath expressions from use by an XMLIndex index	XMLIndex Path Subsetting: Specifying the Paths You Want to Index (page 6-37)
Specify namespace prefixes for XPath expressions used for XMLIndex	XMLIndex Path Subsetting: Specifying the Paths You Want to Index (page 6-37)
Exclude or include particular XPath expressions from use by an XMLIndex index	XMLIndex Path Subsetting: Specifying the Paths You Want to Index (page 6-37)
Specify namespace prefixes for XPath expressions used for XMLIndex	XMLIndex Path Subsetting: Specifying the Paths You Want to Index (page 6-37)

[Table 6-4](#) (page 6-3) identifies the documentation for some other user tasks involving XMLIndex indexes.

Table 6-4 Miscellaneous Tasks Involving XMLIndex Indexes

For information about how to...	See...
Specify that an XMLIndex index should be created and maintained using parallel processes	XMLIndex Partitioning and Parallelism (page 6-41)
Change the parallelism of an XMLIndex path table to tune index performance	XMLIndex Partitioning and Parallelism (page 6-41)
Schedule maintenance for an XMLIndex index	Asynchronous (Deferred) Maintenance of XMLIndex Indexes (page 6-42)
Manually synchronize an XMLIndex index and its base table	Asynchronous (Deferred) Maintenance of XMLIndex Indexes (page 6-42)
Collect statistics on a table or index for the cost-based optimizer	Example 6-40 (page 6-45)

Table 6-4 (Cont.) Miscellaneous Tasks Involving XMLIndex Indexes

For information about how to...	See...
Create an XML search index	Example 6-41 (page 6-57)
Use an XML search index for full-text search of XML data stored as binary XML	Example 6-42 (page 6-57)
Show whether an XML search index is used in a query	Example 6-43 (page 6-58)
Create an Oracle Text CONTEXT index on a content table of an XMLIndex structured component	Example 6-46 (page 6-60)

6.2 Overview of Indexing XMLType Data

Database indexes improve performance by providing faster access to table data. The use of indexes is particularly recommended for online transaction processing (OLTP) environments involving few updates.

The principle way you index XML data is using XMLIndex. You can also use Oracle Text CONTEXT indexes to supplement the use of XMLIndex.

Here is a summary decision tree, as the place to start when choosing ways to index XMLType data stored as binary XML:¹¹

If your XML data contains islands of structured, predictable data, and your queries are known

Use XMLIndex with a *structured component* to index the structured islands (even if the data surrounding these islands is unstructured).

A structured index component reflects the queries you use. You can change this set of known queries over time, provided you update the index definition accordingly. See [XMLIndex Structured Component](#) (page 6-9).

If you need to query full-text content within your XML data

Use an *XML search index*. See [Oracle Text Indexes for XML Data](#) (page 6-5).

If you need to support ad-hoc XML queries that involve predicates

Use XMLIndex with an *unstructured component* – see [XMLIndex Unstructured Component](#) (page 6-15).

Does your XML data contain *islands of data that is highly structured and predictable* (even if the surrounding data might be unstructured)?

- Yes. Use XMLIndex with a structured component to index the islands. See "XMLIndex Structured Component" on page 6-12.
- No. Do you need to *query full-text content* within your XML data?
 - Yes. Use an XML search index. See "Oracle Text Indexes for XML Data" on page 6-5.

¹¹ For XMLType data stored object-rationally, see [Indexing XMLType Data Stored Object-Relationally](#) (page 6-62). If your data is highly structured throughout, or your queries are not known at index creation time, then this approach might be appropriate.

- No. Do you need to support *ad-hoc XML queries that involve predicates*? If so, use XMLIndex with an unstructured component – see "XMLIndex Unstructured Component" on page 6-16. If not, do not bother to index your XML data.

6.2.1 XMLIndex Addresses the Fine-Grained Structure of XML Data

You can create indexes on one or more relational columns, or on a functional expression. XML data, however, has its own, fine-grained structure, which is not necessarily reflected in the structure of the database tables used to store it. For this reason, effectively indexing XML data can be a bit different from indexing most database data.

For object-relational XMLType storage, XML objects such as elements and attributes correspond to object-relational columns and tables. Creating *B-tree indexes* on those columns and tables thus provides an excellent way to effectively index the corresponding XML objects. Here, the storage model directly reflects the fine-grained structure of the XML data, so there is no special problem for indexing structured XML data. See [Indexing XMLType Data Stored Object-Relationally](#) (page 6-62).

In object-relational XMLType storage, an XML document is broken up and stored object-relationally, but you can choose to store one or more of its XML fragments as embedded CLOB instances. A typical use case for this is mapping an XML-schema `complexType` or a complex element to CLOB storage, because you generally access the entire fragment as a unit.

But such an embedded CLOB fragment also acts as an opaque unit when it comes to indexing; its parts are not indexed individually.

Similarly, standard indexing is not helpful for binary XML storage. In both of these cases, indexing a database column using the standard sorts of index (B-tree, bitmap) is generally not helpful for accessing particular parts of an XML document.

XMLIndex provides a general, XML-specific index that indexes the internal structure of XML data. One of its main purposes is to overcome the indexing limitation presented by binary XML storage.

- An XMLIndex index with an *unstructured component* indexes the XML *tags* of your document and identifies document fragments based on XPath expressions that target them. It can also index scalar node *values*, to provide quick lookup based on individual values or ranges of values. It also records document *hierarchy* information for each node it indexes: relations parent–child, ancestor–descendant, and sibling. This index component is particularly useful for queries that extract XML fragments from documents that have little or variable structure.
- An XMLIndex index with a *structured component* indexes highly structured and predictable parts of XML data that is nevertheless for the most part unstructured. This index component is particularly useful for queries that project and use such islands of structured content.

See Also:

[XMLIndex](#) (page 6-7)

6.2.2 Oracle Text Indexes for XML Data

Besides accessing XML nodes such as elements and attributes, it is sometimes important to provide fast access to particular passages within XML text nodes. To

query such content within XML data, you can use XQuery Full Text (XQFT) or Oracle-specific full-text constructs.

In either case, you create an appropriate Oracle Text (full-text) index. In the case of XQFT, the index is an XML search index, which is designed specifically for use with XMLType data stored as binary XML.

Full-text indexing is particularly useful for *document-centric* applications, which often contain a mix of XML elements and text-node content. Full-text searching can often be made more powerful, more focused, by combining it with structural XML searching, that is, by restricting it to certain parts of an XML document, which are identified by using XPath expressions.

See Also:

[Indexing XML Data for Full-Text Queries](#) (page 6-56)

6.2.3 Optimization Chooses the Right Indexes to Use

Which indexes are used when more than one might apply in a given case? Cost-based optimization determines the index or indexes to use, so that performance is maximized.

Oracle Text indexes apply only to text, which for XML data means text nodes. Whenever text nodes are targeted and a corresponding Oracle Text index is defined, it is used. If other indexes are also appropriate in a particular context, then they can be used as well. However, just because an index is defined and it might appear applicable in a given situation does not mean that it will be used. It will not be used if the cost-based optimizer deems that its use is not cost-effective.

6.2.4 Function-Based Indexes Are Deprecated for XMLType

In releases prior to Oracle Database 11g Release 2 (11.2), function-based indexes were sometimes appropriate for use with XMLType data when an XPath expression targeted a singleton node. Oracle recommends that you use the structured component of XMLIndex instead.

Doing so obviates the overhead associated with maintenance operations on function-based indexes, and it increases the number of situations in which the optimizer can correctly select the index. No changes to existing DML statements are required as a result of this.

It continues to be the case that, for object-relational storage of XMLType, defining an index for (deprecated) Oracle SQL function `extractValue` often leads, by XPath rewrite, to automatic creation of B-tree indexes on the underlying objects (instead of a function-based index on `extractValue`). The XPath target here must be a *singleton* element or attribute. A similar shortcut exists for XMLCast applied to XMLQuery.

See Also:

- [Indexing XMLType Data Stored Object-Relationally](#) (page 6-62)
 - [XMLIndex Structured Component](#) (page 6-9)
-
-

6.3 XMLIndex

- [Advantages of XMLIndex](#) (page 6-7)
- [Structured and Unstructured XMLIndex Components](#) (page 6-8)
- [XMLIndex Structured Component](#) (page 6-9)
- [XMLIndex Unstructured Component](#) (page 6-15)
- [Creating, Dropping, Altering, and Examining an XMLIndex Index](#) (page 6-20)
- [Using XMLIndex with an Unstructured Component](#) (page 6-22)
- [Use of XMLIndex with a Structured Component](#) (page 6-26)
- [How to Tell Whether XMLIndex is Used](#) (page 6-31)
- [Turning Off Use of XMLIndex](#) (page 6-36)
- [XMLIndex Path Subsetting: Specifying the Paths You Want to Index](#) (page 6-37)
- [Guidelines for Using XMLIndex with an Unstructured Component](#) (page 6-39)
- [Guidelines for Using XMLIndex with a Structured Component](#) (page 6-40)
- [XMLIndex Partitioning and Parallelism](#) (page 6-41)
- [Asynchronous \(Deferred\) Maintenance of XMLIndex Indexes](#) (page 6-42)
- [Collecting Statistics on XMLIndex Objects for the Cost-Based Optimizer](#) (page 6-44)
- [Data Dictionary Static Public Views Related to XMLIndex](#) (page 6-45)
- [PARAMETERS Clause for CREATE INDEX and ALTER INDEX](#) (page 6-46)

6.3.1 Advantages of XMLIndex

B-tree indexes can be used advantageously with object-relational XMLType storage — they provide sharp focus by targeting the underlying objects directly. They are generally ineffective, however, in addressing the detailed structure (elements and attributes) of an XML document stored using binary XML. That is the special domain of XMLIndex.

XMLIndex is a *domain* index; it is designed specifically for the domain of XML data. It is a *logical* index. An XMLIndex index can be used for SQL/XML functions XMLQuery, XMLTable, XMLExists, and XMLCast.

XMLIndex presents the following advantages over other indexing methods:

- An XMLIndex index is effective in any part of a query; it is not limited to use in a WHERE clause. This is not the case for any of the other kinds of indexes you might use with XML data.
- An XMLIndex index with an unstructured component can speed access to both SELECT list data and FROM list data, making it useful for XML *fragment* extraction, in particular. Function-based indexes, which are deprecated, cannot be used to extract document fragments.

- You can use an `XMLIndex` index with either XML schema-based or non-schema-based `XMLType` data stored as binary XML. B-tree indexing is appropriate only for XML schema-based data that is stored object-relationally.
- You can use an `XMLIndex` index for searches with XPath expressions that target *collections*, that is, nodes that occur multiple times within a document. This is not the case for function-based indexes.
- You need no prior knowledge of the XPath expressions that might be used in queries. The unstructured component of an `XMLIndex` index can be completely general. This is not the case for function-based indexes.
- If you have prior knowledge of the XPath expressions to be used in queries, then you can improve performance either by using a *structured* `XMLIndex` component that targets fixed, structured islands of data that are queried often.
- `XMLIndex` indexing — both index creation and index maintenance — can be carried out in parallel, using multiple database processes. This is not the case for function-based indexes, which are deprecated.

6.3.2 Structured and Unstructured XMLIndex Components

`XMLIndex` is used to index XML data that is unstructured or semi-structured, that is, data that generally has little or no fixed structure. It applies to `XMLType` data that is stored as binary XML.

Semi-structured XML data can sometimes nevertheless contain islands of predictable, structured data. An `XMLIndex` index can therefore have two components: a **structured component**, used to index such islands, and an **unstructured component**, used to index data that has little or variable structure.

A structured component can help with queries that project and use islands of structured content. A typical example is a free-form specification with fixed fields author, date, and title. An unstructured component can help with queries that extract XML fragments. Either component can be omitted from a given `XMLIndex` index.

Unlike a structured component, an unstructured component is general and relatively untargeted. It is appropriate for general indexing of document-centric XML data. A typical example is an XML web document or a book chapter.

You can create an `XMLIndex` index with both structured and unstructured components. A typical use case is supporting queries that extract an XML fragment from a document whenever some structured data is also present. The unstructured component is used for the fragment extraction. The structured component is used for a query predicate that checks for the structured data (for example, in the SQL `WHERE` clause).

Though you can restrict an unstructured component to apply only to certain XPath subsets, its path table indexes node content that can be of different scalar types, which can require you to create multiple secondary indexes on the `VALUE` column to deal with the different data types — see [Secondary Indexes on Column VALUE](#) (page 6-20). Using an unstructured component alone can also lead to inefficiencies involving multiple probes and self-joins of its path table, for queries that project structured islands.

On the other hand, a structured component is not suited for queries that involve little structure or queries that extract XML fragments. Use a structured component to index structured islands of data; use an unstructured component to index data that has little structure.

Figure 6–1 is the same as Figure 1–2 in Chapter 1.

The last row indicates the applicability of XMLIndex for different XML data use cases. It shows that XMLIndex is appropriate for semi-structured XML data, however it is stored (last three columns). And an XMLIndex index with a structured component is useful for document-centric data that contains structured islands (fourth column).

Figure 6-1 XML Use Cases and XML Indexing

	Data-Centric		Document-Centric
Use Case	XML schema-based data, with little variation and little structural change over time	Variable, free-form data, with some fixed embedded structures	Variable, free-form data
Typical Data	Employee record	Technical article, with author, date, and title fields	Web document or book chapter
Storage Model	Object-Relational (Structured)	Binary XML	
Indexing	B-tree index	<ul style="list-style-type: none"> · XMLIndex index with structured and unstructured components · XML search index 	<ul style="list-style-type: none"> · XMLIndex index with unstructured component · XML search index

See Also:

- [XMLIndex Structured Component](#) (page 6-9)
 - [XMLIndex Unstructured Component](#) (page 6-15)
 - [Advantages of XMLIndex](#) (page 6-7) for a summary of the advantages provided by each XMLIndex component type
-

6.3.3 XMLIndex Structured Component

You create and use the structured component of an XMLIndex index for queries that project fixed, structured islands of XML content, even if the surrounding data is relatively unstructured.

A structured XMLIndex component organizes such islands in a *relational* format. In this it is similar to SQL/XML *function* XMLTable, and the syntax you use to define the structured component reflects this similarity. The relational tables used to store the indexing data are data-type aware, and each column can be of a different scalar data type.

You can thus think of the act of creating the structured component of an XMLIndex index as *decomposing* a structured portion of your XML data into relational format. This differs from the object-relational storage model of XMLType in these ways:

- A structured index component *explicitly* decomposes particular *portions* of your data, which you specify — portions that you commonly query. Object-relational XMLType storage involves automatic decomposition of an entire XMLType table or column.

- The structured component of an XMLIndex index applies to both XML schema-based and non-schema-based data. Object-relational XMLType storage applies only to data that is based on an XML schema.
- The decomposed data for a structured XMLIndex component is stored in addition to the XMLType data, as an index, rather than being the storage model for the XMLType data itself.
- For a structured XMLIndex component, the same data can be projected multiple times, as columns of different data type.

The index content tables used for the structured component of an XMLIndex index are part of the index, but because they are normal relational tables you can, in turn, *index* them using any standard relational indexes, including indexes that satisfy primary-key and foreign-key constraints. You can also index them using domain indexes, such as an Oracle Text CONTEXT index.

Another way to look at the structured component of an XMLIndex index sees that it acts as a *generalized function-based index*. A function-based index is similar to a structured XMLIndex component that has only one relational column.

If you find that for a particular application you are creating multiple function-based indexes, then consider using an XMLIndex index with a structured component instead. Create also B-tree indexes on the columns of the structured index component.

Note:

- Queries that use SQL/XML function XMLTable can typically be automatically rewritten to use the relational indexing tables of an XMLIndex structured component. In particular, SQL ORDER BY, GROUP BY, and window constructs operating on columns of an XMLTable virtual table are rewritten to the same constructs operating on the real columns of the relational indexing tables of the structured XMLIndex component.

The relational tables used for XMLIndex structured indexing also contain some internal, system-defined columns. These internal columns might change in the future, so do not write code that depends on any assumptions about their existence or contents.

- Queries that use Oracle SQL function XMLSequence within a SQL TABLE collection expression, that is, TABLE (XMLSequence(. . .)), are *not* rewritten to use the indexing tables of an XMLIndex structured component. Oracle SQL function XMLSequence is *deprecated* in Oracle Database 11g Release 2; use standard SQL/XML function XMLTable instead.

See *Oracle Database SQL Language Reference* for information about the SQL TABLE collection expression.

See Also:

- [Use of XMLIndex with a Structured Component](#) (page 6-26)
 - [SQL/XML Functions XMLQUERY, XMLTABLE, XMLExists, and XMLCast](#) (page 4-9)
 - [Function-Based Indexes Are Deprecated for XMLType](#) (page 6-6)
-

6.3.3.1 Ignore the Index Content Tables; They Are Transparent

Although the index content tables of an XMLIndex structured component are normal relational tables, they are also *read-only*: you cannot add or drop their columns or modify (insert, update, or delete) their rows.

You can thus generally ignore the relational index content tables. You cannot access them, other than to DESCRIBE them and create (secondary) indexes on them. You need never explicitly gather statistics on them. You need only collect statistics on the XMLIndex index itself or the base table on which the XMLIndex index is defined; statistics are collected and maintained on the index content tables transparently.

See Also:

[Collecting Statistics on XMLIndex Objects for the Cost-Based Optimizer](#) (page 6-44)

6.3.3.2 Data Type Considerations for XMLIndex Structured Component

The relational tables that are used for an XMLIndex structured component use SQL data types. XQuery expressions that are used in queries use XML data types (XML Schema data types and XQuery data types).

XQuery typing rules can automatically change the data type of a subexpression, to ensure coherence and type-checking. For example, if a document that is queried using XPath expression `/PurchaseOrder/LineItem[@ItemNumber = 25]` is not XML schema-based, then the subexpression `@ItemNumber` is untyped, and it is then automatically cast to `xs:double` by the XQuery = comparison operator. To index this data using an XMLIndex structured component you must use `BINARY_DOUBLE` as the SQL data type.

This is a general rule. For an XMLIndex index with structured component to apply to a query, the data types must correspond. [Table 6-5](#) (page 6-11) shows the data-type correspondences.

Table 6-5 XML and SQL Data Type Correspondence for XMLIndex

XML Data Type	SQL Data Type
<code>xs:decimal</code>	INTEGER or NUMBER
<code>xs:double</code>	BINARY_DOUBLE
<code>xs:float</code>	BINARY_FLOAT
<code>xs:date</code>	DATE, TIMESTAMP WITH TIMEZONE

Table 6-5 (Cont.) XML and SQL Data Type Correspondence for XMLIndex

XML Data Type	SQL Data Type
<code>xs:dateTime</code>	TIMESTAMP, TIMESTAMP WITH TIMEZONE
<code>xs:dayTimeDuration</code>	INTERVAL DAY TO SECOND
<code>xs:yearMonthDuration</code>	INTERVAL YEAR TO MONTH

Note:

If the XML data type is `xs:date` or `xs:dateTime`, and if you know that the data that you will query and for which you are creating an index will *not* contain a time-zone component, then you can increase performance by using SQL data type `DATE` or `TIMESTAMP`. If the data might contain a time-zone component, then you must use SQL data type `TIMESTAMP WITH TIMEZONE`.

If the XML and SQL data types involved do not have a built-in one-to-one correspondence, then you must make them correspond (according to [Table 6-5](#) (page 6-11)), in order for the index to be picked up for your query. There are two ways you can do this:

- **Make the index correspond to the query** – Define (or redefine) the column in the structured index component, so that it corresponds to the XML data type. For example, if a query that you want to index uses the XML data type `xs:double`, then define the index to use the corresponding SQL data type, `BINARY_DOUBLE`.
- **Make the query correspond to the index** – In your query, explicitly cast the relevant parts of an XQuery expression to data types that correspond to the SQL data types used in the index content table.

[Example 6-1](#) (page 6-13) and [Example 6-2](#) (page 6-13) show how you can cast an XQuery expression in your query to match the SQL data type used in the index content table.

Notice that the number 25 plays a different role in these two examples, even though in both cases it is the purchase-order item number. In [Example 6-1](#) (page 6-13), 25 is a SQL number of data type `INTEGER`; in [Example 6-2](#) (page 6-13), 25 is an XQuery number of data type `xs:decimal`.

In [Example 6-1](#) (page 6-13), the XQuery result is cast to SQL type `INTEGER`, which is compared with the SQL value 25. In [Example 6-2](#) (page 6-13), the value of attribute `ItemNumber` is cast (in XQuery) to the XML data type `xs:decimal`, which is compared with the XQuery value 25 and which corresponds to the SQL data type (`INTEGER`) used for the index. There are thus two different kinds of data-type conversion in these examples, but they both convert query data to make it type-compatible with the index content table.

See Also:

[Use DBMS_XMLSCHEMA to Map XML Schema Data Types to SQL Data Types](#) (page 18-20) for information about the built-in correspondence between XML Schema data types and SQL data types

Example 6-1 Making Query Data Compatible with Index Data – SQL Cast

```
SELECT count(*) FROM purchaseorder
   WHERE XMLCast(XMLQuery('$p/PurchaseOrder/LineItem/@ItemNumber'
                          PASSING OBJECT_VALUE AS "p" RETURNING CONTENT)
                 AS INTEGER)
        = 25;
```

Example 6-2 Making Query Data Compatible with Index Data – XQuery Cast

```
SELECT count(*) FROM purchaseorder
   WHERE XMLEExists('$p/PurchaseOrder/LineItem[xs:decimal(@ItemNumber) = 25]'
                    PASSING OBJECT_VALUE AS "p");
```

6.3.3.3 Exchange Partitioning and XMLIndex

In exchange partitioning, you exchange a table with a partition of another table. The first table must have the same structure as the partition of the second table, with which it is to be exchanged. The two tables must also be similar with respect to indexing with an XMLIndex index.

One of the following must be true:

- Neither table has an XMLIndex index.
- Both have an XMLIndex index, and one of the following is true:
 - Neither index has a structured component.
 - Both indexes have a structured component.

If none of those conditions holds then you *cannot* perform exchange partitioning.

If both tables have an XMLIndex index with a structured component then in the general case you must perform some preprocessing before invoking ALTER TABLE EXCHANGE PARTITION, and you must perform some postprocessing after invoking it. Otherwise, the exchange-partition operation raises an error.

You use PL/SQL procedures **exchangePreProc** and **exchangePostProc** in package DBMS_XMLSTORAGE_MANAGE to perform this preprocessing and postprocessing, as illustrated in [Example 6-3](#) (page 6-14). Each of the XMLType tables there, `table` and `exchange_table`, has an XMLIndex index that has a structured component.

In the special case of *reference*-partitioned tables there are foreign-key constraints involved, so things are a bit more complex. In this case, you use PL/SQL procedure **refPartitionExchangeIn** or **refPartitionExchangeOut**, to load data into (exchange-in) or out of (exchange-out) the partitioned tables, respectively.

[Example 6-4](#) (page 6-14) illustrates this, loading data from exchange tables `parent_ex` and `child_ex` into base tables `parent` and `child`. [Example 6-5](#) (page 6-15) shows the table and index definitions.

See Also:

- *Oracle Database SQL Language Reference*
 - *Oracle Database Data Cartridge Developer's Guide* for general information about using `ALTER TABLE EXCHANGE PARTITION` with tables that have domain indexes (XMLIndex is a domain index)
 - *Oracle Database PL/SQL Packages and Types Reference* for information about procedures `exchangePreProc`, `exchangePostProc`, `refPartitionExchangeIn`, and `refPartitionExchangeIOut` in package `DBMS_XMLSTORAGE_MANAGE`.
-

Example 6-3 Exchange-Partitioning Tables That Have an XMLIndex Structured Component

```
EXEC DBMS_XMLSTORAGE_MANAGE.exchangePreProc(USER, 'table');
EXEC DBMS_XMLSTORAGE_MANAGE.exchangePreProc(USER, 'exchange_table');

ALTER TABLE table EXCHANGE PARTITION partition WITH TABLE exchange_table
WITH VALIDATION UPDATE INDEXES;

EXEC DBMS_XMLSTORAGE_MANAGE.exchangePostProc(USER, 'table');
EXEC DBMS_XMLSTORAGE_MANAGE.exchangePostProc(USER, 'exchange_table');
```

Example 6-4 Exchange-Partitioning Reference-Partitioned Tables That Use XMLIndex

In this example:

- **parent** is the partitioned base table.
- **child** is a *reference*-partitioned child table with XMLType column `xcol`.
- **child_xidx** is an XMLIndex index with a structured component, defined on column `xcol` of table `child`. This is a local index, which is partitioned.
- **parent_ex** is the exchange table for base table `parent`.
- **child_ex** is the exchange table for child table `child`.
- **child_xidx_ex** is an XMLIndex index with a structured component, defined on column `xcol` of table `child_ex`. This is *not* a local index (unlike the case for index `child_xidx`).
- **USER** is the owner (database schema) of the tables.

This example performs an exchange-in operation, loading data from the exchange tables into the partitioned tables. An exchange-out operations, which loads data out of the partitioned tables into the exchange tables, would look the same, except that it would use procedure `refPartitionExchangeOut` instead. The procedure is passed the relevant tables and the necessary `ALTER TABLE ... EXCHANGE` statements.

```
EXEC DBMS_XMLSTORAGE_MANAGE.refPartitionExchangeIn(
    USER, 'parent', 'child', 'parent_ex', 'child_ex',
    'ALTER TABLE parent EXCHANGE PARTITION part_all WITH TABLE parent_ex
    INCLUDING INDEXES WITH VALIDATION UPDATE INDEXES',
    'ALTER TABLE child EXCHANGE PARTITION part_all WITH TABLE child_ex
    INCLUDING INDEXES WITH VALIDATION UPDATE INDEXES');
```

Example 6-5 Data Used in Example of Exchange-Partitioning for Reference-Partitioned Tables

This example shows the creation operations for the tables and indexes used in [Example 6-4](#) (page 6-14).

```
CREATE TABLE parent (id NUMBER PRIMARY KEY,
                    created DATE)
PARTITION BY RANGE (created)
(PARTITION part_2014 VALUES LESS THAN (to_date('01-jan-2015', 'dd-mon-yyyy')),
 PARTITION part_all VALUES LESS THAN (maxvalue));

CREATE TABLE child (parent_id NUMBER NOT NULL,
                    xcol XMLType,
                    CONSTRAINT child_tab_fk FOREIGN KEY (parent_id)
                                REFERENCES parent (id)
                                ENABLE VALIDATE)
XMLType COLUMN xcol STORE AS BINARY XML PARTITION BY REFERENCE (child_tab_fk);

CREATE INDEX child_xidx ON child p (xcol) INDEXTYPE IS XDB.XMLIndex
PARAMETERS ('XMLTable po_index_tab 'purchaseorder'
            COLUMNS pid NUMBER(4) PATH '@id') LOCAL ;

CREATE TABLE parent_ex (id NUMBER PRIMARY KEY,
                       created DATE);

CREATE TABLE child_ex (parent_id NUMBER NOT NULL,
                       xcol XMLType,
                       CONSTRAINT child_tab_fk1 FOREIGN KEY (parent_id)
                                REFERENCES parent_ex(id)
                                ENABLE VALIDATE)
XMLType COLUMN xcol STORE AS BINARY XML;

CREATE INDEX child_ex_xidx ON child_ex p (xcol) INDEXTYPE IS XDB.XMLIndex
PARAMETERS ('XMLTable po_index_tab_ex 'purchaseorder'
            COLUMNS pid NUMBER(4) PATH '@id');
```

6.3.4 XMLIndex Unstructured Component

Unlike a B-tree index, which you define for a specific database column that represents an individual XML element or attribute, or the XMLIndex structured component, which applies to specific, structured document parts, the unstructured component of an XMLIndex index is, by default, very general.

Unless you specify a more narrow focus by detailing specific XPath expressions to use or not to use in indexing, an unstructured XMLIndex component applies to *all possible XPath expressions* for your XML data.

The unstructured component of an XMLIndex index has three logical parts:

- A **path index** – This indexes the XML *tags* of a document and identifies its various document *fragments*.
- An **order index** – This indexes the hierarchical *positions* of the nodes in an XML document. It keeps track of parent–child, ancestor–descendant, and sibling relations.
- A **value index** – This indexes the *values* of an XML document. It provides lookup by either value equality or value range. A value index is used for values in query predicates (WHERE clause).

The unstructured component of an `XMLIndex` index uses a path table and a set of (local) secondary indexes on the path table, which implement the logical parts described above. Two secondary indexes are created automatically:

- A **pikey index**, which implements the logical indexes for both path and order.
- A real **value index**, which implements the logical value index.

You can modify these two indexes or create additional secondary indexes. The path table and its secondary indexes are all owned by the owner of the base table upon which the `XMLIndex` index is created.

The pikey index handles paths and order relationships together, which gives the best performance in most cases. If you find in some particular case that the value index is not picked up when think it should be, you can replace the pikey index with separate indexes for the paths and order relationships. Such (optional) indexes are called **path id** and **order key** indexes, respectively. For best results, contact Oracle Support if you find that the pikey index is not sufficient for your needs in some case.

The path table contains one row for each indexed node in the XML document. For each indexed node, the **path table** stores:

- The corresponding *rowid* of the table that stores the document.
- A *locator*, which provides fast access to the corresponding document fragment. For binary XML storage of XML schema-based data, it also stores data-type information.
- An *order key*, to record the hierarchical position of the node in the document. You can think of this as a Dewey decimal key like that used in library cataloging and Internet protocol SNMP. In such a system, the key 3 . 21 . 5 represents the node position of the fifth child of the twenty-first child of the third child of the document root node.
- An identifier that represents an XPath *path* to the node.
- The effective *text value* of the node.

Table 6-6 (page 6-16) shows the main information²² that is in the path table.

Table 6-6 XMLIndex Path Table

Column	Data Type	Description
PATHID	RAW(8)	Unique identifier for the XPath path to the node.
RID	ROWID	Rowid of the table used to store the XML data.
ORDER_KEY	RAW(1000)	Decimal order key that identifies the hierarchical position of the node. (Document ordering is preserved.)
LOCATOR	RAW(2000)	Fragment-location information. Used for fragment extraction. For binary XML storage of XML schema-based data, data-type information is also stored here.
VALUE	VARCHAR2(4000)	Effective text value the node.

² The actual path table implementation may be slightly different.

The pikey index uses path table columns `PATHID`, `RID`, and `ORDER_KEY` to represent the path and order indexes. An optional path id index uses columns `PATHID` and `RID` to represent the path index. A value index is an index on the `VALUE` column.

[Example 6-6](#) (page 6-17) explores the contents of the path table for two purchase-order documents.

Example 6-6 Path Table Contents for Two Purchase Orders

```
<PurchaseOrder>
  <Reference>SBELL-2002100912333601PDT</Reference>
  <Actions>
    <Action>
      <User>SVOLLMAN</User>
    </Action>
  </Actions>
  . . .
</PurchaseOrder>

<PurchaseOrder>
  <Reference>ABEL-20021127121040897PST</Reference>
  <Actions>
    <Action>
      <User>ZLOTKEY</User>
    </Action>
    <Action>
      <User>KING</User>
    </Action>
  </Actions>
  . . .
</PurchaseOrder>
```

An `XMLIndex` index on an `XMLType` table or column storing these purchase orders includes a path table that has one row for each indexed node in the XML documents. Suppose that the system assigns the following `PATHIDS` when indexing the nodes according to their `XPath` expressions:

PATHID	Indexed XPath
1	<code>/PurchaseOrder</code>
2	<code>/PurchaseOrder/Reference</code>
3	<code>/PurchaseOrder/Actions</code>
4	<code>/PurchaseOrder/Actions/Action</code>
5	<code>/PurchaseOrder/Actions/Action/User</code>

The resulting path table would then be something like this (column `LOCATOR` is not shown):

PATHID	RID	ORDER_KEY	VALUE
1	R1	1	SBELL-2002100912333601PDTSVOLLMAN
2	R1	1.1	SBELL-2002100912333601PDT

PATHID	RID	ORDER_KEY	VALUE
3	R1	1.2	SVOLLMAN
4	R1	1.2.1	SVOLLMAN
5	R1	1.2.1.1	SVOLLMAN
1	R2	1	ABEL-20021127121040897PSTZLOTKEYKING
2	R2	1.1	ABEL-20021127121040897PST
3	R2	1.2	ZLOTKEYKING
4	R2	1.2.1	ZLOTKEY
5	R2	1.2.1.1	ZLOTKEY
4	R2	1.2.2	KING
5	R2	1.2.2.1	KING

6.3.4.1 Ignore the Path Table – It Is Transparent

Though you can create secondary indexes on path-table columns, you can generally ignore the path table itself.

You *cannot access* the path table, other than to DESCRIBE it and create (secondary) indexes on it. You need never explicitly gather statistics on the path table. You need only collect statistics on the XMLIndex index or the base table on which the XMLIndex index is defined; statistics are collected and maintained on the path table and its secondary indexes transparently.

See Also:

[Collecting Statistics on XMLIndex Objects for the Cost-Based Optimizer](#)
(page 6-44)

6.3.4.2 Column VALUE of an XMLIndex Path Table

A secondary index on column VALUE is used with XPath expressions in a WHERE clause that have predicates involving string matches. For example:

```
/PurchaseOrder[Reference/text() = "SBELL-2002100912333601PDT"]
```

Column VALUE stores the **effective text value** of an element or an attribute node — comments and processing instructions are ignored during indexing.

- For an *attribute*, the effective text value is the attribute value.
- For a *simple* element (an element that has no children), the effective text value is the concatenation of all of the text nodes of the element.
- For a *complex* element (an element that has children), the effective text value is the concatenation of (1) the text nodes of the element itself and (2) the effective text values of all of its simple-element descendants. (This is a recursive definition.)

The effective text value is limited (truncated), however, to 4000 bytes for a simple element or attribute and to 80 bytes for a complex element.

Column `VALUE` is a fixed size, `VARCHAR2(4000)`. Any overflow (beyond 4000 bytes) during index creation or update is truncated.

In addition to the 4000-byte limit for column `VALUE`, there is a limit on the size of a key for the secondary index created on this column. This is the case for B-tree and function-based indexes as well; it is not an `XMLIndex` limitation. The index-key size limit is a function of the block size for your database. It is this limit that determines how much of `VALUE` is indexed.

Thus, only the first 4000 bytes of the effective text value are stored in column `VALUE`, and only the first N bytes of column `VALUE` are indexed, where N is the index-key size limit ($N < 4000$). Because of the index-key size limit, the index on column `VALUE` acts only as a *preliminary filter* for the effective text value.

For example, suppose that your database block size requires that the `VALUE` index be no larger than 800 bytes, so that only the first 800 bytes of the effective text value is indexed. The first 800 bytes of the effective text value is first tested, using `XMLIndex`, and only if that text prefix matches the query value is the rest of the effective text value tested.

The secondary index on column `VALUE` is an index on SQL function `substr` (substring equality), because that function is used to test the text prefix. This function-based index is created automatically as part of the implementation of `XMLIndex` for column `VALUE`.

For example, the XPath expression `/PurchaseOrder[Reference/text() = :1]` in a query `WHERE` clause might, in effect, be rewritten to a test something like this:

```
substr(VALUE, 1 800) = substr(:1, 1, 800) AND VALUE = :1;
```

This conjunction contains two parts, which are processed from left to right. The first test uses the index on function `substr` as a preliminary filter, to eliminate text whose first 800 bytes do not match the first 800 bytes of the value of bind variable `:1`.

Only the first test uses an index — the full value of column `VALUE` is not indexed. After preliminary filtering by the first test, the second test checks the entire effective text value — that is, the full value of column `VALUE` — for full equality with the value of `:1`. This check does not use an index.

Even if only the first 800 bytes of text is indexed, it is important for query performance that up to 4000 bytes be stored in column `VALUE`, because that provides quick, direct access to the data, instead of requiring, for example, extracting it from deep within a `CLOB`-instance XML document. If the effective text value is greater than 4000 bytes, then the second test in the `WHERE`-clause conjunction requires accessing the base-table data.

Neither the `VALUE` column 4000-byte limit nor the index-key size affect query results in any way; they can affect only performance.

Note:

Because of the possibility of the `VALUE` column being truncated, an Oracle Text `CONTEXT` index created on the `VALUE` column might return incorrect results.

As mentioned, XMLIndex can be used with XML schema-based data. If an XML schema specifies a `defaultValue` value for a given element or attribute, and a particular document does not specify a value for that element or attribute, then the `defaultValue` value is used for the `VALUE` column.

6.3.4.3 Secondary Indexes on Column `VALUE`

Even if you do not specify a secondary index for column `VALUE` when you create an XMLIndex index, a default secondary index is created on column `VALUE`. This default index has the default properties — in particular, it is an index for *text* (string-valued) data only.

You can, however, create a `VALUE` index of a different type. For example, you can create a number-valued index if that is appropriate for many of your queries. You can create multiple secondary indexes on the `VALUE` column. An index of a particular type is used only when it is appropriate. For example, a number-valued index is used only when the `VALUE` column is a number; it is ignored for other values. Secondary indexes on path-table columns are treated like any other secondary indexes — you can alter them, drop them, mark them unusable, and so on.

See Also:

- [Using XMLIndex with an Unstructured Component](#) (page 6-22) for examples of creating secondary indexes on column `VALUE`
 - [PARAMETERS Clause for CREATE INDEX and ALTER INDEX](#) (page 6-46) for the syntax of the `PARAMETERS` clause
-
-

6.3.4.4 XPath Expressions That Are Not Indexed by an XMLIndex Unstructured Component

A few types of XPath expressions are *not* indexed by XMLIndex.

- Applications of XPath functions, *except* `ora:contains` (which is *deprecated*). In particular, user-defined XPath functions are *not* indexed.
- Axes other than `child`, `descendant`, and `attribute`, that is, axes `parent`, `ancestor`, `following-sibling`, `preceding-sibling`, `following`, `preceding`, and `ancestor-or-self`.
- Expressions using the union operator, `|` (vertical bar).

6.3.5 Creating, Dropping, Altering, and Examining an XMLIndex Index

Basic operations on an XMLIndex index include creating it, dropping it, altering it, and examining it. Examples are presented.

You create an XMLIndex index by declaring the index type to be `XDB.XMLIndex`, as illustrated in [Example 6-7](#) (page 6-21).

This creates an XMLIndex index named `po_xmlindex_ix` on XMLType table `po_binxml`. The index has only an unstructured component, no structured component.

You specify inclusion of a *structured* component in an XMLIndex index by including a *structured_clause* in the `PARAMETERS` clause. You specify inclusion of an

unstructured component by including a *path_table_clause* in the `PARAMETERS` clause.

You can do this when you create the `XMLIndex` index or when you modify it. If, as in [Example 6-7](#) (page 6-21), you specify neither a *structured_clause* nor a *path_table_clause*, then *only* an unstructured component is included.

If an `XMLIndex` index has both an unstructured and a structured component, then you can drop either of these components using `ALTER INDEX`.

See Also:

- [PARAMETERS Clause for CREATE INDEX and ALTER INDEX](#) (page 6-46)
 - [structured_clause ::=](#) (page 6-50)
 - [path_table_clause ::=](#) (page 6-49)
 - [drop_path_table_clause ::=](#) (page 6-50)
 - [alter_index_group_clause ::=](#) (page 6-52)
-
-

You can obtain the name of an `XMLIndex` index on a particular `XMLType` table (or column), as shown in [Example 6-8](#) (page 6-21). You can also select `INDEX_NAME` from `DBA_INDEXES` or `ALL_INDEXES`, as appropriate.

You rename or drop an `XMLIndex` index just as you would any other index, as illustrated in [Example 6-9](#) (page 6-22). This renaming changes the name of the `XMLIndex` index only. It does not change the name of the path table — you can rename the path table separately.

Similarly, you can change other index properties using other `ALTER INDEX` options, such as `REBUILD`. `XMLIndex` is no different from other index types in this respect.

The `RENAME` clause of an `ALTER INDEX` statement for `XMLIndex` applies only to the `XMLIndex` index itself. To rename the path table and secondary indexes, you must determine the names of these objects and use appropriate `ALTER TABLE` or `ALTER INDEX` statements on them directly. Similarly, to retrieve the physical properties of the secondary indexes or alter them in any other way, you must obtain their names, as in [Example 6-14](#) (page 6-23).

See Also:

[PARAMETERS Clause for CREATE INDEX and ALTER INDEX](#) (page 6-46) for the syntax of the `PARAMETERS` clause

Example 6-7 Creating an XMLIndex Index

```
CREATE INDEX po_xmlindex_ix ON po_binxml (OBJECT_VALUE) INDEXTYPE IS XDB.XMLIndex;
```

Example 6-8 Obtaining the Name of an XMLIndex Index on a Particular Table

```
SELECT INDEX_NAME FROM USER_INDEXES
       WHERE TABLE_NAME = 'PO_BINXML' AND ITYP_NAME = 'XMLINDEX';
```

```
INDEX_NAME
```

```
-----  
PO_XMLINDEX_IX  
  
1 row selected.
```

Example 6-9 Renaming and Dropping an XMLIndex Index

```
ALTER INDEX po_xmlindex_ix RENAME TO new_name_ix;  
  
DROP INDEX new_name_ix;
```

6.3.6 Using XMLIndex with an Unstructured Component

You can perform various operations on an XMLIndex index that has an unstructured component, including manipulating the path table and the secondary indexes of that component.

To include an unstructured component in an XMLIndex index, you can use a *path_table_clause* in the PARAMETERS clause when you create or modify the XMLIndex index — see [path_table_clause ::=](#) (page 6-49).

If you do not specify a *structured* component, then the index will have an unstructured component, even if you do not specify the path table. It is however generally a good idea to specify the path table, so that it has a recognizable, user-oriented name that you can refer to in other XMLIndex operations.

[Example 6-10](#) (page 6-23) shows how to name the path table ("my_path_table") when creating an XMLIndex index with an unstructured component.

If you do not name the path table then its name is generated by the system, using the index name you provide to CREATE INDEX as a base. [Example 6-11](#) (page 6-23) shows this for the XMLIndex index created in [Example 6-7](#) (page 6-21).

By default, the storage options of a path table and its secondary indexes are derived from the storage properties of the base table on which the XMLIndex index is created. You can specify different storage options by using a PARAMETERS clause when you create the index, as shown in [Example 6-12](#) (page 6-23). The PARAMETERS clause of CREATE INDEX (and ALTER INDEX) must be between single quotation marks ('').

See Also:

[PARAMETERS Clause for CREATE INDEX and ALTER INDEX](#) (page 6-46)
for the syntax of the PARAMETERS clause

Because XMLIndex is a logical *domain* index, not a physical index, all physical attributes are either zero (0) or NULL.

If an XMLIndex index has both an unstructured and a structured component, then you can use ALTER INDEX to drop the unstructured component. To do this, you drop the path table. [Example 6-13](#) (page 6-23) illustrates this. (This assumes that you also have a structured component — [Example 6-23](#) (page 6-28) results in an index with both structured and unstructured components.)

In addition to specifying storage options for the path table, [Example 6-12](#) (page 6-23) names the secondary indexes on the path table.

Like the name of the path table, the names of the secondary indexes on the path-table columns are generated automatically using the index name as a base, unless you specify them in the PARAMETERS clause. [Example 6-14](#) (page 6-23) illustrates this,

and shows how you can determine these names using public view `USER_IND_COLUMNS`. It also shows that the pikey index uses three columns.

See Also:

[Example 6-20](#) (page 6-25) for a similar, but more complex example

Example 6-10 Naming the Path Table of an XMLIndex Index

```
CREATE INDEX po_xmlindex_ix ON po_binxml (OBJECT_VALUE) INDEXTYPE IS XDB.XMLIndex
  PARAMETERS ('PATH TABLE my_path_table');
```

Example 6-11 Determining the System-Generated Name of an XMLIndex Path Table

```
SELECT PATH_TABLE_NAME FROM USER_XML_INDEXES
  WHERE TABLE_NAME = 'PO_BINXML' AND INDEX_NAME = 'PO_XMLINDEX_IX';
```

```
PATH_TABLE_NAME
-----
SYS67567_PO_XMLINDE_PATH_TABLE
```

1 row selected.

Example 6-12 Specifying Storage Options When Creating an XMLIndex Index

```
CREATE INDEX po_xmlindex_ix ON po_binxml (OBJECT_VALUE) INDEXTYPE IS XDB.XMLIndex
  PARAMETERS
    ('PATH TABLE po_path_table
    (PCTFREE 5 PCTUSED 90 INITRANS 5
    STORAGE (INITIAL 1k NEXT 2k MINEXTENTS 3 BUFFER_POOL KEEP)
    NOLOGGING ENABLE ROW MOVEMENT PARALLEL 3)
    PIKEY INDEX po_pikey_ix (LOGGING PCTFREE 1 INITRANS 3)
    VALUE INDEX po_value_ix (LOGGING PCTFREE 1 INITRANS 3)');
```

Example 6-13 Dropping an XMLIndex Unstructured Component

```
ALTER INDEX po_xmlindex_ix PARAMETERS('DROP PATH TABLE');
```

Example 6-14 Determining the Names of the Secondary Indexes of an XMLIndex Index

```
SELECT INDEX_NAME, COLUMN_NAME, COLUMN_POSITION FROM USER_IND_COLUMNS
  WHERE TABLE_NAME IN (SELECT PATH_TABLE_NAME FROM USER_XML_INDEXES
                        WHERE INDEX_NAME = 'PO_XMLINDEX_IX')
  ORDER BY INDEX_NAME, COLUMN_NAME;
```

```
INDEX_NAME                COLUMN_NAME  COLUMN_POSITION
-----
SYS67563_PO_XMLINDE_PIKEY_IX  ORDER_KEY      3
SYS67563_PO_XMLINDE_PIKEY_IX  PATHID         2
SYS67563_PO_XMLINDE_PIKEY_IX  RID            1
SYS67563_PO_XMLINDE_VALUE_IX  SYS_NC00006$  1
```

4 rows selected.

6.3.6.1 Creating Additional Secondary Indexes on an XMLIndex Path Table

You can add extra secondary indexes to an XMLIndex unstructured component.

Examples [Example 6-15](#) (page 6-25), [Example 6-17](#) (page 6-25), [Example 6-18](#) (page 6-25), and [Example 6-19](#) (page 6-25) add extra secondary indexes to the XMLIndex index created in [Example 6-12](#) (page 6-23).

You can create any number of additional secondary indexes on the VALUE column of the path table of an XMLIndex index. These can be of different types, including function-based indexes and Oracle Text indexes.

Whether or not a given index is used for a given element occurrence when processing a query is determined by whether it is of the appropriate type for that value and whether it is cost-effective to use it.

[Example 6-15](#) (page 6-25) creates a function-based index on column VALUE of the path table using SQL function `substr`. This might be useful if your queries often use `substr` applied to the text nodes of XML elements.

If you have many elements whose text nodes represent numeric values, then it can make sense to create a numeric index on the column VALUE. However, doing so directly, in a manner analogous to [Example 6-15](#) (page 6-25), raises an ORA-01722 error (invalid number) if some of the element values are *not* numbers. This is illustrated in [Example 6-16](#) (page 6-25).

What is needed is an index that is used for numeric-valued elements but is ignored for element occurrences that do not have numeric values. Procedure `createNumberIndex` of package `DBMS_XMLINDEX` exists specifically for this purpose. You pass it the names of the database schema, the XMLIndex index, and the numeric index to be created. Creation of a numeric index is illustrated in [Example 6-17](#) (page 6-25).

Because such an index is specifically designed to ignore elements that do not have numeric values, its use does not detect their presence. If there are non-numeric elements and, for whatever reason, the XMLIndex index is not used in some query, then an ORA-01722 error is raised. However, if the index is used, no such error is raised, because the index ignores non-numeric data. As always, the use of an index never changes the result set — it never gives you different results, but use of an index can prevent you from detecting erroneous data.

Creating a date-valued index is similar to creating a numeric index; you use procedure `DBMS_XMLINDEX.createDateIndex`. [Example 6-18](#) (page 6-25) shows this.

[Example 6-19](#) (page 6-25) creates an Oracle Text CONTEXT index on column VALUE. This is useful for full-text queries on text values of XML elements. XPath predicates that use XPath function `ora:contains` (*deprecated*) are rewritten to applications of Oracle SQL function `contains` on column VALUE. If a CONTEXT index is defined on column VALUE, then it is used during predicate evaluation. An Oracle Text index is independent of all other VALUE-column indexes.

See Also:

- [Column VALUE of an XMLIndex Path Table](#) (page 6-18) for information about the possibility of an Oracle Text CONTEXT index created on the VALUE column returning incorrect results
 - [Indexing XML Data for Full-Text Queries](#) (page 6-56)
 - *Oracle Text Reference* for information about CREATE INDEX parameter TRANSACTIONAL
-
-

The query in [Example 6-20](#) (page 6-25) shows all of the secondary indexes created on the path table of an XMLIndex index. The indexes created explicitly are in bold. Note in particular that some indexes, such as the function-based index created on column VALUE, do not appear as such; the column name listed for such an index is a system-generated name such as SYS_NC00007\$. You *cannot* see these columns by executing a query with COLUMN_NAME = 'VALUE' in the WHERE clause.

See Also:

Oracle Database PL/SQL Packages and Types Reference for information on PL/SQL procedures createNumberIndex and createDateIndex in package DBMS_XMLINDEX

Example 6-15 Creating a Function-Based Index on Path-Table Column VALUE

```
CREATE INDEX fn_based_ix ON po_path_table (substr(VALUE, 1, 100));
```

Example 6-16 Trying to Create a Numeric Index on Path-Table Column VALUE Directly

```
CREATE INDEX direct_num_ix ON po_path_table (to_binary_double(VALUE));
CREATE INDEX direct_num_ix ON po_path_table (to_binary_double(VALUE))
*
```

```
ERROR at line 1:
ORA-01722: invalid number
```

Example 6-17 Creating a Numeric Index on Column VALUE with Procedure createNumberIndex

```
CALL DBMS_XMLINDEX.createNumberIndex('OE', 'PO_XMLINDEX_IX', 'API_NUM_IX');
```

Example 6-18 Creating a Date Index on Column VALUE with Procedure createDateIndex

```
CALL DBMS_XMLINDEX.createDateIndex('OE', 'PO_XMLINDEX_IX', 'API_DATE_IX',
'dateTime');
```

Example 6-19 Creating an Oracle Text CONTEXT Index on Path-Table Column VALUE

```
CREATE INDEX po_otext_ix ON po_path_table (VALUE)
INDEXTYPE IS CTXSYS.CONTEXT PARAMETERS('TRANSACTIONAL');
```

Example 6-20 Showing All Secondary Indexes on an XMLIndex Path Table

```
SELECT c.INDEX_NAME, c.COLUMN_NAME, c.COLUMN_POSITION, e.COLUMN_EXPRESSION
FROM USER_IND_COLUMNS c LEFT OUTER JOIN USER_IND_EXPRESSIONS e
ON (c.INDEX_NAME = e.INDEX_NAME)
WHERE c.TABLE_NAME IN (SELECT PATH_TABLE_NAME FROM USER_XML_INDEXES
WHERE INDEX_NAME = 'PO_XMLINDEX_IX')
ORDER BY c.INDEX_NAME, c.COLUMN_NAME;
```

INDEX_NAME	COLUMN_NAME	COLUMN_POSITION	COLUMN_EXPRESSION
API_DATE_IX	SYS_NC00009\$	1	SYS_EXTRACT_UTC(SYS_XMLCONV("VALUE", 3, 8, 0, 0, 181))
API_NUM_IX	SYS_NC00008\$	1	TO_BINARY_DOUBLE("VALUE")
FN_BASED_IX	SYS_NC00007\$	1	SUBSTR("VALUE", 1, 100)
PO_OTEXT_IX	VALUE	1	

PO_PIKEY_IX	ORDER_KEY	3
PO_PIKEY_IX	PATHID	2
PO_PIKEY_IX	RID	1
PO_VALUE_IX	SYS_NC00006\$	1 SUBSTRB("VALUE" ,1,1599)

8 rows selected.

6.3.7 Use of XMLIndex with a Structured Component

An XMLIndex structured component indexes specific islands of structure in your XML data.

To include a structured component in an XMLIndex index, you use a *structured_clause* in the PARAMETERS clause when you create or modify the XMLIndex index — see *structured_clause ::=* (page 6-50).

A *structured_clause* specifies the structured islands that you want to index. You use the keyword GROUP to specify each structured island: an island thus corresponds syntactically to a structure **group**. If you specify no group explicitly, then the predefined group DEFAULT_GROUP is used. For ALTER INDEX, you precede the GROUP keyword with the modification operation keyword: ADD_GROUP specifies a new group (island); DROP_GROUP deletes a group.

Why have multiple groups within a single index, instead of simply using multiple XMLIndex indexes? The reason is that XMLIndex is a domain index, and you can create only one domain index of a given type on a given database column.

The syntax for defining a structure group, that is, indexing a structured island, is similar to the syntax for invoking SQL/XML *function* XMLTable: you use keywords XMLTable and COLUMNS to define relational columns, and you use multilevel chaining of XMLTable to handle collections. To simplify the creation of such an index, you can use PL/SQL function DBMS_XMLSTORAGE_MANAGE.getSIDXDefFromView to provide exactly the XMLTable expression needed for creating the index.

See Also:

- [Indexing Binary XML Data Exposed Using a Relational View](#) (page 9-4) for information about using DBMS_XMLSTORAGE_MANAGE.getSIDXDefFromView
 - [Example 6-30](#) (page 6-35)
 - [Indexing XML Data for Full-Text Queries](#) (page 6-56)
 - [Using a Registered PARAMETERS Clause for XMLIndex](#) (page 6-47)
 - *structured_clause ::=* (page 6-50)
 - [Usage of XMLIndex_xmltable_clause](#) (page 6-55) for information about an XMLType column in an XMLTable clause
 - [Usage of column_clause](#) (page 6-56) for information about keywords COLUMNS and VIRTUAL
 - [Data Type Considerations for XMLIndex Structured Component](#) (page 6-11)
-

6.3.7.1 Using Namespaces and Storage Clauses with an XMLIndex Structured Component

When you create an XMLIndex index that has a structured component you can specify XML namespaces and storage options to use.

[Example 6-21](#) (page 6-27) shows the creation of an XMLIndex index that has only a structured component (no path-table clause) and that uses the XMLNAMESPACES clause to specify namespaces. It specifies that the index data be compressed and use tablespace USERTBS1. The example assumes a binary XML table po_binxml with non XML schema-based data.

Each of the (identical) TABLESPACE clauses in [Example 6-21](#) (page 6-27) applies at the table level (tables po_ptab and li_tab).

In general you can specify storage options at both the table level and the partition level. A specification at the partition level overrides one at the table level. A TABLESPACE clause can also be specified at the *index* level, that is, so that it applies to all of the partitions and tables used for the index. If TABLESPACE is specified at more than one level, the partition level overrides the table level, which overrides the index level.

[Example 6-22](#) (page 6-27) specifies the same TABLESPACE for each of the tables used in the index. This commonality can be factored out by specifying the TABLESPACE at the index level, as shown in [Example 6-22](#) (page 6-27).

Example 6-21 XMLIndex with a Structured Component, Using Namespaces and Storage Options

```
CREATE INDEX po_struct ON po_binxml (OBJECT_VALUE) INDEXTYPE IS XDB.XMLIndex
  PARAMETERS ('XMLTable po_ptab
    (TABLESPACE "USERTBS1" COMPRESS FOR OLTP)
    XMLNAMESPACES (DEFAULT 'http://www.example.com/po'),
    '/purchaseOrder'
    COLUMNS orderdate DATE PATH '@orderDate',
             id BINARY_DOUBLE PATH '@id',
             items XMLType PATH 'items/item' VIRTUAL
  XMLTable li_tab
    (TABLESPACE "USERTBS1" COMPRESS FOR OLTP)
    XMLNAMESPACES (DEFAULT 'http://www.example.com/po'),
    '/item' PASSING items
    COLUMNS partnum VARCHAR2(15) PATH '@partNum',
             description CLOB PATH 'productName',
             usprice BINARY_DOUBLE PATH 'USPrice',
             shipdat DATE PATH 'shipDate');
```

Example 6-22 XMLIndex with a Structured Component, Specifying TABLESPACE at the Index Level

```
CREATE INDEX po_struct ON po_binxml (OBJECT_VALUE) INDEXTYPE IS XDB.XMLIndex
  PARAMETERS ('XMLTable po_ptab,
    XMLNAMESPACES (DEFAULT 'http://www.example.com/po'),
    '/purchaseOrder'
    COLUMNS orderdate DATE PATH '@orderDate',
             id BINARY_DOUBLE PATH '@id',
             items XMLType PATH 'items/item' VIRTUAL
  XMLTable li_tab,
    XMLNAMESPACES (DEFAULT 'http://www.example.com/po'),
    '/item' PASSING items
    COLUMNS partnum VARCHAR2(15) PATH '@partNum',
             description CLOB PATH 'productName',
```

```

        usprice    BINARY_DOUBLE PATH 'USPrice',
        shipdat    DATE           PATH 'shipDate'
TABLESPACE "USERTBS1" COMPRESS FOR OLTP));

```

6.3.7.2 Adding a Structured Component to an XMLIndex Index

You can use `ALTER INDEX` to add a structured component to an existing XMLIndex index.

[Example 6-23](#) (page 6-28) shows the creation of an XMLIndex index with only an unstructured component. An unstructured component is created because the `PARAMETERS` clause explicitly names the path table.

[Example 6-23](#) (page 6-28) then uses `ALTER INDEX` to add a structured component (group) named `po_item`. This structure group includes two relational tables, each specified with keyword `XMLTable`.

The top-level table, `po_idx_tab`, has columns `reference`, `requestor`, `username`, and `lineitem`. Column `lineitem` is of type `XMLType`. It represents a collection, so it is passed to the second `XMLTable` construct to form the second-level relational table, `po_index_lineitem`, which has columns `itemno`, `description`, `partno`, `quantity`, and `unitprice`.

The keyword `VIRTUAL` is *required* for an `XMLType` column. It specifies that the `XMLType` column itself is not materialized: its data is stored in the XMLIndex index only in the form of the relational columns specified by its corresponding `XMLTable` table.

You cannot create more than one `XMLType` column in a given `XMLTable` clause. To achieve that effect, you must instead define an additional group.

[Example 6-23](#) (page 6-28) also illustrates the use of a registered parameter string in the `PARAMETERS` clause. It uses PL/SQL procedure `DBMS_XMLINDEX.registerParameter` to register the parameter string named `myparam`. Then it uses `ALTER INDEX` to update the index parameters to include those in the string `myparam`.

Example 6-23 XMLIndex Index: Adding a Structured Component

```

CREATE INDEX po_xmlindex_ix ON po_binxml (OBJECT_VALUE)
  INDEXTYPE IS XDB.XMLIndex PARAMETERS ('PATH TABLE path_tab');

BEGIN
  DBMS_XMLINDEX.registerParameter(
    'myparam',
    'ADD_GROUP GROUP po_item
      XMLTable po_idx_tab ''/PurchaseOrder''
        COLUMNS reference  VARCHAR2(30)  PATH ''Reference'',
                requestor  VARCHAR2(30)  PATH ''Requestor'',
                username    VARCHAR2(30)  PATH ''User'',
                lineitem    XMLType       PATH ''LineItems/LineItem'' VIRTUAL
      XMLTable po_index_lineitem ''/LineItem'' PASSING lineitem
        COLUMNS itemno    BINARY_DOUBLE PATH '@ItemNumber'',
                description VARCHAR2(256) PATH ''Description'',
                partno     VARCHAR2(14)  PATH ''Part/@Id'',
                quantity   BINARY_DOUBLE PATH ''Part/@Quantity'',
                unitprice   BINARY_DOUBLE PATH ''Part/@UnitPrice''');
END;
/

ALTER INDEX po_xmlindex_ix PARAMETERS('PARAM myparam');

```

6.3.7.3 Using Non-Blocking ALTER INDEX with an XMLIndex Structured Component

You can prevent `ALTER INDEX` from blocking when you add a group or column for the structured component of an `XMLIndex` index, so that queries that use the index do not need to wait.

When you use `ALTER INDEX` to add a group or a column for the structured component of an `XMLIndex` index, this index-maintenance operation obtains an exclusive DDL lock on the base table and the index.

The base table is locked to DML operations, and the index cannot be used for queries until the `ALTER INDEX` operation is finished. This means that during this index maintenance the index cannot be used by other sessions that query or perform DML operations on the base table. The duration of the `ALTER INDEX` operation and the attendant locking depends on the volume of data in the base `XMLType` column.

You can avoid or work around this problem as follows:

1. Use keyword **NONBLOCKING** before `ADD_GROUP` or `ADD_COLUMN` in the `PARAMETERS` clause of the `ALTER INDEX` statement that creates the structured-component group or column.

This updates the index as needed, but it does not index any base-table data. Because it does not depend on the base-table data it is quick regardless of the base-table size.

2. Invoke PL/SQL procedure `DBMS_XMLINDEX.process_pending`.

This procedure indexes rows of the base table and populates tables of the index, just as if keyword `NONBLOCKING` were absent. However, in this case only a few rows are locked at a time while they are processed and the changes committed. Rows that have already been locked for some other purpose are skipped. This can significantly reduce lock contention and allow indexing of some rows to proceed at the same time as querying or DML on other rows.

When procedure `process_pending` finishes it returns, as `OUT` parameters:

- The number of rows that it could not index. This is either because they were *locked* for another purpose or because an error was raised (this number includes the number returned as the other `OUT` parameter).

After you think those locks have been removed, invoke procedure `process_pending` again to try to process those pending rows.

- The number of rows that it could not index because an *error* was raised. (This should be rare.)

Check table `SYS_AIXSXI_index_number_ERRORTAB` for information about those errors, then take action to fix the underlying problems. *index_number* is the object number of the index.

3. Repeat step 2 as many times as necessary until procedure `process_pending` indicates that all rows have been successfully indexed or you encounter an insurmountable problem and decide to cancel the indexing operation altogether.

You can cancel the indexing at any time (before step 2) by using keywords **NONBLOCKING ABORT** in the `PARAMETERS` clause of a separate `ALTER INDEX` statement for the same `XMLIndex` index.

4. If all rows have been successfully indexed then use keywords **NONBLOCKING COMPLETE** in the PARAMETERS clause of a separate ALTER INDEX statement for the same XMLIndex index.

[Example 6-24](#) (page 6-30) illustrates this.

Just as table SYS_AIXSXI_index_number_ERRORTAB reports errors, so table SYS_AIXSXI_index_number_PENDINGTAB records the current status of each base-table row: whether or not it has been indexed. A row might not yet be indexed because it is locked by for some other purpose or because trying to index it raised an error. In the latter case, consult SYS_AIXSXI_index_number_ERRORTAB for specific information about the error.

See Also:

[alter_index_group_clause ::=](#) (page 6-52)

Example 6-24 Using DBMS_XMLINDEX.PROCESS_PENDING To Index XML Data

```
CREATE INDEX po_struct ON po_binxml (OBJECT_VALUE) INDEXTYPE IS XDB.XMLIndex
PARAMETERS ('XMLTable po_idx_tab
  '/PurchaseOrder'
  COLUMNS reference VARCHAR2(30) PATH 'Reference',
            requestor VARCHAR2(30) PATH 'Requestor',
            username VARCHAR2(30) PATH 'User',
            lineitem XMLType PATH 'LineItems/LineItem' VIRTUAL
  XMLTable po_index_lineitem
  '/LineItem' PASSING lineitem
  COLUMNS itemno BINARY_DOUBLE PATH '@ItemNumber',
            description VARCHAR2(256) PATH 'Description',
            partno VARCHAR2(14) PATH 'Part/@Id',
            quantity BINARY_DOUBLE PATH 'Part/@Quantity',
            unitprice BINARY_DOUBLE PATH 'Part/@UnitPrice');

ALTER INDEX po_struct
PARAMETERS('NONBLOCKING ADD_GROUP GROUP po_action_group
  XMLTABLE po_idx_tab
  '/PurchaseOrder'
  COLUMNS actions XMLType PATH 'Actions/Action' VIRTUAL
  XMLTABLE po_idx_action
  '/Action' PASSING actions
  COLUMNS actioned_by VARCHAR2(10) PATH 'User',
            date_actioned TIMESTAMP PATH 'Date');

DECLARE
  num_pending NUMBER := 0;
  num_errored NUMBER := 0;
BEGIN
  DBMS_XMLINDEX.process_pending('oe', 'po_struct', num_pending, num_errored);
  DBMS_OUTPUT.put_line('Number of rows still pending = ' || num_pending);
  DBMS_OUTPUT.put_line('Number of rows with errors = ' || num_errored);
END;
/
Number of rows still pending = 0
Number of rows with errors = 0

PL/SQL procedure successfully completed.

ALTER INDEX po_struct PARAMETERS('NONBLOCKING COMPLETE');
```

6.3.7.4 Modifying the Data Type of a Structured XMLIndex Component

If an error is raised because some of your data does not match the data type used for the corresponding column of the structured XMLIndex component, you can in some cases simply modify the index by passing keyword `MODIFY_COLUMN_TYPE` to `ALTER INDEX`.

You can, for example, expand a `VARCHAR2(30)` column to, say, `VARCHAR2(40)` if it needs to accommodate data that is up to 40 characters. This is simpler and more efficient than dropping the column and then adding a new column. The new data type must be compatible with the old one: the same restrictions apply as apply for `ALTER TABLE MODIFY COLUMN`.

See Also:

- *Oracle Database SQL Language Reference* for information about `ALTER TABLE MODIFY COLUMN`
 - [modify_column_type_clause ::=](#) (page 6-53)
-

6.3.7.5 Dropping an XMLIndex Structured Component

If an XMLIndex index has both an unstructured and a structured component, then you can use `ALTER INDEX` to drop the structured component. You do this by dropping *all* of the structure groups that compose the structured component.

[Example 6-25](#) (page 6-31) shows how to drop the structured component that was added in [Example 6-23](#) (page 6-28), by dropping its only structure group, `po_item`.

Example 6-25 Dropping an XMLIndex Structured Component

```
ALTER INDEX po_xmlindex_ix PARAMETERS('DROP_GROUP GROUP po_item');
```

6.3.7.6 Indexing the Relational Tables of a Structured XMLIndex Component

Because the tables used for the structured component of an XMLIndex index are normal relational tables, you can index them using any standard relational indexes.

This is explained in section [XMLIndex Structured Component](#) (page 6-9). It is illustrated by [Example 6-26](#) (page 6-31), which creates a B-tree index on the reference column of the index content table (structured fragment) for the XMLIndex index of [Example 6-23](#) (page 6-28).

Example 6-26 Creating a B-tree Index on an XMLIndex Index Content Table

```
CREATE INDEX idx_tab_ref_ix ON po_idx_tab (reference);
```

6.3.8 How to Tell Whether XMLIndex is Used

To know whether a particular XMLIndex index has been used in resolving a query, you can examine an execution plan for the query.

It is at query compile time that Oracle Database determines whether or not a given XMLIndex index can be used, that is, whether the query can be rewritten into a query against the index.

For an unstructured XMLIndex component, if it cannot be determined at compile time that an XPath expression in the query is a subset of the paths you specified to be used for XMLIndex indexing, then the unstructured component of the index is not used.

For example, if the path `/PurchaseOrder/LineItems/**` is included for indexing, then a query with `/PurchaseOrder/LineItems/LineItem/Description` can use the index, but a query with `//Description` cannot. The latter also matches potential `Description` elements that are not children of `/PurchaseOrder/LineItems`, and it is not possible at compile time to know if such additional `Description` elements are present in the data.

You can examine the execution plan for a query to see whether a particular `XMLIndex` index has been used in resolving the query.

- If the *unstructured* component of the index is used, then its path table, order key, or path id is referenced in the execution plan. The execution plan does *not* directly indicate that a domain index was used; it does *not* refer to the `XMLIndex` index by name. See [Example 6-27](#) (page 6-33) and [Example 6-29](#) (page 6-34).
- If the *structured* component of the index is used, then one or more of its index content tables is called out in the execution plan. See [Example 6-30](#) (page 6-35) and [Example 6-31](#) (page 6-36).

See Also:

Oracle Database SQL Tuning Guide

[Example 6-27](#) (page 6-33) shows that the `XMLIndex` index created in [Example 6-10](#) (page 6-23) is used in a particular query. The reference to `MY_PATH_TABLE` in the execution plan here indicates that the `XMLIndex` index (created in [Example 6-10](#) (page 6-23)) is used in this query. Similarly, reference to columns `LOCATOR`, `ORDER_KEY`, and `PATHID` indicates the same thing.

Given the name of a path table from an execution plan such as this, you can obtain the name of its `XMLIndex` index as shown in [Example 6-28](#) (page 6-34). (This is more or less opposite to the query in [Example 6-11](#) (page 6-23).)

`XMLIndex` can be used for XPath expressions in the `SELECT` list, the `FROM` list, and the `WHERE` clause of a query, and it is useful for SQL/XML functions `XMLQuery`, `XMLTable`, `XMLExists`, and `XMLCast`. Unlike function-based indexes, which are deprecated for `XMLType`, `XMLIndex` indexes can be used when you extract data from an XML fragment in a document.

[Example 6-29](#) (page 6-34) illustrates this.

The execution plan for the query in [Example 6-29](#) (page 6-34) shows, by referring to the path table, that `XMLIndex` is used. It also shows the use of Oracle internal SQL function `sys_orderkey_depth` — see [Guidelines for Using XMLIndex with an Unstructured Component](#) (page 6-39).

[Example 6-30](#) (page 6-35) shows an execution plan that indicates that the `XMLIndex` index created in [Example 6-23](#) (page 6-28) is picked up for a query that uses two `WHERE` clause predicates. It is the same query as in [Example 6-46](#) (page 6-60), and the same XML search index is in effect, as is also shown in the execution plan.

With only the unstructured `XMLIndex` component, the query would have involved a join of the path table to itself, because of the two different paths in the `WHERE` clause.

The presence in [Example 6-30](#) (page 6-35) of the path table name, `path_tab`, indicates that the unstructured component of the index is used. The presence of the index content table `po_idx_tab` indicates that the structured index component is

used. The presence of the XML search index, `po_ctx_idx`, indicates that it too is used.

[Example 6-31](#) (page 6-36) shows an execution plan that indicates that the same XMLIndex index is also picked up for a query that uses multilevel XMLTable chaining. With only the unstructured XMLIndex component, this query too would involve a join of the path table to itself, because of the different paths in the two XMLTable function calls.

The execution plan shows direct access to the relational index content tables, `po_idx_tab` and `po_index_lineitem`. There is *no* access at all to the path table, `path_tab`.

See Also:

[Collecting Statistics on XMLIndex Objects for the Cost-Based Optimizer](#)
(page 6-44)

Example 6-27 Checking Whether an XMLIndex Unstructured Component Is Used

```
SET AUTOTRACE ON EXPLAIN
```

```
SELECT XMLQuery('/PurchaseOrder/Requestor' PASSING OBJECT_VALUE RETURNING CONTENT) FROM po_binxml
WHERE XMLElementExists('/PurchaseOrder[Reference="SBELL-2002100912333601PDT"]' PASSING OBJECT_VALUE);
```

```
XMLQUERY('/PURCHASEORDER/REQUESTOR' PASSING OBJECT_VALUE RETURNING CONTENT)
```

```
-----
<Requestor>Sarah J. Bell</Requestor>
```

```
1 row selected.
```

```
Execution Plan
```

```
.....
```

Id	Operation	Name	Rows	Bytes	Cost (%CPU)	Time
0	SELECT STATEMENT		1	24	28 (4)	00:00:01
1	SORT GROUP BY		1	3524		
* 2	TABLE ACCESS BY INDEX ROWID	MY_PATH_TABLE	2	7048	3 (0)	00:00:01
* 3	INDEX RANGE SCAN	SYS67616_PO_XMLINDE_PIKEY_IX	1		2 (0)	00:00:01
4	NESTED LOOPS		1	24	28 (4)	00:00:01
5	VIEW	VW_SQ_1	1	12	26 (0)	00:00:01
6	HASH UNIQUE		1	5046		
7	NESTED LOOPS		1	5046	26 (0)	00:00:01
* 8	TABLE ACCESS BY INDEX ROWID	MY_PATH_TABLE	1	3524	24 (0)	00:00:01
* 9	INDEX RANGE SCAN	SYS67616_PO_XMLINDE_VALUE_IX	73		1 (0)	00:00:01
* 10	TABLE ACCESS BY INDEX ROWID	MY_PATH_TABLE	1	1522	2 (0)	00:00:01
* 11	INDEX RANGE SCAN	SYS67616_PO_XMLINDE_PIKEY_IX	1		1 (0)	00:00:01
12	TABLE ACCESS BY USER ROWID	PO_BINXML	1	12	1 (0)	00:00:01

```
-----
Predicate Information (identified by operation id):
```

```
-----
2 - filter(SYS_XMLI_LOC_ISNODE("SYS_P0"."LOCATOR")=1)
3 - access("SYS_P0"."RID"=:b1 AND "SYS_P0"."PATHID"=HEXTORAW('76E2') )
8 - filter("SYS_P4"."VALUE"='SBELL-2002100912333601PDT' AND "SYS_P4"."PATHID"=HEXTORAW('4F8C') AND
SYS_XMLI_LOC_ISNODE("SYS_P4"."LOCATOR")=1)
9 - access(SUBSTRB("VALUE",1,1599)='SBELL-2002100912333601PDT')
10 - filter(SYS_XMLI_LOC_ISNODE("SYS_P2"."LOCATOR")=1)
11 - access("SYS_P4"."RID"="SYS_P2"."RID" AND "SYS_P2"."PATHID"=HEXTORAW('4E36') AND
"SYS_P2"."ORDER_KEY"<"SYS_P4"."ORDER_KEY")
filter("SYS_P4"."ORDER_KEY"<SYS_ORDERKEY_MAXCHILD("SYS_P2"."ORDER_KEY") AND
```

```
SYS_ORDERKEY_DEPTH("SYS_P2"."ORDER_KEY")+1=SYS_ORDERKEY_DEPTH("SYS_P4"."ORDER_KEY"))
```

...

Example 6-28 Obtaining the Name of an XMLIndex Index from Its Path-Table Name

```
SELECT INDEX_NAME FROM USER_XML_INDEXES WHERE PATH_TABLE_NAME = 'MY_PATH_TABLE';
```

```
INDEX_NAME
-----
PO_XMLINDEX_IX
```

1 row selected.

Example 6-29 Extracting Data from an XML Fragment Using XMLIndex

```
SET AUTOTRACE ON EXPLAIN
```

```
SELECT li.description, li.itemno
FROM po_binxml, XMLTable('/PurchaseOrder/LineItems/LineItem'
      PASSING OBJECT_VALUE
      COLUMNS "DESCRIPTION" VARCHAR(40) PATH 'Description',
              "ITEMNO"      INTEGER      PATH '@ItemNumber') li
WHERE XMLElement('/PurchaseOrder[Reference="SBELL-2002100912333601PDT"]'
      PASSING OBJECT_VALUE);
```

```
DESCRIPTION                                ITEMNO
-----
A Night to Remember                        1
The Unbearable Lightness Of Being         2
Sisters                                    3
```

3 rows selected.

Execution Plan

Id	Operation	Name	Rows	Bytes	Cost (%CPU)	Time
0	SELECT STATEMENT		1	1546	30 (4)	00:00:01
* 1	FILTER					
* 2	TABLE ACCESS BY INDEX ROWID	MY_PATH_TABLE	1	3524	3 (0)	00:00:01
* 3	INDEX RANGE SCAN	SYS67616_PO_XMLINDE_PIKEY_IX	1		2 (0)	00:00:01
* 4	FILTER					
* 5	TABLE ACCESS BY INDEX ROWID	MY_PATH_TABLE	1	3524	3 (0)	00:00:01
* 6	INDEX RANGE SCAN	SYS67616_PO_XMLINDE_PIKEY_IX	1		2 (0)	00:00:01
7	NESTED LOOPS					
8	NESTED LOOPS		1	1546	30 (4)	00:00:01
9	NESTED LOOPS		1	24	28 (4)	00:00:01
10	VIEW	VW_SQ_1	1	12	26 (0)	00:00:01
11	HASH UNIQUE		1	5046		
12	NESTED LOOPS		1	5046	26 (0)	00:00:01
* 13	TABLE ACCESS BY INDEX ROWID	MY_PATH_TABLE	1	3524	24 (0)	00:00:01
* 14	INDEX RANGE SCAN	SYS67616_PO_XMLINDE_VALUE_IX	73		1 (0)	00:00:01
* 15	TABLE ACCESS BY INDEX ROWID	MY_PATH_TABLE	1	1522	2 (0)	00:00:01
* 16	INDEX RANGE SCAN	SYS67616_PO_XMLINDE_PIKEY_IX	1		1 (0)	00:00:01
17	TABLE ACCESS BY USER ROWID	PO_BINXML	1	12	1 (0)	00:00:01
* 18	INDEX RANGE SCAN	SYS67616_PO_XMLINDE_PIKEY_IX	1		1 (0)	00:00:01
* 19	TABLE ACCESS BY INDEX ROWID	MY_PATH_TABLE	1	1522	2 (0)	00:00:01

Predicate Information (identified by operation id):

```
1 - filter(:B1<SYS_ORDERKEY_MAXCHILD(:B2))
```



```

2 - filter(SYS_XMLI_LOC_ISNODE("SYS_P2"."LOCATOR")=1)
3 - access("SYS_P2"."RID"=:B1 AND "SYS_P2"."PATHID"=HEXTORAW('28EC') AND "SYS_P2"."ORDER_KEY">:B2 AND
   "SYS_P2"."ORDER_KEY"<SYS_ORDERKEY_MAXCHILD(:B3))
   filter(SYS_ORDERKEY_DEPTH("SYS_P2"."ORDER_KEY")=SYS_ORDERKEY_DEPTH(:B1)+1)
4 - filter(:B1<SYS_ORDERKEY_MAXCHILD(:B2))
5 - filter(SYS_XMLI_LOC_ISNODE("SYS_P5"."LOCATOR")=1)
6 - access("SYS_P5"."RID"=:B1 AND "SYS_P5"."PATHID"=HEXTORAW('60E0') AND "SYS_P5"."ORDER_KEY">:B2 AND
   "SYS_P5"."ORDER_KEY"<SYS_ORDERKEY_MAXCHILD(:B3))
   filter(SYS_ORDERKEY_DEPTH("SYS_P5"."ORDER_KEY")=SYS_ORDERKEY_DEPTH(:B1)+1)
13 - filter("SYS_P10"."VALUE"='SBELL-2002100912333601PDT' AND "SYS_P10"."PATHID"=HEXTORAW('4F8C') AND
   SYS_XMLI_LOC_ISNODE("SYS_P10"."LOCATOR")=1)
14 - access(SUBSTRB("VALUE",1,1599)='SBELL-2002100912333601PDT')
15 - filter(SYS_XMLI_LOC_ISNODE("SYS_P8"."LOCATOR")=1)
16 - access("SYS_P10"."RID"="SYS_P8"."RID" AND "SYS_P8"."PATHID"=HEXTORAW('4E36') AND
   "SYS_P8"."ORDER_KEY"<"SYS_P10"."ORDER_KEY")
   filter("SYS_P10"."ORDER_KEY"<SYS_ORDERKEY_MAXCHILD("SYS_P8"."ORDER_KEY") AND
   SYS_ORDERKEY_DEPTH("SYS_P8"."ORDER_KEY")+1=SYS_ORDERKEY_DEPTH("SYS_P10"."ORDER_KEY"))
18 - access("PO_BINXML".ROWID="SYS_ALIAS_4"."RID" AND "SYS_ALIAS_4"."PATHID"=HEXTORAW('3748') )
19 - filter(SYS_XMLI_LOC_ISNODE("SYS_ALIAS_4"."LOCATOR")=1)

```

Note

- dynamic sampling used for this statement (level=2)

Example 6-30 Using a Structured XMLIndex Component for a Query with Two Predicates

EXPLAIN PLAN FOR

```

SELECT XMLQuery('/PurchaseOrder/LineItems/LineItem'
   PASSING OBJECT_VALUE RETURNING CONTENT)
FROM po_binxml
WHERE XMLElement('/PurchaseOrder/LineItems/LineItem
   [Description contains text "Picnic"]'
   PASSING OBJECT_VALUE)
AND XMLElement('/PurchaseOrder[User="SBELL"]' PASSING OBJECT_VALUE);

```

Explained.

Id	Operation	Name	Rows	Bytes	Cost (%CPU)	Time
0	SELECT STATEMENT		1	2051	9 (0)	00:00:01
1	SORT GROUP BY		1	3524		
* 2	TABLE ACCESS BY INDEX ROWID BATCHED	PATH_TAB	2	7048	3 (0)	00:00:01
* 3	INDEX RANGE SCAN	SYS86751_PO_XMLINDE_PIKEY_IX	1		2 (0)	00:00:01
4	NESTED LOOPS SEMI		1	2051	6 (0)	00:00:01
5	TABLE ACCESS BY INDEX ROWID	PO_BINXML	1	2024	4 (0)	00:00:01
* 6	DOMAIN INDEX	PO_CTX_IDX			4 (0)	00:00:01
* 7	TABLE ACCESS BY INDEX ROWID BATCHED	PO_IDX_TAB	13	351	2 (0)	00:00:01
* 8	INDEX RANGE SCAN	SYS86751_86755_OID_IDX	1		1 (0)	00:00:01

Predicate Information (identified by operation id):

```

2 - filter(SYS_XMLI_LOC_ISNODE("SYS_P1"."LOCATOR")=1)
3 - access("SYS_P1"."RID"=:B1 AND "SYS_P1"."PATHID"=HEXTORAW('3748') )
6 - access("CTXSYS"."CONTAINS"(SYS_MAKEXML(0,"XMLDATA"), '<query><textquery grammar="CONTEXT"
   lang="english">{Picnic} INPATH
   (/PurchaseOrder/LineItems/LineItem/Description)/<textquery><xquery><offset>0</
   offset></xquery></query>')>0)
7 - filter("SYS_SXI_0"."USERNAME"='SBELL')
8 - access("PO_BINXML"."SYS_NC_OID$"="SYS_SXI_0"."OID")

```

Note

- dynamic sampling used for this statement (level=2)

30 rows selected.

Example 6-31 Using a Structured XMLIndex Component for a Query with Multilevel Chaining

```
EXPLAIN PLAN FOR
SELECT po.reference, li.*
FROM po_binxml p,
     XMLTable('/PurchaseOrder' PASSING p.OBJECT_VALUE
              COLUMNS reference  VARCHAR2(30)  PATH 'Reference',
                       lineitem  XMLType      PATH 'LineItems/LineItem') po,
     XMLTable('/LineItem' PASSING po.lineitem
              COLUMNS itemno     BINARY_DOUBLE PATH '@ItemNumber',
                       description VARCHAR2(256) PATH 'Description',
                       partno     VARCHAR2(14)  PATH 'Part/@Id',
                       quantity   BINARY_DOUBLE PATH 'Part/@Quantity',
                       unitprice  BINARY_DOUBLE PATH 'Part/@UnitPrice') li
WHERE po.reference = 'SBELL-20021009123335280PDT';
```

Id	Operation	Name	Rows	Bytes	Cost (%CPU)	Time
0	SELECT STATEMENT		17	20366	8 (0)	00:00:01
1	NESTED LOOPS					
2	NESTED LOOPS		17	20366	8 (0)	00:00:01
3	NESTED LOOPS		1	539	3 (0)	00:00:01
* 4	TABLE ACCESS FULL	PO_IDX_TAB	1	529	3 (0)	00:00:01
* 5	INDEX UNIQUE SCAN	SYS_C007442	1	10	0 (0)	00:00:01
* 6	INDEX RANGE SCAN	SYS86751_86759_PKY_IDX	17		1 (0)	00:00:01
7	TABLE ACCESS BY INDEX ROWID	PO_INDEX_LINEITEM	17	11203	5 (0)	00:00:01

Predicate Information (identified by operation id):

```
4 - filter("SYS_SXI_2"."REFERENCE"='SBELL-20021009123335280PDT')
5 - access("P"."SYS_NC_OID$"="SYS_SXI_2"."OID")
6 - access("SYS_SXI_2"."KEY"="SYS_SXI_3"."PKEY")
```

Note

- dynamic sampling used for this statement

25 rows selected.

6.3.9 Turning Off Use of XMLIndex

You can turn off the use of XMLIndex by using optimizer hint: /*+ NO_XML_QUERY_REWRITE */ or optimizer hint /*+ NO_XMLINDEX_REWRITE */.

Each of these hints turns off the use of *all* XMLIndex indexes. In addition to turning off the use of XMLIndex, NO_XML_QUERY_REWRITE turns off all XQuery optimization (XMLIndex is part of XPath rewrite).

[Example 6-32](#) (page 6-37) shows the use of these optimizer hints.

Note:

The NO_INDEX optimizer hint does not apply to XMLIndex.

See Also:

[XQuery Optional Features](#) (page 4-27) for information about XQuery pragmas `ora:no_xmlquery_rewrite` and `ora:xmlquery_rewrite`, which you can use for fine-grained control of XQuery optimization

Example 6-32 Turning Off XMLIndex Using Optimizer Hints

```
SELECT /*+ NO_XMLINDEX_REWRITE */
count(*) FROM po_binxml WHERE XMLExists('$p/*' PASSING OBJECT_VALUE AS "p");

SELECT /*+ NO_XML_QUERY_REWRITE */
count(*) FROM po_binxml WHERE XMLExists('$p/*' PASSING OBJECT_VALUE AS "p");
```

6.3.10 XMLIndex Path Subsetting: Specifying the Paths You Want to Index

If you know which XPath expressions you are most likely to query then you can narrow the focus of XMLIndex indexing and thus improve performance.

One of the advantages of an XMLIndex index with an unstructured component is that it is very general: you need not specify which XPath locations to index; you need no prior knowledge of the XPath expressions that will be queried. By default, an unstructured XMLIndex component indexes all possible XPath locations in your XML data.

However, if you are aware of the XPath expressions that you are most likely to query, then you can narrow the focus of XMLIndex indexing and thus improve performance. Having fewer indexed nodes means less space is required for indexing, which improves index maintenance during DML operations. Having fewer indexed nodes improves DDL performance, and having a smaller path table improves query performance.

You narrow the focus of indexing by pruning the set of XPath expressions (paths) corresponding to XML fragments to be indexed, specifying a subset of all possible paths. You can do this in two alternative ways:

- Exclusion – Start with the default behavior of including all possible XPath expressions, and exclude some of them from indexing.
- Inclusion – Start with an empty set of XPath expressions to be used in indexing, and add paths to this inclusion set.

You can specify path subsetting either when you create an XMLIndex index using `CREATE INDEX` or when you modify it using `ALTER INDEX`. In both cases, you provide the subsetting information in the `PATHS` parameter of the statement's `PARAMETERS` clause. For exclusion, you use keyword `EXCLUDE`. For inclusion, you use keyword `INCLUDE` for `ALTER INDEX` and no keyword for `CREATE INDEX` (list the paths to include). You can also specify namespace mappings for the nodes targeted by the `PATHS` parameter.

For `ALTER INDEX`, keyword `INCLUDE` or `EXCLUDE` is followed by keyword `ADD` or `REMOVE`, to indicate whether the list of paths that follows the keyword is to be added or removed from the inclusion or exclusion list. For example, this statement adds path `/PurchaseOrder/Reference` to the list of paths to be excluded from indexing:

```
ALTER INDEX po_xmlindex_ix REBUILD
PARAMETERS ('PATHS (EXCLUDE ADD (/PurchaseOrder/Reference))');
```

To alter an XMLIndex index so that it *includes all* possible paths, use keyword INDEX_ALL_PATHS. See [alter_index_paths_clause ::=](#) (page 6-49).

Note:

If you create an XMLIndex index that has both structured and unstructured components, then, by default, any nodes indexed in the structured component are also indexed in the unstructured component; that is, they are *not* automatically *excluded* from the unstructured component. If you do not want unstructured XMLIndex indexing to apply to them, then you must explicitly use path subsetting to exclude them.

See Also:

[PARAMETERS Clause for CREATE INDEX and ALTER INDEX](#) (page 6-46) for the syntax of the PARAMETERS clause

6.3.10.1 Examples of XMLIndex Path Subsetting

Some examples are presented of defining XMLIndex indexes on subsets of XPath expressions.

Example 6-33 XMLIndex Path Subsetting with CREATE INDEX

```
CREATE INDEX po_xmlindex_ix ON po_binxml (OBJECT_VALUE) INDEXTYPE IS XDB.XMLIndex
  PARAMETERS ('PATHS (INCLUDE (/PurchaseOrder/LineItems/*
                               /PurchaseOrder/Reference))');
```

This statement creates an index that indexes only top-level element PurchaseOrder and some of its children, as follows:

- All LineItems elements and their descendants
- All Reference elements

It does that by including the specified paths, starting with an empty set of paths to be used for the index.

Example 6-34 XMLIndex Path Subsetting with ALTER INDEX

```
ALTER INDEX po_xmlindex_ix REBUILD
  PARAMETERS ('PATHS (INCLUDE ADD (/PurchaseOrder/Requestor
                                   /PurchaseOrder/Actions/Action/*))');
```

This statement adds two more paths to those used for indexing. These paths index element Requestor and descendants of element Action (and their ancestors).

Example 6-35 XMLIndex Path Subsetting Using a Namespace Prefix

If an XPath expression to be used for XMLIndex indexing uses namespace prefixes, you can use a NAMESPACE MAPPING clause to the PATHS list, to specify those prefixes. Here is an example:

```
CREATE INDEX po_xmlindex_ix ON po_binxml (OBJECT_VALUE) INDEXTYPE IS XDB.XMLIndex
  PARAMETERS ('PATHS (INCLUDE (/PurchaseOrder/LineItems/* /PurchaseOrder/ipo:Reference)
  NAMESPACE MAPPING (xmlns="http://xmlns.oracle.com"
                      xmlns:ipo="http://xmlns.oracle.com/ipo"))');
```

6.3.10.2 XMLIndex Path-Subsetting Rules

Rules that apply to XMLIndex path subsetting are described.

- The paths must reference only child and descendant axes, and they must test only element and attribute nodes or their names (possibly using wildcards). In particular, the paths must not involve predicates.
- You cannot specify both path exclusion and path inclusion; choose one or the other.
- If an index was created using path exclusion (inclusion), then you can modify it using only path exclusion (inclusion) — index modification must either further restrict or further extend the path subset. For example, you cannot create an index that includes certain paths and subsequently modify it to exclude certain paths.

6.3.11 Guidelines for Using XMLIndex with an Unstructured Component

There are several guidelines that can help you use XMLIndex with an unstructured component.

These guidelines are applicable only when the two alternatives discussed return the same result set.

- Avoid prefixing // with ancestor elements. For example, use //c, not /a/b//c, provided these return the same result set.
- Avoid prefixing /* with ancestor elements. For example, use /*/*/*, not /a/*/*, provided these return the same result set.
- In a WHERE clause, use XMLExists rather than XMLCast of XMLQuery. This can allow optimization that, in effect, invokes a subquery against the path-table VALUE column. For example, use this:

```
SELECT count(*) FROM purchaseorder p
WHERE
    XMLExists('$p/PurchaseOrder/LineItems/LineItem/Part[@Id="715515011020"]'
              PASSING OBJECT_VALUE AS "p");
```

Do not use this:

```
SELECT count(*) FROM purchaseorder p
WHERE XMLCast(XMLQuery('$p/PurchaseOrder/LineItems/LineItem/Part/@Id'
                       PASSING OBJECT_VALUE AS "p" RETURNING CONTENT)
              AS VARCHAR2(14))
      = "715515011020";
```

- When possible, use count(*), not count(XMLCast(XMLQuery(...))), in a SELECT clause. For example, if you know that a LineItem element in a purchase-order document has only one Description child, use this:

```
SELECT count(*) FROM po_binxml, XMLTable('//LineItem' PASSING OBJECT_VALUE);
```

Do not use this:

```
SELECT count(li.value)
FROM po_binxml p, XMLTable('//LineItem' PASSING p.OBJECT_VALUE
                           COLUMNS value VARCHAR2(30) PATH 'Description') li;
```

- Reduce the number of XPath expressions used in a query FROM list as much as possible. For example, use this:

```
SELECT li.description
FROM po_binxml p,
     XMLTable('PurchaseOrder/LineItems/LineItem' PASSING p.OBJECT_VALUE
              COLUMNS description VARCHAR2(256) PATH 'Description') li;
```

Do not use this:

```
SELECT li.description
FROM po_binxml p,
     XMLTable('PurchaseOrder/LineItems' PASSING p.OBJECT_VALUE) ls,
     XMLTable('LineItems/LineItem'      PASSING ls.OBJECT_VALUE
              COLUMNS description VARCHAR2(256) PATH 'Description') li;
```

- If you use an XPath expression in a query to drill down inside a virtual table (created, for example, using SQL/XML function `XMLTable`), then create a secondary index on the order key of the path table using Oracle SQL function `sys_orderkey_depth`. Here is an example of such a query; the selection navigates to element `Description` inside virtual line-item table `li`.

```
SELECT li.description
FROM po_binxml p,
     XMLTable('PurchaseOrder/LineItems/LineItem' PASSING p.OBJECT_VALUE
              COLUMNS description VARCHAR2(256) PATH 'Description') li;
```

Such queries are evaluated using function `sys_orderkey_depth`, which returns the depth of the order-key value. Because the order index uses two columns, the index needed is a *composite* index over columns `ORDER_KEY` and `RID`, as well as over function `sys_orderkey_depth` applied to the `ORDER_KEY` value. For example:

```
CREATE INDEX depth_ix ON my_path_table
(RID, sys_orderkey_depth(ORDER_KEY), ORDER_KEY);
```

See Also:

[Example 6-29](#) (page 6-34) for an example that shows the use of `sys_orderkey_depth`

6.3.12 Guidelines for Using XMLIndex with a Structured Component

There are several guidelines that can help you use `XMLIndex` with a structured component.

- Use `XMLIndex` with a structured component to project and index XML data as relational columns. Do not use function-based indexes; they are deprecated for use with XML. See [Function-Based Indexes Are Deprecated for XMLType](#) (page 6-6).
- Ensure data type correspondence between a query and an `XMLIndex` index that has a structured component. See [Data Type Considerations for XMLIndex Structured Component](#) (page 6-11).
- If you create a relational view over `XMLType` data (for example, using SQL function `XMLTable`), then consider also creating an `XMLIndex` index with a structured component that targets the same relational columns. See [Relational Views over XML Data](#) (page 9-1).

- Instead of using a single XQuery expression for both fragment extraction and value filtering (search), use SQL/XML function `XMLQuery` in the `SELECT` clause to extract fragments and `XMLExists` in the `WHERE` clause to filter values.

This lets Oracle XML DB evaluate fragment extraction functionally or by using streaming evaluation. For value filtering, this lets Oracle XML DB pick up an `XMLIndex` index that has a relevant structured component.

- To order query results, use a SQL `ORDER BY` clause, together with SQL/XML function `XMLTable`. Avoid using the XQuery `order by` clause. This is particularly pertinent if you use an `XMLIndex` index with a structured component.

6.3.13 XMLIndex Partitioning and Parallelism

If you partition an `XMLType` table, or a table with an `XMLType` column, using range, list, or hash partitioning, you can also create an `XMLIndex` index on the table. You can optionally ensure that index creation and maintenance are carried out in parallel.

To ensure parallel index creation and maintenance, you use a `PARALLEL` clause (with optional degree) when creating or altering an `XMLIndex` index.

If you use the keyword `LOCAL` when you create the `XMLIndex` index, then the index and all of its storage tables are locally equipartitioned with respect to the base table.

If you do not use the keyword `LOCAL` then you cannot create an `XMLIndex` index on a partitioned table. Also, if you composite-partition a table, then you cannot create an `XMLIndex` index on it.

If you use a `PARALLEL` clause and the base table is partitioned or enabled for parallelism, then this can improve the performance for both DML operations (`INSERT`, `UPDATE`, `DELETE`) and index DDL operations (`CREATE`, `ALTER`, `REBUILD`).

Specifying parallelism for an index can also consume more storage, because storage parameters apply separately to each query server process. For example, an index created with an `INITIAL` value of 5M and a parallelism degree of 12 consumes at least 60M of storage during index creation.

The syntax for the parallelism clause for `CREATE INDEX` and `ALTER INDEX` is the same as for other domain indexes:

```
{ NOPARALLEL | PARALLEL [ integer ] }
```

Example 6-36 (page 6-42) creates an `XMLIndex` index with a parallelism degree of 10. If the base table is partitioned, then this index is equipartitioned.

In **Example 6-36** (page 6-42), the path table and the secondary indexes are created with the same parallelism degree as the `XMLIndex` index itself, 10, by inheritance. You can specify different parallelism degrees for these by using separate `PARALLEL` clauses. **Example 6-37** (page 6-42) demonstrates this. Again, because of keyword `LOCAL`, if the base table is partitioned, then this index is equipartitioned.

In **Example 6-37** (page 6-42), the `XMLIndex` index itself is created serially, because of `NOPARALLEL`. The secondary index `po_pikekey_ix` is also populated serially, because no parallelism is specified explicitly for it; it inherits the parallelism of the `XMLIndex` index. The path table itself is created with a parallelism degree of 10, and the secondary index value column, `po_value_ix`, is populated with a degree of 5, due to their explicit parallelism specifications.

Any parallelism you specify for an `XMLIndex` index, its path table, or its secondary indexes is exploited during subsequent DML operations and queries.

There are two places where you can specify parallelism for XMLIndex: within the PARAMETERS clause parenthetical expression and after it.

See Also:

- *Oracle Database SQL Language Reference* for information on the CREATE INDEX parallel clause
 - [PARAMETERS Clause for CREATE INDEX and ALTER INDEX](#) (page 6-46) for the syntax of the PARAMETERS clause
 - [Structured and Unstructured XMLIndex Components](#) (page 6-8)
-
-

Example 6-36 Creating an XMLIndex Index in Parallel

```
CREATE INDEX po_xmlindex_ix ON sale_info (sale_po_clob) INDEXTYPE IS XDB.XMLIndex
LOCAL PARALLEL 10;
```

Example 6-37 Using Different PARALLEL Degrees for XMLIndex Internal Objects

```
CREATE INDEX po_xmlindex_ix ON sale_info (sale_po_clob) INDEXTYPE IS XDB.XMLIndex
LOCAL NOPARALLEL PARAMETERS ('PATH TABLE po_path_table (PARALLEL 10)
PIKEY INDEX po_pikey_ix
VALUE INDEX po_value_ix (PARALLEL 5)');
```

6.3.14 Asynchronous (Deferred) Maintenance of XMLIndex Indexes

You can defer the cost of maintaining an XMLIndex index that has *only* an *unstructured* component, performing maintenance only at commit time or when database load is reduced. This can improve DML performance, and it can enable bulk loading of unsynchronized index rows when an index is synchronized.

This feature applies to an XMLIndex index that has *only* an *unstructured* component. If you specify asynchronous maintenance for an XMLIndex index that has a *structured* component (even if it also has an unstructured component), then an error is raised.

By default, XMLIndex indexing is updated (maintained) at each DML operation, so that it remains in sync with the base table. In some situations, you might not require this, and using possibly stale indexes might be acceptable. In that use case, you can decide to defer the cost of index maintenance, performing at commit time only or at some time when database load is reduced. This can improve DML performance. It can also improve index maintenance performance by enabling bulk loading of unsynchronized index rows when an index is synchronized.

Using a stale index has no effect, other than performance, on DML operations. It can have an effect on query results, however: If the index is not up-to-date at query time, then the query results might not be up-to-date either. Even if only one column of a base table is of data type XMLType, all queries on that table reflect the database data as of the last synchronization of the XMLIndex index on the XMLType column.

You can specify index maintenance deferment using the parameters clause of a CREATE INDEX or ALTER INDEX statement.

Be aware that even if you defer synchronization for an XMLIndex index, the following database operations automatically synchronize the index:

- Any DDL operation on the index – ALTER INDEX or creation of secondary indexes

- Any DDL operation on the base table – ALTER TABLE or creation of another index

[Table 6-7](#) (page 6-43) lists the synchronization options and the ASYNC clause syntax you use to specify them. The ASYNC clause is used in the PARAMETERS clause of a CREATE INDEX or ALTER INDEX statement for XMLIndex.

Table 6-7 Index Synchronization

When to Synchronize ASYNC Clause Syntax	
Always	ASYNC (SYNC ALWAYS) This is the default behavior. You can specify it explicitly, to cancel a previous ASYNC specification.
Upon commit	ASYNC (SYNC ON COMMIT)
Periodically	ASYNC (SYNC EVERY " <i>repeat_interval</i> ") <i>repeat_interval</i> is the same as for the calendaring syntax of DBMS_SCHEDULER To use EVERY, you must have the CREATE JOB privilege.
Manually, on demand	ASYNC (SYNC MANUAL) You can manually synchronize the index using PL/SQL procedure DBMS_XMLINDEX.syncIndex.

Optional ASYNC syntax parameter STALE is intended for possible future use; you need never specify it explicitly. It has value FALSE whenever ALWAYS is used; otherwise it has value TRUE. Specifying an explicit STALE value that contradicts this rule raises an error.

[Example 6-38](#) (page 6-44) creates an XMLIndex index that is synchronized every Monday at 3:00 pm, starting tomorrow.

[Example 6-39](#) (page 6-44) manually synchronizes the index created in [Example 6-38](#) (page 6-44).

When XMLIndex index synchronization is deferred, all DML changes (inserts, updates, and deletions) made to the base table since the last index synchronization are recorded in a pending table, one row per DML operation. The name of this table is the value of column PEND_TABLE_NAME of static public views USER_XML_INDEXES, ALL_XML_INDEXES, and DBA_XML_INDEXES.

You can examine this table to determine when synchronization might be appropriate for a given XMLIndex index. The more rows there are in the pending table, the more the index is likely to be in need of synchronization.

If the pending table is large, then setting parameter REINDEX to TRUE when calling syncIndex, as in [Example 6-39](#) (page 6-44), can improve performance. When REINDEX is TRUE, all of the secondary indexes are dropped and then re-created after the pending table data is bulk-loaded.

See Also:

- *Oracle Database PL/SQL Packages and Types Reference*, section "Calendaring Syntax", for the syntax of *repeat_interval*
 - *Oracle Database PL/SQL Packages and Types Reference* for information on PL/SQL procedure DBMS_XMLINDEX.syncIndex
-
-

Example 6-38 Specifying Deferred Synchronization for XMLIndex

```
CREATE INDEX po_xmlindex_ix ON po_binxml (OBJECT_VALUE) INDEXTYPE IS XDB.XMLIndex
  PARAMETERS ('ASYNC (SYNC EVERY "FREQ=HOURLY; INTERVAL = 1")');
```

Example 6-39 Manually Synchronizing an XMLIndex Index Using SYNCINDEX

```
EXEC DBMS_XMLINDEX.syncIndex('OE', 'PO_XMLINDEX_IX', REINDEX => TRUE);
```

6.3.14.1 Syncing an XMLIndex Index in Case of Error ORA-08181

If a query raises error ORA-08181, check whether the base XMLType table of the query has an XMLIndex index with an unstructured component. If so, then manually synchronize the XMLIndex index using `DBMS_XMLINDEX.syncIndex`.

This applies only if error ORA-08181 is raised in the following situation:

1. In a pluggable database, *PDB1*, you created an XMLType table or column *XTABCOL*, which you indexed using an XMLIndex index that has an unstructured component.
2. You plugged *PDB1* into a container database.
3. You cloned *PDB1* to a new pluggable database, *PDB2*.
4. Error ORA-08181 is raised when you query *XTABCOL* in *PDB2*.

If the error is raised even after synchronizing then seek another cause. Error ORA-08181 is a general error that can be raised in various situations, of which this is only one.

See Also:

[Oracle XML DB and Database Consolidation](#) (page 34-13)

6.3.15 Collecting Statistics on XMLIndex Objects for the Cost-Based Optimizer

The Oracle Database cost-based optimizer determines how to most cost-effectively evaluate a given query, including which indexes, if any, to use. For it to be able to do this accurately, you must collect statistics on various database objects.

Note:

The following applies only to procedures in package `DBMS_STATS`; it does not apply to `ANALYZE INDEX`.

For XMLIndex, you normally need to collect statistics on only the base table on which the XMLIndex index is defined (using, for example, procedure `DBMS_STATS.gather_table_stats`). This automatically collects statistics for the XMLIndex index itself, as well as the path table, its secondary indexes, and any structured component content tables and their secondary indexes.

If you delete statistics on the base table (using procedure `DBMS_STATS.delete_table_stats`), then statistics on the other objects are also deleted. Similarly, if you collect statistics on the XMLIndex index (using procedure `DBMS_STATS.gather_index_stats`), then statistics are also collected on the path table, its secondary indexes, and any structured component content tables and their secondary indexes.

[Example 6-40](#) (page 6-45) collects statistics on the base table `po_binxml`. Statistics are automatically collected on the XMLIndex index, its path table, and the secondary path-table indexes.

See Also:

[Data Dictionary Static Public Views Related to XMLIndex](#) (page 6-45) for information about database views that record statistics information for an XMLIndex index

Example 6-40 Automatic Collection of Statistics on XMLIndex Objects

```
CALL DBMS_STATS.gather_table_stats(USER, 'PO_BINXML', ESTIMATE_PERCENT => NULL);
```

6.3.16 Data Dictionary Static Public Views Related to XMLIndex

Information about the standard database indexes is available in static public views `USER_INDEXES`, `ALL_INDEXES`, and `DBA_INDEXES`. Similar information about XMLIndex indexes is available in static public views `USER_XML_INDEXES`, `ALL_XML_INDEXES`, and `DBA_XML_INDEXES`.

[Table 6-8](#) (page 6-45) describes the columns in each of these views.

Table 6-8 XMLIndex Static Public Views

Column Name	Type	Description
ASYNC	VARCHAR2	Asynchronous index updating specification. See Asynchronous (Deferred) Maintenance of XMLIndex Indexes (page 6-42).
EX_OR_INCLUDE	VARCHAR2	Path subsetting: <ul style="list-style-type: none"> FULLY_IX – The index uses no path subsetting. EXCLUDE – The index uses only exclusion subsetting. INCLUDE – The index uses only inclusion subsetting.
INDEX_NAME	VARCHAR2	Name of the XMLIndex index.
INDEX_OWNER	VARCHAR2	Owner of the index. Not available for <code>USER_XML_INDEXES</code> .
INDEX_TYPE	VARCHAR2	The types of components the index is composed of: <code>STRUCTURED</code> , <code>UNSTRUCTURED</code> , or <code>STRUCTURED AND UNSTRUCTURED</code> .

Table 6-8 (Cont.) XMLIndex Static Public Views

Column Name	Type	Description
PARAMETERS	XMLType	Information from the PARAMETERS clause that was used to create the index. If an unstructured XMLIndex component is present, the PARAMETERS clause can include the set of XPath paths defining path-subsetting and the name of a scheduler job for synchronization. If a structured component is present, the PARAMETERS clause includes the name of the structure group and the table definitions provided by XMLTable, including the XQuery expressions that define the columns.
PATH_TABLE_NAME	VARCHAR2	Name of the XMLIndex path table.
PEND_TABLE_NAME	VARCHAR2	Name of the table that records base-table DML operations since the last index synchronization. See Asynchronous (Deferred) Maintenance of XMLIndex Indexes (page 6-42).
TABLE_NAME	VARCHAR2	Name of the base table on which the index is defined.
TABLE_OWNER	VARCHAR2	Owner of the base table on which the index is defined.

These views provide information about an XMLIndex index, but there is no single static data dictionary view that provides information about the statistics gathered for an XMLIndex index. This statistics information is distributed among the following views:

- USER_INDEXES, ALL_INDEXES, DBA_INDEXES – Column LAST_ANALYZED provides the date when the XMLIndex index was last analyzed.
- USER_TAB_STATISTICS, ALL_TAB_STATISTICS, DBA_TAB_STATISTICS – Column TABLE_NAME provides information about the structured and unstructured components of an XMLIndex index. For information about the structured or unstructured component, query using the name of the path table or the XMLTable table as TABLE_NAME, respectively.
- USER_IND_STATISTICS, ALL_IND_STATISTICS, DBA_IND_STATISTICS – Column INDEX_NAME provides information about each of the secondary indexes for an XMLIndex index. For information about a given secondary index, query using the name of that secondary index as INDEX_NAME.

6.3.17 PARAMETERS Clause for CREATE INDEX and ALTER INDEX

Creation or modification of an XMLIndex index often involves the use of a PARAMETERS clause with SQL statement CREATE INDEX or ALTER INDEX. You can use it to specify index characteristics in detail.

- See [PARAMETERS Clause Syntax for CREATE INDEX and ALTER INDEX](#) (page 6-47) for the syntax of the PARAMETERS clause for use with XMLIndex.

- You can use PL/SQL procedures `registerParameter` and `modifyParameter` in package `DBMS_XMLINDEX` to get around the 1000-character `PARAMETERS` clause limit. See [Using a Registered PARAMETERS Clause for XMLIndex](#) (page 6-47)

See Also:

- *Oracle Database SQL Language Reference* for the syntax of `index_attributes`
 - *Oracle Database SQL Language Reference* for the syntax of `segment_attributes_clause`
 - *Oracle Database SQL Language Reference* for the syntax of `table_properties`
 - *Oracle Database SQL Language Reference* for the syntax of `parallel_clause`
 - *Oracle Database SQL Language Reference* for additional information about the syntax and semantics of `CREATE INDEX`
 - *Oracle Database SQL Language Reference* for additional information about the syntax and semantics of `ALTER INDEX`
 - *Oracle Database PL/SQL Packages and Types Reference*, section "Calendaring Syntax", for the syntax of `repeat_interval`
-
-

6.3.17.1 Using a Registered PARAMETERS Clause for XMLIndex

The string value used for the `PARAMETERS` clause of a `CREATE INDEX` or `ALTER INDEX` statement has a 1000-character limit. To get around this limitation, you can use PL/SQL procedures `registerParameter` and `modifyParameter` in package `DBMS_XMLINDEX`.

For each of these procedures, you provide a string of parameters (unlimited in length) and an identifier under which the string is registered. Then, in the index `PARAMETERS` clause, you provide the identifier preceded by the keyword `PARAM`, instead of a literal string.

The identifier must already have been registered before you can use it in a `CREATE INDEX` or `ALTER INDEX` statement.

See Also:

[Example 6-23](#) (page 6-28)

6.3.17.2 PARAMETERS Clause Syntax for CREATE INDEX and ALTER INDEX

The syntax for the `PARAMETERS` clause for `CREATE INDEX` and `ALTER INDEX` is defined.

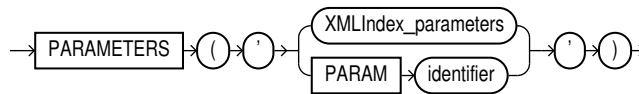
XMLIndex_parameters_clause ::=**See Also:**

[Usage of XMLIndex_parameters_clause](#) (page 6-53)

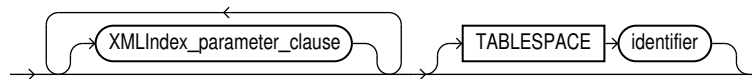
XMLIndex_parameters ::=**See Also:**

[Usage of XMLIndex_parameters](#) (page 6-53)

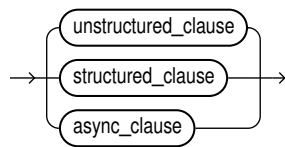
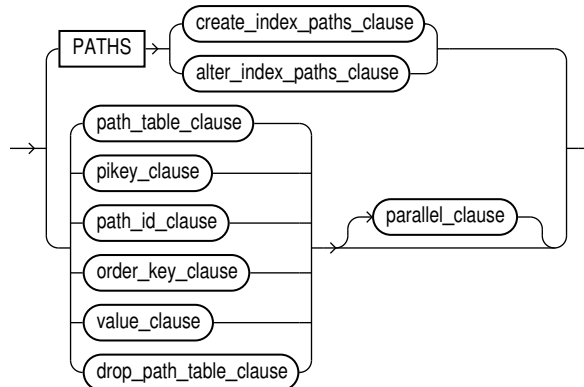
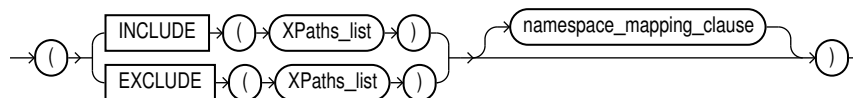
XMLIndex_parameter_clause ::=**unstructured_clause ::=****create_index_paths_clause ::=**

See Also:

- [Usage of PATHS Clause](#) (page 6-54)
- [Usage of create_index_paths_clause and alter_index_paths_clause](#) (page 6-54)

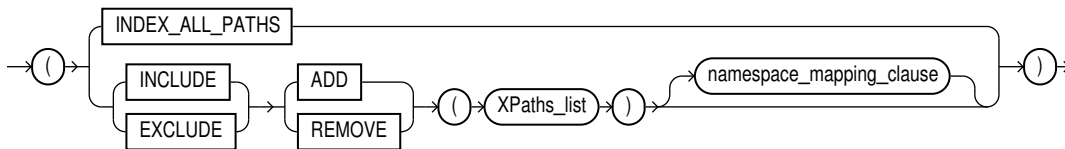
alter_index_paths_clause ::=**See Also:**

- [Usage of PATHS Clause](#) (page 6-54)
- [Usage of create_index_paths_clause and alter_index_paths_clause](#) (page 6-54)

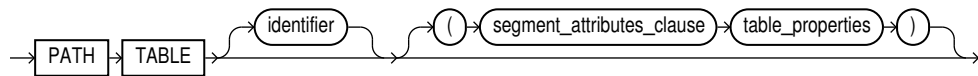
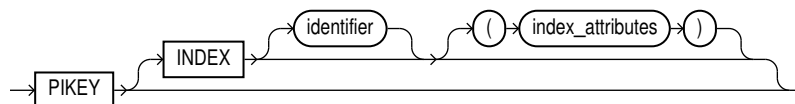
namespace_mapping_clause ::=***path_table_clause ::=******pikey_clause ::=*****See Also:**

[Usage of pikey_clause, path_id_clause, and order_key_clause](#) (page 6-54)

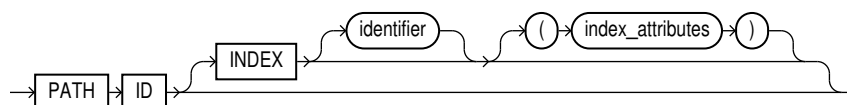
path_id_clause ::=

See Also:

[Usage of pikey_clause, path_id_clause, and order_key_clause](#) (page 6-54)

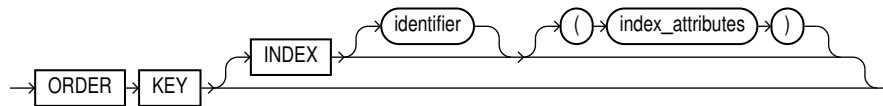
order_key_clause ::=**See Also:**

[Usage of pikey_clause, path_id_clause, and order_key_clause](#) (page 6-54)

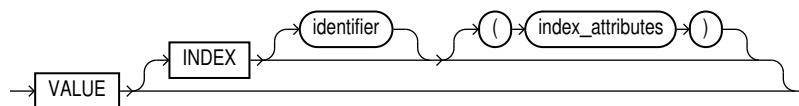
value_clause ::=**See Also:**

[Usage of value_clause](#) (page 6-54)

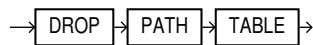
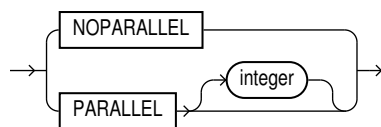
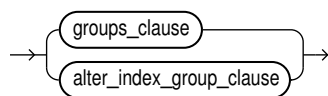
drop_path_table_clause ::=**parallel_clause ::=****structured_clause ::=****See Also:**

[Usage of groups_clause and alter_index_group_clause](#) (page 6-55)

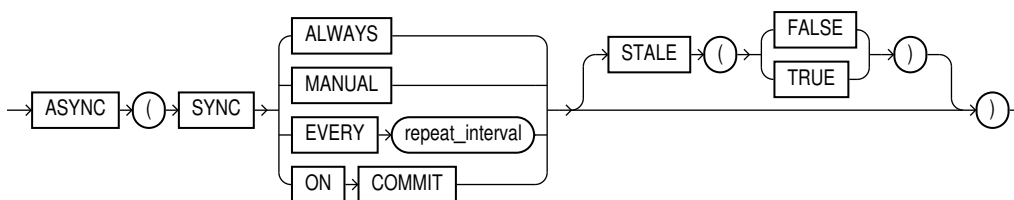
async_clause ::=**See Also:**

[Usage of async_clause](#) (page 6-55)

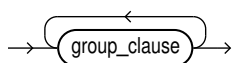
groups_clause ::=**See Also:**

[Usage of groups_clause and alter_index_group_clause](#) (page 6-55)

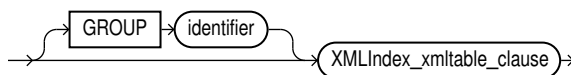
group_clause ::=**See Also:**

[Usage of groups_clause and alter_index_group_clause](#) (page 6-55)

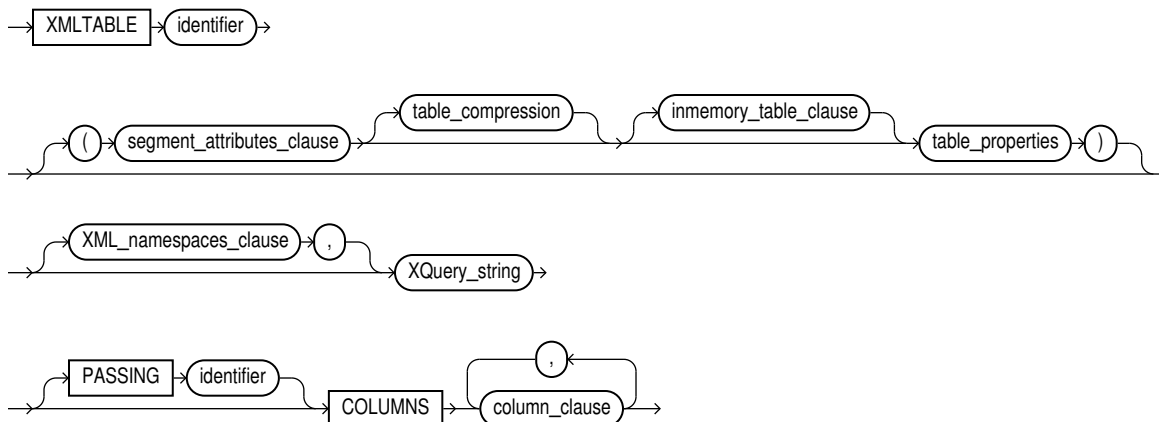
XMLIndex_xmltable_clause ::=

Syntax elements XML_namespaces_clause and XQuery_string are the same as for SQL/XML function XMLTable.

See Also:

- [Usage of XMLIndex_xmltable_clause](#) (page 6-55)
- [XMLTABLE SQL/XML Function in Oracle XML DB](#) (page 4-11)

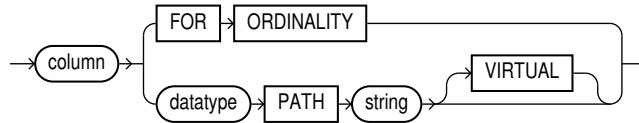
column_clause ::=

Syntax element `column_clause` is similar, but not identical, to `XML_table_column` in SQL/XML function `XMLTable`.

See Also:

- [Usage of column_clause](#) (page 6-56)
- [XMLTABLE SQL/XML Function in Oracle XML DB](#) (page 4-11)

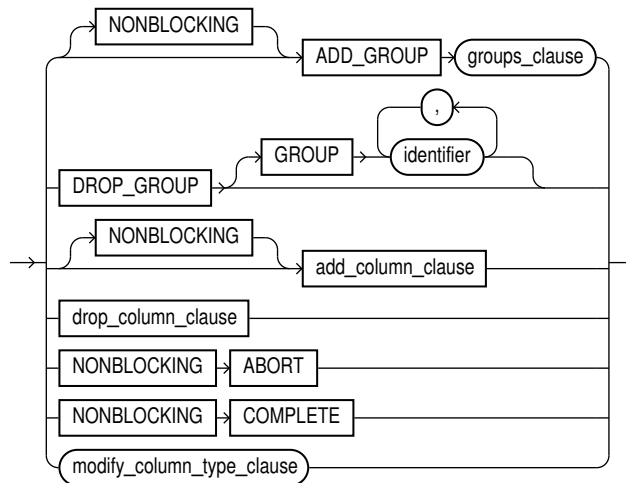
alter_index_group_clause ::=**See Also:**

[Usage of groups_clause and alter_index_group_clause](#) (page 6-55)

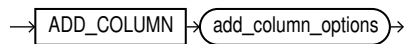
add_column_clause ::=

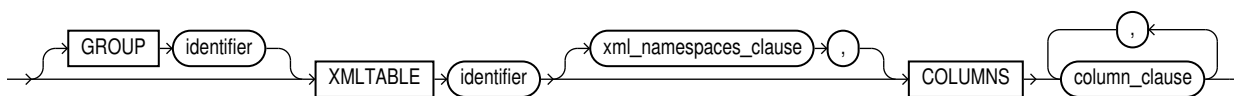
add_column_options ::=

Syntax element `XML_namespaces_clause` is the same as for SQL/XML function `XMLTable`. See [XMLTABLE SQL/XML Function in Oracle XML DB](#) (page 4-11).

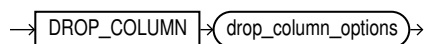
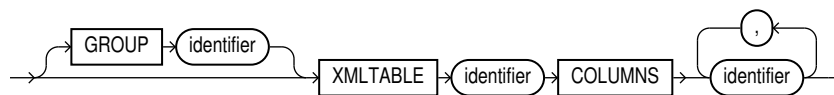
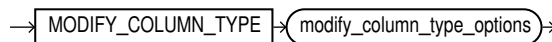
drop_column_clause ::=**drop_column_options ::=****modify_column_type_clause ::=****modify_column_type_options ::=****6.3.17.3 Usage of XMLIndex_parameters_clause**

When you create an `XMLIndex` index, if there is no `XMLIndex_parameters_clause`, then the new index has only an unstructured component. If there is an `XMLIndex_parameters_clause`, but the `PARAMETERS` argument is empty (' '), then the result is the same: an index with only an unstructured component.

See Also:

- *Oracle Database SQL Language Reference* for information about the use context for `XMLIndex_parameters_clause` in `CREATE INDEX`
- *Oracle Database SQL Language Reference* for information about the use context for `XMLIndex_parameters_clause` in `ALTER INDEX`

6.3.17.4 Usage of XMLIndex_parameters

Certain considerations apply to using `XMLIndex_parameters`.

- There can be at most one `XMLIndex_parameter_clause` of each type in `XMLIndex_parameters`. For example, there can be at most one `PATHS` clause, at most one `path_table_clause`, and so on.

- If there is no *structured_clause* when you create an XMLIndex index, then the new index has only an unstructured component. If there is only a *structured_clause*, then the new index has only a structured component.

6.3.17.5 Usage of PATHS Clause

Certain considerations apply to using the PATHS clause.

- There can be at most one PATHS clause in a CREATE INDEX statement. That is, there can be at most one occurrence of PATHS followed by *create_index_paths_clause*.
- Clause *create_index_paths_clause* is used only with CREATE INDEX; *alter_index_paths_clause* is used only with ALTER INDEX.

6.3.17.6 Usage of create_index_paths_clause and alter_index_paths_clause

Certain considerations apply to using *create_index_paths_clause* and *alter_index_paths_clause*.

- The INDEX_ALL_PATHS keyword rebuilds the index to include all paths. This keyword is available only for *alter_index_paths_clause*, not *create_index_paths_clause*.
- An explicit list of paths to index can include wildcards and //.
- *XPaths_list* is a list of one or more XPath expressions, each of which includes only child axis, descendant axis, name test, and wildcard (*) constructs.
- If *XPaths_list* is omitted from *create_index_paths_clause*, all paths are indexed.
- For each unique namespace prefix that is used in an XPath expression in *XPaths_list*, a standard XML namespace declaration is needed, to provide the corresponding namespace information.
- You can change an index in ways that are not reflected directly in the syntax by dropping it and then creating it again as needed. For example, to change an index that was defined by including paths to one that is defined by excluding paths, drop it and then create it using EXCLUDE.

6.3.17.7 Usage of pikey_clause, path_id_clause, and order_key_clause

Syntactically, each of the clauses *pikey_clause*, *path_id_clause*, and *order_key_clause* is optional. A pikey index is created even if you do not specify a *pikey_clause*. To create a path id index or an order-key index, you must specify a *path_id_clause* or an *order_key_clause*, respectively.

6.3.17.8 Usage of value_clause

Certain considerations apply to using *value_clause*.

- Column VALUE is created as VARCHAR2(4000).
- If clause *value_clause* consists only of the keyword VALUE, then the value index is created with the usual default attributes.
- If clause *path_id_clause* consists only of the keywords PATH ID, then the path-id index is created with the usual default attributes.

- If clause *order_key_clause* consists only of the keywords `ORDER KEY`, then the order-key index is created with the usual default attributes.

6.3.17.9 Usage of *async_clause*

Certain considerations apply to using the `ASYNC` clause.

- Use this feature only with an `XMLIndex` index that has *only* an *unstructured* component. If you specify an `ASYNC` clause for an `XMLIndex` index that has a *structured* component, then an error is raised.
- `ALWAYS` means automatic synchronization occurs for each DML statement.
- `MANUAL` means no automatic synchronization occurs. You must manually synchronize the index using `DBMS_XMLINDEX.syncIndex`.
- `EVERY repeat_interval` means automatically synchronize the index at interval *repeat_interval*. The syntax of *repeat_interval* is the same as that for PL/SQL package `DBMS_SCHEDULER`, and it must be enclosed in double quotation marks (`"`). To use `EVERY` you must have the `CREATE JOB` privilege.
- `ON COMMIT` means synchronize the index immediately after a commit operation. The commit does not return until the synchronization is complete. Since the synchronization is performed as a separate transaction, there can be a short period when the data is committed but index changes are not yet committed.
- `STALE` is optional. A value of `TRUE` means that query results might be stale; a value of `FALSE` means that query results are always up-to-date. The default value, and the only permitted explicitly specified value, is as follows.
 - For `ALWAYS`, `STALE` is `FALSE`.
 - For any other `ASYNC` option besides `ALWAYS`, `STALE` is `TRUE`.

6.3.17.10 Usage of *groups_clause* and *alter_index_group_clause*

Clause *groups_clause* is used only with `CREATE INDEX` (or following `ADD GROUP` in clause *alter_index_group_clause*). Clause *alter_index_group_clause* is used only with `ALTER INDEX`.

6.3.17.11 Usage of *XMLIndex_xmltable_clause*

Certain considerations apply to using *XMLIndex_xmltable_clause*.

- The *XQuery_string* expression in *XMLIndex_xmltable_clause* must not use the XQuery functions `ora:view` (*desupported*), `fn:doc`, or `fn:collection`.
- Oracle XML DB raises an error if a given *XMLIndex_xmltable_clause* contains more than one *column_clause* of data type `XMLType`. To achieve the effect of defining two such virtual columns, you must instead add a separate *group_clause*.
- The `PASSING` clause in *XMLIndex_xmltable_clause* is optional. If not present, then an `XMLType` column is passed implicitly, as follows:
 - For the first *XMLIndex_xmltable_clause* in a parameters clause, the `XMLType` column being indexed is passed implicitly. (When indexing an `XMLType` table, pseudocolumn `OBJECT_VALUE` is passed.)

- For each subsequent *XMLIndex_xmltable_clause*, the `VIRTUAL XMLType` column of the preceding *XMLIndex_xmltable_clause* is passed implicitly.

6.3.17.12 Usage of `column_clause`

Certain considerations apply to using *column_clause*.

When you use multilevel chaining of `XMLTable` in an `XMLIndex` index, the `XMLTable` table at one level corresponds to an `XMLType` column at the previous level. The syntax description shows keyword `VIRTUAL` as optional. In fact, it is used only for such an `XMLType` column, in which case it is *required*. It is an error to use it for a non-`XMLType` column. `VIRTUAL` specifies that the `XMLType` column itself is not materialized, meaning that its data is stored in the index only in the form of the relational columns specified by its corresponding `XMLTable` table.

6.4 Indexing XML Data for Full-Text Queries

When you need full-text search over XML data, Oracle recommends that you store your `XMLType` data as binary XML and you use XQuery Full Text (XQFT). You use an XML search index for this. This is the topic of this section.

If portability and standardized code are not a concern, or if your `XMLType` data is stored object-rationally, then you can alternatively use the Oracle-specific full-text constructs and syntax provided by Oracle Text, specifically Oracle SQL function `contains` or Oracle XPath function `ora:contains` (*deprecated*).

You can perform XQuery Full Text (XQFT) queries on `XMLType` data that is stored as binary XML. If you use an XQFT full-text predicate in an `XMLExists` expression within a SQL `WHERE` clause, then you must create an **XML search index**. This section describes the creation and use of such an index.

See Also:

- [Example 6-46](#) (page 6-60)
 - [Support for XQuery Full Text](#) (page 4-28)
-
-

6.4.1 Creating and Using an XML Search Index

An XQuery Full Text query can use an XML search index to improve performance.

To create an XML search index you must be granted database role `CTXAPP`. More generally, this role is needed to create Oracle Text indexes, to set Oracle Text index preferences, or to use Oracle Text PL/SQL packages.

Before creating the index, you must create an Oracle Text path section group and set its `XML_ENABLE` attribute to `t`. This makes the path section group XML-aware.

For best performance, create an index preference of type `BASIC_STORAGE` in the Oracle Text data dictionary, specifying the following attributes:

- `D_TABLE_CLAUSE` – Specify `SECUREFILE` storage for column `DOC` of index data table `$D`, which contains information about the structure of your XML documents. Specify *caching* and medium *compression*.
- `I_TABLE_CLAUSE` – Specify `SECUREFILE` storage for column `TOKEN_INFO` of index data table `$I`, which contains information about full-text tokens and their occurrences in the indexed documents. Specify *caching* (but not compression).

This is illustrated in [Example 6-41](#) (page 6-57), which uses a non XML-schema-based XMLType table, `po_binxml` (which has the same data as table `purchaseorder` in standard database schema OE).

Index preference `BASIC_STORAGE` specifies the tablespace and creation parameters for the database tables and indexes that constitute an Oracle Text index.

See Also:

- *Oracle Text Reference* for information about section groups
 - *Oracle Text Reference* for information about procedure `CTX_DDL.set_sec_grp_attr`
 - *Oracle Text Reference* for information about procedure `CTX_DDL.create_preference`
 - *Oracle Text Reference* for information about procedure `CTX_DDL.set_attribute`
 - *Oracle Text Reference* for information about preference `BASIC_STORAGE`, `D_TABLE_CLAUSE`, and `I_TABLE_CLAUSE`
-
-

[Example 6-42](#) (page 6-57) queries the data to retrieve the `Description` elements whose text contains both `Big` and `Street`, in that order.

[Example 6-43](#) (page 6-58) shows the execution plan for the query, which indicates that index `po_ctx_idx` is picked up.

Example 6-41 Creating an XML Search Index

```
BEGIN
  CTX_DDL.create_section_group('mysecgroup', 'PATH_SECTION_GROUP');
  CTX_DDL.set_sec_grp_attr('mysecgroup', 'XML_ENABLE', 'T');

  CTX_DDL.create_preference('mypref', 'BASIC_STORAGE');
  CTX_DDL.set_attribute('mypref',
    'D_TABLE_CLAUSE',
    'TABLESPACE my_ts
     LOB(DOC) STORE AS SECUREFILE
     (TABLESPACE my_ts COMPRESS MEDIUM CACHE)');
  CTX_DDL.set_attribute('mypref',
    'I_TABLE_CLAUSE',
    'TABLESPACE my_ts
     LOB(TOKEN_INFO) STORE AS SECUREFILE
     (TABLESPACE my_ts NOCOMPRESS CACHE)');

END;
/

CREATE INDEX po_ctx_idx ON po_binxml(OBJECT_VALUE)
  INDEXTYPE IS CTXSYS.CONTEXT
  PARAMETERS('storage mypref section group mysecgroup');
```

Example 6-42 XQuery Full Text Query

```
SELECT XMLQuery('for $i in /PurchaseOrder/LineItems/LineItem/Description
  where $i[. contains text "Big" ftext "Street"]
  return <Title>{$i}</Title>'
  PASSING OBJECT_VALUE RETURNING CONTENT)
```

```

FROM po_binxml
WHERE XMLExists('/PurchaseOrder/LineItems/LineItem/Description
                [. contains text "Big" ftand "Street"]'
                PASSING OBJECT_VALUE);

```

Example 6-43 Execution Plan for XQuery Full Text Query

Id	Operation	Name	Rows	Bytes	Cost (%CPU)	Time
0	SELECT STATEMENT		1	2014	4 (0)	00:00:01
1	TABLE ACCESS BY INDEX ROWID	PO_BINXML	1	2014	4 (0)	00:00:01
* 2	DOMAIN INDEX	PO_CTX_IDX			4 (0)	00:00:01

Predicate Information (identified by operation id):

```

2 - access("CTXSYS"."CONTAINS"(SYS_MAKEXML(0,"XMLDATA"), '<query><textquery
    grammar="CONTEXT" lang="english"> ( ( {Big} ) and ( {Street} ) ) INPATH
    (/PurchaseOrder/LineItems/LineItem/Description)</textquery></query>' )>

```

Note

```

-----
- dynamic sampling used for this statement (level=2)
- Unoptimized XML construct detected (enable XMLOptimizationCheck for more information)

```

21 rows selected.

6.4.2 What To Do If an XML Search Index Is Not Picked Up

You can modify your query to ensure that certain conditions are satisfied, so its evaluation picks up an XML search index.

If you use an XQuery full-text predicate in an `XMLExists` expression within a SQL `WHERE` clause, but you do not create an XML search index or the index cannot be used for some reason, then compile-time error `ORA-18177` is raised.

If this error is raised then your execution plan does *not* indicate that the index is picked up. In the plan you do not see operation `DOMAIN INDEX` followed by the name of the index.

In that case, try to change your query to enable the index to be used. The following conditions must both apply for the index to be picked up:

- The expression that computes the XML nodes for the search context must be an XPath expression whose steps are only along *forward* and *descendent axes*.
- You can pass only one `XMLType` instance as a SQL expression in the `PASSING` clause of SQL/XML function `XMLExists`, and each of the other, non-`XMLType` SQL expressions in that clause must be either a *compile-time constant* of a SQL built-in data type or a *bind variable* that is bound to an instance of such a data type.

6.4.3 Pragma `ora:no_schema`: Using XML Schema-Based Data with XQuery Full Text

Oracle recommends in general that you use *non* XML Schema-based `XMLType` data when you use XQuery Full Text and an XML search index. But you can in some circumstances use XML Schema-based `XMLType` data that is stored as binary XML. Oracle XQuery pragma `ora:no_schema` can be useful in this context.

By default, when an XML search index is used to evaluate XML Schema-based data, compile-time error `ORA-18177` is raised. This is because the full-text indexing itself makes no use of the associated XML schema: it is not type-aware. It treats all of the

text that it applies to as untyped. This error is raised even if you type-cast data appropriately and thus do not depend on the XML schema to cast types implicitly. [Example 6-44](#) (page 6-59) illustrates this.

The error raised draws this to your attention, in case you might be expecting a full-text condition in your query to depend on XML Schema types and typed operations.

In order to use a condition that depends on types you must explicitly cast the relevant XQuery expressions to the appropriate types. Do not expect Oracle XML DB to use the XML schema to perform implicit type casting. Failure to type-cast appropriately can lead to results that you might not expect.

[Example 6-45](#) (page 6-59) shows a query of XML Schema-based data that uses explicit type-casting to ensure that the proper condition is evaluated.

However, most uses of XQuery Full Text expressions, even with XML Schema-based data, do not involve data that is typed. Just remember that if you do use a condition that makes use of typed data then you must cast to the proper type.

In sum, if you are sure that your query does not involve typed data, or if you judge that it is all right to treat particular typed data as if it were untyped, or if you explicitly type-cast any data that needs to be typed, then you can use Oracle XQuery pragma `ora:no_schema` in your query to inhibit raising the error and allow evaluation of the query using an XML search index.

Example 6-44 XQuery Full Text Query with XML Schema-Based Data: Error ORA-18177

```
SELECT XMLQuery('/PurchaseOrder/LineItems/LineItem'
                PASSING OBJECT_VALUE RETURNING CONTENT)
FROM oe.purchaseorder
WHERE XMLExists('/PurchaseOrder
                [LineItems/LineItem/@ItemNumber > xs:integer("20")
                and Actions/Action/User contains text "KPARTNER"]'
                PASSING OBJECT_VALUE);
FROM oe.purchaseorder
*
```

ERROR at line 3:
ORA-18177: XQuery full text expression '/PurchaseOrder
[LineItems/LineItem/@ItemNumber > xs:integer("20")
and Actions/Action/User contains text "KPARTNER"]'
cannot be evaluated using XML text index

Example 6-45 Using XQuery Pragma `ora:no_schema` with XML Schema-Based Data

```
SELECT XMLQuery('/PurchaseOrder/LineItems/LineItem'
                PASSING OBJECT_VALUE RETURNING CONTENT)
FROM oe.purchaseorder
WHERE XMLExists('(# ora:no_schema #)
                {/PurchaseOrder
                [LineItems/LineItem/@ItemNumber > xs:integer("20")
                and Actions/Action/User contains text "KPARTNER"]}')
                PASSING OBJECT_VALUE);
```

6.4.4 Pragma `ora:use_xmltext_idx`: Forcing the Use of an XML Search Index

You can use XQuery pragma `ora:use_xmltext_idx` to force the use of an XML search index.

A given query involving XML data can be evaluated in various ways, depending on the existence of different indexes and other factors. Sometimes the default evaluation method is not the most performant and it would be more efficient to force the use of

an existing XML search index. You can use XQuery pragma `ora:use_xmltext_idx` to do this. (An XML search index applies only to XMLType data stored as binary XML.)

For example, a WHERE clause might include two XMLEExists expressions, only one of which involves an XQuery full-text condition, and you might have an XMLIndex index that applies to the XMLEExists expression that has no full-text condition. With such a query it is typically more efficient to use an XML search index to evaluate the entire WHERE clause.

Even in some cases where there is no full-text condition in the query, the use of an XML search index can provide the most efficient query evaluation.

The query in [Example 6-46](#) (page 6-60) illustrates the use of pragma `ora:use_xmltext_idx`. Only the first of the XMLEExists clauses uses a full-text condition. Because of the pragma, the full-text index (`po_ctx_idx`, created in [Example 6-41](#) (page 6-57)) is used for both XMLEExists clauses.

Example 6-46 Full-Text Query with XQuery Pragma `ora:use_xmltext_idx`

```
SELECT XMLQuery('/PurchaseOrder/LineItems/LineItem'
               PASSING OBJECT_VALUE RETURNING CONTENT)
FROM po_binxml
WHERE XMLEExists('/PurchaseOrder/LineItems/LineItem
                 [Description contains text "Picnic"]' PASSING OBJECT_VALUE)
AND XMLEExists('(# ora:use_xmltext_idx #) {/PurchaseOrder[User="SBELL"]}'
               PASSING OBJECT_VALUE);
```

6.4.5 Migrating from Using Oracle Text Index to XML Search Index

If you have legacy queries for XMLType data stored as binary XML that use SQL function CONTAINS or *deprecated* XPath function `ora:contains` and an Oracle Text index that is not XML-enabled, then consider using XQuery Full Text constructs instead.

The XQuery and XPath Full Text (XQFT) standard is supported by Oracle XML DB starting with Oracle Database 12c Release 1 (12.1). This support applies only to XMLType data stored as binary XML. Prior to that release, for full-text querying of XML data you could use only an Oracle Text index that was not XML-enabled (not an XML search index), and your full-text queries necessarily used Oracle-specific constructs: SQL function CONTAINS or XPath function `ora:contains` (*deprecated*).

If you have legacy code that does this, Oracle recommends that you migrate that code to use XQFT. This section provides information about which XQFT constructs you can use to replace the use of CONTAINS and `ora:contains` in queries.

This use of an Oracle Text index can also be replaced by the use of an XML search index. To replace a query that uses HASPATH by one that uses a simple XQuery expression, you use Oracle XQuery pragma `ora:use_xmltext_idx` to specify that the XML search index is to be picked up. This section also illustrates this.

[Table 6-9](#) (page 6-61) provides a mapping from typical queries that use Oracle-specific constructs to queries that use XQuery Full Text.

Table 6-9 Migrating Oracle-Specific XML Queries to XQuery Full Text

Original Example	Replacement Example
CONTAINS(t.x, 'HASPATH (/P/LIs/LI/Description ¹)') > 0	<pre> XMLExists('(# ora:use_xmltext_idx #) { \$d/P/LIs/LI/Description¹ }' PASSING t.x AS "d") </pre> <p>Or if the data is XML Schema-based:</p> <pre> XMLExists('(# ora:use_xmltext_idx #) { (# ora:no_schema #) { \$d/P/LIs/LI/Description¹ } }' PASSING t.x AS "d") </pre>
CONTAINS(t.x, 'Big INPATH (/P/LIs/LI/Description)') > 0	<pre> XMLExists('\$d/P/LIs/LI/Description [. contains text "Big"]' PASSING t.x AS "d") </pre> <p>Or if the data is XML Schema-based:</p> <pre> XMLExists('(# ora:no_schema #) { \$d/P/LIs/LI/Description [. contains text "Big"] }' PASSING t.x AS "d") </pre>
<pre> XMLExists('\$d/P/LIs/LI/Description [ora:contains(., "Big AND Street") > 0]' PASSING t.x AS "d") </pre>	<pre> XMLExists('\$d/P/LIs/LI/Description [. contains text "Big" ftand "Street"]' PASSING t.x AS "d") </pre>
CONTAINS(t.x, '(Big) AND (Street) INPATH (/P/LIs/LI/Description)') > 0	<pre> XMLExists('\$d/P/LIs/LI/Description [. contains text "Big" ftand "Street"]' PASSING t.x AS "d") </pre>
CONTAINS(t.x, '(Big) OR (Street) INPATH (/P/LIs/LI/Description)') > 0	<pre> XMLExists('\$d/P/LIs/LI/Description [. contains text "Big" ftor "Street"]' PASSING t.x AS "d") </pre>
CONTAINS(t.x, '({Big}) NOT ({Street}) INPATH (/P/LIs/LI/Description)') > 0	<pre> XMLExists('\$d/P/LIs/LI/Description [. contains text "Big" ftand ftnot "Street"]' PASSING t.x AS "d") </pre>
CONTAINS(t.x, '({Street}) MNOT ({Big Street}) INPATH (/P/LIs/LI/Description)') > 0	<pre> XMLExists('\$d/P/LIs/LI/Description [. contains text "Street" not in "Big Street"]' PASSING t.x AS "d") </pre>

Table 6-9 (Cont.) Migrating Oracle-Specific XML Queries to XQuery Full Text

Original Example	Replacement Example
<pre>CONTAINS(t.x, '(NEAR ({Big}, {Street}), 3) INPATH (/P/LIs/LI/Description)') > 0</pre>	<pre>XMLExists('\$d/P/LIs/LI/Description [. contains text "Big" ftand "Street" window 3 words]' PASSING t.x AS "d")</pre>
<p>(Not applicable – Oracle Text queries are not XML namespace aware.)</p>	<pre>XMLExists('declare namespace ipo="http://www.example.com/IPO"; /ipo:P/ipo:LIs/ipo:LI/ipo:Description [. contains text "Big"]' PASSING t.x AS "d")</pre>

- ¹ The path test can contain a predicate expression, which is the same for both the original query (with HASPATH) and its replacement. For example: `/PurchaseOrder/LineItems/LineItem/Part[@Id < "31415927"]`.

6.5 Indexing XMLType Data Stored Object-Relationally

You can effectively index XMLType data that is stored object-relationally by creating B-tree indexes on the underlying database columns that correspond to XML nodes.

If the data to be indexed is a *singleton*, that is, if it can occur only once in any XML instance document, then you can use a *shortcut* of ostensibly creating a function-based index, where the expression defining the index is a functional application, with an XPath-expression argument that targets the singleton data. A shortcut is defined for XMLCast applied to XMLQuery, and another shortcut is defined for (deprecated) Oracle SQL function extractValue.

In many cases, Oracle XML DB then automatically creates appropriate indexes on the underlying object-relational tables or columns; it does *not* create a function-based index on the targeted XMLType data as the CREATE INDEX statement would suggest.

In the case of the extractValue shortcut, the index created is a B-tree index. In the case of XMLCast applied to XMLQuery, the index created is a function-based index on the scalar value resulting from the functional expression. [Indexing Non-Repeating Text Nodes or Attribute Values](#) (page 6-62) describes this.

If the data to be indexed is a *collection*, then you cannot use such a shortcut; you must create the B-tree indexes manually. [Indexing Repeating \(Collection\) Elements](#) (page 6-63) describes this.

6.5.1 Indexing Non-Repeating Text Nodes or Attribute Values

Table purchaseorder in sample database schema OE is stored object-relationally. Each purchase-order document has a single Reference element; this element is a singleton. You can thus use a shortcut to create an index on the underlying object-relational data.

[Example 6-47](#) (page 6-63) shows a CREATE INDEX statement that ostensibly tries to create a function-based index using XMLCast applied to XMLQuery, targeting the text content of element Reference. (The content of this element is only text, so targeting the element is the same as targeting its text node using XPath node test text (.))

[Example 6-48](#) (page 6-63) ostensibly tries to create a function-based index using (deprecated) Oracle SQL function `extractValue`, targeting the same data.

In reality, in both [Example 6-47](#) (page 6-63) and [Example 6-48](#) (page 6-63) no function-based index is created on the targeted XMLType data. Instead, Oracle XML DB rewrites the `CREATE INDEX` statements to create indexes on the underlying scalar data.

See Also:

[Example 19-7](#) (page 19-8) and [Example 19-8](#) (page 19-8) for information about XPath rewrite as it applies to such `CREATE INDEX` statements

In some cases when you use either of these shortcuts, the `CREATE INDEX` statement is not able to create an index on the underlying scalar data as described, and it instead actually does create a function-based index on the referenced XMLType data. (This is so, even if the *value* of the index might be a scalar.)

If this happens, drop the index, and create instead an `XMLIndex` index with a structured component that targets the same XPath. As a general rule, Oracle recommends against using a function-based index on XMLType data.

This is an instance of a general rule for XMLType data, regardless of the storage method used: Use an `XMLIndex` with a structured component instead of a function-based index. This rule applies starting with Oracle Database 11g Release 2 (11.2). Respecting this rule obviates the overhead associated with maintenance operations on function-based indexes, and it can increase the number of situations in which the optimizer can correctly select the index.

See Also:

[Function-Based Indexes Are Deprecated for XMLType](#) (page 6-6)

Example 6-47 CREATE INDEX Using XMLCAST and XMLQUERY on a Singleton Element

```
CREATE INDEX po_reference_ix ON purchaseorder
  (XMLCast(XMLQuery ('$p/PurchaseOrder/Reference' PASSING po.OBJECT_VALUE AS "p"
                   RETURNING CONTENT)
            AS VARCHAR2(128)));
```

Example 6-48 CREATE INDEX Using EXTRACTVALUE on a Singleton Element

```
CREATE INDEX po_reference_ix ON purchaseorder
  (extractValue(OBJECT_VALUE, '/PurchaseOrder/Reference'));
```

6.5.2 Indexing Repeating (Collection) Elements

In XMLType data stored object-rationally, a collection is stored as an ordered collection table (OCT) of an XMLType instance, which means that you can directly access its members. Because object-relational storage directly reflects the fine-grained structure of the XML data, you can create indexes that target individual collection members.

You must create such indexes manually. The special feature of automatically creating B-tree indexes when you ostensibly create a function-based index for (deprecated)

Oracle SQL function `extractValue` does *not* apply to collections (the XPath expression passed to `extractValue` must target a singleton).

To create B-tree indexes for a collection, you must understand the structure of the SQL object that is used to manage the collection. Given this information, you can use conventional object-relational SQL code to create the indexes directly on the appropriate SQL-object attributes. Refer to [Guideline: Create indexes on ordered collection tables](#) (page 19-8) for an example of how to do this.

Transformation and Validation of XMLType Data

There are several Oracle SQL functions and XMLType APIs for transforming XMLType data using XSLT stylesheets and for validating XMLType instances against an XML schema.

- [XSL Transformation and Oracle XML DB](#) (page 7-1)
- [Validation of XMLType Instances](#) (page 7-11)

7.1 XSL Transformation and Oracle XML DB

You can apply XSL transformations to XML Schema-based documents using the built-in Oracle XML DB XSLT processor. In-database XML-specific optimizations can significantly reduce the memory required, eliminate the overhead associated with parsing, and reduce network traffic.

The W3C XSLT Recommendation defines an XML language for specifying how to transform XML documents from one form to another. See <http://www.w3.org/TR/xslt> for information about the XSLT standard.

Transformation can include mapping from one XML schema to another or mapping from XML to some other format such as HTML or WML.

XSL transformation can be costly in terms of the amount of memory and processing required. In typical XSL processors, the entire source document and stylesheet must be parsed and loaded into memory, before processing can begin. Typically, XSL processors use DOM to provide dynamic memory representations of document and stylesheet, to allow random access to their different parts. The XSL processor then applies the stylesheet to the source document, generating a third document.

Parsing and loading the document and stylesheet into memory before beginning transformation requires significant memory and processor resources. It is especially inefficient when only a small part of the document needs to be transformed.

Oracle XML DB includes an XSLT processor that performs XSL transformations *inside the database*. In this way, it can provide XML-specific optimizations that can significantly reduce the memory required to perform the transformation, eliminate overhead associated with parsing, and reduce network traffic.

These optimizations are available, however, *only* when the source for the transformation is a *schema-based* XML document. In that case, there is no need to parse before processing can begin. The Oracle XML DB lazily loaded virtual DOM loads content only on demand, as the nodes are accessed. This also reduces the memory required, because only parts of the document that need to be processed are loaded.

You can transform XML data in the following ways:

- In Oracle Database – Using Oracle SQL function `XMLtransform`, XMLType method `transform()`, or PL/SQL package `DBMS_XSLPROCESSOR`
- In the middle tier – Using Oracle XML Developer's Kit transformation options, such as XSLT Processor for Java.

See Also:

- *Oracle Database SQL Language Reference* for information about SQL function `XMLTransform`
 - [PL/SQL XSLT Processor for XMLType \(DBMS_XSLPROCESSOR\)](#) (page 11-24) and *Oracle Database PL/SQL Packages and Types Reference* for information about PL/SQL package `DBMS_XSLPROCESSOR`
 - *Oracle XML Developer's Kit Programmer's Guide* for information about XSLT Processor for Java
-
-

Each of these XML transformation methods takes as input a source XML document and an XSL stylesheet in the form of XMLType instances. For SQL function `XMLtransform` and XMLType method `transform()`, the result of the transformation can be an XML document or a non-XML document, such as HTML. However, for PL/SQL package `DBMS_XSLPROCESSOR`, the result of the transformation is expected to be a valid XML document. Any HTML data generated by a transformation using package `DBMS_XSLPROCESSOR` is XHTML data, which is both valid XML data and valid HTML data.

[Example 7-1](#) (page 7-2) shows part of an XSLT stylesheet, `PurchaseOrder.xsl`. The complete stylesheet is given in [XSLT Stylesheet Example, PurchaseOrder.xsl](#) (page A-41).

There is nothing Oracle XML DB-specific about the stylesheet of [Example 7-1](#) (page 7-2). A stylesheet can be stored in an XMLType table or column or stored as non-schema-based XML data inside Oracle XML DB Repository.

Example 7-1 XSLT Stylesheet Example: PurchaseOrder.xsl

```
<?xml version="1.0" encoding="WINDOWS-1252"?>
<xsl:stylesheet version="1.0"
  xmlns:xsl="http://www.w3.org/1999/XSL/Transform"
  xmlns:xdb="http://xmlns.oracle.com/xdb"
  xmlns:xsi="http://www.w3.org/2001/XMLSchema-instance">
  <xsl:template match="/">
    <html>
      <head/>
      <body bgcolor="#003333" text="#FFFFFF" link="#FFCC00" vlink="#66CC99" alink="#669999">
        <FONT FACE="Arial, Helvetica, sans-serif">
          <xsl:for-each select="PurchaseOrder"/>
          <xsl:for-each select="PurchaseOrder">
            <center>
              <span style="font-family:Arial; font-weight:bold">
                <FONT COLOR="#FF0000">
                  <B>PurchaseOrder </B>
                </FONT>
              </span>
            </center>
            <br/>
            <center>
              <xsl:for-each select="Reference">
                <span style="font-family:Arial; font-weight:bold">
                  <xsl:apply-templates/>
                </span>
              </xsl:for-each>
            </center>
          </xsl:for-each>
        </FONT>
      </body>
    </html>
  </xsl:template>
</xsl:stylesheet>
```



```

        </span>
      </xsl:for-each>
    </center>
  </xsl:for-each>
  <P>
    <xsl:for-each select="PurchaseOrder">
      <br/>
    </xsl:for-each>
  <P/>
  <P>
    <xsl:for-each select="PurchaseOrder">
      <br/>
    </xsl:for-each>
  </P>
</P>
<xsl:for-each select="PurchaseOrder" />
<xsl:for-each select="PurchaseOrder">
  <table border="0" width="100%" BGOLOR="#000000">
    <tbody>
      <tr>
        <td WIDTH="296">
          <P>
            <B>
              <FONT SIZE="+1" COLOR="#FF0000" FACE="Arial, Helvetica, sans-serif">Internal</FONT>
            </B>
          </P>
          ...
        </td>
        <td width="93" />
        <td valign="top" WIDTH="340">
          <B>
            <FONT COLOR="#FF0000">
              <FONT SIZE="+1">Ship To</FONT>
            </FONT>
          </B>
          <xsl:for-each select="ShippingInstructions">
            <xsl:if test="position()=1"/>
          </xsl:for-each>
          <xsl:for-each select="ShippingInstructions">
            </xsl:for-each>
          ...
        </td>
      </tr>
    </tbody>
  </table>
</xsl:for-each>

```

7.1.1 SQL Function XMLTRANSFORM and XMLType Method TRANSFORM()

SQL function `XMLtransform` transforms an XML document by using an XSLT stylesheet. It returns the processed output as XML, HTML, and so on, as specified by the stylesheet.

Figure 7-1 (page 7-3) shows the syntax of Oracle SQL function `XMLtransform`. This function takes as arguments an `XMLType` instance and an XSLT stylesheet. The stylesheet can be an `XMLType` instance or a `VARCHAR2` string literal. It applies the stylesheet to the instance and returns an `XMLType` instance.

Figure 7-1 XMLTRANSFORM Syntax

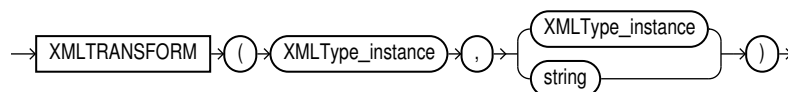

You can alternatively use `XMLType` method `transform()` as an alternative to Oracle SQL function `XMLtransform`. It has the same functionality.

Figure 7-2 (page 7-4) shows how `XMLtransform` transforms an XML document by using an XSLT stylesheet. It returns the processed output as XML, HTML, and so on, as specified by the XSLT stylesheet. You typically use `XMLtransform` when retrieving or generating XML documents stored as `XMLType` in the database.

See Also:

Figure 1-3 (page 1-9) in [Introduction to Oracle XML DB](#) (page 1-1)

Figure 7-2 Using XMLTRANSFORM



7.1.1.1 XMLTRANSFORM and XMLType.transform(): Examples

Examples illustrate how to use Oracle SQL function `XMLtransform` and `XMLType` method `transform()` to transform XML data stored as `XMLType` to various formats.

[Example 7-2](#) (page 7-4) sets up an XML schema and tables that are needed to run other examples in this chapter. The call to `deleteSchema` here ensures that there is no existing XML schema before creating one. If no such schema exists, then `deleteSchema` raises an error.

[Example 7-3](#) (page 7-6) stores an XSLT stylesheet, then retrieves it and uses it with Oracle SQL function `XMLtransform` to transform the XML data stored in [Example 7-2](#) (page 7-4).

[Example 7-4](#) (page 7-7) uses `XMLType` method `transform()` with an XSL stylesheet created on the fly.

[Example 7-5](#) (page 7-8) uses `XMLtransform` to apply an XSL stylesheet to produce HTML code. PL/SQL constructor `XDBURIType` reads the XSL stylesheet from Oracle XML DB Repository.

Only part of the HTML result is shown in [Example 7-5](#) (page 7-8). Omitted parts are indicated with an ellipsis (. . .). [Figure 7-3](#) (page 7-10) shows what the transformed result looks like in a Web browser.

Example 7-2 Registering an XML Schema and Inserting XML Data

```

BEGIN
  -- Delete the schema, if it already exists.
  DBMS_XMLSCHEMA.deleteSchema('http://www.example.com/schemas/ipo.xsd',4);
END;
/
BEGIN
  -- Register the schema
  DBMS_XMLSCHEMA.registerSchema(
    SCHEMAURL => 'http://www.example.com/schemas/ipo.xsd',
    SCHEMADOC => '<schema targetNamespace="http://www.example.com/IPO"
      xmlns="http://www.w3.org/2001/XMLSchema"
      xmlns:ipo="http://www.example.com/IPO">
      <!-- annotation>
      <documentation xml:lang="en">
        International Purchase order schema for Example.com
        Copyright 2000 Example.com. All rights reserved.
      </documentation>
  
```

```

</annotation -->
<element name="purchaseOrder" type="ipo:PurchaseOrderType"/>
<element name="comment" type="string"/>
<complexType name="PurchaseOrderType">
  <sequence>
    <element name="shipTo" type="ipo:Address"/>
    <element name="billTo" type="ipo:Address"/>
    <element ref="ipo:comment" minOccurs="0"/>
    <element name="items" type="ipo:Items"/>
  </sequence>
  <attribute name="orderDate" type="date"/>
</complexType>
<complexType name="Items">
  <sequence>
    <element name="item" minOccurs="0" maxOccurs="unbounded">
      <complexType>
        <sequence>
          <element name="productName" type="string"/>
          <element name="quantity">
            <simpleType>
              <restriction base="positiveInteger">
                <maxExclusive value="100"/>
              </restriction>
            </simpleType>
          </element>
          <element name="USPrice" type="decimal"/>
          <element ref="ipo:comment" minOccurs="0"/>
          <element name="shipDate" type="date" minOccurs="0"/>
        </sequence>
        <attribute name="partNum" type="ipo:SKU" use="required"/>
      </complexType>
    </element>
  </sequence>
</complexType>
<complexType name="Address">
  <sequence>
    <element name="name" type="string"/>
    <element name="street" type="string"/>
    <element name="city" type="string"/>
    <element name="state" type="string"/>
    <element name="country" type="string"/>
    <element name="zip" type="string"/>
  </sequence>
</complexType>
<simpleType name="SKU">
  <restriction base="string">
    <pattern value="[0-9]{3}-[A-Z]{2}"/>
  </restriction>
</simpleType>
</schema>',
LOCAL => TRUE,
GENTYPES => TRUE);
END;
/

-- Create table to hold XML purchase-order documents, and insert the documents
DROP TABLE po_tab;
CREATE TABLE po_tab (id NUMBER, xmlcol XMLType)
XMLType COLUMN xmlcol
XMLSCHEMA "http://www.example.com/schemas/ipo.xsd"
ELEMENT "purchaseOrder";

```

```

INSERT INTO po_tab
VALUES(1, XMLType(
  '<?xml version="1.0"?>
  <ipo:purchaseOrder
    xmlns:xsi="http://www.w3.org/2001/XMLSchema-instance"
    xmlns:ipo="http://www.example.com/IPO"
    xsi:schemaLocation="http://www.example.com/IPO
      http://www.example.com/schemas/ipo.xsd"
    orderDate="1999-12-01">
    <shipTo>
      <name>Helen Zoe</name>
      <street>121 Broadway</street>
      <city>Cardiff</city>
      <state>Wales</state>
      <country>UK</country>
      <zip>CF2 1QJ</zip>
    </shipTo>
    <billTo>
      <name>Robert Smith</name>
      <street>8 Oak Avenue</street>
      <city>Old Town</city>
      <state>CA</state>
      <country>US</country>
      <zip>95819</zip>
    </billTo>
    <items>
      <item partNum="833-AA">
        <productName>Lapis necklace</productName>
        <quantity>1</quantity>
        <USPrice>99.95</USPrice>
        <ipo:comment>Want this for the holidays!</ipo:comment>
        <shipDate>1999-12-05</shipDate>
      </item>
    </items>
  </ipo:purchaseOrder>'));

```

Example 7-3 Using SQL Function XMLTRANSFORM to Apply an XSL Stylesheet

```

DROP TABLE stylesheet_tab;
CREATE TABLE stylesheet_tab (id NUMBER, stylesheet XMLType);
INSERT INTO stylesheet_tab
VALUES (1,
  XMLType(
    '<?xml version="1.0" ?>
    <xsl:stylesheet version="1.0"
      xmlns:xsl="http://www.w3.org/1999/XSL/Transform">
    <xsl:template match="*">
    <td>
      <xsl:choose>
        <xsl:when test="count(child:*) > 1">
          <xsl:call-template name="nested"/>
        </xsl:when>
        <xsl:otherwise>
          <xsl:value-of select="name(.)"/><xsl:value-of
            select="text()"/>
        </xsl:otherwise>
      </xsl:choose>
    </td>
    </xsl:template>
    <xsl:template match="*" name="nested" priority="-1" mode="nested2">

```

```

<b>
  <!-- xsl:value-of select="count(child:*)" / -->
  <xsl:choose>
    <xsl:when test="count(child:*) > 1">
      <xsl:value-of select="name(.)"/><xsl:apply-templates
        mode="nested2"/>
    </xsl:when>
    <xsl:otherwise>
      <xsl:value-of select="name(.)"/><xsl:value-of
        select="text()"/>
    </xsl:otherwise>
  </xsl:choose>
</b>
</xsl:template>
</xsl:stylesheet>');

```

```

SELECT XMLSerialize(DOCUMENT XMLtransform(x.xmlcol, y.stylesheet)
  AS VARCHAR2(1000))
  AS result FROM po_tab x, stylesheet_tab y WHERE y.id = 1;

```

This produces the following output (pretty-printed here for readability):

RESULT

```

<td>
  <b>ipo:purchaseOrder:
    <b>shipTo:
      <b>name:Helen Zoe</b>
      <b>street:100 Broadway</b>
      <b>city:Cardiff</b>
      <b>state:Wales</b>
      <b>country:UK</b>
      <b>zip:CF2 1QJ</b>
    </b>
    <b>billTo:
      <b>name:Robert Smith</b>
      <b>street:8 Oak Avenue</b>
      <b>city:Old Town</b>
      <b>state:CA</b>
      <b>country:US</b>
      <b>zip:95819</b>
    </b>
    <b>items:</b>
  </b>
</td>

```

Example 7-4 Using XMLType Method TRANSFORM() with a Transient XSL Stylesheet

```

SELECT XMLSerialize(
  DOCUMENT
  x.xmlcol.transform(
    XMLType('<?xml version="1.0" ?>
      <xsl:stylesheet
        version="1.0"
        xmlns:xsl="http://www.w3.org/1999/XSL/Transform">
        <xsl:template match="*">
          <td>
            <xsl:choose>
              <xsl:when test="count(child:*) > 1">
                <xsl:call-template name="nested"/>
              </xsl:when>

```

```

        <xsl:otherwise>
          <xsl:value-of
            select =
              "name(.)"/><xsl:value-of select="text()"/>
        </xsl:otherwise>
      </xsl:choose>
    </td>
  </xsl:template>
  <xsl:template match="*" name="nested" priority="-1"
    mode="nested2">
    <b>
      <!-- xsl:value-of select="count(child:*)" / -->
      <xsl:choose>
        <xsl:when test="count(child:*) > 1">
          <xsl:value-of select="name(.)"/>:
          <xsl:apply-templates mode="nested2"/>
        </xsl:when>
        <xsl:otherwise>
          <xsl:value-of
            select =
              "name(.)"/><xsl:value-of select="text()"/>
          </xsl:otherwise>
        </xsl:choose>
      </b>
    </xsl:template>
  </xsl:stylesheet>'))
  AS varchar2(1000))
FROM po_tab x;

```

Example 7-5 Using XMLTRANSFORM to Apply an XSL Stylesheet Retrieved Using XDBURITYPE

```

SELECT
  XMLTransform(
    OBJECT_VALUE,
    XDBURITYPE('/source/schemas/poSource/xsl/purchaseOrder.xsl').getXML())
FROM purchaseorder
WHERE XMLExists('$p/PurchaseOrder[Reference="SBELL-2002100912333601PDT"]'
  PASSING OBJECT_VALUE AS "p");

XMLTRANSFORM(OBJECT_VALUE, XDBURITYPE('/SOURCE/SCHEMAS/POSOURCE/XSL/PURCHASEORDER.XSL').GET
-----
<html xmlns:xdb="http://xmlns.oracle.com/xdb"
  xmlns:xsi="http://www.w3.org/2001/XMLSchema-instance">
  <head/>
  <body bgcolor="#003333" text="#FFFFFF" link="#FFCC00" vlink="#66CC99" alink="#669999">
    <FONT FACE="Arial, Helvetica, sans-serif">
      <center>
        <span style="font-family:Arial; font-weight:bold">
          <FONT COLOR="#FF0000">
            <B>PurchaseOrder </B>
          </FONT>
        </span>
      </center>
    <br/>
    <center>
      <span style="font-family:Arial; font-weight:bold">SBELL-2002100912333601PDT</span>
    </center>
    <P>
      <br/>
    <P/>
    <P>
      <br/>
    </P>
  </P>

```

```

<table border="0" width="100%" BGCOLOR="#000000">
  <tbody>
    <tr>
      <td WIDTH="296">
        <P>
          <B>
            <FONT SIZE="+1" COLOR="#FF0000" FACE="Arial, Helvetica,
              sans-serif">Internal</FONT>
          </B>
        </P>
        <table border="0" width="98%" BGCOLOR="#000099">
          . . .
        </table>
      </td>
      <td width="93">
      </td>
      <td valign="top" WIDTH="340">
        <B>
          <FONT COLOR="#FF0000">
            <FONT SIZE="+1">Ship To</FONT>
          </FONT>
        </B>
        <table border="0" BGCOLOR="#999900">
          . . .
        </table>
      </td>
    </tr>
  </tbody>
</table>
<br/>
<B>
  <FONT COLOR="#FF0000" SIZE="+1">Items:</FONT>
</B>
<br/>
<br/>
<table border="0">
  . . .
</table>
</FONT>
</body>
</html>

```

1 row selected.

7.1.2 XSL Transformation Using DBUri Servlet

You can apply an XSL transformation to XML content that is generated by the DBUri servlet.

[Figure 7-3](#) (page 7-10) shows the result of such a transformation. The URL is the following (it is split and truncated here):

```

http://localhost:8080/oradb/SCOTT/PURCHASEORDER/ROW/PurchaseOrder[Reference="SBELL-2003030912333601PDT"]
contentType=text/html&transform=/home/SCOTT/xsl/purchaseOrder.xsl...

```

The presence of parameter `transform` causes the DBUri servlet to use SQL function `XMLTransform` to apply the XSL stylesheet at `/home/SCOTT/xsl/purchaseOrder.xsl` to the `PurchaseOrder` document that is identified by the main URL. The result of the transformation, which is HTML code, is returned to the browser for display. The URL also uses parameter `contentType` to specify that the MIME-type of the final document is `text/html`.

Figure 7-3 Database XSL Transformation of a PurchaseOrder Using DBUri Servlet

Figure 7-4 (page 7-11) shows table departments displayed as an HTML document. You need no code to achieve this. You need only an XMLType view based on SQL/XML functions, an industry-standard XSL stylesheet, and DBUri servlet.

Figure 7-4 Database XSL Transformation of Departments Table Using DBUri Servlet

DEPARTMENT	LOCATION	EMPLOYEES
IT	2014 Jaberwocky Rd Southlake Texas 26192 United States of America	Alexander Hunold Programmer 9000 03-JAN-90
		Diana Lorentz Programmer 4200 07-FEB-99
		Valli Pataballa Programmer 4800 05-FEB-98
		David Austin Programmer 4800 25-JUN-97
		Bruce Ernst Programmer 6000 21-MAY-91
Shipping	2011 Interiors Blvd South San Francisco California 99236 United States of America	Kevin Mourgos Stock Manager 5800 16-NOV-99
		Shanta Vollman Stock Manager 6500 10-OCT-97
		Payam Kaufing Stock Manager 7900 01-MAY-95
		Adam Fripp Stock Manager 8200 10-APR-97
		Matthew Weiss Stock Manager 8000 18-JUL-96

7.2 Validation of XMLType Instances

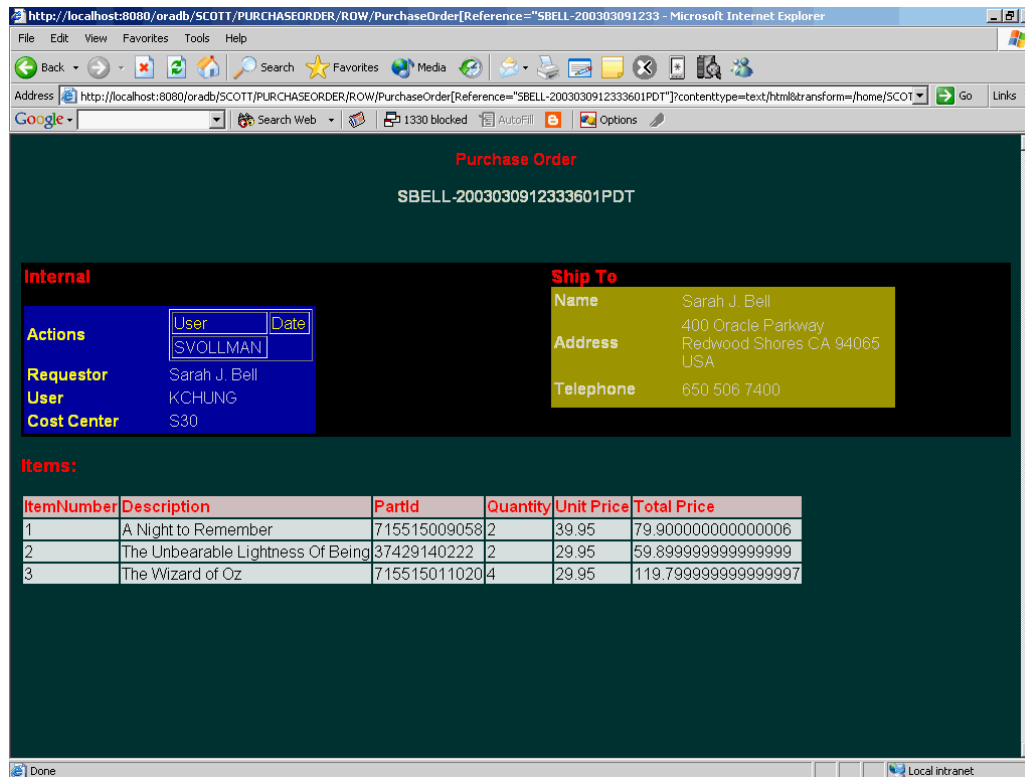
Besides needing to know whether a particular XML document is well-formed, you often need to know whether it conforms to a given XML schema, that is, whether it is valid with respect to that XML schema.

XML schema-based data that is stored as binary XML is automatically validated fully whenever it is inserted or updated. This validation does not require building a DOM. It is done using streaming, which is efficient and minimizes memory use.

For XMLType data that is stored object-relationally, full validation requires building a DOM, which can be costly in terms of memory management. For this reason, Oracle XML DB does not automatically perform full validation when you insert or update data that is stored object-relationally.

However, in the process of decomposing XML data to store it object-relationally, Oracle XML DB does automatically perform partial validation, to ensure that the structure of the XML document conforms to the SQL data type definitions that were derived from the XML schema.

If you require full validation for XMLType data stored object-relationally, then consider validating on the client before inserting the data into the database or updating it.

You can use the following to perform full validation and manipulate the recorded validation status of XML documents:

- Oracle SQL function **XMLIsValid** and XMLType method **IsSchemaValid()** – Run the validation process unconditionally. Do not record any validation status. Return:
 - 1 if the document is determined to be *valid*.
 - 0 if the document is determined to be *invalid* or the validity of the document *cannot be determined*.
- XMLType method **SchemaValidate()** – Runs the validation process if the validation status is 0, which it is by default. Sets the validation status to 1 if the document is determined to be *valid*. (Otherwise, the status remains 0.)
- XMLType method **isSchemaValidated()** returns the recorded validation status of an XMLType instance.
- XMLType method **setSchemaValidated()** sets (records) the validation status of an XMLType instance.

The validation status indicates knowledge of validity, as follows:

- 1 means that the document is known to be *valid*.
- 0 means that validity of the document is *unknown*. The document might have been shown to be invalid during a validation check, but that invalidity is not recorded. A recorded validation status of 0 indicates only a lack of knowledge about the document's validity.

See Also:

- [Partial and Full XML Schema Validation](#) (page 7-12)
 - *Oracle Database SQL Language Reference* for information about Oracle SQL function `XMLIsValid`
 - *Oracle Database PL/SQL Packages and Types Reference* for information about XMLType methods `IsSchemaValid()`, `IsSchemaValidated()`, `SchemaValidate()`, and `setSchemaValidated()`
-
-

7.2.1 Partial and Full XML Schema Validation

When you insert XML Schema-based documents into the database they can be validated partially or fully.

7.2.1.1 Partial Validation

For binary XML storage, Oracle XML DB validates XML Schema-based documents fully when they are inserted into an XMLType table or column. For object-relational XML storage, only a partial validation is performed. This is because complete XML schema validation is quite costly for object-relational storage, in terms of performance.

Partial validation ensures only that all of the mandatory elements and attributes are present, and that there are no unexpected elements or attributes in the document. That is, it ensures only that the structure of the XML document conforms to the SQL data type definitions that were derived from the XML schema. Partial validation does not ensure that the instance document is fully compliant with the XML schema.

[Example 7-6](#) (page 7-13) provides an example of failing partial validation while inserting an XML document into table `PurchaseOrder`, which is stored object-relationally.

Example 7-6 Error When Inserting Incorrect XML Document (Partial Validation)

```
INSERT INTO purchaseorder
  VALUES(XMLType(bfilename('XMLDIR', 'InvalidElement.xml'),
    nls_charset_id('AL32UTF8')));
  VALUES(XMLType(bfilename('XMLDIR', 'InvalidElement.xml'),
    *
ERROR at line 2:
ORA-30937: No schema definition for 'UserName' (namespace '##local') in parent
'/PurchaseOrder'
```

7.2.1.2 Full Validation

Loading XML Schema-based data into binary XML storage fully validates it against the target XML schemas. For object-relational XMLType storage, you can force full validation at any time.

To force full validation, use either of the following:

- Table level CHECK constraint
- PL/SQL BEFORE INSERT trigger

Both approaches ensure that only valid XML documents can be stored in the XMLType table.

The advantage of a TABLE CHECK constraint is that it is easy to code. The disadvantage is that it is based on Oracle SQL function `XMLIsValid`, so it can only indicate whether or not the XML document is valid. If an XML document is invalid, a TABLE CHECK constraint cannot provide any information about *why* it is invalid.

A BEFORE INSERT trigger requires slightly more code. The trigger validates the XML document by invoking XMLType method `schemaValidate()`. The advantage of using `schemaValidate()` is that the exception raised provides additional information about what was wrong with the instance document. Using a BEFORE INSERT trigger also makes it possible to attempt corrective action when an invalid document is encountered.

7.2.1.2.1 Full XML Schema Validation Costs Processing Time and Memory Usage

Unless you are using binary XML storage, full XML schema validation costs processing time and memory. You should thus perform full XML schema validation only when necessary.

If you can rely on your application to validate an XML document then you can obtain higher overall throughput with non-binary XML storage, by avoiding the overhead associated with full validation. If you cannot be sure about the validity of incoming XML documents, you can rely on the database to ensure that an XMLType table or column contains only schema-valid XML documents.

[Example 7-7](#) (page 7-14) shows how to force a full XML schema validation by adding a CHECK constraint to an XMLType table. In [Example 7-7](#) (page 7-14), the XML document `InvalidReference` is not valid with respect to the XML schema. The XML schema defines a minimum length of 18 characters for the text node associated with the `Reference` element. In this document, the node contains the value `SBELL-20021009`, which is only 14 characters long. Partial validation would not

catch this error. Unless the constraint or trigger is present, attempts to insert this document into the database would succeed.

Example 7-7 Forcing Full XML Schema Validation Using a CHECK Constraint

```
ALTER TABLE purchaseorder
  ADD CONSTRAINT validate_purchaseorder
  CHECK (XMLIsValid(OBJECT_VALUE) = 1);
```

Table altered.

```
INSERT INTO purchaseorder
  VALUES (XMLType(bfilename('XMLDIR', 'InvalidReference.xml'),
    nls_charset_id('AL32UTF8')));
```

```
INSERT INTO purchaseorder
*
```

```
ERROR at line 1:
ORA-02290: check constraint (QUINE.VALIDATE_PURCHASEORDER) violated
```

Pseudocolumn OBJECT_VALUE can be used to access the content of an XMLType table from within a trigger. [Example 7-8](#) (page 7-14) illustrates this, showing how to use a BEFORE INSERT trigger to validate that the data being inserted into the XMLType table conforms to the specified XML schema.

Example 7-8 Enforcing Full XML Schema Validation Using a BEFORE INSERT Trigger

```
CREATE OR REPLACE TRIGGER validate_purchaseorder
  BEFORE INSERT ON purchaseorder
  FOR EACH ROW
BEGIN
  IF (:new.OBJECT_VALUE IS NOT NULL) THEN :new.OBJECT_VALUE.schemavalidate();
  END IF;
END;
/
```

```
INSERT INTO purchaseorder VALUES (XMLType(bfilename('XMLDIR',
'InvalidReference.xml'),
  nls_charset_id('AL32UTF8')));
VALUES (XMLType( bfilename('XMLDIR', 'InvalidReference.xml'),
  *
```

```
ERROR at line 2:
ORA-31154: invalid XML document
ORA-19202: Error occurred in XML processing
LSX-00221: "SBELL-20021009" is too short (minimum length is 18)
LSX-00213: only 0 occurrences of particle "sequence", minimum is 1
ORA-06512: at "SYS.XMLTYPE", line 354
ORA-06512: at "QUINE.VALIDATE_PURCHASEORDER", line 3
ORA-04088: error during execution of trigger 'QUINE.VALIDATE_PURCHASEORDER'
```

7.2.2 Validating XML Data Stored as XMLType: Examples

Examples here illustrate how to use Oracle SQL function XMLIsValid and XMLType methods isSchemaValid() and schemaValidate() to validate XML data being stored as XMLType in Oracle XML DB.

[Example 7-9](#) (page 7-15) and [Example 7-10](#) (page 7-15) show how to validate an XML instance against an XML schema using PL/SQL method isSchemaValid().

XMLType method `schemaValidate()` can be used within INSERT and UPDATE triggers to ensure that all instances stored in the table are validated against the XML schema. [Example 7-11](#) (page 7-15) illustrates this.

[Example 7-12](#) (page 7-15) uses Oracle SQL function `XMLIsValid` to do the following:

- Verify that the XMLType instance conforms to the specified XML schema
- Ensure that the incoming XML documents are valid by using CHECK constraints

Note:

The validation functions and procedures described in [Validation of XMLType Instances](#) (page 7-11) facilitate validation checking. Of these, `schemaValidate` is the only one that raises errors that indicate why validation has failed.

Example 7-9 Validating XML Using Method `ISSCHEMAVALID()` in SQL

```
SELECT x.xmlcol.isSchemaValid('http://www.example.com/schemas/ipo.xsd',
                             'purchaseOrder')
FROM po_tab x;
```

Example 7-10 Validating XML Using Method `ISSCHEMAVALID()` in PL/SQL

```
DECLARE
    xml_instance XMLType;
BEGIN
    SELECT x.xmlcol INTO xml_instance FROM po_tab x WHERE id = 1;
    IF xml_instance.isSchemaValid('http://www.example.com/schemas/ipo.xsd') = 0
    THEN raise_application_error(-20500, 'Invalid Instance');
    ELSE DBMS_OUTPUT.put_line('Instance is valid');
    END IF;
END;
/
Instance is valid
```

PL/SQL procedure successfully completed.

Example 7-11 Validating XML Using Method `SCHEMAVALIDATE()` within Triggers

```
DROP TABLE po_tab;
CREATE TABLE po_tab OF XMLType
    XMLSCHEMA "http://www.example.com/schemas/ipo.xsd" ELEMENT "purchaseOrder";

CREATE TRIGGER emp_trig BEFORE INSERT OR UPDATE ON po_tab FOR EACH ROW

DECLARE
    newxml XMLType;
BEGIN
    newxml := :new.OBJECT_VALUE;
    XMLTYPE.schemaValidate(newxml);
END;
/
```

Example 7-12 Checking XML Validity Using `XMLISVALID` Within CHECK Constraints

```
DROP TABLE po_tab;
CREATE TABLE po_tab OF XMLType
```

```
(CHECK(XMLIsValid(OBJECT_VALUE) = 1))  
XMLSCHEMA "http://www.example.com/schemas/ipo.xsd" ELEMENT "purchaseOrder";
```

Part III

Relational Data To and From XML Data

There are various ways that you can view existing relational data as XML data.

- [Generation of XML Data from Relational Data](#) (page 8-1)
- [Relational Views over XML Data](#) (page 9-1)
- [XMLType Views](#) (page 10-1)

Generation of XML Data from Relational Data

Oracle XML DB provides features for generating (constructing) XML data from relational data in the database. There are both SQL/XML standard functions and Oracle-specific functions and packages for generating XML data from relational content.

- [Overview of Generating XML Data](#) (page 8-1)
- [Generation of XML Data Using SQL Functions](#) (page 8-2)
- [Generation of XML Data Using DBMS_XMLGEN](#) (page 8-21)
- [SYS_XMLAGG Oracle SQL Function](#) (page 8-46)
- [Ordering Query Results Before Aggregating, Using XMLAGG ORDER BY Clause](#) (page 8-46)
- [Returning a Rowset Using XMLTABLE](#) (page 8-47)

See Also:

[XQuery and Oracle XML DB](#) (page 4-1) for information about constructing XML data using SQL/XML functions `XMLQuery` and `XMLTable`

8.1 Overview of Generating XML Data

You can generate XML data using Oracle XML DB using standard SQL/XML functions, Oracle-specific SQL functions, PL/SQL subprograms from package `DBMS_XMLGEN`, or `DBURITYPE`.

- Use standard SQL/XML functions. See [Generation of XML Data Using SQL Functions](#) (page 8-2).
- Use Oracle SQL functions. See the following sections:
 - [XMLCOLATTVAL Oracle SQL Function](#) (page 8-19)
 - [XMLCDATA Oracle SQL Function](#) (page 8-20)
 - [SYS_XMLAGG Oracle SQL Function](#) (page 8-46). This operates on groups of rows, aggregating several XML documents into one.
- Use PL/SQL package `DBMS_XMLGEN`. See [Generation of XML Data Using DBMS_XMLGEN](#) (page 8-21).

- Use a `DBURITYPE` instance to construct XML documents from database data. See [Data Access Using URIs](#) (page 32-1).

See Also:

- [Overview of How To Use Oracle XML DB](#) (page 3-1)
 - [Transformation and Validation of XMLType Data](#) (page 7-1)
 - [PL/SQL APIs for XMLType](#) (page 11-1)
 - [Java DOM API for XMLType](#) (page 13-1)
-

8.2 Generation of XML Data Using SQL Functions

Oracle XML DB provides SQL functions that you can use to construct XML data. Most of these belong to the SQL/XML standard.

- [XMLELEMENT and XMLATTRIBUTES SQL/XML Functions](#) (page 8-3)
- [XMLFOREST SQL/XML Function](#) (page 8-9)
- [XMLCONCAT SQL/XML Function](#) (page 8-11)
- [XMLAGG SQL/XML Function](#) (page 8-12)
- [XMLPI SQL/XML Function](#) (page 8-15)
- [XMLCOMMENT SQL/XML Function](#) (page 8-16)
- [XMLSERIALIZE SQL/XML Function](#) (page 8-17)
- [XMLPARSE SQL/XML Function](#) (page 8-18)

The standard XML-generation functions are also known as SQL/XML **publishing** or **generation** functions.

The use of SQL/XML function `XMLQuery` is not limited to generating (publishing) XML data. Function `XMLQuery` is very general and is referred to in this book as a SQL/XML **query and update** function.

The following XML-generating SQL functions are Oracle-specific (not part of the SQL/XML standard):

- [XMLCOLATTVAL Oracle SQL Function](#) (page 8-19).
- [XMLCDATA Oracle SQL Function](#) (page 8-20).
- [SYS_XMLAGG Oracle SQL Function](#) (page 8-46). This operates on groups of relational rows, aggregating several XML documents into one.

All of the XML-generation SQL functions convert scalars and user-defined data-type instances to their canonical XML format. In this canonical mapping, user-defined data-type attributes are mapped to XML elements.

See Also:

- [XQuery and Oracle XML DB](#) (page 4-1) for information about constructing XML data using SQL/XML function `XMLQuery`
- *Oracle Database SQL Language Reference* for information about Oracle support for the SQL/XML standard

8.2.1 XMLELEMENT and XMLATTRIBUTES SQL/XML Functions

SQL/XML standard function `XMLElement` constructs XML elements from relational data. SQL/XML standard function `XMLAttributes` can be used together with `XMLElement`, to specify attributes for the generated elements.

SQL/XML standard function `XMLElement` takes as arguments an XML element name, an optional collection of attributes for the element, and zero or more additional arguments that make up the element content. It returns an `XMLType` instance.

Figure 8-1 *XMLELEMENT Syntax*

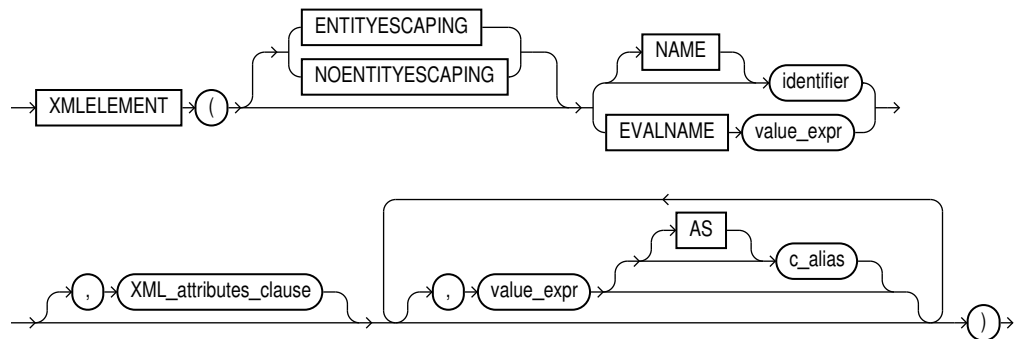

For an explanation of keywords `ENTITYESCAPING` and `NOENTITYESCAPING`, see [Escape of Characters in Generated XML Data](#) (page 8-5). These keywords are Oracle extensions to standard SQL/XML functions `XMLElement` and `XMLAttributes`.

The first argument to function `XMLElement` defines an identifier that names the *root* XML element to be created. The root-element identifier argument can be defined using a literal identifier (*identifier*, in [Figure 8-1](#) (page 8-3)) or by `EVALNAME` followed by an expression (*value_expr*) that evaluates to an identifier. However it is defined, the identifier must not be `NULL` or else an error is raised. The possibility of using `EVALNAME` is an Oracle extension to standard SQL/XML function `XMLElement`.

The optional *XML-attributes-clause* argument of function `XMLElement` specifies the attributes of the root element to be generated. [Figure 8-2](#) (page 8-4) shows the syntax of this argument.

In addition to the optional *XML-attributes-clause* argument, function `XMLElement` accepts zero or more *value_expr* arguments that make up the *content* of the root element (child elements and text content). If an *XML-attributes-clause* argument is also present then these content arguments must follow the *XML-attributes-clause* argument. Each of the content-argument expressions is evaluated, and the result is converted to XML format. If a value argument evaluates to `NULL`, then no content is created for that argument.

Note:

The AS preceding an alias (*c_alias*) is required by the SQL/XML standard, but is optional for Oracle.

The optional *XML-attributes-clause* argument uses SQL/XML standard function XMLAttributes to specify the *attributes* of the root element. Function XMLAttributes can be used *only* in a call to function XMLElement. It cannot be used on its own.

Figure 8-2 XMLAttributes Clause Syntax (XMLATTRIBUTES)

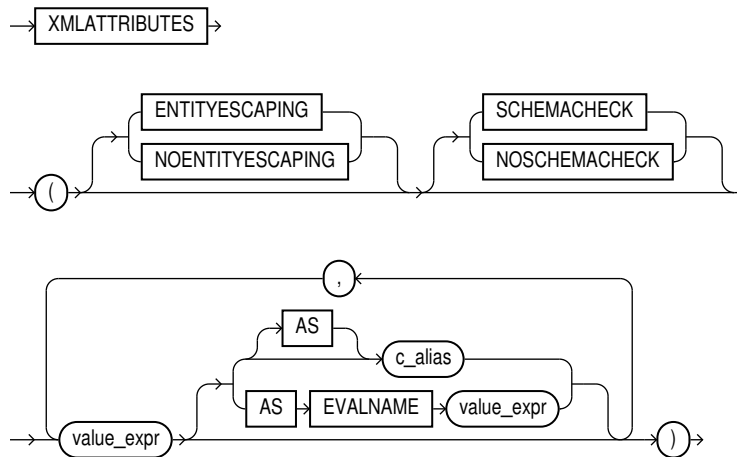

For an explanation of keywords ENTITYESCAPING and NOENTITYESCAPING, see [Escape of Characters in Generated XML Data](#) (page 8-5). These keywords are Oracle extensions to standard SQL/XML functions XMLElement and XMLAttributes.

Keywords SCHEMACHECK and NOSCHEMACHECK determine whether or not a run-time check is made of the generated attributes, to see if any of them specify a schema location that corresponds to an XML schema that is registered with Oracle XML DB, and, if so, to try to generate XML schema-based XML data accordingly. The default behavior is that provided by NOSCHEMACHECK: no check is made. In releases prior to 12c Release 1 (12.1), the default behavior is to perform the check. Keyword SCHEMACHECK can be used to obtain backward compatibility.

A similar check is *always* made at *compile* time, regardless of the presence or absence of NOSCHEMACHECK. This means, in particular, that if you use a string literal to specify an XML schema location attribute value, then a (compile-time) check is made, and, if appropriate, XML schema-based data is generated accordingly.

Keywords SCHEMACHECK and NOSCHEMACHECK are Oracle extensions to standard SQL/XML function XMLAttributes.

Note:

If a view is created to generate XML data, function XMLAttributes is used to add XML-schema location references, and the target XML schema has not yet been registered with Oracle XML DB, then the XML data that is generated is not XML schema-based. If the XML schema is subsequently registered, then XML data that is generated thereafter is also *not* XML-schema-based. To create XML schema-based data, you must recompile the view.

Argument *XML-attributes-clause* itself contains one or more *value_expr* expressions as arguments to function `XMLAttributes`. These are evaluated to obtain the values for the attributes of the root element. (Do not confuse these *value_expr* arguments to function `XMLAttributes` with the *value_expr* arguments to function `XMLElement`, which specify the content of the root element.) The optional `AS c_alias` clause for each *value_expr* specifies that the attribute name is *c_alias*, which can be either a string literal or `EVALNAME` followed by an expression that evaluates to a string literal.

Note:

The following are Oracle extensions to the standard SQL/XML syntax:

- The possibility of using `EVALNAME`.
 - The fact that `AS` preceding an alias (*c_alias*) is optional.
-
-

If an attribute value expression evaluates to `NULL`, then no corresponding attribute is created. The data type of an attribute value expression cannot be an object type or a collection.

8.2.1.1 Escape of Characters in Generated XML Data

As specified by the SQL/XML standard, characters in explicit *identifiers* are *not* escaped in any way – it is up to you to ensure that valid XML names are used. This applies to all SQL/XML functions.

In particular, it applies to the root-element identifier of `XMLElement` (*identifier*, in [Figure 8-1](#) (page 8-3)) and to attribute identifier aliases named with `AS` clauses of `XMLAttributes` (see [Figure 8-2](#) (page 8-4)).

However, other XML data that is generated is *escaped*, by default, to ensure that only valid XML `NameChar` characters are generated. As part of generating a valid XML element or attribute name from a SQL identifier, each character that is disallowed in an XML name is replaced with an underscore character (`_`), followed by the hexadecimal Unicode representation of the original character, followed by a second underscore character. For example, the colon character (`:`) is escaped by replacing it with `_003A_`, where `003A` is the hexadecimal Unicode representation.

Escaping applies to characters in the evaluated *value_expr* arguments to *all* SQL/XML functions, including `XMLElement` and `XMLAttributes`. It applies also to the characters of an attribute identifier that is defined implicitly from an `XMLAttributes` attribute value expression that is *not* followed by an `AS` clause: the escaped form of the SQL column name is used as the name of the attribute.

In some cases, you might not need or want character escaping. If you know, for example, that the XML data being generated is well-formed, then you can save some processing time by inhibiting escaping. You can do that by specifying the keyword `NOENTITYESCAPING` for SQL/XML functions `XMLElement` and `XMLAttributes`. Keyword `ENTITYESCAPING` imposes escaping, which is the default behavior. Keywords `NOENTITYESCAPING` and `ENTITYESCAPING` are Oracle extensions to standard SQL/XML functions `XMLElement` and `XMLAttributes`.

8.2.1.2 Formatting of XML Dates and Timestamps

The XML Schema standard specifies that dates and timestamps in XML data be in standard formats. XML generation functions in Oracle XML DB produce XML dates and timestamps according to this standard.

In releases prior to Oracle Database 10g Release 2, the database settings for date and timestamp formats, not the XML Schema standard formats, were used for XML. You can reproduce this *previous* behavior by setting the database event 19119, level 0x8, as follows:

```
ALTER SESSION SET EVENTS '19119 TRACE NAME CONTEXT FOREVER, LEVEL 0x8';
```

If you must otherwise produce a non-standard XML date or timestamp, use SQL function `to_char` – see [Example 8-1](#) (page 8-7).

See Also:

<http://www.w3.org/TR/2004/REC-xmlschema-2-20041028/datatypes.html#isoformats> for the XML Schema specification of XML date and timestamp formats

8.2.1.3 XML Element Examples

Examples here illustrate the use SQL/XML function `XML Element`.

[Example 8-1](#) (page 8-7) uses `XML Element` to generate an XML date with a format that is different from the XML Schema standard date format.

[Example 8-2](#) (page 8-7) uses `XML Element` to generate an `Emp` element for each employee, with the employee name as the content.

[Example 8-3](#) (page 8-7) uses `XML Element` to generate an `Emp` element for each employee, with child elements that provide the employee name and hire date.

[Example 8-4](#) (page 8-8) uses `XML Element` to generate an `Emp` element for each employee, with attributes `id` and `name`.

As mentioned in [Escape of Characters in Generated XML Data](#) (page 8-5), characters in the root-element name and the names of any attributes defined by `AS` clauses are *not* escaped. Characters in an identifier name are escaped only if the name is created from an evaluated expression (such as a column reference).

[Example 8-5](#) (page 8-8) shows that, with XML data constructed using `XML Element`, the root-element name and the attribute name are *not* escaped. Invalid XML is produced because greater-than sign (`>`) and a comma (`,`) are not allowed in XML element and attribute names.

A full description of character escaping is included in the SQL/XML standard.

[Example 8-6](#) (page 8-8) illustrates the use of namespaces to create an XML schema-based document. Assuming that an XML schema "<http://www.oracle.com/Employee.xsd>" exists and has no target namespace, the query in [Example 8-6](#) (page 8-8) creates an `XMLType` instance conforming to that schema:

[Example 8-7](#) (page 8-9) uses `XML Element` to generate an XML document with employee and department information, using data from sample database schema table `hr.departments`.

Example 8-1 XMLELEMENT: Formatting a Date

```
-- With standard XML date format:
SELECT XMLElement("Date", hire_date)
   FROM hr.employees
   WHERE employee_id = 203;

XMLELEMENT("DATE",HIRE_DATE)
-----
<Date>2002-06-07</Date>

1 row selected.

-- With an alternative date format:
SELECT XMLElement("Date", to_char(hire_date))
   FROM hr.employees
   WHERE employee_id = 203;

XMLELEMENT("DATE",TO_CHAR(HIRE_DATE))
-----
<Date>07-JUN-02</Date>

1 row selected.
```

Example 8-2 XMLELEMENT: Generating an Element for Each Employee

```
SELECT e.employee_id,
       XMLELEMENT ("Emp", e.first_name || ' ' || e.last_name) AS "RESULT"
   FROM hr.employees e
   WHERE employee_id > 200;
```

This query produces the following typical result:

```
EMPLOYEE_ID RESULT
-----
201 <Emp>Michael Hartstein</Emp>
202 <Emp>Pat Fay</Emp>
203 <Emp>Susan Mavris</Emp>
204 <Emp>Hermann Baer</Emp>
205 <Emp>Shelley Higgins</Emp>
206 <Emp>William Gietz</Emp>

6 rows selected.
```

SQL/XML function XMLElement can also be nested, to produce XML data with a nested structure.

Example 8-3 XMLELEMENT: Generating Nested XML

```
SELECT XMLElement("Emp",
                 XMLElement("name", e.first_name || ' ' || e.last_name),
                 XMLElement("hiredate", e.hire_date)) AS "RESULT"
   FROM hr.employees e
   WHERE employee_id > 200;
```

This query produces the following typical XML result:

```
RESULT
-----
<Emp><name>Michael Hartstein</name><hiredate>2004-02-17</hiredate></Emp>
<Emp><name>Pat Fay</name><hiredate>2005-08-17</hiredate></Emp>
<Emp><name>Susan Mavris</name><hiredate>2002-06-07</hiredate></Emp>
<Emp><name>Hermann Baer</name><hiredate>2002-06-07</hiredate></Emp>
```

```
<Emp><name>Shelley Higgins</name><hiredate>2002-06-07</hiredate></Emp>
<Emp><name>William Gietz</name><hiredate>2002-06-07</hiredate></Emp>
```

6 rows selected.

Example 8-4 XMLELEMENT: Generating Employee Elements with Attributes ID and Name

```
SELECT XMLElement("Emp", XMLAttributes(
    e.employee_id as "ID",
    e.first_name || ' ' || e.last_name AS "name"))
    AS "RESULT"
FROM hr.employees e
WHERE employee_id > 200;
```

This query produces the following typical XML result fragment:

```
RESULT
-----
<Emp ID="201" name="Michael Hartstein"></Emp>
<Emp ID="202" name="Pat Fay"></Emp>
<Emp ID="203" name="Susan Mavris"></Emp>
<Emp ID="204" name="Hermann Baer"></Emp>
<Emp ID="205" name="Shelley Higgins"></Emp>
<Emp ID="206" name="William Gietz"></Emp>
```

6 rows selected.

Example 8-5 XMLELEMENT: Characters in Generated XML Data Are Not Escaped

```
SELECT XMLElement("Emp->Special",
    XMLAttributes(e.last_name || ', ' || e.first_name
        AS "Last,First"))
    AS "RESULT"
FROM hr.employees e
WHERE employee_id = 201;
```

This query produces the following result, which is *not* well-formed XML:

```
RESULT
-----
<Emp->Special Last,First="Hartstein, Michael"></Emp->Special>
```

1 row selected.

Example 8-6 Creating a Schema-Based XML Document Using XMLELEMENT with Namespaces

```
SELECT XMLElement("Employee",
    XMLAttributes('http://www.w3.org/2001/XMLSchema' AS
        "xmlns:xsi",
        'http://www.oracle.com/Employee.xsd' AS
        "xsi:nonamespaceSchemaLocation"),
    XMLForest(employee_id, last_name, salary)) AS "RESULT"
FROM hr.employees
WHERE department_id = 10;
```

This creates the following XML document that conforms to XML schema Employee.xsd. (The result is shown here pretty-printed, for clarity.)

```
RESULT
-----
```



```

<Employee xmlns:xsi="http://www.w3.org/2001/XMLSchema"
          xsi:nonamespaceSchemaLocation="http://www.oracle.com/Employee.xsd">
  <EMPLOYEE_ID>200</EMPLOYEE_ID>
  <LAST_NAME>Whalen</LAST_NAME>
  <SALARY>4400</SALARY>
</Employee>

```

1 row selected.

Example 8-7 XMLELEMENT: Generating an Element from a User-Defined Data-Type Instance

```

CREATE OR REPLACE TYPE emp_t AS OBJECT ("@EMPNO" NUMBER(4),
                                       ENAME VARCHAR2(10));

CREATE OR REPLACE TYPE emplist_t AS TABLE OF emp_t;

CREATE OR REPLACE TYPE dept_t AS OBJECT ("@DEPTNO" NUMBER(2),
                                       DNAME VARCHAR2(14),
                                       EMP_LIST emplist_t);

SELECT XMLElement("Department",
                dept_t(department_id,
                      department_name,
                      cast(MULTISET
                          (SELECT employee_id, last_name
                           FROM hr.employees e
                           WHERE e.department_id = d.department_id)
                          AS emplist_t)))
AS deptxml
FROM hr.departments d
WHERE d.department_id = 10;

```

This produces an XML document which contains the Department element and the canonical mapping of type dept_t.

```

DEPTXML
-----
<Department>
  <DEPT_T DEPTNO="10">
    <DNAME>ACCOUNTING</DNAME>
    <EMPLIST>
      <EMP_T EMPNO="7782">
        <ENAME>CLARK</ENAME>
      </EMP_T>
      <EMP_T EMPNO="7839">
        <ENAME>KING</ENAME>
      </EMP_T>
      <EMP_T EMPNO="7934">
        <ENAME>MILLER</ENAME>
      </EMP_T>
    </EMPLIST>
  </DEPT_T>
</Department>

```

1 row selected.

8.2.2 XMLFOREST SQL/XML Function

You use SQL/XML standard function XMLForest to construct a forest of XML elements.

Its arguments are expressions to be evaluated, with optional aliases. [Figure 8-3](#) (page 8-10) describes the XMLForest syntax.

Figure 8-3 XMLFOREST Syntax

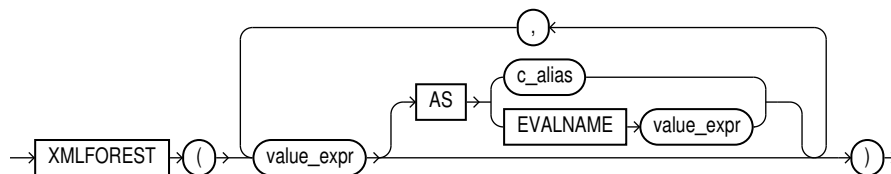

Each of the value expressions (*value_expr* in [Figure 8-3](#) (page 8-10)) is converted to XML format, and, optionally, identifier *c_alias* is used as the attribute identifier (*c_alias* can be a string literal or EVALNAME followed by an expression that evaluates to a string literal). The possibility of using EVALNAME is an Oracle extension to standard SQL/XML function XMLForest.

For an object type or collection, the AS clause is required. For other types, the AS clause is optional. For a given expression, if the AS clause is omitted, then characters in the evaluated value expression are *escaped* to form the name of the enclosing tag of the element. The escaping is as defined in [Escape of Characters in Generated XML Data](#) (page 8-5). If the value expression evaluates to NULL, then no element is created for that expression.

[Example 8-8](#) (page 8-10) uses XMLElement and XMLForest to generate an Emp element for each employee, with a name attribute and with child elements containing the employee hire date and department as the content.

Example 8-8 XMLFOREST: Generating Elements with Attribute and Child Elements

```
SELECT XMLElement("Emp",
                XMLAttributes(e.first_name || ' ' || e.last_name AS "name"),
                XMLForest(e.hire_date, e.department AS "department"))
AS "RESULT"
FROM employees e WHERE e.department_id = 20;
```

(The WHERE clause is used here to keep the example brief.) This query produces the following XML result:

```
RESULT
-----
<Emp name="Michael Hartstein">
  <HIRE_DATE>2004-02-17</HIRE_DATE>
  <department>20</department>
</Emp>
<Emp name="Pat Fay">
  <HIRE_DATE>2005-08-17</HIRE_DATE>
  <department>20</department>
</Emp>

2 rows selected.
```

See Also:

[Example 8-19](#) (page 8-20)

[Example 8-9](#) (page 8-11) uses XMLForest to generate hierarchical XML data from user-defined data-type instances.

Example 8-9 XMLFOREST: Generating an Element from a User-Defined Data-Type Instance

```

SELECT XMLForest(
  dept_t(department_id,
        department_name,
        cast(MULTISET
             (SELECT employee_id, last_name
              FROM hr.employees e WHERE e.department_id = d.department_id)
             AS emplist_t))
        AS "Department")
  AS deptxml
FROM hr.departments d
WHERE department_id=10;

```

This produces an XML document with element `Department` containing attribute `DEPTNO` and child element `DNAME`.

```

DEPTXML
-----
<Department DEPTNO="10">
  <DNAME>Administration</DNAME>
  <EMP_LIST>
    <EMP_T EMPNO="200">
      <ENAME>Whalen</ENAME>
    </EMP_T>
  </EMP_LIST>
</Department>

1 row selected.

```

You might want to compare this example with [Example 8-7](#) (page 8-9) and [Example 8-24](#) (page 8-34).

8.2.3 XMLCONCAT SQL/XML Function

You use SQL/XML standard function `XMLConcat` to construct an XML fragment by concatenating multiple `XMLType` instances.

[Figure 8-4](#) (page 8-11) shows the `XMLConcat` syntax. Function `XMLConcat` has two forms:

- The first form takes as argument an `XMLSequenceType` value, which is a varray of `XMLType` instances, and returns a single `XMLType` instance that is the concatenation of all of the elements of the varray. This form is useful to collapse lists of `XMLType` instances into a single instance.
- The second form takes an arbitrary number of `XMLType` instances and concatenates them together. If one of the values is `NULL`, then it is ignored in the result. If all the values are `NULL`, then the result is `NULL`. This form is used to concatenate arbitrary number of `XMLType` instances in the same row. Function `XMLAgg` can be used to concatenate `XMLType` instances across rows.

Figure 8-4 XMLCONCAT Syntax

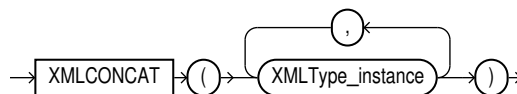

[Example 8-10](#) (page 8-12) uses SQL/XML function `XMLConcat` to return a concatenation of `XMLType` instances from an `XMLSequenceType` value (a varray of `XMLType` instances).

Example 8-10 XMLCONCAT: Concatenating XMLType Instances from a Sequence

```
SELECT XMLSerialize(
    CONTENT
    XMLConcat(XMLSequenceType(
        XMLType('<PartNo>1236</PartNo>'),
        XMLType('<PartName>Widget</PartName>'),
        XMLType('<PartPrice>29.99</PartPrice>'))
    AS CLOB)
    AS "RESULT"
FROM DUAL;
```

This query returns a single XML fragment. (The result is shown here pretty-printed, for clarity.)

```
RESULT
-----
<PartNo>1236</PartNo>
<PartName>Widget</PartName>
<PartPrice>29.99</PartPrice>
```

1 row selected.

[Example 8-11](#) (page 8-12) uses `XMLConcat` to create and concatenate XML elements for employee first and the last names.

Example 8-11 XMLCONCAT: Concatenating XML Elements

```
SELECT XMLConcat(XMLElement("first", e.first_name),
    XMLElement("last", e.last_name))
    AS "RESULT"
FROM employees e;
```

This query produces the following XML fragment:

```
RESULT
-----
<first>Den</first><last>Raphaely</last>
<first>Alexander</first><last>Khoo</last>
<first>Shelli</first><last>Baida</last>
<first>Sigal</first><last>Tobias</last>
<first>Guy</first><last>Himuro</last>
<first>Karen</first><last>Colmenares</last>
```

6 rows selected.

8.2.4 XMLAGG SQL/XML Function

You use SQL/XML standard function `XMLAgg` to construct a forest of XML elements from a collection of XML elements — it is an aggregate function.

[Figure 8-5](#) (page 8-12) describes the `XMLAgg` syntax.

Figure 8-5 XMLAGG Syntax

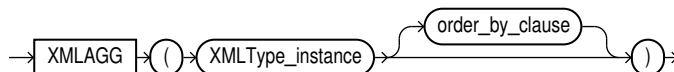

The `order_by_clause` is the following:

```
ORDER BY [list of: expr [ASC|DESC] [NULLS {FIRST|LAST}]]
```

Numeric literals are *not* interpreted as column positions. For example, `ORDER BY 1` does not mean order by the first column. Instead, numeric literals are interpreted as any other literals.

As with SQL/XML function `XMLConcat`, any arguments whose value is `NULL` are dropped from the result. SQL/XML function `XMLAgg` is similar to Oracle SQL function `sys_XMLAgg`, but `XMLAgg` returns a forest of nodes and it does not accept an `XMLFormat` parameter.

SQL/XML function `XMLAgg` can be used to concatenate `XMLType` instances across *multiple rows*. It also accepts an optional `ORDER BY` clause, to order the XML values being aggregated. Function `XMLAgg` produces one aggregated XML result for each group. If there is no group by specified in the query, then it returns a single aggregated XML result for all the rows of the query.

[Example 8-12](#) (page 8-13) uses SQL/XML functions `XMLAgg` and `XMLElement` to construct a `Department` element that contains `Employee` elements that have employee job ID and last name as their contents. It also orders the `Employee` elements in the department by employee last name. (The result is shown pretty-printed, for clarity.)

Example 8-12 XMLAGG: Generating a Department Element with Child Employee Elements

```
SELECT XMLElement("Department", XMLAgg(XMLElement("Employee",
                                           e.job_id||' '||e.last_name)
                                       ORDER BY e.last_name))
AS "Dept_list"
FROM hr.employees e
WHERE e.department_id = 30 OR e.department_id = 40;
```

```
Dept_list
-----
<Department>
  <Employee>PU_CLERK Baida</Employee>
  <Employee>PU_CLERK Colmenares</Employee>
  <Employee>PU_CLERK Himuro</Employee>
  <Employee>PU_CLERK Khoo</Employee>
  <Employee>HR_REP Mavris</Employee>
  <Employee>PU_MAN Raphaely</Employee>
  <Employee>PU_CLERK Tobias</Employee>
</Department>
```

1 row selected.

The result is a *single* row, because `XMLAgg` aggregates the employee rows.

[Example 8-13](#) (page 8-13) shows how to use the `GROUP BY` clause to group the returned set of rows into multiple groups, forming multiple `Department` elements. (The result is shown here pretty-printed, for clarity.)

Example 8-13 XMLAGG: Using GROUP BY to Generate Multiple Department Elements

```
SELECT XMLElement("Department", XMLAttributes(department_id AS "deptno"),
           XMLAgg(XMLElement("Employee", e.job_id||' '||e.last_name)))
AS "Dept_list"
FROM hr.employees e
```

```

GROUP BY e.department_id;

Dept_list
-----
<Department deptno="30">
  <Employee>PU_MAN Raphaely</Employee>
  <Employee>PU_CLERK Colmenares</Employee>
  <Employee>PU_CLERK Himuro</Employee>
  <Employee>PU_CLERK Tobias</Employee>
  <Employee>PU_CLERK Baida</Employee>
  <Employee>PU_CLERK Khoo</Employee></Department>

<Department deptno="40">
  <Employee>HR_REP Mavis</Employee>
</Department>

2 rows selected.

```

You can order the employees within each department by using the `ORDER BY` clause inside the `XMLAgg` expression.

Note:

Within the `ORDER BY` clause, Oracle Database does not interpret number literals as column positions, as it does in other uses of this clause.

Function `XMLAgg` can be used to reflect the hierarchical nature of some relationships that exist in tables. [Example 8-14](#) (page 8-14) generates a department element for department 30. Within this element is a child element `emp` for each employee of the department. Within each employee element is a dependent element for each dependent of that employee.

Example 8-14 XMLAGG: Generating Nested Elements

```
SELECT last_name, employee_id FROM employees WHERE department_id = 30;
```

LAST_NAME	EMPLOYEE_ID
Raphaely	114
Khoo	115
Baida	116
Tobias	117
Himuro	118
Colmenares	119

6 rows selected.

A `dependents` table holds the dependents of each employee.

```
CREATE TABLE hr.dependents (id NUMBER(4) PRIMARY KEY,
                             employee_id NUMBER(4),
                             name VARCHAR2(10));
```

```

Table created.
INSERT INTO dependents VALUES (1, 114, 'MARK');
1 row created.
INSERT INTO dependents VALUES (2, 114, 'JACK');
1 row created.
INSERT INTO dependents VALUES (3, 115, 'JANE');
```

```

1 row created.
INSERT INTO dependents VALUES (4, 116, 'HELEN');
1 row created.
INSERT INTO dependents VALUES (5, 116, 'FRANK');
1 row created.
COMMIT;
Commit complete.

```

The following query generates the XML data for a department that contains the information about dependents. (The result is shown here pretty-printed, for clarity.)

```

SELECT
  XMLElement(
    "Department",
    XMLAttributes(d.department_name AS "name"),
    (SELECT
      XMLAgg(XMLElement("emp",
        XMLAttributes(e.last_name AS name),
        (SELECT XMLAgg(XMLElement("dependent",
          XMLAttributes(de.name AS "name")))
        FROM dependents de
        WHERE de.employee_id = e.employee_id)))
      FROM employees e
      WHERE e.department_id = d.department_id) AS "dept_list"
    FROM departments d
    WHERE department_id = 30;

```

```

dept_list
-----
<Department name="Purchasing">
  <emp NAME="Raphaely">
    <dependent name="MARK"></dependent>
    <dependent name="JACK"></dependent>
  </emp><emp NAME="Khoo">
    <dependent name="JANE"></dependent>
  </emp>
  <emp NAME="Baida">
    <dependent name="HELEN"></dependent>
    <dependent name="FRANK"></dependent>
  </emp><emp NAME="Tobias"></emp>
  <emp NAME="Himuro"></emp>
  <emp NAME="Colmenares"></emp>
</Department>

1 row selected.

```

8.2.5 XMLPI SQL/XML Function

You use SQL/XML standard function XMLPI to construct an XML processing instruction (PI).

Figure 8-6 (page 8-15) shows the syntax:

Figure 8-6 XMLPI Syntax

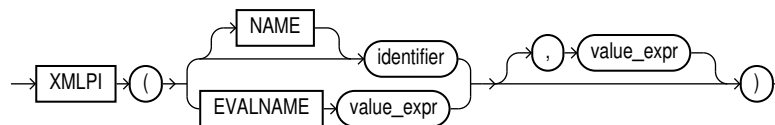

Argument *value_expr* is evaluated, and the string result is appended to the optional identifier (*identifier*), separated by a space. This concatenation is then enclosed between "<?" and "?>" to create the processing instruction. That is, if *string-result* is the result of evaluating *value_expr*, then the generated processing instruction is <?*identifier* *string-result*?>. If *string-result* is the empty string, '', then the function returns <?*identifier*?>.

As an alternative to using keyword NAME followed by a *literal* string *identifier*, you can use keyword EVALNAME followed by an expression that evaluates to a string to be used as the identifier. The possibility of using EVALNAME is an Oracle extension to standard SQL/XML function XMLPI.

An error is raised if the constructed XML is not a legal XML processing instruction. In particular:

- *identifier* must *not* be the word "xml" (uppercase, lowercase, or mixed case).
- *string-result* must *not* contain the character sequence ">".

Function XMLPI returns an instance of XMLType. If *string-result* is NULL, then it returns NULL.

[Example 8-15](#) (page 8-16) uses XMLPI to generate a simple processing instruction.

Example 8-15 Using SQL/XML Function XMLPI

```
SELECT XMLPI(NAME "OrderAnalysisComp", 'imported, reconfigured, disassembled')
  AS pi FROM DUAL;
```

This results in the following output:

```
PI
-----
<?OrderAnalysisComp imported, reconfigured, disassembled?>

1 row selected.
```

8.2.6 XMLCOMMENT SQL/XML Function

You use SQL/XML standard function XMLComment to construct an XML comment.

[Figure 8-7](#) (page 8-16) shows the syntax:

Figure 8-7 XMLComment Syntax

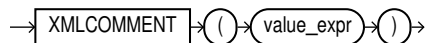

Argument *value_expr* is evaluated to a string, and the result is used as the body of the generated XML comment. The result is thus <!--*string-result*-->, where *string-result* is the string result of evaluating *value_expr*. If *string-result* is the empty string, then the comment is empty: <!-->.

An error is raised if the constructed XML is not a legal XML comment. In particular, *string-result* must *not* contain two consecutive hyphens (-): "--".

Function XMLComment returns an instance of XMLType. If *string-result* is NULL, then the function returns NULL.

[Example 8-16](#) (page 8-16) uses XMLComment to generate a simple XML comment.

Example 8-16 Using SQL/XML Function XMLCOMMENT

```
SELECT XMLComment('This is a comment') AS cmnt FROM DUAL;
```

This query results in the following output:

```
CMNT
-----
<!--This is a comment-->
```

8.2.7 XMLSERIALIZE SQL/XML Function

You use SQL/XML standard function XMLSerialize to obtain a string or LOB representation of XML data.

Figure 8-8 (page 8-17) shows the syntax of XMLSerialize:

Figure 8-8 XMLSerialize Syntax

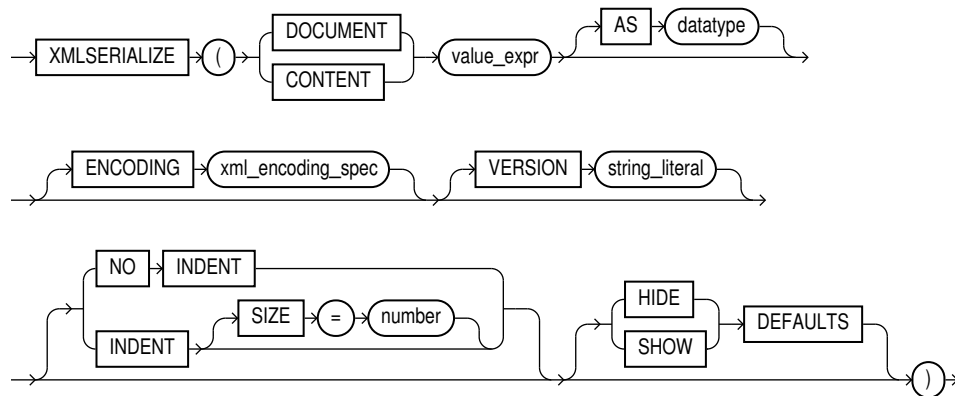

Argument *value_expr* is evaluated, and the resulting XMLType instance is serialized to produce the content of the created string or LOB. If present¹¹, the specified *datatype* must be one of the following (the default data type is CLOB):

- VARCHAR2 (N), where N is the size in bytes²²
- CLOB
- BLOB

If you specify DOCUMENT, then the result of evaluating *value_expr* must be a well-formed document. In particular, it must have a single root. If the result is not a well-formed document, then an error is raised. If you specify CONTENT, however, then the result of *value_expr* is *not* checked for being well-formed.

If *value_expr* evaluates to NULL or to the empty string (' '), then function XMLSerialize returns NULL.

The ENCODING clause specifies the character encoding for XML data that is serialized as a BLOB instance. *xml_encoding_spec* is an XML encoding declaration (encoding= " . . . "). If *datatype* is BLOB and you specify an ENCODING clause, then the output is encoded as specified, and *xml_encoding_spec* is added to the prolog to indicate the BLOB encoding. If you specify an ENCODING clause with a *datatype* other than BLOB, then an error is raised. For UTF-16 characters, *xml_encoding_spec* must be one of the following:

- encoding=UTF-16BE – Big-endian UTF-16 encoding

¹¹ The SQL/XML standard requires argument *data-type* to be present, but it is *optional* in the Oracle XML DB implementation of the standard, for ease of use.

²² The limit is 32767 or 4000 bytes, depending on the value of initialization parameter MAX_STRING_SIZE. See *Oracle Database PL/SQL Packages and Types Reference*.

- encoding=UTF-16LE – Little-endian UTF-16 encoding

If you specify VERSION then the specified version is used in the XML declaration (<?xml version="..." ...?>).

If you specify NO INDENT, then all insignificant whitespace is stripped, so that it does not appear in the output. If you specify INDENT SIZE = N, where N is a whole number, then the output is *pretty-printed* using a relative indentation of N spaces. If N is 0, then pretty-printing inserts a newline character after each element, placing each element on a line by itself, but there is no other insignificant whitespace in the output. If you specify INDENT without a SIZE specification, then 2-space indenting is used. If you specify neither NO INDENT nor INDENT, then the behavior (pretty-printing or not) is indeterminate.

HIDE DEFAULTS and SHOW DEFAULTS apply only to XML schema-based data. If you specify SHOW DEFAULTS and the input data is missing any optional elements or attributes for which the XML schema defines default values, then those elements or attributes are included in the output with their default values. If you specify HIDE DEFAULTS, then no such elements or attributes are included in the output. HIDE DEFAULTS is the default behavior.

Example 8-17 (page 8-18) uses XMLSerialize to produce a CLOB instance containing serialized XML data.

Example 8-17 Using SQL/XML Function XMLSERIALIZE

```
SELECT XMLSerialize(DOCUMENT XMLType('<poid>143598</poid>') AS CLOB)
       AS xmlserialize_doc FROM DUAL;
```

This results in the following output:

```
XMLSERIALIZE_DOC
-----
<poid>143598</poid>
```

8.2.8 XMLPARSE SQL/XML Function

You use SQL/XML standard function XMLParse to parse a string containing XML data and construct a corresponding XMLType instance.

Figure 8-9 (page 8-18) shows the syntax:

Figure 8-9 XMLParse Syntax

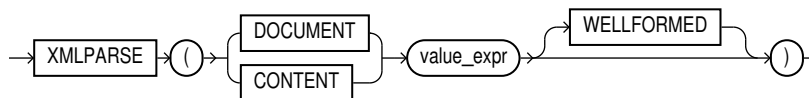

Argument *value_expr* is evaluated to produce the string that is parsed. If you specify DOCUMENT, then *value_expr* must correspond to a *singly rooted*, well-formed XML document. If you specify CONTENT, then *value_expr* need only correspond to a well-formed XML fragment (it need not be singly rooted).

Keyword WELLFORMED is an Oracle XML DB extension to the SQL/XML standard. When you specify WELLFORMED, you are informing the parser that argument *value_expr* is well-formed, so Oracle XML DB does *not* check to ensure that it is well-formed.

Function XMLParse returns an instance of XMLType. If *value_expr* evaluates to NULL, then the function returns NULL.

[Example 8-18](#) (page 8-19) uses `XMLParse` to parse a string of XML code and produce an `XMLType` instance.

Example 8-18 Using SQL/XML Function XMLPARSE

```
SELECT XMLParse(CONTENT
               '124 <purchaseOrder poNo="12435">
                 <customerName> Acme Enterprises</customerName>
                 <itemNo>32987457</itemNo>
                 </purchaseOrder>'
               WELLFORMED)
AS po FROM DUAL d;
```

This results in the following output:

```
PO
-----
124 <purchaseOrder poNo="12435">
<customerName>Acme Enterprises</customerName>
<itemNo>32987457</itemNo>
</purchaseOrder>
```

See Also:

<http://www.w3.org/TR/REC-xml/>, *Extensible Markup Language (XML) 1.0*, for the definition of well-formed XML documents and fragments

8.2.9 XMLCOLATTVAL Oracle SQL Function

Oracle SQL function `XMLColAttVal` generates a forest of XML `column` elements containing the values of the arguments passed in. This function is an Oracle extension to the SQL/XML ANSI-ISO standard functions.

[Figure 8-10](#) (page 8-19) shows the `XMLColAttVal` syntax.

Figure 8-10 XMLCOLATTVAL Syntax

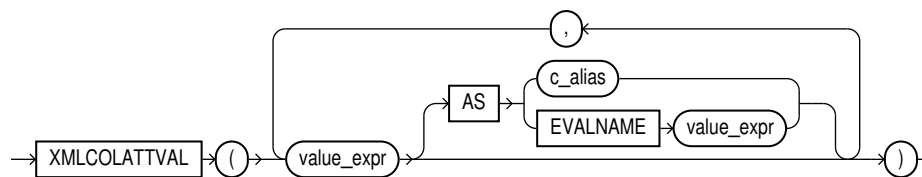

The arguments are used as the values of the name attribute of the `column` element. The `c_alias` values are used as the attribute identifiers.

As an alternative to using keyword `AS` followed by a *literal* string `c_alias`, you can use `AS EVALNAME` followed by an expression that evaluates to a string to be used as the attribute identifier.

Because argument values `value_expr` are used only as attribute *values*, they need *not* be escaped in any way. This is in contrast to function `XMLForest`. It means that you can use `XMLColAttVal` to transport SQL columns and values without escaping.

[Example 8-19](#) (page 8-20) uses `XMLColAttVal` to generate an `Emp` element for each employee, with a name attribute, and with `column` elements that have the employee hire date and department as the content.

Example 8-19 XMLCOLATTVAL: Generating Elements with Attribute and Child Elements

```
SELECT XMLElement("Emp",
                XMLAttributes(e.first_name || ' ' || e.last_name AS "fullname" ),
                XMLColAttVal(e.hire_date, e.department_id AS "department"))
AS "RESULT"
FROM hr.employees e
WHERE e.department_id = 30;
```

This query produces the following XML result. (The result is shown here pretty-printed, for clarity.)

```
RESULT
-----
<Emp fullname="Den Raphaely">
  <column name = "HIRE_DATE">2002-12-07</column>
  <column name = "department">30</column>
</Emp>
<Emp fullname="Alexander Khoo">
  <column name = "HIRE_DATE">2003-05-18</column>
  <column name = "department">30</column>
</Emp>
<Emp fullname="Shelli Baida">
  <column name = "HIRE_DATE">2005-12-24</column>
  <column name = "department">30</column>
</Emp>
<Emp fullname="Sigal Tobias">
  <column name = "HIRE_DATE">2005-07-24</column>
  <column name = "department">30</column>
</Emp>
<Emp fullname="Guy Himuro">
  <column name = "HIRE_DATE">2006-11-15</column>
  <column name = "department">30</column>
</Emp>
<Emp fullname="Karen Colmenares">
  <column name = "HIRE_DATE">2007-08-10</column>
  <column name = "department">30</column>
</Emp>

6 rows selected.
```

See Also:

[Example 8-8](#) (page 8-10)

8.2.10 XMLCDATA Oracle SQL Function

You use Oracle SQL function XMLCDATA to generate an XML CDATA section.

[Figure 8-11](#) (page 8-20) shows the syntax:

Figure 8-11 XMLCDATA Syntax

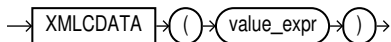

Argument *value_expr* is evaluated to a string, and the result is used as the body of the generated XML CDATA section, <![CDATA[*string-result*]]>, where *string-*

result is the result of evaluating *value_expr*. If *string-result* is the empty string, then the CDATA section is empty: `<![CDATA[]]>`.

An error is raised if the constructed XML is not a legal XML CDATA section. In particular, *string-result* must *not* contain two consecutive right brackets (}): `"]]`.

Function XMLCDATA returns an instance of XMLType. If *string-result* is NULL, then the function returns NULL.

[Example 8-20](#) (page 8-21) uses XMLCDATA to generate an XML CDATA section.

Example 8-20 Using Oracle SQL Function XMLCDATA

```
SELECT XMLElement("PurchaseOrder",
                XMLElement("Address",
                            XMLCDATA('100 Pennsylvania Ave.'),
                            XMLElement("City", 'Washington, D.C.')))
AS RESULT FROM DUAL;
```

This results in the following output. (The result is shown here pretty-printed, for clarity.)

```
RESULT
-----
<PurchaseOrder>
  <Address>
    <![CDATA[100 Pennsylvania Ave.]]>
    <City>Washington, D.C.</City>
  </Address>
</PurchaseOrder>
```

8.3 Generation of XML Data Using DBMS_XMLGEN

PL/SQL package DBMS_XMLGEN creates XML documents from SQL query results. It retrieves an XML document as a CLOB or XMLType value.

It provides a *fetch* interface, whereby you can specify the maximum number of rows to retrieve and the number of rows to skip. For example, the first fetch could retrieve a maximum of ten rows, skipping the first four. This is especially useful for pagination requirements in Web applications.

Package DBMS_XMLGEN also provides options for changing tag names for ROW, ROWSET, and so on. The parameters of the package can restrict the number of rows retrieved and the enclosing tag names.

See Also:

- *Oracle Database PL/SQL Packages and Types Reference*
 - *Oracle XML Developer's Kit Programmer's Guide* (compare OracleXMLQuery with DBMS_XMLGEN)
-

8.3.1 Using PL/SQL Package DBMS_XMLGEN

You can use package DBMS_XMLGEN to generate XML data from relational data.

[Figure 8-12](#) (page 8-22) illustrates how to use package DBMS_XMLGEN. The steps are as follows:

1. Get the context from the package by supplying a SQL query and calling PL/SQL function `newContext`.
2. Pass the context to all procedures or functions in the package to set the various options. For example, to set the ROW element name, use `setRowTag(ctx)`, where `ctx` is the context got from the previous `newContext` call.
3. Get the XML result, using PL/SQL function `getXML` or `getXMLType`. By setting the maximum number of rows to be retrieved for each fetch using PL/SQL procedure `setMaxRows`, you can call either of these functions repeatedly, retrieving up to the maximum number of rows for each call. These functions return XML data (as a CLOB value and as an instance of `XMLType`, respectively), unless there are no rows retrieved. In that case, these functions return NULL. To determine how many rows were retrieved, use PL/SQL function `getNumRowsProcessed`.
4. You can reset the query to start again and repeat step 3.
5. Call PL/SQL procedure `closeContext` to free up any previously allocated resources.

Figure 8-12 Using PL/SQL Package DBMS_XMLGEN

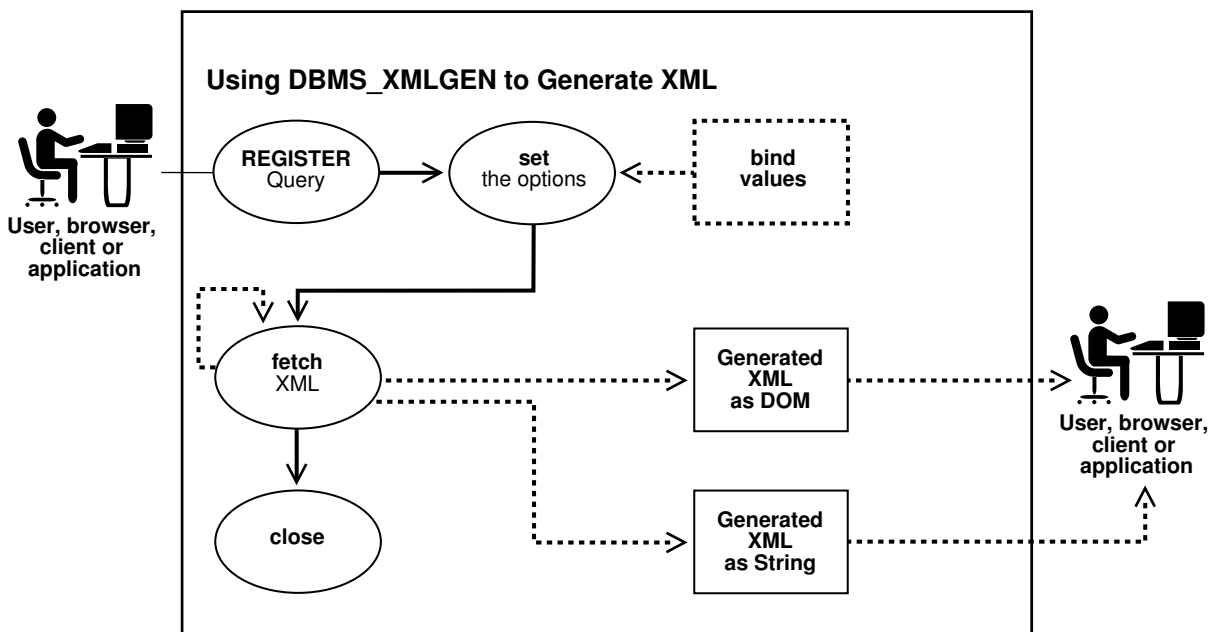

In conjunction with a SQL query, PL/SQL method `DBMS_XMLGEN.getXML()` typically returns a result similar to the following, as a CLOB value:

```
<?xml version="1.0"?>
<ROWSET>
  <ROW>
    <EMPLOYEE_ID>100</EMPLOYEE_ID>
    <FIRST_NAME>Steven</FIRST_NAME>
    <LAST_NAME>King</LAST_NAME>
    <EMAIL>SKING</EMAIL>
    <PHONE_NUMBER>515.123.4567</PHONE_NUMBER>
    <HIRE_DATE>17-JUN-87</HIRE_DATE>
```

```

<JOB_ID>AD_PRES</JOB_ID>
<SALARY>24000</SALARY>
<DEPARTMENT_ID>90</DEPARTMENT_ID>
</ROW>
<ROW>
<EMPLOYEE_ID>101</EMPLOYEE_ID>
<FIRST_NAME>Neena</FIRST_NAME>
<LAST_NAME>Kochhar</LAST_NAME>
<EMAIL>NKOCHHAR</EMAIL>
<PHONE_NUMBER>515.123.4568</PHONE_NUMBER>
<HIRE_DATE>21-SEP-89</HIRE_DATE>
<JOB_ID>AD_VP</JOB_ID>
<SALARY>17000</SALARY>
<MANAGER_ID>100</MANAGER_ID>
<DEPARTMENT_ID>90</DEPARTMENT_ID>
</ROW>
</ROWSET>

```

The default mapping between relational data and XML data is as follows:

- Each row returned by the SQL query maps to an XML element with the default element name ROW.
- Each column returned by the SQL query maps to a child element of the ROW element.
- The entire result is wrapped in a ROWSET element.
- Binary data is transformed to its hexadecimal representation.

Element names ROW and ROWSET can be replaced with names you choose, using DBMS_XMLGEN procedures `setRowTagName` and `setRowSetTagName`, respectively.

The CLOB value returned by `getXML` has the same encoding as the database character set. If the database character set is SHIFTJIS, then the XML document returned is also SHIFTJIS.

8.3.2 Functions and Procedures of Package DBMS_XMLGEN

PL/SQL package DBMS_XMLGEN provides functions and procedures for generating XML data from relational data.

[Table 8-1](#) (page 8-23) describes the functions and procedures of package DBMS_XMLGEN.

Table 8-1 DBMS_XMLGEN Functions and Procedures

Function or Procedure	Description
SUBTYPE ctxHandle IS NUMBER	<p>The context handle used by all functions.</p> <p>Document Type Definition (DTD) or schema specifications:</p> <p>NONE CONSTANT NUMBER := 0;</p> <p>DTD CONSTANT NUMBER := 1;</p> <p>SCHEMA CONSTANT NUMBER := 2;</p> <p>Can be used in function <code>getXML</code> to specify whether to generate a DTD or XML schema or neither (NONE). Only the NONE specification is supported.</p>

Table 8-1 (Cont.) DBMS_XMLGEN Functions and Procedures

Function or Procedure	Description
newContext()	Given a query string, generate a new context handle to be used in subsequent functions.
newContext(queryString IN VARCHAR2)	Returns a new context <i>Parameter:</i> queryString (IN) - the query string, the result of which must be converted to XML <i>Returns:</i> Context handle. Call this function first to obtain a handle that you can use in the getXML and other functions to get the XML back from the result.
newContext(queryString IN SYS_REFCURSOR) RETURN ctxHandle;	Creates a new context handle from a PL/SQL cursor variable. The context handle can be used for the rest of the functions.
newContextFromHierarchy(queryString IN VARCHAR2) RETURN ctxHandle;	<i>Parameter:</i> queryString (IN) - the query string, the result of which must be converted to XML. The query is a hierarchical query typically formed using a CONNECT BY clause, and the result must have the same property as the result set generated by a CONNECT BY query. The result set must have only two columns, the level number and an XML value. The level number is used to determine the hierarchical position of the XML value within the result XML document. <i>Returns:</i> Context handle. Call this function first to obtain a handle that you can use in the getXML and other functions to get a hierarchical XML with recursive elements back from the result.
setRowTag()	Sets the name of the element separating all the rows. The default name is ROW.
setRowTag(ctx IN ctxHandle, rowTag IN VARCHAR2);	<i>Parameters:</i> ctx (IN) - the context handle obtained from the newContext call. rowTag (IN) - the name of the ROW element. A NULL value for rowTag indicates that you do not want the ROW element to be present. Call this procedure to set the name of the ROW element, if you do not want the default ROW name to show up. You can also set rowTag to NULL to suppress the ROW element itself. However, since function getXML returns complete XML documents, not XML fragments, there must be a (single) root element. Therefore, an error is raised if both the rowTag value and the rowSetTag value (see setRowSetTag, next) are NULL and there is more than one column or row in the output.
setRowSetTag()	Sets the name of the document root element. The default name is ROWSET

Table 8-1 (Cont.) DBMS_XMLGEN Functions and Procedures

Function or Procedure	Description
<pre>setRowSetTag(ctx IN ctxHandle, rowSetTag IN VARCHAR2);</pre>	<p><i>Parameters:</i></p> <p>ctx (IN) – the context handle obtained from the newContext call.</p> <p>rowSetTag (IN) – the name of the document root element to be used in the output. A NULL value for rowSetTag indicates that you do <i>not</i> want the ROWSET element to be present.</p> <p>Call this procedure to set the name of the document root element, if you do not want the default name ROWSET to be used. You can set rowSetTag to NULL to suppress printing of the document root element.</p> <p>However, since function getXML returns complete XML documents, not XML fragments, there must be a (single) root element. Therefore, an error is raised if both the rowTag value and the rowSetTag value (see setRowTag, previous) are NULL and there is more than one column or row in the output, or if the rowSetTag value is NULL and there is more than one row in the output.</p>
<pre>getXML()</pre>	<p>Gets the XML document by fetching the maximum number of rows specified. It appends the XML document to the CLOB passed in.</p>
<pre>getXML(ctx IN ctxHandle, clobval IN OUT NCOPY clob, dtdOrSchema IN number:= NONE);</pre>	<p><i>Parameters:</i></p> <p>ctx (IN) - The context handle obtained from calling newContext.</p> <p>clobval (IN/OUT) - the CLOB to which the XML document is to be appended,</p> <p>dtdOrSchema (IN) - whether you should generate the DTD or Schema. This parameter is NOT supported.</p> <p>Use this version of function getXML, to avoid any extra CLOB copies and if you want to reuse the same CLOB for subsequent calls. This getXML call is more efficient than the next flavor, though this involves that you create the LOB locator. When generating the XML, the number of rows indicated by the setSkipRows call are skipped, then the maximum number of rows as specified by the setMaxRows call (or the entire result if not specified) is fetched and converted to XML. Use the getNumRowsProcessed function to check if any rows were retrieved or not.</p>
<pre>getXML()</pre>	<p>Generates the XML document and returns it as a CLOB.</p>
<pre>getXML(ctx IN ctxHandle, dtdOrSchema IN number:= NONE) RETURN clob;</pre>	<p><i>Parameters:</i></p> <p>ctx (IN) - The context handle obtained from calling newContext.</p> <p>dtdOrSchema (IN) - whether to generate a DTD or XML schema. This parameter is <i>not</i> supported.</p> <p><i>Returns:</i> A temporary CLOB containing the document. Free the temporary CLOB obtained from this function using the DBMS_LOB.freeTemporary call.</p>

Table 8-1 (Cont.) DBMS_XMLGEN Functions and Procedures

Function or Procedure	Description
<pre>getXMLType(ctx IN ctxHandle, dtdOrSchema IN number:= NONE) RETURN XMLType;</pre>	<p><i>Parameters:</i></p> <p>ctx (IN) - The context handle obtained from calling newContext.</p> <p>dtdOrSchema (IN) - whether to generate a DTD or XML schema. This parameter is <i>not</i> supported.</p> <p><i>Returns:</i> An XMLType instance containing the document.</p>
<pre>getXML(sqlQuery IN VARCHAR2, dtdOrSchema IN NUMBER := NONE) RETURN CLOB;</pre>	<p>Converts the query results from the SQL query string sqlQuery to XML format.</p> <p><i>Returns:</i> A CLOB instance.</p>
<pre>getXMLType(sqlQuery IN VARCHAR2, dtdOrSchema IN NUMBER := NONE) RETURN XMLType;</pre>	<p>Converts the query results from the SQL query string sqlQuery to XML format.</p> <p><i>Returns:</i> An XMLType instance.</p>
<pre>getNumRowsProcessed()</pre>	<p>Gets the number of SQL rows processed when generating XML data using function getXML. This count does not include the number of rows <i>skipped</i> before generating XML data.</p>
<pre>getNumRowsProcessed(ctx IN ctxHandle) RETURN number;</pre>	<p><i>Parameter:</i> queryString (IN) - the query string, the result of which must be converted to XML</p> <p><i>Returns:</i> The number of SQL rows that were processed in the last call to getXML.</p> <p>You can call this to find out if the end of the result set has been reached. This does not include the number of rows <i>skipped</i> before generating XML data. Use this function to determine the terminating condition if you are calling getXML in a loop. getXML always generates an XML document even if there are no rows present.</p>
<pre>setMaxRows()</pre>	<p>Sets the maximum number of rows to fetch from the SQL query result for every invocation of the getXML call. It is an error to call this function on a context handle created by function newContextFromHierarchy.</p>
<pre>setMaxRows(ctx IN ctxHandle, maxRows IN NUMBER);</pre>	<p><i>Parameters:</i></p> <p>ctx (IN) - the context handle corresponding to the query executed,</p> <p>maxRows (IN) - the maximum number of rows to get for each call to getXML.</p> <p>The maxRows parameter can be used when generating paginated results using this utility. For instance when generating a page of XML or HTML data, you can restrict the number of rows converted to XML and then in subsequent calls, you can get the next set of rows and so on. This also can provide for faster response times. It is an error to call this procedure on a context handle created by function newContextFromHierarchy.</p>

Table 8-1 (Cont.) DBMS_XMLGEN Functions and Procedures

Function or Procedure	Description
<code>setSkipRows()</code>	Skips a given number of rows before generating the XML output for every call to <code>getXML</code> . It is an error to call this function on a context handle created by function <code>newContextFromHierarchy</code> .
<code>setSkipRows(ctx IN ctxHandle, skipRows IN NUMBER);</code>	<p><i>Parameters:</i></p> <p><code>ctx (IN)</code> - the context handle corresponding to the query executed,</p> <p><code>skipRows (IN)</code> - the number of rows to skip for each call to <code>getXML</code>.</p> <p>The <code>skipRows</code> parameter can be used when generating paginated results for stateless Web pages using this utility. For instance when generating the first page of XML or HTML data, you can set <code>skipRows</code> to zero. For the next set, you can set the <code>skipRows</code> to the number of rows that you got in the first case. It is an error to call this function on a context handle created by function <code>newContextFromHierarchy</code>.</p>
<code>setConvertSpecialChars()</code>	Determines whether or not special characters in the XML data must be converted into their escaped XML equivalent. For example, the <code><</code> sign is converted to <code>&lt;</code> . The default behavior is to perform escape conversions.
<code>setConvertSpecialChars(ctx IN ctxHandle, conv IN BOOLEAN);</code>	<p><i>Parameters:</i></p> <p><code>ctx (IN)</code> - the context handle to use,</p> <p><code>conv (IN)</code> - true indicates that conversion is needed.</p> <p>You can use this function to speed up the XML processing whenever you are sure that the input data cannot contain any special characters such as <code><</code>, <code>></code>, <code>"</code>, <code>'</code>, and so on, which must be preceded by an escape character. It is expensive to scan the character data to replace the special characters, particularly if it involves a lot of data. So, in cases when the data is XML-safe, this function can be called to improve performance.</p>
<code>useItemTagsForColl()</code>	Sets the name of the collection elements. The default name for collection elements is the type name itself. You can override that to use the name of the column with the <code>_ITEM</code> tag appended to it using this function.
<code>useItemTagsForColl(ctx IN ctxHandle);</code>	<p><i>Parameter:</i> <code>ctx (IN)</code> - the context handle.</p> <p>If you have a collection of <code>NUMBER</code>, say, the default tag name for the collection elements is <code>NUMBER</code>. You can override this action and generate the collection column name with the <code>_ITEM</code> tag appended to it, by calling this procedure.</p>
<code>restartQuery()</code>	Restarts the query and generate the XML from the first row again.
<code>restartQuery(ctx IN ctxHandle);</code>	<p><i>Parameter:</i> <code>ctx (IN)</code> - the context handle corresponding to the current query. You can call this to start executing the query again, without having to create a new context.</p>

Table 8-1 (Cont.) DBMS_XMLGEN Functions and Procedures

Function or Procedure	Description
<code>closeContext()</code>	Closes a given context and releases all resources associated with that context, including the SQL cursor and bind and define buffers, and so on.
<code>closeContext(ctx IN ctxHandle);</code>	<i>Parameter:</i> <code>ctx (IN)</code> - the context handle to close. Closes all resources associated with this handle. After this you cannot use the handle for any other DBMS_XMLGEN function call.
<i>Conversion Functions</i>	Encodes or decodes the XML data string argument.
<code>convert(xmlData IN varchar2, flag IN NUMBER := ENTITY_ENCODE) RETURN VARCHAR2;</code>	<ul style="list-style-type: none"> • Encoding refers to replacing entity references such as < to their escaped equivalent, such as &lt;. • Decoding refers to the reverse conversion.
<code>convert(xmlData IN CLOB, flag IN NUMBER := ENTITY_ENCODE) RETURN CLOB;</code>	<p>Encodes or decodes the passed in XML CLOB data.</p> <ul style="list-style-type: none"> • Encoding refers to replacing entity references such as < to their escaped equivalent, such as &lt;. • Decoding refers to the reverse conversion.
<i>NULL Handling</i>	The <code>setNullHandling</code> flag values are:
<code>setNullHandling(ctx IN ctxHandle, flag IN NUMBER);</code>	<ul style="list-style-type: none"> • <code>DROP_NULLS CONSTANT NUMBER := 0;</code> This is the default setting and leaves out the tag for NULL elements. • <code>NULL_ATTR CONSTANT NUMBER := 1;</code> This sets <code>xsi:nil = "true"</code>. • <code>EMPTY_TAG CONSTANT NUMBER := 2;</code> This sets, for example, <code><foo/></code>.
<code>useNullAttributeIndicator(ctx IN ctxHandle, attrind IN BOOLEAN := TRUE);</code>	<code>useNullAttributeIndicator</code> is a shortcut for <code>setNullHandling(ctx, NULL_ATTR)</code> .
<code>setBindValue(ctx IN ctxHandle, bindValueName IN VARCHAR2, bindValue IN VARCHAR2);</code>	Sets bind value for the bind variable appearing in the query string associated with the context handle. The query string with bind variables cannot be executed until all of the bind variables are set values using <code>setBindValue</code> .
<code>clearBindValue(ctx IN ctxHandle);</code>	Clears all the bind values for all the bind variables appearing in the query string associated with the context handle. Afterward, all of the bind variables must rebind new values using <code>setBindValue</code> .

8.3.3 DBMS_XMLGEN Examples

Examples here illustrate the use of PL/SQL package DBMS_XMLGEN.

[Example 8-21](#) (page 8-30) uses DBMS_XMLGEN to create an XML document by selecting employee data from an object-relational table and putting the resulting CLOB value into a table.

Instead of generating all of the XML data for all rows, you can use the fetch interface of package `DBMS_XMLGEN` to retrieve a fixed number of rows each time. This speeds up response time and can help in scaling applications that need a Document Object Model (DOM) Application Program Interface (API) on the resulting XML, particularly if the number of rows is large.

[Example 8-22](#) (page 8-31) uses `DBMS_XMLGEN` to retrieve results from table `HR.employees`:

[Example 8-23](#) (page 8-32) uses `DBMS_XMLGEN` with object types to represent nested structures.

With relational data, the result is an XML document without nested elements. To obtain nested XML structures, you can use object-relational data, where the mapping is as follows:

- *Object types* map to XML elements – see [XML Schema Storage and Query: Basic](#) (page 17-1).
- *Attributes of the type* map to sub-elements of the parent element

Note:

Complex structures can be obtained by using object types and creating object views or object tables. A canonical mapping is used to map object instances to XML.

When used in column names or attribute names, the at-sign (@) is translated into an attribute of the enclosing XML element in the mapping.

When you provide a user-defined data-type instance to `DBMS_XMLGEN` functions, the user-defined data-type instance is mapped to an XML document using a canonical mapping: the *attributes* of the user-defined data type are mapped to XML *elements*. Attributes with names starting with an at-sign character (@) are mapped to attributes of the preceding element.

User-defined data-type instances can be used for nesting in the resulting XML document.

For example, consider the tables `emp` and `dept` defined in [Example 8-24](#) (page 8-34). To generate a hierarchical view of the data, that is, departments with their employees, [Example 8-24](#) (page 8-34) defines suitable object types to create the structure inside the database.

The default name `ROW` is not present because it was set to `NULL`. The `deptno` and `empno` have become attributes of the enclosing element.

[Example 8-25](#) (page 8-35) uses `DBMS_XMLGEN.getXMLType` to generate a purchase order document in XML format using object views.

[Example 8-26](#) (page 8-39) shows how to open a cursor variable for a query and use that cursor variable to create a new context handle for `DBMS_XMLGEN`.

See Also:

Oracle Database PL/SQL Language Reference for more information about cursor variables (`REF CURSOR`)

[Example 8-27](#) (page 8-40) shows how to specify NULL handling when using DBMS_XMLGEN.

Function `DBMS_XMLGEN.newContextFromHierarchy` takes as argument a hierarchical query string, which is typically formulated with a `CONNECT BY` clause. It returns a context that can be used to generate a hierarchical XML document with recursive elements.

The hierarchical query returns two columns, the level number (a pseudocolumn generated by `CONNECT BY` query) and an `XMLType` instance. The level is used to determine the position of the `XMLType` value within the hierarchy of the result XML document.

It is an error to set the skip number of rows or the maximum number of rows for a context created using `newContextFromHierarchy`.

[Example 8-28](#) (page 8-42) uses `DBMS_XMLGEN.newContextFromHierarchy` to generate a manager–employee hierarchy.

If the query string used to create a context contains host variables, you can use PL/SQL method `setBindValue()` to give the variables values before query execution. [Example 8-29](#) (page 8-44) illustrates this.

Example 8-21 DBMS_XMLGEN: Generating Simple XML

```
CREATE TABLE temp_clob_tab (result CLOB);

DECLARE
  qryCtx DBMS_XMLGEN.ctxHandle;
  result CLOB;
BEGIN
  qryCtx := DBMS_XMLGEN.newContext(
            'SELECT * FROM hr.employees WHERE employee_id = 101');
  -- Set the row header to be EMPLOYEE
  DBMS_XMLGEN.setRowTag(qryCtx, 'EMPLOYEE');
  -- Get the result
  result := DBMS_XMLGEN.getXML(qryCtx);
  INSERT INTO temp_clob_tab VALUES(result);
  --Close context
  DBMS_XMLGEN.closeContext(qryCtx);
END;
/
```

That generates the following XML document:

```
SELECT * FROM temp_clob_tab;

RESULT
-----
<?xml version="1.0"?>
<ROWSET>
  <EMPLOYEE>
    <EMPLOYEE_ID>101</EMPLOYEE_ID>
    <FIRST_NAME>Neena</FIRST_NAME>
    <LAST_NAME>Kochhar</LAST_NAME>
    <EMAIL>NKOCHHAR</EMAIL>
    <PHONE_NUMBER>515.123.4568</PHONE_NUMBER>
    <HIRE_DATE>21-SEP-05</HIRE_DATE>
    <JOB_ID>AD_VP</JOB_ID>
    <SALARY>17000</SALARY>
    <MANAGER_ID>100</MANAGER_ID>
    <DEPARTMENT_ID>90</DEPARTMENT_ID>
```

```

</EMPLOYEE>
</ROWSET>

1 row selected.

```

Example 8-22 DBMS_XMLGEN: Generating Simple XML with Pagination (Fetch)

```

-- Create a table to hold the results
CREATE TABLE temp_clob_tab (result clob);
DECLARE
  qryCtx DBMS_XMLGEN.ctxHandle;
  result CLOB;
BEGIN
  -- Get the query context;
  qryCtx := DBMS_XMLGEN.newContext('SELECT * FROM hr.employees');
  -- Set the maximum number of rows to be 2
  DBMS_XMLGEN.setMaxRows(qryCtx, 2);
  LOOP
    -- Get the result
    result := DBMS_XMLGEN.getXML(qryCtx);
    -- If no rows were processed, then quit
    EXIT WHEN DBMS_XMLGEN.getNumRowsProcessed(qryCtx) = 0;

    -- Do some processing with the lob data
    -- Insert the results into a table.
    -- You can print the lob out, output it to a stream,
    -- put it in a queue, or do any other processing.
    INSERT INTO temp_clob_tab VALUES(result);
  END LOOP;
  --close context
  DBMS_XMLGEN.closeContext(qryCtx);
END;
/

```

```
SELECT * FROM temp_clob_tab WHERE rownum < 3;
```

RESULT

```

-----
<?xml version="1.0"?>
<ROWSET>
  <ROW>
    <EMPLOYEE_ID>100</EMPLOYEE_ID>
    <FIRST_NAME>Steven</FIRST_NAME>
    <LAST_NAME>King</LAST_NAME>
    <EMAIL>SKING</EMAIL>
    <PHONE_NUMBER>515.123.4567</PHONE_NUMBER>
    <HIRE_DATE>17-JUN-03</HIRE_DATE>
    <JOB_ID>AD_PRES</JOB_ID>
    <SALARY>24000</SALARY>
    <DEPARTMENT_ID>90</DEPARTMENT_ID>
  </ROW>
  <ROW>
    <EMPLOYEE_ID>101</EMPLOYEE_ID>
    <FIRST_NAME>Neena</FIRST_NAME>
    <LAST_NAME>Kochhar</LAST_NAME>
    <EMAIL>NKOCHHAR</EMAIL>
    <PHONE_NUMBER>515.123.4568</PHONE_NUMBER>
    <HIRE_DATE>21-SEP-05</HIRE_DATE>
    <JOB_ID>AD_VP</JOB_ID>
    <SALARY>17000</SALARY>
    <MANAGER_ID>100</MANAGER_ID>

```

```

    <DEPARTMENT_ID>90</DEPARTMENT_ID>
  </ROW>
</ROWSET>

<?xml version="1.0"?>
<ROWSET>
  <ROW>
    <EMPLOYEE_ID>102</EMPLOYEE_ID>
    <FIRST_NAME>Lex</FIRST_NAME>
    <LAST_NAME>De Haan</LAST_NAME>
    <EMAIL>LDEHAAN</EMAIL>
    <PHONE_NUMBER>515.123.4569</PHONE_NUMBER>
    <HIRE_DATE>13-JAN-01</HIRE_DATE>
    <JOB_ID>AD_VP</JOB_ID>
    <SALARY>17000</SALARY>
    <MANAGER_ID>100</MANAGER_ID>
    <DEPARTMENT_ID>90</DEPARTMENT_ID>
  </ROW>
  <ROW>
    <EMPLOYEE_ID>103</EMPLOYEE_ID>
    <FIRST_NAME>Alexander</FIRST_NAME>
    <LAST_NAME>Hunold</LAST_NAME>
    <EMAIL>AHUNOLD</EMAIL>
    <PHONE_NUMBER>590.423.4567</PHONE_NUMBER>
    <HIRE_DATE>03-JAN-06</HIRE_DATE>
    <JOB_ID>IT_PROG</JOB_ID>
    <SALARY>9000</SALARY>
    <MANAGER_ID>102</MANAGER_ID>
    <DEPARTMENT_ID>60</DEPARTMENT_ID>
  </ROW>
</ROWSET>

```

2 rows selected.

Example 8-23 DBMS_XMLGEN: Generating XML Using Object Types

```

CREATE TABLE new_departments (department_id NUMBER PRIMARY KEY,
                             department_name VARCHAR2(20));
CREATE TABLE new_employees (employee_id NUMBER PRIMARY KEY,
                             last_name VARCHAR2(20),
                             department_id NUMBER REFERENCES new_departments);
CREATE TYPE emp_t AS OBJECT ("@employee_id" NUMBER,
                             last_name VARCHAR2(20));
/
INSERT INTO new_departments VALUES (10, 'SALES');
INSERT INTO new_departments VALUES (20, 'ACCOUNTING');
INSERT INTO new_employees VALUES (30, 'Scott', 10);
INSERT INTO new_employees VALUES (31, 'Mary', 10);
INSERT INTO new_employees VALUES (40, 'John', 20);
INSERT INTO new_employees VALUES (41, 'Jerry', 20);
COMMIT;
CREATE TYPE emplist_t AS TABLE OF emp_t;
/
CREATE TYPE dept_t AS OBJECT ("@department_id" NUMBER,
                             department_name VARCHAR2(20),
                             emplist emplist_t);
/
CREATE TABLE temp_clob_tab (result CLOB);
DECLARE
  qryCtx DBMS_XMLGEN.ctxHandle;
  result CLOB;

```



```

BEGIN
  DBMS_XMLGEN.setRowTag(qryCtx, NULL);
  qryCtx := DBMS_XMLGEN.newContext
    ('SELECT dept_t(department_id,
                   department_name,
                   cast(MULTISET
                       (SELECT e.employee_id, e.last_name
                        FROM new_employees e
                        WHERE e.department_id = d.department_id)
                       AS emplist_t))
    AS deptxml
    FROM new_departments d');
  -- now get the result
  result := DBMS_XMLGEN.getXML(qryCtx);
  INSERT INTO temp_clob_tab VALUES (result);
  -- close context
  DBMS_XMLGEN.closeContext(qryCtx);
END;
/
SELECT * FROM temp_clob_tab;

```

Here is the resulting XML:

```

RESULT
-----
<?xml version="1.0"?>
<ROWSET>
<ROW>
  <DEPTXML department_id="10">
    <DEPARTMENT_NAME>SALES</DEPARTMENT_NAME>
    <EMPLIST>
      <EMP_T employee_id="30">
        <LAST_NAME>Scott</LAST_NAME>
      </EMP_T>
      <EMP_T employee_id="31">
        <LAST_NAME>Mary</LAST_NAME>
      </EMP_T>
    </EMPLIST>
  </DEPTXML>
</ROW>
<ROW>
  <DEPTXML department_id="20">
    <DEPARTMENT_NAME>ACCOUNTING</DEPARTMENT_NAME>
    <EMPLIST>
      <EMP_T employee_id="40">
        <LAST_NAME>John</LAST_NAME>
      </EMP_T>
      <EMP_T employee_id="41">
        <LAST_NAME>Jerry</LAST_NAME>
      </EMP_T>
    </EMPLIST>
  </DEPTXML>
</ROW>
</ROWSET>

1 row selected.

```

Example 8-24 DBMS_XMLGEN: Generating XML Using User-Defined Data-Type Instances

```

CREATE TABLE dept (deptno NUMBER PRIMARY KEY, dname VARCHAR2(20));
CREATE TABLE emp (empno NUMBER PRIMARY KEY, ename VARCHAR2(20),
                  deptno NUMBER REFERENCES dept);

-- empno is preceded by an at-sign (@) to indicate that it must
-- be mapped as an attribute of the enclosing Employee element.
CREATE TYPE emp_t AS OBJECT ("@empno" NUMBER, -- empno defined as attribute
                             ename VARCHAR2(20));
/
INSERT INTO DEPT VALUES (10, 'Sports');
INSERT INTO DEPT VALUES(20, 'Accounting');
INSERT INTO EMP VALUES(200, 'John', 10);
INSERT INTO EMP VALUES(300, 'Jack', 10);
INSERT INTO EMP VALUES(400, 'Mary', 20);
INSERT INTO EMP VALUES(500, 'Jerry', 20);
COMMIT;
CREATE TYPE emplist_t AS TABLE OF emp_t;
/
CREATE TYPE dept_t AS OBJECT("@deptno" NUMBER,
                             dname VARCHAR2(20),
                             emplist emplist_t);
/
-- Department type dept_t contains a list of employees.
-- You can now query the employee and department tables and get
-- the result as an XML document, as follows:
CREATE TABLE temp_clob_tab (result CLOB);
DECLARE
    qryCtx DBMS_XMLGEN.ctxHandle;
    RESULT CLOB;
BEGIN
    -- get query context
    qryCtx := DBMS_XMLGEN.newContext(
        'SELECT dept_t(deptno,
                      dname,
                      cast(MULTISET
                          (SELECT empno, ename FROM emp e WHERE e.deptno = d.deptno)
                          AS emplist_t)
                      AS deptxml
        FROM dept d');
    -- set maximum number of rows to 5
    DBMS_XMLGEN.setMaxRows(qryCtx, 5);
    -- set no row tag for this result, since there is a single ADT column
    DBMS_XMLGEN.setRowTag(qryCtx, NULL);
    LOOP
        -- get result
        result := DBMS_XMLGEN.getXML(qryCtx);
        -- if there were no rows processed, then quit
        EXIT WHEN DBMS_XMLGEN.getNumRowsProcessed(qryCtx) = 0;
        -- do something with the result
        INSERT INTO temp_clob_tab VALUES (result);
    END LOOP;
END;
/

```

The **MULTISET** keyword for Oracle SQL function **cast** treats the employees working in the department as a list, which **cast** assigns to the appropriate collection type. A department instance is created using constructor **dept_t**, and **DBMS_XMLGEN** routines create the XML data for the object instance.

```
SELECT * FROM temp_clob_tab;
```

```
RESULT
```

```
-----
<?xml version="1.0"?>
<ROWSET>
  <DEPTXML deptno="10">
    <DNAME>Sports</DNAME>
    <EMPLIST>
      <EMP_T empno="200">
        <ENAME>John</ENAME>
      </EMP_T>
      <EMP_T empno="300">
        <ENAME>Jack</ENAME>
      </EMP_T>
    </EMPLIST>
  </DEPTXML>
  <DEPTXML deptno="20">
    <DNAME>Accounting</DNAME>
    <EMPLIST>
      <EMP_T empno="400">
        <ENAME>Mary</ENAME>
      </EMP_T>
      <EMP_T empno="500">
        <ENAME>Jerry</ENAME>
      </EMP_T>
    </EMPLIST>
  </DEPTXML>
</ROWSET>
```

```
1 row selected.
```

Example 8-25 DBMS_XMLGEN: Generating an XML Purchase Order

```
-- Create relational schema and define object views
-- DBMS_XMLGEN maps user-defined data-type attribute names that start
--   with an at-sign (@) to XML attributes

-- Purchase Order Object View Model

-- PhoneList varray object type
CREATE TYPE phonelist_vartyp AS VARRAY(10) OF VARCHAR2(20)
/

-- Address object type
CREATE TYPE address_typ AS OBJECT(Street VARCHAR2(200),
                                City   VARCHAR2(200),
                                State  CHAR(2),
                                Zip    VARCHAR2(20))
/

-- Customer object type
CREATE TYPE customer_typ AS OBJECT(CustNo   NUMBER,
                                CustName  VARCHAR2(200),
                                Address   address_typ,
                                PhoneList phonelist_vartyp)
/

-- StockItem object type
CREATE TYPE stockitem_typ AS OBJECT("@StockNo" NUMBER,
                                Price    NUMBER,
                                TaxRate  NUMBER)
/

-- LineItems object type
```

```

CREATE TYPE lineitem_typ AS OBJECT("@LineItemNo" NUMBER,
                                Item          stockitem_typ,
                                Quantity     NUMBER,
                                Discount     NUMBER)
/
-- LineItems ordered collection table
CREATE TYPE lineitems_ntabtyp AS TABLE OF lineitem_typ
/
-- Purchase Order object type
CREATE TYPE po_typ AUTHID CURRENT_USER
AS OBJECT(PONO          NUMBER,
          Cust_ref      REF customer_typ,
          OrderDate     DATE,
          ShipDate      TIMESTAMP,
          LineItems_ntab lineitems_ntabtyp,
          ShipToAddr    address_typ)
/
-- Create Purchase Order relational model tables
-- Customer table
CREATE TABLE customer_tab (CustNo    NUMBER NOT NULL,
                           CustName  VARCHAR2(200),
                           Street    VARCHAR2(200),
                           City      VARCHAR2(200),
                           State     CHAR(2),
                           Zip       VARCHAR2(20),
                           Phone1    VARCHAR2(20),
                           Phone2    VARCHAR2(20),
                           Phone3    VARCHAR2(20),
                           CONSTRAINT cust_pk PRIMARY KEY (CustNo));

-- Purchase Order table
CREATE TABLE po_tab (PONO          NUMBER,          /* purchase order number */
                    Custno         NUMBER          /* foreign KEY referencing customer */
                    CONSTRAINT po_cust_fk REFERENCES customer_tab,
                    OrderDate      DATE,          /* date of order */
                    ShipDate       TIMESTAMP,     /* date to be shipped */
                    ToStreet       VARCHAR2(200), /* shipto address */
                    ToCity         VARCHAR2(200),
                    ToState        CHAR(2),
                    ToZip          VARCHAR2(20),
                    CONSTRAINT po_pk PRIMARY KEY(PONO));

--Stock Table
CREATE TABLE stock_tab (StockNo NUMBER CONSTRAINT stock_uk UNIQUE,
                        Price  NUMBER,
                        TaxRate NUMBER);

--Line Items table
CREATE TABLE lineitems_tab (LineItemNo NUMBER,
                             PONO        NUMBER
                             CONSTRAINT li_po_fk REFERENCES po_tab,
                             StockNo     NUMBER,
                             Quantity    NUMBER,
                             Discount    NUMBER,
                             CONSTRAINT li_pk PRIMARY KEY (PONO, LineItemNo));

-- Create Object views
-- Customer Object View
CREATE OR REPLACE VIEW customer OF customer_typ
WITH OBJECT IDENTIFIER(CustNo)
AS SELECT c.custno, c.custname,
         address_typ(c.street, c.city, c.state, c.zip),
         phonelist_vartyp(phone1, phone2, phone3)
FROM customer_tab c;
--Purchase order view

```

```

CREATE OR REPLACE VIEW po OF po_typ
WITH OBJECT IDENTIFIER (PONo)
AS SELECT p.pono, make_ref(Customer, P.Custno), p.orderdate, p.shipdate,
        cast(MULTISET
            (SELECT lineitem_typ(l.lineitemno,
                                stockitem_typ(l.stockno, s.price,
                                                s.taxrate),
                                l.quantity, l.discount)
            FROM lineitems_tab l, stock_tab s
            WHERE l.pono = p.pono AND s.stockno=l.stockno)
        AS lineitems_ntabtyp),
        address_typ(p.tostreet,p.tocity, p.tostate, p.tozip)
FROM po_tab p;
-- Create table with XMLType column to store purchase order in XML format
CREATE TABLE po_xml_tab (poid NUMBER, podoc XMLType)
/
-- Populate data
-----
-- Establish Inventory
INSERT INTO stock_tab VALUES(1004, 6750.00, 2);
INSERT INTO stock_tab VALUES(1011, 4500.23, 2);
INSERT INTO stock_tab VALUES(1534, 2234.00, 2);
INSERT INTO stock_tab VALUES(1535, 3456.23, 2);
-- Register Customers
INSERT INTO customer_tab
VALUES (1, 'Jean Nance', '2 Avocet Drive',
        'Redwood Shores', 'CA', '95054',
        '415-555-1212', NULL, NULL);
INSERT INTO customer_tab
VALUES (2, 'John Nike', '323 College Drive',
        'Edison', 'NJ', '08820',
        '609-555-1212', '201-555-1212', NULL);
-- Place orders
INSERT INTO po_tab
VALUES (1001, 1, '10-APR-1997', '10-MAY-1997',
        NULL, NULL, NULL, NULL);
INSERT INTO po_tab
VALUES (2001, 2, '20-APR-1997', '20-MAY-1997',
        '55 Madison Ave', 'Madison', 'WI', '53715');
-- Detail line items
INSERT INTO lineitems_tab VALUES(01, 1001, 1534, 12, 0);
INSERT INTO lineitems_tab VALUES(02, 1001, 1535, 10, 10);
INSERT INTO lineitems_tab VALUES(01, 2001, 1004, 1, 0);
INSERT INTO lineitems_tab VALUES(02, 2001, 1011, 2, 1);

-- Use package DBMS_XMLGEN to generate purchase order in XML format
-- and store XMLType in table po_xml
DECLARE
    qryCtx DBMS_XMLGEN.ctxHandle;
    pxml XMLType;
    cxml CLOB;
BEGIN
    -- get query context;
    qryCtx := DBMS_XMLGEN.newContext('SELECT pono,deref(cust_ref) customer,
                                    p.orderdate,
                                    p.shipdate,
                                    lineitems_ntab lineitems,
                                    shiptoaddr
                                    FROM po p');
    -- set maximum number of rows to be 1,
    DBMS_XMLGEN.setMaxRows(qryCtx, 1);

```

```

-- set ROWSET tag to NULL and ROW tag to PurchaseOrder
DBMS_XMLGEN.setRowSetTag(qryCtx, NULL);
DBMS_XMLGEN.setRowTag(qryCtx, 'PurchaseOrder');
LOOP
  -- get purchase order in XML format
  pxml := DBMS_XMLGEN.getXMLType(qryCtx);
  -- if there were no rows processed, then quit
  EXIT WHEN DBMS_XMLGEN.getNumRowsProcessed(qryCtx) = 0;
  -- Store XMLType po in po_xml table (get the pono out)
  INSERT INTO po_xml_tab(poid, poDoc)
    VALUES(XMLCast(XMLQuery('//PONO/text()' PASSING pxml RETURNING CONTENT)
      AS NUMBER),
      pxml);
END LOOP;
END;
/

```

This query then produces two XML purchase-order documents:

```
SELECT XMLSerialize(DOCUMENT x.podoc AS CLOB) xpo FROM po_xml_tab x;
```

XPO

```

-----
<PurchaseOrder>
  <PONO>1001</PONO>
  <CUSTOMER>
    <CUSTNO>1</CUSTNO>
    <CUSTNAME>Jean Nance</CUSTNAME>
    <ADDRESS>
      <STREET>2 Avocet Drive</STREET>
      <CITY>Redwood Shores</CITY>
      <STATE>CA</STATE>
      <ZIP>95054</ZIP>
    </ADDRESS>
    <PHONELIST>
      <VARCHAR2>415-555-1212</VARCHAR2>
    </PHONELIST>
  </CUSTOMER>
  <ORDERDATE>10-APR-97</ORDERDATE>
  <SHIPDATE>10-MAY-97 12.00.00.000000 AM</SHIPDATE>
  <LINEITEMS>
    <LINEITEM_TYP LineItemNo="1">
      <ITEM StockNo="1534">
        <PRICE>2234</PRICE>
        <TAXRATE>2</TAXRATE>
      </ITEM>
      <QUANTITY>12</QUANTITY>
      <DISCOUNT>0</DISCOUNT>
    </LINEITEM_TYP>
    <LINEITEM_TYP LineItemNo="2">
      <ITEM StockNo="1535">
        <PRICE>3456.23</PRICE>
        <TAXRATE>2</TAXRATE>
      </ITEM>
      <QUANTITY>10</QUANTITY>
      <DISCOUNT>10</DISCOUNT>
    </LINEITEM_TYP>
  </LINEITEMS>
  <SHIPTOADDR/>
</PurchaseOrder>

```

```

<PurchaseOrder>
  <PONO>2001</PONO>
  <CUSTOMER>
    <CUSTNO>2</CUSTNO>
    <CUSTNAME>John Nike</CUSTNAME>
    <ADDRESS>
      <STREET>323 College Drive</STREET>
      <CITY>Edison</CITY>
      <STATE>NJ</STATE>
      <ZIP>08820</ZIP>
    </ADDRESS>
    <PHONELIST>
      <VARCHAR2>609-555-1212</VARCHAR2>
      <VARCHAR2>201-555-1212</VARCHAR2>
    </PHONELIST>
  </CUSTOMER>
  <ORDERDATE>20-APR-97</ORDERDATE>
  <SHIPDATE>20-MAY-97 12.00.00.000000 AM</SHIPDATE>
  <LINEITEMS>
    <LINEITEM_TYP LineItemNo="1">
      <ITEM StockNo="1004">
        <PRICE>6750</PRICE>
        <TAXRATE>2</TAXRATE>
      </ITEM>
      <QUANTITY>1</QUANTITY>
      <DISCOUNT>0</DISCOUNT>
    </LINEITEM_TYP>
    <LINEITEM_TYP LineItemNo="2">
      <ITEM StockNo="1011">
        <PRICE>4500.23</PRICE>
        <TAXRATE>2</TAXRATE>
      </ITEM>
      <QUANTITY>2</QUANTITY>
      <DISCOUNT>1</DISCOUNT>
    </LINEITEM_TYP>
  </LINEITEMS>
  <SHIPTOADDR>
    <STREET>55 Madison Ave</STREET>
    <CITY>Madison</CITY>
    <STATE>WI</STATE>
    <ZIP>53715</ZIP>
  </SHIPTOADDR>
</PurchaseOrder>

```

2 rows selected.

Example 8-26 DBMS_XMLGEN: Generating a New Context Handle from a REF Cursor

```

CREATE TABLE emp_tab (emp_id      NUMBER PRIMARY KEY,
                      name        VARCHAR2(20),
                      dept_id     NUMBER);

```

Table created.

```

INSERT INTO emp_tab VALUES (122, 'Scott', 301);

```

1 row created.

```

INSERT INTO emp_tab VALUES (123, 'Mary', 472);

```

1 row created.

```

INSERT INTO emp_tab VALUES (124, 'John', 93);

```

1 row created.

```

INSERT INTO emp_tab VALUES (125, 'Howard', 488);

```

1 row created.

```

INSERT INTO emp_tab VALUES (126, 'Sue', 16);
1 row created.
COMMIT;

DECLARE
    ctx      NUMBER;
    maxrow   NUMBER;
    xmldoc   CLOB;
    refcur   SYS_REFCURSOR;
BEGIN
    DBMS_LOB.createtemporary(xmldoc, TRUE);
    maxrow := 3;
    OPEN refcur FOR 'SELECT * FROM emp_tab WHERE ROWNUM <= :1' USING maxrow;
    ctx := DBMS_XMLGEN.newContext(refcur);
    -- xmldoc will have 3 rows
    DBMS_XMLGEN.getXML(ctx, xmldoc, DBMS_XMLGEN.NONE);
    DBMS_OUTPUT.put_line(xmldoc);
    DBMS_LOB.freetemporary(xmldoc);
    CLOSE refcur;
    DBMS_XMLGEN.closeContext(ctx);
END;
/
<?xml version="1.0"?>
<ROWSET>
  <ROW>
    <EMP_ID>122</EMP_ID>
    <NAME>Scott</NAME>
    <DEPT_ID>301</DEPT_ID>
  </ROW>
  <ROW>
    <EMP_ID>123</EMP_ID>
    <NAME>Mary</NAME>
    <DEPT_ID>472</DEPT_ID>
  </ROW>
  <ROW>
    <EMP_ID>124</EMP_ID>
    <NAME>John</NAME>
    <DEPT_ID>93</DEPT_ID>
  </ROW>
</ROWSET>

PL/SQL procedure successfully completed.

```

Example 8-27 DBMS_XMLGEN: Specifying NULL Handling

```

CREATE TABLE emp_tab (emp_id      NUMBER PRIMARY KEY,
                      name        VARCHAR2(20),
                      dept_id     NUMBER);

Table created.
INSERT INTO emp_tab VALUES (30, 'Scott', NULL);
1 row created.
INSERT INTO emp_tab VALUES (31, 'Mary', NULL);
1 row created.
INSERT INTO emp_tab VALUES (40, 'John', NULL);
1 row created.
COMMIT;
CREATE TABLE temp_clob_tab (result CLOB);
Table created.

DECLARE
    qryCtx DBMS_XMLGEN.ctxHandle;

```



```

    result CLOB;
BEGIN
    qryCtx := DBMS_XMLGEN.newContext('SELECT * FROM emp_tab where name = :NAME');
    -- Set the row header to be EMPLOYEE
    DBMS_XMLGEN.setRowTag(qryCtx, 'EMPLOYEE');
    -- Drop nulls
    DBMS_XMLGEN.setBindValue(qryCtx, 'NAME', 'Scott');
    DBMS_XMLGEN.setNullHandling(qryCtx, DBMS_XMLGEN.DROP_NULLS);
    result := DBMS_XMLGEN.getXML(qryCtx);
    INSERT INTO temp_clob_tab VALUES(result);
    -- Null attribute
    DBMS_XMLGEN.setBindValue(qryCtx, 'NAME', 'Mary');
    DBMS_XMLGEN.setNullHandling(qryCtx, DBMS_XMLGEN.NULL_ATTR);
    result := DBMS_XMLGEN.getXML(qryCtx);
    INSERT INTO temp_clob_tab VALUES(result);
    -- Empty tag
    DBMS_XMLGEN.setBindValue(qryCtx, 'NAME', 'John');
    DBMS_XMLGEN.setNullHandling(qryCtx, DBMS_XMLGEN.EMPTY_TAG);
    result := DBMS_XMLGEN.getXML(qryCtx);
    INSERT INTO temp_clob_tab VALUES(result);
    --Close context
    DBMS_XMLGEN.closeContext(qryCtx);
END;
/

```

PL/SQL procedure successfully completed.

```
SELECT * FROM temp_clob_tab;
```

RESULT

```

-----
<?xml version="1.0"?>
<ROWSET>
  <EMPLOYEE>
    <EMP_ID>30</EMP_ID>
    <NAME>Scott</NAME>
  </EMPLOYEE>
</ROWSET>

<?xml version="1.0"?>
<ROWSET xmlns:xsi = "http://www.w3.org/2001/XMLSchema-instance">
  <EMPLOYEE>
    <EMP_ID>31</EMP_ID>
    <NAME>Mary</NAME>
    <DEPT_ID xsi:nil = "true"/>
  </EMPLOYEE>
</ROWSET>

<?xml version="1.0"?>
<ROWSET>
  <EMPLOYEE>
    <EMP_ID>40</EMP_ID>
    <NAME>John</NAME>
    <DEPT_ID/>
  </EMPLOYEE>
</ROWSET>

```

3 rows selected.

Example 8-28 DBMS_XMLGEN: Generating Recursive XML with a Hierarchical Query

```

CREATE TABLE sqlx_display (id NUMBER, xmldoc XMLType);
Table created.

DECLARE
  qryctx DBMS_XMLGEN.ctxhandle;
  result XMLType;
BEGIN
  qryctx :=
    DBMS_XMLGEN.newContextFromHierarchy(
      'SELECT level,
          XMLElement("employees",
                    XMLElement("enumber", employee_id),
                    XMLElement("name", last_name),
                    XMLElement("Salary", salary),
                    XMLElement("Hiredate", hire_date))
          FROM hr.employees
          START WITH last_name='De Haan' CONNECT BY PRIOR employee_id=manager_id
          ORDER SIBLINGS BY hire_date');
  result := DBMS_XMLGEN.getxmltype(qryctx);
  DBMS_OUTPUT.put_line('<result num rows>');
  DBMS_OUTPUT.put_line(to_char(DBMS_XMLGEN.getNumRowsProcessed(qryctx)));
  DBMS_OUTPUT.put_line('</result num rows>');
  INSERT INTO sqlx_display VALUES (2, result);
  COMMIT;
  DBMS_XMLGEN.closecontext(qryctx);
END;
/
<result num rows>
6
</result num rows>
PL/SQL procedure successfully completed.

SELECT xmldoc FROM sqlx_display WHERE id = 2;

XMLDOC
-----
<?xml version="1.0"?>
<employees>
  <enumber>102</enumber>
  <name>De Haan</name>
  <Salary>17000</Salary>
  <Hiredate>2001-01-13</Hiredate>
  <employees>
    <enumber>103</enumber>
    <name>Hunold</name>
    <Salary>9000</Salary>
    <Hiredate>2006-01-03</Hiredate>
    <employees>
      <enumber>105</enumber>
      <name>Austin</name>
      <Salary>4800</Salary>
      <Hiredate>2005-06-25</Hiredate>
    </employees>
  </employees>
  <employees>
    <enumber>106</enumber>
    <name>Patoballa</name>
    <Salary>4800</Salary>
    <Hiredate>2006-02-05</Hiredate>
  </employees>
</employees>

```

```

</employees>
<employees>
  <enumber>107</enumber>
  <name>Lorentz</name>
  <Salary>4200</Salary>
  <Hiredate>2007-02-07</Hiredate>
</employees>
<employees>
  <enumber>104</enumber>
  <name>Ernst</name>
  <Salary>6000</Salary>
  <Hiredate>2007-05-21</Hiredate>
</employees>
</employees>
</employees>

```

1 row selected.

By default, the ROWSET tag is NULL: there is no default ROWSET tag used to enclose the XML result. However, you can explicitly set the ROWSET tag by using procedure `setRowSetTag`, as follows:

```

CREATE TABLE gg (x XMLType);
Table created.

DECLARE
  qryctx DBMS_XMLGEN.ctxhandle;
  result CLOB;
BEGIN
  qryctx := DBMS_XMLGEN.newContextFromHierarchy(
    'SELECT level,
           XMLElement("NAME", last_name) AS myname FROM hr.employees
    CONNECT BY PRIOR employee_id=manager_id
    START WITH employee_id = 102');
  DBMS_XMLGEN.setRowSetTag(qryctx, 'mynum_hierarchy');
  result:=DBMS_XMLGEN.getxml(qryctx);
  DBMS_OUTPUT.put_line('<result num rows>');
  DBMS_OUTPUT.put_line(to_char(DBMS_XMLGEN.getNumRowsProcessed(qryctx)));
  DBMS_OUTPUT.put_line('</result num rows>');
  INSERT INTO gg VALUES(XMLType(result));
  COMMIT;
  DBMS_XMLGEN.closecontext(qryctx);
END;
/
<result num rows>
6
</result num rows>
PL/SQL procedure successfully completed.

SELECT * FROM gg;

X
-----
<?xml version="1.0"?>
<mynum_hierarchy>
  <NAME>De Haan
    <NAME>Hunold
      <NAME>Ernst</NAME>
      <NAME>Austin</NAME>
      <NAME>Pataballa</NAME>
      <NAME>Lorentz</NAME>

```

```

        </NAME>
    </NAME>
</mynum_hierarchy>

```

1 row selected.

Example 8-29 DBMS_XMLGEN: Binding Query Variables Using SETBINDVALUE()

```

-- Bind one variable
DECLARE
    ctx NUMBER;
    xmldoc CLOB;
BEGIN
    ctx := DBMS_XMLGEN.newContext(
        'SELECT * FROM employees WHERE employee_id = :NO');
    DBMS_XMLGEN.setBindValue(ctx, 'NO', '145');
    xmldoc := DBMS_XMLGEN.getXML(ctx);
    DBMS_OUTPUT.put_line(xmldoc);
    DBMS_XMLGEN.closeContext(ctx);
EXCEPTION
    WHEN OTHERS THEN DBMS_XMLGEN.closeContext(ctx);
    RAISE;
END;
/
<?xml version="1.0"?>
<ROWSET>
  <ROW>
    <EMPLOYEE_ID>145</EMPLOYEE_ID>
    <FIRST_NAME>John</FIRST_NAME>
    <LAST_NAME>Russell</LAST_NAME>
    <EMAIL>JRUSSEL</EMAIL>
    <PHONE_NUMBER>011.44.1344.429268</PHONE_NUMBER>
    <HIRE_DATE>01-OCT-04</HIRE_DATE>
    <JOB_ID>SA_MAN</JOB_ID>
    <SALARY>14000</SALARY>
    <COMMISSION_PCT>.4</COMMISSION_PCT>
    <MANAGER_ID>100</MANAGER_ID>
    <DEPARTMENT_ID>80</DEPARTMENT_ID>
  </ROW>
</ROWSET>

```

PL/SQL procedure successfully completed.

```

-- Bind one variable twice with different values
DECLARE
    ctx NUMBER;
    xmldoc CLOB;
BEGIN
    ctx := DBMS_XMLGEN.newContext('SELECT * FROM employees
        WHERE hire_date = :MDATE');
    DBMS_XMLGEN.setBindValue(ctx, 'MDATE', '01-OCT-04');
    xmldoc := DBMS_XMLGEN.getXML(ctx);
    DBMS_OUTPUT.put_line(xmldoc);
    DBMS_XMLGEN.setBindValue(ctx, 'MDATE', '10-MAR-05');
    xmldoc := DBMS_XMLGEN.getXML(ctx);
    DBMS_OUTPUT.put_line(xmldoc);
    DBMS_XMLGEN.closeContext(ctx);
EXCEPTION
    WHEN OTHERS THEN DBMS_XMLGEN.closeContext(ctx);
    RAISE;
END;

```

```

/
<?xml version="1.0"?>
<ROWSET>
  <ROW>
    <EMPLOYEE_ID>145</EMPLOYEE_ID>
    <FIRST_NAME>John</FIRST_NAME>
    <LAST_NAME>Russell</LAST_NAME>
    <EMAIL>JRUSSEL</EMAIL>
    <PHONE_NUMBER>011.44.1344.429268</PHONE_NUMBER>
    <HIRE_DATE>01-OCT-04</HIRE_DATE>
    <JOB_ID>SA_MAN</JOB_ID>
    <SALARY>14000</SALARY>
    <COMMISSION_PCT>.4</COMMISSION_PCT>
    <MANAGER_ID>100</MANAGER_ID>
    <DEPARTMENT_ID>80</DEPARTMENT_ID>
  </ROW>
</ROWSET>

```

```

<?xml version="1.0"?>
<ROWSET>
  <ROW>
    <EMPLOYEE_ID>147</EMPLOYEE_ID>
    <FIRST_NAME>Alberto</FIRST_NAME>
    <LAST_NAME>Errazuriz</LAST_NAME>
    <EMAIL>AERRAZUR</EMAIL>
    <PHONE_NUMBER>011.44.1344.429278</PHONE_NUMBER>
    <HIRE_DATE>10-MAR-05</HIRE_DATE>
    <JOB_ID>SA_MAN</JOB_ID>
    <SALARY>12000</SALARY>
    <COMMISSION_PCT>.3</COMMISSION_PCT>
    <MANAGER_ID>100</MANAGER_ID>
    <DEPARTMENT_ID>80</DEPARTMENT_ID>
  </ROW>
  <ROW>
    <EMPLOYEE_ID>159</EMPLOYEE_ID>
    <FIRST_NAME>Lindsey</FIRST_NAME>
    <LAST_NAME>Smith</LAST_NAME>
    <EMAIL>LSMITH</EMAIL>
    <PHONE_NUMBER>011.44.1345.729268</PHONE_NUMBER>
    <HIRE_DATE>10-MAR-97</HIRE_DATE>
    <JOB_ID>SA_REP</JOB_ID>
    <SALARY>8000</SALARY>
    <COMMISSION_PCT>.3</COMMISSION_PCT>
    <MANAGER_ID>146</MANAGER_ID>
    <DEPARTMENT_ID>80</DEPARTMENT_ID>
  </ROW>
</ROWSET>

```

PL/SQL procedure successfully completed.

-- Bind two variables

```

DECLARE
  ctx NUMBER;
  xmldoc CLOB;
BEGIN
  ctx := DBMS_XMLGEN.newContext('SELECT * FROM employees
                                WHERE employee_id = :NO
                                AND hire_date = :MDATE');
  DBMS_XMLGEN.setBindValue(ctx, 'NO', '145');
  DBMS_XMLGEN.setBindValue(ctx, 'MDATE', '01-OCT-04');
  xmldoc := DBMS_XMLGEN.getXML(ctx);
  DBMS_OUTPUT.put_line(xmldoc);

```

```

        DBMS_XMLGEN.closeContext(ctx);
    EXCEPTION
        WHEN OTHERS THEN DBMS_XMLGEN.closeContext(ctx);
        RAISE;
    END;
/
<?xml version="1.0"?>
<ROWSET>
  <ROW>
    <EMPLOYEE_ID>145</EMPLOYEE_ID>
    <FIRST_NAME>John</FIRST_NAME>
    <LAST_NAME>Russell</LAST_NAME>
    <EMAIL>JRUSSEL</EMAIL>
    <PHONE_NUMBER>011.44.1344.429268</PHONE_NUMBER>
    <HIRE_DATE>01-OCT-04</HIRE_DATE>
    <JOB_ID>SA_MAN</JOB_ID>
    <SALARY>14000</SALARY>
    <COMMISSION_PCT>.4</COMMISSION_PCT>
    <MANAGER_ID>100</MANAGER_ID>
    <DEPARTMENT_ID>80</DEPARTMENT_ID>
  </ROW>
</ROWSET>
PL/SQL procedure successfully completed.

```

8.4 SYS_XMLAGG Oracle SQL Function

Oracle SQL function `sys_XMLAgg` aggregates all XML documents or fragments represented by an expression, producing a single XML document from them. It wraps the results of the expression in a new element named `ROWSET` (by default).

Oracle function `sys_XMLAgg` is similar to standard SQL/XML function `XMLAgg`, but `sys_XMLAgg` returns a single node and it accepts an `XMLFormat` parameter. You can use that parameter to format the resulting XML document in various ways.

Figure 8-13 SYS_XMLAGG Syntax



See Also:

- *Oracle Database SQL Language Reference* for information about `sys_XMLAgg`
 - *Oracle Database SQL Language Reference* for information about an `XMLFormat` parameter
-

8.5 Ordering Query Results Before Aggregating, Using XMLAGG ORDER BY Clause

To use the `XMLAgg ORDER BY` clause before aggregation, specify the `ORDER BY` clause following the first `XMLAGG` argument.

This is illustrated in [Example 8-30](#) (page 8-46).

Example 8-30 Using XMLAGG ORDER BY Clause

```

CREATE TABLE dev_tab (dev          NUMBER,
                      dev_total    NUMBER,
                      devname       VARCHAR2(20));

```

```

Table created.
INSERT INTO dev_tab VALUES (16, 5, 'Alexis');
1 row created.
INSERT INTO dev_tab VALUES (2, 14, 'Han');
1 row created.
INSERT INTO dev_tab VALUES (1, 2, 'Jess');
1 row created.
INSERT INTO dev_tab VALUES (9, 88, 'Kurt');
1 row created.
COMMIT;

```

The result of the following query is aggregated according to the order of the dev column. (The result is shown here pretty-printed, for clarity.)

```

SELECT XMLAgg(XMLElement("Dev",
                        XMLAttributes(dev AS "id", dev_total AS "total"),
                        devname)
            ORDER BY dev)
FROM dev_tab dev_total;

XMLAGG(XMLELEMENT("DEV",XMLATTRIBUTES(DEVAS"ID",DEV_TOTALAS"TOTAL"),DEVNAME)ORDE
-----
<Dev id="1" total="2">Jess</Dev>
<Dev id="2" total="14">Han</Dev>
<Dev id="9" total="88">Kurt</Dev>
<Dev id="16" total="5">Alexis</Dev>

1 row selected.

```

8.6 Returning a Rowset Using XMLTABLE

You can use standard SQL/XML function `XMLTable` to return a rowset with relevant portions of a document extracted as multiple rows.

This is shown in [Example 8-31](#) (page 8-47).

Example 8-31 *Returning a Rowset Using XMLTABLE*

```

CONNECT oe
Enter password: password

Connected.

SELECT item.descr, item.partid
FROM purchaseorder,
XMLTable('$p/PurchaseOrder/LineItems/LineItem' PASSING OBJECT_VALUE
        COLUMNS descr VARCHAR2(256) PATH 'Description',
        partid VARCHAR2(14) PATH 'Part/@Id') item
WHERE item.partid = '715515012027'
OR item.partid = '715515011921'
ORDER BY partid;

```

This returns a rowset with just the descriptions and part IDs, ordered by part ID.

```

DESCR
-----
PARTID
-----
My Man Godfrey
715515011921

My Man Godfrey

```

715515011921

My Man Godfrey
715515011921

My Man Godfrey
715515011921

My Man Godfrey
715515011921

My Man Godfrey
715515011921

My Man Godfrey
715515011921

Mona Lisa
715515012027

Mona Lisa
715515012027

Mona Lisa
715515012027

Mona Lisa
715515012027

Mona Lisa
715515012027

Mona Lisa
715515012027

Mona Lisa
715515012027

Mona Lisa
715515012027

Mona Lisa
715515012027

16 rows selected.

Relational Views over XML Data

Relational database views over XML data provide conventional, relational access to XML content.

- [Introduction to Creating and Using Relational Views over XML Data](#) (page 9-1)
- [Creating a Relational View over XML: One Row for Each XML Document](#) (page 9-1)
- [Creating a Relational View over XML: Mapping XML Nodes to Columns](#) (page 9-2)
- [Indexing Binary XML Data Exposed Using a Relational View](#) (page 9-4)
- [Querying XML Content As Relational Data](#) (page 9-5)

9.1 Introduction to Creating and Using Relational Views over XML Data

You can use the XML-specific functions and methods provided by Oracle XML DB to create conventional database views that provide relational access to XML content. This lets programmers, tools, and applications that understand Oracle Database, but not necessarily XML, work with XML content stored in the database.

The relational views can use XQuery expressions and SQL/XML functions such as `XMLTable` to define a mapping between columns in the view and nodes in an XML document.

See Also:

- [XQuery and Oracle XML DB](#) (page 4-1)
 - [Indexes for XMLType Data](#) (page 6-1)
-

9.2 Creating a Relational View over XML: One Row for Each XML Document

To expose each document in an `XMLType` table as a row in a relational view, use `CREATE OR REPLACE VIEW AS SELECT`, selecting from a join of the `XMLType` table and a relational table that you create from the XML data using SQL/XML function `XMLTable`.

You use standard SQL/XML function `XMLTable` to map nodes in the XML document to columns in the view. Use this technique whenever there is a one-to-one (1:1) relationship between documents in the `XMLType` table and the rows in the view.

[Example 9-1](#) (page 9-2) creates relational view `purchaseorder_master_view`, which has one row for each row in `XMLType` table `po_binaryxml`.

Example 9-1 Creating a Relational View of XML Content

```
CREATE TABLE po_binaryxml OF XMLType
  XMLTYPE STORE AS BINARY XML;

INSERT INTO po_binaryxml SELECT OBJECT_VALUE FROM OE.purchaseorder;

CREATE OR REPLACE VIEW purchaseorder_master_view AS
  SELECT po.*
  FROM po_binaryxml pur,
       XMLTable(
         '$p/PurchaseOrder' PASSING pur.OBJECT_VALUE as "p"
         COLUMNS
           reference      VARCHAR2(30)  PATH 'Reference',
           requestor      VARCHAR2(128) PATH 'Requestor',
           userid         VARCHAR2(10)  PATH 'User',
           costcenter     VARCHAR2(4)   PATH 'CostCenter',
           ship_to_name   VARCHAR2(20)  PATH 'ShippingInstructions/name',
           ship_to_address VARCHAR2(256) PATH 'ShippingInstructions/address',
           ship_to_phone  VARCHAR2(24)  PATH 'ShippingInstructions/telephone',
           instructions   VARCHAR2(2048) PATH 'SpecialInstructions') po;
```

View created.

```
DESCRIBE purchaseorder_master_view
```

Name	Null?	Type
REFERENCE		VARCHAR2(30)
REQUESTOR		VARCHAR2(128)
USERID		VARCHAR2(10)
COSTCENTER		VARCHAR2(4)
SHIP_TO_NAME		VARCHAR2(20)
SHIP_TO_ADDRESS		VARCHAR2(256)
SHIP_TO_PHONE		VARCHAR2(24)
INSTRUCTIONS		VARCHAR2(2048)

9.3 Creating a Relational View over XML: Mapping XML Nodes to Columns

To expose data from multiple levels of an XMLType table as individual rows in a relational view, apply SQL/XML function XMLTable to each level. Use this technique whenever there is a one-to-many (1:N) relationship between documents in the XMLType table and rows in the view.

That is, you use the same general approach as for breaking up a single level (see [Creating a Relational View over XML: One Row for Each XML Document](#) (page 9-1)): Define the columns making up the view, and map the XML nodes to those columns. But in this case you apply XMLTable to each document level that is to be broken up and stored in relational columns.

For example, each PurchaseOrder element contains a LineItems element, which in turn contains one or more LineItem elements. Each LineItem element has child elements, such as Description, and an ItemNumber attribute. To make such lower-level data accessible as a relational value, use XMLTable to project both the PurchaseOrder element and the LineItem collection.

When element PurchaseOrder is broken up, its descendant LineItem element is mapped to a column of type XMLType, which contains an XML fragment. That column is then passed to a second call to XMLTable to be broken into its various parts as multiple columns of relational values.

[Example 9-2](#) (page 9-3) illustrates this. It uses `XMLTable` to effect a one-to-many (1:N) relationship between the documents in `XMLType` table `po_binaryxml` and the rows in relational view `purchaseorder_detail_view`. The view provides access to the individual members of a collection and exposes the collection members as a set of rows.

In [Example 9-2](#) (page 9-3), there is one row in view `purchaseorder_detail_view` for each `LineItem` element in the XML documents stored in `XMLType` table `po_binaryxml`.

The `CREATE OR REPLACE VIEW` statement of [Example 9-2](#) (page 9-3) defines the set of relational columns that make up the view. The `SELECT` statement passes table `po_binaryxml` as context to function `XMLTable` to create virtual table `p`, which has columns `reference` and `lineitem`. These columns contain the `Reference` and `LineItem` elements of the purchase-order documents, respectively.

Column `lineitem` contains a collection of `LineItem` elements as an `XMLType` instance — one row for each element. These rows are in turn passed to a second `XMLTable` expression to serve as its context. This second `XMLTable` expression creates a virtual table of line-item rows, with columns corresponding to various descendant nodes of element `LineItem`. Most of these descendants are attributes (`ItemNumber`, `Part/@Id`, and so on). One of the descendants is the child element `Description`.

Element `Reference` is projected in view `purchaseorder_detail_view` as column `reference`. It provides a foreign key that can be used to join rows in view `purchaseorder_detail_view` to corresponding rows in view `purchaseorder_master_view`. The correlated join in the `CREATE OR REPLACE VIEW` statement ensures that the one-to-many (1:N) relationship between element `Reference` and the associated `LineItem` elements is maintained whenever the view is accessed.

Example 9-2 Accessing Individual Members of a Collection Using a View

```
CREATE OR REPLACE VIEW purchaseorder_detail_view AS
  SELECT po.reference, li.*
  FROM po_binaryxml p,
       XMLTable('/PurchaseOrder' PASSING p.OBJECT_VALUE
              COLUMNS
                reference VARCHAR2(30) PATH 'Reference',
                lineitem XMLType PATH 'LineItems/LineItem') po,
       XMLTable('/LineItem' PASSING po.lineitem
              COLUMNS
                itemno NUMBER(38) PATH '@ItemNumber',
                description VARCHAR2(256) PATH 'Description',
                partno VARCHAR2(14) PATH 'Part/@Id',
                quantity NUMBER(12, 2) PATH 'Part/@Quantity',
                unitprice NUMBER(8, 4) PATH 'Part/@UnitPrice') li;
```

View created.

```
DESCRIBE purchaseorder_detail_view
Name          Null?     Type
-----
REFERENCE          VARCHAR2(30)
ITEMNO             NUMBER(38)
DESCRIPTION        VARCHAR2(256)
PARTNO             VARCHAR2(14)
QUANTITY           NUMBER(12,2)
UNITPRICE          NUMBER(8,4)
```

9.4 Indexing Binary XML Data Exposed Using a Relational View

If the relational columns of the structured component of an `XMLIndex` index over binary XML data match the columns of a relational view over that data, then the view too is effectively indexed.

When the `XMLType` data that is exposed in a relational view is stored as binary XML, you can typically improve performance by creating an `XMLIndex` index that has a structured component that matches the view columns. Such an index projects parts of the XML data onto relational columns, just as the view does. When the columns of the index match the columns of the view, the view is itself indexed.

To simplify the creation of such an `XMLIndex` index, you can PL/SQL function `DBMS_XMLSTORAGE_MANAGE.getSIDXDefFromView` to provide exactly the `XMLTable` expression needed for creating the index. That is the sole purpose of this function: to return an `XMLTable` expression that you can use to create an `XMLIndex` index for a relational view. It takes the view as argument and returns a `CLOB` instance. [Example 9-3](#) (page 9-4) illustrates this.

[Example 9-4](#) (page 9-4) shows the `XMLTable` expression used in [Example 9-3](#) (page 9-4).

See Also:

- [Use of XMLIndex with a Structured Component](#) (page 6-26)
 - *Oracle Database PL/SQL Packages and Types Reference* for information about PL/SQL function `DBMS_XMLSTORAGE_MANAGE.getSIDXDefFromView`
-
-

Example 9-3 XMLIndex Index that Matches Relational View Columns

```
CALL DBMS_XMLINDEX.registerParameter(
    'my_param',
    DBMS_XMLSTORAGE_MANAGE.getSIDXDefFromView('PURCHASEORDER_MASTER_VIEW'));11

CREATE INDEX my_idx on po_binaryxml (OBJECT_VALUE) INDEXTYPE IS XDB.XMLIndex
    PARAMETERS ('PARAM my_param');
```

Example 9-4 XMLTable Expression Returned by PL/SQL Function getSIDXDefFromView

```
SELECT DBMS_XMLSTORAGE_MANAGE.getSIDXDefFromView('PURCHASEORDER_MASTER_VIEW')
    FROM DUAL;

XMLTABLE po_binaryxml_XTAB_1 '//PurchaseOrder' PASSING OBJECT_VALUE
    COLUMNS
        reference          VARCHAR2    (30) PATH 'Reference',
        requestor          VARCHAR2    (128) PATH 'Requestor',
        userid              VARCHAR2    (10) PATH 'User',
        costcenter          VARCHAR2    (4) PATH 'CostCenter',
        ship_to_name        VARCHAR2    (20) PATH 'ShippingInstructions/name',
        ship_to_address     VARCHAR2    (256) PATH 'ShippingInstructions/address',
        ship_to_phone       VARCHAR2    (24) PATH 'ShippingInstructions/telephone',
        instructions        VARCHAR2    (2048) PATH 'SpecialInstructions'
```

¹¹ The view-name argument to `getSIDXDefFromView` must be uppercase, because that is how the name is recorded.

9.5 Querying XML Content As Relational Data

Examples here show relational queries of XML data. They illustrate some of the benefits provided by creating relational views over XMLType tables and columns.

[Example 9-5](#) (page 9-5) and [Example 9-6](#) (page 9-5) show how to query master and detail relational views of XML data. [Example 9-5](#) (page 9-5) queries the master view to select the rows where column `userid` starts with `S`.

[Example 9-6](#) (page 9-5) joins the master view and the detail view. It selects the `purchaseorder_detail_view` rows where the value of column `itemno` is 1 and the corresponding `purchaseorder_master_view` row contains a `userid` column with the value `SBELL`.

[Example 9-7](#) (page 9-6) shows how to use relational views over XML content to perform business-intelligence queries on XML documents. The example query selects `PurchaseOrder` documents that contain orders for titles identified by UPC codes 715515009058 and 715515009126.

The query in [Example 9-7](#) (page 9-6) determines the number of copies of each film title that are ordered in each `PurchaseOrder` document. For example, for part number 715515009126, there are four `PurchaseOrder` documents where one copy of the item is ordered and seven `PurchaseOrder` documents where three copies of the item are ordered.

Example 9-5 Querying Master Relational View of XML Data

```
SELECT reference, costcenter, ship_to_name
   FROM purchaseorder_master_view
   WHERE userid LIKE 'S%';
```

REFERENCE	COST	SHIP_TO_NAME
SBELL-20021009123336231PDT	S30	Sarah J. Bell
SBELL-20021009123336331PDT	S30	Sarah J. Bell
SKING-20021009123336321PDT	A10	Steven A. King
...		

36 rows selected.

Example 9-6 Querying Master and Detail Relational Views of XML Data

```
SELECT d.reference, d.itemno, d.partno, d.description
   FROM purchaseorder_detail_view d, purchaseorder_master_view m
   WHERE m.reference = d.reference
         AND m.userid = 'SBELL'
         AND d.itemno = 1;
```

REFERENCE	ITEMNO	PARTNO	DESCRIPTION
SBELL-20021009123336231PDT	1	37429165829	Juliet of the Spirits
SBELL-20021009123336331PDT	1	715515009225	Salo
SBELL-20021009123337353PDT	1	37429141625	The Third Man
SBELL-20021009123338304PDT	1	715515009829	Nanook of the North
SBELL-20021009123338505PDT	1	37429122228	The 400 Blows
SBELL-20021009123335771PDT	1	37429139028	And the Ship Sails on
SBELL-20021009123335280PDT	1	715515011426	All That Heaven Allows
SBELL-2002100912333763PDT	1	715515010320	Life of Brian - Python
SBELL-2002100912333601PDT	1	715515009058	A Night to Remember
SBELL-20021009123336362PDT	1	715515012928	In the Mood for Love
SBELL-20021009123336532PDT	1	37429162422	Wild Strawberries
SBELL-20021009123338204PDT	1	37429168820	Red Beard

SBELL-20021009123337673PDT 1 37429156322 Cries and Whispers

13 rows selected.

Example 9-7 Business-Intelligence Query of XML Data Using a View

```
SELECT partno, count(*) "No of Orders", quantity "No of Copies"
FROM purchaseorder_detail_view
WHERE partno IN (715515009126, 715515009058)
GROUP BY rollup(partno, quantity);
```

PARTNO	No of Orders	No of Copies
715515009058	7	1
715515009058	9	2
715515009058	5	3
715515009058	2	4
715515009058	23	
715515009126	4	1
715515009126	7	3
715515009126	11	
	34	

9 rows selected.

XMLType Views

You can create `XMLType` views over relational and object-relational data.

- [What Are XMLType Views?](#) (page 10-1)
- [Creating Non-Schema-Based XMLType Views](#) (page 10-2)
- [Creating XML Schema-Based XMLType Views](#) (page 10-3)
- [Creating XMLType Views from XMLType Tables](#) (page 10-17)
- [Referencing XMLType View Objects Using SQL Function REF](#) (page 10-17)
- [Using DML \(Data Manipulation Language\) on XMLType Views](#) (page 10-18)

10.1 What Are XMLType Views?

`XMLType` views wrap existing relational and object-relational data in XML formats. This lets you use existing data in contexts that expect XML data and exploit XML features, including XML Schema.

The major advantages of using `XMLType` views are:

- You can exploit Oracle XML DB XML features that use XML Schema functionality without having to migrate your base legacy data.
- With `XMLType` views, you can experiment with various forms of storage for your data. You need not decide immediately whether to store it as `XMLType` or which `XMLType` storage model to use.

`XMLType` views are similar to object views. Each row of an `XMLType` view corresponds to an `XMLType` instance. The object identifier for uniquely identifying each row in the view can be created using SQL/XML functions `XMLCast` and `XMLQuery`.

Throughout this chapter XML schema refers to the W3C XML Schema 1.0 recommendation, <http://www.w3.org/XML/Schema>.

There are two types of `XMLType` views:

- **Non-schema-based XMLType views.** These views do not conform to a particular XML schema.
- **XML schema-based XMLType views.** As with `XMLType` tables, `XMLType` views that conform to a particular XML schema are called XML schema-based `XMLType` views. These provide stronger typing than non-schema-based `XMLType` views.

XPath rewrite of queries over `XMLType` views is enabled for both XML schema-based and non-schema-based `XMLType` views. XPath rewrite is described in [XPath Rewrite for Object-Relational Storage](#) (page 19-1).

To create an XML schema-based XMLType view, first register your XML schema. If the view is an object view, that is, if it is constructed using an object type, then the XML schema should have annotations that represent the bidirectional mapping from XML to SQL object types. XMLType views conforming to this registered XML schema can then be created by providing an underlying query that constructs instances of the appropriate SQL object type.

See Also:

- [XML Schema Storage and Query: Basic](#) (page 17-1)
 - [Relational Views over XML Data](#) (page 9-1)
 - [Choice of XMLType Storage and Indexing](#) (page 16-1)
-
-

You can create XMLType views in any of the following ways:

- Based on SQL/XML publishing functions, such as XMLElement, XMLForest, XMLConcat, and XMLAgg. SQL/XML publishing functions can be used to construct both non-schema-based XMLType views and XML schema-based XMLType views. This enables construction of XMLType view from the underlying relational tables directly without physically migrating those relational legacy data into XML. However, to construct XML schema-based XMLType view, the XML schema must be registered and the XML value generated by SQL/XML publishing functions must be constrained to the XML schema.
- Based on object types or object views. This enables the construction of the XMLType view from underlying relational or object relational tables directly without physically migrating the relational or object relational legacy data into XML. Creating an XML-schema-based XMLType view requires that you annotate the XML schema with a mapping to existing object types or that you generate the XML schema from the existing object types.
- Directly from an XMLType table.

10.2 CREATE VIEW for XMLType Views: Syntax

The syntax for the CREATE VIEW clause for creating XMLType views is presented.

Figure 10-1 (page 10-2) shows this syntax. See *Oracle Database SQL Language Reference* for details on the CREATE VIEW syntax.

Figure 10-1 Creating XMLType Views Clause: Syntax

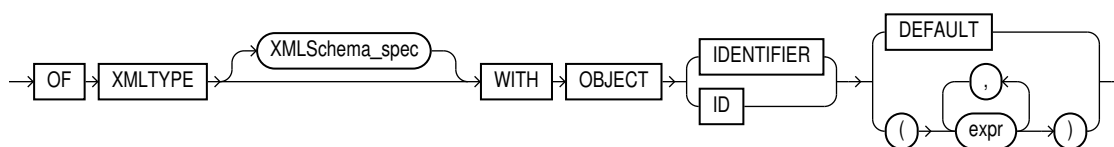

10.3 Creating Non-Schema-Based XMLType Views

The XML data in a non XML Schema-based XMLType view is not constrained to conform to a registered XML schema. You can create a non-schema-based XMLType view using SQL/XML publishing functions.

Example 10-1 (page 10-3) shows how to create an XMLType view using SQL/XML function XMLElement.

Existing data in relational tables or views can be exposed as XML data this way. If a view is generated using a SQL/XML publishing function then queries that access that view using XQuery expressions can often be rewritten. These optimized queries can then directly access the underlying relational columns. See [XPath Rewrite for Object-Relational Storage](#) (page 19-1) for details.

You can perform a DML operation on an XMLType view, but, in general, you must write instead-of triggers to handle the DML operation.

See Also:

[Generation of XML Data from Relational Data](#) (page 8-1), for details on SQL/XML publishing functions

Example 10-1 Creating an XMLType View Using XMLELEMENT

```
CREATE OR REPLACE VIEW emp_view OF XMLType
  WITH OBJECT ID (XMLCast(XMLQuery('/Emp/@empno'
                                PASSING OBJECT_VALUE RETURNING CONTENT)
                          AS BINARY_DOUBLE)) AS
  SELECT XMLElement("Emp",
                   XMLAttributes(employee_id AS "empno"),
                   XMLForest(e.first_name || ' ' || e.last_name AS "name",
                             e.hire_date AS "hiredate"))
  AS "result" FROM employees e WHERE salary > 15000;
```

```
SELECT * FROM emp_view;
```

```
SYS_NC_ROWINFO$
```

```
-----
<Emp empno="100"><name>Steven King</name><hiredate>2003-06-17</hiredate></Emp>
<Emp empno="101"><name>Neena Kochhar</name><hiredate>2005-09-21</hiredate></Emp>
<Emp empno="102"><name>Lex De Haan</name><hiredate>2001-01-13</hiredate></Emp>
```

10.4 Creating XML Schema-Based XMLType Views

The XML data in an XML Schema-based XMLType view is constrained to conform to an XML schema. You can create a schema-based XMLType view using SQL/XML publishing functions or using object types or views.

Create a schema-based view in either of these ways:

- Using SQL/XML publishing functions.

See Also:

[Creating XML Schema-Based XMLType Views Using SQL/XML Publishing Functions](#) (page 10-4)

- Using object types or object views. This is convenient when you already have object types, views, and tables that you want to map to XML data.

See Also:

[Creating XML Schema-Based XMLType Views Using Object Types or Object Views](#) (page 10-10)

10.4.1 Creating XML Schema-Based XMLType Views Using SQL/XML Publishing Functions

You can use SQL/XML publishing functions to create an XML Schema-based XMLType view.

1. Create and register the XML schema document that contains the necessary XML structures. You do not need to annotate the XML schema to define the mapping between XML types and SQL object types.
2. Use SQL/XML publishing functions to create an XMLType view that conforms to the XML schema.

These two steps are illustrated in [Example 10-2](#) (page 10-5) and [Example 10-3](#) (page 10-5), respectively.

[Example 10-4](#) (page 10-6) illustrates querying an XMLType view.

[Example 10-2](#) (page 10-5) assumes that you have an XML schema `emp_simple.xsd` that contains XML structures defining an employee. It registers the XML schema with the target location `http://www.oracle.com/emp_simple.xsd`.

When using SQL/XML publishing functions to generate XML schema-based content, you must specify the appropriate namespace information for all of the elements and also indicate the location of the schema using attribute `xsi:schemaLocation`. These can be specified using the `XMLAttributes` clause. [Example 10-3](#) (page 10-5) illustrates this.

Note:

Whenever you use SQL/XML function `XMLAttributes` with an XML schema reference to create an XMLType view, register the XML schema before creating the view, if possible. Otherwise, you must recompile the view after registering the XML schema, in order for the generated documents to be based on the XML schema.

In [Example 10-3](#) (page 10-5), function `XMLElement` creates XML element `Employee`. Function `XMLForest` creates the children of element `Employee`. The `XMLAttributes` clause inside `XMLElement` constructs the required XML namespace and schema location attributes, so that the XML data that is generated conforms to the XML schema of the view. The innermost call to `XMLForest` creates the children of element `department`, which is a child of element `Employee`.

By default, the XML generation functions create a non-schema-based XML instance. However, when the schema location is specified, using attribute `xsi:schemaLocation` or `xsi:noNamespaceSchemaLocation`, Oracle XML DB generates XML schema-based XML data. For XMLType views, as long as the names of the elements and attributes match those in the XML schema, the XML data is converted implicitly into a valid XML schema-based document. Any errors in the generated XML data are caught later, when operations such as validation or extraction operations are performed on the XML instance.

[Example 10-4](#) (page 10-6) queries the XMLType view, returning an XML result from tables `employees` and `departments`. The result of the query is shown pretty-printed, for clarity.

Example 10-2 Registering XML Schema emp_simple.xsd

```

BEGIN
  DBMS_XMLSCHEMA.registerSchema(
    SCHEMAURL => 'http://www.oracle.com/emp_simple.xsd',
    SCHEMADOC => '<schema xmlns="http://www.w3.org/2001/XMLSchema"
      targetNamespace="http://www.oracle.com/emp_simple.xsd"
      version="1.0"
      xmlns:xdb="http://xmlns.oracle.com/xdb"
      elementFormDefault="qualified">
    <element name = "Employee">
      <complexType>
        <sequence>
          <element name = "EmployeeId"
            type = "positiveInteger" minOccurs = "0"/>
          <element name = "Name"
            type = "string" minOccurs = "0"/>
          <element name = "Job"
            type = "string" minOccurs = "0"/>
          <element name = "Manager"
            type = "positiveInteger" minOccurs = "0"/>
          <element name = "HireDate"
            type = "date" minOccurs = "0"/>
          <element name = "Salary"
            type = "positiveInteger" minOccurs = "0"/>
          <element name = "Commission"
            type = "positiveInteger" minOccurs = "0"/>
          <element name = "Dept">
            <complexType>
              <sequence>
                <element name = "DeptNo"
                  type = "positiveInteger" minOccurs = "0"/>
                <element name = "DeptName"
                  type = "string" minOccurs = "0"/>
                <element name = "Location"
                  type = "positiveInteger" minOccurs = "0"/>
              </sequence>
            </complexType>
          </element>
        </sequence>
      </complexType>
    </element>
  </schema>',
    LOCAL      => TRUE,
    GENTYPES   => TRUE);
END;

```

Example 10-3 Creating an XMLType View Using SQL/XML Publishing Functions

```

CREATE OR REPLACE VIEW emp_simple_xml OF XMLType
XMLSCHEMA "http://www.oracle.com/emp_simple.xsd" ELEMENT "Employee"
WITH OBJECT ID (XMLCast(XMLQuery('/Employee/EmployeeId/text()')
      PASSING OBJECT_VALUE
      RETURNING CONTENT)
      AS BINARY_DOUBLE)) AS
SELECT
  XMLElement("Employee",
    XMLAttributes(
      'http://www.oracle.com/emp_simple.xsd' AS "xmlns" ,
      'http://www.w3.org/2001/XMLSchema-instance' AS "xmlns:xsi",
      'http://www.oracle.com/emp_simple.xsd'
      http://www.oracle.com/emp_simple.xsd'

```

```

        AS "xsi:schemaLocation"),
XMLForest(e.employee_id AS "EmployeeId",
          e.last_name AS "Name",
          e.job_id AS "Job",
          e.manager_id AS "Manager",
          e.hire_date AS "HireDate",
          e.salary AS "Salary",
          e.commission_pct AS "Commission",
          XMLForest(
            d.department_id AS "DeptNo",
            d.department_name AS "DeptName",
            d.location_id AS "Location") AS "Dept"))
FROM employees e, departments d
WHERE e.department_id = d.department_id;

```

Example 10-4 Querying an XMLType View

```
SELECT OBJECT_VALUE AS RESULT FROM emp_simple_xml WHERE ROWNUM < 2;
```

RESULT

```

-----
<Employee xmlns="http://www.oracle.com/emp_simple.xsd"
  xmlns:xsi="http://www.w3.org/2001/XMLSchema-instance"
  xsi:schemaLocation="http://www.oracle.com/emp_simple.xsd
    http://www.oracle.com/emp_simple.xsd">
  <EmployeeId>200</EmployeeId>
  <Name>Whalen</Name>
  <Job>AD_ASST</Job>
  <Manager>101</Manager>
  <HireDate>2003-09-17</HireDate>
  <Salary>4400</Salary>
  <Dept>
    <DeptNo>10</Deptno>
    <DeptName>Administration</DeptName>
    <Location>1700</Location>
  </Dept>
</Employee>

```

10.4.1.1 Using Namespaces with SQL/XML Publishing Functions

If you have complex XML schemas involving namespaces, you must use the partially escaped mapping provided by the SQL/XML publishing functions and create elements with appropriate namespaces and prefixes.

The query in [Example 10-5](#) (page 10-6) creates XML instances that have the correct namespace, prefixes, and target schema location. It can be used as the query in the definition of view `emp_simple_xml`.

If the XML schema had no target namespace, then you could use attribute `xsi:noNamespaceSchemaLocation` to indicate that. [Example 10-6](#) (page 10-7) shows such an XML schema.

[Example 10-7](#) (page 10-8) creates a view that conforms to the XML schema in [Example 10-6](#) (page 10-7). The `XMLAttributes` clause creates an XML element that contains the `noNamespace` schema location attribute.

[Example 10-8](#) (page 10-8) creates view `dept_xml`, which conforms to XML schema `dept.xsd`.

Example 10-5 Using Namespace Prefixes with SQL/XML Publishing Functions

```

SELECT XMLElement("ipo:Employee",
  XMLAttributes('http://www.oracle.com/emp_simple.xsd' AS "xmlns:ipo",

```

```

        'http://www.oracle.com/emp_simple.xsd
        http://www.oracle.com/emp_simple.xsd' AS "xmlns:xsi"),
XMLForest(e.employee_id          AS "ipo:EmployeeId",
e.last_name                     AS "ipo:Name",
e.job_id                        AS "ipo:Job",
e.manager_id                    AS "ipo:Manager",
TO_CHAR(e.hire_date,'YYYY-MM-DD') AS "ipo:HireDate",
e.salary                        AS "ipo:Salary",
e.commission_pct                AS "ipo:Commission",
XMLForest(d.department_id AS "ipo:DeptNo",
d.department_name AS "ipo:DeptName", d.location_id
AS "ipo:Location") AS "ipo:Dept"))
FROM employees e, departments d
WHERE e.department_id = d.department_id AND d.department_id = 20;

BEGIN
  -- Delete schema if it already exists (else error)
  DBMS_XMLSCHEMA.deleteSchema('emp-noname.xsd', 4);
END;

XMLELEMENT("IPO:EMPLOYEE", XMLATTRIBUTES('HTTP://WWW.ORACLE.COM/EMP_SIMPLE.XSD' AS
-----
<ipo:Employee
xmlns:ipo="http://www.oracle.com/emp_simple.xsd"
  xmlns:xsi="http://www.oracle.com/emp_simple.xsd"
  http://www.oracle.com/emp_simple.xsd">
<ipo:EmployeeId>201</ipo:EmployeeId><ipo:Name>Hartstein</ipo:Name>
<ipo:Job>MK_MAN</ipo:Job><ipo:Manager>100</ipo:Manager>
<ipo:HireDate>2004-02-17</ipo:HireDate><ipo:Salary>13000</ipo:Salary>
<ipo:Dept><ipo:DeptNo>20</ipo:DeptNo><ipo:DeptName>Marketing</ipo:DeptName>
<ipo:Location>1800</ipo:Location></ipo:Dept></ipo:Employee>
<ipo:Employee xmlns:ipo="http://www.oracle.com/emp_simple.xsd"
  xmlns:xsi="http://www.oracle.com/emp_simple.xsd"
  http://www.oracle.com/emp_simple.xsd"><ipo:EmployeeId>202</ipo:EmployeeId>
<ipo:Name>Fay</ipo:Name><ipo:Job>MK_REP</ipo:Job><ipo:Manager>201</ipo:Manager>
<ipo:HireDate>2005-08-17</ipo:HireDate><ipo:Salary>6000</ipo:Salary>
<ipo:Dept><ipo:DeptNo>20</ipo:Dept
No><ipo:DeptName>Marketing</ipo:DeptName><ipo:Location>1800</ipo:Location>
</ipo:Dept>
</ipo:Employee>

```

Example 10-6 XML Schema with No Target Namespace

```

BEGIN
  DBMS_XMLSCHEMA.registerSchema(
    SCHEMAURL => 'emp-noname.xsd',
    SCHEMADOC => '<schema xmlns="http://www.w3.org/2001/XMLSchema"
      xmlns:xdb="http://xmlns.oracle.com/xdb">
      <element name = "Employee">
        <complexType>
          <sequence>
            <element name = "EmployeeId" type = "positiveInteger"/>
            <element name = "Name" type = "string"/>
            <element name = "Job" type = "string"/>
            <element name = "Manager" type = "positiveInteger"/>
            <element name = "HireDate" type = "date"/>
            <element name = "Salary" type = "positiveInteger"/>
            <element name = "Commission" type = "positiveInteger"/>
            <element name = "Dept">
              <complexType>
                <sequence>
                  <element name = "DeptNo" type = "positiveInteger" />

```

```

        <element name = "DeptName" type = "string"/>
        <element name = "Location" type = "positiveInteger"/>
    </sequence>
</complexType>
</element>
</sequence>
</complexType>
</element>
</schema>',
LOCAL      => TRUE,
GENTYPES  => TRUE);
END;
```

Example 10-7 Creating a View for an XML Schema with No Target Namespace

```

CREATE OR REPLACE VIEW emp_xml OF XMLType
XMLSCHEMA "emp-noname.xsd" ELEMENT "Employee"
WITH OBJECT ID (XMLCast(XMLQuery('/Employee/EmployeeId/text()')
    PASSING OBJECT_VALUE
    RETURNING CONTENT)
    AS BINARY_DOUBLE)) AS
SELECT XMLElement(
    "Employee",
    XMLAttributes('http://www.w3.org/2001/XMLSchema-instance' AS "xmlns:xsi",
        'emp-noname.xsd' AS "xsi:noNamespaceSchemaLocation"),
    XMLForest(e.employee_id AS "EmployeeId",
        e.last_name AS "Name",
        e.job_id AS "Job",
        e.manager_id AS "Manager",
        e.hire_date AS "HireDate",
        e.salary AS "Salary",
        e.commission_pct AS "Commission",
        XMLForest(d.department_id AS "DeptNo",
            d.department_name AS "DeptName",
            d.location_id AS "Location") AS "Dept"))
FROM employees e, departments d
WHERE e.department_id = d.department_id;
```

Example 10-8 Using SQL/XML Functions in XML Schema-Based XMLType Views

```

BEGIN
    -- Delete schema if it already exists (else error)
    DBMS_XMLSCHEMA.deleteSchema('http://www.oracle.com/dept.xsd', 4);
END;
/

BEGIN
    DBMS_XMLSCHEMA.registerSchema(
        SCHEMAURL => 'http://www.oracle.com/dept.xsd',
        SCHEMADOC => '<schema xmlns="http://www.w3.org/2001/XMLSchema"
            targetNamespace="http://www.oracle.com/dept.xsd"
            version="1.0"
            xmlns:xdb="http://xmlns.oracle.com/xdb"
            elementFormDefault="qualified">
        <element name = "Department">
            <complexType>
                <sequence>
                    <element name = "DeptNo" type = "positiveInteger"/>
                    <element name = "DeptName" type = "string"/>
                    <element name = "Location" type = "positiveInteger"/>
                    <element name = "Employee" maxOccurs = "unbounded">
                        <complexType>
```

```

        <sequence>
          <element name = "EmployeeId" type = "positiveInteger"/>
          <element name = "Name" type = "string"/>
          <element name = "Job" type = "string"/>
          <element name = "Manager" type = "positiveInteger"/>
          <element name = "HireDate" type = "date"/>
          <element name = "Salary" type = "positiveInteger"/>
          <element name = "Commission" type = "positiveInteger"/>
        </sequence>
      </complexType>
    </element>
  </sequence>
</complexType>
</element>
</schema>',
LOCAL      => TRUE,
GENTYPES  => FALSE);
END;
/

CREATE OR REPLACE VIEW dept_xml OF XMLType
XMLSCHEMA "http://www.oracle.com/dept.xsd" ELEMENT "Department"
WITH OBJECT ID (XMLCast(XMLQuery('/Department/DeptNo'
                                PASSING OBJECT_VALUE RETURNING CONTENT)
                        AS BINARY_DOUBLE)) AS
SELECT XMLElement(
  "Department",
  XMLAttributes(
    'http://www.oracle.com/emp.xsd' AS "xmlns" ,
    'http://www.w3.org/2001/XMLSchema-instance' AS "xmlns:xsi",
    'http://www.oracle.com/dept.xsd'
    http://www.oracle.com/dept.xsd' AS "xsi:schemaLocation"),
  XMLForest(d.department_id AS "DeptNo",
            d.department_name AS "DeptName",
            d.location_id AS "Location"),
  (SELECT XMLagg(
    XMLElement("Employee",
      XMLForest(
        e.employee_id AS "EmployeeId",
        e.last_name AS "Name",
        e.job_id AS "Job",
        e.manager_id AS "Manager",
        to_char(e.hire_date, 'YYYY-MM-DD') AS "Hiredate",
        e.salary AS "Salary",
        e.commission_pct AS "Commission"))
    FROM employees e
    WHERE e.department_id = d.department_id))
  FROM departments d;

```

This is the XMLType instance that results:

```
SELECT OBJECT_VALUE AS result FROM dept_xml WHERE ROWNUM < 2;
```

```
RESULT
```

```

-----
<Department
  xmlns="http://www.oracle.com/emp.xsd"
  xmlns:xsi="http://www.w3.org/2001/XMLSchema-instance"
  xsi:schemaLocation="http://www.oracle.com/dept.xsd
                    http://www.oracle.com/dept.xsd">
  <DeptNo>10</DeptNo>

```

```
<DeptName>Administration</DeptName>
<Location>1700</Location>
<Employee>
  <EmployeeId>200</EmployeeId>
  <Name>Whalen</Name>
  <Job>AD_ASST</Job>
  <Manager>101</Manager>
  <Hiredate>2003-09-17</Hiredate>
  <Salary>4400</Salary>
</Employee>
</Department>
```

10.4.2 Creating XML Schema-Based XMLType Views Using Object Types or Object Views

You can create an XML Schema-based XMLType view from object types or views by annotating the XML schema to define a mapping between XML types and SQL object types and object attributes.

To create an XML Schema-based XMLType view from object types or object views, do the following:

1. Create the object types, if they do not yet exist.
2. Create and then register the XML schema, annotating it to define the mapping between XML types and SQL object types and attributes.

Annotate the XML schema *before* registering it. You typically do this when you wrap existing data to create an XMLType view.

When such an XML schema document is registered, the following validation can occur:

- SQLType for attributes or elements based on simpleType. The SQL type must be compatible with the XML type of the corresponding XMLType data. For example, an XML string data type can be mapped only to a VARCHAR2 or a Large Object (LOB) data type.
- SQLType specified for elements based on complexType. This is either a LOB or an object type whose structure must be compatible with the declaration of the complexType, that is, the object type must have the correct number of attributes with the correct data types.

See:

[XML Schema Storage and Query: Basic](#) (page 17-1)

3. Create the XMLType view, specifying the XML schema URL and the root element name. The query defining the view first constructs the object instances and then converts them to XML.
 - a. Create an object view.
 - b. Create an XMLType view over the object view.

The following sections present examples of creating XML schema-based XMLType views using object types or object views. They are based on relational tables that contain employee and department data.

- [Creating XMLType Employee View, with Nested Department Information](#) (page 10-11)
- [Creating XMLType Department View, with Nested Employee Information](#) (page 10-14)

The same relational data is used to create each of two XMLType views. In the employee view, `emp_xml`, the XML document describes an employee, with the employee's department as nested information. In the department view, `dept_xml`, the XML data describes a department, with the department's employees as nested information.

10.4.2.1 Creating XMLType Employee View, with Nested Department Information

Examples here create XMLType view `emp_xml` based on object views.

For the *last* step of the view creation, there are two *alternatives*:

- [Step 3a. Create XMLType View emp_xml Using Object Type emp_t](#) (page 10-13) – create XMLType view `emp_xml` using object type `emp_t`
- [Step 3b. Create XMLType View emp_xml Using Object View emp_v](#) (page 10-13) – create XMLType view `emp_xml` using object view `emp_v`

10.4.2.1.1 Step 1. Create Object Types for XMLType Employee View

Create an object type for an XML Schema-based view.

[Example 10-9](#) (page 10-11) creates the object types used in the other steps.

Example 10-9 Creating Object Types for Schema-Based XMLType Views

```
CREATE TYPE dept_t AS OBJECT
  (deptno NUMBER(4),
   dname  VARCHAR2(30),
   loc    NUMBER(4));
/

CREATE TYPE emp_t AS OBJECT
  (empno    NUMBER(6),
   ename    VARCHAR2(25),
   job      VARCHAR2(10),
   mgr      NUMBER(6),
   hiredate DATE,
   sal      NUMBER(8,2),
   comm     NUMBER(2,2),
   dept     dept_t);
/
```

10.4.2.1.2 Step 2. Create and Register XML Schema emp_complex.xsd

Create and register an XML schema, `emp_complex.xsd`. The schema maps XML elements and attributes to corresponding object-relational object attributes.

Create XML schema `emp_complex.xsd`, which specifies how XML elements and attributes are mapped to corresponding object attributes in the object types (the `xdb:SQLType` annotations), then register it. [Example 10-10](#) (page 10-12) registers it.

[Example 10-10](#) (page 10-12) creates and registers the XML schema using the target location `http://www.oracle.com/emp_complex.xsd`.

Example 10-10 Creating and Registering XML Schema emp_complex.xsd

```

BEGIN
  -- Delete schema if it already exists (else error)
  DBMS_XMLSCHEMA.deleteSchema('http://www.oracle.com/emp_complex.xsd', 4);
END;
/

COMMIT;

BEGIN
  DBMS_XMLSCHEMA.registerSchema(
    SCHEMAURL => 'http://www.oracle.com/emp_complex.xsd',
    SCHEMADOC => '<?xml version="1.0"?>
      <xsd:schema xmlns:xsd="http://www.w3.org/2001/XMLSchema"
        xmlns:xsi="http://www.w3.org/2001/XMLSchema-instance"
        xmlns:xdb="http://xmlns.oracle.com/xdb"
        xsi:schemaLocation="http://xmlns.oracle.com/xdb
          http://xmlns.oracle.com/xdb/XDBSchema.xsd">
        <xsd:element name="Employee" type="EMP_TType" xdb:SQLType="EMP_T"/>
        <xsd:complexType name="EMP_TType" xdb:SQLType="EMP_T" xdb:maintainDOM="false">
          <xsd:sequence>
            <xsd:element name="EMPNO" type="xsd:double" xdb:SQLName="EMPNO"
              xdb:SQLType="NUMBER"/>
            <xsd:element name="ENAME" xdb:SQLName="ENAME" xdb:SQLType="VARCHAR2">
              <xsd:simpleType>
                <xsd:restriction base="xsd:string">
                  <xsd:maxLength value="25"/>
                </xsd:restriction>
              </xsd:simpleType>
            </xsd:element>
            <xsd:element name="JOB" xdb:SQLName="JOB" xdb:SQLType="VARCHAR2">
              <xsd:simpleType>
                <xsd:restriction base="xsd:string">
                  <xsd:maxLength value="10"/>
                </xsd:restriction>
              </xsd:simpleType>
            </xsd:element>
            <xsd:element name="MGR" type="xsd:double" xdb:SQLName="MGR"
              xdb:SQLType="NUMBER"/>
            <xsd:element name="HIREDATE" type="xsd:date" xdb:SQLName="HIREDATE"
              xdb:SQLType="DATE"/>
            <xsd:element name="SAL" type="xsd:double" xdb:SQLName="SAL"
              xdb:SQLType="NUMBER"/>
            <xsd:element name="COMM" type="xsd:double" xdb:SQLName="COMM"
              xdb:SQLType="NUMBER"/>
            <xsd:element name="DEPT" type="DEPT_TType" xdb:SQLName="DEPT"
              xdb:SQLType="DEPT_T"/>
          </xsd:sequence>
        </xsd:complexType>
        <xsd:complexType name="DEPT_TType" xdb:SQLType="DEPT_T"
          xdb:maintainDOM="false">
          <xsd:sequence>
            <xsd:element name="DEPTNO" type="xsd:double" xdb:SQLName="DEPTNO"
              xdb:SQLType="NUMBER"/>
            <xsd:element name="DNAME" xdb:SQLName="DNAME" xdb:SQLType="VARCHAR2">
              <xsd:simpleType>
                <xsd:restriction base="xsd:string">
                  <xsd:maxLength value="30"/>
                </xsd:restriction>
              </xsd:simpleType>
          </xsd:sequence>
        </xsd:complexType>
      </xsd:schema>
    );
END;

```

```

        </xsd:element>
        <xsd:element name="LOC" type="xsd:double" xdb:SQLName="LOC"
            xdb:SQLType="NUMBER"/>
    </xsd:sequence>
</xsd:complexType>
</xsd:schema>',
LOCAL      => TRUE,
GENTYPES  => FALSE);
END;
/

```

10.4.2.1.3 Step 3a. Create XMLType View emp_xml Using Object Type emp_t

Create an XMLType view using an object type.

[Example 10-11](#) (page 10-13) creates an XMLType view using object type emp_t.

[Example 10-11](#) (page 10-13) uses SQL/XML function XMLCast in the OBJECT ID clause to convert the XML employee number to SQL data type BINARY_DOUBLE.

See Also:

[Step 3b. Create XMLType View emp_xml Using Object View emp_v](#) (page 10-13) for an alternative way to create view emp_xml, which uses object view emp_v

Example 10-11 Creating XMLType View emp_xml Using Object Type emp_t

```

CREATE OR REPLACE VIEW emp_xml OF XMLType
XMLSCHEMA "http://www.oracle.com/emp_complex.xsd"
ELEMENT "Employee"
WITH OBJECT ID (XMLCast(XMLQuery('/Employee/EMPNO'
                                PASSING OBJECT_VALUE RETURNING CONTENT)
                        AS BINARY_DOUBLE)) AS
SELECT emp_t(e.employee_id, e.last_name, e.job_id, e.manager_id, e.hire_date,
            e.salary, e.commission_pct,
            dept_t(d.department_id, d.department_name, d.location_id))
FROM employees e, departments d
WHERE e.department_id = d.department_id;

```

10.4.2.1.4 Step 3b. Create XMLType View emp_xml Using Object View emp_v

Create an XMLType view using an object view.

[Example 10-12](#) (page 10-13) creates object view emp_v and then creates XMLType view emp_xml based on that object view.

See Also:

[Step 3a. Create XMLType View emp_xml Using Object Type emp_t](#) (page 10-13) for an alternative way to create view emp_xml, which uses object type emp_t

Example 10-12 Creating an Object View and an XMLType View Based on the Object View

```

CREATE OR REPLACE VIEW emp_v OF emp_t WITH OBJECT ID (empno) AS
SELECT emp_t(e.employee_id, e.last_name, e.job_id, e.manager_id, e.hire_date,
            e.salary, e.commission_pct,

```

```

        dept_t(d.department_id, d.department_name, d.location_id))
    FROM employees e, departments d
    WHERE e.department_id = d.department_id;

CREATE OR REPLACE VIEW emp_xml OF XMLType
    XMLSCHEMA "http://www.oracle.com/emp_complex.xsd" ELEMENT "Employee"
    WITH OBJECT ID DEFAULT AS
    SELECT VALUE(p) FROM emp_v p;

```

10.4.2.2 Creating XMLType Department View, with Nested Employee Information

XMLType view dept_xml is created so that each department in the view contains nested employee information.

For the *last* step of the view creation, there are two *alternatives*:

- [Step 3a. Create XMLType View dept_xml Using Object Type dept_t](#) (page 10-16) – create XMLType view dept_xml using the object type for a department, dept_t
- [Step 3b. Create XMLType View dept_xml Using Relational Data Directly](#) (page 10-16) – create XMLType view dept_xml using relational data directly

10.4.2.2.1 Step 1. Create Object Types for XMLType Department View

Create an object type for an XML Schema-based view.

[Example 10-13](#) (page 10-14) creates the object types used in the other steps.

Example 10-13 Creating Object Types

```

CREATE TYPE emp_t AS OBJECT (empno    NUMBER(6),
                           ename     VARCHAR2(25),
                           job       VARCHAR2(10),
                           mgr       NUMBER(6),
                           hiredate  DATE,
                           sal       NUMBER(8,2),
                           comm      NUMBER(2,2)); /

CREATE OR REPLACE TYPE emplist_t AS TABLE OF emp_t;
/

CREATE TYPE dept_t AS OBJECT (deptno  NUMBER(4),
                              dname   VARCHAR2(30),
                              loc     NUMBER(4),
                              emps    emplist_t);
/

```

10.4.2.2.2 Step 2. Register XML Schema dept_complex.xsd

Register XML schema dept_complex.xsd.

[Example 10-14](#) (page 10-14) illustrates this.

Example 10-14 Registering XML Schema dept_complex.xsd

```

BEGIN
    -- Delete schema if it already exists (else error)
    DBMS_XMLSCHEMA.deleteSchema('http://www.oracle.com/dept_complex.xsd', 4);
END;
/

BEGIN
    DBMS_XMLSCHEMA.registerSchema(
        SCHEMAURL => 'http://www.oracle.com/dept_complex.xsd',

```

```

SCHEMADOC => '<?xml version="1.0"?>
  <xsd:schema xmlns:xsd="http://www.w3.org/2001/XMLSchema"
    xmlns:xsi="http://www.w3.org/2001/XMLSchema-instance"
    xmlns:xdb="http://xmlns.oracle.com/xdb"
    xsi:schemaLocation="http://xmlns.oracle.com/xdb
      http://xmlns.oracle.com/xdb/XDBSchema.xsd">
    <xsd:element name="Department" type="DEPT_TType" xdb:SQLType="DEPT_T"/>
    <xsd:complexType name="DEPT_TType" xdb:SQLType="DEPT_T"
      xdb:maintainDOM="false">
      <xsd:sequence>
        <xsd:element name="DEPTNO" type="xsd:double" xdb:SQLName="DEPTNO"
          xdb:SQLType="NUMBER"/>
        <xsd:element name="DNAME" xdb:SQLName="DNAME" xdb:SQLType="VARCHAR2">
          <xsd:simpleType>
            <xsd:restriction base="xsd:string">
              <xsd:maxLength value="30"/>
            </xsd:restriction>
          </xsd:simpleType>
        </xsd:element>
        <xsd:element name="LOC" type="xsd:double" xdb:SQLName="LOC"
          xdb:SQLType="NUMBER"/>
        <xsd:element name="EMPS" type="EMP_TType" maxOccurs="unbounded"
          minOccurs="0" xdb:SQLName="EMPS"
          xdb:SQLCollType="EMPLIST_T" xdb:SQLType="EMP_T"
          xdb:SQLCollSchema="HR"/>
      </xsd:sequence>
    </xsd:complexType>
    <xsd:complexType name="EMP_TType" xdb:SQLType="EMP_T" xdb:maintainDOM="false">
      <xsd:sequence>
        <xsd:element name="EMPNO" type="xsd:double" xdb:SQLName="EMPNO"
          xdb:SQLType="NUMBER"/>
        <xsd:element name="ENAME" xdb:SQLName="ENAME" xdb:SQLType="VARCHAR2">
          <xsd:simpleType>
            <xsd:restriction base="xsd:string">
              <xsd:maxLength value="25"/>
            </xsd:restriction>
          </xsd:simpleType>
        </xsd:element>
        <xsd:element name="JOB" xdb:SQLName="JOB" xdb:SQLType="VARCHAR2">
          <xsd:simpleType>
            <xsd:restriction base="xsd:string">
              <xsd:maxLength value="10"/>
            </xsd:restriction>
          </xsd:simpleType>
        </xsd:element>
        <xsd:element name="MGR" type="xsd:double" xdb:SQLName="MGR"
          xdb:SQLType="NUMBER"/>
        <xsd:element name="HIREDATE" type="xsd:date" xdb:SQLName="HIREDATE"
          xdb:SQLType="DATE"/>
        <xsd:element name="SAL" type="xsd:double" xdb:SQLName="SAL"
          xdb:SQLType="NUMBER"/>
        <xsd:element name="COMM" type="xsd:double" xdb:SQLName="COMM"
          xdb:SQLType="NUMBER"/>
      </xsd:sequence>
    </xsd:complexType>
  </xsd:schema>',
  LOCAL => TRUE,
  GENTYPES => FALSE);
END;
/

```

10.4.2.2.3 Step 3a. Create XMLType View dept_xml Using Object Type dept_t

Create XMLType view dept_xml using object type dept_t.

[Example 10-15](#) (page 10-16) illustrates this.

Example 10-15 Creating XMLType View dept_xml Using Object Type dept_t

```
CREATE OR REPLACE VIEW dept_xml OF XMLType
  XMLSCHEMA "http://www.oracle.com/dept_complex.xsd" ELEMENT "Department"
  WITH OBJECT ID (XMLCast(XMLQuery('/Department/DEPTNO'
    PASSING OBJECT_VALUE RETURNING CONTENT)
    AS BINARY_DOUBLE)) AS
  SELECT dept_t(d.department_id, d.department_name, d.location_id,
    cast(MULTISET
      (SELECT emp_t(e.employee_id, e.last_name, e.job_id,
        e.manager_id, e.hire_date,
        e.salary, e.commission_pct)
      FROM employees e WHERE e.department_id = d.department_id)
    AS emplist_t))
  FROM departments d;
```

10.4.2.2.4 Step 3b. Create XMLType View dept_xml Using Relational Data Directly

You can use SQL/XML publishing functions to create XMLType view dept_xml from the relational tables without using object type dept_t.

[Example 10-16](#) (page 10-16) illustrates this.

Note:

XML schema and element information must be specified at the view level, because the SELECT list could arbitrarily construct XML of a different XML schema from the underlying table.

Example 10-16 Creating XMLType View dept_xml Using Relational Data Directly

```
CREATE OR REPLACE VIEW dept_xml OF XMLType
  XMLSCHEMA "http://www.oracle.com/dept_complex.xsd" ELEMENT "Department"
  WITH OBJECT ID (XMLCast(XMLQuery('/Department/DEPTNO'
    PASSING OBJECT_VALUE RETURNING CONTENT)
    AS BINARY_DOUBLE)) AS
  SELECT
    XMLElement(
      "Department",
      XMLAttributes('http://www.oracle.com/dept_complex.xsd' AS "xmlns",
        'http://www.w3.org/2001/XMLSchema-instance' AS "xmlns:xsi",
        'http://www.oracle.com/dept_complex.xsd'
        'http://www.oracle.com/dept_complex.xsd'
        AS "xsi:schemaLocation"),
      XMLForest(d.department_id "DeptNo", d.department_name "DeptName",
        d.location_id "Location"),
      (SELECT XMLAgg(XMLElement("Employee",
        XMLForest(e.employee_id "EmployeeId",
          e.last_name "Name",
          e.job_id "Job",
          e.manager_id "Manager",
          e.hire_date "Hiredate",
          e.salary "Salary",
          e.commission_pct "Commission"))))
```

```
FROM employees e WHERE e.department_id = d.department_id))
FROM departments d;
```

10.5 Creating XMLType Views from XMLType Tables

An XMLType view can be created on an XMLType table, for example, to transform the XML data or to restrict the rows returned.

[Example 10-17](#) (page 10-17) creates an XMLType view by restricting the rows included from an underlying XMLType table. It uses XML schema `dept_complex.xsd` to create the underlying table — see [Creating XMLType Department View, with Nested Employee Information](#) (page 10-14).

[Example 10-18](#) (page 10-17) shows how you can create an XMLType view by transforming XML data using an XSL stylesheet.

See Also:

[SQL Function XMLTRANSFORM and XMLType Method TRANSFORM\(\)](#)
(page 7-3)

Example 10-17 *Creating an XMLType View by Restricting Rows from an XMLType Table*

```
CREATE TABLE dept_xml_tab OF XMLType
  XMLSchema "http://www.oracle.com/dept_complex.xsd" ELEMENT "Department"
  NESTED TABLE XMLDATA."EMPS" STORE AS dept_xml_tab_tabl;

CREATE OR REPLACE VIEW dallas_dept_view OF XMLType
  XMLSchema "http://www.oracle.com/dept.xsd" ELEMENT "Department"
  AS SELECT OBJECT_VALUE FROM dept_xml_tab
     WHERE XMLCast(XMLQuery('/Department/LOC'
                           PASSING OBJECT_VALUE RETURNING CONTENT)
                 AS VARCHAR2(20))
     = 'DALLAS';
```

Here, `dallas_dept_view` restricts the XMLType table rows to those departments whose location is Dallas.

Example 10-18 *Creating an XMLType View by Transforming an XMLType Table*

```
CREATE OR REPLACE VIEW hr_po_tab OF XMLType
  ELEMENT "PurchaseOrder" WITH OBJECT ID DEFAULT AS
  SELECT XMLtransform(OBJECT_VALUE, x.coll)
  FROM purchaseorder p, xsl_tab x;
```

10.6 Referencing XMLType View Objects Using SQL Function REF

You can reference an XMLType view object using SQL function `ref`.

```
SELECT ref(d) FROM dept_xml_tab d;
```

An XMLType view reference is based on one of the following object IDs:

- System-generated OID — for views on XMLType tables or object views
- Primary key based OID -- for views with `OBJECT ID` expressions

These REFs can be used to fetch OCIXMLType instances in the OCI Object cache, or they can be used in SQL queries. These REFs act the same as REFs to object views.

10.7 Using DML (Data Manipulation Language) on XMLType Views

A given XMLType view might not be implicitly updatable. In that case, you must write instead-of triggers to handle all DML. To determine whether an XMLType view is implicitly updatable, query it to see whether it is based on an object view or constructor that is itself inherently updatable.

[Example 10-19](#) (page 10-18) illustrates this.

Example 10-19 Determining Whether an XMLType View Is Implicitly Updatable, and Updating It

```
CREATE TYPE dept_t AS OBJECT
  (deptno NUMBER(4),
   dname VARCHAR2(30),
   loc NUMBER(4));
/

BEGIN
  -- Delete schema if it already exists (else error)
  DBMS_XMLSCHEMA.deleteSchema('http://www.oracle.com/dept_t.xsd', 4);
END;
/
COMMIT;

BEGIN
  DBMS_XMLSCHEMA.registerSchema(
    SCHEMAURL => 'http://www.oracle.com/dept_t.xsd',
    SCHEMADOC => '<?xml version="1.0"?>
      <xsd:schema xmlns:xsd="http://www.w3.org/2001/XMLSchema"
        xmlns:xsi="http://www.w3.org/2001/XMLSchema-instance"
        xmlns:xdb="http://xmlns.oracle.com/xdb"
        xsi:schemaLocation="http://xmlns.oracle.com/xdb
          http://xmlns.oracle.com/xdb/XDBSchema.xsd">
      <xsd:element name="Department" type="DEPT_TType" xdb:SQLType="DEPT_T"/>
      <xsd:complexType name="DEPT_TType" xdb:SQLType="DEPT_T"
        xdb:maintainDOM="false">
      <xsd:sequence>
      <xsd:element name="DEPTNO" type="xsd:double" xdb:SQLName="DEPTNO"
        xdb:SQLType="NUMBER"/>
      <xsd:element name="DNAME" xdb:SQLName="DNAME" xdb:SQLType="VARCHAR2">
      <xsd:simpleType>
      <xsd:restriction base="xsd:string">
      <xsd:maxLength value="30"/>
      </xsd:restriction>
      </xsd:simpleType>
      </xsd:element>
      <xsd:element name="LOC" type="xsd:double" xdb:SQLName="LOC"
        xdb:SQLType="NUMBER"/>
      </xsd:sequence>
      </xsd:complexType>
    </xsd:schema>',
    LOCAL      => TRUE,
    GENTYPES   => FALSE);
END;
/

CREATE OR REPLACE VIEW dept_xml OF XMLType
  XMLSchema "http://www.oracle.com/dept_t.xsd" element "Department"
  WITH OBJECT ID (XMLCast(XMLQuery('/Department/DEPTNO'
    PASSING OBJECT_VALUE RETURNING CONTENT)
    AS BINARY_DOUBLE)) AS
```



```
SELECT dept_t(d.department_id, d.department_name, d.location_id)
FROM departments d;

INSERT INTO dept_xml
VALUES (
XMLType.createXML(
'<Department
  xmlns:xsi="http://www.w3.org/2001/XMLSchema-instance"
  xsi:noNamespaceSchemaLocation="http://www.oracle.com/dept_t.xsd" >
  <DEPTNO>300</DEPTNO>
  <DNAME>Processing</DNAME>
  <LOC>1700</LOC>
</Department>');

UPDATE dept_xml d
SET d.OBJECT_VALUE =
XMLQuery('copy $i := $p1 modify
  (for $j in $i/Department/DNAME
    return replace value of node $j with $p2)
  return $i'
  PASSING d.OBJECT_VALUE AS "p1", 'Shipping' AS "p2" RETURNING CONTENT)
WHERE XMLEExists('/Department[DEPTNO=300]' PASSING OBJECT_VALUE);
```

Part IV

XMLType APIs

You can use Oracle XML DB `XMLType` PL/SQL, Java, C APIs, and Oracle Data Provider for .NET (ODP.NET) to access and manipulate XML data.

- [PL/SQL APIs for XMLType](#) (page 11-1)
- [PL/SQL Package DBMS_XMLSTORE](#) (page 12-1)
- [Java DOM API for XMLType](#) (page 13-1)
- [C DOM API for XMLType](#) (page 14-1)
- [Oracle XML DB and Oracle Data Provider for .NET](#) (page 15-1)

PL/SQL APIs for XMLType

There are several PL/SQL packages that provide APIs for XMLType.

- [Overview of PL/SQL APIs for XMLType](#) (page 11-1)
- [PL/SQL DOM API for XMLType \(DBMS_XMLDOM\)](#) (page 11-4)
- [PL/SQL Parser API for XMLType \(DBMS_XMLPARSER\)](#) (page 11-22)
- [PL/SQL XSLT Processor for XMLType \(DBMS_XSLPROCESSOR\)](#) (page 11-24)

11.1 Overview of PL/SQL APIs for XMLType

The PL/SQL Application Program Interfaces (APIs) for XMLType include a DOM API, a parser API, and a processor API.

- PL/SQL Document Object Model (DOM) API for XMLType (package DBMS_XMLDOM): For accessing XMLType objects. You can access both XML schema-based and non-schema-based documents.

A **DOM** is a tree-based object representation of an XML document in dynamic memory. It enables programmatic access to its elements and attributes. The DOM object and its interface is a W3C recommendation. It specifies the Document Object Model of an XML document including APIs for programmatic access. DOM views the parsed document as a tree of objects.

- PL/SQL XML Parser API for XMLType (package DBMS_XMLPARSER): For creating a DOM and accessing the content and structure of XML documents.
- PL/SQL XSLT Processor for XMLType (package DBMS_XSLPROCESSOR): For transforming XML documents to other formats using XSLT.

11.1.1 PL/SQL APIs for XMLType: Features

You can use the PL/SQL APIs for XMLType to create XMLType tables, columns, and views; construct XMLType instances from data encoded in different character sets; and access and manipulate XMLType in various ways.

See Also:

- [Oracle XML DB Features](#) (page 1-10), for an overview of the Oracle XML DB architecture and new features.
 - [Query and Update of XML Data](#) (page 5-1)
 - *Oracle Database PL/SQL Packages and Types Reference*
-

11.1.1.1 Lazy Load of XML Data (Lazy Manifestation)

Lazy XML loading loads rows of data only when they are requested, enhancing scalability of your applications that involve large XML documents and many concurrent users.

Because XMLType provides a dynamic memory or virtual Document Object Model (DOM), it can use a memory conserving process called **lazy XML loading**, also sometimes referred to as **lazy manifestation**. This process optimizes memory usage by only loading rows of data when they are requested. It throws away previously-referenced sections of the document if memory usage grows too large. Lazy XML loading supports highly scalable applications that have many concurrent users needing to access large XML documents.

11.1.1.2 XMLType Data Type Supports XML Schema

SQL data type XMLType supports XML Schema.

You can create an XML schema and annotate it with mappings from XML to object-relational storage. To take advantage of the PL/SQL DOM API, first create an XML schema and register it. Then, when you create XMLType tables and columns, you can specify that these conform to the registered XML schema.

11.1.1.3 XMLType Supports Data in Different Character Sets

You can use PL/SQL to create XMLType instances from data that is encoded in any Oracle-supported character set. To do this, you use the PL/SQL XMLType constructor or XMLType method `createXML()`.

The source XML data must be supplied using data type BFILE or BLOB. The encoding of the data is specified through argument `csid`. When this argument is zero (0), the encoding of the source data is determined from the XML prolog, as specified in Appendix F of the XML 1.0 Reference.

Caution:

AL32UTF8 is the Oracle Database character set that is appropriate for XMLType data. It is equivalent to the IANA registered standard UTF-8 encoding, which supports all valid XML characters.

Do not confuse Oracle Database database character set UTF8 (no hyphen) with database character set AL32UTF8 or with character *encoding* UTF-8. Database character set UTF8 has been *superseded* by AL32UTF8. Do *not* use UTF8 for XML data. Character set UTF8 supports only Unicode version 3.1 and earlier. It does not support all valid XML characters. AL32UTF8 has no such limitation.

Using database character set UTF8 for XML data could potentially *stop a system or affect security negatively*. If a character that is not supported by the database character set appears in an input-document element name, a replacement character (usually "?") is substituted for it. This terminates parsing and raises an exception. It could cause an irrecoverable error.

11.1.2 PL/SQL APIs for XMLType: References

The PL/SQL Application Programming Interfaces (APIs) for XMLType are described.

[Table 11-1](#) (page 11-3) lists the reference documentation for the PL/SQL APIs that you can use to manipulate XML data. The main reference for PL/SQL APIs is *Oracle Database PL/SQL Packages and Types Reference*.

See Also:

- *Oracle Database XML Java API Reference* for information about Java APIs for XML
 - *Oracle Database XML C API Reference* for information about C APIs for XML
 - *Oracle Database XML C++ API Reference* for information about C++ APIs for XML
-
-

Table 11-1 PL/SQL APIs Related to XML

API	Documentation	Description
XMLType	<i>Oracle Database PL/SQL Packages and Types Reference</i> , chapter "XMLType"	PL/SQL APIs with XML operations on XMLType data – validation, transformation.
Database URI types	<i>Oracle Database PL/SQL Packages and Types Reference</i> , chapter "Database URI TYPEs"	Functions used for various URI types.
DBMS_METADATA	<i>Oracle Database PL/SQL Packages and Types Reference</i> , chapter "DBMS_METADATA"	PL/SQL API for retrieving metadata from the database dictionary as XML, or retrieving creation DDL and submitting the XML to re-create the associated object.
DBMS_RESCONFIG	<i>Oracle Database PL/SQL Packages and Types Reference</i> , chapter "DBMS_RESCONFIG"	PL/SQL API to operate on a resource configuration list, and to retrieve listener information for a resource.
DBMS_XDB_ADMIN	<i>Oracle Database PL/SQL Packages and Types Reference</i> , chapter "DBMS_XDB_ADMIN"	PL/SQL API for the management of Oracle XML DB Repository by database administrators.
DBMS_XDB_CONFIG	<i>Oracle Database PL/SQL Packages and Types Reference</i> , chapter "DBMS_XDB_CONFIG"	PL/SQL API for managing Oracle XML DB configuration sessions.
DBMS_XDB_CONSTANTS	<i>Oracle Database PL/SQL Packages and Types Reference</i> , chapter "DBMS_XDB_CONSTANTS"	PL/SQL constants for use with Oracle XML DB
DBMS_XDB_REPOS	<i>Oracle Database PL/SQL Packages and Types Reference</i> , chapter "DBMS_XDB_REPOS"	PL/SQL API for the use of Oracle XML DB Repository by application developers.
DBMS_XDBRESOURCE	<i>Oracle Database PL/SQL Packages and Types Reference</i> , chapter "DBMS_XDBRESOURCE"	PL/SQL API to operate on repository resource metadata and contents.
DBMS_XDBT	<i>Oracle Database PL/SQL Packages and Types Reference</i> , chapter "DBMS_XDBT"	PL/SQL API for creation of text indexes on repository resources.

Table 11-1 (Cont.) PL/SQL APIs Related to XML

API	Documentation	Description
DBMS_XDB_VERSION	<i>Oracle Database PL/SQL Packages and Types Reference</i> , chapter "DBMS_XDB_VERSION"	PL/SQL API for version management of repository resources.
DBMS_XDBZ	<i>Oracle Database PL/SQL Packages and Types Reference</i> , chapter "DBMS_XDBZ"	Oracle XML DB Repository ACL-based security.
DBMS_XEVENT	<i>Oracle Database PL/SQL Packages and Types Reference</i> , chapter "DBMS_XEVENT"	PL/SQL API providing event-related types and supporting interface..
DBMS_XMLDOM	<i>Oracle Database PL/SQL Packages and Types Reference</i> , chapter "DBMS_XMLDOM"	PL/SQL implementation of the DOM API for XMLType.
DBMS_XMLGEN	<i>Oracle Database PL/SQL Packages and Types Reference</i> , chapter "DBMS_XMLGEN"	PL/SQL API for transformation of SQL query results into canonical XML format.
DBMS_XMLINDEX	<i>Oracle Database PL/SQL Packages and Types Reference</i> , chapter "DBMS_XMLINDEX"	PL/SQL API for XMLIndex.
DBMS_XMLPARSER	<i>Oracle Database PL/SQL Packages and Types Reference</i> , chapter "DBMS_XMLPARSER"	PL/SQL implementation of the DOM Parser API for XMLType.
DBMS_XMLSCHEMA	<i>Oracle Database PL/SQL Packages and Types Reference</i> , chapter "DBMS_XMLSCHEMA"	PL/SQL API for managing XML schemas within Oracle Database – schema registration, deletion.
DBMS_XMLSCHEMA_ANNOTATE	<i>Oracle Database PL/SQL Packages and Types Reference</i> , chapter "DBMS_XMLSCHEMA_ANNOTATE"	PL/SQL API for adding and managing Oracle-specific XML Schema annotations.
DBMS_XMLSTORAGE_MANAGE	<i>Oracle Database PL/SQL Packages and Types Reference</i> , chapter "DBMS_XMLSTORAGE_MANAGE"	PL/.SQL API managing and modifying storage of XML data after XML schema registration.
DBMS_XMLSTORE	<i>Oracle Database PL/SQL Packages and Types Reference</i> , chapter "DBMS_XMLSTORE"	PL/SQL API for storing XML data in relational tables.
DBMS_XSLPROCESSOR	<i>Oracle Database PL/SQL Packages and Types Reference</i> , chapter "DBMS_XSLPROCESSOR"	PL/SQL implementation of an XSLT processor.

11.2 PL/SQL DOM API for XMLType (DBMS_XMLDOM)

The PL/SQL DOM API for XMLType, DBMS_XMLDOM lets you operate on XMLType instances using a DOM.

See Also:

Oracle Database PL/SQL Packages and Types Reference for descriptions of the individual DBMS_XMLDOM methods

11.2.1 Overview of the W3C Document Object Model (DOM) Recommendation

The Document Object Model (DOM) recommended by the World Wide Web Consortium (W3C) is a universal API for accessing the structure of XML documents.

The DOM is a universal API for accessing the structure of XML documents. It was originally developed to formalize Dynamic HTML, which is used for animation, interaction, and dynamic updating of Web pages. DOM provides a language-neutral and platform-neutral object model for Web pages and XML documents. DOM describes language-independent and platform-independent interfaces to access and operate on XML components and elements. It expresses the structure of an XML document in a universal, content-neutral way. Applications can be written to dynamically delete, add, and edit the content, attributes, and style of XML documents. DOM makes it possible to create applications that work properly on all browsers, servers, and platforms.

11.2.1.1 Oracle XML Developer's Kit Extensions to the W3C DOM Standard

Oracle XML Developer's Kit (XDK) extends the W3C DOM API. These extensions are supported by Oracle XML DB except for those relating to client-side operations that are not applicable in the database. See the Simple API for XML (SAX) interface in the Oracle XML Developer's Kit Java and C components.

See Also:

Oracle XML Developer's Kit Programmer's Guide

11.2.1.2 Supported W3C DOM Recommendations

All Oracle XML DB APIs for accessing and manipulating XML data comply with standard XML processing requirements as approved by the W3C. The PL/SQL DOM supports Levels 1 and 2 of the W3C DOM specifications.

- **DOM Level 1.0** – The first formal Level of the DOM specifications, completed in October 1998. Level 1.0 defines support for XML 1.0 and HTML.
- **DOM Level 2.0** – Completed in November 2000, Level 2.0 extends Level 1.0 with support for XML 1.0 with namespaces and adds support for Cascading Style Sheets (CSS) and events (user-interface events and tree manipulation events), and enhances tree manipulations (tree ranges and traversal mechanisms). CSS are a simple mechanism for adding style (fonts, colors, spacing, and so on) to Web documents.

Oracle support for DOM is as follows:

- In Oracle9i release 1 (9.0.1), Oracle XML Developer's Kit for PL/SQL implemented DOM Level 1.0 and parts of DOM Level 2.0.
- In Oracle9i release 2 (9.2) and Oracle Database 10g release 1 (10.1), the PL/SQL API for XMLType implements DOM Levels 1.0 and Level 2.0 Core, and is fully integrated in the database through extensions to the XMLType API.

11.2.1.3 Difference Between DOM and SAX

DOM is the primary generic tree-based API for XML. SAX (Simple API for XML) is the primary generic event-based programming interface between an XML parser and an XML application.

DOM works by creating objects. These objects have child objects and properties. The child objects have their own child objects and properties, and so on. Objects are referenced either by moving down the object hierarchy or by explicitly giving an HTML element an ID attribute. For example:

```

```

Examples of structural manipulations are:

- Reordering elements
- Adding or deleting elements
- Adding or deleting attributes
- Renaming elements

See Also:

- <http://www.w3.org/DOM/> for information about DOM
 - <http://www.saxproject.org/> for information about SAX
-
-

11.2.2 PL/SQL DOM API for XMLType (DBMS_XMLDOM): Features

Oracle XML DB extends the Oracle Database XML development platform beyond SQL support for storage and retrieval of XML data. It lets you operate on XMLType instances using DOM in PL/SQL, Java, and C.

The *default* action for the PL/SQL DOM API for XMLType (DBMS_XMLDOM) does the following:

- Produce a parse tree that can be accessed by DOM APIs.
- Validate, if a DTD is found. Otherwise, do not validate.
- Raise an application error if parsing fails.

DTD validation occurs when the object document is manifested. If lazy manifestation is employed, then the document is validated when it is used.

The PL/SQL DOM API exploits a C-based representation of XML in the server and operates on XML schema-based XML instances. The PL/SQL, Java, and C DOM APIs for XMLType comply with the W3C DOM Recommendations to define and implement object-relational storage of XML data in relational or object-relational columns and as dynamic memory instances of XMLType. See [Preparing XML Data to Use the PL/SQL DOM API for XMLType](#) (page 11-8), for a description of W3C DOM Recommendations.

11.2.2.1 PL/SQL DOM API Support for XML Schema

The PL/SQL DOM API for XMLType supports XML Schema. Oracle XML DB uses annotations within an XML schema as metadata to determine the structure of an XML document and the mapping of the document to a database schema.

Note:

For backward compatibility and flexibility, the PL/SQL DOM supports both XML Schema-based documents and non-schema-based documents.

After an XML schema is registered with Oracle XML DB, the PL/SQL DOM API for XMLType builds a tree representation of an associated XML document in dynamic memory as a hierarchy of node objects, each with its own specialized interfaces. Most node object types can have child node types, which in turn implement additional, more specialized interfaces. Nodes of some node types can have child nodes of various types, while nodes of other node types must be leaf nodes, which do not have child nodes.

11.2.2.2 Enhanced DOM Performance

Oracle XML DB uses DOM to provide a standard way to translate data between XML and multiple back-end data sources. This eliminates the need to use separate XML translation techniques for the different data sources in your environment.

Applications needing to exchange XML data can use a single native XML database to cache XML documents. Oracle XML DB can thus speed up application performance by acting as an intermediate cache between your Web applications and your back-end data sources, whether they are in relational databases or file systems.

See Also:

[Java DOM API for XMLType](#) (page 13-1)

11.2.3 Application Design Using Oracle XML Developer's Kit and Oracle XML DB

When you build applications based on Oracle XML DB, you do not need the additional components provided by Oracle XML Developer's Kit (XDK). However, you can use XDK components with Oracle XML DB to deploy a full suite of XML-enabled applications that run end-to-end.

These XDK features are particularly useful for developing XML applications based on Oracle XML DB.

- Simple API for XML (SAX) interface processing. SAX is an XML standard interface provided by XML parsers and used by procedural and event-based applications.
- DOM interface processing, for structural and recursive object-based processing.

Oracle XML Developer's Kit contains the basic building blocks for creating applications that run on a client, in a browser or a plug-in. Such applications typically read, manipulate, transform and view XML documents. To provide a broad variety of deployment options, Oracle XML Developer's Kit is available for Java, C, and C++. Oracle XML Developer's Kit is fully supported and comes with a commercial redistribution license.

Oracle XML Developer's Kit for Java consists of these components:

- **XML Parsers** – Creates and parses XML using industry standard DOM and SAX interfaces. Supports Java, C, C++, and the Java API for XML Processing (JAXP).
- **XSL Processor** – Transforms or renders XML into other text-based formats such as HTML. Supports Java, C, and C++.
- **XML Schema Processor** – Uses XML simple and complex data types. Supports Java, C, and C++.
- **XML Class Generator, Oracle JAXB Class Generator** – Automatically generate C++ and Java classes, respectively, from DTDs and XML schemas, to send XML data from Web forms or applications. Class generators accept an input file and create a set of output classes that have corresponding functionality. For the XML Class Generator, the input file is a DTD, and the output is a series of classes that can be used to create XML documents conforming with the DTD.
- **XML SQL Utility** – Generates XML documents, DTDs, and XML schemas from SQL queries. Supports Java.
- **TransX Utility** – Loads data encapsulated in XML into the database. Has additional functionality useful for installations.
- **XML Pipeline Processor** – Invokes Java processes through XML control files.
- **XSLT VM and Compiler** – Provides a high-performance C-based XSLT transformation engine that uses compiled XSL stylesheets.
- **XML Java Beans** – Parses, transforms, compares, retrieves, and compresses XML documents using Java components.

See Also:

Oracle XML Developer's Kit Programmer's Guide

11.2.4 Preparing XML Data to Use the PL/SQL DOM API for XMLType

Create an XML schema, annotate it to map XML to SQL objects, and register the XML schema.

To prepare data for using PL/SQL DOM APIs in Oracle XML DB:

1. Create a standard XML schema.
2. Annotate the XML schema with definitions for the SQL objects you use.
3. Register the XML schema, to generate the necessary database mappings.

You can then do any of the following:

- Use XMLType views to wrap existing relational or object-relational data in XML formats, making it available to your applications in XML form. See [Wrap Existing Data as XML with XMLType Views](#) (page 11-10).
- Insert XML data into XMLType columns.

- Use Oracle XML DB PL/SQL and Java DOM APIs to manipulate XML data stored in XMLType columns and tables.

11.2.5 XML Schema Types Are Mapped to SQL Object Types

An XML schema must be registered with Oracle XML DB before it can be referenced by an XML document. When you register an XML schema, elements and attributes it declares are mapped to attributes of corresponding SQL object types within the database.

After XML schema registration, XML documents that conform to the XML schema and reference it can be managed by Oracle XML DB. Tables and columns for storing the conforming documents can be created for root elements defined by the XML schema.

See Also:

[XML Schema Storage and Query: Basic](#) (page 17-1)

An XML schema is registered by using PL/SQL package DBMS_XMLSCHEMA and by specifying the schema document and its *schema-location URL*. This URL is a name that uniquely identifies the registered schema within the database. It need not correspond to any real location — in particular, it need not indicate where the schema document is located.

The *target namespace* of the schema is another URL used in the XML schema. It specifies a namespace for the XML-schema elements and types. An XML document should specify both the namespace of the root element and the schema-location URL identifying the schema that defines this element.

When documents are inserted into Oracle XML DB using path-based protocols such as HTTP(S) and FTP, the XML schema to which the document conforms is *registered implicitly*, provided its name and location are specified and it has not yet been registered.

See Also:

Oracle Database PL/SQL Packages and Types Reference descriptions of the individual DBMS_XMLSCHEMA methods

11.2.5.1 DOM Fidelity for XML Schema Mapping

Elements and attributes declared within an XML schema get mapped to separate attributes of the corresponding SQL object type. Other information encoded in an XML document, such as comments, processing instructions, namespace declarations and prefix definitions, and whitespace, is not represented directly.

To store this additional information, binary attribute SYS_XDBPD\$ is present in all generated SQL object types. This database attribute stores all information in the original XML document that is not stored using the other database attributes. Retaining this accessory information ensures *DOM fidelity* for XML documents stored in Oracle XML DB: an XML document retrieved from the database is identical to the original document that was stored.

Note:

In this book, attribute `SYS_XDBPD$` has been omitted from most examples, for simplicity. However, the attribute is always present in SQL object types generated by schema registration.

See Also:

[SYS_XDBPD\\$ and DOM Fidelity for Object-Relational Storage](#) (page 18-6)

11.2.6 Wrap Existing Data as XML with XMLType Views

To make existing relational and object-relational data available to your XML applications, you can create XMLType views based on it. You can then access the resulting XML data using the PL/SQL DOM API.

After you register an XML schema containing annotations that represent the mapping between XML types and SQL object types, you can create an XMLType view that conforms to the XML schema.

See Also:

[XMLType Views](#) (page 10-1)

11.2.7 DBMS_XMLDOM Methods Supported by Oracle XML DB

All DBMS_XMLDOM methods are supported by Oracle XML DB, with a few exceptions.

These methods are *not* supported by Oracle XML DB:

- `writeExternalDTDToFile()`
 - `writeExternalDTDToBuffer()`
 - `writeExternalDTDToClob()`
-
-

See Also:

Oracle Database PL/SQL Packages and Types Reference for descriptions of the individual DBMS_XMLDOM methods

11.2.8 PL/SQL DOM API for XMLType: Node Types

The DOM specifies the way elements within an XML document are used to create an object-based tree structure. It defines and exposes interfaces to manage and use the objects stored in XML documents. The DOM supports storage of documents in diverse systems.

In the DOM specification, the term "**document**" describes a container for many different kinds of information or data, which the DOM objectifies.

When a request such as `getNodeType(myNode)` is invoked, it returns `myNodeType`, which is the node type supported by the parent node. The following constants represent the different types that a node can adopt:

- ELEMENT_NODE
- ATTRIBUTE_NODE
- TEXT_NODE
- CDATA_SECTION_NODE
- ENTITY_REFERENCE_NODE
- ENTITY_NODE
- PROCESSING_INSTRUCTION_NODE
- COMMENT_NODE
- DOCUMENT_NODE
- DOCUMENT_TYPE_NODE
- DOCUMENT_FRAGMENT_NODE
- NOTATION_NODE

[Table 11-2](#) (page 11-11) shows the node types for XML and HTML, and the allowed corresponding child node types.

Table 11-2 XML and HTML DOM Node Types and Their Child Node Types

Node Type	Children Node Types
Document	Element (maximum of one), ProcessingInstruction, Comment, DocumentType (maximum of one)
DocumentFragment	Element, ProcessingInstruction, Comment, Text, CDATASection, EntityReference
DocumentType	No children
EntityReference	Element, ProcessingInstruction, Comment, Text, CDATASection, EntityReference
Element	Element, Text, Comment, ProcessingInstruction, CDATASection, EntityReference
Attr	Text, EntityReference
ProcessingInstruction	No children
Comment	No children

Table 11-2 (Cont.) XML and HTML DOM Node Types and Their Child Node Types

Node Type	Children Node Types
Text	No children
CDATASection	No children
Entity	Element, ProcessingInstruction, Comment, Text, CDATASection, EntityReference
Notation	No children

Oracle XML DB DOM API for XMLType also specifies the following interfaces:

- A **NodeList** interface to handle ordered lists of Nodes, for example:
 - The children of a Node
 - Elements returned by method `getElementByTagName()` of the element interface
- A **NamedNodeMap** interface to handle unordered sets of nodes, referenced by their name attribute, such as the attributes of an element.

11.2.9 PL/SQL Function NEWDOMDOCUMENT and DOMDOCUMENT Nodes

PL/SQL function `newDOMDocument` constructs a DOM document handle, given an XMLType value. The resulting handle is of type `DOMDocument`.

A typical usage scenario for a PL/SQL application is:

1. Fetch or construct an XMLType instance
2. Construct a DOMDocument node over the XMLType instance
3. Use the DOM API to access and manipulate the XML data

Note:

For `DOMDocument`, node types represent handles to XML fragments but do not represent the data itself.

For example, if you copy a node value, `DOMDocument` clones the handle to the same underlying data. Any data modified by one of the handles is visible when accessed by the other handle. The XMLType value from which the `DOMDocument` handle is constructed is the data, and reflects the results of all DOM operations on it.

11.2.10 DOM NodeList and NamedNodeMap Objects

When you change the document structure underlying a `DOMDocument` instance, the changes are reflected in all relevant `NodeList` and `NamedNodeMap` objects.

For example, if a DOM user gets a `NodeList` object containing the children of an element, and then subsequently adds more children to that element (or removes children, or modifies existing children) then those changes automatically propagate to the `NodeList` without additional action from the user. Likewise, changes to a node in the tree are propagated throughout all references to that node in `NodeList` and `NamedNodeMap` objects.

The interfaces: `Text`, `Comment`, and `CDATASection`, all inherit from the `CharacterData` interface.

11.2.11 Overview of Using the PL/SQL DOM API for XMLType (DBMS_XMLDOM)

Using PL/SQL package `DBMS_XMLDOM` typically involves creating DOM documents, traversing or extending the DOM tree, and creating and manipulating nodes.

Figure 11-1 (page 11-13) illustrates the use of PL/SQL DOM API for XMLType (`DBMS_XMLDOM`).

- You can create a DOM document (`DOMDocument`) from an existing XMLType or as an empty document. Procedure `newDOMDocument` processes the XMLType instance or empty document.

This creates a `DOMDocument` instance.

- You can use DOM API PL/SQL methods such as `createElement()`, `createTextNode()`, `createAttribute()`, and `createComment()` to traverse and extend the DOM tree.
- The results of PL/SQL methods such as `DOMElement()` and `DOMText()` can also be passed to PL/SQL function `makeNode` to obtain the `DOMNode` interface.

Figure 11-1 Using the PL/SQL DOM API for XMLType

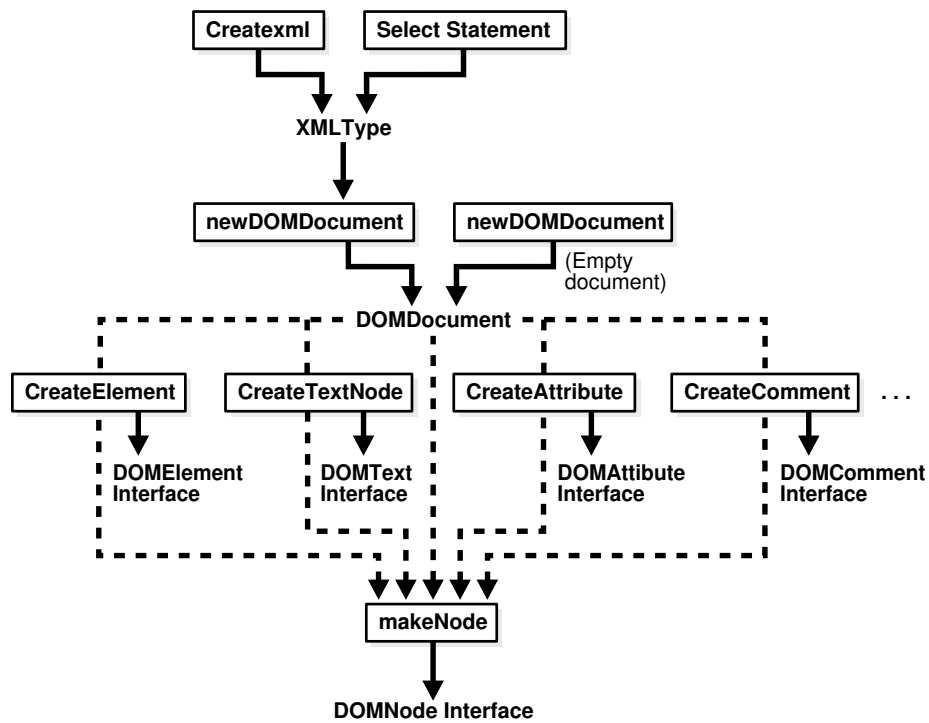

11.2.12 PL/SQL DOM API for XMLType – Examples

Examples are presented of using the PL/SQL DOM API for XMLType.

Remember to call procedure `freeDocument` for *each* `DOMDocument` instance, when you are through with the instance. This procedure frees the document and all of its nodes. You can still access XMLType instances on which `DOMDocument` instances were built, even after the `DOMDocument` instances have been freed.

[Example 11-1](#) (page 11-14) creates a hierarchical, representation of an XML document in dynamic memory: a DOM document.

[Example 11-1](#) (page 11-14) uses a *handle* to the DOM document to manipulate it: print it, change part of it, and print it again after the change. Manipulating the DOM document by its handle also indirectly affects the XML data represented by the document, so that querying that data after the change shows the changed result.

The DOM document is created from an XMLType variable using PL/SQL function `newDOMDocument`. The handle to this document is created using function `makeNode`. The document is written to a `VARCHAR2` buffer using function `writeToBuffer`, and the buffer is printed using `DBMS_OUTPUT.put_line`.

After manipulating the document using various `DBMS_XMLDOM` procedures, the (changed) data in the XMLType variable is inserted into a table and queried, showing the change. It is only when the data is inserted into a database table that it becomes persistent. Until then, it exists in memory only. This persistence is demonstrated by the fact that the database query is made after the document (`DOMDocument` instance) has been freed from dynamic memory.

[Example 11-2](#) (page 11-15) creates an empty DOM document, and then adds an element node (`<ELEM>`) to the document. `DBMS_XMLDOM` API node procedures are used to obtain the name (`<ELEM>`), value (`NULL`), and type (`1 = element node`) of the element node.

Example 11-1 Creating and Manipulating a DOM Document

```
CREATE TABLE person OF XMLType;

DECLARE
    var      XMLType;
    doc      DBMS_XMLDOM.DOMDocument;
    ndoc     DBMS_XMLDOM.DOMNode;
    docelem  DBMS_XMLDOM.DOMElement;
    node     DBMS_XMLDOM.DOMNode;
    childnode DBMS_XMLDOM.DOMNode;
    nodelist DBMS_XMLDOM.DOMNodelist;
    buf      VARCHAR2(2000);
BEGIN
    var := XMLType('<PERSON><NAME>ramesh</NAME></PERSON>');

    -- Create DOMDocument handle
    doc := DBMS_XMLDOM.newDOMDocument(var);
    ndoc := DBMS_XMLDOM.makeNode(doc);

    DBMS_XMLDOM.writeToBuffer(ndoc, buf);
    DBMS_OUTPUT.put_line('Before: ' || buf);

    docelem := DBMS_XMLDOM.getDocumentElement(doc);

    -- Access element
    nodelist := DBMS_XMLDOM.getElementsByTagName(docelem, 'NAME');
```

```

node := DBMS_XMLDOM.item(nodelist, 0);
childnode := DBMS_XMLDOM.getFirstChild(node);

-- Manipulate element
DBMS_XMLDOM.setNodeValue(childnode, 'raj');
DBMS_XMLDOM.writeToBuffer(ndoc, buf);
DBMS_OUTPUT.put_line('After: ' || buf);
DBMS_XMLDOM.freeDocument(doc);
INSERT INTO person VALUES (var);
END;
/

```

This produces the following output:

```

Before:<PERSON>
  <NAME>ramesh</NAME>
</PERSON>

After:<PERSON>
  <NAME>raj</NAME>
</PERSON>

```

This query confirms that the data has changed:

```

SELECT * FROM person;
SYS_NC_ROWINFO$
-----
<PERSON>
  <NAME>raj</NAME>
</PERSON>

1 row selected.

```

Example 11-2 Creating an Element Node and Obtaining Information About It

```

DECLARE
  doc  DBMS_XMLDOM.DOMDocument;
  elem DBMS_XMLDOM.DOMELEMENT;
  nelem DBMS_XMLDOM.DOMNode;
BEGIN
  doc := DBMS_XMLDOM.newDOMDocument;
  elem := DBMS_XMLDOM.createElement(doc, 'ELEM');
  nelem := DBMS_XMLDOM.makeNode(elem);
  DBMS_OUTPUT.put_line('Node name = ' || DBMS_XMLDOM.getNodeName(nelem));
  DBMS_OUTPUT.put_line('Node value = ' || DBMS_XMLDOM.getNodeValue(nelem));
  DBMS_OUTPUT.put_line('Node type = ' || DBMS_XMLDOM.getNodeType(nelem));
  DBMS_XMLDOM.freeDocument(doc);
END;
/

```

This produces the following output:

```

Node name = ELEM
Node value =
Node type = 1

```

11.2.13 Large Node Handling Using DBMS_XMLDOM

Oracle XML DB provides abstract streams and stream-manipulation methods that you can use to handle XML nodes that are larger than 64 K bytes.

Prior to Oracle Database 11g Release 1 (11.1), each text node or attribute value processed by Oracle XML DB was limited in size to 64 K bytes. Starting with release 11.1, this restriction no longer applies.

To overcome this size limitation and allow nodes to contain graphics files, PDF files, and multibyte character encodings, the following abstract streams are available. These abstract PL/SQL streams are analogous to the corresponding Java streams. Each input stream has an associated writer, or data producer, and each output stream has an associated reader, or data consumer.

- **Binary Input Stream:** This provides the data consumer with read-only access to source data, as a sequential (non-array) linear space of bytes. The consumer has iterative read access to underlying source data (whatever representation) in binary format, that is, read access to source data in unconverted, "raw" format. The consumer sees a sequence of bytes as they exist in the node. There is no specification of the format or representation of the source data. In particular, there is no associated character set.
- **Binary Output Stream:** This provides the data producer with write-only access to target data as a sequential (non-array) linear space of bytes. The producer has iterative write access to target data in binary format, that is, write access to target data in pure binary format with no data semantics at all. The producer passes a sequence of bytes and the target data is replaced by these bytes. No data conversion occurs.
- **Character Input Stream:** This provides the data consumer iterative read-only access to source data as a sequential (non-array) linear space of characters, independent of the representation and format of the source data. Conversion of the source data may or may not occur.
- **Character Output Stream:** This provides the data producer with iterative write-only access to target data as a sequential (non-array) linear space of characters. The producer passes a sequence of characters and the target data is replaced by this sequence of characters. Conversion of the passed data may or may not occur.

Each of the input streams has the following abstract methods: open, read, and close. Each of the output streams has the following abstract methods: open, write, flush, and close. For output streams, you must close the stream before any nodes are physically written.

There are four general node-access models, for reading and writing. Each access model has both binary and character versions. Binary and character stream methods defined on data type `DOMNode` realize these access models.

Your application acts as the client, with the parser as its service provider. The parser mode determines whether the parser or your application drives the stream dataflow.

- For a parser in push mode, your application pushes data to the parser in an output stream, and the parser returns the result of the requested operation.
- For a parser in pull mode, your application pulls data from the parser in an input stream. Each data item in the stream is the result of a parsing event.

Each access model is described in a separate section, with an explanation of the PL/SQL functions and procedures in package `DBMS_XMLDOM` that operate on large nodes. The name of each subprogram reflects whether it reads ("get") or writes ("set") data, and whether the parser is being used in push ("push") or pull ("pull") mode.

- [Get-Push Model for Large Node Handling](#) (page 11-17)

- [Get-Pull Model for Large Node Handling](#) (page 11-18)
- [Set-Pull Model for Large Node Handling](#) (page 11-20)
- [Set-Push Model for Large Node Handling](#) (page 11-21)

For all except the get-push and set-pull access models (whether binary or character), Oracle supplies a concrete stream that you can use (implicitly). For get-push and set-pull, you must define a subtype of the abstract stream type that Oracle provides, and you must implement its access methods (open, close, and so on). For get-push and set-pull, you then instantiate your stream type and supply your stream as an argument to the access method. So, for example, you would use `my_node.getNodeValueAsCharacterStream(my-stream)` for get-push, but just `my_node.getNodeValueAsCharacterStream()` for get-pull. The latter requires no explicit stream argument, because the concrete stream supplied by Oracle is used.

Note:

When you access a character-data stream, the access method you use determines the apparent character set of the nodes accessed. If you use Java to access the stream, then the character set seen by your Java program is UCS2 (or an application-specified character set). If you use PL/SQL to access the stream, then the character set seen by your PL/SQL program is the database-session character set (or an application-specified character set). In all cases, however, the XML data is stored in the database in the database character set.

In the following descriptions, C1 is the character set of the node as stored in the database, and C2 is the character set of the node as seen by your program.

See Also:

- [Large XML Node Handling with Java](#) (page 13-13) for information on using Java with large nodes
 - *Oracle Database PL/SQL Packages and Types Reference*
 - *Oracle Database XML Java API Reference* for information about Java functions for handling large nodes
 - *Oracle Database XML C API Reference* for information about C functions for handling large nodes
-
-

11.2.14 Get-Push Model for Large Node Handling

In this model, you retrieve the value of a DOM node, using a parser that is in push mode. Oracle XML DB writes the node data to an output stream that the parser reads.

To read a node value in this model, your application creates a binary output stream or character output stream and passes this to Oracle XML DB. In this case, the source data is the node value. Oracle XML DB populates the output stream by adding node data to the stream. If the stream is a character output stream, then the character set, C2, is the session character set, and node data is converted, if necessary, from C1 to C2. Additionally, the data type of the node can be any that is supported by Oracle XML DB. If the node data type is not character data then the node data is first

converted to character data in C2. If a binary output stream, the data type of the node must be RAW or BLOB.

The procedures of the DBMS_XMLDOM package to be used for this case are:

```
PROCEDURE getNodeValueAsBinaryStream (n      IN DBMS_XMLDOM.domnode,
                                     value IN SYS.utl_BinaryOutputStream);
```

The application passes an implementation of SYS.utl_BinaryOutputStream into which Oracle XML DB writes the contents of the node. The data type of the node must be RAW or CLOB or else an exception is raised.

```
PROCEDURE getNodeValueAsCharacterStream (n      IN DBMS_XMLDOM.domnode,
                                         value IN SYS.utl_CharacterOutputStream);
```

The node data is converted, as necessary, to the session character set and then "pushed" into the SYS.utl_CharacterOutputStream.

The following example fragments illustrate reading the node value as binary data and driving the write methods in a user-defined subtype of SYS.utl_BinaryOutputStream, which is called MyBinaryOutputStream:

Example 11-3 Creating a User-Defined Subtype of SYS.utl_BinaryOutputStream()

```
CREATE TYPE MyBinaryOutputStream UNDER SYS.utl_BinaryOutputStream (
    CONSTRUCTOR FUNCTION MyBinaryOutputStream ()
    RETURN SELF AS RESULT,
    MEMBER FUNCTION write (bytes IN RAW) RETURN INTEGER,
    MEMBER PROCEDURE write (bytes IN RAW, offset IN INTEGER, length IN OUT
        INTEGER),
    MEMBER FUNCTION flush () RETURN BOOLEAN,
    MEMBER FUNCTION close () RETURN BOOLEAN);
);

-- Put code here that implements these methods
...

```

Example 11-4 Retrieving Node Value with a User-Defined Stream

```
DECLARE
    ostream      MyBinaryOutputStream = MyBinaryOutputStream ();
    node         DBMS_XMLDOM.domnode;
    ...
BEGIN
    ...
    -- This drives the write methods in MyBinaryOutputStream,
    -- flushes the data, and closes the stream after the value has been
    -- completely written.
    DBMS_XMLDOM.getNodeValueAsBinaryStream (node, ostream);
    ...
END;
```

11.2.15 Get-Pull Model for Large Node Handling

In this model, you retrieve the value of a DOM node, using a parser that is in pull mode. Oracle XML DB reads the event data from an input stream written by the parser.

To read the value of a node in this model, Oracle XML DB creates a binary input stream or character input stream and returns this to the caller. The character set, C2, of the character input stream is the current session character set. Oracle XML DB populates the input stream as the caller pulls the node data from the stream so Oracle

XML DB is again the producer of the data. If the stream is a character input stream, then the node data type may be any supported by Oracle XML DB and node data, if character, is converted, if necessary, from C1 to C2. If the node data is non-character, it is converted to character in C2. If a binary input stream, the data type of the node must be RAW or BLOB.

The functions of the DBMS_XMLDOM package to be used for this case are `getNodeValueAsBinaryStream` and `getNodeValueAsCharacterStream`.

```
FUNCTION getNodeValueAsBinaryStream(n IN DBMS_XMLDOM.domnode)
    RETURN SYS.utl_BinaryInputStream;
```

This function returns an instance of the new PL/SQL `SYS.utl_BinaryInputStream` that can be read using defined methods as described in the section [Set-Pull Model for Large Node Handling](#) (page 11-20). The node data type must be RAW or BLOB or else an exception is raised.

```
FUNCTION getNodeValueAsCharacterStream (n IN DBMS_XMLDOM.domnode)
    RETURN SYS.utl_CharacterInputStream;
```

This function returns an instance of the new PL/SQL `SYS.utl_CharacterInputStream` that can be read using defined methods. If the node data is character it is converted to the current session character set. If the node data is not character data, it is first converted to character data.

[Example 11-5](#) (page 11-19) illustrates reading a node value as binary data in 50-byte increments:

[Example 11-6](#) (page 11-19) illustrates reading a node value as character data in 50-character increments:

Example 11-5 Get-Pull of Binary Data

```
DECLARE
    istream      SYS.utl_BinaryInputStream;
    node         DBMS_XMLDOM.domnode;
    buffer       raw(50);
    numBytes     pls_integer;
    ...
BEGIN
    ...
    istream := DBMS_XMLDOM.getNodeValueAsBinaryStream (node);
    -- Read stream in 50-byte chunks
    LOOP
        numBytes := 50;
        istream.read ( buffer, numBytes);
        if numBytes <= 0 then
            exit;
        end if;
    -- Process next 50 bytes of node value in buffer
    END LOOP
    ...
END;
```

Example 11-6 Get-Pull of Character Data

```
DECLARE
    istream      SYS.utl_CharacterInputStream;
    node         DBMS_XMLDOM.domnode;
    buffer       varchar2(50);
    numChars     pls_integer;
```

```

...
BEGIN
...
  istream := DBMS_XMLDOM.getNodeValueAsCharacterStream (node);
-- Read stream in 50-character chunks
LOOP
  numChars := 50;
  istream.read ( buffer, numChars);
  IF numChars <= 0 then
    exit;
  END IF;
-- Process next 50 characters of node value in buffer
END LOOP
...
END;
```

11.2.16 Set-Pull Model for Large Node Handling

In this model, you set the value of a DOM node, using a parser that is in pull mode. Oracle XML DB reads the event data from an input stream written by the parser.

To write a node value in this mode, the application creates a binary input stream or character input stream and passes this to Oracle XML DB.

The character set of the character input stream, C2, is the session character set. Oracle XML DB pulls the data from the input stream and populates the node. If the stream is a character input stream, then the data type of the node may be any supported by Oracle XML DB. If the data type of the node is not character, the stream data is first converted to the node data type. If the node data type is character, then no conversion occurs, so the node data remains in character set C2. If the stream is a binary input stream, then the data type of the node must be RAW or BLOB and no conversion occurs.

The procedures of the DBMS_XMLDOM package to be used for this case are `setNodeValueAsBinaryStream` and `setNodeValueAsCharacterStream`.

```
PROCEDURE setNodeValueAsBinaryStream(n IN DBMS_XMLDOM.domnode,
  value IN SYS.utl_BinaryInputStream);
```

The application passes in an implementation of `SYS.utl_BinaryInputStream` from which Oracle XML DB reads data to populate the node. The data type of the node must be RAW or BLOB or else an exception is raised.

```
PROCEDURE setNodeValueAsCharacterStream (n IN DBMS_XMLDOM.domnode,
  value IN SYS.utl_CharacterInputStream);
```

The application passes in an implementation of `SYS.utl_CharacterInputStream` from which Oracle XML DB reads to populate the node. The data type of the node may be any valid type supported by Oracle XML DB. If it is a non-character data type, the character data read from the stream is converted to the data type of the node. If the data type of the node is either character or CLOB, then no conversion occurs and the character set of the node becomes the character set of the PL/SQL session.

[Example 11-7](#) (page 11-21) illustrates setting the node value to binary data produced by the read methods defined in a user-defined subtype of `SYS.utl_BinaryInputStream`, which is called `MyBinaryInputStream`:

You can use an object of type `MyBinaryInputStream` to set the value of a node as follows:

```

DECLARE
    istream      MyBinaryInputStream = MyBinaryInputStream ();
    node         DBMS_XMLDOM.domnode;
    ...
BEGIN
    ...
    -- This drives the read methods in MyBinaryInputStream
    DBMS_XMLDOM.setNodeValueAsBinaryStream (node, istream);
    ...
END;

```

Example 11-7 Set-Pull of Binary Data

```

CREATE TYPE MyBinaryInputStream UNDER SYS.utl_BinaryInputStream (
    CONSTRUCTOR FUNCTION MyBinaryInputStream ()
    RETURN SELF AS RESULT,
    MEMBER FUNCTION read () RETURN RAW,
    MEMBER PROCEDURE read (bytes IN OUT RAW, numbytes IN OUT INTEGER),
    MEMBER PROCEDURE read (bytes IN OUT RAW,
        offset IN INTEGER,
        length IN OUT INTEGER),
    MEMBER FUNCTION close () RETURN BOOLEAN);

```

11.2.17 Set-Push Model for Large Node Handling

In this model, you set the value of a DOM node, using a parser that is in push mode. Oracle XML DB writes the node data to an output stream that the parser reads.

To write a new node value in this mode, Oracle XML DB creates a binary output stream or character output stream and returns this to the caller. The character set of the character output stream, C2, is the current session character set. The caller pushes data into the output stream and Oracle XML DB then writes this to the Oracle XML DB Node. If the stream is a character output stream, then the data type of the node may be any type supported by Oracle XML DB. In this case, the character data is converted to the node data type. If the node data type is character, then the character set, C1, is changed to C2. No data conversion occurs. If the stream is a binary input stream, and the data type of the node must be RAW or BLOB. In this case, the stream is read without data conversion.

The procedures of the DBMS_XMLDOM package to be used for this case are `setNodeValueAsBinaryStream` and `setNodeValueAsCharacterStream`.

```

FUNCTION setNodeValueAsBinaryStream(n IN DBMS_XMLDOM.domnode)
    RETURN SYS.utl_BinaryOutputStream;

```

This function returns an instance of `SYS.utl_BinaryOutputStream` into which the caller can write the node value. The data type of the node must be RAW or BLOB or else an exception is raised.

```

FUNCTION setNodeValueAsCharacterStream (n IN DBMS_XMLDOM.domnode)
    RETURN SYS.utl_CharacterOutputStream;

```

This function returns an instance of the PL/SQL `SYS.utl_CharacterOutputStream` type into which the caller can write the node value. The data type of the node can be any valid Oracle XML DB data type. If the type is not character or CLOB, the character data written to the stream is converted to the node data type. If the data type of the node is character or CLOB, then the character data written to the stream is converted from PL/SQL session character set to the character set of the node

[Example 11-8](#) (page 11-22) illustrates setting the value of a node to binary data by writing 50-byte segments into the `SYS.utl_BinaryOutputStream`:

Example 11-8 Set-Push of Binary Data

```

DECLARE
    ostream      SYS.utl_BinaryOutputStream;
    node         DBMS_XMLDOM.domnode;
    buffer       raw(500);
    segment      raw(50);
    numBytes     pls_integer;
    offset       pls_integer;
    ...
BEGIN
    ...
    ostream := DBMS_XMLDOM.setNodeValueAsBinaryStream (node);
    offset := 0;
    length := 500;
    -- Write to stream in 50-byte chunks
    LOOP
        numBytes := 50;
        -- Get next 50 bytes of buffer
        ostream.write ( segment, offset, numBytes);
        length := length - numBytes;
        IF length <= 0 then
            exit;
        END IF;
    END LOOP
    ostream.close();
    ...
END;
```

11.2.18 Determining Binary Stream or Character Stream for Large Node Handling

You can use subprogram `DBMS_XMLDOM.useBinaryStream` to determine whether to use a character stream or a binary stream to access the content of a large node.

```
FUNCTION useBinaryStream (n IN DBMS_XMLDOM.domnode) RETURN BOOLEAN;
```

This function returns `TRUE` if the data type of the node is `RAW` or `BLOB`, so that the node value may be read or written using either a `SYS.utl_BinaryInputStream` or a `SYS.utl_BinaryOutputStream`. If a value of `FALSE` is returned, the node value can be accessed only using a `SYS.utl_CharacterInputStream` or a `SYS.utl_CharacterOutputStream`.

11.3 PL/SQL Parser API for XMLType (DBMS_XMLPARSER)

The PL/SQL Parser API for XMLType (DBMS_XMLPARSER) builds a parsing result tree that can be accessed by PL/SQL APIs. If parsing fails, it raises an error.

A software module called an XML parser or processor reads XML documents and provides access to their content and structure. An XML parser usually does its work on behalf of another module, typically the application.

XML documents are made up of storage units, called *entities*, that contain either parsed or unparsed data. Parsed data is made up of characters, some of which constitute character data and some of which act as markup. Markup encodes a description of the document storage layout and logical structure. XML provides a mechanism for imposing constraints on the storage layout and logical structure.

Figure 11-2 (page 11-23) illustrates how to use the PL/SQL Parser for XMLType (DBMS_XMLPARSER). These are the steps:

1. Construct a parser instance using PL/SQL method `newParser()`.
2. Parse XML documents using PL/SQL methods such as `parseBuffer()`, `parseClob()`, and `parse(URI)`. An error is raised if the input is not a valid XML document.
3. Call PL/SQL function `getDocument` on the parser to obtain a `DOMDocument` interface.

Figure 11-2 Using the PL/SQL Parser API for XMLType

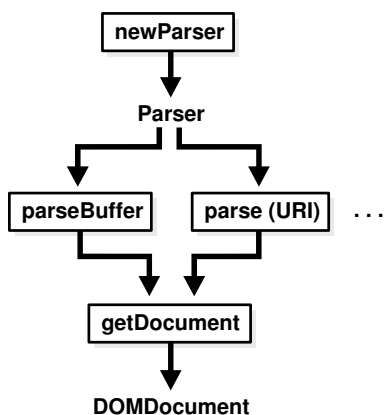

Example 11-9 (page 11-23) parses a simple XML document. It creates an XML parser (instance of `DBMS_XMLPARSER.parser`) and uses it to parse the XML document (text) in variable `indoc`. Parsing creates a DOM document, which is retrieved from the parser using `DBMS_XMLPARSER.getDocument`. A DOM node is created that contains the entire document, and the node is printed. After freeing (destroying) the DOM document, the parser instance is freed using `DBMS_XMLPARSER.freeParser`.

Note:

Method `DBMS_XMLPARSER.setErrorLog()` is not supported.

See Also:

Oracle Database PL/SQL Packages and Types Reference for descriptions of individual `DBMS_XMLPARSER` methods

Example 11-9 Parsing an XML Document

```

DECLARE
    indoc    VARCHAR2(2000);
    indomdoc DBMS_XMLDOM.DOMDocument;
    innode   DBMS_XMLDOM.DOMNode;
    myparser DBMS_XMLPARSER.parser;
    buf      VARCHAR2(2000);
BEGIN
    indoc := '<emp><name>De Selby</name></emp>';
    myParser := DBMS_XMLPARSER.newParser;
    DBMS_XMLPARSER.parseBuffer(myParser, indoc);
  
```

```
indomdoc := DBMS_XMLPARSER.getDocument(myParser);
innode := DBMS_XMLDOM.makeNode(indomdoc);
DBMS_XMLDOM.writeToBuffer(innode, buf);
DBMS_OUTPUT.put_line(buf);
DBMS_XMLDOM.freeDocument(indomdoc);
DBMS_XMLPARSER.freeParser(myParser);
END;
/
```

This produces the following output:

```
<emp><name>De Selby</name></emp>
```

11.4 PL/SQL XSLT Processor for XMLType (DBMS_XSLPROCESSOR)

You can use PL/SQL package `DBMS_XSLPROCESSOR` to transform one XML document to another or to convert XML data into HTML, PDF, or other formats. This package traverses the DOM tree for the document and applies Extensible Stylesheet Language Transformation (XSLT) statements to it to produce the transformed document.

The W3C XSL Recommendation describes rules for transforming a source tree into a result tree. A transformation expressed in XSL is called an **XSLT stylesheet**. The transformation specified is achieved by associating patterns with templates defined in the XSLT stylesheet. A template is instantiated to create part of the result tree. XSLT is widely used to convert XML data to HTML for web browser display.

Note:

Oracle XML DB applications do not require a separate XML parser. However, applications requiring external processing can still use the XML Parser for PL/SQL first to expose the document structure. The XML Parser for PL/SQL in Oracle XML Developer's Kit parses an XML document (or a standalone DTD) so that the XML document can be processed by an application, typically running on the client. PL/SQL APIs for XMLType are used for applications that run on the server and are natively integrated in the database. Benefits of running applications on the server include performance improvements and enhanced access and manipulation options.

See Also:

[Transformation and Validation of XMLType Data](#) (page 7-1)

11.4.1 PL/SQL XSLT Processor for XMLType: Features

PL/SQL XSLT Processor for XMLType (`DBMS_XSLPROCESSOR`) follows the W3C XSLT final recommendation (REC-xslt-19991116). It provides a convenient and efficient way of applying a single XSL stylesheet to multiple documents.

The methods in PL/SQL package `DBMS_XSLPROCESSOR` use PL/SQL data types `PROCESSOR` and `STYLESHEET`, which are specific to the XSL Processor implementation. All `DBMS_XSLPROCESSOR` methods are supported by Oracle XML DB, with the *exception* of method `setErrorLog()`.

See Also:

Oracle Database PL/SQL Packages and Types Reference for descriptions of the individual DBMS_XSLPROCESSOR methods

11.4.2 Using the PL/SQL XSLT Processor API for XMLType (DBMS_XSLPROCESSOR)

You create an XSLT processor, build a `STYLESHEET` object from a DOM document, transform the document using the processor and the stylesheet, and use the DOM API for XMLType to manipulate the result of XSLT processing.

Figure 11-3 (page 11-25) illustrates how to use the XSLT Processor for XMLType (DBMS_XSLPROCESSOR).

Figure 11-3 Using the PL/SQL XSLT Processor for XMLType

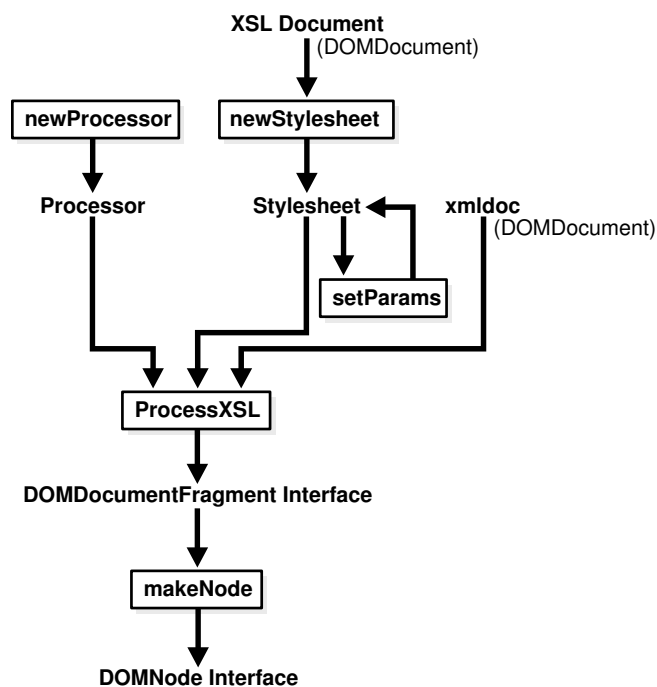

These are the steps:

1. Construct an XSLT processor using `newProcessor`.
2. Use `newStylesheet` to build a `STYLESHEET` object from a DOM document.
3. Optionally, you can set parameters for the `STYLESHEET` object using `setParams`.
4. Use `processXSL` to transform a DOM document using the processor and `STYLESHEET` object.
5. Use the PL/SQL DOM API for XMLType to manipulate the result of XSLT processing.

Example 11-10 (page 11-26) transforms an XML document using procedure `processXSL`. It uses the same parser instance to create two different DOM documents: the XML text to transform and the XSLT stylesheet. An XSL processor instance is created, which applies the stylesheet to the source XML to produce a new DOM fragment. A DOM node (`outnode`) is created from this fragment, and the node

content is printed. The output DOM fragment, parser, and XSLT processor instances are freed using procedures `freeDocFrag`, `freeParser`, and `freeProcessor`, respectively.

Example 11-10 Transforming an XML Document Using an XSL Stylesheet

```

DECLARE
    indoc          VARCHAR2(2000);
    xsl           VARCHAR2(2000);
    myParser      DBMS_XMLPARSER.parser;
    indomdoc      DBMS_XMLDOM.DOMDocument;
    xsltdomdoc    DBMS_XMLDOM.DOMDocument;
    xsl           DBMS_XSLPROCESSOR.stylesheet;
    outdomdocf    DBMS_XMLDOM.DOMDocumentFragment;
    outnode       DBMS_XMLDOM.DOMNode;
    proc          DBMS_XSLPROCESSOR.processor;
    buf           VARCHAR2(2000);
BEGIN
    indoc := '<emp><empno>1</empno>
             <fname>robert</fname>
             <lname>smith</lname>
             <sal>1000</sal>
             <job>engineer</job>
             </emp>';
    xsl := '<?xml version="1.0"?>
           <xsl:stylesheet version="1.0"
                xmlns:xsl="http://www.w3.org/1999/XSL/Transform">
           <xsl:output encoding="utf-8"/>
           <!-- alphabetizes an xml tree -->
           <xsl:template match="*">
               <xsl:copy>
                   <xsl:apply-templates select="*|text()"
                       <xsl:sort select="name(.)" data-type="text"
                               order="ascending"/>
                   </xsl:apply-templates>
               </xsl:copy>
           </xsl:template>
           <xsl:template match="text()">
               <xsl:value-of select="normalize-space(.)"/>
           </xsl:template>
           </xsl:stylesheet>';
    myParser := DBMS_XMLPARSER.newParser;
    DBMS_XMLPARSER.parseBuffer(myParser, indoc);
    indomdoc := DBMS_XMLPARSER.getDocument(myParser);
    DBMS_XMLPARSER.parseBuffer(myParser, xsl);
    xsltdomdoc := DBMS_XMLPARSER.getDocument(myParser);
    xsl := DBMS_XSLPROCESSOR.newStyleSheet(xsltdomdoc, '');
    proc := DBMS_XSLPROCESSOR.newProcessor;
    --apply stylesheet to DOM document
    outdomdocf := DBMS_XSLPROCESSOR.processXSL(proc, xsl, indomdoc);
    outnode := DBMS_XMLDOM.makeNode(outdomdocf);
    -- PL/SQL DOM API for XMLType can be used here
    DBMS_XMLDOM.writeToBuffer(outnode, buf);
    DBMS_OUTPUT.put_line(buf);
    DBMS_XMLDOM.freeDocument(indomdoc);
    DBMS_XMLDOM.freeDocument(xsltdomdoc);
    DBMS_XMLDOM.freeDocFrag(outdomdocf);
    DBMS_XMLPARSER.freeParser(myParser);
    DBMS_XSLPROCESSOR.freeProcessor(proc);
END;
/

```

This produces the following output:

```
<emp>  
<empno>1</empno>  
<fname>robert</fname>  
<job>engineer</job>  
<lname>smith</lname>  
<sal>1000</sal>  
</emp>
```

PL/SQL Package DBMS_XMLSTORE

You can use PL/SQL package `DBMS_XMLSTORE` to insert, update, or delete data from XML documents stored object-relationally. It uses a canonical XML mapping similar to the one produced by package `DBMS_XMLGEN`. It converts the mapping to object-relational constructs and then inserts, updates or deletes the corresponding values in relational tables.

- [Using Package DBMS_XMLSTORE](#) (page 12-1)
- [Inserting an XML Document Using DBMS_XMLSTORE](#) (page 12-2)
- [Updating XML Data Using DBMS_XMLSTORE](#) (page 12-3)
- [Deleting XML Data Using DBMS_XMLSTORE](#) (page 12-4)

12.1 Using Package DBMS_XMLSTORE

Create a context handle, perform one or more insertions, updates, or deletions, and then close the context,

To use PL/SQL package `DBMS_XMLSTORE`, follow these steps:

1. Create a context handle by calling function `DBMS_XMLSTORE.newContext` and supplying it with the table name to use for the DML operations. For case sensitivity, double quotation mark (") the string that is passed to the function.

By default, XML documents are expected to use the `<ROW>` tag to identify rows. This is the same default used by package `DBMS_XMLGEN` when generating XML data. You can use function `setRowTag` to override this behavior.

2. (Optional) Perform one or more insertions, updates or deletions (you can *repeat* this step):

- For *insertions*, to improve performance you can specify the list of columns to insert by calling procedure `DBMS_XMLSTORE.setUpdateColumn` for each column. The default behavior (if you do not specify the list of columns) is to insert values for each column whose corresponding element is present in the XML document.
- For *updates*, use function `DBMS_XMLSTORE.setKeyColumn` to specify one or more (pseudo-) key columns, which are used to specify the *rows* to update. You do this in the `WHERE` clause of a SQL `UPDATE` statement. The columns that you specify need not be keys of the table, but together they must uniquely specify the rows to update.

For example, in table `employees`, column `employee_id` uniquely identifies rows (it is a key of the table). If the XML document that you use to update the table contains element `<EMPLOYEE_ID>2176</EMPLOYEE_ID>`, then the rows where `employee_id` equals 2176 are updated.

To improve performance, you can also specify the list of update columns using DBMS_XMLSTORE . **setUpdateColumn**. The default behavior is to update *all* of the columns in the row(s) identified by `setKeyColumn` whose corresponding elements are present in the XML document.

- For *deletions* you specify (pseudo-) key columns to identify the row(s) to delete. You do this the same way you specify rows to update (see previous).
3. Provide a document to PL/SQL function `insertXML`, `updateXML`, or `deleteXML`. You can *repeat* this step to update several XML documents.
 4. Close the context by calling function DBMS_XMLSTORE . **closeContext**.

12.2 Inserting an XML Document Using DBMS_XMLSTORE

You can use PL/SQL package DBMS_XMLSTORE to insert an XML document into a table or view. It parses the document and creates an INSERT statement into which it binds the values. By default, it inserts values into all of the columns represented by elements in the XML document.

Example 12-1 (page 12-2) uses DBM_XMLSTORE to insert the information for two new employees into the employees table. The information to insert is provided as XML data.

Example 12-1 Inserting Data with Specified Columns

```
SELECT employee_id AS EMP_ID, salary, hire_date, job_id, email, last_name
FROM employees WHERE department_id = 30;
```

EMP_ID	SALARY	HIRE_DATE	JOB_ID	EMAIL	LAST_NAME
114	11000	07-DEC-94	PU_MAN	DRAPHEAL	Raphaely
115	3100	18-MAY-95	PU_CLERK	AKHOO	Khoo
116	2900	24-DEC-97	PU_CLERK	SBAIDA	Baida
117	2800	24-JUL-97	PU_CLERK	STOBIAS	Tobias
118	2600	15-NOV-98	PU_CLERK	GHIMURO	Himuro
119	2500	10-AUG-99	PU_CLERK	KCOLMENA	Colmenares

6 rows selected.

```
DECLARE
insCtx DBMS_XMLSTORE.ctxType;
rows NUMBER;
xmlDoc CLOB :=
'<ROWSET>
  <ROW num="1">
    <EMPLOYEE_ID>920</EMPLOYEE_ID>
    <SALARY>1800</SALARY>
    <DEPARTMENT_ID>30</DEPARTMENT_ID>
    <HIRE_DATE>17-DEC-2002</HIRE_DATE>
    <LAST_NAME>Strauss</LAST_NAME>
    <EMAIL>JSTRAUSS</EMAIL>
    <JOB_ID>ST_CLERK</JOB_ID>
  </ROW>
<ROW>
  <EMPLOYEE_ID>921</EMPLOYEE_ID>
  <SALARY>2000</SALARY>
  <DEPARTMENT_ID>30</DEPARTMENT_ID>
  <HIRE_DATE>31-DEC-2004</HIRE_DATE>
  <LAST_NAME>Jones</LAST_NAME>
  <EMAIL>EJONES</EMAIL>
```

```

        <JOB_ID>ST_CLERK</JOB_ID>
    </ROW>
</ROWSET>';
BEGIN
    insCtx := DBMS_XMLSTORE.newContext('HR.EMPLOYEES'); -- Get saved context
    DBMS_XMLSTORE.clearUpdateColumnList(insCtx); -- Clear the update settings

    -- Set the columns to be updated as a list of values
    DBMS_XMLSTORE.setUpdateColumn(insCtx, 'EMPLOYEE_ID');
    DBMS_XMLSTORE.setUpdateColumn(insCtx, 'SALARY');
    DBMS_XMLSTORE.setUpdateColumn(insCtx, 'HIRE_DATE');
    DBMS_XMLSTORE.setUpdateColumn(insCtx, 'DEPARTMENT_ID');
    DBMS_XMLSTORE.setUpdateColumn(insCtx, 'JOB_ID');
    DBMS_XMLSTORE.setUpdateColumn(insCtx, 'EMAIL');
    DBMS_XMLSTORE.setUpdateColumn(insCtx, 'LAST_NAME');

    -- Insert the doc.
    rows := DBMS_XMLSTORE.insertXML(insCtx, xmlDoc);
    DBMS_OUTPUT.put_line(rows || ' rows inserted.');
```

```

    -- Close the context
    DBMS_XMLSTORE.closeContext(insCtx);
END;
/
```

2 rows inserted.

PL/SQL procedure successfully completed.

```

SELECT employee_id AS EMP_ID, salary, hire_date, job_id, email, last_name
FROM employees WHERE department_id = 30;
```

EMP_ID	SALARY	HIRE_DATE	JOB_ID	EMAIL	LAST_NAME
114	11000	07-DEC-94	PU_MAN	DRAPHEAL	Raphaely
115	3100	18-MAY-95	PU_CLERK	AKHOO	Khoo
116	2900	24-DEC-97	PU_CLERK	SBaida	Baida
117	2800	24-JUL-97	PU_CLERK	STOBIAS	Tobias
118	2600	15-NOV-98	PU_CLERK	GHIMURO	Himuro
119	2500	10-AUG-99	PU_CLERK	KCOLMENA	Colmenares
920	1800	17-DEC-02	ST_CLERK	STRAUSS	Strauss
921	2000	31-DEC-04	ST_CLERK	EJONES	Jones

8 rows selected.

12.3 Updating XML Data Using DBMS_XMLSTORE

You can use PL/SQL package DBMS_XMLSTORE to update (modify) existing data. You specify which rows to update by calling procedure `setKeyColumn` once for *each* of the columns that are used collectively to identify the row. (In SQL, you would specify the rows using a WHERE clause in an UPDATE statement.)

You can think of this set of columns as acting like a set of key columns: *together, they specify a unique row* to be updated. However, the columns that you use (with `setKeyColumn`) need *not* be keys of the table — as long as they uniquely specify a row, they can be used with calls to `setKeyColumn`.

[Example 12-2](#) (page 12-4) uses DBM_XMLSTORE to update information. Assuming that the first name for employee number 188 is incorrectly recorded as Kelly, this example corrects that first name to Pat. Since column `employee_id` is a primary key

for table `employees`, a single call to `setKeyColumn` specifying column `employee_id` is sufficient to identify a unique row for updating.

The following UPDATE statement is equivalent to the use of `DBM_XMLSTORE` in [Example 12-2](#) (page 12-4):

```
UPDATE hr.employees SET first_name = 'Pat' WHERE employee_id = 188;
```

Example 12-2 Updating Data with Key Columns

```
SELECT employee_id, first_name FROM employees WHERE employee_id = 188;
```

```
EMPLOYEE_ID FIRST_NAME
-----
          188 Kelly
```

1 row selected.

```
DECLARE
  updCtx DBMS_XMLSTORE.ctxType;
  rows NUMBER;
  xmlDoc CLOB :=
    '<ROWSET>
      <ROW>
        <EMPLOYEE_ID>188</EMPLOYEE_ID>
        <FIRST_NAME>Pat</FIRST_NAME>
      </ROW>
    </ROWSET>';
BEGIN
  updCtx := DBMS_XMLSTORE.newContext('HR.EMPLOYEES'); -- get the context
  DBMS_XMLSTORE.clearUpdateColumnList(updCtx);      -- clear update settings

  -- Specify that column employee_id is a "key" to identify the row to update.
  DBMS_XMLSTORE.setKeyColumn(updCtx, 'EMPLOYEE_ID');
  rows := DBMS_XMLSTORE.updateXML(updCtx, xmlDoc); -- update the table
  DBMS_XMLSTORE.closeContext(updCtx);             -- close the context
END;
```

```
SELECT employee_id, first_name FROM employees WHERE employee_id = 188;
```

```
EMPLOYEE_ID FIRST_NAME
-----
          188 Pat
```

1 row selected.

12.4 Deleting XML Data Using DBMS_XMLSTORE

You can use PL/SQL package `DBMS_XMLSTORE` to delete existing data. You specify which rows to delete by calling procedure `setKeyColumn` once for *each* of the columns that are used collectively to identify the row. (In SQL, you would specify the rows using a WHERE clause in an UPDATE statement.)

Example 12-3 DBMS_XMLSTORE.DELETXML Example

```
SELECT employee_id FROM employees WHERE employee_id = 188;
```

```
EMPLOYEE_ID
-----
          188
```

1 row selected.

```
DECLARE
delCtx DBMS_XMLSTORE.ctxType;
rows NUMBER;
xmlDoc CLOB :=
'<ROWSET>
  <ROW>
    <EMPLOYEE_ID>188</EMPLOYEE_ID>
    <DEPARTMENT_ID>50</DEPARTMENT_ID>
  </ROW>
</ROWSET>';
BEGIN
delCtx := DBMS_XMLSTORE.newContext('HR.EMPLOYEES');
DBMS_XMLSTORE.setKeyColumn(delCtx, 'EMPLOYEE_ID');
rows := DBMS_XMLSTORE.deleteXML(delCtx, xmlDoc);
DBMS_XMLSTORE.closeContext(delCtx);
END;
/

SELECT employee_id FROM employees WHERE employee_id = 188;

no rows selected.
```

Java DOM API for XMLType

The Java DOM API for `XMLType` lets you operate on `XMLType` instances using a DOM. You can use it to manipulate XML data in Java, including fetching it through Java Database Connectivity (JDBC).

- [Overview of Java DOM API for XMLType](#) (page 13-1)
- [Access to XMLType Data Using JDBC](#) (page 13-2)
- [Manipulating XML Database Documents Using JDBC](#) (page 13-4)
- [Loading a Large XML Document into the Database Using JDBC](#) (page 13-8)
- [MS Windows Java Security Manager Permissions for Java DOM API with a Thick Connection](#) (page 13-9)
- [Creating XML Schema-Based Documents](#) (page 13-10)
- [Classes of Java DOM API for XMLType](#) (page 13-11)
- [Using the Java DOM API for XMLType](#) (page 13-12)
- [Large XML Node Handling with Java](#) (page 13-13)
- [Using the Java DOM API and JDBC with Binary XML](#) (page 13-17)

See Also:

[Using XQuery with XQJ to Access Database Data](#) (page 5-23)

13.1 Overview of Java DOM API for XMLType

Oracle XML DB supports the Java Document Object Model (DOM) Application Program Interface (API) for `XMLType`. This is a generic API for client and server, for both XML Schema-based and non-schema-based documents.

DOM is a tree-based object representation of XML documents in dynamic memory that enables programmatic access to their elements and attributes. The DOM object and interface are part of a W3C recommendation. As discussed in [PL/SQL APIs for XMLType](#) (page 11-1), the Oracle XML DB DOM APIs are compliant with the W3C DOM Level 1.0 and Level 2.0 Core Recommendation.

The Java DOM API for `XMLType` handles all well-formed XML documents stored in Oracle XML DB. It presents a uniform view of an XML document, whether it is XML Schema-based or non-schema-based and whatever the underlying `XMLType` storage model. The Java DOM API works on both client and server.

The Java DOM API for XMLType can be used to construct an XMLType instance from data encoded in different character sets.

You can use the Java DOM API for XMLType to access XML documents stored in Oracle XML DB Repository from Java applications. Naming conforms to the Java binding for DOM as specified by the W3C DOM Recommendation. The repository can contain both XML schema-based and non-schema-based documents.

To access XMLType data using JDBC, use the class `oracle.xml.db.XMLType`.

The Java DOM API for XMLType is implemented using Java package `oracle.xml.parser.v2`.

See Also:

Oracle Database XML Java API Reference

13.2 Access to XMLType Data Using JDBC

Java Database Connectivity (JDBC) is a SQL-based way for Java applications to access any data in Oracle Database, including XML documents in Oracle XML DB.

You use Java class `oracle.xml.db.XMLType` or Java interface `java.sql.SQLXML` to create XML data.

The JDBC 4.0 standard data type for XML data is `java.sql.SQLXML`. Method `getObject()` returns an object of type `oracle.xml.db.XMLType`. Starting with Oracle Database 11g Release 2 (11.2.0.3), `oracle.xml.db.XMLType` implements interface `java.sql.SQLXML`.

13.2.1 Using JDBC to Access XML Documents in Oracle XML DB

JDBC users can query an XMLType table to obtain a JDBC XMLType interface that supports all SQL/XML functions supported by SQL data type XMLType. The Java (JDBC) API for XMLType interface can implement the DOM document interface.

[Example 13-1](#) (page 13-2) illustrates how to use JDBC to query an XMLType table.

You can select XMLType data using JDBC in any of these ways:

- Use SQL/XML function `XMLSerialize` in SQL, and obtain the result as an `oracle.jdbc.OracleClob` or `java.lang.String` instance in Java. The Java snippet in [Example 13-2](#) (page 13-3) illustrates this.
- Call method `getSQLXML()` in the `ResultSet` to obtain the whole `SQLXML` instance. The return value of this method is of type `java.sql.SQLXML`. Then you can use Java methods in interface `SQLXML` to access the data. [Example 13-3](#) (page 13-3) shows how to do this.

[Example 13-3](#) (page 13-3) shows the use of method `getObject()` to directly obtain an XMLType instance from `ResultSet`.

[Example 13-4](#) (page 13-3) shows how to bind an output parameter of type XMLType to a SQL statement. The output parameter is registered as having data type XMLType.

Example 13-1 Querying an XMLType Table Using JDBC

```
PreparedStatement statement = connection.prepareStatement("SELECT e.poDoc FROM  
po_xml_tab e");
```

```
ResultSet resultSet = statement.executeQuery();
```



```

while(resultSet.next())
{
    // Get result as SQLXML data.
    // Use that to get a DomSource instance.
    SQLXML sqlXml = resultSet.getSQLXML(1);
    DomSource source = sqlXml.getSource(DomSource.class);

    // Get document from the DomSource instance as a DOM node.
    Document document = (Document) source.getNode();

    // Use the document object
    ...
}

```

Example 13-2 Selecting XMLType Data Using getString() and getCLOB()

```

PreparedStatement statement = connection.prepareStatement(
    "SELECT XMLSerialize(DOCUMENT e.poDoc AS CLOB) poDoc, " +
    "XMLSerialize(DOCUMENT e.poDoc AS VARCHAR2(2000)) poString " +
    " FROM po_xml_tab e");

ResultSet resultSet = statement.executeQuery();
while(resultSet.next())
{
    // The first result is an OracleClob instance
    OracleClob clob = resultSet.getClob(1);

    // The second result is a String instance
    String poString = resultSet.getString(2);

    // Use clob and poString
    ...
}

```

Example 13-3 Returning XMLType Data Using getSQLXML()

```

PreparedStatement statement = connection.prepareStatement(
    "SELECT e.poDoc FROM po_xml_tab e");

ResultSet resultSet = statement.executeQuery();

while(resultSet.next())
{
    // Get the SQLXML
    SQLXML sqlXml = resultSet.getSQLXML(1);

    // Convert the SQLXML to an xmlString instance
    String xmlString = sqlXml.getString();

    //Use the xmlString instance
    ...
}

```

Example 13-4 Returning XMLType Data Using an Output Parameter

```

public void doCall (String[] args) throws Exception
{
    // CREATE OR REPLACE FUNCTION getPurchaseOrder(reference VARCHAR2)
    // RETURN XMLTYPE
    // AS
    //     xml XMLTYPE;

```

```

// BEGIN
//   SELECT OBJECT_VALUE INTO xml
//   FROM purchaseorder
//   WHERE XMLCast(XMLQuery('$p/PurchaseOrder/Reference'
//   PASSING OBJECT_VALUE AS "p" RETURNING CONTENT)
//   AS VARCHAR2(30))
//   = reference;
//   RETURN xml;
// END;

String SQLTEXT = "{? = call getPurchaseOrder('BLAKE-2002100912333601PDT')}";
super.doSomething(args);
createConnection();
try
{
    System.out.println("SQL := " + SQLTEXT);
    CallableStatement sqlStatement = getConnection().prepareCall(SQLTEXT);
    sqlStatement.registerOutParameter(1, java.sql.Types.SQLXML);
    sqlStatement.execute();

    SQLXML sqlXml = sqlStatement.getSQLXML(1);
    System.out.println(sqlXml.getString());
}
catch (SQLException exception)
{
    if (sqlStatement != null)
    {
        sqlStatement.close();
        throw exception;
    }
}
}

```

13.3 Manipulating XML Database Documents Using JDBC

You can update, insert, and delete XMLType data stored in the database using Java Database Connectivity (JDBC) with Oracle XML DB.

Note:

XMLType method `transform()` works only with the OCI driver.

Not all `oracle.xdb.XMLType` functions are supported by the thin JDBC driver. If you do not use `oracle.xdb.XMLType` classes and the OCI driver, you could lose performance benefits associated with the intelligent handling of XML.

You can update, insert, or delete XMLType data in either of these ways:

- Bind a string to an INSERT, UPDATE, or DELETE statement, and use the XMLType constructor inside SQL to construct the XML instance. [Example 13-5](#) (page 13-5) illustrates this.
- Use `setSQLXML()` in a PreparedStatement instance to set an entire XMLType instance. [Example 13-6](#) (page 13-5) illustrates this.

When selecting SQLXML values, JDBC describes the column as SQLXML. You can select the column type name and compare it with SQLXML to see whether you are dealing with a SQLXML instance. [Example 13-7](#) (page 13-5) illustrates this.

[Example 13-8](#) (page 13-5) updates element `discount` inside element `PurchaseOrder` stored in an `XMLType` column. It uses JDBC and `SQLXML`. It uses the XML parser to update a DOM tree and write the updated XML value to the `XMLType` column.

[Example 13-9](#) (page 13-7) shows the updated purchase order that results from [Example 13-8](#) (page 13-5).

Example 13-5 Updating an XMLType Column Using SQL Constructor XMLType and Java String

```
PreparedStatement statement =
    connection.prepareStatement("UPDATE po_xml_tab SET poDoc = XMLType(?);

String poString = "<PO><PONO>200</PONO><PNAME>PO_2</PNAME></PO>";

// Bind the string
statement.setString(1,poString);
statement.execute();
```

Example 13-6 Updating an XMLType Column Using SQLXML

```
PreparedStatement statement =
    connection.prepareStatement("UPDATE po_xml_tab SET poDoc = ?");

String xmlString = "<PO><PONO>200</PONO><PNAME>PO_2</PNAME></PO>";
SQLXML sqlXml = connection.createSQLXML();
sqlXml.setString(xmlString);

// Bind the SQLXML
statement.setSQLXML(1, sqlXml);
statement.execute();
```

Example 13-7 Retrieving Metadata About an XMLType Column Using JDBC

```
PreparedStatement statement =
    connection.prepareStatement("SELECT poDoc FROM po_xml_tab");
ResultSet resultSet = statement.executeQuery();

// Get the resultSet metadata
ResultSetMetaData mdata = (ResultSetMetaData)resultSet.getMetaData();

// The column type is SQLXML
if (mdata.getColumnType(1) == java.sql.Types.SQLXML)
{
    // It is a SQLXML instance
}
```

Example 13-8 Updating an XMLType Column Using JDBC

```
public class UpdateXMLType
{
    static String qryStr =
        "SELECT x.poDoc from po_xml_tab x " +
        "WHERE XMLCast(XMLQuery('/PO/PONO/text()'" +
        " PASSING x.poDoc RETURNING CONTENT)" +
        " AS NUMBER)" +
        " = 200";

    static String updateXML(String xmlTypeStr)
    {
        System.out.println("\n=====");
```

```

System.out.println(xmlTypeStr);
System.out.println("=====");
String outXML = null;

try
{
    DOMParser parser = new DOMParser();
    parser.setValidationMode(false);
    parser.setPreserveWhitespace (true);
    parser.parse(new StringReader(xmlTypeStr));

    System.out.println("XML string is well-formed");
    XMLDocument document = parser.getDocument();
    NodeList nl = document.getElementsByTagName("DISCOUNT");

    for(int i=0;i<nl.getLength();i++)    {
        XMLElement discount = (XMLElement)nl.item(i);
        XMLNode textNode    = (XMLNode)discount.getFirstChild();
        textNode.setNodeValue("10");
    }

    StringWriter sw = new StringWriter();
    document.print(new PrintWriter(sw));
    outXML = sw.toString();

    //Print modified xml
    System.out.println("\n=====");
    System.out.println("Updated PurchaseOrder:");
    System.out.println(outXML);
    System.out.println("=====");
}
catch (Exception e)
{
    e.printStackTrace(System.out);
}
return outXML;
}

public static void main(String args[]) throws Exception
{
    try
    {
        PreparedStatement statement = connection.createStatement();
        ResultSet resultSet = statement.executeQuery(qryStr);

        while(resultSet.next())
        {
            //retrieve PurchaseOrder xml document from database
            SQLXML sqlXml = resultSet.getSQLXML(1);

            //store this PurchaseOrder in po_xml_hist table
            statement = connection.prepareStatement("INSERT INTO po_xml_hist VALUES(?)");
            statement.setSQLXML(1,sqlXml); // bind the SQLXML instance
            statement.execute();

            //update "DISCOUNT" element
            String newXML = updateXML(sqlXml.getString());
            // create a new instance of an XMLtype from the updated value
            SQLXML sqlXml2 = connection.createSQLXML();
            sqlXml2.setString(newXml);
        }
    }
}

```

```

// update PurchaseOrder xml document in database
statement = connection.prepareStatement(
    "UPDATE po_xml_tab x SET x.poDoc =? WHERE " +
    "XMLCast(XMLQuery('/PO/PONO/text()'" +
    " PASSING value(xmltab) RETURNING CONTENT)" +
    " AS NUMBER)" +
    "= 200");

statement.setSQLXML(1, sqlXml2); // bind the XMLType instance
statement.execute();
connection.commit();
System.out.println("PurchaseOrder 200 Updated!");
}

//delete PurchaseOrder 1001
statement.execute("DELETE FROM po_xml x WHERE " +
    "XMLCast(XMLQuery('/PurchaseOrder/PONO/text()'" +
    " PASSING value(xmltab) RETURNING CONTENT)" +
    " AS NUMBER)" +
    "= 1001");

System.out.println("PurchaseOrder 1001 deleted!");
}
catch(Exception e)
{
    e.printStackTrace(System.out);
}
}
}

```

Example 13-9 Updated Purchase-Order Document

```

<?xml version = "1.0"?>
<PurchaseOrder>
  <PONO>200</PONO>
  <CUSTOMER>
    <CUSTNO>2</CUSTNO>
    <CUSTNAME>John Nike</CUSTNAME>
    <ADDRESS>
      <STREET>323 College Drive</STREET>
      <CITY>Edison</CITY>
      <STATE>NJ</STATE>
      <ZIP>08820</ZIP>
    </ADDRESS>
    <PHONELIST>
      <VARCHAR2>609-555-1212</VARCHAR2>
      <VARCHAR2>201-555-1212</VARCHAR2>
    </PHONELIST>
  </CUSTOMER>
  <ORDERDATE>20-APR-97</ORDERDATE>
  <SHIPDATE>20-MAY-97 12.00.00.000000 AM</SHIPDATE>
  <LINEITEMS>
    <LINEITEM_TYP LineItemNo="1">
      <ITEM StockNo="1004">
        <PRICE>6750</PRICE>
        <TAXRATE>2</TAXRATE>
      </ITEM>
      <QUANTITY>1</QUANTITY>
      <DISCOUNT>10</DISCOUNT>
    </LINEITEM_TYP>
    <LINEITEM_TYP LineItemNo="2">

```

```
<ITEM StockNo="1011">
  <PRICE>4500.23</PRICE>
  <TAXRATE>2</TAXRATE>
</ITEM>
<QUANTITY>2</QUANTITY>
<DISCOUNT>10</DISCOUNT>
</LINEITEM_TYP>
</LINEITEMS>
<SHIPTOADDR>
  <STREET>55 Madison Ave</STREET>
  <CITY>Madison</CITY>
  <STATE>WI</STATE>
  <ZIP>53715</ZIP>
</SHIPTOADDR>
</PurchaseOrder>
```

13.4 Loading a Large XML Document into the Database Using JDBC

To load a large XML document into the database using Java Database Connectivity (JDBC), use a Java CLOB object to hold the document, and use Java method `insertXML()` to perform the insertion.

If a large XML document (greater than 4000 characters, typically) is inserted into an XMLType table or column using a String object in JDBC, this run-time error occurs:

```
"java.sql.SQLException: Data size bigger than max size for this type"
```

This error can be avoided by using a Java `OracleClob` object to hold the large XML document. [Example 13-10](#) (page 13-9) shows code that uses this technique. It defines XMLType method `insertXML()`, which can be used to insert a large XML document into XMLType column `purchaseOrder` of table `poTable`. The same approach can be used for an XMLType table.

Method `insertXML()` uses an `OracleClob` object that contains the XML document. Interface `OracleClob` is a sub-interface of the standard JDBC interface `java.sql.Clob`. Method `insertXML()` binds the `OracleClob` object to a JDBC prepared statement, which inserts the data into the XMLType column.

The prerequisites for using `insertXML()` are as follows:

- Oracle Database, release 9.2.0.1 or later.
- The target database table. Execute the following SQL before running the example:

```
CREATE TABLE poTable (purchaseOrder XMLType);
```

The formal parameters of XMLType method `insertXML()` are as follows:

- *xmlString* – XML data to be inserted into the XMLType column
- *connection* – database connection object (Oracle Connection Object)

Java method `insertXML()` calls method `getCLOB()` to create and return the CLOB object that holds the XML data. The formal parameters of method `getCLOB()`, which is defined in [Example 13-11](#) (page 13-9), are as follows:

- *xmlString* – XML data to be inserted into the XMLType column
- *connection* – database connection object (Oracle Connection Object)

See Also:*Oracle Database SecureFiles and Large Objects Developer's Guide***Example 13-10 Inserting an XMLType column using JDBC**

```

private void insertXML(Connection connection, String xmlString)
{
    OracleClob clob = null;
    try
    {
        String query = "INSERT INTO potable (purchaseOrder) VALUES (XMLType(?) )";

        // Get the statement Object
        PreparedStatement statement = connection.prepareStatement(query);

        // Get the OracleClob instance from xmlString
        clob = getOracleClob(connection, xmlString);
        statement.setObject(1, clob);

        // Execute the prepared statement
        if (statement.executeUpdate () == 1)
        {
            System.out.println ("Successfully inserted a Purchase Order");
        }
    }
    catch(Exception exp)
    {
        exp.printStackTrace();
    }
    finally
    {
        if(clob !=null)
            clob.close();
    }
}

```

Example 13-11 Converting an XML String to an OracleClob Instance

```

private OracleClob getOracleClob(Connection connection, String xmlString) throws
SQLException
{
    OracleClob clob =(OracleClob) connection.createClob();
    clob.setString(1, xmlString);
    return clob;
}

```

13.5 MS Windows Java Security Manager Permissions for Java DOM API with a Thick Connection

If you use Java Security Manager (class `SecurityManager`) on MS Windows to implement a security policy for your application, then you must add certain permissions to your security policy file, in order to use the Java DOM API for `XMLType` with a thick connection.

[Example 13-12](#) (page 13-10) shows the contents of such a policy file, where the workspace folder that contains the jars related to Oracle XML DB is `c:\myworkspace`. (The policy file must be in the same folder.)

The libraries used in [Example 13-12](#) (page 13-10) are `orageneric12` and `oraxml12`. The last two characters (12 here) must correspond to your major database release number (so for Oracle Database 13 Release 2, for example, you would use `orageneric13` and `oraxml13`).

After you have created the policy file, you can invoke your program using the following command-line switches:

```
-Djava.security.manager=default -Djava.security.policy=c:\myworkspace\ojdbc.policy
```

Example 13-12 Policy File Granting Permissions for Java DOM API

```
grant codeBase "file:c:\myworkspace" {
    permission java.lang.RuntimePermission "loadLibrary.orageneric12";
    permission java.lang.RuntimePermission "loadLibrary.oraxml12";
}

grant codeBase "file:c:\myworkspace\xdb6.jar" {
    permission java.lang.RuntimePermission "loadLibrary.orageneric12";
    permission java.lang.RuntimePermission "loadLibrary.oraxml12";
}

grant codeBase "file:c:\myworkspace\ojdbc6.jar" {
    permission java.lang.RuntimePermission "loadLibrary.orageneric12";
    permission java.lang.RuntimePermission "loadLibrary.oraxml12";
}
```

13.6 Creating XML Schema-Based Documents

To create XML Schema-based documents, Java DOM API for `XMLType` uses an extension to specify which XML schema URL to use. It also verifies that the DOM being created conforms to the specified XML schema, that is, that the appropriate children are being inserted under the appropriate documents.

Note:

The Java DOM API for `XMLType` does *not* perform type and constraint checks.

Once the DOM object has been created, it can be saved to Oracle XML DB Repository using the Oracle XML DB resource API for Java. The XML document is stored in the appropriate format:

- As a BLOB instance for non-schema-based documents.
- In the format specified by the XML schema for XML schema-based documents.

[Example 13-13](#) (page 13-10) shows how you can use the Java DOM API for `XMLType` to create a DOM object and store it in the format specified by the associated XML schema. Validation against the XML schema is not shown here.

Example 13-13 Creating a DOM Object with the Java DOM API

```
PreparedStatement statement = connection.prepareStatement(
    "update po_xml_XMLType set poDoc = ?");
String xmlString = "<PO><PONO>200</PONO><PNAME>PO_2</PNAME></PO>";

OracleClob clob = (OracleClob)connection.createClob();
clob.setString(1, xmlString);
SQLXML sqlXml = clob.toSQLXML();
```



```

DOMSource domSource = sqlXml.getSource(DOMSource.class);
Document document = (Document) domSource.getNode();
Element rootElem = document.createElement("PO");
document.insertBefore(document, rootElem, null);

SQLXML sqlXml2 = clob.toSQLXML();

DOMResult domResult = sqlXml2.setResult(DOMResult.class);
domResult.setNode(document);
statement.setSQLXML(1, sqlXml2);
statement.execute();

```

13.7 XMLType Instance Representation in Java (JDBC or SQLJ)

An XMLType instance is represented in Java by `oracle.xml.db.XMLType`. When an instance of XMLType is fetched using JDBC or a SQLJ client, it is automatically manifested as an object of the provided XMLType class.

You can bind objects of this class as values to Data Manipulation Language (DML) statements where an XMLType is expected.

13.8 Classes of Java DOM API for XMLType

Oracle XML DB supports the W3C DOM Level 2 Recommendation. It also provides Oracle-specific extensions, to facilitate interfacing your application with Oracle XML Developer's Kit for Java. The Java DOM API for XMLType provides classes that implement W3C DOM interfaces.

A list of the Oracle extensions is available at:

<http://www.oracle.com/technetwork/database-features/xmlldb/overview/index.html>

XMLDocument is a class that represents the DOM for the instantiated XML document. You can retrieve a SQLXML instance from a document and a connection object as follows:

```

SQLXML sqlXml = connection.createSQLXML();
DOMResult domResult = sqlXml.setResult(DOMResult.class);
domResult.setNode(document);

```

Table 13-1 (page 13-11) lists the Java DOM API for XMLType classes and the W3C DOM interfaces they implement. The Java DOM API classes are in package `oracle.xml.parser.v2`.

Table 13-1 Java DOM API for XMLType: Classes

Java DOM API for XMLType Class	W3C DOM Interface Recommendation Class
XMLDocument	<code>org.w3c.dom.Document</code>
XMLCDATA	<code>org.w3c.dom.CDataSection</code>
XMLComment	<code>org.w3c.dom.Comment</code>

Table 13-1 (Cont.) Java DOM API for XMLType: Classes

Java DOM API for XMLType Class	W3C DOM Interface Recommendation Class
XMLPI	org.w3c.dom.ProcessingInstruction
XMLText	org.w3c.dom.Text
XMLEntity	org.w3c.dom.Entity
DTD	org.w3c.dom.DocumentType
XMLNotation	org.w3c.dom.Notation
XMLAttr	org.w3c.dom.Attribute
XMLDomImplementation	org.w3c.dom.DOMImplementation
XMLElement	org.w3c.dom.Element
XMLAttrList	org.w3c.dom.NamedNodeMap
XMLNode	org.w3c.dom.Node

13.9 Using the Java DOM API for XMLType

Retrieve data from an XMLType table or column and obtain a Java XMLDocument instance from it. Manipulate elements of the DOM tree for the data using the Java DOM API for XMLType.

The Java DOM API for XMLType lets you find and retrieve nodes within a document at any level. You can use it to create XML documents programmatically, including on the fly (dynamically). These documents can conform to a registered XML schema or not. The Java API for XMLType conforms to the DOM 2.0 recommendation, and it is namespace-aware.

Figure 13-1 (page 13-13) illustrates how to use the Java DOM API for XMLType.¹¹ These are the steps:

1. Retrieve the XML data from the XMLType table or XMLType column in the table. When you fetch XML data, Oracle creates a Document instance. You can then use method `getNode()` to retrieve an XMLDocument instance.

¹¹ This assumes that your XML data is pre-registered with an XML schema, and that it is stored in an XMLType column.

- Use the Java DOM API for `XMLType` to manipulate elements of the DOM tree. The `XMLType` instance holds the modified data, but the data is sent back using a JDBC update.

The `XMLType` and `XMLDocument` instances should be closed using method `free()` in the respective classes. This frees any underlying memory that is held.

Figure 13-1 Using the Java DOM API for XMLType

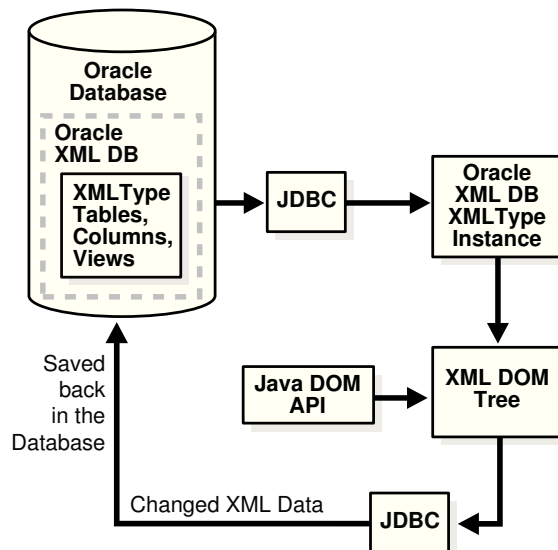

13.10 Large XML Node Handling with Java

Oracle XML DB provides abstract streams and stream-manipulation methods that you can use to handle XML nodes that are larger than 64 K bytes. Use Java classes `XMLNode` and `XMLAttr`, together with a thick or `kprb` connection, to manipulate large nodes.

Note:

The large-node feature works only with a thick or `kprb` connection. It does not work with a thin connection.

Prior to Oracle Database 11g Release 1 (11.1), each text node or attribute value processed by Oracle XML DB was limited in size to 64 K bytes. Starting with release 11.1, this restriction no longer applies.

The former restrictions on the size of nodes were because the Java methods to set and get a node value supported only arguments of type `java.lang.String`. The maximum size of a string is dependent on the implementation of the Java VM, but it is bounded. Prior to Release 11.1, the Java DOM APIs to manage a node value, contained within class `oracle.xdb.dom.XDBNode.java`, were these:

```
public String getNodeValue ();
public void setNodeValue (String value);
```

Prior to Release 11.1, the Java DOM APIs to manage an attribute, contained within class `oracle.xdb.dom.XDBAttribute.java`, were these:

```
public String getValue ();  
public void setValue (String value);
```

Package `oracle.xdb.dom` is deprecated, starting with Oracle Database 11g Release 1 (11.1). Java classes `XDBNode` and `XDBAttribute` in that package are replaced by classes `XMLNode` and `XMLAttr`, respectively, in package `oracle.xml.parser.v2`. In addition, these DOM APIs were extended in Release 11.1 to support text and binary node values of arbitrary size.

See Also:

[Large Node Handling Using DBMS_XMLDOM](#) (page 11-15) for information on using PL/SQL with large nodes

13.10.1 Stream Extensions to Java DOM

All Java `String`, `Reader`, and `Writer` data is represented in UCS2, which might be different from the database character set. Additionally, node character data is tagged with a character set id, which is set at the time the node value is populated.

The following methods of `oracle.xml.parser.v2.XMLNode.java` can be used to access nodes of size greater than 64 KB. These APIs throw exceptions if you try to get or set a node that is not a leaf node (attribute, `PI`, `CDATA`, and so on). Also, be sure to use `close()` which actually writes the value and frees resources used to maintain the state for streaming access to nodes.

13.10.1.1 Get-Pull Model

You can use methods `getNodeValueAsBinaryStream()` and `getNodeValueAsCharacterStream()` to retrieve the value of a DOM node, using a parser that is in pull mode. Oracle XML DB reads the event data from an input stream written by the parser.

For a binary input stream:

```
public java.io.InputStream getNodeValueAsBinaryStream ()  
    throws java.io.IOException,  
           DOMException;
```

Method `getNodeValueAsBinaryStream()` returns an instance of `java.io.InputStream` that can be read using the defined methods for this class. The data type of the node must be `RAW` or `BLOB`. If not, an `IOException` is thrown. The following example fragment illustrates reading the value of a node in binary 50-byte segments:

```
...  
oracle.xml.parser.v2.XMLNode node = null;  
...  
java.io.InputStream value = node.getNodeValueAsBinaryStream ();  
// now read InputStream...  
byte buffer [] = new byte [50];  
int returnValue = 0;  
while ((returnValue = value.read (buffer)) != -1)  
{  
    // process next 50 bytes of node  
}  
...  
...
```

For a character input stream:

```
public java.io.Reader getNodeValueAsCharacterStream()
    throws java.io.IOException,
           DOMException;
```

Method `getNodeValueAsCharacterStream()` returns an instance of `java.io.Reader` that can be read using the defined methods for this class. If the data type of the node is neither character nor CLOB, the node data is first converted to character. All node data is ultimately in character format and is converted to UCS2, if necessary. The following example fragment illustrates reading the node value in segments of 50 characters:

```
...
oracle.xml.parser.v2.XMLNode node = null;
...
java.io.Reader value = node.getNodeValueAsCharacterStream ();
// now read InputStream
char buffer [] = new char [50];
int returnValue = 0;
while ((returnValue = value.read (buffer)) != -1)
{
    // process next 50 characters of node
}
...

```

13.10.1.2 Get-Push Model

In this model, you retrieve the value of a DOM node, using a parser that is in push mode. Oracle XML DB writes the node data to an output stream that the parser reads.

For a binary output stream:

```
public void getNodeValueAsBinaryStream (java.io.OutputStream pushValue)
    throws java.io.IOException,
           DOMException;
```

The state of the `java.io.OutputStream` specified by `pushValue` must be open. The data type of the node must be RAW or BLOB. If not, an `IOException` is thrown. The node binary data is written to `pushValue` using method `write()` of `OutputStream`, and method `close()` is called when the node value has been completely written to the stream.

For a character output stream:

```
public void getNodeValueAsCharacterStream (java.io.Writer pushValue)
    throws java.io.IOException,
           DOMException;
```

The state of the `java.io.Writer` specified by `pushValue` must be open. If the data type of the node is neither character nor CLOB, then the data is first converted to character. The node data, always in character format, is converted, as necessary, to UCS2 and then pushed into the `java.io.Writer`.

13.10.1.3 Set-Pull Model

In this model, you set the value of a DOM node, using a parser that is in pull mode. Oracle XML DB reads the event data from an input stream written by the parser.

For a binary input stream:

```
public void setNodeValueAsBinaryStream (java.io.InputStream pullValue)
    throws java.io.IOException,
           DOMException;
```

The state of the `java.io.InputStream` specified by `pullValue` must be open. The data type of the node must be RAW or BLOB. If not, an `IOException` is thrown. The binary data from `pullValue` is read in its entirety using method `read()` of `InputStream` and replaces the node value.

```
import java.io.InputStream;
import oracle.xml.parser.*;
...
oracle.xml.parser.v2.XMLNode node = null;
...
byte [] buffer = new byte [500];
java.io.InputStream istream; //user-defined input stream
node.setNodeValueAsBinaryStream (istream);
```

For a character input stream:

```
public void setNodeValueAsCharacterStream (java.io.Reader pullValue)
    throws java.io.IOException,
           DOMException;
```

The state of the `java.io.Reader` specified by `pullValue` must be open. If the data type of the node is neither character nor CLOB, the character data is converted from UCS2 to the node data type. If the data type of the node is character or CLOB, then the character data read from `pullValue` is converted from UCS2 to the character set of the node.

13.10.1.4 Set-Push Model

In this model, you set the value of a DOM node, using a parser that is in push mode. Oracle XML DB writes the node data to an output stream that the parser reads.

For a binary output stream:

```
public java.io.OutputStream setNodeValueAsBinaryStream ()
    throws java.io.IOException,
           DOMException;
```

Method `setNodeValueAsBinaryStream()` returns an instance of `java.io.OutputStream`, into which the caller can write the node value. The data type of the node must be RAW or BLOB. Otherwise, an `IOException` is raised. The following example fragment illustrates setting the value of a node to binary data by writing to the implementation of `java.io.OutputStream` provided by Oracle XML DB or Oracle XML Developer's Kit.

For a character output stream:

```
public java.io.Writer setNodeValueAsCharacterStream ()
    throws java.io.IOException,
           DOMException;
```

Method `setNodeValueAsCharacterStream()` returns an instance of `java.io.Writer` into which the caller can write the node value. The character data written is first converted from UCS2 to the node character set, if necessary. If the data type of the node is neither character nor CLOB, then the character data is converted to the node data type. Similarly, the following example fragment illustrates setting the value of a node to character data by writing to the implementation of `java.io.Writer` provided by Oracle XML DB or Oracle XML Developer's Kit.

```

import java.io.Writer;
import oracle.xml.parser.*;
...
oracle.xml.parser.v2.XMLNode node = null;
...
char [] buffer = new char [500];
java.io.Writer writer = node.setNodeValueAsCharacterStream ();
for (int k = 0; k < 10; k++)
{
    byte segment [] = new byte [50];
    // copy next subset of buffer into segment
    writer.write (segment);
}
writer.flush ();
writer.close();

```

See Also:

- *Oracle Database XML Java API Reference*
 - *Oracle Database XML C API Reference* for information about C functions for large nodes
-
-

Oracle XML DB creates a writer or `OutputStream` and passes it to the user who calls method `write()` repeatedly until the complete node value has been written. The new node value is reflected only when the user calls method `close()`.

13.11 Using the Java DOM API and JDBC with Binary XML

You can use the Java DOM API for XML and Java Database Connectivity (JDBC) to read or write XML data that is encoded as binary XML from or to Oracle XML DB. Doing so involves the usual read and write procedures.

XML data can be stored in Oracle XML DB using data type `XMLType`, and one of the storage models for this abstract data type is binary XML, a compact, XML Schema-aware encoding of XML data. You can use binary XML as a storage model for `XMLType` in the database, but you can also use it for XML data located outside the database. Client-side processing of XML data can involve data stored in Oracle XML DB or transient data that resides outside the database.

Binary XML is XML Schema-aware and can use various encoding schemes, depending on your needs and your data. Because of this, in order to manipulate binary XML data, you must have both the data and this metadata about the relevant XML schemas and encodings.

For `XMLType` data stored in the database, this metadata is also stored in the database. However, depending on how your database and data are set up, the metadata might not be on the same server as the data it applies to. If this is the case, then, before you can read or write binary XML data from or to the database, you must carry out these steps:

1. Create a context instance for the metadata.
2. Associate this context with a data connection that you use to access binary XML data in the database. A data connection can be a dedicated connection or a connection pool. You use methods `getDedicatedConn()` and `getConnPool()`

in class `java.sql.Connection` to obtain handles to these two types of connection, respectively.

Then, when your application needs to encode or decode binary XML data on the data connection, it automatically fetches the metadata needed for that. The overall sequence of actions is thus as follows:

1. Create an XML data connection object, in class `java.sql.Connection`.
2. Create one or more metadata contexts, as needed, using method `BinXMLMetadataProviderFactory.createDBMetadataProvider()` in package `oracle.xml.binxml`. A metadata context is sometimes referred to as a metadata repository. You can create a metadata context from a dedicated connection or from a connection pool.
3. Associate the metadata context(s) with the binary XML data connection(s). Use method `DBBinXMLMetadataProvider.associateDataConnection()` in package `oracle.xml.binxml` to do this.
4. (Optional) If the XML data originated outside of the database, use method `oracle.xdb.XMLType.setFormatPref()` to specify that XML data to be sent to the database be encoded in the binary XML format. This applies to a DOM document (class `oracle.xdb.XMLType`). If you do not specify binary XML, the data is sent to the database as text.
5. Use the usual Java methods to read and write XML data from and to the database. Whenever it is needed for encoding or decoding binary XML documents, the necessary metadata is fetched automatically using the metadata context.

Use the Java DOM API for XML to operate on the XML data at the client level.

[Example 13-14](#) (page 13-18) illustrates this.

See Also:

- [XMLType Storage Models](#) (page 1-11)
 - *Oracle XML Developer's Kit Programmer's Guide*
-
-

Example 13-14 Using the Java DOM API with a Binary XML Column

```
class PrintBinaryXML
{
    public static void printBinXML() throws SQLException, BinXMLException
    {
        // Create datasource to connect to local database
        OracleDataSource ods = new OracleDataSource();
        ods.setURL("jdbc:oracle:kprb");

        System.out.println("Starting Binary XML Java Example");

        // Create data connection
        Connection connection = ods.getConnection();
        // Create binary XML metadata context, using connection pool
        DBBinXMLMetadataProvider repos =
            BinXMLMetadataProviderFactory.createDBMetadataProvider();
        repos.setConnectionPool(ods);

        // Associate metadata context with data connection
```



```
repos.associateDataConnection(connection);

// Query XML data stored in SQLXML column as binary XML
Statement statement = connection.createStatement();
ResultSet resultSet = statement.executeQuery("SELECT doc FROM po_binxmltab");

// Get the SQLXML object
while (resultSet.next())
{
    SQLXML sqlXml = resultSet.getSQLXML(1);

    // Convert SQLXML to a String
    String xmlString = sqlXml.getString();
    System.out.println(xmlString);
}

resultSet.close();
statement.close();
connection.close();

System.out.println("Completed Binary XML Java Example");
}
}
```

C DOM API for XMLType

The C DOM API for XMLType lets you operate on XMLType instances using a DOM in C.

- [Overview of the C API for XML](#) (page 14-1)
- [Access to XMLType Data Stored in the Database Using OCI](#) (page 14-2)
- [Creating XMLType Instances on the Client](#) (page 14-2)
- [XML Context Parameter for C DOM API Functions](#) (page 14-3)
- [Initializing and Terminating an XML Context](#) (page 14-3)
- [Using the C API for XML with Binary XML](#) (page 14-7)
- [Using the Oracle XML Developer's Kit Pull Parser with Oracle XML DB](#) (page 14-10)
- [Common XMLType Operations in C](#) (page 14-15)

14.1 Overview of the C API for XML

The C API for XML is a DOM API that is used for Oracle XML Developer's Kit (XDK) and Oracle XML DB. You can use it for XML data that is inside or outside the database.

DOM refers to compliance with the World Wide Web Consortium (W3C) DOM 2.0 Recommendation.

The C API for XML also includes performance-improving extensions that you can use in XDK for traditional storage of XML data, or in Oracle XML DB for storage as an XMLType column in a table.

Note:

C DOM functions from releases prior to Oracle Database 10g Release 1 are supported only for backward compatibility.

The C API for XML is implemented on XMLType in Oracle XML DB. In the W3C DOM Recommendation, the term "document" is used in a broad sense (URI, file system, memory buffer, standard input and output). The C API for XML is a combined programming interface that includes all of the functionality needed by Oracle XML Developer's Kit and Oracle XML DB applications. It provides XSLT and XML Schema implementations. Although the DOM 2.0 Recommendation was followed closely, some naming changes were required for mapping from the object-oriented DOM 2.0

Recommendation to the flat C namespace. For example, method `getName()` was renamed to `getAttrName()`.

The C API for XML supersedes older Oracle APIs. In particular, the `oraxml` interface (top-level, DOM, SAX, and XSLT) and `oraxsd.h` (Schema) interfaces will be deprecated in a future release.

The reference documentation for the C and C++ Application Programming Interfaces (APIs) that you can use to manipulate XML data is *Oracle Database XML C API Reference*, and *Oracle Database XML C++ API Reference*.

See Also:

- *Oracle Database PL/SQL Packages and Types Reference* for information about PL/SQL APIs for XML
 - *Oracle Database XML Java API Reference* for information about Java APIs for XML
-
-

14.2 Access to XMLType Data Stored in the Database Using OCI

Oracle XML DB provides support for storing and manipulating XML instances using abstract data type `XMLType`. These XML instances can be accessed and manipulated on the client side using the Oracle Call Interface (OCI) in conjunction with the C DOM API for XML.

You can bind and define `XMLType` values using the C DOM structure `xmlDocNode`. This structure can be used for binding, defining and operating on XML values in OCI statements. You can use OCI statements to select XML data from the server, which you can then use with C DOM API functions. Similarly, values can be bound back to SQL statements directly.

The main flow for an application program involves initializing the usual OCI handles, such as server handle and statement handle, and then initializing an XML context parameter. You can then either operate on XML instances in the database or create new instances on the client side. The initialized XML context can be used with all of the C DOM functions.

See Also:

[XML Context Parameter for C DOM API Functions](#) (page 14-3)

14.3 Creating XMLType Instances on the Client

You can construct new `XMLType` instances on the client side using the C DOM API methods `XMLCreateDocument()` and `XmlLoadDom()`.

You can construct empty `XMLType` instances using `XMLCreateDocument()`. This is similar to using `OCIObjectNew()` for other types.

You construct a non-empty `XMLType` instance using `XmlLoadDom()`, as follows:

1. Initialize the `xmlctx` as in [Example 14-1](#) (page 14-4).
2. Construct the XML data from a user buffer, local file, or URI. The return value, a (`xmlDocNode*`), can be used in the rest of the common C API.

- If required, you can cast (`xmlDocNode *`) to (`void*`) and provide it directly as the bind value.

14.4 XML Context Parameter for C DOM API Functions

An *XML context* is a required parameter for all the C DOM API functions. This opaque context encapsulates information about the data encoding, the error message language, and so on. The contents of the context are different for Oracle XML Developer's Kit applications and Oracle XML DB.

For Oracle XML DB, OCI functions `OCIxmldbInitXmlCtx()` and `OCIxmldbFreeXmlCtx()`, respectively, initialize and terminate an XML context.

14.4.1 OCIxmldbInitXmlCtx() Syntax

OCI function `OCIxmldbInitXmlCtx()` initializes an XML context.

The syntax of `OCIxmldbInitXmlCtx()` is as follows:

```
xmlctx *OCIxmldbInitXMLCtx (OCIEnv      *envhp,
                             OCISvcHp   *svchp,
                             OCIError   *errhp,
                             ocixmlbparam *params,
                             ub4         num_params);
```

Table 14-1 (page 14-3) describes the parameters.

Table 14-1 *OCIxmldbInitXMLCtx() Parameters*

Parameter	Description
<code>envhp (IN)</code>	The OCI environment handle.
<code>svchp (IN)</code>	The OCI service handle.
<code>errhp (IN)</code>	The OCI error handle.
<code>params (IN)</code>	An array of optional values: <ul style="list-style-type: none"> OCI duration. Default value is <code>OCI_DURATION_SESSION</code>. Error handler, which is a user-registered callback: <pre>void (*err_handler) (sword errcode, (CONST OraText *) errmsg);</pre>
<code>num_params (IN)</code>	Number of parameters to be read from <code>params</code> .

14.4.2 OCIxmldbFreeXmlCtx() Syntax

OCI function `OCIxmldbFreeXmlCtx()` terminates an XML context.

The syntax of `OCIxmldbFreeXmlCtx()` is as follows, where parameter `xctx (IN)` is the XML context to terminate.:

```
void OCIxmldbFreeXmlCtx (xmlctx *xctx);
```

14.5 Initializing and Terminating an XML Context

An example illustrates a C program that uses the C DOM API to construct an XML document and save it to Oracle Database.

[Example 14-1](#) (page 14-4) shows this. The document constructed is stored in table `my_table`. OCI functions `OCIXmlDbInitXmlCtx()` and `OCIXmlDbFreeXmlCtx()` are used to initialize and terminate the XML context, respectively. These functions are defined in header file `ocixml.h`.

The code uses helper functions `exec_bind_xml`, `init_oci_handles`, and `free_oci_handles`, which are not listed here. The complete listing of this example, including the helper functions, can be found in [Oracle-Supplied XML Schemas and Examples](#) (page A-1), [Initializing and Terminating an XML Context \(OCI\)](#) (page A-49).

The C code in [Example 14-1](#) (page 14-4) assumes that the following SQL code has first been executed to create table `my_table` in database schema `capiususer`:

```
CONNECT CAPIUSER
Enter password: password

Connected.

CREATE TABLE my_table OF XMLType;
```

[Example 14-4](#) (page 14-15) queries table `my_table` to show the data that was inserted by [Example 14-1](#) (page 14-4).

Example 14-1 Using OCIXMLDBINITXMLCTX() and OCIXMLDBFREEXMLCTX()

```
#ifndef S_ORACLE
#endif
#ifndef ORATYPES_ORACLE
#include <oratypes.h>
#endif
#ifndef XML_ORACLE
#include <xml.h>
#endif
#ifndef OCIXML_ORACLE
#include <ocixml.h>
#endif
#ifndef OCI_ORACLE
#include <oci.h>
#endif
#include <string.h>

typedef struct test_ctx {
    OCIEnv *envhp;
    OCIError *errhp;
    OCISvcCtx *svchp;
    OCIStmt *stmthp;
    OCIError *srvhp;
    OCIDuration dur;
    OCISession *sesshp;
    oratext *username;
    oratext *password;
} test_ctx;

/* Helper function 1: execute a sql statement which binds xml data */
static sword exec_bind_xml(OCISvcCtx *svchp,
                           OCIError *errhp,
                           OCIStmt *stmthp,
                           void *xml,
                           OCIType *xmldo,
                           OraText *sqlstmt);
```

```

/* Helper function 2: Initialize OCI handles and connect */
static sword init_oci_handles(test_ctx *ctx);

/* Helper function 3: Free OCI handles and disconnect */
static sword free_oci_handles(test_ctx *ctx);

void main()
{
    test_ctx temp_ctx;
    test_ctx *ctx = &temp_ctx;
    OCIType *xmltdo = (OCIType *) 0;
    xmldocnode *doc = (xmldocnode *)0;
    ocixmlbparam params[1];
    xmlnode *quux, *foo, *foo_data, *top;
    xmlerr err;
    sword status = 0;
    xmlctx *xctx;

    oratext ins_stmt[] = "insert into my_table values (:1)";
    oratext tlpxml_test_sch[] = "<TOP/>";
    ctx->username = (oratext *)"capiuser";
    ctx->password = (oratext *)"*****"; /* Replace with real password */

    /* Initialize envhp, svchp, errhp, dur, stmthp */
    init_oci_handles(ctx);

    /* Get an xml context */
    params[0].name_ocixmlbparam = XCTXINIT_OCIDUR;
    params[0].value_ocixmlbparam = &ctx->dur;
    xctx = OCIXmlDbInitXmlCtx(ctx->envhp, ctx->svchp, ctx->errhp, params, 1);

    /* Start processing - first, check that this DOM supports XML 1.0 */
    printf("\n\nSupports XML 1.0? : %s\n",
        XmlHasFeature(xctx, (oratext *) "xml", (oratext *) "1.0") ?
        "YES" : "NO");

    /* Parse a document */
    if (!(doc = XmlLoadDom(xctx, &err, "buffer", tlpxml_test_sch,
        "buffer_length", sizeof(tlpxml_test_sch)-1,
        "validate", TRUE, NULL)))
    {
        printf("Parse failed, code %d\n", err);
    }
    else
    {
        /* Get the document element */
        top = (xmlnode *)XmlDomGetDocElem(xctx, doc);

        /* Print out the top element */
        printf("\n\nOriginal top element is :\n");
        XmlSaveDom(xctx, &err, top, "stdio", stdout, NULL);

        /* Print out the document. The changes are reflected here */
        printf("\n\nOriginal document is :\n");
        XmlSaveDom(xctx, &err, (xmlnode *)doc, "stdio", stdout, NULL);

        /* Create some elements and add them to the document */
        quux = (xmlnode *) XmlDomCreateElem(xctx ,doc, (oratext *) "QUUX");
        foo = (xmlnode *) XmlDomCreateElem(xctx, doc, (oratext *) "FOO");
        foo_data = (xmlnode *) XmlDomCreateText(xctx, doc, (oratext *) "data");
        foo_data = XmlDomAppendChild(xctx, (xmlnode *) foo, (xmlnode *) foo_data);
    }
}

```

```

foo = XmlDomAppendChild(xctx, quux, foo);
quux = XmlDomAppendChild(xctx, top, quux);

/* Print out the top element */
printf("\n\nNow the top element is :\n");
XmlSaveDom(xctx, &err, top, "stdio", stdout, NULL);

/* Print out the document. The changes are reflected here */
printf("\n\nNow the document is :\n");
XmlSaveDom(xctx, &err, (xmlnode *)doc, "stdio", stdout, NULL);

/* Insert the document into my_table */
status = OCITypeByName(ctx->envhp, ctx->errhp, ctx->svchp,
                      (const text *) "SYS", (ub4) strlen((char *) "SYS"),
                      (const text *) "XMLTYPE",
                      (ub4) strlen((char *) "XMLTYPE"), (CONST text *) 0,
                      (ub4) 0, OCI_DURATION_SESSION, OCI_TYPEGET_HEADER,
                      (OCIType **) &xmldto);

if (status == OCI_SUCCESS)
{
    exec_bind_xml(ctx->svchp, ctx->errhp, ctx->stmthp, (void *)doc, xmldto,
                 ins_stmt);
}
}
/* Free xml ctx */
OCIXmlDbFreeXmlCtx(xctx);

/* Free envhp, svchp, errhp, stmthp */
free_oci_handles(ctx);
}

```

The output from compiling and running this C program is as follows:

```

Supports XML 1.0? : YES

Original top element is :
<TOP/>

Original document is :
<TOP/>

Now the top element is :
<TOP>
  <QUUX>
    <FOO>data</FOO>
  </QUUX>
</TOP>

Now the document is :
<TOP>
  <QUUX>
    <FOO>data</FOO>
  </QUUX>
</TOP>

```

This is the result of querying the constructed document in my_table:

```

SELECT * FROM my_table;

SYS_NC_ROWINFO$
-----
<TOP>

```



```

<QUUX>
  <FOO>data</FOO>
</QUUX>
</TOP>

```

1 row selected.

14.6 Using the C API for XML with Binary XML

You can use the C API for XML to read or write XML data that is encoded as binary XML from or to Oracle XML DB. Doing so involves the usual read and write procedures.

Binary XML is a compact, XML Schema-aware encoding of XML data. You can use binary XML as a storage model for `XMLType` data in the database, but you can also use it for XML data located outside the database.

Binary XML data is XML Schema-aware, and it can use various encoding schemes, depending on your needs. In order to manipulate binary XML data, you must have both the data and this metadata about the relevant XML schemas and encodings.

For `XMLType` data stored in the database, this metadata is also stored in the database. However, depending on how your database and data are set up, the metadata might not be on the same server as the data it applies to. If this is the case, then, before you can read or write binary XML data from or to the database, you must carry out these steps:

1. Create a context instance for the metadata.
2. Associate this context with a data connection that you use to access binary XML data in the database. A data connection can be a dedicated connection (`OCISvcCtx`) or a connection pool (`OCICPool`).

Then, when your application needs to encode or decode binary XML data on the data connection, it automatically fetches the metadata needed for that. As is illustrated by [Example 14-2](#) (page 14-8), the overall sequence of actions is as follows:

1. Create the usual OCI handles for environment (`OCIEnv`), connection (`OCISvcCtx`), and error context (`OCIError`).
2. Create one or more metadata contexts, as needed. A metadata context is sometimes referred to as a metadata repository, and `OCIBinXMLReposCtx` is the OCI context data structure. You use `OCIBinXMLCreateReposCtxFromConn` to create a metadata context from a dedicated connection and `OCIBinXMLCreateReposCtxFromCPool` to create a context from a connection pool.
3. Associate the metadata context(s) with the binary XML data connection(s). You use `OCIBinXmlSetReposCtxForConn` to do this.
4. (Optional) If the XML data originated outside of the database, use `setPicklePreference` to specify that XML data to be sent to the database from now on is in binary XML format. This applies to a DOM document (`xmlDomDoc`). If you do not specify binary XML, the data is stored as text (`CLOB`).
5. Use OCI libraries to read and write XML data from and to the database. Whenever it is needed for encoding or decoding binary XML documents, the necessary metadata is fetched automatically using the metadata context. Use the C DOM API for XML to operate on the XML data at the client level.

See Also:

- [XMLType Storage Models](#) (page 1-11)
- *Oracle XML Developer's Kit Programmer's Guide*

Example 14-2 Using the C API for XML with Binary XML

```

. . .
/* Private types and constants */
#define SCHEMA      (OraText *)"SYS"
#define TYPE        (OraText *)"XMLTYPE"
#define USER        (OraText *)"oe"
#define USER_LEN    (ub2)(strlen((char *)USER))
#define PWD         (OraText *)"oe"
#define PWD_LEN     (ub2)(strlen((char *)PWD))
#define NUM_PARAMS  1
static void checkerr(OCIError *errhp, sword status);
static sword create_env(OraText *user, ub2 user_len, OraText *pwd, ub2 pwd_len,
                      OCIEnv **envhp, OCISvcCtx **svchp, OCIError **errhp);
static sword run_example(OCIEnv *envhp, OCISvcCtx *svchp, OCIError *errhp,
                        OCIDuration dur);
static void cleanup(OCIEnv *envhp, OCISvcCtx *svchp, OCIError *errhp);

int main (int argc, char *argv[])
{
    OCIEnv      *envhp;
    OCISvcCtx   *svchp;
    OCIError    *errhp;
    printf("*** Starting Binary XML Example program\n");
    if (create_env(USER, USER_LEN, PWD, PWD_LEN, &envhp, &svchp, &errhp))
    {
        printf("FAILED: create_env()\n");
        cleanup(envhp, svchp, errhp);
        return OCI_ERROR;
    }
    if (run_example(envhp, svchp, errhp, OCI_DURATION_SESSION))
    {
        printf("FAILED: run_example()\n");
        cleanup(envhp, svchp, errhp);
        return OCI_ERROR;
    }
    cleanup(envhp, svchp, errhp);
    printf ("*** Completed Binary XML example\n");
    return OCI_SUCCESS;
}

static sword create_env(OraText *user, ub2 user_len,
                      OraText *pwd, ub2 pwd_len,
                      OCIEnv **envhp, OCISvcCtx **svchp, OCIError **errhp)
{
    sword      status;
    OCIServer  *srvhp;
    OCISession *usrp;
    OCICPool   *poolhp;
    OraText    *poolname;
    ub4        poolnamelen;
    OraText    *database =(OraText *)"";
    OCIBinXmlReposCtx *rctx;

```

```

/* Create and initialize environment. Allocate error handle. */
...
if ((status = OCIConnectionPoolCreate((dvoid *)envhp, (dvoid*)errhp,
                                     (dvoid *)poolhp, &poolname,
                                     (sb4 *)&poolnamelen,
                                     (OraText *)0,
                                     (sb4) 0, 1, 10, 1,
                                     (OraText *)USER,
                                     (sb4) USER_LEN,
                                     (OraText *)PWD,
                                     (sb4) PWD_LEN,
                                     OCI_DEFAULT)) != OCI_SUCCESS)
{
    printf ("OCIConnectionPoolCreate - Fail %d\n", status);
    return OCI_ERROR;
}
status = OCILogon2((OCIEnv *)envhp, *errhp, svchp, (OraText *)USER,
                  (ub4)USER_LEN, (const oratext *)PWD, (ub4)PWD_LEN,
                  (const oratext *)poolname, poolnamelen, OCI_CPOOL);
if (status)
{
    printf ("OCILogon2 - Fail %d\n", status);
    return OCI_ERROR;
}
OCIBinXmlCreateReposCtxFromCPool(*envhp, poolhp, *errhp, &rctx);
OCIBinXmlSetReposCtxForConn(*svchp, rctx);
return OCI_SUCCESS;
}

static sword run_example(OCIEnv *envhp, OCISvcCtx *svchp, OCIError *errhp,
                        OCIDuration dur)
{
    OCIType *xmltdo = (OCIType *)0;
    OCISmt *stmthp;
    OCIDefine *defnp;
    xmldocnode *xmldoc = (xmldocnode *)0;
    ub4 xmlsize = 0;
    text *selstmt = (text *)"SELECT doc FROM po_binxmlltab";
    sword status;
    struct xmlctx *xctx = (xmlctx *) 0;
    ocixmlbparam params[NUM_PARAMS];
    xmlerr xerr = (xmlerr) 0;
    /* Obtain type definition for XMLType. Allocate statement handle.
       Prepare SELECT statement. Define variable for XMLType. Execute statement. */
    ...
    /* Construct xmlctx for using XML C API */
    params[0].name_ocixmlbparam = XCTXINIT_OCIDUR;
    params[0].value_ocixmlbparam = &dur;
    xctx = OCIXmlDbInitXmlCtx(envhp, svchp, errhp, params, NUM_PARAMS);
    /* Print result to local string */
    XmlSaveDom(xctx, &xerr, (xmlnode *)xmldoc, "stdio", stdout, NULL);
    /* Free instances */
    ...
}

```

14.7 Using the Oracle XML Developer's Kit Pull Parser with Oracle XML DB

You can use the Oracle XML Developer's Kit pull parser with `XMLType` instances in Oracle XML DB. When you use this parser, parsing is done on demand, so your application drives the parsing process.

Your application accesses an XML document through a sequence of events, with start tags, end tags, and comments, just as in Simple API for XML (SAX) parsing. However, unlike the case of SAX parsing, where parsing events are handled by callbacks, in pull parsing your application calls methods to ask for (pull) events only when it needs them. This gives the application more control over XML processing. In particular, filtering is more flexible with the pull parser than with the SAX parser.

You can also use the Oracle XML Developer's Kit pull parser to perform stream-based XML Schema validation.

Example 14-3 (page 14-10) shows how to use the Oracle XML DB pull parser with an `XMLType` instance. To use the pull parser, you also need static library `libxml10.a` on UNIX and Linux systems or `oraxml10.dll` on Microsoft Windows systems. You also need header file `xmlcv.h`.

See Also:

- *Oracle XML Developer's Kit Programmer's Guide* for information about the Oracle XML Developer's Kit pull parser
 - *Oracle XML Developer's Kit Programmer's Guide* for information on using the pull parser for stream-based validation
-
-

Example 14-3 Using the Oracle XML DB Pull Parser

```
#define MAXBUFLen 64*1024
void main()
{
    test_ctx temp_ctx;
    test_ctx *ctx = &temp_ctx;
    OCIType *xmltdo = (OCIType *) 0;
    ocixmlbparam params[1];
    sword status = 0;
    xmlctx *xctx;
    OCIDefine *defnp = (OCIDefine *) 0;
    oratext sel_stmt[] =
        "SELECT XMLSerialize(DOCUMENT x.OBJECT_VALUE AS CLOB) FROM PURCHASEORDER x where rownum = 1";
    OCILobLocator *cob;
    ub4 amtp, nbytes;
    ub1 bufp[MAXBUFLen];
    ctx->username = (oratext *)"oe";
    ctx->password = (oratext *)"*****"; /* Replace with real password */

    /* Initialize envhp, svchp, errhp, dur, stmp */
    init_oci_handles(ctx);

    /* Get an xml context */
    params[0].name_ocixmlbparam = XCTXINIT_OCIDUR;
    params[0].value_ocixmlbparam = &ctx->dur;
    xctx = OCIXMLDBInitXmlCtx(ctx->envhp, ctx->svchp, ctx->errhp, params, 1);
```

```

/* Start processing */
printf("\n\nSupports XML 1.0? : %s\n",
       XmlHasFeature(xctx, (oratext *) "xml", (oratext *) "1.0") ?
       "YES" : "NO");

/* Allocate the lob descriptor */
status = OCIDescriptorAlloc((dvoid *) ctx->envhp, (dvoid **) &clob,
                           (ub4)OCI_DTYPE_LOB, (size_t) 0, (dvoid **) 0);
if (status)
{
    printf("OCIDescriptorAlloc Failed\n");
    goto error;
}
status = OCIStmtPrepare(ctx->stmthp, ctx->errhp,
                       (CONST OraText *)sel_stmt, (ub4) strlen((char *)sel_stmt),
                       (ub4) OCI_NTV_SYNTAX, (ub4) OCI_DEFAULT);
if (status)
{
    printf("OCIStmtPrepare Failed\n");
    goto error;
}
status = OCIDefineByPos(ctx->stmthp, &defnp, ctx->errhp, (ub4) 1,
                       (dvoid *) &clob, (sb4) -1, (ub2 ) SQLT_CLOB,
                       (dvoid *) 0, (ub2 *)0,
                       (ub2 *)0, (ub4) OCI_DEFAULT);
if (status)
{
    printf("OCIDefineByPos Failed\n");
    goto error;
}
status = OCIStmtExecute(ctx->svchp, ctx->stmthp, ctx->errhp, (ub4) 1,
                       (ub4) 0, (CONST OCISnapshot*) 0, (OCISnapshot*) 0,
                       (ub4) OCI_DEFAULT);
if (status)
{
    printf("OCIStmtExecute Failed\n");
    goto error;
}
/* read the fetched value into a buffer */
amtp = nbytes = MAXBUFLEN-1;
status = OCILobRead(ctx->svchp, ctx->errhp, clob, &amtp,
                   (ub4) 1, (dvoid *) bufp, (ub4) nbytes, (dvoid *)0,
                   (sb4 *) (dvoid *, CONST dvoid *, ub4, ub1)) 0,
                   (ub2) 0, (ub1) SQLCS_IMPLICIT);
if (status)
{
    printf("OCILobRead Failed\n");
    goto error;
}
bufp[amtp] = '\0';
if (amtp > 0)
{
    printf("\n=> Query result of %s: \n%s\n", sel_stmt, bufp);
    /****** PULL PARSING *****/
    status = pp_parse(xctx, bufp, amtp);
    if (status)
        printf("Pull Parsing failed\n");
}
error:
/* Free XML Ctx */

```

```
OCIXmlDbFreeXmlCtx(xctx);

/* Free envhp, svchp, errhp, stmthp */
free_oci_handles(ctx);
}
#define ERRBUFLLEN 256
sb4 pp_parse(xctx, buf, amt)
xmlctx *xctx;
oratext *buf;
ub4 amt;
{
    xmlevctx *evctx;
    xmlerr xerr = XMLERR_OK;
    oratext message[ERRBUFLLEN];
    oratext *emsg = message;
    xmlerr ecode;
    boolean done, inattr = FALSE;
    xmlevtype event;

    /* Create an XML event context - Pull Parser Context */
    evctx = XmlEvCreatePPCtx(xctx, &xerr,
                           "expand_entities", FALSE,
                           "validate", TRUE,
                           "attr_events", TRUE,
                           "raw_buffer_len", 1024,
                           NULL);

    if (!evctx)
    {
        printf("FAILED: XmlEvCreatePPCtx: %d\n", xerr);
        return OCI_ERROR;
    }
    /* Load the document from input buffer */
    xerr = XmlEvLoadPPDoc(xctx, evctx, "buffer", buf, amt, "utf-8");
    if (xerr)
    {
        printf("FAILED: XmlEvLoadPPDoc: %d\n", xerr);
        return OCI_ERROR;
    }
    /* Process the events until END_DOCUMENT event or error */
    done = FALSE;
    while(!done)
    {
        event = XmlEvNext(evctx);
        switch(event)
        {
            case XML_EVENT_START_ELEMENT:
                printf("START ELEMENT: %s\n", XmlEvGetName0(evctx));
                break;
            case XML_EVENT_END_ELEMENT:
                printf("END ELEMENT: %s\n", XmlEvGetName0(evctx));
                break;
            case XML_EVENT_START_DOCUMENT:
                printf("START DOCUMENT\n");
                break;
            case XML_EVENT_END_DOCUMENT:
                printf("END DOCUMENT\n");
                done = TRUE;
                break;
            case XML_EVENT_START_ATTR:
                printf("START ATTRIBUTE: %s\n", XmlEvGetAttrName0(evctx, 0));
                inattr = TRUE;
        }
    }
}
```

```

        break;
    case XML_EVENT_END_ATTR:
        printf("END ATTRIBUTE: %s\n", XmlEvGetAttrName0(evctx, 0));
        inattr = FALSE;
        break;
    case XML_EVENT_CHARACTERS:
        if (inattr)
            printf("ATTR VALUE: %s\n", XmlEvGetText0(evctx));
        else
            printf("TEXT: %s\n", XmlEvGetText0(evctx));
        break;
    case XML_EVENT_ERROR:
    case XML_EVENT_FATAL_ERROR:
        done = TRUE;
        ecode = XmlEvGetError(evctx, &emsg);
        printf("ERROR: %d: %s\n", ecode, emsg);
        break;
    }
}
/* Destroy the event context */
XmlEvDestroyPPCtx(xctx, evctx);
return OCI_SUCCESS;
}

```

The output from compiling and running this C program is as follows:

=> **Query result** of XMLSerialize(DOCUMENT x.OBJECT_VALUE AS CLOB) FROM PURCHASEORDER x where rownum = 1:

```

<PurchaseOrder xmlns:xsi="http://www.w3.org/2001/XMLSchema-instance"
  xsi:noNamespaceSchemaLocation=
    "http://localhost:8080/source/schemas/poSource/xsd/purchaseOrder.xsd">
  <Reference>AMCEWEN-20021009123336171PDT</Reference>
  <Actions>
    <Action>
      <User>KPARTNER</User>
    </Action>
  </Actions>
  <Reject/>
  <Requestor>Allan D. McEwen</Requestor>
  <User>AMCEWEN</User>
  <CostCenter>S30</CostCenter>
  <ShippingInstructions>
    <name>Allan D. McEwen</name>
    <address>Oracle Plaza
Twin Dolphin Drive
Redwood Shores
CA
94065
USA</address>
    <telephone>650 506 7700</telephone>
  </ShippingInstructions>
  <SpecialInstructions>Ground</SpecialInstructions>
  <LineItems>
    <LineItem ItemNumber="1">
      <Description>Salesman</Description>
      <Part Id="37429158920" UnitPrice="39.95" Quantity="2"/>
    </LineItem>
    . . .
  </LineItems>
</PurchaseOrder>

START DOCUMENT

```

```
START ELEMENT: PurchaseOrder
START ATTRIBUTE: xmlns:xsi
ATTR VALUE: http://www.w3.org/2001/XMLSchema-instance
END ATTRIBUTE: xmlns:xsi
START ATTRIBUTE: xsi:noNamespaceSchemaLocation
ATTR VALUE: http://localhost:8080/source/schemas/poSource/xsd/purchaseOrder.xsd
END ATTRIBUTE: xsi:noNamespaceSchemaLocation
START ELEMENT: Reference
TEXT: AMCEWEN-20021009123336171PDT
END ELEMENT: Reference
START ELEMENT: Actions
START ELEMENT: Action
START ELEMENT: User
TEXT: KPARTNER
END ELEMENT: User
END ELEMENT: Action
END ELEMENT: Actions
START ELEMENT: Reject
END ELEMENT: Reject
START ELEMENT: Requestor
TEXT: Allan D. McEwen
END ELEMENT: Requestor
START ELEMENT: User
TEXT: AMCEWEN
END ELEMENT: User
START ELEMENT: CostCenter
TEXT: S30
END ELEMENT: CostCenter
START ELEMENT: ShippingInstructions
START ELEMENT: name
TEXT: Allan D. McEwen
END ELEMENT: name
START ELEMENT: address
TEXT: Oracle Plaza
Twin Dolphin Drive
Redwood Shores
CA
94065
USA
END ELEMENT: address
START ELEMENT: telephone
TEXT: 650 506 7700
END ELEMENT: telephone
END ELEMENT: ShippingInstructions
START ELEMENT: SpecialInstructions
TEXT: Ground
END ELEMENT: SpecialInstructions
START ELEMENT: LineItems
START ELEMENT: LineItem
START ATTRIBUTE: ItemNumber
ATTR VALUE: 1
END ATTRIBUTE: ItemNumber
START ELEMENT: Description
TEXT: Salesman
END ELEMENT: Description
START ELEMENT: Part
START ATTRIBUTE: Id
ATTR VALUE: 37429158920
END ATTRIBUTE: Id
START ATTRIBUTE: UnitPrice
ATTR VALUE: 39.95
```



```

END ATTRIBUTE: UnitPrice
START ATTRIBUTE: Quantity
ATTR VALUE: 2
END ATTRIBUTE: Quantity
END ELEMENT: Part
END ELEMENT: LineItem
. . .
END ELEMENT: LineItems
END ELEMENT: PurchaseOrder
END DOCUMENT

```

14.8 Common XMLType Operations in C

Common XML operations are provided by the C API for XML.

[Table 14-2](#) (page 14-15) provides the XMLType functional equivalent of common XML operations.

Table 14-2 Common XMLType Operations in C

Description	C API XMLType Function
Create empty XMLType instance	XmlCreateDocument()
Create from a source buffer	XmlLoadDom()
Extract an XPath expression	XmlXPathEvalexpr() and family
Transform using an XSLT stylesheet	XmlXslProcess() and family
Check if an XPath exists	XmlXPathEvalexpr() and family
Is document schema-based?	XmlDomIsSchemaBased()
Get schema information	XmlDomGetSchema()
Get document namespace	XmlDomGetNodeURI()
Validate using schema	XmlSchemaValidate()
Obtain DOM from XMLType	Cast(void *) to (xmlDocnode *)
Obtain XMLType from DOM	Cast(xmlDocnode *) to (void *)

See Also:

Oracle XML Developer's Kit Programmer's Guide "XML Parser for C"

[Example 14-4](#) (page 14-15) shows how to use the DOM to determine how many instances of a particular part have been ordered. The part in question has Id 37429158722. See [Oracle-Supplied XML Schemas and Examples](#) (page A-1), [Example A-6](#) (page A-50) for the definitions of helper functions `exec_bind_xml`, `free_oci_handles`, and `init_oci_handles`.

Example 14-4 Using the DOM to Count Ordered Parts

```

#ifndef S_ORACLE
#endif
#ifndef ORATYPES_ORACLE
#include <oratypes.h>

```

```
#endif
#ifndef XML_ORACLE
#include <xml.h>
#endif
#ifndef OCIXML_ORACLE
#include <ocixml.h>
#endif
#ifndef OCI_ORACLE
#include <oci.h>
#endif
#include <string.h>

typedef struct test_ctx {
    OCIEnv *envhp;
    OCIError *errhp;
    OCISvcCtx *svchp;
    OCIStmt *stmthp;
    OCIServer *srvhp;
    OCIDuration dur;
    OCISession *sesshp;
    oratext *username;
    oratext *password;
} test_ctx;

/* Helper function 1: execute a sql statement which binds xml data */
static sword exec_bind_xml(OCISvcCtx *svchp,
                            OCIError *errhp,
                            OCIStmt *stmthp,
                            void *xml,
                            OCIType *xmltdo,
                            OraText *sqlstmt);

/* Helper function 2: Initialize OCI handles and connect */
static sword init_oci_handles(test_ctx *ctx);

/* Helper function 3: Free OCI handles and disconnect */
static sword free_oci_handles(test_ctx *ctx);

void main()
{
    test_ctx temp_ctx;
    test_ctx *ctx = &temp_ctx;
    OCIType *xmltdo = (OCIType *) 0;
    xmldocnode *doc = (xmldocnode *)0;
    ocixmlbparam params[1];
    xmlnode *quux, *foo, *foo_data, *top;
    xmlerr err;
    sword status = 0;
    xmlctx *xctx;
    ub4 xmlsize = 0;
    OCIDefine *defnp = (OCIDefine *) 0;
    oratext sel_stmt[] = "SELECT SYS_NC_ROWINFO$ FROM PURCHASEORDER";
    xmlodelist *litems = (xmlodelist *)0;
    xmlnode *item = (xmlnode *)item;
    xmlnode *part;
    xmlnamedmap *attrs;
    xmlnode *id;
    xmlnode *qty;
    oratext *idval;
    oratext *qtyval;
    ub4 total_qty;
```

```

int i;
int numdocs;

ctx->username = (oratest *)"oe";
ctx->password = (oratest *)"*****"; /* Replace with real password */

/* Initialize envhp, svchp, errhp, dur, stmthp */
init_oci_handles(ctx);

/* Get an xml context */
params[0].name_ocixmlbparam = XCTXINIT_OCIDUR;
params[0].value_ocixmlbparam = &ctx->dur;
xctx = OCIXmlDbInitXmlCtx(ctx->envhp, ctx->svchp, ctx->errhp, params, 1);

/* Start processing */
printf("\n\nSupports XML 1.0? : %s\n",
       XmlHasFeature(xctx, (oratest *) "xml", (oratest *) "1.0") ?
       "YES" : "NO");

/* Get the documents from the database using a select statement */
status = OCITypeByName(ctx->envhp, ctx->errhp, ctx->svchp, (const text *) "SYS",
                      (ub4) strlen((char *)"SYS"), (const text *) "XMLTYPE",
                      (ub4) strlen((char *)"XMLTYPE"), (CONST text *) 0,
                      (ub4) 0, OCI_DURATION_SESSION, OCI_TYPEGET_HEADER,
                      (OCIType **) &xmldo);
status = OCISmtPrepare(ctx->stmthp, ctx->errhp,
                      (CONST OraText *)sel_stmt, (ub4) strlen((char *)sel_stmt),
                      (ub4) OCI_NTV_SYNTAX, (ub4) OCI_DEFAULT);
status = OCIDefineByPos(ctx->stmthp, &defnp, ctx->errhp, (ub4) 1, (dvoid *) 0,
                      (sb4) 0, SQLT_NTY, (dvoid *) 0, (ub2 *) 0,
                      (ub2 *) 0, (ub4) OCI_DEFAULT);
status = OCIDefineObject(defnp, ctx->errhp, (OCIType *) xmldo,
                      (dvoid **) &doc,
                      &xmlsize, (dvoid **) 0, (ub4 *) 0);
status = OCISmtExecute(ctx->svchp, ctx->stmthp, ctx->errhp, (ub4) 0, (ub4) 0,
                      (CONST OCISnapshot*) 0, (OCISnapshot*) 0, (ub4) OCI_DEFAULT);

/* Initialize variables */
total_qty = 0;
numdocs = 0;

/* Loop through all the documents */
while ((status = OCISmtFetch2(ctx->stmthp, ctx->errhp, (ub4) 1, (ub4)
OCI_FETCH_NEXT,
                                (ub4)1, (ub4) OCI_DEFAULT)) == 0)
{
    numdocs++;

    /* Get all the LineItem elements */
    litems = XmlDomGetDocElemsByTag(xctx, doc, (oratest *)"LineItem");
    i = 0;

    /* Loop through all LineItems */
    while (item = XmlDomGetNodeListItem(xctx, litems, i))
    {
        /* Get the part */
        part = XmlDomGetLastChild(xctx, item);

        /* Get the attributes */
        attrs = XmlDomGetAttrs(xctx, (xmlelemnode *)part);
    }
}

```

```
/* Get the id attribute and its value */
id = XmlDomGetNamedItem(xctx, attrs, (oratext *)"Id");
idval = XmlDomGetNodeValue(xctx, id);

/* Keep only parts with id 37429158722 */
if (idval && (strlen((char *)idval) == 11 )
    && !strcmp((char *)idval, (char *)"37429158722", 11))
{
    /* Get the quantity attribute and its value.*/
    qty = XmlDomGetNamedItem(xctx, attrs, (oratext *)"Quantity");
    qtyval = XmlDomGetNodeValue(xctx, qty);

    /* Add the quantity to total_qty */
    total_qty += atoi((char *)qtyval);
}
i++;
}
XmlFreeDocument(xctx, doc);
doc = (xmldocnode *)0;
}
printf("Total quantity needed for part 37429158722 = %d\n", total_qty);
printf("Number of documents in table PURCHASEORDER = %d\n", numdocs);

/* Free Xml Ctx */
OCIXmlDbFreeXmlCtx(xctx);

/* Free envhp, svchp, errhp, stmthp */
free_oci_handles(ctx);
}
```

The output from compiling and running this C program is as follows:

```
Supports XML 1.0? : YES
Total quantity needed for part 37429158722 = 42
Number of documents in table PURCHASEORDER = 132
```

Oracle XML DB and Oracle Data Provider for .NET

Oracle Data Provider for Microsoft .NET (ODP.NET) is an implementation of a data provider for Oracle Database. It uses Oracle native APIs to offer fast and reliable access to Oracle data and features from any .NET application.

It also uses and inherits classes and interfaces available in the Microsoft .NET Framework Class Library. ODP.NET supports the following LOB data types natively with .NET: BLOB, CLOB, NCLOB, and BFILE.

- [Oracle XML DB and ODP.NET XML](#) (page 15-1)
- [Using XMLType Data with ODP.NET](#) (page 15-1)

15.1 Oracle XML DB and ODP.NET XML

ODP.NET supports XML data natively in the database, through Oracle XML DB.

ODP.NET:

- Stores XML data natively in Oracle Database as `XMLType`.
- Accesses relational and object-relational data as XML data from Oracle Database to a Microsoft .NET environment, and processes the XML using Microsoft .NET framework.
- Saves changes to the database server using XML data.
- Provides the following XML-specific classes:
 - `OracleXmlType`
 - `OracleXmlStream`
 - `OracleXmlQueryProperties`
 - `OracleXmlSaveProperties`
- Enhances classes `OracleCommand`, `OracleConnection`, and `OracleDataReader`.

15.2 Using XMLType Data with ODP.NET

An example illustrates passing `XMLType` data from the database to .NET

[Example 15-1](#) (page 15-2) retrieves `XMLType` data from the database to .NET and outputs the results:

See Also:

Oracle Data Provider for .NET Developer's Guide for Microsoft Windows for complete information about Oracle .NET support for Oracle XML DB.

Example 15-1 Retrieve XMLType Data to .NET

```
//Create OracleCommand and query XMLType
OracleCommand xmlCmd = new OracleCommand();
poCmd.CommandText = "SELECT po FROM po_tab";
poCmd.Connection = conn;
// Execute OracleCommand and output XML results to an OracleDataReader
OracleDataReader poReader = poCmd.ExecuteReader();
// ODP.NET native XML data type object from Oracle XML DB
OracleXmlType poXml;
string str = ""; //read XML results
while (poReader.Read())
{
    // Return OracleXmlType object of the specified XmlType column
    poXml = poReader.GetOracleXmlType(0);
    // Concatenate output for all the records
    str = str + poXml.Value;
} //Output XML results to the screen
Console.WriteLine(str);
```

Part V

XML Schema and Object-Relational XMLType

The use of XML Schema and object-relational storage of XMLType data is covered.

It contains the following chapters:

- [Choice of XMLType Storage and Indexing](#) (page 16-1)
- [XML Schema Storage and Query: Basic](#) (page 17-1)
- [XPath Rewrite for Object-Relational Storage](#) (page 19-1)
- [XML Schema Storage and Query: Object-Relational Storage](#) (page 18-1)
- [XML Schema Evolution](#) (page 20-1)

Choice of XMLType Storage and Indexing

Important design choices for your application include what XMLType storage model to use and which indexing approaches to use.

- [Introduction to Choosing an XMLType Storage Model and Indexing Approaches](#) (page 16-1)
- [XMLType Use Case Spectrum: Data-Centric to Document-Centric](#) (page 16-2)
- [Common Use Cases for XML Data Stored as XMLType](#) (page 16-3)
- [XMLType Storage Options: Relative Advantages](#) (page 16-8)
- [XMLType Indexing Considerations](#) (page 16-8)
- [XMLType Storage Options: Relative Advantages](#) (page 16-8)

16.1 Introduction to Choosing an XMLType Storage Model and Indexing Approaches

XMLType is an abstract SQL data type that provides different storage and indexing models to best fit your XML data and your use of it. Because it is an abstract data type, your applications and database queries gain in flexibility: the same interface is available for all XMLType operations.

Different applications use XML data in different ways. Sometimes it is constructed from relational data sources, so it is relatively structured. Sometimes it is used for extraction, transformation, and loading (ETL) operations, in which case it is also quite structured. Sometimes it is used for free-form documents (unstructured or semi-structured) such as books and articles.

Retrieval approaches can also be different for different kinds of data. Data-centric use cases often involve a fixed set of queries, whereas document-centric use cases often involve arbitrary (ad-hoc) queries.

Because there is a broad spectrum of XML usage, there is no one-size-fits-all storage model that offers optimal performance and flexibility for every use case. Oracle XML DB offers two storage models for XMLType, and several indexing methods appropriate to these different storage models. You can tailor performance and functionality to best fit the kind of XML data you have and the ways you use it.

Therefore, one key decision to make is which XMLType storage model to use for which XML data. This chapter helps you choose the best storage option for a given use case.

XMLType tables and columns can be stored in the following ways:

- **Binary XML storage** – This is also referred to as **post-parse persistence**. It is the default storage model for Oracle XML DB. It is a post-parse, binary format designed specifically for XML data. Binary XML is compact and XML schema-

aware. The biggest advantage of Binary XML storage is *flexibility*: you can use it for XML schema-based documents or for documents that are not based on an XML schema. You can use it with an XML schema that allows for high data variability or that evolves considerably or unexpectedly. This storage model also provides efficient partial updating and streamable query evaluation.

- **Object-relational storage** – This is also referred to as **structured** storage and **object-based persistence**. This storage model represents an entity-relationship (ER) decomposition of the XML data. It provides the best performance for highly structured data with a known and more or less fixed set of queries. Query performance matches that of relational data, and updates can be performed in place.

Note:

Starting with Oracle Database 12c Release 1 (12.1.0.1), the unstructured (CLOB) storage model for XMLType is *deprecated*. Use binary XML storage instead.

If you have existing XMLType data that is stored as CLOB data then consider moving it to binary XML storage format using Oracle GoldenGate. If document fidelity is important for a particular XML document then store a copy of it in a relational CLOB column.

Oracle XML DB supports the following kinds of indexes on XMLType data.

- B-tree functional indexes on object-relational storage
- XML search index on binary XML storage
- XMLIndex with structured and unstructured components on binary XML storage
- B-tree indexes on the secondary tables created automatically for XMLIndex (both structured and unstructured components) on binary XML storage

Different use cases call for different combinations of XMLType storage model and indexes.

See Also:



- [Indexes for XMLType Data](#) (page 6-1)
 - [XMLType Storage Options: Relative Advantages](#) (page 16-8)
-
-

16.2 XMLType Use Case Spectrum: Data-Centric to Document-Centric

When choosing an XMLType storage model, consider the nature of your XML data and the ways you use it. There is a spectrum of use cases, ranging from most data-centric to most document-centric.

This is illustrated in [Figure 16-1](#) (page 16-3), which shows the most data-centric cases at the left and the most document-centric cases at the right.

Figure 16-1 XML Use Cases and XMLType Storage Models

			
	Data-Centric	Document-Centric	
Use Case	XML schema-based data, with little variation and little structural change over time	Variable, free-form data, with some fixed embedded structures	Variable, free-form data
Typical Data	Employee record	Technical article, with author, date, and title fields	Web document or book chapter
Storage Model	Object-Relational (Structured)	Binary XML	
Indexing	B-tree index	<ul style="list-style-type: none"> · XMLIndex index with structured and unstructured components · XML search index 	<ul style="list-style-type: none"> · XMLIndex index with unstructured component · XML search index

Data-centric data is highly structured, with relatively static and predictable structure, and your applications take advantage of this structure. The data conforms to an XML schema.

Document-centric data can be divided into two cases:

- The data is generally without structure or is of variable structure. This includes the case of documents that have both structured and unstructured parts. Document structure can vary over time (evolution), and the content can be **mixed (semi-structured)**, with many elements containing both text nodes and child elements. Many XML elements can be absent or can appear in different orders. Documents might or might not conform to an XML schema.
- The data is relatively structured, but your applications do not take advantage of that structure: they treat the data as if it were without structure.

16.3 Common Use Cases for XML Data Stored as XMLType

Recommendations are provided for application use cases that correspond to common use cases for XML data stored as XMLType.

If your use case is *not* a common one, so that it is not covered here, then refer to the rest of this chapter for information about special cases.

Note:

This section is about the use of XML data that is persisted as XMLType. One common use case for XML data involves the generation of XML data from relational data. That case is not covered here, as it involves relational storage and the generated XML data is not necessarily persisted.

(For cases where generated XML data is persisted as XMLType, see [XMLType Use Case: Staged XML Data for ETL](#) (page 16-4).)

See Also:

- [XMLType Indexing Considerations](#) (page 16-8)
 - [XMLType Storage Options: Relative Advantages](#) (page 16-8)
-
-

16.3.1 XMLType Use Case: No XML Fragment Updating or Querying

In this use case there is no requirement to update or query fragments of XML data that is stored in the database.

You have these options for this use case:

- Store it as XMLType using *binary XML storage*.
- Store it in a *relational* BLOB or CLOB column, preferably a SecureFiles LOB.

If you store the XML data in a relational LOB column, not as XMLType, Oracle Database does not parse the data and it cannot guarantee its validity. (And you cannot perform XMLType operations on the data.)

16.3.2 XMLType Use Case: Data Integration from Diverse Sources with Different XML Schemas

If your XML data comes from multiple data sources that use different XML schemas then use *binary XML storage*.

This use case has three subcases:

- If the XML data contains islands of structured, predictable data, and your queries are known, then use XMLIndex with a *structured component* to index the structured islands (even if the data surrounding these islands is unstructured). A structured index component reflects the queries you use. An RSS news aggregator is an example of such a use case.
- If there are no such structured islands or your queries are unknown ahead of time (ad hoc) then use XMLIndex with an unstructured component.
- If you use queries that involve full-text search then use an XML search index, together with XQuery pragma `ora:no_schema`.

See Also:

- [XMLIndex Structured Component](#) (page 6-9)
 - [XMLIndex Unstructured Component](#) (page 6-15)
 - [Indexing XML Data for Full-Text Queries](#) (page 6-56) and [Oracle XQuery Extension-Expression Pragmas](#) (page 4-22)
-
-

16.3.3 XMLType Use Case: Staged XML Data for ETL

In this use case, data is extracted from outside sources, transformed to fit operational needs (typically relational), and then loaded into the database: *extract, transform, load* (ETL). In particular, transformation distinguishes this use case.

ETL use cases often integrate data from multiple applications that are maintained or hosted by multiple parties using different software and hardware systems. The data that is extracted is often the responsibility of parties other than those who transform it or use it after transformation.

The XML data involved is typically highly structured and conforms to an XML schema. This use case covers both producing relational data from XML data and generating XML data from relational data.

A subset of ETL use cases involve the need to efficiently *update* the XML data. Updating can involve replacement of an entire XML document or changes to only fragments of a document (partial updating).

Object-relational storage of XMLType data is generally appropriate for this use case.

See Also:

- [Relational Views over XML Data](#) (page 9-1)
 - [Generation of XML Data from Relational Data](#) (page 8-1)
-

16.3.4 XMLType Use Case: Semi-Structured XML Data

In this use case, either your XML data is of variable form or large portions of it are not well defined. There might not be an associated XML schema, or the XML schema might allow for high data variability or evolve considerably or in unexpected ways.

Binary XML storage of XMLType data is generally appropriate for this use case.

Use structured-component XMLIndex indexing when query paths are known, and use path-subsetted unstructured-component XMLIndex indexing when paths are not known beforehand (ad hoc queries). Use an XML search index for XQuery Full-Text queries.

See Also:

- [XMLIndex Structured Component](#) (page 6-9)
 - [XMLIndex Unstructured Component](#) (page 6-15)
 - [Indexing XML Data for Full-Text Queries](#) (page 6-56)
-

16.3.5 XMLType Use Case: Business Intelligence Queries

To enable business-intelligence (BI) queries over XML data, you can use SQL/XML function XMLTable to project values contained in the data as columns of a virtual table. Then use analytic-function windows, together with SQL ORDER BY and GROUP BY, to operate on columns of the virtual table.

For business-intelligence queries, you will generally do all of the following:

- Store your XMLType data as binary XML.
- Use an XMLIndex index with a structured component.
- Create relational views over the data using SQL/XML function XMLTable, where the views project all columns of interest to the BI application.

- Write your application queries against these relational views.

If the `XMLIndex` index is created in one-to-one correspondence to these views, Oracle Database automatically translates queries over the views to queries over the relational tables of the structured `XMLIndex` component, providing relational performance.

When you use analytic-function windows, `ORDER BY`, or `GROUP BY` on a column of the virtual table, these operations are translated to windows, `ORDER BY`, and `GROUP BY` operations on the corresponding physical columns of the structured-component `XMLIndex` tables.

See Also:

- [XMLIndex Structured Component](#) (page 6-9)
 - [Relational Views over XML Data](#) (page 9-1)
-
-

16.3.6 XMLType Use Case: XML Queries Involving Full-Text Search

If your application needs to perform full-text searches on XML data then use *binary XML storage* and create XML search indexes that correspond to your queries.

See Also:

[Indexing XML Data for Full-Text Queries](#) (page 6-56)

16.4 XMLType Storage Model Considerations

For most use cases, Oracle recommends that you use binary XML storage of `XMLType`. Object-relational storage is appropriate in special cases.

Object-relational storage is not appropriate unless *all* of the following are true:

- You have an XML schema that rigorously specifies the detailed data format of all XML documents that you intend to store in a given `XMLType` column or table. Your applications are data-centric.
- You do not expect your XML schema to evolve frequently in ways that do not allow in-place schema evolution.
- Your data is not especially sparse (does not include many elements that are empty or missing).
- You do not necessarily insert and select whole XML documents at a time. Partial updates and selections are common.
- You do not need document fidelity (DOM fidelity is sufficient).

[Table 16-1](#) (page 16-7) provides more detail about this. The guidelines it presents for choosing an `XMLType` storage model are *not* independent: follow them *in the order presented*, row by row, until a requirement in column **If...** is satisfied.

Table 16-1 XMLType Storage Model Considerations

If...	Then...
1. You need the property of document fidelity, preserving all original whitespace.	Use binary XML storage for database use and XML processing. But also store a copy of the original documents in a CLOB (relational) column. (It is your responsibility to keep the two versions synchronized, if you update the data.)
2. You rarely need to select or update only a portion of your XML data. Instead, you typically insert and select whole XML documents at a time.	Use binary XML storage.
3. You need to store XMLType instances that conform to different XML schemas in the <i>same</i> XMLType table or column. (Oracle does <i>not</i> recommend this practice in general, because it prohibits Oracle XML DB from using the XML schemas to optimize XML queries and other operations.)	Use binary XML storage.
4. You do <i>not</i> have an XML schema for your data.	Use binary XML storage. If you think that your data could benefit from XML schema validation, then consider also whether you can generate an XML schema for it using a schema-generation tool.
5. You expect your XML schema to evolve frequently or in unexpected ways, and you <i>cannot</i> take advantage of in-place XML schema evolution. In-place evolution is generally permitted only if the changes do not invalidate existing documents and they do not involve changing the storage model. See XML Schema Evolution (page 20-1).	Use binary XML storage. Use PL/SQL procedure <code>DBMS_XMLSCHEMA.copyEvolve</code> to update the XML schema.
6. Your XML data is very sparse.	Use binary XML storage.
7. Your XML schema does <i>not</i> make use of constructs such as <code>any</code> and <code>choice</code> , which do not provide a detailed specification of the data format. (XML schema generators often include such constructs in the generated schemas.)	Use object-relational storage.
8. You can modify your XML schema to remove constructs such as <code>any</code> and <code>choice</code> that prevent a rigorous definition of the structure of your XML data.	Remove such constructs, then use object-relational storage.
9. You cannot remove such constructs.	Use binary XML storage.

16.5 XMLType Indexing Considerations

For XMLType data stored object-rationally, create B-tree and bitmap indexes just as you would for relational data. Use XMLIndex indexing with XMLType data that is stored as binary XML.

For general indexing of document-centric XML data, use XMLIndex with an *unstructured component*. This is appropriate for queries that are ad hoc (arbitrary).

For data that contains predictable, fixed parts that you query frequently, use XMLIndex with *structured components* for those parts. An example of this use case is a specification that is generally free-form but that has fixed fields for the author, date, and title.

To handle islands of structure within generally unstructured content, create an XMLIndex index that has both structured and unstructured components. A use case where you might use both components would be to support queries that extract an XML fragment from a document whenever some structured data is present. The structured component of the index would be used for a query WHERE clause condition that checks for the structured data. The unstructured component would be used for the fragment extraction.

Table 16-2 (page 16-8) provides simple guidelines for indexing XMLType data that is stored as binary XML. These guidelines are *independent*: you can use a combination of indexing approaches if their *If...* conditions are satisfied.

Table 16-2 XMLType Indexing Considerations

If...	Then...
Your data contains predictable islands of structured data.	Use XMLIndex, with a structured component for each of the structured islands.
You need to support full-text queries.	Use XML search indexes.
You need to support ad-hoc XML queries involving predicates.	Use XMLIndex, with an unstructured component.

16.6 XMLType Storage Options: Relative Advantages

Each XMLType storage model has particular advantages and disadvantages.

Table 16-3 (page 16-8) summarizes the advantages and disadvantages of each XMLType storage model. Symbols + and – provide a rough indication of strength and weakness, respectively.

Table 16-3 XMLType Storage Models: Relative Advantages

Quality	Binary XML Storage	Object-Relational Storage
Throughput	(+) High throughput. Fast DOM loading. There is a slight overhead from the binary encoder/decoder.	(–) XML decomposition can result in reduced throughput when ingesting or retrieving the entire content of an XML document.
Indexing support	XMLIndex and XML search indexes.	B-tree, bitmap, and Oracle Text indexes on specific elements or attributes.

Table 16-3 (Cont.) XMLType Storage Models: Relative Advantages

Quality	Binary XML Storage	Object-Relational Storage
Queries	(+) Fast when using XMLIndex. Queries that cannot use an index use streaming XPath evaluation, which can also be fast.	(++) Relational query performance. You can create B-tree indexes on the underlying object-relational columns.
Update operations (DML)	(+) In-place, piecewise update for SecureFiles LOB storage.	(++) Relational update performance. Columns are updated in place.
Data flexibility	(+) Flexibility in the structure of the XML documents that can be stored in an XMLType column or table.	(-) Limited flexibility. Only documents that conform to the XML schema can be stored.
XML schema flexibility	(++) Both XML schema-based and non-schema-based documents can be stored. Documents conforming to any XML schemas that have been registered can be stored in the same XMLType table or column.	(-) Only documents that conform to the same XML schema can be stored in a given XMLType table or column.
Validation upon insert	(++) XML schema-based data can be fully validated when it is inserted, but this takes time.	(+) XML data is partially validated when it is inserted.
Compression and Encryption	(+) Binary XML with SecureFiles LOB storage can be compressed/encrypted.	(++) Each XML element/attribute can be compressed/encrypted individually.

XML Schema Storage and Query: Basic

XML Schema is a standard for describing the content and structure of XML documents. You can register, update, and delete an XML schema used with Oracle XML DB. You can define storage structures to use for your XML schema-based data and map XML Schema data types to SQL data types.

The XML Schema Recommendation was created by the World Wide Web Consortium (W3C) to describe the content and structure of XML documents. It includes the full capabilities of Document Type Definitions (DTDs) so that existing DTDs can be converted to XML Schema. XML schemas have additional capabilities compared to DTDs.

- [Overview of XML Schema](#) (page 17-1)
- [Overview of Using XML Schema with Oracle XML DB](#) (page 17-3)
- [XML Schema Registration with Oracle XML DB](#) (page 17-7)
- [Creation of XMLType Tables and Columns Based on XML Schemas](#) (page 17-17)
- [Ways to Identify XML Schema Instance Documents](#) (page 17-24)
- [XML Schema Data Types Are Mapped to Oracle XML DB Storage](#) (page 17-26)

See Also:

- [XML Schema Storage and Query: Object-Relational Storage](#) (page 18-1) for more advanced information about using XML Schema with Oracle XML DB
 - [XPath Rewrite for Object-Relational Storage](#) (page 19-1) for information about the optimization of XPath expressions in Oracle XML DB
 - <http://www.w3.org/TR/xmlschema-0/> for an introduction to XML Schema
-

17.1 Overview of XML Schema

The W3C XML Schema Recommendation defines a standardized language for specifying the structure, content, and certain semantics of a set of XML documents. An XML schema can be considered as the metadata that describes a class of XML documents.

The XML Schema Recommendation is described at: <http://www.w3.org/TR/xmlschema-0/>

This documentation refers to an XML Schema instance definition as an **XML schema** (lowercase).

17.1.1 XML Schema for Schemas

The W3C Schema working group publishes an XML schema, often referred to as the "Schema for Schemas". This XML schema provides the definition, or vocabulary, of the XML Schema language. All valid XML schemas can be considered to be members of the class defined by this XML schema.

An XML schema is thus an XML document that conforms to the class defined by the XML schema published at <http://www.w3.org/2001/XMLSchema>.

17.1.2 XML Schema Features

XML Schema defines 47 scalar data types, for strong typing of elements and attributes. It supports object-oriented inheritance and extension, so you can design an XML schema with complex objects from base data types. It includes constructs for defining and ordering, default values, mandatory content, nesting, repeated sets, and redefines.

Oracle XML DB supports all of the constructs defined by XML Schema, except for redefines.

17.1.3 XML Instance Documents

Documents conforming to an XML schema can be considered as instances of the class defined by that XML schema. A common use of an XML schema is to validate that a given such **instance document** conforms to the rules defined by the XML schema.

17.1.4 XML Namespaces and XML Schemas

An XML schema can specify a `targetNamespace` attribute, whose value is a URL. If omitted, the schema has no target namespace. The target namespace is the namespace for everything defined in the XML schema. The `targetNamespace` value is typically a URL where the XML schema can be accessed.

An XML instance document must specify the namespace of the root element of the document (same as the target namespace of the XML schema that the instance conforms to) and the location (URL) of the XML schema that defines this root element. This information is specified by attribute `xsi:schemaLocation`. When the XML schema has no target namespace, use attribute `xsi:noNamespaceSchemaLocation` to specify the schema URL.

17.1.5 Overview of Editing XML Schemas

You can author and edit XML schemas anyway you like.

For example, you can use any of the following:

- A simple text editor, such as Emacs or vi
- An XML Schema-aware editor, such as the XML editor included with Oracle JDeveloper
- An explicit XML Schema authoring tool, such as XMLSpy from Altova Corporation

[Figure 17-1](#) (page 17-3) shows a purchase-order XML schema being edited using XMLSpy. XMLSpy is a graphical XML tool from Altova Corporation that you can use to create and edit XML schemas and other XML documents. See <http://www.altova.com> for details.¹¹

Figure 17-1 XMLSpy Graphical Representation of a Purchase-Order XML Schema

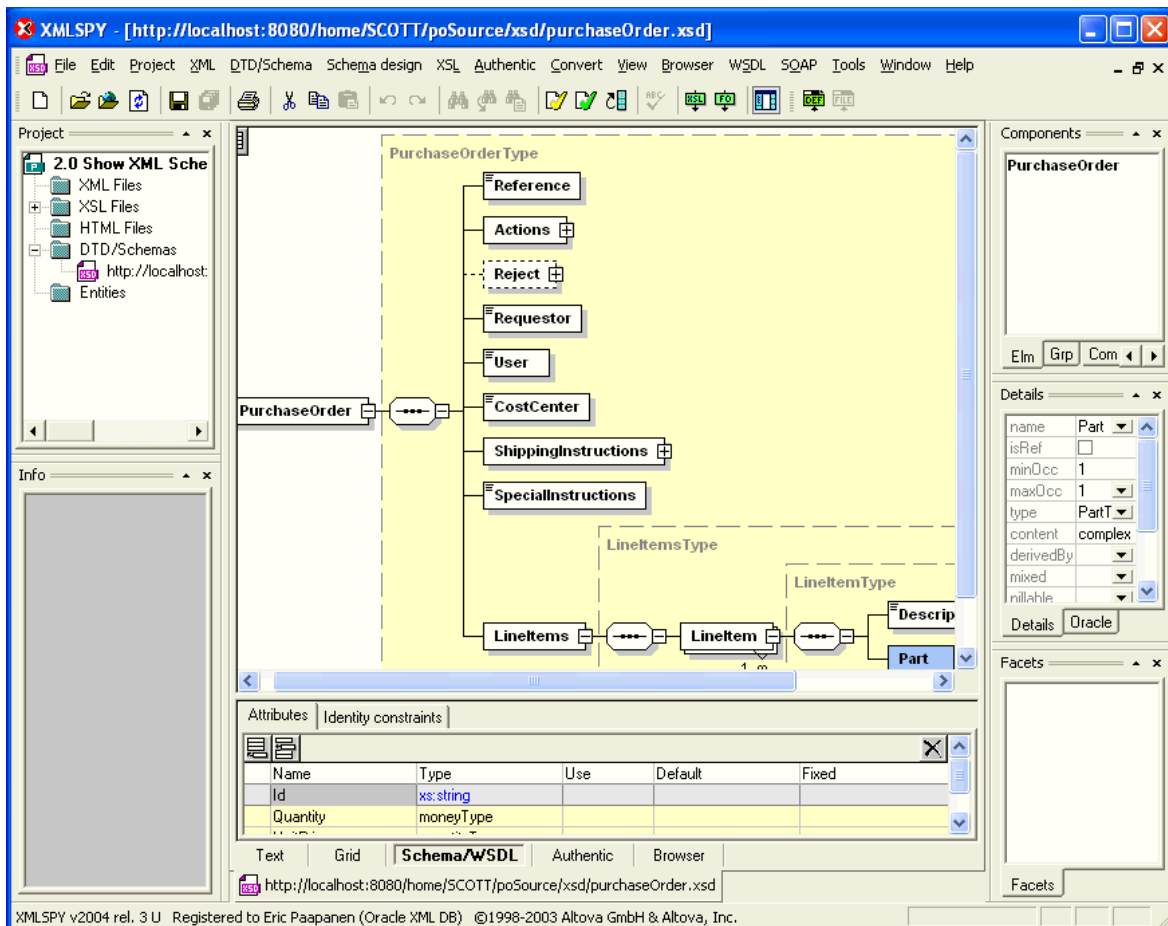

17.2 Overview of Using XML Schema with Oracle XML DB

Oracle XML DB supports registering XML schemas, validating documents against an XML schema, generating XML schemas from SQL object types, mapping from XML Schema to SQL, creating and querying XML Schema-based tables, views, and columns, and automatically inserting data when XML Schema-based documents are inserted into Oracle XML DB Repository.

XML schemas are stored in Oracle XML DB as `XMLType` instances, just like the XML documents that reference them. You must *register* an XML schema with Oracle XML DB in order to use it with XML data that is stored in the database.

Oracle XML DB takes advantage of the strong typing and other features of XML Schema to process XML database data safely and efficiently.

To be registered with Oracle XML DB, an XML schema must conform to the **root XML Schema, XDBSchema.xsd**. This is the XML schema for Oracle XML DB XML schemas. You can access `XDBSchema.xsd` at Oracle XML DB Repository location `/sys/schemas/PUBLIC/xmlns.oracle.com/xdb/XDBSchema.xsd`.

Oracle XML DB uses *annotated* XML schemas as metadata. The standard XML Schema definitions are used, along with several Oracle namespace attributes. These attributes determine how XML instance documents get mapped to the database. Because these

¹ XMLSpy also supports WebDAV and FTP protocols, so you can use it to directly access and edit content stored in Oracle XML DB Repository.

attributes are in a different namespace from the XML Schema namespace, such as annotated XML schemas respect the XML Schema standard.

Oracle XML DB provides XML Schema support for the following tasks:

- Registering W3C-compliant XML schemas, both local and global.
- Validating your XML documents against registered XML schema definitions.
- Generating XML schemas from SQL object types.
- Referencing an XML schema owned by another user.
- Referencing a global XML schema when a local XML schema exists with the same name.
- Generating a database mapping from your XML schemas during XML schema registration. This includes generating SQL object types, collection types, and default tables, and capturing the mapping information using XML schema attributes.
- Specifying a particular SQL data type mapping when there are multiple allowed mappings.
- Creating `XMLType` tables, views, and columns based on registered XML schemas.
- Manipulating and querying XML schema-based `XMLType` tables.
- Automatically inserting data into default tables when XML schema-based documents are inserted into Oracle XML DB Repository using protocols (FTP, HTTP(S)/WebDAV) and languages other than SQL.

17.2.1 Why Use XML Schema with Oracle XML DB?

Common reasons to use XML Schema include validation, constraint definition, storage specification, and optimization of document insertion, storage, and access.

- The most common use of XML Schema is as a mechanism for *validating* that XML instance documents conform to a given XML schema, that is, verify that your XML data conforms to its intended definition. This definition includes data types, numbers of allowed item occurrences, and allowed lengths of items.
- An XML schema can also be used as a *constraint* when creating `XMLType` tables or columns. For example, the table or column can be constrained to store only XML documents that compliant with one of the global elements defined by the XML schema.
- Oracle XML DB also uses XML Schema as a mechanism for defining how the contents of an `XMLType` instance should be stored inside the database. Both binary XML and object-relational storage models for `XMLType` support the use of XML Schema. When `XMLType` data is stored object-relationally, XML Schema is used to efficiently map XML Schema data types to SQL data types and object-relational tables and columns.
- XML schema information can also improve the efficiency of document insertion when you storing XML Schema-based documents in Oracle XML DB using protocols FTP and HTTP(S).

- When XML instances must be handled without any prior information about them, XML schemas can be useful in predicting optimum storage, fidelity, and access.

See Also:

[XMLType Storage Models](#) (page 1-11)

17.2.2 Overview of Annotating an XML Schema to Control Naming, Mapping, and Storage

The W3C XML Schema Recommendation lets vendor-specific annotations be added to an XML schema. Oracle XML DB uses annotations to control the mapping between an XML schema and various database features. You can use annotations to specify which tables store XML data. Annotation is especially useful for object-relational storage.

You can use XML schema annotations with Oracle XML DB to do the following:

- Specify which database tables are used to store the XML data.
- Override the default mapping between XML Schema data types and SQL data types, for object-relational storage.
- Name the database objects and attributes that are created to store XML data (for object-relational storage).

[Example A-2](#) (page A-34) shows an annotated purchase-order XML schema. It defines the following two XML namespaces:

- `http://www.w3c.org/2001/XMLSchema`. This is reserved by W3C for the Schema for Schemas.
- `http://xmlns.oracle.com/xdb`. This is reserved by Oracle for the Oracle XML DB schema annotations.

Before annotating an XML schema you *must* declare the Oracle XML DB namespace. The Oracle XML DB namespace is `http://xmlns.oracle.com/xdb`. [Example A-2](#) (page A-34) makes use of the namespace *prefix* `xdb` to abbreviate the Oracle XML DB namespace.

[Example A-2](#) (page A-34) uses several XML schema annotations, including the following:

- `defaultTable` annotation in the `PurchaseOrder` element. This specifies that XML documents, compliant with this XML schema are stored in a database table called `purchaseorder`.

- `SQLType` annotation.

The first occurrence of annotation `SQLType` specifies that the name of the SQL data type generated from `complexType` element `PurchaseOrderType` is `purchaseorder_t`.

The second occurrence of annotation `SQLType` specifies that the name of the SQL data type generated from `complexType` element `LineItemType` is `lineitem_t`.

- `SQLCollType` annotation. This specifies that the name of the SQL varray type that manages the collection of `LineItem` elements is `lineitem_v`.

- SQLName annotation. This provides an explicit name for each SQL object attribute of purchaseorder_t.

Figure 17-2 (page 17-6) shows the XMLSpy Oracle tab, which facilitates adding Oracle XML DB annotations to an XML schema while working in the graphical editor.

Figure 17-2 XMLSpy Support for Oracle XML DB Schema Annotations

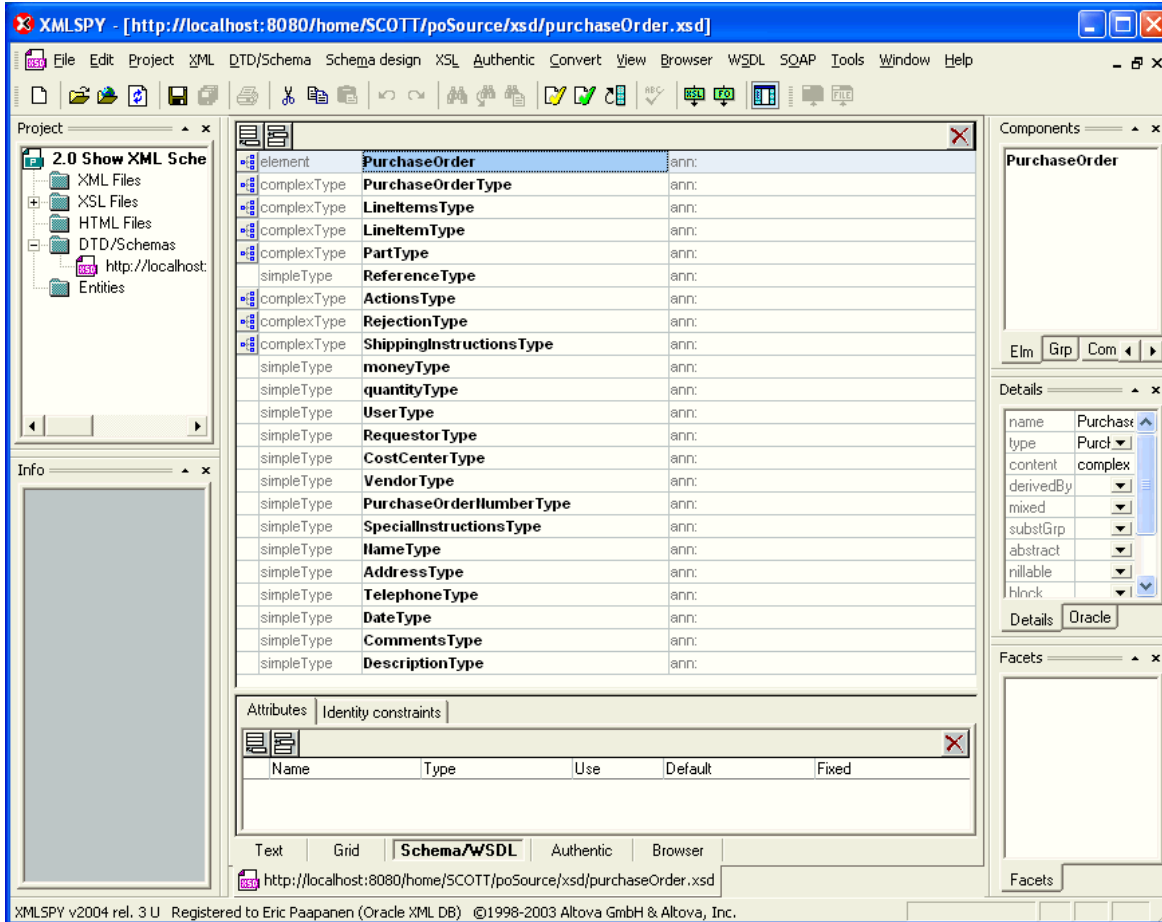

17.2.3 DOM Fidelity

DOM fidelity means that all information in an XML document is preserved except whitespace that is insignificant. You can use DOM fidelity to ensure the accuracy and integrity of XML documents stored in Oracle XML DB.

Document Object Model (DOM) fidelity is the concept of retaining the structure of a retrieved XML document, compared to the original XML document, for DOM traversals.

With DOM fidelity, XML data retrieved from the database has the same information as before it was inserted into the database, with the single exception of insignificant whitespace. The term "DOM fidelity" is used because this kind of fidelity is particularly important for DOM traversals.

With binary XML storage of XML data, all of the significant information is encoded in the binary XML format, ensuring DOM fidelity.

See Also:

[SYS_XDBPD\\$ and DOM Fidelity for Object-Relational Storage](#) (page 18-6) for information about DOM fidelity and object-relational storage of XML data

17.2.4 XMLType Methods Related to XML Schema

The most important XMLType methods for working with XML schemas are: `isSchemaBased()`, `getSchemaURL()`, `schemaValidate()`, `isSchemaValid()`, `isSchemaValidated()`, and `setSchemaValidated()`.

Table 17-1 XMLType Methods Related to XML Schema

XMLType Method	Description
<code>isSchemaBased()</code>	Returns TRUE if the XMLType instance is based on an XML schema, FALSE otherwise.
<code>getSchemaURL()</code>	The XML schema URL for an XMLType instance.
<code>schemaValidate()</code> <code>isSchemaValid()</code> <code>isSchemaValidated()</code> <code>setSchemaValidated()</code>	Validation of an XMLType instance against a registered XML schema: validate, check validation status, or set recorded validation status. See Transformation and Validation of XMLType Data (page 7-1).

17.3 XML Schema Registration with Oracle XML DB

Before an XML schema can be used by Oracle XML DB, you must register it. It can then be used to create XMLType tables and columns and to validate XML documents. If schema registration fails then the database is restored to the state it had prior to the registration attempt.

Like all DDL operations, XML schema registration is non-transactional. However, registration is *atomic*, in this sense:

- If registration succeeds then the operation is auto-committed.
- If registration fails then the database is rolled back to the state it had before registration began.

Because XML schema registration potentially involves creating object types and tables, error recovery involves dropping any types and tables thus created. The entire XML schema registration process is guaranteed to be atomic: either it succeeds or the database is restored to its state before the start of registration.

Two items are required to register an XML schema with Oracle XML DB:

- The XML schema document
- A string that can be used as a unique identifier for the XML schema, after it is registered with Oracle Database. XML instance documents use this unique identifier to identify themselves as members of the class defined by the XML schema. The identifier is typically in the form of a URL, and is often referred to as the **schema location hint** or the **document location hint**.

Note:

The act of registering an XML schema has *no effect* on the status of any instance documents that are *already loaded* into Oracle XML DB Repository and that reference that XML schema.

Such instance documents were treated as non XML-schema-based when they were loaded. They remain such. After schema registration, you must *delete* such documents and *reload* them, in order to obtain XML schema-based documents.

17.3.1 XML Schema Registration Actions

As part of registering an XML schema, Oracle XML DB performs several actions that facilitate storing, accessing, and manipulating XML instances that conform to the XML schema.

These include:

- Mapping XML Schema data types to Oracle XML DB storage. When XML schema-based data is stored, its storage data types are derived from the XML Schema data types using a default mapping and, optionally, using mapping information that you specify using XML schema annotations. For binary XML storage, XML Schema types are mapped to binary XML encoding types. For object-relational storage, XML schema registration creates the appropriate SQL object types for the object-relational storage of conforming documents.
- Creating default tables. XML schema registration generates default `XMLType` tables for all global elements. You can use XML-schema annotations to control the names of the tables, and to provide column-level and table-level storage clauses and constraints for use during table creation.

See Also:

- [XML Schema Data Types Are Mapped to Oracle XML DB Storage](#) (page 17-26)
 - [Default Tables Created during XML Schema Registration](#) (page 18-5)
 - [Oracle XML Schema Annotations](#) (page 18-7)
-

After XML schema registration, documents that reference the XML schema using the XML Schema instance mechanism can be processed automatically by Oracle XML DB. For XML data that is stored object-relationally, `XMLType` tables and columns can be created that are constrained to the global elements defined by the XML schema.

17.3.2 Registering an XML Schema with Oracle XML DB

An example illustrates the use of PL/SQL procedure `DBMS_XMLSCHEMA.registerSchema` to register an XML schema. The main parameters of this procedure are the schema URL, the schema source document, the character-set ID of the source-document encoding, and options that specify how the schema should be registered.

The main parameters to `DBMS_XMLSCHEMA.registerSchema` are as follows:

- **SCHEMAURL** – the XML schema URL. This is a unique identifier for the XML schema within Oracle XML DB. It is conventionally in the form of a URL, but this is not a requirement. The XML schema URL is used with Oracle XML DB to identify instance documents, by making the schema location hint identical to the XML schema URL. Oracle XML DB never tries to access a Web server identified by the specified URL.

Note:

- You cannot register an XML schema using the same **SCHEMAURL** as any system-defined XML schema.
 - The non-protocol part of the URL must be unique. The protocol part (for example, `http` or `https`) is ignored in the test for uniqueness.
-
-

- **SCHEMADOC** – The XML schema source document. This is a `VARCHAR`, `CLOB`, `BLOB`, `BFILE`, `XMLType`, or `URIType` value.
- **CSID** – The character-set ID of the source-document encoding, when `schemaDoc` is a `BFILE` or `BLOB` value.
- **OPTIONS** – Options that specify how the XML schema should be registered. The most important option is `REGISTER_BINARYXML`, which indicates that the XML schema is used for binary XML storage. Another option is `REGISTER_NT_AS_IOT`, which forces OCTs to be stored as index-organized tables (IOTs).

See Also:

Oracle Database PL/SQL Packages and Types Reference

[Example 17-1](#) (page 17-10) registers the annotated XML schema of [Example A-2](#) (page A-34).

In [Example A-2](#) (page A-34), the unique identifier for the XML schema is:

```
http://localhost:8080/source/schemas/poSource/xsd/purchaseOrder.xsd
```

The XML schema document was previously loaded into Oracle XML DB Repository at this path: `/source/schemas/poSource/xsd/purchaseOrder.xsd`.

During XML schema registration, option `SCHEMADOC` specifies that PL/SQL constructor `XDBURIType` is to access the content of the XML schema document, based on its location in the repository. Other options passed to procedure `registerSchema` specify that the schema in [Example A-2](#) (page A-34) is to be registered as a local XML schema (option `LOCAL`), and that SQL objects, and that tables are to be generated during the registration process (option `GENTABLES`).

PL/SQL procedure `DBMS_XMLSCHEMA.registerSchema` performs the following operations:

- Parses and validates the XML schema.
- Creates a set of entries in Oracle Data Dictionary that describe the XML schema.
- Creates a set of SQL object definitions, based on `complexType` elements defined in the XML schema.

- Creates an `XMLType` table for each global element defined by the XML schema.

By default, when an XML schema is registered, Oracle XML DB automatically generates all of the SQL object types and `XMLType` tables required to manage the instance documents. An XML schema can be registered as global or local.

See Also:

- [Local and Global XML Schemas](#) (page 17-12)
 - [SQL Types and Tables Created During XML Schema Registration](#) (page 17-10)
 - *Oracle Database PL/SQL Packages and Types Reference* for information about `DBMS_XMLSCHEMA.registerSchema`
-
-

Example 17-1 Registering an XML Schema Using `DBMS_XMLSCHEMA.REGISTERSCHEMA`

```
BEGIN
  DBMS_XMLSCHEMA.registerSchema(
    SCHEMAURL => 'http://localhost:8080/source/schemas/poSource/xsd/purchaseOrder.xsd',
    SCHEMADOC => XDBURITYPE('/source/schemas/poSource/xsd/purchaseOrder.xsd').getCLOB(),
    LOCAL      => TRUE,
    GENTYPES   => TRUE,
    GENTABLES  => TRUE);
END;
/
```

17.3.3 SQL Types and Tables Created During XML Schema Registration

Registration of an XML schema results in the creation of object types and tables.

[Example 17-2](#) (page 17-10) shows the SQL type definitions that were created during an XML schema registration such as that of [Example 17-1](#) (page 17-10). These SQL type definitions include:

- `purchaseorder_t`. This type is used to persist the SQL objects generated from a `PurchaseOrder` element. When an XML document containing a `PurchaseOrder` element is stored in Oracle XML DB the document is broken up, and the contents of the document are stored as an instance of `purchaseorder_t`.
- `lineitems_t`, `lineitem_v`, and `lineitem_t`. These types manage the collection of `LineItem` elements that may be present in a `PurchaseOrder` document. Type `lineitems_t` consists of a single attribute `lineitem`, defined as an instance of type `lineitem_v`. Type `lineitem_v` is defined as a varray of `lineitem_t` objects. There is one instance of the `lineitem_t` object for each `LineItem` element in the document.

Example 17-2 Objects Created During XML Schema Registration

```
DESCRIBE purchaseorder_t
purchaseorder_t is NOT FINAL
Name                               Null?    Type
-----
SYS_XDBPD$                          XDB.XDB$RAW_LIST_T
REFERENCE                            VARCHAR2(30 CHAR)
ACTIONS                              ACTIONS_T
REJECTION                            REJECTION_T
REQUESTOR                            VARCHAR2(128 CHAR)
USERID                               VARCHAR2(10 CHAR)
```

```

COST_CENTER          VARCHAR2(4 CHAR)
SHIPPING_INSTRUCTIONS SHIPPING_INSTRUCTIONS_T
SPECIAL_INSTRUCTIONS VARCHAR2(2048 CHAR)
LINEITEMS           LINEITEMS_T

```

```
DESCRIBE lineitems_t
```

```
lineitems_t is NOT FINAL
```

Name	Null?	Type
-----	-----	-----
SYS_XDBPD\$		XDB.XDB\$RAW_LIST_T
LINEITEM		LINEITEM_V

```
DESCRIBE lineitem_v
```

```
lineitem_v VARRAY(2147483647) OF LINEITEM_T
```

```
LINEITEM_T is NOT FINAL
```

Name	Null?	Type
-----	-----	-----
SYS_XDBPD\$		XDB.XDB\$RAW_LIST_T
ITEMNUMBER		NUMBER(38)
DESCRIPTION		VARCHAR2(256 CHAR)
PART		PART_T

17.3.4 Default Tables for Global Elements

By default, tables with system-generated names are created for all global elements. You can specify names to use instead. You can prevent the creation of default tables for particular elements, which can reduce processor time and space used, especially if an XML schema contains many global element definitions.

By default, when an XML schema is registered with the database, Oracle XML DB generates a *default table for each global element* defined by the XML schema.

You can use attribute `xdb:defaultTable` to specify the name of the default table for a given global element. Each `xdb:defaultTable` attribute value you provide must be *unique* among *all schemas* registered by a given database user. If you do *not* supply a nonempty default table name for some element, then a unique name is provided automatically.

In practice, however, you do *not* want to create a default table for most global elements. Elements that never serve as the root element for an XML instance document do not need default tables — such tables are never used. Creating default tables for all global elements can lead to significant overhead in processor time and space used, especially if an XML schema contains a large number of global element definitions.

As a general rule, then, you want to prevent the creation of a default table for any global element (or any local element stored out of line) that you are sure will *not* be used as a root element in any document. You can do this in one of the following ways:

- Add the annotation `xdb:defaultTable = ""` (empty string) to the definition of *each* global element that will *not* appear as the root element of an XML instance document. Using this approach, you allow automatic default-table creation, in general, and you prohibit it explicitly where needed, using `xdb:defaultTable = ""`.
- Set parameter `GENTABLES` to `FALSE` when registering the XML schema, and then *manually create the default table* for each global element that can legally appear as the root element of an instance document. Using this approach, you inhibit automatic default-table creation, and you create only the tables that are needed, by hand.

17.3.5 Database Objects That Depend on Registered XML Schemas

Several kinds of database object can depend on registered XML schemas: tables, views, other XML schemas, and cursors that reference an XML schema.

More precisely:

- Tables or views that have an `XMLType` column that conforms to an element in an XML schema.
- Other XML schemas that include or import a given XML schema as part of their definition.
- Cursors that reference an XML schema. This includes references within functions of package `DBMS_XMLGEN`. Such cursors are purely transient objects.

17.3.6 Local and Global XML Schemas

An XML schema can be registered as local (visible only to its owner, by default) or global (visible to all database users, by default).

When you register an XML schema, PL/SQL package `DBMS_XMLSCHEMA` adds a corresponding resource to Oracle XML DB Repository. The XML schema URL determines the path name of the XML schema resource in the repository (and it is associated with parameter `SCHEMAURL` of PL/SQL procedure `DBMS_XMLSCHEMA.registerSchema`).

Note:

In Oracle Enterprise Manager, local and global registered XML schemas are referred to as **private** and **public**, respectively.

17.3.6.1 Local XML Schema

By default, an XML schema is local, meaning that it belongs to you alone, after you register it with Oracle XML DB. A reference to the XML schema document is stored in Oracle XML DB Repository under your user (database schema) name.

Such XML schemas are referred to as **local**. By default, they are usable only by you, the owner. In Oracle XML DB, local XML schema resources are created under folder `/sys/schemas/username`. The rest of the repository path name is derived from the schema URL.

For example, if the XML schema `purchaseOrder.xsd` is registered as a local schema by user `QUINE`, it is given this path name:

```
/sys/schemas/QUINE/xmlns.oracle.com/xdb/documentation/purchaseOrder.xsd
```

Database users need appropriate permissions and Access Control Lists (ACLs) to create a resource with a given path name, in order to register the XML schema as a local XML schema. Some ways in which a local XML schema can be registered require one or more of the following privileges:

- `ALTER SESSION`
- `CREATE PROCEDURE`

- CREATE SESSION
- CREATE TABLE
- CREATE TRIGGER
- CREATE TYPE

See Also:

[Repository Access Control](#) (page 27-1)

Note:

Typically, only the owner of the XML schema can use it to define XMLType tables, columns, or views, validate documents, and so on. However, Oracle XML DB supports fully qualified XML schema URLs. For example: `http://xmlns.oracle.com/xdb/schemas/QUINE/xmlns.oracle.com/xdb/documentation/purchaseOrder.xsd`. Privileged users can use such an extended URL to specify XML schemas belonging to other users (in this case, user QUINE).

Example 17-3 Registering a Local XML Schema

```
BEGIN
  DBMS_XMLSCHEMA.registerSchema(
    SCHEMAURL => 'http://xmlns.oracle.com/xdb/documentation/purchaseOrder.xsd',
    SCHEMADOC => bfilename('XMLDIR', 'purchaseOrder.xsd'),
    LOCAL      => TRUE,
    GENTYPES   => TRUE,
    GENTABLES  => FALSE,
    CSID       => nls_charset_id('AL32UTF8'));
END;
/
```

17.3.6.2 Global XML Schema

In contrast to local XML schemas, a privileged user can register an XML schema as global by specifying an argument to registration function `DBMS_XMLSCHEMA`. are visible to *all* users. They are stored under folder `/sys/schemas/PUBLIC/` in Oracle XML DB Repository.

Note:

Access to folder `/sys/schemas/PUBLIC` is controlled by access control lists (ACLs). By default, this folder is writable only by a database administrator. You need write privileges on this folder to register global XML schemas. Role XDBADMIN provides write access to this folder, assuming that it is protected by the default ACLs. See [Repository Access Control](#) (page 27-1).

You can register a local schema with the same URL as an existing global schema. A local schema always shadows (hides) any global schema with the same name (URL).

[Example 17-4](#) (page 17-14) illustrates the registration of a global schema.

Example 17-4 Registering a Global XML Schema

```
GRANT XDBADMIN TO QUINE;
```

Grant succeeded.

```
CONNECT quine
Enter password: password
```

Connected.

```
BEGIN
  DBMS_XMLSCHEMA.registerSchema(
    SCHEMAURL => 'http://xmlns.oracle.com/xdb/documentation/purchaseOrder.xsd',
    SCHEMADOC => bfilename('XMLDIR', 'purchaseOrder.xsd'),
    LOCAL     => FALSE,
    GENTYPES  => TRUE,
    GENTABLES => FALSE,
    CSID      => nls_charset_id('AL32UTF8'));
END;
/
```

If this global XML schema is registered by user QUINE, it is given this path name:

```
/sys/schemas/PUBLIC/xmlns.oracle.com/xdb/documentation/purchaseOrder.xsd
```

Database users need appropriate permissions (ACL access) to create this resource in order to register the XML schema as global.

17.3.7 Fully Qualified XML Schema URLs

Fully qualified XML schema URLs permit explicit reference to particular XML schemas. The name of the database user owning the XML schema is specified as part of the URL. Fully qualified schema URLs belong to the Oracle XML DB namespace.

By default, XML schema URLs are referenced within the scope of the current database user. XML schema URLs are first resolved as the names of *local* XML schemas owned by the current user.

- If there are no such XML schemas, then they are resolved as names of *global* XML schemas.
- If there are no *global* XML schemas either, then Oracle XML DB raises an error.

The Oracle XML DB namespace is:

```
http://xmlns.oracle.com/xdb/schemas/<database-user>/<schemaURL-minus-protocol>
```

For example, suppose there is a registered global XML schema with the URL `http://www.example.com/po.xsd`, and user QUINE has a local registered XML schema with the same URL. Another user can reference the schema owned by QUINE as follows using this fully qualified XML Schema URL:

```
http://xmlns.oracle.com/xdb/schemas/QUINE/www.example.com/po.xsd
```

The fully qualified URL for the global XML schema is:

```
http://xmlns.oracle.com/xdb/schemas/PUBLIC/www.example.com/po.xsd
```

See Also:[Local and Global XML Schemas](#) (page 17-12)

17.3.8 Deletion of an XML Schema

You can delete a registered XML schema using procedure `DBMS_XMLSCHEMA.deleteSchema`.

This does the following, by default:

1. Checks that the current user has the appropriate privileges to delete the resource corresponding to the XML schema within Oracle XML DB Repository. You can control which users can delete which XML schemas, by setting the appropriate ACLs on the XML schema resources.
2. Checks whether there are any tables dependent on the XML schema that is to be deleted. If so, raises an error and cancels the deletion. This check is not performed if option `delete_invalidate` or `delete_cascade_force` is used. In that case, no error is raised.
3. Removes the XML schema document from the Oracle XML DB Repository (folder `/sys/schemas`).
4. Removes the XML schema document from `DBA_XML_SCHEMAS`, unless it was registered for use with binary XML instances and neither `delete_invalidate` nor `delete_cascade_force` is used.
5. Drops the default table, if either `delete_cascade` or `delete_cascade_force` is used. Raises an error if `delete_cascade` is specified and there are instances in other tables that are also dependent on the XML schema.

The following values are available for option `DELETE_OPTION` of procedure `DBMS_XMLSCHEMA.deleteSchema`:

- `DELETE_RESTRICT` – Raise an error and cancel deletion if dependencies are detected. This is the default behavior.
- `DELETE_INVALIDATE` – Do not raise an error if dependencies are detected. Instead, mark each of the dependencies as being invalid.
- `DELETE_CASCADE` – Drop all types and default tables that were generated during XML schema registration. Raise an error if there are instances that depend upon the XML schema that are stored in tables other than the default table. However, do not raise an error for any such instances that are stored in `XMLType` columns that were created using `ANY_SCHEMA`. If the XML schema was registered for use with binary XML, do not remove it from `DBA_XML_SCHEMAS`.
- `DELETE_CASCADE_FORCE` – Drop all types and default tables that were generated during XML schema registration. Do not raise an error if there are instances that depend upon the XML schema that are stored in tables other than the default table. Instead, mark each of the dependencies as being invalid. Remove the XML schema from `DBA_XML_SCHEMAS`.

See Also:

Oracle Database PL/SQL Packages and Types Reference

[Example 17-5](#) (page 17-16) illustrates the use of `DELETE_CASCADE_FORCE`.

If an XML schema was registered for use with binary XML, it is not removed from `DBA_XML_SCHEMAS` when you delete it using option `DELETE_RESTRICT` (the default value) or `DELETE_CASCADE`. Therefore, although you can no longer use the XML schema to encode new XML instance documents, any existing documents in Oracle XML DB that reference the XML schema can still be *decoded* using it.

This remains the case until you remove the XML schema from `DBA_XML_SCHEMAS` using `DBMS_XMLSCHEMA.purgeSchema`. Oracle recommends that, in general, you use `delete_restrict` or `delete_cascade`. Instead of using `DELETE_CASCADE_FORCE`, call `DBMS_XMLSCHEMA.purgeSchema` when you are sure you no longer need the XML schema.

Procedure `purgeSchema` removes the XML schema completely from Oracle XML DB. In particular, it removes it from `DBA_XML_SCHEMAS`. Before you use `DBMS_XMLSCHEMA.purgeSchema`, be sure that you have transformed all existing XML documents that reference the XML schema to be purged, so they reference a different XML schema or no XML schema. Otherwise, it will be impossible to decode them after the purge.

Example 17-5 Deleting an XML Schema with `DBMS_XMLSCHEMA.DELETESHEMA`

```
BEGIN
  DBMS_XMLSCHEMA.deleteSchema(
    SCHEMAURL => 'http://xmlns.oracle.com/xdb/documentation/purchaseOrder.xsd',
    DELETE_OPTION => DBMS_XMLSCHEMA.DELETE_CASCADE_FORCE);
END;
/
```

17.3.9 Listing All Registered XML Schemas

An example lists all XML schemas that are registered with Oracle XML DB.

[Example 17-6](#) (page 17-16) shows how to use PL/SQL procedure `DBMS_XMLSCHEMA.registerSchema` to obtain a list of all XML schemas registered with Oracle XML DB. You can also examine views `USER_XML_SCHEMAS`, `ALL_XML_SCHEMAS`, `USER_XML_TABLES`, and `ALL_XML_TABLES`.

Example 17-6 Data Dictionary Table for Registered Schemas

```
DESCRIBE DBA_XML_SCHEMAS
```

Name	Null?	Type
OWNER		VARCHAR2(30)
SCHEMA_URL		VARCHAR2(700)
LOCAL		VARCHAR2(3)
SCHEMA		XMLTYPE(XMLSchema "http://xmlns.oracle.com/xdb/XDBSchema.xsd" Element "schema")
INT_OBJNAME		VARCHAR2(4000)
QUAL_SCHEMA_URL		VARCHAR2(767)
HIER_TYPE		VARCHAR2(11)
BINARY		VARCHAR2(3)
SCHEMA_ID		RAW(16)

```

HIDDEN          VARCHAR2(3)

SELECT OWNER, LOCAL, SCHEMA_URL FROM DBA_XML_SCHEMAS;

OWNER  LOC  SCHEMA_URL
-----
XDB    NO   http://xmlns.oracle.com/xdb/XDBSchema.xsd
XDB    NO   http://xmlns.oracle.com/xdb/XDBResource.xsd
XDB    NO   http://xmlns.oracle.com/xdb/acl.xsd
XDB    NO   http://xmlns.oracle.com/xdb/dav.xsd
XDB    NO   http://xmlns.oracle.com/xdb/XDBStandard.xsd
XDB    NO   http://www.w3.org/2001/xml.xsd
XDB    NO   http://xmlns.oracle.com/xdb/stats.xsd
XDB    NO   http://xmlns.oracle.com/xdb/xdbconfig.xsd
SCOTT  YES  http://xmlns.oracle.com/xdb/documentation/purchaseOrder.xsd

13 rows selected.

DESCRIBE DBA_XML_TABLES

Name          Null? Type
-----
OWNER          VARCHAR2(30)
TABLE_NAME     VARCHAR2(30)
XMLSCHEMA      VARCHAR2(700)
SCHEMA_OWNER   VARCHAR2(30)
ELEMENT_NAME   VARCHAR2(2000)
STORAGE_TYPE   VARCHAR2(17)
ANYSHEMA       VARCHAR2(3)
NONSCHEMA      VARCHAR2(3)

SELECT TABLE_NAME FROM DBA_XML_TABLES
       WHERE XMLSCHEMA = 'http://xmlns.oracle.com/xdb/documentation/purchaseOrder.xsd';

TABLE_NAME
-----
PurchaseOrder1669_TAB

1 row selected.

```

17.4 Creation of XMLType Tables and Columns Based on XML Schemas

You can create XMLType tables and columns that are constrained to a global element defined by an XML schema. After an XMLType column has been constrained to a particular element and a particular schema, it can only contain documents that are compliant with the schema definition of that element.

You constrain an XMLType table column to a particular element and XML schema by adding appropriate XMLSCHEMA and ELEMENT clauses to the CREATE TABLE operation.

Figures [Figure 17-3](#) (page 17-18) through [Figure 17-6](#) (page 17-18) show the syntax for creating an XMLType table.

See Also:

Oracle Database SQL Language Reference for the complete description of CREATE TABLE, including syntax elements such as object_properties.

Note:

To create an XMLType table in a different database schema from your own, you must have not only privilege CREATE ANY TABLE but also privilege CREATE ANY INDEX. This is because a unique index is created on column OBJECT_ID when you create the table. Column OBJECT_ID stores a system-generated object identifier.

Figure 17-3 Creating an XMLType Table – CREATE TABLE Syntax

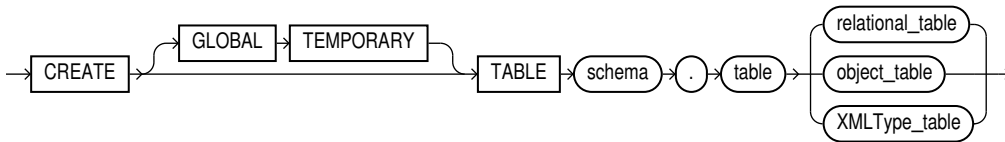

Figure 17-4 Creating an XMLType Table – XMLType_table Syntax

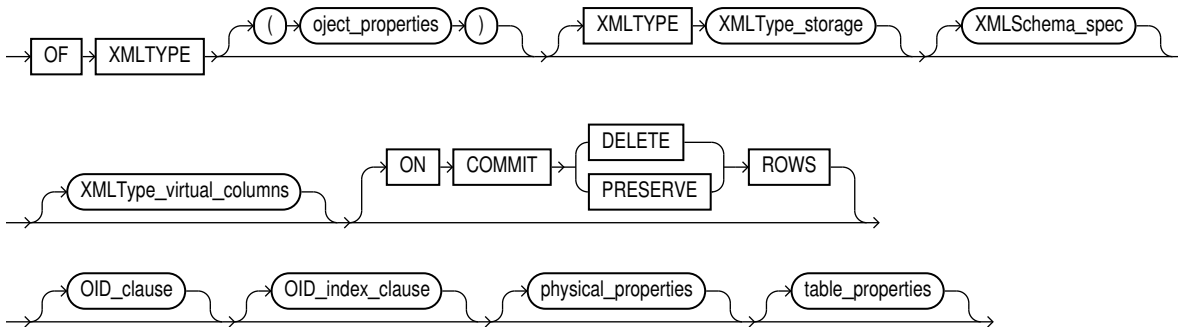

Figure 17-5 Creating an XMLType Table – table_properties Syntax

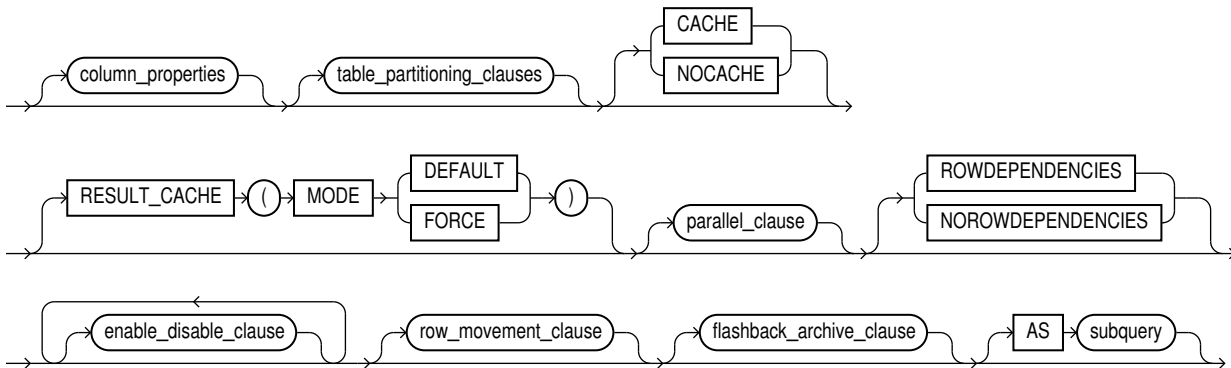

Figure 17-6 Creating an XMLType Table – XMLType_virtual_columns Syntax



Note:

- Clause `XMLType_virtual_columns` can be used only for XMLType data that is stored as *binary XML*. In particular, if you use it for data that is stored object-rationally, and if you use a partitioning clause, then an error is raised.
- For XML data, virtual columns are used primarily for partitioning or defining SQL constraints. If your need is to project out specific XML data in order to access it relationally, then consider using SQL/XML function `XMLTable` or `XMLIndex` with a structured component.

See Also:

- [Creating Virtual Columns on XMLType Data Stored as Binary XML](#) (page 3-2)
- [XMLTABLE SQL/XML Function in Oracle XML DB](#) (page 4-11)
- [XMLIndex Structured Component](#) (page 6-9)

A subset of the XPointer notation can also be used to provide a single URL that contains the XML schema location and element name. See also [Query and Update of XML Data](#) (page 5-1).

Example 17-7 (page 17-19) shows two `CREATE TABLE` statements. The first creates XMLType table `purchaseorder_as_table`. The second creates relational table `purchaseorder_as_column`, which has XMLType column `xml_document`. In each table, the XMLType instance is constrained to the `PurchaseOrder` element that is defined by the XML schema registered with URL `http://xmlns.oracle.com/xdb/documentation/purchaseOrder.xsd`.

There are two ways to specify XMLSchema and Element:

- as separate clauses, XMLSchema and Element
- using only the Element clause with an XPointer notation

The data associated with an XMLType table or column that is constrained to an XML schema can be stored in different ways:

- Decomposed and stored object-rationally
- Stored as binary XML, using a single binary-XML column

Example 17-7 Creating XML Schema-Based XMLType Tables and Columns

```
CREATE TABLE purchaseorder_as_table OF XMLType
  XMLSCHEMA "http://xmlns.oracle.com/xdb/documentation/purchaseOrder.xsd"
  ELEMENT "PurchaseOrder";

CREATE TABLE purchaseorder_as_column (id NUMBER, xml_document XMLType)
  XMLTYPE COLUMN xml_document
  ELEMENT
    "http://xmlns.oracle.com/xdb/documentation/purchaseOrder.xsd#PurchaseOrder";
```

17.4.1 Specification of XMLType Storage Options for XML Schema-Based Data

You can specify storage options to use when you manually create a table that stores XML instance documents that reference an XML schema. To specify a particular XMLType storage model, use a `STORE AS` clause in the `CREATE TABLE` statement.

Otherwise, the storage model specified during registration of the XML schema is used. If no storage model was specified during registration, then object-relational storage is used.

Besides specifying storage options for XML schema-based data, you can also specify storage options for tables that are created automatically, by using XML schema annotations.

See Also:

- [Oracle XML Schema Annotations](#) (page 18-7)
 - [Choice of XMLType Storage and Indexing](#) (page 16-1)
-
-

17.4.1.1 Binary XML Storage of XML Schema-Based Data

If you specify `STORE AS BINARY_XML` then binary XML storage is used. If you specify an XML schema that the documents must conform to then you can use that schema only to create XMLType tables and columns that are stored as binary XML.

You *cannot* use the same XML schema to create XMLType tables and columns that are stored object-rationally.

The converse is also true: If you use object-relational storage for the registered XML schema, then you can use only that XML schema to create XMLType tables and columns that are stored as binary XML.

Binary XML storage offers a great deal of flexibility for XML data, especially concerning the use of XML schemas. Binary XML encodes XML data differently, depending upon whether or not an XML schema is used for the encoding, and it can encode the same data differently using different XML schemas.

When an XML schema is taken into account for encoding binary XML data, the XML Schema data types are mapped to encoded types for storage. Alternatively, you can encode XML data as non-schema-based binary XML, whether or not the data references an XML schema. In that case, any referenced XML schema is ignored, and there is no encoding of XML Schema data types.

When you create an XMLType table or column and you use binary XML storage, you can specify how to encode the column or table to make use of XML schemas. Choose from among these possibilities:

- Encode the column or table data as *non-schema-based* binary XML. The XML data stored in the column can nevertheless conform to an XML schema, but it need not. Any referenced XML schema is ignored for encoding purposes, and documents are not automatically validated when they are inserted or updated.

You can nevertheless explicitly validate an XML schema-based document that is encoded as non-schema-based binary XML. This represents an important use case: situations where you do not want to tie documents too closely to a particular XML schema, because you might change it or delete it.

- Encode the column or table data to conform to a *single XML schema*. All rows (documents) must conform to the same XML schema. You can nevertheless specify, as an option, that non-schema-based documents can also be stored in the same column.
- Encode the column or table data to conform to whatever XML schema it references. Each row (document) can reference *any XML schema*, and that XML schema is used to encode that particular XML document. In this case also, you can specify, as an option, that non-schema-based documents can also be stored in the same column.

You can use multiple *versions* of the same XML schema in this way. Store documents that conform to different versions. Each is encoded according to the XML schema that it references.

You can specify that any XML schema can be used for encoding by using option `ALLOW ANYSCHEMA` when you create the table.

Note:

- If you use option `ALLOW ANYSCHEMA`, then any XML schema referenced by your instance documents is used *only for validation*. It is *not* used at query time. Queries of your data treat it as if it were non XML schema-based data.
 - Oracle recommends that you do *not* use option `ALLOW ANYSCHEMA` if you anticipate using copy-based XML schema evolution (see [Copy-Based Schema Evolution](#) (page 20-2)). If you use this option, it is impossible to determine which rows (documents) might conform to the XML schema that is evolved. Conforming rows are not transformed during copy-based evolution, and afterward they are not decodable.
-
-

You can specify, for tables and columns that use XML schema-based encodings, that they can accept also non-schema-based documents by using option `ALLOW NONSCHEMA`. In the absence of keyword `XMLSCHEMA`, encoding is for non-schema-based documents. In the absence of the keywords `ALLOW NONSCHEMA` but the presence of keyword `XMLSCHEMA`, encoding is for the single XML schema specified. In the absence of the keywords `ALLOW NONSCHEMA` but the presence of the keywords `ALLOW ANYSCHEMA`, encoding is for any XML schema that is referenced.

An error is raised if you try to insert an XML document into an XMLType table or column that does not correspond to the document.

The various possibilities are summarized in [Table 17-2](#) (page 17-21).

Table 17-2 CREATE TABLE Encoding Options for Binary XML

Storage Options	Encoding Effect
<code>STORE AS BINARY XML</code>	Encodes all documents using the non-schema-based encoding.
<code>STORE AS BINARY XML XMLSCHEMA ...</code>	Encodes all documents using an encoding based on the referenced XML schema. Trying to insert or update a document that does not conform to the XML schema raises an error.

Table 17-2 (Cont.) CREATE TABLE Encoding Options for Binary XML

Storage Options	Encoding Effect
STORE AS BINARY XML XMLSCHEMA ... ALLOW NONSCHEMA	Encodes all XML schema-based documents using an encoding based on the referenced XML schema. Encodes all non-schema-based documents using the non-schema-based encoding. Trying to insert or update an XML schema-based document that does not conform to the referenced XML schema raises an error.
STORE AS BINARY XML ALLOW ANYSCHEMA	Encodes all XML schema-based documents using an encoding based on the XML schema referenced by the document. Trying to insert or update a document that does not reference a registered XML schema or that does not conform to the XML schema it references raises an error.
STORE AS BINARY XML ALLOW ANYSCHEMA ALLOW NONSCHEMA	Encodes all XML schema-based documents using an encoding based on the XML schema referenced by the document. Encodes all non-schema-based documents using the non-schema-based encoding. Trying to insert or update an XML schema-based document that does not conform to the registered XML schema it references raises an error.

Note:

If you use `CREATE TABLE` with `ALLOW NONSCHEMA` but not `ALLOW ANYSCHEMA`, then all documents, even XML schema-based documents, are encoded using the non-schema-based encoding. If you later use `ALTER TABLE` with `ALLOW ANYSCHEMA` on the same table, this has no effect on the encoding of documents that were stored prior to the `ALTER TABLE` operation — all such documents continue to be encoded using the non-schema-based encoding, regardless of whether they reference an XML schema. Only XML schema-based documents that you insert in the table after the `ALTER TABLE` operation are encoded using XML schema-based encodings.

17.4.1.2 Object-Relational Storage of XML Schema-Based Data

After you register an XML schema you can create an object-relational XMLType table or column for documents that conform to that schema. You can optionally specify object-relational storage options for the table or column.

Suppose that you have registered a purchase-order XML schema, identified by URL `http://xmlns.oracle.com/xdb/documentation/purchaseOrder.xsd`. You then create an object-relational XMLType table, `purchaseorder_as_table`, to store instances that conform to element `PurchaseOrder` of the XML schema, as in [Example 17-8](#) (page 17-24).

This automatically creates hidden columns that correspond to the database object type to which the `PurchaseOrder` element has been mapped. In addition, an `XMLEXTRA` object column is created, to store top-level instance data such as namespace declarations. `XMLEXTRA` is reserved for internal use.

Suppose that XML schema `purchaseOrder.xsd` defines element `LineItems` as a child of element `PurchaseOrder`, and that `LineItems` is a collection of `LineItem` elements.

With object-relational storage, collections are mapped to SQL varray values. An XML **collection** is any element that is defined by the XML schema with `maxOccurs > 1`, allowing it to appear multiple times. By default, the entire contents of such a varray is stored as a set of rows in an ordered collection table (OCT).

[Example 17-9](#) (page 17-24) creates table `purchaseorder_as_table` differently from [Example 17-8](#) (page 17-24). It specifies additional storage options:

- The `LineItems` collection varray is stored as a LOB, not as a table.
- Tablespace `USERS` is used for storing element `Notes`.
- The table is compressed for online transaction processing (OLTP).

Note:

In releases prior to Oracle Database 11gR2, the default behavior for `CREATE TABLE` was to store a collection using a varray stored as a LOB, not a varray stored as a table.

Note:

When compression is specified for a parent `XMLType` table or column, all descendant `XMLType` ordered collection tables (OCTs) are similarly compressed.

See Also:

- [Oracle XML Schema Annotations](#) (page 18-7) for information about specifying storage options by using XML schema annotations
 - *Oracle Database SQL Language Reference* for information about compression for OLTP
-
-

As a convenience, if you need to specify that *all* varrays in an `XMLType` table or column are to be stored as LOBs, or all are to be stored as tables, then you can use the syntax clause `STORE ALL VARRAYS AS`, followed by `LOBs` or `TABLES`, respectively. This is a convenient alternative to using multiple `VARRAY...STORE AS` clauses, one for each collection. [Example 17-10](#) (page 17-24) illustrates this.

The storage method specified using `STORE ALL VARRAYS AS` overrides any storage method specified using (deprecated) XML Schema annotation `xdb:storeVarrayAsTable`² in the corresponding XML schema.

See Also:

Oracle Database SQL Language Reference for information about using `STORE ALL VARRAYS AS LOBS`

² XML Schema annotation `xdb:storeVarrayAsTable` is *deprecated*, starting with Oracle Database 12c Release 1 (12.1.0.1).

Example 17-8 Creating an Object-Relational XMLType Table with Default Storage

```
CREATE TABLE purchaseorder_as_table OF XMLType
  ELEMENT
    "http://xmlns.oracle.com/xdb/documentation/purchaseOrder.xsd#PurchaseOrder";
```

Example 17-9 Specifying Object-Relational Storage Options for XMLType Tables and Columns

```
CREATE TABLE purchaseorder_as_table
  OF XMLType (UNIQUE ("XMLDATA"."Reference"),
    FOREIGN KEY ("XMLDATA"."User") REFERENCES hr.employees (email))
  ELEMENT
    "http://xmlns.oracle.com/xdb/documentation/purchaseOrder.xsd#PurchaseOrder"
  VARRAY "XMLDATA"."LineItems"."LineItem" STORE AS LOB lineitem_lob
  LOB ("XMLDATA"."Notes")
    STORE AS (TABLESPACE USERS ENABLE STORAGE IN ROW
      STORAGE(INITIAL 4K NEXT 32K))
    COMPRESS FOR OLTP;

CREATE TABLE purchaseorder_as_column (
  id NUMBER,
  xml_document XMLType,
  UNIQUE (xml_document."XMLDATA"."Reference"),
  FOREIGN KEY (xml_document."XMLDATA"."User") REFERENCES hr.employees (email))
  XMLTYPE COLUMN xml_document
  XMLSCHEMA "http://xmlns.oracle.com/xdb/documentation/purchaseOrder.xsd"
  ELEMENT "PurchaseOrder"
  VARRAY xml_document."XMLDATA"."LineItems"."LineItem" STORE AS LOB lineitem_lob
  LOB (xml_document."XMLDATA"."Notes")
    STORE AS (TABLESPACE USERS ENABLE STORAGE IN ROW
      STORAGE(INITIAL 4K NEXT 32K))
    COMPRESS FOR OLTP;
```

Example 17-10 Using STORE ALL VARRAYS AS

```
CREATE TABLE purchaseorder_as_table OF XMLType (UNIQUE ("XMLDATA"."Reference"),
  FOREIGN KEY ("XMLDATA"."User") REFERENCES hr.employees (email))
  ELEMENT
    "http://xmlns.oracle.com/xdb/documentation/purchaseOrder.xsd#PurchaseOrder"
  STORE ALL VARRAYS AS LOBS;
```

17.5 Ways to Identify XML Schema Instance Documents

Before an XML document can be inserted into an XML Schema-based XMLType table or column, the associated XML schema must be identified. You can do this when you create the table or column, or you can use XMLSchema-instance to explicitly add the required schema identification to the XML instance document.

To explicitly identify the XML schema when creating the XMLType table or column, you can pass the name of the XML schema to the XMLType constructor, or you can invoke XMLType method createSchemaBasedXML().

The advantage of the XMLSchema-instance mechanism is that it lets the Oracle XML DB protocol servers recognize that an XML document inserted into Oracle XML DB Repository is an instance of a registered XML schema. The content of the instance document is automatically stored in the default table specified by that XML schema.

The XMLSchema-instance mechanism is defined by the W3C XML Schema working group. It is based on adding attributes that identify the target XML schema to the root

element of the instance document. These attributes are defined by the XMLSchema-instance namespace.

To identify an instance document as a member of the class defined by a particular XML schema you must declare the XMLSchema-instance namespace by adding a namespace declaration to the root element of the instance document. For example:

```
xmlns:xsi = http://www.w3.org/2001/XMLSchema-instance
```

Once the XMLSchema-instance namespace has been declared and given a namespace prefix, attributes that identify the XML schema can be added to the root element of the instance document. In the preceding example, the namespace prefix for the XMLSchema-instance namespace was defined as `xsi`. This prefix can then be used when adding the XMLSchema-instance attributes to the root element of the instance document.

Which attributes must be added depends on several factors. There are two possibilities, `noNamespaceSchemaLocation` and `schemaLocation`. Depending on the XML schema, one or both of these attributes is required to identify the XML schemas that the instance document is associated with.

17.5.1 Attributes `noNamespaceSchemaLocation` and `schemaLocation`

If the target XML schema does not declare a target namespace, attribute `noNamespaceSchemaLocation` is used to identify the XML schema. The attribute value is the *schema location hint*. This is the unique identifier that is passed to PL/SQL procedure `DBMS_XMLSCHEMA.registerSchema` when the XML schema is registered with the database.

For XML schema `purchaseOrder.xsd`, the correct definition of the root element of the instance document would read as follows:

```
<PurchaseOrder
  xmlns:xsi=http://www.w3.org/2001/XMLSchema-instance
  xsi:noNamespaceSchemaLocation=
    "http://localhost:8080/source/schemas/poSource/xsd/purchaseOrder.xsd">
```

If the target XML schema declares a target namespace, then the `schemaLocation` attribute is used to identify the XML schema. The value of this attribute is a pair of values separated by a space:

- The value of the *target namespace* declared in the XML schema
- The *schema location hint*, the unique identifier passed to procedure `DBMS_XMLSCHEMA.registerSchema` when the schema is registered with the database

For example, assume that the `PurchaseOrder` XML schema includes a target namespace declaration. The root element of the schema would look like this:

```
<xs:schema targetNamespace="http://demo.oracle.com/xdb/purchaseOrder"
  xmlns:xs="http://www.w3.org/2001/XMLSchema"
  xmlns:xdb="http://xmlns.oracle.com/xdb"
  version="1.0">
  <xs:element name="PurchaseOrder" type="PurchaseOrderType"
    xdb:defaultTable="PURCHASEORDER"/>
```

In this case, the correct form of the root element of the instance document would read as follows:

```
<PurchaseOrder
  xmlns="http://demo.oracle.com/xdb/purchaseOrder"
  xmlns:xsi="http://www.w3.org/2001/XMLSchema-instance
  xsi:schemaLocation=
    "http://demo.oracle.com/xdb/purchaseOrder
    http://mdrake-lap:8080/source/schemas/poSource/xsd/purchaseOrder.xsd">
```

17.5.2 XML Schema and Multiple Namespaces

When an XML schema includes elements defined in multiple namespaces, an entry must occur in the `schemaLocation` attribute for each of the XML schemas. Each entry consists of the namespace declaration and the *schema location hint*.

The entries are separated from each other by one or more whitespace characters.

If the primary XML schema does not declare a target namespace, then the XML instance document also needs to include a `noNamespaceSchemaLocation` attribute that provides the *schema location hint* for the primary XML schema.

17.6 XML Schema Data Types Are Mapped to Oracle XML DB Storage

Data that conforms to an XML schema uses XML Schema data types. When this XML data is stored in Oracle XML DB, its storage data types are derived from the XML Schema data types using a default mapping and, optionally, using mapping information that you specify using XML schema annotations.

Whenever you do not specify a data type to use for storage, Oracle XML DB uses the default mapping to annotate the XML schema appropriately, during registration. In this way, the registered XML schema has a complete set of data-type annotations.

- For object-relational storage, XML Schema data types are mapped to SQL data types.
- For binary XML storage, XML Schema data types are mapped to Oracle XML DB binary XML encoding types.

See Also:

[Use DBMS_XMLSCHEMA to Map XML Schema Data Types to SQL Data Types](#) (page 18-20)

[Figure 17-7](#) (page 17-27) shows how Oracle XML DB creates XML schema-based `XMLType` tables using an XML document and a mapping specified in an XML schema. Depending on the storage method specified in the XML schema, an XML instance document is stored either as a binary XML value in a single `XMLType` column, or using multiple object-relational columns.

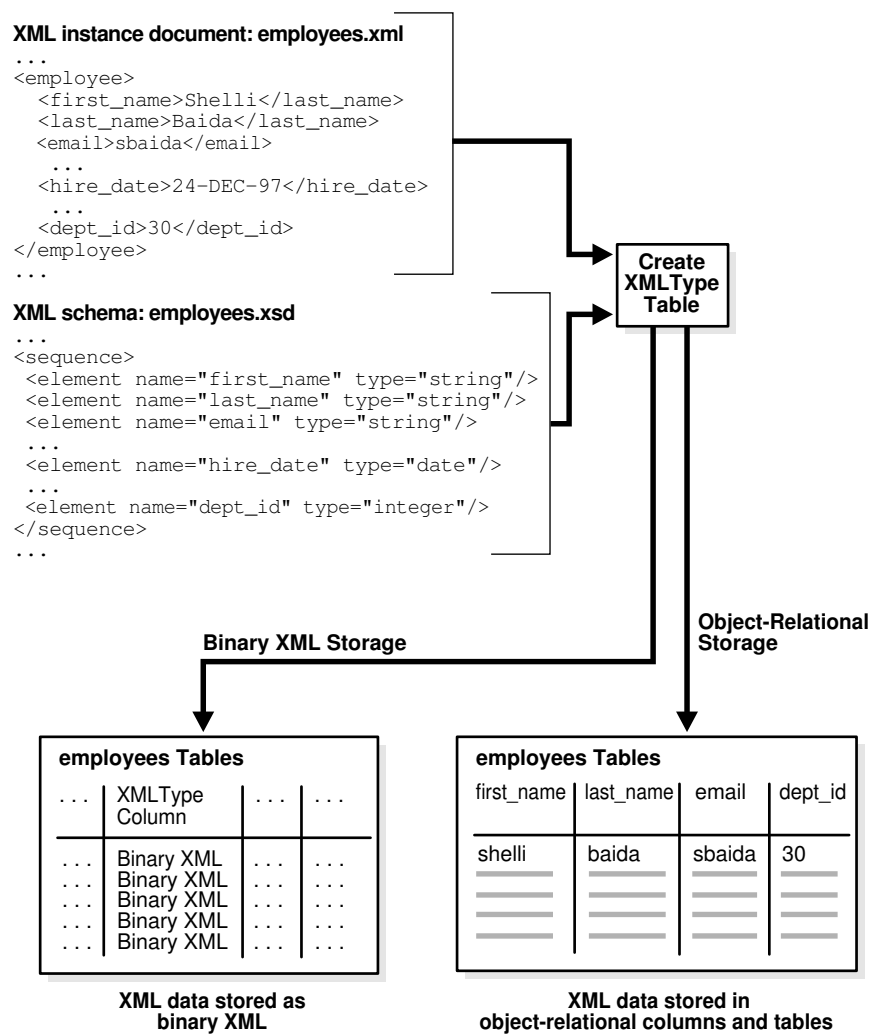
Figure 17-7 How Oracle XML DB Maps XML Schema-Based XMLType Tables

XML Schema Storage and Query: Object-Relational Storage

Advanced techniques for XML Schema-based data include using object-relational storage; annotating XML schemas; mapping Schema data types to SQL; using `complexType` extensions and restrictions; creating, specifying relational constraints on, and partitioning XML Schema-based data, storing `XMLType` data out of line, working with complex or large schemas, and debugging schema registration.

- [Object-Relational Storage of XML Documents](#) (page 18-2)
- [Oracle XML Schema Annotations](#) (page 18-7)
- [Use DBMS_XMLSCHEMA to Map XML Schema Data Types to SQL Data Types](#) (page 18-20)
- [complexType Extensions and Restrictions in Oracle XML DB](#) (page 18-29)
- [Creating XML Schema-Based XMLType Columns and Tables](#) (page 18-32)
- [Overview of Partitioning XMLType Tables and Columns Stored Object-Relationally](#) (page 18-34)
- [Specification of Relational Constraints on XMLType Tables and Columns](#) (page 18-37)
- [Out-Of-Line Storage of XMLType Data](#) (page 18-40)
- [Considerations for Working with Complex or Large XML Schemas](#) (page 18-45)
- [Debugging XML Schema Registration for XML Data Stored Object-Relationally](#) (page 18-59)

See Also:

- [XML Schema Storage and Query: Basic](#) (page 17-1) for basic information about using XML Schema with Oracle XML DB
 - [XPath Rewrite for Object-Relational Storage](#) (page 19-1) for information about the optimization of XPath expressions in Oracle XML DB
 - [XML Schema Evolution](#) (page 20-1) for information about updating an XML schema after you have registered it with Oracle XML DB
 - <http://www.w3.org/TR/xmlschema-0/> for an introduction to XML Schema
-

18.1 Object-Relational Storage of XML Documents

Object-relational storage of XML documents is based on decomposing the document content into a set of SQL objects. These SQL objects are based on the SQL 1999 Type framework. When an XML schema is registered with Oracle XML DB, the required SQL type definitions are automatically generated from the schema.

A SQL type definition is generated from each `complexType` defined by the XML schema. Each element or attribute defined by the `complexType` becomes a SQL attribute in the corresponding SQL type. Oracle XML DB automatically maps the 47 scalar data types defined by the XML Schema Recommendation to the 19 scalar data types supported by SQL. A varray type is generated for each element and this can occur multiple times.

The generated SQL types allow XML content that is compliant with the XML schema to be decomposed and stored in the database as a set of objects, without any loss of information. When an XML document is ingested, the constructs defined by the XML schema are mapped directly to the equivalent SQL types. This lets Oracle XML DB leverage the full power of Oracle Database when managing XML, and it can lead to significant reductions in the amount of space required to store the document. It can also reduce the amount of memory required to query and update XML content.

18.1.1 How Collections Are Stored for Object-Relational XMLType Storage

You can store an ordered collection as a varray in an ordered collection table (OCT), which can be either a heap-based table (recommended) or an index-organized table (IOT). You can store the actual data out of line by using varray entries that are `REFs` to the data.

When you register an XML schema for `XMLType` data that is stored object-rationally and you set registration parameter `GENTABLES` to `TRUE`, default tables are created automatically to store the associated XML instance documents.

Order is preserved among XML collection elements when they are stored. The result is an **ordered collection**.¹ You can store data in an ordered collection in these ways:

- **Varray in a table.** Each element in the collection is mapped to a SQL object. The collection of SQL objects is stored as a set of rows in a table, called an **ordered collection table (OCT)**. By default, all collections are stored in OCTs.

This default behavior corresponds to the XML schema annotation `xdb:storeVarrayAsTable = "true"` (default value).²

- **Varray in a LOB (deprecated).** Each element in the collection is mapped to a SQL object. The entire collection of SQL objects is serialized as a varray and stored in a LOB column. To store a given collection as a varray in a LOB, use XML schema annotation `xdb:storeVarrayAsTable = "false"`.²

You can also use out-of-line storage for an ordered collection. This corresponds to XML schema annotation `SQLInline = "false"`, and it means that a varray of

¹ XML Schema annotation `xdb:maintainOrder` is *deprecated*, starting with Oracle Database 12c Release 1 (12.1.0.1). If you use `xdb:maintainOrder = "false"`, then an unordered collection is used instead of an ordered collection. Oracle recommends that you use ordered collections (`xdb:maintainOrder = "true"`) for XML data, to preserve document order. By default, attribute `xdb:maintainOrder` is `true`.

² XML Schema annotation `xdb:storeVarrayAsTable` is *deprecated*, starting with Oracle Database 12c Release 1 (12.1.0.1).

REFs in the collection table (or the LOB) tracks the collection content, which is stored out of line.

There is no requirement to annotate an XML schema before using it. Oracle XML DB uses a set of default assumptions when processing an XML schema that contains no annotations.

If you do not supply any of the annotations mentioned in this section, then Oracle XML DB stores a collection as a *heap-based* OCT. You can force OCTs to be stored as **index-organized tables (IOTs)** instead, by passing **REGISTER_NT_AS_IOT** in the **OPTIONS** parameter of `DBMS_XMLSCHEMA.registerSchema`.

Note:

In releases prior to Oracle Database 11g Release 1:

- OCTs were stored as IOTs by default.
 - The default value for `xdb:storeVarrayAsTable` was `false`.
-
-

Note:

Use heap-based OCTs, *not* IOTs, unless you are explicitly advised by Oracle to use IOTs. IOT storage has these significant limitations:

- It disables partitioning of the collection tables (IOTs).
 - It supports only document-level Oracle Text indexes. It disables indexes that are element-specific or attribute-specific.
-
-

See Also:

- [Object-Relational Storage of XML Documents](#) (page 18-2) for information about collection storage when you create `XMLType` tables and columns manually using object-relational storage
 - [Setting Annotation Attribute `xdb:SQLInline` to false for Out-Of-Line Storage](#) (page 18-40)
 - [Overview of Partitioning `XMLType` Tables and Columns Stored Object-Relationally](#) (page 18-34)
-
-

18.1.2 SQL Types Created during XML Schema Registration for Object-Relational Storage

Use `TRUE` as the value of parameter `GENTYPES` when you register an XML schema for use with XML data stored object-relationally (`TRUE` is the default value). Oracle XML DB then creates the appropriate SQL object types that enable object-relational storage of conforming XML documents.

By default, all SQL object types are created in the database schema of the user who registers the XML schema. If annotation `xdb:defaultSchema` is used, then Oracle XML DB attempts to create the object type using the specified database schema. The current user must have the necessary privileges to create these object types.

[Example 18-1](#) (page 18-4) shows the SQL object types that are created automatically when XML schema `purchaseOrder.xsd` is registered with Oracle XML DB.

Note:

By default, the names of the SQL object types and attributes are system-generated. This is the case in [Example 18-1](#) (page 18-4). If the XML schema does not contain attribute `SQLName`, then the SQL name is derived from the XML name. You can use XML schema annotations to provide user-defined names (see [Oracle XML Schema Annotations](#) (page 18-7) for details).

Note:

Starting with Oracle Database 12c Release 2 (12.2.0.1), if you register an XML schema for object-relational storage for an *application common user* then you *must* annotate each complex type in the schema with `xdb:SQLType`, to name the SQL data type. Otherwise, an error is raised.

Example 18-1 SQL Object Types for Storing XMLType Tables

```
DESCRIBE "PurchaseOrderType1668_T"

"PurchaseOrderType1668_T" is NOT FINAL
Name                Null?  Type
-----
SYS_XDBPD$          XDB.XDB$RAW_LIST_T
Reference            VARCHAR2(30 CHAR)
Actions              ActionsType1661_T
Reject               RejectionType1660_T
Requestor            VARCHAR2(128 CHAR)
User                 VARCHAR2(10 CHAR)
CostCenter           VARCHAR2(4 CHAR)
ShippingInstructions ShippingInstructionsTyp1659_T
SpecialInstructions  VARCHAR2(2048 CHAR)
LineItems            LineItemsType1666_T
Notes                VARCHAR2(4000 CHAR)

DESCRIBE "LineItemsType1666_T"

"LineItemsType1666_T" is NOT FINAL
Name                Null?  Type
-----
SYS_XDBPD$          XDB.XDB$RAW_LIST_T
LineItem            LineItem1667_COLL

DESCRIBE "LineItem1667_COLL"

"LineItem1667_COLL" VARRAY(2147483647) OF LineItemType1665_T
"LineItemType1665_T" is NOT FINAL
Name                Null?  Type
-----
SYS_XDBPD$          XDB.XDB$RAW_LIST_T
ItemNumber           NUMBER(38)
Description           VARCHAR2(256 CHAR)
Part                 PartType1664_T
```

18.1.3 Default Tables Created during XML Schema Registration

You can create default tables as part of XML schema registration. Default tables are most useful when documents are inserted using APIs and protocols such as FTP and HTTP(S), which do not provide any table specification.

In such cases, the XML instance is inserted into the default table.

[Example 18-2](#) (page 18-5) describes the default purchase-order table.

If you provide a value for attribute `xdb:defaultTable`, then the XMLType table is created with that name. Otherwise it is created with an internally generated name.

Any text specified using attributes `xdb:tableProps` and `xdb:columnProps` is appended to the generated CREATE TABLE statement.

Example 18-2 Default Table for Global Element PurchaseOrder

```
DESCRIBE "PurchaseOrder1669_TAB"

Name                               Null? Type
-----
TABLE of
  SYS.XMLTYPE(
    XMLSchema "http://xmlns.oracle.com/xdb/documentation/purchaseOrder.xsd"
    Element "PurchaseOrder")
  STORAGE OBJECT-RELATIONAL TYPE "PurchaseOrderType1668_T"
```

18.1.4 Do Not Use Internal Constructs Generated during XML Schema Registration

In general, the SQL constructs (data types, nested tables, and tables associated with out-of-line storage) that are automatically generated during XML schema registration are *internal* to Oracle XML DB. Oracle recommends that you do *not* use them in your code.

More precisely, generated SQL data types, nested tables, and tables associated with out-of-line storage are based on specific internal XML schema-to-object type mappings that are subject to change and redefinition by Oracle at any time. In general:

- Do not use any generated SQL data types.
- Do not access or modify any generated nested tables or out-of-line tables.

You can, however, modify the storage options, such as partitioning, of generated tables, and you can create indexes and constraints on generated tables. You can also freely use any XML schema annotations provided by Oracle XML DB, including annotations that name generated constructs.

18.1.5 Generated Names are Case Sensitive

The names of any SQL tables, objects, and attributes generated by XML schema registration are *case sensitive*.

For instance, in [Example 18-2](#) (page 18-5), the name of table `PurchaseOrder1669_TAB` is derived from the name of element `PurchaseOrder`, so it too is mixed case. You must therefore refer to this table using a quoted identifier: `"PurchaseOrder1669_TAB"`. Failure to do so results in an object-not-found error, such as `ORA-00942: table or view does not exist`.

18.1.6 SYS_XDBPD\$ and DOM Fidelity for Object-Relational Storage

In order to provide DOM fidelity for XML data that is stored object-relationally, Oracle XML DB records all information that cannot be stored in any of the other object attributes as instance-level metadata using the system-defined binary object attribute `SYS_XDBPD$` (positional descriptor, or PD).

With object-relational storage of XML data, the elements and attributes declared in an XML schema are mapped to separate attributes of the corresponding SQL object types. However, the following information in XML instance documents is not stored in these object attributes:

- Namespace declarations
- Comments
- Prefix information

In order to provide DOM fidelity for XML data stored object-relationally, Oracle XML DB uses a separate mechanism to keep track of this information: it is recorded as instance-level metadata.

This metadata is tracked at the type level using the system-defined binary object attribute `SYS_XDBPD$`. This object attribute is referred to as the **positional descriptor**, or **PD** for short.

The PD is intended for Oracle XML DB *internal use only*. You should never directly access or manipulate column PD.

The positional descriptor stores all information that cannot be stored in any of the other object attributes. PD information is used to ensure the DOM fidelity of all XML documents stored in Oracle XML DB. Examples of PD information include: ordering information, comments, processing instructions, and namespace prefixes.

If DOM fidelity is not required, you can suppress the use of `SYS_XDBPD$` by setting attribute `xdb:maintainDOM` to `false` in the XML schema, at the type level.

Note:

For clarity, object attribute `SYS_XDBPD$` is omitted in many examples in this book. However, it is always present as a positional descriptor (PD) column in all SQL object types that are generated by the XML schema registration process.

In general, Oracle recommends that you do not suppress the PD attribute, because the extra information, such as comments and processing instructions, could be lost if there is no PD column.

See Also:

- [You Can Override the SQLType Value in an XML Schema When Declaring Attributes](#) (page 18-22)
 - [Override of the SQLType Value in an XML Schema When Declaring Elements](#) (page 18-23)
 - [DOM Fidelity](#) (page 17-6) for information about DOM fidelity and binary XML storage of XML data
-

18.2 Oracle XML Schema Annotations

You can annotate XML schemas to influence the objects and tables that are generated by the XML schema registration process. You do this by adding Oracle-specific attributes to `complexType`, `element`, and `attribute` definitions that are declared by the XML schema.

You can add such annotations manually by editing the XML schema document or, for the most common annotations, by invoking annotation-specific PL/SQL subprograms. See *Oracle Database PL/SQL Packages and Types Reference*, chapter "DBMS_XMLSCHEMA_ANNOTATE".

If you edit an XML schema manually using the Altova XMLSpy editor then you can take advantage of the *Oracle* tab in the editor for adding and editing Oracle-specific annotations. See [Figure 17-2](#) (page 17-6).

Most XML attributes used by Oracle XML DB belong to the namespace `http://xmlns.oracle.com/xdb`. XML attributes used for encoding XML data as binary XML belong to the namespace `http://xmlns.oracle.com/2004/CSX`. To simplify the process of annotating an XML schema, Oracle recommends that you declare namespace prefixes in the root element of the XML schema.

18.2.1 Common Uses of XML Schema Annotations

You can annotate an XML schema to customize the names of object-relational tables, objects, and object attributes or to allow XPath rewrite when XQuery-expression arguments target recursive XML data.

Common reasons for wanting to annotate an XML schema include the following:

- To ensure that the names of the tables, objects, and object attributes created by PL/SQL procedure `DBMS_XMLSCHEMA.registerSchema` for object-relational storage of XMLType data are easy to recognize and compliant with any application-naming standards. Set parameter `GENTYPES` or `GENTABLES` to `TRUE` for this (`TRUE` is the default value for each of these parameters).
- To prevent the generation of mixed-case names that require the use of quoted identifiers when working directly with SQL.
- To allow XPath rewrite for object-relational storage in the case of document-correlated recursive XPath queries. This applies to certain applications of SQL/XML access and query functions whose XQuery-expression argument targets recursive XML data.

The most commonly used XML schema annotations are the following:

- `xdb:defaultTable` – Name of the default table generated for each global element when parameter `GENTABLES` is `TRUE`. Setting this to the empty string, "", prevents a default table from being generated for the element in question.
- `xdb:SQLName` – Name of the SQL object attribute that corresponds to each element or attribute defined in the XML schema.
- `xdb:SQLType` – For `complexType` definitions, the corresponding object type. For `simpleType` definitions, `SQLType` is used to override the default mapping between XML schema data types and SQL data types. A common use of `SQLType` is to define when unbounded strings should be stored as `CLOB` values, rather than as `VARCHAR(4000) CHAR` values (the default). Note: You cannot use data type `NCHAR`, `NVARCHAR2`, or `NCLOB` as the value of a `SQLType` annotation.

Note:

Starting with Oracle Database 12c Release 2 (12.2.0.1), if you register an XML schema for object-relational storage for an *application common user* then you *must* annotate each complex type in the schema with `xdb:SQLType`, to name the SQL data type. Otherwise, an error is raised.

- `xdb:SQLCollType` – Used to specify the varray type that manages a collection of elements.
- `xdb:maintainDOM` – Used to determine whether or not DOM fidelity should be maintained for a given `complexType` definition

You need not specify values for any of these attributes. Oracle XML DB provides appropriate values by default during the XML schema registration process. However, if you are using object-relational storage, then Oracle recommends that you specify the names of at least the top-level SQL types, so that you can reference them later.

18.2.2 XML Schema Annotation Example

A sample XML schema illustrates some of the most important Oracle XML DB annotations.

The XML schema in [Example 18-3](#) (page 18-9) is similar to the one in [Example A-2](#) (page A-34), but it also defines a `Notes` element and its type, `NotesType`.

- The schema element includes the declaration of the `xdb` namespace.
- The definition of global element `PurchaseOrder` includes a `defaultTable` annotation that specifies that the name of the default table associated with this element is `purchaseorder`.
- The definition of global complex type `PurchaseOrderType` includes a `SQLType` annotation that specifies that the generated SQL object type is named `purchaseorder_t`. Within the definition of this type, the following annotations are used:
 - The definition of element `Reference` includes a `SQLName` annotation that specifies that the SQL attribute corresponding to XML element `Reference` is named `reference`.

- The definition of element `Actions` includes a `SQLName` annotation that specifies that the SQL attribute corresponding to XML element `Actions` is named `action_collection`.
- The definition of element `USER` includes a `SQLName` annotation that specifies that the SQL attribute corresponding to XML element `User` is named `email`.
- The definition of element `LineItems` includes a `SQLName` annotation that specifies that the SQL attribute corresponding to XML element `LineItems` is named `lineitem_collection`.
- The definition of element `Notes` includes a `SQLType` annotation that specifies that the data type of the SQL attribute corresponding to XML element `Notes` is `CLOB`.
- The definition of global complex type `LineItemsType` includes a `SQLType` annotation that specifies that the generated SQL object type is named `lineitems_t`. Within the definition of this type, the following annotation is used:
 - The definition of element `LineItem` includes a `SQLName` annotation that specifies that the data type of the SQL attribute corresponding to XML element `LineItems` is named `lineitem_varray`, and a `SQLCollName` annotation that specifies that the SQL object type that manages the collection is named `lineitem_v`.
- The definition of global complex type `LineItemType` includes a `SQLType` annotation that specifies that generated SQL object type is named `lineitem_t`.
- The definition of complex type `PartType` includes a `SQLType` annotation that specifies that the SQL object type is named `part_t`. It also includes the annotation `xdb:maintainDOM = "false"`, specifying that there is no need for Oracle XML DB to maintain DOM fidelity for elements based on this data type.

[Example 18-4](#) (page 18-10) shows some of the tables and objects that are created when the annotated XML schema of [Example 18-3](#) (page 18-9) is registered.

The following are results of this XML schema registration:

- A table called `purchaseorder` was created.
- Types called `purchaseorder_t`, `lineitems_t`, `lineitem_v`, `lineitem_t`, and `part_t` were created. The attributes defined by these types are named according to supplied the `SQLName` annotations.
- The `Notes` attribute defined by `purchaseorder_t` is of data type `CLOB`.
- Type `part_t` does not include a positional descriptor (PD) attribute.
- Ordered collection tables (OCTs) were created to manage the collections of `LineItem` and `Action` elements.

Example 18-3 Using Common Schema Annotations

```
<xs:schema
  targetNamespace="http://xmlns.oracle.com/xdb/documentation/purchaseOrder"
  xmlns:xs="http://www.w3.org/2001/XMLSchema"
  xmlns:xdb="http://xmlns.oracle.com/xdb"
  xmlns:po="http://xmlns.oracle.com/xdb/documentation/purchaseOrder"
  version="1.0">
  <xs:element name="PurchaseOrder" type="po:PurchaseOrderType"
    xdb:defaultTable="PURCHASEORDER"/>
```

```

<xs:complexType name="PurchaseOrderType" xdb:SQLType="PURCHASEORDER_T">
  <xs:sequence>
    <xs:element name="Reference" type="po:ReferenceType" minOccurs="1"
      xdb:SQLName="REFERENCE"/>
    <xs:element name="Actions" type="po:ActionsType"
      xdb:SQLName="ACTION_COLLECTION"/>
    <xs:element name="Reject" type="po:RejectionType" minOccurs="0"/>
    <xs:element name="Requestor" type="po:RequestorType"/>
    <xs:element name="User" type="po:UserType" minOccurs="1"
      xdb:SQLName="EMAIL"/>
    <xs:element name="CostCenter" type="po:CostCenterType"/>
    <xs:element name="ShippingInstructions"
      type="po:ShippingInstructionsType"/>
    <xs:element name="SpecialInstructions" type="po:SpecialInstructionsType"/>
    <xs:element name="LineItems" type="po:LineItemsType"
      xdb:SQLName="LINEITEM_COLLECTION"/>
    <xs:element name="Notes" type="po:NotesType" xdb:SQLType="CLOB"/>
  </xs:sequence>
</xs:complexType>
<xs:complexType name="LineItemsType" xdb:SQLType="LINEITEMS_T">
  <xs:sequence>
    <xs:element name="LineItem" type="po:LineItemType" maxOccurs="unbounded"
      xdb:SQLCollType="LINEITEM_V" xdb:SQLName="LINEITEM_VARRAY"/>
  </xs:sequence>
</xs:complexType>
<xs:complexType name="LineItemType" xdb:SQLType="LINEITEM_T">
  <xs:sequence>
    <xs:element name="Description" type="po:DescriptionType"/>
    <xs:element name="Part" type="po:PartType"/>
  </xs:sequence>
  <xs:attribute name="ItemNumber" type="xs:integer"/>
</xs:complexType>
<xs:complexType name="PartType" xdb:SQLType="PART_T" xdb:maintainDOM="false">
  <xs:attribute name="Id">
    <xs:simpleType>
      <xs:restriction base="xs:string">
        <xs:minLength value="10"/>
        <xs:maxLength value="14"/>
      </xs:restriction>
    </xs:simpleType>
  </xs:attribute>
  <xs:attribute name="Quantity" type="po:moneyType"/>
  <xs:attribute name="UnitPrice" type="po:quantityType"/>
</xs:complexType>
<xs:simpleType name="NotesType">
  <xs:restriction base="xs:string">
    <xs:minLength value="1"/>
    <xs:maxLength value="32767"/>
  </xs:restriction>
</xs:simpleType>
</xs:schema>

```

Example 18-4 Registering an Annotated XML Schema

```

BEGIN
  DBMS_XMLSCHEMA.registerSchema(
    SCHEMAURL => 'http://xmlns.oracle.com/xdb/documentation/purchaseOrder.xsd',
    SCHEMADOC => bfilename('XMLDIR', 'purchaseOrder.Annotated.xsd'),
    LOCAL    => TRUE,
    GENTYPES => TRUE,
    GENTABLES => TRUE,

```



```

        CSID      => nls_charset_id('AL32UTF8');
END;
/

SELECT table_name, xmlschema, element_name FROM USER_XML_TABLES;

TABLE_NAME      XMLSCHEMA
-----
PURCHASEORDER   http://xmlns.oracle.com/xdb/documen
                 tation/purchaseOrder.xsd
                 ELEMENT_NAME
                 PurchaseOrder

1 row selected.

DESCRIBE purchaseorder

Name                                     Null? Type
-----
TABLE of SYS.XMLTYPE(XMLSchema
"http://xmlns.oracle.com/xdb/documentation/purchaseOrder.xsd"
ELEMENT "PurchaseOrder") STORAGE Object-relational TYPE "PURCHASEORDER_T"

DESCRIBE purchaseorder_t

PURCHASEORDER_T is NOT FINAL
Name                                     Null? Type
-----
SYS_XDBPD$                               XDB.XDB$RAW_LIST_T
REFERENCE                                 VARCHAR2(30 CHAR)
ACTION_COLLECTION                         ACTIONS_T
REJECT                                    REJECTION_T
REQUESTOR                                 VARCHAR2(128 CHAR)
EMAIL                                      VARCHAR2(10 CHAR)
COSTCENTER                                VARCHAR2(4 CHAR)
SHIPPINGINSTRUCTIONS                     SHIPPING_INSTRUCTIONS_T
SPECIALINSTRUCTIONS                       VARCHAR2(2048 CHAR)
LINEITEM_COLLECTION                       LINEITEMS_T
Notes                                      CLOB

DESCRIBE lineitems_t

LINEITEMS_T is NOT FINAL
Name                                     Null? Type
-----
SYS_XDBPD$                               XDB.XDB$RAW_LIST_T
LINEITEM_VARRAY                           LINEITEM_V

DESCRIBE lineitem_v

LINEITEM_V VARRAY(2147483647) OF LINEITEM_T
LINEITEM_T is NOT FINAL
Name                                     Null? Type
-----
SYS_XDBPD$                               XDB.XDB$RAW_LIST_T
ITEMNUMBER                                 NUMBER(38)
DESCRIPTION                                 VARCHAR2(256 CHAR)
PART                                        PART_T

DESCRIBE part_t

PART_T is NOT FINAL
Name                                     Null? Type
-----

```

```

ID                                VARCHAR2(14 CHAR)
QUANTITY                          NUMBER(12,2)
UNITPRICE                         NUMBER(8,4)

SELECT table_name, parent_table_column FROM USER_NESTED_TABLES
       WHERE parent_table_name = 'purchaseorder';

TABLE_NAME                        PARENT_TABLE_COLUMN
-----
SYS_NTNOHV+tfSTRaDTA9FETvBJw==  "XMLDATA"."LINEITEM_COLLECTION"."LINEITEM_VARRAY"
SYS_NTV4bNVqQ1S4WdCIvBK5qjZA==  "XMLDATA"."ACTION_COLLECTION"."ACTION_VARRAY"

2 rows selected.

```

18.2.3 Annotating an XML Schema Using DBMS_XMLSCHEMA_ANNOTATE

PL/SQL package `DBMS_XMLSCHEMA_ANNOTATE` provides subprograms to annotate an XML schema. Using these subprograms can often be more convenient and less error prone than manually editing the XML schema.

In particular, you can use the PL/SQL subprograms in a script, which you can run at any time or multiple times, as needed. This can be especially useful if you are using a large XML schema or a standard or other third-party XML schema that you do not want to modify manually.

There are specific PL/SQL subprograms for each Oracle annotation. For example, you use PL/SQL procedure `setDefaultTable` to add a `xdb:defaultTable` annotation, and `removeDefaultTable` to remove a `xdb:defaultTable` annotation.

Each annotation subprogram has the following as its parameters:

- The XML schema to be annotated. This parameter is IN OUT.
- The name of the global element where the annotation is to be added or removed.
- The annotation (XML attribute) value.
- A Boolean flag indicating whether any corresponding existing annotation is to be overwritten. By default, it is overwritten.

If the element to be annotated is not a global element then you provide the local element name as an additional parameter. The global and local names together identify the target element. The element with the local name must be a descendent of the element with the global name.

If you use SQL*Plus, you can use PL/SQL procedure `DBMS_XMLSCHEMA_ANNOTATE.printWarnings` to enable and disable printing of SQL*Plus warnings during the use of other `DBMS_XMLSCHEMA_ANNOTATE` subprograms. By default, no warnings are printed. An example of a warning is an inability to annotate the XML schema because there is no element with the name you provided to the annotation subprogram.

[Example 18-5](#) (page 18-13) uses subprograms in PL/SQL package `DBMS_XMLSCHEMA_ANNOTATE` to produce the annotated XML schema shown in [Example 18-3](#) (page 18-9).

See Also:

Oracle Database PL/SQL Packages and Types Reference, chapter
"DBMS_XMLSCHEMA_ANNOTATE"

Example 18-5 Using DBMS_XMLSCHEMA_ANNOTATE

```

CREATE TABLE annotation_tab (id NUMBER, inp XMLType, out XMLType);
INSERT INTO annotation_tab VALUES (1, ... unannotated XML schema...);

DECLARE
    schema XMLType;
BEGIN
    SELECT t.inp INTO schema FROM annotation_tab t WHERE t.id = 1;

    DBMS_XMLSCHEMA_ANNOTATE.setDefaultTable(schema, 'PurchaseOrder', 'PURCHASEORDER');
    DBMS_XMLSCHEMA_ANNOTATE.setSQLType(schema, 'PurchaseOrderType', 'PURCHASEORDER_T');
    DBMS_XMLSCHEMA_ANNOTATE.setSQLName(schema, 'complexType', 'PurchaseOrderType', 'element', 'Reference',
        'REFERENCE');
    DBMS_XMLSCHEMA_ANNOTATE.setSQLName(schema, 'complexType', 'PurchaseOrderType', 'element', 'Actions',
        'ACTIONS_COLLECTION');
    DBMS_XMLSCHEMA_ANNOTATE.setSQLName(schema, 'complexType', 'PurchaseOrderType', 'element', 'User', 'EMAIL');
    DBMS_XMLSCHEMA_ANNOTATE.setSQLName(schema, 'complexType', 'PurchaseOrderType', 'element', 'LineItems',
        'LINEITEM_COLLECTION');
    DBMS_XMLSCHEMA_ANNOTATE.setSQLType(schema, 'complexType', 'PurchaseOrderType', 'element', 'Notes', 'CLOB');
    DBMS_XMLSCHEMA_ANNOTATE.setSQLType(schema, 'LineItemsType', 'LINEITEMS_T');
    DBMS_XMLSCHEMA_ANNOTATE.setSQLCollType(schema, 'complexType', 'LineItemsType', 'LineItem', 'LINEITEM_V');
    DBMS_XMLSCHEMA_ANNOTATE.setSQLName(schema, 'complexType', 'LineItemsType', 'element', 'LineItem',
        'LINEITEM_VARRAY');
    DBMS_XMLSCHEMA_ANNOTATE.setSQLType(schema, 'LineItemType', 'LINEITEM_T');
    DBMS_XMLSCHEMA_ANNOTATE.setSQLType(schema, 'PartType', 'PART_T');
    DBMS_XMLSCHEMA_ANNOTATE.disableMaintainDom(schema, 'PartType');

    UPDATE annotation_tab t SET t.out = schema WHERE t.id = 1;
END;
/

```

18.2.4 Available Oracle XML DB XML Schema Annotations

The Oracle XML DB annotations that you can specify in element and attribute declarations are described, along with the PL/SQL subprograms in package DBMS_XMLSCHEMA_ANNOTATE that you can use to manipulate them.

All annotations except those that have the prefix `csx` are applicable to XML schemas registered for object-relational storage.

The following annotations apply to XML schemas that are registered for binary XML storage:

- `xdb:defaultTable`
- `xdb:defaultTableSchema` (deprecated)
- `xdb:tableProps`

See Also:

Oracle Database PL/SQL Packages and Types Reference, chapter
"DBMS_XMLSCHEMA_ANNOTATE"

Table 18-1 Annotations in Elements

Attribute and PL/SQL	Values	Default	Description
xdb:columnProps No applicable PL/SQL.	Any column storage clause	NULL	Specifies the COLUMN storage clause that is inserted into the default CREATE TABLE statement. It is useful mainly for elements that get mapped to SQL tables, namely top-level element declarations and out-of-line element declarations.
xdb:defaultTable PL/SQL: setDefaultTable removeDefaultTable enableDefaultTableCreation disableDefaultTableCreation	Any table name	Based on element name	Specifies the name of the SQL table into which XML instances of this XML schema are stored. This is most useful in cases where the XML data is inserted from APIs and protocols, such as FTP and HTTP(S), where the table name is not specified. Applicable to object-relational storage and binary XML storage.
xdb:defaultTableSchema ¹ <i>Deprecated.</i> No applicable PL/SQL.	Any SQL user name	User registering XML schema	Name of the database user (database schema) who owns the type specified by xdb:defaultTable. Applicable to object-relational storage and binary XML storage.
xdb:maintainDOM PL/SQL: enableMaintainDOM disableMaintainDOM	true false	true	If true, then instances of this element are stored so that they retain DOM fidelity on output. This implies that all comments, processing instructions, namespace declarations, and so on are retained, in addition to the ordering of elements. If false, then the output is not guaranteed to have the same DOM action as the input.
xdb:maintainOrder ¹ <i>Deprecated.</i> No applicable PL/SQL.	true false	true	If true (generally recommended, and the default value), then the collection is mapped to a varray (stored in a LOB or an ordered collection table). If false, then the collection is mapped to an unordered table, and document order is <i>not</i> preserved.
xdb:SQLCollSchema ¹ <i>Deprecated.</i> No applicable PL/SQL.	Any SQL user name	User registering XML schema	Name of the database user (database schema) who owns the type specified by xdb:SQLCollType.
xdb:SQLCollType PL/SQL: setSQLCollType removeSQLCollType	Any SQL collection type	Name generated from element name	Name of the SQL collection type that corresponds to this XML element. The XML element must be specified with maxOccurs > 1.

Table 18-1 (Cont.) Annotations in Elements

Attribute and PL/SQL	Values	Default	Description
xdb:SQLInline PL/SQL: setOutOfLine removeOutOfLine	true false	true	If <code>true</code> , then this element is stored inline as an embedded object attribute (or as a collection, if <code>maxOccurs > 1</code>). If <code>false</code> , then a <code>REF</code> value is stored (or a collection of <code>REF</code> values, if <code>maxOccurs > 1</code>). This attribute is forced to <code>false</code> in certain situations, such as cyclic references, where SQL does not support inlining.
xdb:SQLName PL/SQL: setSQLName removeSQLName	Any SQL identifier	Element name	Name of the attribute within the SQL object that maps to this XML element.
xdb:SQLSchema ¹ <i>Deprecated.</i> No applicable PL/ SQL.	Any SQL user name	User registering XML schema	Name of the database user (database schema) who owns the type specified by <code>SQLType</code> .
xdb:SQLType PL/SQL: setSQLType removeSQLType	Any SQL data type ² , <i>except</i> NCHAR, NVARCHA R2, and NCLOB	Name generated from element name	Name of the SQL type corresponding to this XML element declaration.
xdb:tableProps PL/SQL: setTableProps removeTableProps	Any table storage clause	NULL	Specifies the <code>TABLE</code> storage clause that is appended to the default <code>CREATE TABLE</code> statement. This is meaningful mainly for global and out-of-line elements. Applicable to object-relational storage and binary XML storage.

¹ XML Schema annotations `xdb:defaultTableSchema`, `xdb:maintainOrder`, `xdb:SQLCollSchema`, and `xdb:SQLSchema` are *deprecated*, starting with Oracle Database Release 12c (12.1.0.1).

² See [Use DBMS_XMLSCHEMA to Map XML Schema Data Types to SQL Data Types](#) (page 18-20).

See Also:

[Object-Relational Storage of XML Schema-Based Data](#) (page 17-22) for information about specifying storage options when manually creating `XMLType` tables for object-relational storage

Table 18-2 Annotations in Elements Declaring Global complexType Elements

Attribute	Values	Default	Description
xdb:maintainDOM PL/SQL: enableMaintainDom disableMaintainDom	true false	true	If true, then instances of this element are stored so that they retain DOM fidelity on output. This implies that all comments, processing instructions, namespace declarations, and so on are retained, in addition to the ordering of elements. If false, then the output is not guaranteed to have the same DOM action as the input.
xdb:SQLSchema ¹ <i>Deprecated.</i> No applicable PL/SQL.	Any SQL user name	User registering XML schema	Name of the database user (database schema) who owns the type specified by SQLType.
xdb:SQLType PL/SQL: setSQLType removeSQLType	Any SQL data type ² <i>except</i> NCHAR, NVARCHAR2, and NCLOB	Name generated from element name	Name of the SQL type that corresponds to this XML element declaration.

¹ XML Schema annotation `xdb:SQLSchema` is *deprecated*, starting with Oracle Database Release 12c (12.1.0.1).

² See [Use DBMS_XMLSCHEMA to Map XML Schema Data Types to SQL Data Types](#) (page 18-20).

Table 18-3 Annotations in XML Schema Declarations

Attribute	Values	Default	Description
xdb:mapUnboundedStringToLob ¹ No applicable PL/SQL.	true false	false	If true, then unbounded strings are mapped to CLOB instances by default. Similarly, unbounded binary data gets mapped to a BLOB value, by default. If false, then unbounded strings are mapped to VARCHAR2(4000) values, and unbounded binary components are mapped to RAW(2000) values.
xdb:storeVarrayAsTable ¹ <i>Deprecated.</i> No applicable PL/SQL.	true false	true	If true, then the varray is stored as a table (OCT). The default value is true. If false, then the varray is stored in a LOB.

¹ XML Schema annotations `xdb:mapUnboundedStringToLob` and `xdb:storeVarrayAsTable` are *deprecated*, starting with Oracle Database 12c Release 1 (12.1.0.1).

18.2.5 XML Schema Annotation Guidelines for Object-Relational Storage

For XMLType data stored object-relationally, careful planning is called for, to optimize performance. Similar considerations are in order as for relational data: entity-relationship models, indexing, data types, table partitions, and so on. To enable XPath

rewrite and achieve optimal performance, you implement many such design choices using XML schema annotations.

See Also:

- [Table 18-1](#) (page 18-14)
 - [XPath Rewrite for Object-Relational Storage](#) (page 19-1)
-
-

18.2.5.1 Avoid Creation of Unnecessary Tables for Unused Top-Level Elements

Whenever a top-level element in an XML schema is *never* used at the top level in any corresponding XML instance, you can avoid the creation of associated tables by adding annotation `xdb:defaultTable = ""` to the element in the XML schema. An empty value for this attribute prevents default-table creation.

By default, XML schema registration creates a top-level table for each top-level element defined in the schema. Some such elements might be used at top level in XML instances that conform to the schema. For example, elements in an XML schema might be top-level in order to be used as a REF target.

You can use PL/SQL procedure

```
DBMS_XMLSCHEMA_ANNOTATE.disableDefaultTableCreation
```

 to add an empty `xdb:defaultTable` attribute to each top-level element that has no `xdb:defaultTable` attribute.

Note:

Any top-level XML schema element that is used as the root element of any instance documents must have a non-empty `xdb:defaultTable` attribute.

See Also:

Oracle Database PL/SQL Packages and Types Reference, chapter "DBMS_XMLSCHEMA_ANNOTATE" for information about PL/SQL procedure `disableDefaultTableCreation`.

18.2.5.2 Provide Your Own Names for Default Tables

For tuning purposes, you examine execution plan output for your queries. This refers to the tables that underlie `XMLType` data stored object-relationally. By default, these tables have system-generated names. Oracle recommends that you provide your own table names instead, especially for tables that you are sure to be interested in.

You do that using annotation `xdb:defaultTable`.

See Also:

[Default Tables Created during XML Schema Registration](#) (page 18-5)

18.2.5.3 Turn Off DOM Fidelity If Not Needed

By default, XML schema registration generates tables that maintain DOM fidelity. It is often the case that for data-centric XML data DOM fidelity is not needed. You can improve the performance of storage, queries, and data modification by instead using object-relational tables that do not maintain DOM fidelity.

You use the annotation `xdb:maintainDOM = "false"` to do that.

See Also:

[DOM Fidelity](#) (page 17-6)

18.2.5.4 Annotate Time-Related Elements with a Timestamp Data Type

If your application needs to work with time-zone indicators, then annotate any XML schema elements of type `xs:time` and `xs:dateTime` with `xdb:SQLType = "TIMESTAMP WITH TIME ZONE"`. This ensures that values containing time-zone indicators can be stored, retrieved, and compared.

18.2.5.5 Add Table and Column Properties

If a table or column underlying object-relational `XMLType` data needs additional properties specified, such as partition, tablespace, or compression, use annotation `xdb:tableProps` or `xdb:columnProps`. You can do this to add primary keys or constraints, for example.

For example, to achieve table compression for online transaction processing (OLTP), you would add `COMPRESS FOR OLTP` using a `tableProps` attribute.

See Also:

[Example 17-9](#) (page 17-24) for an example of specifying Advanced Row Compression when creating `XMLType` tables and columns manually

18.2.5.6 Store Large Collections Out of Line

If you have large collections then you might need to use annotations `xdb:defaultTable` and `xdb:SQLInline` to specify that collection elements be stored out of line.

The maximum number of elements and attributes defined by a `complexType` is 1000. It is not possible to create a single table that can manage the SQL objects that are generated when an instance of that type is stored. If you have large collections, then you might run up against this limit of 1000 columns for a table.

You can use annotations `xdb:defaultTable` and `xdb:SQLInline` to specify that such collection elements be stored out of line. That means that their data is stored in a separate table — only a reference to a row in that table is stored in the main collection table. Use `xdb:defaultTable` to name the out-of-line table. Annotate each element of a potentially large collection with `xdb:SQLInline = "false"`, to store it out of line.

Note:

For each inheritance hierarchy or substitution group in an XML schema, a table is created whose columns cover the content models of that hierarchy or substitution group. This too can cause the 1000-column limit to be reached.

See Also:

- [ORA-01792 and ORA-04031: Issues with Large XML Schemas](#) (page 18-56)
- [Setting Annotation Attribute xdb:SQLInline to false for Out-Of-Line Storage](#) (page 18-40)

18.2.6 Querying a Registered XML Schema to Obtain Annotations

You can query database views `USER_XML_SCHEMAS` and `ALL_XML_SCHEMAS` to obtain a registered XML schema with all of its annotations. The registered version of an XML schema contains a full set of Oracle XML DB annotations. These annotations were supplied by a user or set by default during XML schema registration.

[Example 18-6](#) (page 18-19) illustrates this. It returns the XML schema as an `XMLType` instance.

As shown in [Example 17-3](#) (page 17-13) and [Example 17-4](#) (page 17-14), the location of the registered XML schema depends on whether it is local or global. If you want to project specific annotation information to relational columns, you can query `RESOURCE_VIEW`. [Example 18-7](#) (page 18-19) illustrates this. It obtains the set of global `complexType` definitions declared by an XML schema for object-relational storage of `XMLType` data, and the corresponding SQL object types and DOM fidelity values.

Example 18-6 Querying View `USER_XML_SCHEMAS` for a Registered XML Schema

```
SELECT SCHEMA FROM USER_XML_SCHEMAS
WHERE SCHEMA_URL = 'http://xmlns.oracle.com/xdp/documentation/purchaseOrder.xsd';
```

Example 18-7 Querying Metadata from a Registered XML Schema

```
SELECT ct.xmlschema_type_name, ct.sql_type_name, ct.dom_fidelity
FROM RESOURCE_VIEW,
XMLTable(
XMLNAMESPACES (
'http://xmlns.oracle.com/xdp/XDBResource.xsd' AS "r",
'http://xmlns.oracle.com/xdp/documentation/purchaseOrder' AS "po",
'http://www.w3.org/2001/XMLSchema' AS "xs",
'http://xmlns.oracle.com/xdp' AS "xdb"),
'/r:Resource/r:Contents/xs:schema/xs:complexType' PASSING RES
COLUMNS
xmlschema_type_name VARCHAR2(30) PATH '@name',
sql_type_name        VARCHAR2(30) PATH '@xdb:SQLType',
dom_fidelity         VARCHAR2(6)  PATH '@xdb:maintainDOM') ct
WHERE
equals_path(
RES,
'/sys/schemas/SCOTT/xmlns.oracle.com/xdp/documentation/purchaseOrder.xsd')
=1;
```

XMLSCHEMA_TYPE_NAME	SQL_TYPE_NAME	DOM_FIDELITY
---------------------	---------------	--------------

PurchaseOrderType	PURCHASEORDER_T	true
LineItemsType	LINEITEMS_T	true
LineItemType	LINEITEM_T	true
PartType	PART_T	true
ActionTypes	ACTIONS_T	true
RejectionType	REJECTION_T	true
ShippingInstructionsType	SHIPPING_INSTRUCTIONS_T	true

7 rows selected.

18.2.6.1 You Can Apply Annotations from One XML Schema to Another

Sometimes you need to apply the annotations from one XML schema to another XML schema. A typical use case is applying the annotations from an older version of a schema to a new version. You can get and set annotations using PL/SQL subprograms `getSchemaAnnotations` and `setSchemaAnnotations`, respectively.

PL/SQL function `getSchemaAnnotations` returns all of the annotations from an XML schema. PL/SQL procedure `setSchemaAnnotations` sets annotations. These subprograms are in PL/SQL package `DBMS_XMLSCHEMA_ANNOTATE`.

See Also:

Oracle Database PL/SQL Packages and Types Reference, chapter "DBMS_XMLSCHEMA_ANNOTATE" for information about PL/SQL subprograms `getSchemaAnnotations` and `setSchemaAnnotations`.

18.3 Use DBMS_XMLSCHEMA to Map XML Schema Data Types to SQL Data Types

You use PL/SQL package `DBMS_XMLSCHEMA` to map data types for XML Schema attributes and elements to SQL data types.

Note:

Do *not* directly access the SQL data types that are mapped from XML Schema data types during XML schema registration. These SQL types are part of the implementation of Oracle XML DB. They are not exposed for your use. Oracle reserves the right to change the implementation at any time, including in a product patch. Such a change by Oracle will have no effect on applications that abide by the XML abstraction, but it might impact applications that directly access these data types.

18.3.1 Example of Mapping XML Schema Data Types to SQL

An example illustrates mapping XML Schema data types to SQL data types.

[Example 18-8](#) (page 18-20) uses attribute `SQLType` to specify the data-type mapping. It also uses attribute `SQLName` to specify the object attributes to use for various XML elements and attributes.

Example 18-8 Mapping XML Schema Data Types to SQL Data Types Using Attribute `SQLType`

```
<xs:schema xmlns:xs="http://www.w3.org/2001/XMLSchema"
  xmlns:xdb="http://xmlns.oracle.com/xdb"
  version="1.0">
```

```

<xs:element name="PurchaseOrder" type="PurchaseOrderType" xdb:defaultTable="PURCHASEORDER" />
<xs:complexType name="PurchaseOrderType" xdb:SQLType="PURCHASEORDER_T">
  <xs:sequence>
    <xs:element name="Reference" type="ReferenceType" minOccurs="1" xdb:SQLName="REFERENCE" />
    <xs:element name="Actions" type="ActionsType" xdb:SQLName="ACTIONS" />
    <xs:element name="Reject" type="RejectionType" minOccurs="0" xdb:SQLName="REJECTION" />
    <xs:element name="Requestor" type="RequestorType" xdb:SQLName="REQUESTOR" />
    <xs:element name="User" type="UserType" minOccurs="1" xdb:SQLName="USERID" />
    <xs:element name="CostCenter" type="CostCenterType" xdb:SQLName="COST_CENTER" />
    <xs:element name="ShippingInstructions" type="ShippingInstructionsType"
      xdb:SQLName="SHIPPING_INSTRUCTIONS" />
    <xs:element name="SpecialInstructions" type="SpecialInstructionsType"
      xdb:SQLName="SPECIAL_INSTRUCTIONS" />
    <xs:element name="LineItems" type="LineItemsType" xdb:SQLName="LINEITEMS" />
    <xs:element name="Notes" type="po:NotesType" xdb:SQLType="CLOB" />
  </xs:sequence>
</xs:complexType>
<xs:complexType name="LineItemsType" xdb:SQLType="LINEITEMS_T">
  <xs:sequence>
    <xs:element name="LineItem" type="LineItemType" maxOccurs="unbounded"
      xdb:SQLName="LINEITEM" xdb:SQLCollType="LINEITEM_V" />
  </xs:sequence>
</xs:complexType>
<xs:complexType name="LineItemType" xdb:SQLType="LINEITEM_T">
  <xs:sequence>
    <xs:element name="Description" type="DescriptionType"
      xdb:SQLName="DESCRIPTION" />
    <xs:element name="Part" type="PartType" xdb:SQLName="PART" />
  </xs:sequence>
  <xs:attribute name="ItemNumber" type="xs:integer" xdb:SQLName="ITEMNUMBER"
    xdb:SQLType="NUMBER" />
</xs:complexType>
<xs:complexType name="PartType" xdb:SQLType="PART_T">
  <xs:attribute name="Id" xdb:SQLName="PART_NUMBER" xdb:SQLType="VARCHAR2">
    <xs:simpleType>
      <xs:restriction base="xs:string">
        <xs:minLength value="10" />
        <xs:maxLength value="14" />
      </xs:restriction>
    </xs:simpleType>
  </xs:attribute>
  <xs:attribute name="Quantity" type="moneyType" xdb:SQLName="QUANTITY" />
  <xs:attribute name="UnitPrice" type="quantityType" xdb:SQLName="UNITPRICE" />
</xs:complexType>
...
<xs:complexType name="ActionsType" xdb:SQLType="ACTIONS_T">
  <xs:sequence>
    <xs:element name="Action" maxOccurs="4" xdb:SQLName="ACTION" xdb:SQLCollType="ACTION_V">
      <xs:complexType xdb:SQLType="ACTION_T">
        <xs:sequence>
          <xs:element name="User" type="UserType" xdb:SQLName="ACTIONED_BY" />
          <xs:element name="Date" type="DateType" minOccurs="0" xdb:SQLName="DATE_ACTIONED" />
        </xs:sequence>
      </xs:complexType>
    </xs:element>
  </xs:sequence>
</xs:complexType>
<xs:complexType name="RejectionType" xdb:SQLType="REJECTION_T">
  <xs:all>
    <xs:element name="User" type="UserType" minOccurs="0" xdb:SQLName="REJECTED_BY" />
    <xs:element name="Date" type="DateType" minOccurs="0" xdb:SQLName="DATE_REJECTED" />
    <xs:element name="Comments" type="CommentsType" minOccurs="0" xdb:SQLName="REASON_REJECTED" />
  </xs:all>
</xs:complexType>
<xs:complexType name="ShippingInstructionsType" xdb:SQLType="SHIPPING_INSTRUCTIONS_T">
  <xs:sequence>
    <xs:element name="name" type="NameType" minOccurs="0" xdb:SQLName="SHIP_TO_NAME" />

```

```
<xs:element name="address" type="AddressType" minOccurs="0" xdb:SQLName="SHIP_TO_ADDRESS" />
<xs:element name="telephone" type="TelephoneType" minOccurs="0" xdb:SQLName="SHIP_TO_PHONE" />
</xs:sequence>
</xs:complexType>
...
</xs:schema>
```

18.3.2 XML Schema Attribute Data Types Mapped to SQL

An XML attribute declaration can specify its XML Schema data type in terms of a primitive type, a local `simpleType`, a global `simpleType`, or a reference to a global attribute (`ref=" . . "`). The SQL data type and its associated information are derived from the base XML Schema type.

An attribute declaration can specify its XML Schema data type in terms of any of the following:

- Primitive type
- Global `simpleType`, declared within this XML schema or in an external XML schema
- Reference to global attribute (`ref=" . . "`), declared within this XML schema or in an external XML schema
- Local `simpleType`

In all cases, the SQL data type, any associated information (length, precision), and the memory mapping information are derived from the `simpleType` on which the attribute is based.

18.3.2.1 You Can Override the SQLType Value in an XML Schema When Declaring Attributes

You can explicitly specify a `SQLType` value in an XML schema, as an annotation. The SQL data type that you specify is used for XML schema validation, overriding the default SQL data types.

Only the following specific forms of such SQL data-type overrides are allowed:

- If the default SQL data type is `STRING` then you can override it with `CHAR`, `VARCHAR`, or `CLOB`.
- If the default SQL data type is `RAW` then you can override it with `RAW` or `BLOB`.

18.3.3 XML Schema Element Data Types Mapped to SQL

An XML element declaration can specify its XML Schema data type using a primitive type, a local or global `simpleType`, a local or global `complexType`, or a reference to a global element (`ref=" . . "`). The SQL data type and its associated information are derived from the base XML Schema type.

An element declaration can specify its XML Schema data type in terms of any of the following:

- Any of the ways for specifying type for an attribute declaration. See [XML Schema Attribute Data Types Mapped to SQL](#) (page 18-22).
- Global `complexType`, specified within this XML schema document or in an external XML schema.

- Reference to a global element (`ref=" . . . "`), which could itself be within this XML schema document or in an external XML schema.
- Local `complexType`.

18.3.3.1 Override of the SQLType Value in an XML Schema When Declaring Elements

An element based on a `complexType` is, by default, mapped to a SQL object type that contains object attributes corresponding to each of its sub-elements and attributes. You can override this mapping by explicitly specifying a value for attribute `SQLType` in the input XML schema.

The following values for `SQLType` are permitted here:

- `VARCHAR2`
- `RAW`
- `CLOB`
- `BLOB`

These represent storage of the XML data in a text form in the database.

For example, to override the `SQLType` from `VARCHAR2` to `CLOB`, declare the `xdb` namespace using `xmlns:xdb="http://xmlns.oracle.com/xdb"`, and then use `xdb:SQLType = "CLOB"`.

The following special cases are handled:

- If a cycle is detected when processing the `complexType` values that are used to declare elements and the elements declared within the `complexType`, the `SQLInline` attribute is forced to be `false`, and the correct SQL mapping is set to `REF XMLType`.
- If `maxOccurs > 1`, a varray type might be created.
 - If `SQLInline = "true"`, then a varray type is created whose element type is the SQL data type previously determined. Cardinality of the varray is based on the value of attribute `maxOccurs`. Either you specify the name of the varray type using attribute `SQLCollType`, or it is derived from the element name.
 - If `SQLInline = "false"`, then the SQL data type is set to `XDB.XDB$XMLTYPE_REF_LIST_T`. This is a predefined data type that represents an array of `REF` values pointing to `XMLType` instances.
- If the element is a global element, or if `SQLInline = "false"`, then the system creates a default table. Either you specify the name of the default table, or it is derived from the element name.

18.3.4 How XML Schema simpleType Is Mapped to SQL

XML `simpleType` is mapped to SQL object types in various ways, depending on how the `simpleType` is defined.

Figure 18-1 (page 18-24) illustrates one such mapping, XML string type to SQL `VARCHAR2` or `CLOB`.

Figure 18-1 simpleType Mapping: XML Strings to SQL VARCHAR2 or CLOB

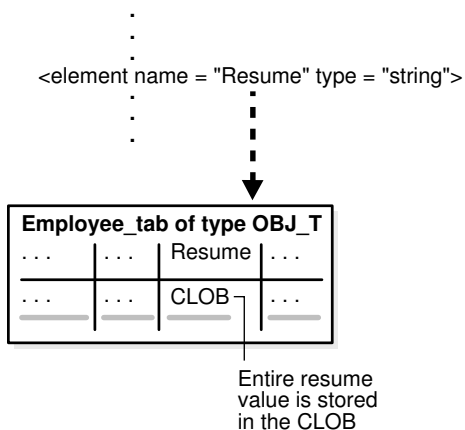

Table 18-4 (page 18-24) through Table 18-7 (page 18-25) present the default mapping of XML Schema simpleType to SQL, as specified in the XML Schema definition.

For example:

- An XML Schema *primitive* type is mapped to the closest SQL data type. For example, DECIMAL, POSITIVEINTEGER, and FLOAT are all mapped to SQL NUMBER.
- An XML Schema *enumeration* type is mapped to a SQL object type with a single RAW(*n*) object attribute. The value of *n* is determined by the number of possible values in the enumeration declaration.
- An XML Schema *list* or a *union* type is mapped to a SQL string (VARCHAR2 or CLOB) data type.

Table 18-4 XML Schema String Data Types Mapped to SQL

XML Schema String Type	Length or MaxLength Facet	Default SQL Data Type	Compatible SQL Data Type
string	n	VARCHAR2(n) if n < 4000, else VARCHAR2(4000)	CHAR, CLOB
string	-	VARCHAR2(4000) if mapUnboundedStringToLob = "false", CLOB	CHAR, CLOB

Table 18-5 XML Schema Binary Data Types (hexBinary/base64Binary) Mapped to SQL

XML Schema Binary Type	Length or MaxLength Facet	Default SQL Data Type	Compatible SQL Data Type
hexBinary, base64Binary	n	RAW(n) if n < 2000, else RAW(2000)	RAW, BLOB
hexBinary, base64Binary	-	RAW(2000) if mapUnboundedStringToLob = "false", BLOB	RAW, BLOB

Table 18-6 Default Mapping of Numeric XML Schema Primitive Types to SQL

XML Schema Simple Type	Default SQL Data Type	totalDigits (m), fractionDigits(n) Specified	Compatible SQL Data Types
float	NUMBER	NUMBER (m+n, n)	FLOAT, DOUBLE, BINARY_FLOAT
double	NUMBER	NUMBER (m+n, n)	FLOAT, DOUBLE, BINARY_DOUBLE
decimal	NUMBER	NUMBER (m+n, n)	FLOAT, DOUBLE
integer	NUMBER	NUMBER (m+n, n)	NUMBER
nonNegativeInteger	NUMBER	NUMBER (m+n, n)	NUMBER
positiveInteger	NUMBER	NUMBER (m+n, n)	NUMBER
nonPositiveInteger	NUMBER	NUMBER (m+n, n)	NUMBER
negativeInteger	NUMBER	NUMBER (m+n, n)	NUMBER
long	NUMBER (20)	NUMBER (m+n, n)	NUMBER
unsignedLong	NUMBER (20)	NUMBER (m+n, n)	NUMBER
int	NUMBER (10)	NUMBER (m+n, n)	NUMBER
unsignedInt	NUMBER (10)	NUMBER (m+n, n)	NUMBER
short	NUMBER (5)	NUMBER (m+n, n)	NUMBER
unsignedShort	NUMBER (5)	NUMBER (m+n, n)	NUMBER
byte	NUMBER (3)	NUMBER (m+n, n)	NUMBER
unsignedByte	NUMBER (3)	NUMBER (m+n, n)	NUMBER

Table 18-7 XML Schema Date and Time Data Types Mapped to SQL

XML Schema Date or Time Type	Default SQL Data Type	Compatible SQL Data Types
dateTime	TIMESTAMP	TIMESTAMP WITH TIME ZONE, DATE
time	TIMESTAMP	TIMESTAMP WITH TIME ZONE, DATE
date	DATE	TIMESTAMP WITH TIME ZONE
gDay	DATE	TIMESTAMP WITH TIME ZONE
gMonth	DATE	TIMESTAMP WITH TIME ZONE
gYear	DATE	TIMESTAMP WITH TIME ZONE
gYearMonth	DATE	TIMESTAMP WITH TIME ZONE
gMonthDay	DATE	TIMESTAMP WITH TIME ZONE
duration	VARCHAR2 (4000)	none

Table 18-8 Default Mapping of Other XML Schema Primitive and Derived Data Types to SQL

XML Schema Primitive or Derived Type	Default SQL Data Type	Compatible SQL Data Types
boolean	RAW(1)	VARCHAR2
language(string)	VARCHAR2(4000)	CLOB, CHAR
NMTOKEN(string)	VARCHAR2(4000)	CLOB, CHAR
NMTOKENS(string)	VARCHAR2(4000)	CLOB, CHAR
Name(string)	VARCHAR2(4000)	CLOB, CHAR
NCName(string)	VARCHAR2(4000)	CLOB, CHAR
ID	VARCHAR2(4000)	CLOB, CHAR
IDREF	VARCHAR2(4000)	CLOB, CHAR
IDREFS	VARCHAR2(4000)	CLOB, CHAR
ENTITY	VARCHAR2(4000)	CLOB, CHAR
ENTITIES	VARCHAR2(4000)	CLOB, CHAR
NOTATION	VARCHAR2(4000)	CLOB, CHAR
anyURI	VARCHAR2(4000)	CLOB, CHAR
anyType	VARCHAR2(4000)	CLOB, CHAR
anySimpleType	VARCHAR2(4000)	CLOB, CHAR
QName	XDB.XDB\$QNAME	none
normalizedString	VARCHAR2(4000)	none
token	VARCHAR2(4000)	none

18.3.4.1 NCHAR, NVARCHAR2, and NCLOB SQLType Values Are Not Supported for SQLType

Oracle XML DB does *not* support NCHAR, NVARCHAR2, and NCLOB as values for attribute SQLType: You cannot specify that an XML element or attribute is to be of type NCHAR, NVARCHAR2, or NCLOB. Also, if you provide your own data type, do not use any of these data types.

See Also:

[Oracle XML DB Restrictions](#) (page B-1)

18.3.4.2 simpleType: How XML Strings Are Mapped to SQL VARCHAR2 Versus CLOB

If an XML schema specifies a data type as a string with `maxLength` less than 4000, it is mapped to a VARCHAR2 object attribute of the specified length. If `maxLength` is not specified in the schema then the XML Schema data type can only be mapped to a LOB.

This is sub-optimal when most of the string values are small and only a small fraction of them are large enough to need a LOB.

See Also:

[Table 18-4](#) (page 18-24)

18.3.4.3 How XML Schema Time Zones Are Mapped to SQL

If your application needs to work with time-zone indicators, then use attribute `SQLType` to specify the SQL data type as `TIMESTAMP WITH TIME ZONE`. This ensures that values containing time-zone indicators can be stored and retrieved correctly.

The following XML Schema data types allow for an optional time-zone indicator as part of their literal values:

- `xsd:dateTime`
- `xsd:time`
- `xsd:date`
- `xsd:gYear`
- `xsd:gMonth`
- `xsd:gDay`
- `xsd:gYearMonth`
- `xsd:gMonthDay`

By default, XML schema registration maps `xsd:dateTime` and `xsd:time` to SQL data type `TIMESTAMP`, and it maps all other date types to SQL data type `DATE`.

SQL data types `TIMESTAMP` and `DATE` do not permit a time-zone indicator. For this reason, if your application needs time-zone information then you must use attribute `SQLType` to specify SQL data type `TIMESTAMP WITH TIME ZONE`. For example:

```
<element name="dob" type="xsd:dateTime"
  xdb:SQLType="TIMESTAMP WITH TIME ZONE"/>
<attribute name="endofquarter" type="xsd:gMonthDay"
  xdb:SQLType="TIMESTAMP WITH TIME ZONE"/>
```

18.3.4.3.1 Use Trailing Z to Indicate UTC Time Zone

You can specify an XML Schema time-zone component as `Z`, to indicate UTC time zone. When a value with a trailing `Z` is stored as SQL `TIMESTAMP WITH TIME ZONE`, the time zone is actually stored as `+00:00`. The retrieved value contains the trailing `+00:00` and not the original `Z`.

For example, if the value in an input XML document is `1973-02-12T13:44:32Z` then the output is `1973-02-12T13:44:32.000000+00:00`.

18.3.5 How XML Schema complexType Is Mapped to SQL

XML `complexType` is mapped to SQL object types in various ways, depending on how the `complexType` is defined.

Using XML Schema, a `complexType` is mapped to a SQL object type as follows:

- XML attributes declared within the `complexType` are mapped to SQL object attributes. The `simpleType` defining an XML attribute determines the SQL data type of the corresponding object attribute.
- XML elements declared within the `complexType` are also mapped to SQL object attributes. The `simpleType` or `complexType` defining an XML element determines the SQL data type of the corresponding object attribute.

If the XML element is declared with attribute `maxOccurs > 1` then it is mapped to a SQL collection (object) attribute. The collection could be a varray value (the default, recommended) or an unordered table (if you set deprecated attribute `xdb:maintainOrder3` to `false`). The default storage of a varray value is an ordered collections table (OCT). You can choose LOB storage instead, by setting deprecated attribute `xdb:storeVarrayAsTable8` to `false`.

18.3.5.1 Attribute Specification in a complexType XML Schema Declaration

When an element is based on a global `complexType`, attribute `SQLType` must be specified for the `complexType` declaration. You can optionally include the same `SQLType` attribute within the element declaration.

If you do not specify attribute `SQLType` for the global `complexType`, Oracle XML DB creates a `SQLType` attribute with an internally generated name. The elements that reference this global type *cannot* then have a different value for `SQLType`. The following code is acceptable:

```
<xs:complexType name="LineItemsType" xdb:SQLType="LINEITEMS_T">
  <xs:sequence>
    <xs:element name="LineItem" type="LineItemType" maxOccurs="unbounded"
      xdb:SQLName="LINEITEM" xdb:SQLCollType="LINEITEM_V"/>
  </xs:sequence>
</xs:complexType>
<xs:complexType name="LineItemType" xdb:SQLType="LINEITEM_T">
  <xs:sequence>
    <xs:element name="Description" type="DescriptionType"
      xdb:SQLName="DESCRIPTION"/>
    <xs:element name="Part" type="PartType" xdb:SQLName="PART"/>
  </xs:sequence>
  <xs:attribute name="ItemNumber" type="xs:integer" xdb:SQLName="ITEMNUMBER"
    xdb:SQLType="NUMBER"/>
</xs:complexType>
<xs:complexType name="PartType" xdb:SQLType="PART_T">
  <xs:attribute name="Id" xdb:SQLName="PART_NUMBER" xdb:SQLType="VARCHAR2">
    <xs:simpleType>
      <xs:restriction base="xs:string">
        <xs:minLength value="10"/>
        <xs:maxLength value="14"/>
      </xs:restriction>
    </xs:simpleType>
  </xs:attribute>
  <xs:attribute name="Quantity" type="moneyType" xdb:SQLName="QUANTITY"/>
  <xs:attribute name="UnitPrice" type="quantityType" xdb:SQLName="UNITPRICE"/>
</xs:complexType>
```

³ XML Schema annotations `xdb:maintainOrder` and `xdb:storeVarrayAsTable` are *deprecated*, starting with Oracle Database 12c Release 1 (12.1.0.1).

18.4 complexType Extensions and Restrictions in Oracle XML DB

In XML Schema, `complexType` values are declared based on `complexContent` and `simpleContent`. Oracle XML DB defines various extensions and restrictions to `complexType`.

- `simpleContent` is declared as an extension of `simpleType`.
- `complexContent` is declared as one of the following:
 - Base type
 - `complexType` extension
 - `complexType` restriction

18.4.1 complexType Declarations in XML Schema: Handling Inheritance

For `complexType`, Oracle XML DB handles inheritance in an XML schema differently for types that extend and types that restrict other complex types

- For complex types declared to *extend* other complex types, the SQL type corresponding to the base type is specified as the supertype for the current SQL type. Only the additional attributes and elements declared in the sub-`complexType` are added as attributes to the sub-object-type.
- For complex types declared to *restrict* other complex types, the SQL type for the sub-`complexType` is set to be the same as the SQL type for its base type. This is because SQL does not support restriction of object types through the inheritance mechanism. Any constraints are imposed by the restriction in XML schema.

[Example 18-9](#) (page 18-30) shows the registration of an XML schema that defines a base `complexType` `Address` and two extensions `USAddress` and `IntlAddress`.

Note:

Type `intladdr_t` is created as a *final* type because the corresponding `complexType` specifies the `final` attribute. By default, all `complexTypes` can be extended and restricted by other types, so all SQL object types are created as types that are *not final*.

```
CREATE TYPE addr_t AS OBJECT(SYS_XDBPD$ XDB.XDB$RAW_LIST_T,
                           "street" VARCHAR2(4000),
                           "city" VARCHAR2(4000)) NOT FINAL;
CREATE TYPE usaddr_t UNDER addr_t ("zip" VARCHAR2(4000)) NOT FINAL;
CREATE TYPE intladdr_t UNDER addr_t ("country" VARCHAR2(4000)) FINAL;
```

[Example 18-10](#) (page 18-30) shows the registration of an XML schema that defines a base `complexType` `Address` and a restricted type `LocalAddress` that prohibits the specification of `country` attribute.

Because SQL inheritance does not support a notion of restriction, the SQL data type corresponding to a restricted `complexType` is an empty subtype of the parent object type. For the XML schema of [Example 18-10](#) (page 18-30), Oracle XML DB generates the following SQL types:

```
CREATE TYPE addr_t AS OBJECT (SYS_XDBPD$ XDB.XDB$RAW_LIST_T,
                             "street"  VARCHAR2(4000),
                             "city"    VARCHAR2(4000),
                             "zip"     VARCHAR2(4000),
                             "country" VARCHAR2(4000)) NOT FINAL;
CREATE TYPE usaddr_t UNDER addr_t;
```

Example 18-9 XML Schema Inheritance: complexContent as an Extension of complexTypes

```
DECLARE
  doc VARCHAR2(3000) :=
    '<xs:schema xmlns:xs="http://www.w3.org/2001/XMLSchema"
      xmlns:xdb="http://xmlns.oracle.com/xdb">
      <xs:complexType name="Address" xdb:SQLType="ADDR_T">
        <xs:sequence>
          <xs:element name="street" type="xs:string"/>
          <xs:element name="city" type="xs:string"/>
        </xs:sequence>
      </xs:complexType>
      <xs:complexType name="USAddress" xdb:SQLType="USADDR_T">
        <xs:complexContent>
          <xs:extension base="Address">
            <xs:sequence>
              <xs:element name="zip" type="xs:string"/>
            </xs:sequence>
          </xs:extension>
        </xs:complexContent>
      </xs:complexType>
      <xs:complexType name="IntlAddress" final="#all" xdb:SQLType="INTLADDR_T">
        <xs:complexContent>
          <xs:extension base="Address">
            <xs:sequence>
              <xs:element name="country" type="xs:string"/>
            </xs:sequence>
          </xs:extension>
        </xs:complexContent>
      </xs:complexType>
    </xs:schema>';
BEGIN
  DBMS_XMLSCHEMA.registerSchema(
    SCHEMAURL => 'http://www.oracle.com/PO.xsd',
    SCHAMEDOC => doc);
END;
```

Example 18-10 Inheritance in XML Schema: Restrictions in complexTypes

```
DECLARE
  doc varchar2(3000) :=
    '<xs:schema xmlns:xs="http://www.w3.org/2001/XMLSchema"
      xmlns:xdb="http://xmlns.oracle.com/xdb">
      <xs:complexType name="Address" xdb:SQLType="ADDR_T">
        <xs:sequence>
          <xs:element name="street" type="xs:string"/>
          <xs:element name="city" type="xs:string"/>
          <xs:element name="zip" type="xs:string"/>
          <xs:element name="country" type="xs:string" minOccurs="0"
            maxOccurs="1"/>
        </xs:sequence>
      </xs:complexType>
      <xs:complexType name="LocalAddress" xdb:SQLType="USADDR_T">
        <xs:complexContent>
```

```

        <xs:restriction base="Address">
          <xs:sequence>
            <xs:element name="street" type="xs:string"/>
            <xs:element name="city" type="xs:string"/>
            <xs:element name="zip" type="xs:string"/>
            <xs:element name="country" type="xs:string"
              minOccurs="0" maxOccurs="0"/>
          </xs:sequence>
        </xs:restriction>
      </xs:complexContent>
    </xs:complexType>
  </xs:schema>';
BEGIN
  DBMS_XMLSCHEMA.registerSchema(
    SCHEMAURL => 'http://www.oracle.com/PO.xsd',
    SCHEMADOC => doc);
END;
```

18.4.2 How a complexType Based on simpleContent Is Mapped to an Object Type

A complex type based on a `simpleContent` declaration is mapped to an object type with attributes corresponding to the XML attributes and an extra `SYS_XDBBODY$` attribute, which corresponds to the body value. The data type of the body attribute is based on a `simpleType` that defines the body type.

For the XML schema of [Example 18-11](#) (page 18-31), Oracle XML DB generates the following type:

```
CREATE TYPE obj_t AS OBJECT(SYS_XDBPD$ XDB.XDB$RAW_LIST_T,
                          SYS_XDBBODY$ VARCHAR2(4000));
```

Example 18-11 XML Schema complexType: Mapping complexType to simpleContent

```

DECLARE
  doc VARCHAR2(3000) :=
    '<schema xmlns="http://www.w3.org/2001/XMLSchema"
      targetNamespace="http://www.oracle.com/emp.xsd"
      xmlns:emp="http://www.oracle.com/emp.xsd"
      xmlns:xdb="http://xmlns.oracle.com/xdb">
    <complexType name="name" xdb:SQLType="OBJ_T">
      <simpleContent>
        <restriction base="string">
        </restriction>
      </simpleContent>
    </complexType>
  </schema>';
BEGIN
  DBMS_XMLSCHEMA.registerSchema(
    SCHEMAURL => 'http://www.oracle.com/emp.xsd',
    SCHEMADOC => doc);
END;
```

18.4.3 How any and anyAttribute Declarations Are Mapped to Object Type Attributes

Oracle XML DB maps the element declaration `any` and the attribute declaration `anyAttribute` to `VARCHAR2` attributes, or optionally to Large Objects (LOBs), in the created object type. The object attribute stores the text of the XML fragment that matches the `any` declaration.

- The `namespace` attribute can be used to restrict the contents so that they belong to a specified namespace.
- The `processContents` attribute within the `any` element declaration, indicates the level of validation required for the contents matching the `any` declaration.

Note: Starting with Oracle Database 12c Release 2 (12.2.0.1), when an XML schema is registered for object-relational XMLType storage by the common user of a multitenant container database (CDB) or by an application common user, you must annotate the complex type with `xdb:SQLType` to specify the corresponding SQL type to use. Otherwise, an error is raised.

The code in [Example 18-12](#) (page 18-32) declares an `any` element and maps it to the column `SYS_XDBANY$`, in object type `obj_t`. It also declares that attribute `processContents` does not validate contents that match the `any` declaration.

For the XML schema of [Example 18-12](#) (page 18-32), Oracle XML DB generates the following type:

```
CREATE TYPE obj_t AS OBJECT(SYS_XDBPD$ XDB.XDB$RAW_LIST_T,
                          Name VARCHAR2(4000),
                          Age NUMBER,
                          SYS_XDBANY$ VARCHAR2(4000));
```

Example 18-12 XML Schema: Mapping complexType to any/anyAttribute

```
DECLARE
  doc VARCHAR2(3000) :=
    '<schema xmlns="http://www.w3.org/2001/XMLSchema"
      targetNamespace="http://www.oracle.com/any.xsd"
      xmlns:emp="http://www.oracle.com/any.xsd"
      xmlns:xdb="http://xmlns.oracle.com/xdb">
    <complexType name="Employee" xdb:SQLType="OBJ_T">
      <sequence>
        <element name="Name" type="string"/>
        <element name="Age" type="decimal"/>
        <any namespace="http://www.w3.org/2001/xhtml"
          processContents="skip"/>
      </sequence>
    </complexType>
  </schema>';
BEGIN
  DBMS_XMLSCHEMA.registerSchema(
    SCHEMAURL => 'http://www.oracle.com/emp.xsd',
    SCHEMADOC => doc);
END;
```

18.5 Creating XML Schema-Based XMLType Columns and Tables

After an XML schema has been registered with Oracle XML DB, you can reference it when you define XMLType tables or columns.

If you specify no storage model when creating an XMLType table or column for XML Schema-based data then the storage model used is that specified during registration of the referenced XML schema. If no storage model was specified for the XML schema registration, then *object-relational* storage is used.

[Example 18-13](#) (page 18-34) shows how to manually create table `purchaseorder`, the default table for `PurchaseOrder` elements.

The `CREATE TABLE` statement of [Example 18-13](#) (page 18-34) is equivalent to the `CREATE TABLE` statement that is generated automatically by Oracle XML DB when you set parameter `GENTABLES` to `TRUE` during XML schema registration.

The XML schema referenced [Example 18-13](#) (page 18-34) specifies that table `purchaseorder` is the default table for `PurchaseOrder` elements. When an XML document compliant with the XML schema is inserted into Oracle XML DB Repository using protocols or PL/SQL, the content of the document is stored as a row in table `purchaseorder`.

When an XML schema is registered as a *global* schema, you must grant the appropriate access rights on the default table to all other users of the database, before they can work with instance documents that conform to the globally registered XML schema.

See Also:

[Local and Global XML Schemas](#) (page 17-12)

Each member of the varray that manages the collection of `Action` elements is stored in the ordered collection table `action_table`. Each member of the varray that manages the collection of `LineItem` elements is stored as a row in ordered collection table `lineitem_table`. The ordered collection tables are heap-based. Because of the `PRIMARY KEY` specification, they automatically contain pseudocolumn `NESTED_TABLE_ID` and column `SYS_NC_ARRAY_INDEX$`, which are required to link them back to the parent column.

By default, the value of (deprecated) XML schema annotation `xdb:storeVarrayAsTable`⁴ is `true`, which automatically generates ordered collection tables (OCTs) for collections during XML schema registration. These OCTs are given system-generated names, which can be difficult to work with. You can give them more meaningful names using the SQL statement `RENAME TABLE`.

The `CREATE TABLE` statement in [Example 18-13](#) (page 18-34) corresponds to a purchase-order document with a single level of nesting: The varray that manages the collection of `LineItem` elements is ordered collection table `lineitem_table`.

What if you had a different XML schema that had, say, a collection of `Shipment` elements inside a `Shipments` element that was, in turn, inside a `LineItem` element? In that case, you could create the table manually as shown in [Example 18-14](#) (page 18-34).

A SQL*Plus `DESCRIBE` statement can be used to view information about an XMLType table, as shown in [Example 18-15](#) (page 18-34).

The output of the `DESCRIBE` statement of [Example 18-15](#) (page 18-34) shows the following information about table `purchaseorder`:

- The table is an XMLType table
- The table is constrained to storing `PurchaseOrder` documents as defined by the `PurchaseOrder` XML schema
- Rows in this table are stored as a set of objects in the database
- SQL type `purchaseorder_t` is the base object for this table

⁴ XML Schema annotation `xdb:storeVarrayAsTable` is *deprecated*, starting with Oracle Database 12c Release 1 (12.1.0.1).

Example 18-13 Creating an XMLType Table that Conforms to an XML Schema

```
CREATE TABLE purchaseorder OF XMLType
XMLSCHEMA "http://localhost:8080/source/schemas/poSource/xsd/purchaseOrder.xsd"
ELEMENT "PurchaseOrder"
VARRAY "XMLDATA"."ACTIONS"."ACTION"
STORE AS TABLE action_table
((PRIMARY KEY (NESTED_TABLE_ID, SYS_NC_ARRAY_INDEX$)))
VARRAY "XMLDATA"."LINEITEMS"."LINEITEM"
STORE AS TABLE lineitem_table
((PRIMARY KEY (NESTED_TABLE_ID, SYS_NC_ARRAY_INDEX$)));
```

Example 18-14 Creating an XMLType Table for Nested Collections

```
CREATE TABLE purchaseorder OF XMLType
XMLSCHEMA "http://localhost:8080/source/schemas/poSource/xsd/purchaseOrder.xsd"
ELEMENT "PurchaseOrder"
VARRAY "XMLDATA"."ACTIONS"."ACTION"
STORE AS TABLE action_table
((PRIMARY KEY (NESTED_TABLE_ID, SYS_NC_ARRAY_INDEX$)))
VARRAY "XMLDATA"."LINEITEMS"."LINEITEM"
STORE AS TABLE lineitem_table
((PRIMARY KEY (NESTED_TABLE_ID, SYS_NC_ARRAY_INDEX$)))
VARRAY "SHIPMENTS"."SHIPMENT"
STORE AS TABLE shipments_table
((PRIMARY KEY (NESTED_TABLE_ID,
SYS_NC_ARRAY_INDEX$)));
```

Example 18-15 Using DESCRIBE with an XML Schema-Based XMLType Table

```
DESCRIBE purchaseorder
Name Null? Type
-----
TABLE of SYS.XMLTYPE(XMLSchema
"http://localhost:8080/source/schemas/poSource/xsd/purchaseOrder.xsd"
Element "PurchaseOrder") STORAGE Object-relational TYPE "PURCHASEORDER_T"
```

18.6 Overview of Partitioning XMLType Tables and Columns Stored Object-Relationally

When you partition an object-relational XMLType table or a table with an XMLType column that is stored object-relationally and you use list, range, or hash partitioning, any ordered collection tables (OCTs) or out-of-line tables within the data are automatically partitioned accordingly, by default.

This **equipartitioning** means that the partitioning of an OCT or an out-of-line table follows the partitioning scheme of its parent (base) table. There is a corresponding child-table partition for each partition of the base table. A child element is stored in the child-table partition that corresponds to the base-table partition of its parent element.

Storage attributes for a base table partition are, by default, also used for the corresponding child-table partitions. You can override these storage attributes for a given child-table partition.

Similarly, by default, the name of an OCT partition is the same as its base (parent) table, but you can override this behavior by specifying the name to use. The name of an out-of-line table partition is always the same as the partition of its parent-table (which could be a base table or an OCT).

Note:

- Equipartitioning of XMLType data stored object-relationally is not available in releases prior to Oracle Database 11g Release 1 (11.1).
- Equipartitioning of XMLType data that is stored out of line is not available in releases prior to Oracle Database 11g Release 2 (11.2.0.2). Starting with that release, out-of-line tables are not shared: You cannot create two top-level tables that are based on the same XML schema, if that schema specifies an out-of-line table.

You can prevent partitioning of OCTs by specifying the keyword `GLOBAL` in a `CREATE TABLE` statement. (Starting with Oracle Database 11g Release 1 (11.1), the default behavior uses keyword `LOCAL`). For information about converting a non-partitioned collection table to a partitioned collection table, see *Oracle Database VLDB and Partitioning Guide*.

You can prevent partitioning of out-of-line tables, and thus allow out-of-line sharing, by turning on event 31178 with level 0x200:

```
ALTER SESSION SET EVENTS '31178 TRACE NAME CONTEXT FOREVER, LEVEL 0x200'
```

See Also:

Oracle Database SQL Language Reference for information about creating tables with partitions using keywords `GLOBAL` and `LOCAL`

18.6.1 Examples of Partitioning XMLType Data Stored Object-Relationally

You can specify partitioning information for an object-relational XMLType base table during either the XML schema registration or the table creation. Examples here illustrate this.

- During XML schema registration, using XML Schema annotation `xdb:tableProps`
- During table creation using `CREATE TABLE`

[Example 18-16](#) (page 18-36) and [Example 18-17](#) (page 18-36) illustrate this. These two examples have exactly the same effect. They partition the base `purchaseorder` table using the `Reference` element to specify ranges. They equipartition the child table of line items with respect to the base table.

[Example 18-16](#) (page 18-36) shows element `PurchaseOrder` from the `purchaseorder` XML schema, annotated to partition the base table and its child table of line items.

[Example 18-17](#) (page 18-36) specifies the same partitioning as in [Example 18-16](#) (page 18-36), but it does so during the creation of the base table `purchaseorder`.

[Example 18-16](#) (page 18-36) and [Example 18-17](#) (page 18-36) also show how you can specify object storage options for the individual child-table partitions. In this case, the `STORAGE` clauses specify that extents of size 14M are to be allocated initially for each of the child-table partitions.

See Also:

- [Example A-2](#) (page A-34)
- *Oracle Database Object-Relational Developer's Guide* for more information about partitioning object-relational data
- *Oracle Database VLDB and Partitioning Guide* for more information about partitioning

Example 18-16 Specifying Partitioning Information During XML Schema Registration

```
<xs:element name="PurchaseOrder" type="PurchaseOrderType"
  xdb:defaultTable="PURCHASEORDER"
  xdb:tableProps =
    "VARRAY XMLDATA.LINEITEMS.LINEITEM
     STORE AS TABLE lineitem_table
      ((PRIMARY KEY (NESTED_TABLE_ID, SYS_NC_ARRAY_INDEX$)))
     PARTITION BY RANGE (XMLDATA.Reference)
      (PARTITION p1 VALUES LESS THAN (1000)
       VARRAY XMLDATA.LINEITEMS.LINEITEM
        STORE AS TABLE lineitem_p1 (STORAGE (MINEXTENTS 13)),
       PARTITION p2 VALUES LESS THAN (2000)
       VARRAY XMLDATA.LINEITEMS.LINEITEM
        STORE AS TABLE lineitem_p2 (STORAGE (MINEXTENTS 13)))/>
```

Example 18-17 Specifying Partitioning Information During Table Creation

```
CREATE TABLE purchaseorder OF XMLType
  XMLSCHEMA "http://localhost:8080/source/schemas/poSource/xsd/purchaseOrder.xsd"
  ELEMENT "PurchaseOrder"
  VARRAY "XMLDATA"."LINEITEMS"."LINEITEM" STORE AS TABLE lineitem_table
  ((PRIMARY KEY (NESTED_TABLE_ID, SYS_NC_ARRAY_INDEX$)))
  PARTITION BY RANGE (XMLDATA.Reference)
  (PARTITION p1 VALUES LESS THAN (1000)
   VARRAY "XMLDATA"."LINEITEMS"."LINEITEM" STORE AS TABLE lineitem_p1
   (STORAGE (MINEXTENTS 13)),
   PARTITION p2 VALUES LESS THAN (2000)
   VARRAY "XMLDATA"."LINEITEMS"."LINEITEM" STORE AS TABLE lineitem_p2
   (STORAGE (MINEXTENTS 13)));
```

18.6.2 Partition Maintenance for XMLType Data Stored Object-Relationally

You need not define or maintain child-table partitions manually. When you perform partition maintenance on the base (parent) table, corresponding maintenance is automatically performed on the child tables as well.

There are a few exceptions to the general rule that you perform partition maintenance only on the base table. In the following cases you perform maintenance on a child table:

- Modify the *default* physical storage attributes of a collection partition
- Modify the physical storage attributes of a collection partition
- Move a collection partition to a different segment, possibly in a different tablespace
- Rename a collection partition

For example, if you change the tablespace of a base table, that change is not cascaded to its child-table partitions. You must manually use `ALTER TABLE MOVE PARTITION` on the child-table partitions to change their tablespace.

Other than those exceptional operations, you perform all partition maintenance on the base table only. This includes operations such as adding, dropping, and splitting a partition.

Online partition redefinition is also supported for child tables. You can copy unpartitioned child tables to partitioned child tables during online redefinition of a base table. You typically specify parameter values `copy_indexes => 0` and `copy_constraints => false` for PL/SQL procedure `DBMS_REDEFINITION.copy_table_dependents`, to protect the indexes and constraints of the newly defined child tables.

See Also:

- *Oracle Database SQL Language Reference* for information about SQL statement `ALTER TABLE`
 - *Oracle Database PL/SQL Packages and Types Reference* for information about online partition redefinition using PL/SQL package `DBMS_REDEFINITION`
-
-

18.7 Specification of Relational Constraints on XMLType Tables and Columns

For XMLType data stored object-rationally, you can specify typical relational constraints for elements and attributes that occur only once in an XML document.

[Example 18-18](#) (page 18-38) defines uniqueness and foreign-key constraints on XMLType table `purchaseorder` in standard database schema `OE`.

For XMLType data that is stored object-rationally, such as that in table `OE.purchaseorder`, constraints must be specified in terms of object attributes of the SQL data types that are used to manage the XML content.

[Example 18-18](#) (page 18-38) is similar to [Example 3-8](#) (page 3-7), which defines a uniqueness constraint on a binary XML table. But in addition, [Example 18-18](#) (page 18-38) defines a foreign-key constraint that requires element `User` of each `OE.purchaseorder` document to be the e-mail address of an employee that is in table `employees` of standard database schema `HR`.

Just as for [Example 3-8](#) (page 3-7), the uniqueness constraint `reference_is_unique` of [Example 18-18](#) (page 18-38) ensures the uniqueness of element `Reference` across all documents stored in the table. The foreign key constraint `user_is_valid` ensures that the value of element `User` corresponds to a value in column `email` of table `HR.employees`.

The text node associated with element `Reference` in the XML document `DuplicateReference.xml` contains the same value as the corresponding node in XML document `PurchaseOrder.xml`. Attempting to store both documents in Oracle XML DB thus violates the constraint `reference_is_unique`.

The text node associated with element `User` in XML document `InvalidUser.xml` contains the value `HACKER`. There is no entry in table `HR.employees` where the value of column `email` is `HACKER`. Attempting to store this document in Oracle XML DB violates the foreign-key constraint `user_is_valid`.

See Also:

- [Enforcing Referential Integrity Using SQL Constraints](#) (page 3-6), and [Example 3-8](#) (page 3-7) in particular
- [Enforcing XML Data Integrity Using the Database](#) (page 3-5) for information about defining constraints for XMLType data stored as binary XML
- [Adding Unique Constraints to the Parent Element of an Attribute](#) (page 18-38)

Example 18-18 Integrity Constraints and Triggers for an XMLType Table Stored Object-Relationally

```
ALTER TABLE purchaseorder
  ADD CONSTRAINT reference_is_unique
  UNIQUE (XMLDATA."REFERENCE");

ALTER TABLE purchaseorder
  ADD CONSTRAINT user_is_valid
  FOREIGN KEY (XMLDATA."USERID") REFERENCES hr.employees(email);

INSERT INTO purchaseorder
  VALUES (XMLType(bfilename('XMLDIR', 'purchaseOrder.xml'),
    nls_charset_id('AL32UTF8')));

INSERT INTO purchaseorder
  VALUES (XMLType(bfilename('XMLDIR', 'DuplicateReference.xml'),
    nls_charset_id('AL32UTF8')));

INSERT INTO purchaseorder
*
ERROR at line 1:
ORA-00001: unique constraint (QUINE.REFERENCE_IS_UNIQUE) violated

INSERT INTO purchaseorder
  VALUES (XMLType(bfilename('XMLDIR', 'InvalidUser.xml'),
    nls_charset_id('AL32UTF8')));

INSERT INTO purchaseorder
*
ERROR at line 1:
ORA-02291: integrity constraint (QUINE.USER_IS_VALID) violated - parent key not
found
```

18.7.1 Adding Unique Constraints to the Parent Element of an Attribute

To create constraints on elements that can occur more than once, store the varray as an ordered collection table (OCT). You can then create constraints on the OCT. You might, for example, want to create a unique key based on an attribute of an element that repeats itself (a collection).

[Example 18-19](#) (page 18-39) shows an XML schema that lets attribute No of element <PhoneNumber> appear more than once. The example shows how you can add a unique constraint to ensure that the same phone number cannot be repeated within a given instance document.

The constraint in this example applies to each collection, and not across all instances. This is achieved by creating a concatenated index with the collection id column. To apply the constraint across all collections of all instance documents, omit the collection id column.

Note:

You can create only a *functional* constraint as a unique or foreign key constraint on XMLType data stored as binary XML.

Example 18-19 Adding a Unique Constraint to the Parent Element of an Attribute

```
BEGIN DBMS_XMLSCHEMA.registerSchema(
  SCHEMAURL => 'emp.xsd',
  SCHEMADOC => '<xs:schema xmlns:xs="http://www.w3.org/2001/XMLSchema"
    xmlns:xdb="http://xmlns.oracle.com/xdb">
    <xs:element name="Employee" xdb:SQLType="EMP_TYPE">
    <xs:complexType>
    <xs:sequence>
    <xs:element name="EmployeeId" type="xs:positiveInteger"/>
    <xs:element name="PhoneNumber" maxOccurs="10"/>
    <xs:complexType>
    <xs:attribute name="No" type="xs:integer"/>
    </xs:complexType>
    </xs:sequence>
    </xs:element>
    </xs:sequence>
    </xs:complexType>
    </xs:element>
    </xs:schema>',
  LOCAL      => FALSE,
  GENTYPES   => FALSE);
END;/
```

PL/SQL procedure successfully completed.

```
CREATE TABLE emp_tab OF XMLType
  XMLSCHEMA "emp.xsd" ELEMENT "Employee"
  VARRAY XMLDATA."PhoneNumber" STORE AS TABLE phone_tab;
```

Table created.

```
ALTER TABLE phone_tab ADD UNIQUE (NESTED_TABLE_ID, "No");
```

Table altered.

```
INSERT INTO emp_tab
  VALUES(XMLType('<Employee>
    <EmployeeId>1234</EmployeeId>
    <PhoneNumber No="1234"/>
    <PhoneNumber No="2345"/>
  </Employee>').createSchemaBasedXML('emp.xsd'));
```

1 row created.

```
INSERT INTO emp_tab
  VALUES(XMLType('<Employee>
    <EmployeeId>3456</EmployeeId>
    <PhoneNumber No="4444"/>
```

```
<PhoneNumber No="4444"/>
</Employee>').createSchemaBasedXML('emp.xsd');
```

This returns the expected result:

```
*
ERROR at line 1:
ORA-00001: unique constraint (SCOTT.SYS_C002136) violated
```

18.8 Out-Of-Line Storage of XMLType Data

By default, when XMLType data is stored object-rationally a child element is mapped to an embedded SQL object attribute. Sometimes better performance can be obtained by storing some XMLType data out of line. Use XML schema annotation `xdb:SQLInline` to do this.

18.8.1 Setting Annotation Attribute `xdb:SQLInline` to false for Out-Of-Line Storage

Set XML schema annotation `xdb:SQLInline` to `false` to store an XML fragment out of line. The element is mapped to a SQL object type with an embedded `REF` attribute, which points to another XMLType instance that is stored out of line and that corresponds to the XML fragment.

By default, a child XML element is mapped to an embedded SQL object attribute when XMLType data is stored object-rationally. However, there are scenarios where out-of-line storage offers better performance. In such cases, set XML schema annotation (attribute) `xdb:SQLInline` to `false`, so Oracle XML DB generates a SQL object type with an embedded `REF` attribute. The `REF` points to another XMLType instance that is stored out of line and that corresponds to the XML fragment. Default XMLType tables are also created, to store the out-of-line fragments.

Figure 18-2 (page 18-40) illustrates the mapping of `complexType` to SQL for out-of-line storage.

Figure 18-2 Mapping complexType to SQL for Out-Of-Line Storage

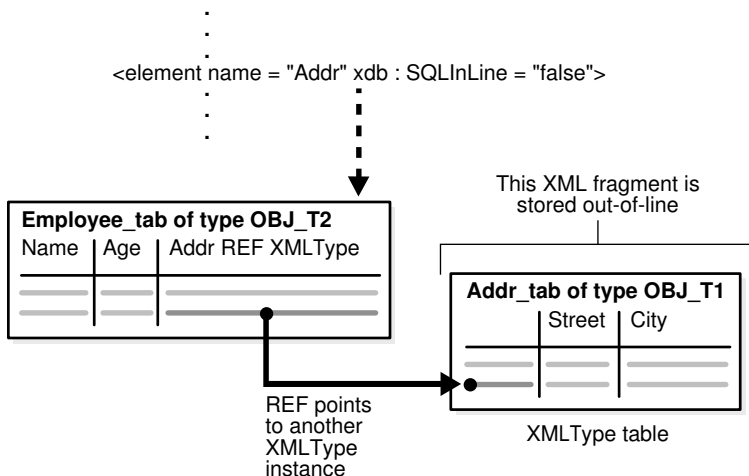

Note:

Starting with Oracle Database 11g Release 2 (11.2.0.2), you can create only *one* XMLType table that uses an XML schema that results in an *out-of-line* table. An error is raised if you try to create a second table that uses the same XML schema.

In [Example 18-20](#) (page 18-41), attribute `xdb:SQLInline` of element `Addr` has value `false`. The resulting SQL object type, `obj_t2`, has an XMLType column with an embedded REF object attribute. The REF attribute points to an XMLType instance of SQL object type `obj_t1` in table `addr_tab`. Table `addr_tab` is stored out of line. It has columns `street` and `city`.

When registering this XML schema, Oracle XML DB generates the XMLType tables and types shown in [Example 18-21](#) (page 18-42).

Table `emp_tab` holds all of the employee information, and it contains an object reference that points to the address information that is stored out of line, in table `addr_tab`.

An advantage of this model is that it lets you query the out-of-line table (`addr_tab`) directly, to look up address information. [Example 18-22](#) (page 18-42) illustrates querying table `addr_tab` directly to obtain the distinct city information for all employees.

The disadvantage of this storage model is that, in order to obtain the entire `Employee` element, you must access an additional table for the address.

Example 18-20 Setting SQLInline to False for Out-Of-Line Storage

```

DECLARE
  doc VARCHAR2(3000) :=
    '<schema xmlns="http://www.w3.org/2001/XMLSchema"
      targetNamespace="http://www.oracle.com/emp.xsd"
      xmlns:emp="http://www.oracle.com/emp.xsd"
      xmlns:xdb="http://xmlns.oracle.com/xdb">
    <complexType name="EmpType" xdb:SQLType="EMP_T">
      <sequence>
        <element name="Name" type="string"/>
        <element name="Age" type="decimal"/>
        <element name="Addr"
          xdb:SQLInline="false"
          xdb:defaultTable="ADDR_TAB">
          <complexType xdb:SQLType="ADDR_T">
            <sequence>
              <element name="Street" type="string"/>
              <element name="City" type="string"/>
            </sequence>
          </complexType>
        </element>
      </sequence>
    </complexType>
    <element name="Employee" type="emp:EmpType"
      xdb:defaultTable="EMP_TAB"/>
  </schema>';
BEGIN
  DBMS_XMLSCHEMA.registerSchema(
    SCHEMAURL      => 'emp.xsd',
    SCHEMADOC      => doc,
    ENABLE_HIERARCHY => DBMS_XMLSCHEMA.ENABLE_HIERARCHY_NONE);

```

```
END;
/
```

Example 18-21 Generated XMLType Tables and Types

```
DESCRIBE emp_tab
Name                               Null?   Type
-----
TABLE of SYS.XMLTYPE(XMLSchema "emp.xsd" Element "Employee") STORAGE Object-
relational TYPE "EMP_T"

DESCRIBE addr_tab
Name                               Null?   Type
-----
TABLE of SYS.XMLTYPE(XMLSchema "emp.xsd" Element "Addr") STORAGE Object-relational
TYPE "ADDR_T"

DESCRIBE emp_t
emp_t is NOT FINAL
Name                               Null?   Type
-----
SYS_XDBPD$                         XDB.XDB$RAW_LIST_T
Name                               VARCHAR2(4000 CHAR)
Age                                 NUMBER
Addr                               REF OF XMLTYPE

DESCRIBE addr_t
Name                               Null?   Type
-----
SYS_XDBPD$                         XDB.XDB$RAW_LIST_T
Street                             VARCHAR2(4000 CHAR)
City                               VARCHAR2(4000 CHAR)
```

Example 18-22 Querying an Out-Of-Line Table

```
INSERT INTO emp_tab
VALUES
  (XMLType(' <x:Employee
            xmlns:xsi="http://www.w3.org/2001/XMLSchema-instance"
            xmlns:x="http://www.oracle.com/emp.xsd"
            xsi:schemaLocation="http://www.oracle.com/emp.xsd emp.xsd">
            <Name>Abe Bee</Name>
            <Age>22</Age>
            <Addr>
              <Street>A Street</Street>
              <City>San Francisco</City>
            </Addr>
          </x:Employee>'));

INSERT INTO emp_tab
VALUES
  (XMLType(' <x:Employee
            xmlns:xsi="http://www.w3.org/2001/XMLSchema-instance"
            xmlns:x="http://www.oracle.com/emp.xsd"
            xsi:schemaLocation="http://www.oracle.com/emp.xsd emp.xsd">
            <Name>Cecilia Dee</Name>
            <Age>23</Age>
            <Addr>
              <Street>C Street</Street>
```



```

        <City>Redwood City</City>
      </Addr>
    </x:Employee>');
. . .
SELECT DISTINCT XMLCast(XMLQuery('/Addr/City' PASSING OBJECT_VALUE AS "."
                                RETURNING CONTENT)
                    AS VARCHAR2(20))
FROM addr_tab;

CITY
-----
Redwood City
San Francisco

```

18.8.2 Storing Collections in Out-Of-Line Tables

You can store collection items out of line. Instead of a single REF column, the parent element contains a varray of REF values that point to the collection members.

For example, suppose that there is a list of addresses for each employee and that list is mapped to out-of-line storage, as shown in [Example 18-23](#) (page 18-43).

During registration of this XML schema, Oracle XML DB generates tables `emp_tab` and `addr_tab` and types `emp_t` and `addr_t`, just as in [Example 18-20](#) (page 18-41). However, this time, type `emp_t` contains a varray of REF values that point to addresses, instead of a single REF attribute, as shown in [Example 18-24](#) (page 18-44).

By default, (deprecated) XML schema attribute `xdb:storeVarrayAsTable`⁵⁵ has value `true`, which means that the varray of REF values is stored out of line, in an intermediate table. That is, in addition to creating the tables and types just mentioned, XML schema registration also creates the intermediate table that stores the list of REF values. This table has a system-generated name, but you can rename it. That can be useful, for example, in order to create an index on it.

[Example 18-26](#) (page 18-44) shows a query that selects the names of all San Francisco-based employees and the streets in which they live. The example queries the address table on element `City`, and joins back with the employee table. The explain-plan fragment shown indicates a join between tables `emp_tab_reflist` and `emp_tab`.

To improve performance you can create an index on the REF values in the intermediate table, `emp_tab_reflist`. This lets Oracle XML DB query the address table, obtain an object reference (REF) to the relevant row, join it with the intermediate table storing the list of REF values, and join that table back with the employee table.

You can create an index on REF values only if the REF is *scoped* or has a referential constraint. A scoped REF column stores pointers only to objects in a particular table. The REF values in table `emp_tab_reflist` point only to objects in table `addr_tab`, so you can create a scope constraint and an index on the REF column, as shown in [Example 18-27](#) (page 18-45).

Example 18-23 Storing a Collection Out of Line

```

DECLARE
  doc VARCHAR2(3000) :=
    '<schema xmlns="http://www.w3.org/2001/XMLSchema"
          targetNamespace="http://www.oracle.com/emp.xsd"
          xmlns:emp="http://www.oracle.com/emp.xsd"

```

⁵⁵ XML Schema annotation `xdb:storeVarrayAsTable` is *deprecated*, starting with Oracle Database 12c Release 1 (12.1.0.1).

```

        xmlns:xdb="http://xmlns.oracle.com/xdb">
<complexType name="EmpType" xdb:SQLType="EMP_T">
  <sequence>
    <element name="Name" type="string"/>
    <element name="Age" type="decimal"/>
    <element name="Addr" xdb:SQLInline="false"
      maxOccurs="unbounded" xdb:defaultTable="ADDR_TAB">
      <complexType xdb:SQLType="ADDR_T">
        <sequence>
          <element name="Street" type="string"/>
          <element name="City" type="string"/>
        </sequence>
      </complexType>
    </element>
  </sequence>
</complexType>
<element name="Employee" type="emp:EmpType"
  xdb:defaultTable="EMP_TAB"/>
</schema>';
BEGIN
  DBMS_XMLSCHEMA.registerSchema(
    SCHEMAURL => 'emp.xsd',
    SCHEMADOC => doc,
    ENABLE_HIERARCHY => DBMS_XMLSCHEMA.ENABLE_HIERARCHY_NONE);
END;
/

```

Example 18-24 Generated Out-Of-Line Collection Type

```

DESCRIBE emp_t
emp_t is NOT FINAL
Name                               Null?   Type
-----
SYS_XDBPD$                          XDB.XDB$RAW_LIST_T
Name                                VARCHAR2(4000 CHAR)
Age                                  NUMBER
Addr                                XDB.XDB$XMLTYPE_REF_LIST_T

```

Example 18-25 Renaming an Intermediate Table of REF Values

```

DECLARE
  gen_name VARCHAR2 (4000);
BEGIN
  SELECT TABLE_NAME INTO gen_name FROM USER_NESTED_TABLES
    WHERE PARENT_TABLE_NAME = 'EMP_TAB';
  EXECUTE IMMEDIATE 'RENAME "' || gen_name || '" TO emp_tab_reflist';
END;
/

```

```

DESCRIBE emp_tab_reflist
Name                               Null?   Type
-----
COLUMN_VALUE                       REF OF XMLTYPE

```

Example 18-26 XPath Rewrite for an Out-Of-Line Collection

```

SELECT em.name, ad.street
FROM emp_tab,
  XMLTable(XMLNAMESPACES ('http://www.oracle.com/emp.xsd' AS "x"),
    '/x:Employee' PASSING OBJECT_VALUE
    COLUMNS name  VARCHAR2(20) PATH 'Name') em,
  XMLTable(XMLNAMESPACES ('http://www.oracle.com/emp.xsd' AS "x"),

```

```

'/x:Employee/Addr' PASSING OBJECT_VALUE
COLUMN street VARCHAR2(20) PATH 'Street',
        city VARCHAR2(20) PATH 'City') ad
WHERE ad.city = 'San Francisco';
    
```

NAME	STREET
Abe Bee	A Street
Eve Fong	E Street
George Hu	G Street
Iris Jones	I Street
Karl Luomo	K Street
Marina Namur	M Street
Omar Pinano	O Street
Quincy Roberts	Q Street

8 rows selected.

4	TABLE ACCESS FULL	EMP_TAB_REFLIST	32	640	2 (0)	00:00:01
5	TABLE ACCESS BY INDEX ROWID	EMP_TAB	1	29	1 (0)	00:00:01
* 6	INDEX UNIQUE SCAN	SYS_C005567	1		0 (0)	00:00:01

Example 18-27 XPath Rewrite for an Out-Of-Line Collection, with Index on REFs

```

ALTER TABLE emp_tab_reflist ADD SCOPE FOR (COLUMN_VALUE) IS addr_tab;
CREATE INDEX reflist_idx ON emp_tab_reflist (COLUMN_VALUE);
    
```

The explain-plan fragment for the same query as in [Example 18-26](#) (page 18-44) shows that index `reflist_idx` is picked up.

4	TABLE ACCESS BY INDEX ROWID	EMP_TAB_REFLIST	1	20	1 (0)	00:00:01
* 5	INDEX RANGE SCAN	REFLIST_IDX	1		0 (0)	00:00:01
6	TABLE ACCESS BY INDEX ROWID	EMP_TAB				
* 7	INDEX UNIQUE SCAN	SYS_C005567	1		0 (0)	00:00:01

18.9 Considerations for Working with Complex or Large XML Schemas

XML schemas can be complex. Examples of complex schemas include those that are recursive and those that contain circular or cyclical references. Working with complex or large XML schemas can be challenging and requires taking certain considerations into account.

18.9.1 Circular and Cyclical Dependencies Among XML Schemas

The W3C XML Schema Recommendation lets `complexType`s and global elements contain recursive references. This kind of structure allows for instance documents where the element in question can appear an infinite number of times in a recursive hierarchy.

For example, a `complexType` definition can *contain* an element based on that same `complexType`, or a global element can contain a reference to itself. In both cases the reference can be direct or indirect.

Example 18-28 An XML Schema with Circular Dependency

```

<?xml version="1.0" encoding="UTF-8"?>
<xs:schema xmlns:xs="http://www.w3.org/2001/XMLSchema"
           xmlns:xdb="http://xmlns.oracle.com/xdb"
           elementFormDefault="qualified" attributeFormDefault="unqualified">
  <xs:element name="person" type="personType" xdb:defaultTable="PERSON_TABLE"/>
  <xs:complexType name="personType" xdb:SQLType="PERSON_T">
    
```

```

<xs:sequence>
  <xs:element name="descendant" type="personType" minOccurs="0"
    maxOccurs="unbounded" xdb:SQLName="DESCENDANT"
    xdb:defaultTable="DESCENDANT_TABLE"/>
</xs:sequence>
<xs:attribute name="personName" use="required" xdb:SQLName="PERSON_NAME">
  <xs:simpleType>
    <xs:restriction base="xs:string">
      <xs:maxLength value="20"/>
    </xs:restriction>
  </xs:simpleType>
</xs:attribute>
</xs:complexType>
</xs:schema>
    
```

The XML schema in [Example 18-28](#) (page 18-45) includes a circular dependency. The complexType `personType` consists of a `personName` attribute and a collection of descendant elements. The descendant element is defined as being of type `personType`.

18.9.1.1 For Circular XML Schema Dependencies Set Parameter GENTABLES to TRUE

Oracle XML DB supports XML schemas that involve circular schema dependencies. It does this by detecting the cycles, breaking them, and storing the recursive elements as rows in a separate XMLType table that is created during XML schema registration.

Consequently, it is important to ensure that parameter `GENTABLES` is set to `TRUE` when registering an XML schema that defines this kind of structure. The name of the table used to store the recursive elements can be specified by adding an `xdb:defaultTable` annotation to the XML schema.

18.9.1.2 complexType Declarations in XML Schema: Handling Cycles

SQL object types do not allow cycles. Cycles in an XML schema are broken while generating the object types, by introducing a `REF` attribute where the cycle would be completed. Part of the data is stored out of line, but it is retrieved as part of the parent XML document.

Note:

Starting with Oracle Database 11g Release 2 (11.2.0.2), you can create only *one* XMLType table that uses an XML schema that results in an *out-of-line* table. An error is raised if you try to create a second table that uses the same XML schema.

XML schemas permit cycling between definitions of complex types. [Figure 18-3](#) (page 18-47) shows this, where the definition of complex type `CT1` can reference another complex type `CT2`, whereas the definition of `CT2` references the first type `CT1`.

XML schemas permit cycles among definitions of complex types. [Example 18-29](#) (page 18-48) creates a cycle of length two:

SQL types do not allow cycles in type definitions. However, they do support **weak cycles**, that is, cycles involving `REF` (reference) object attributes. Cyclic XML schema definitions are mapped to SQL object types in such a way that cycles are avoided by forcing `SQLInline = "false"` at the appropriate points. This creates a weak SQL cycle.

For the XML schema of [Example 18-29](#) (page 18-48), Oracle XML DB generates the following types:

```
CREATE TYPE ct1 AS OBJECT (SYS_XDBPD$ XDB.XDB$RAW_LIST_T,
                          "e1"      VARCHAR2(4000),
                          "e2"      REF XMLType) NOT FINAL;
CREATE TYPE ct2 AS OBJECT (SYS_XDBPD$ XDB.XDB$RAW_LIST_T,
                          "e1"      VARCHAR2(4000),
                          "e2"      CT1) NOT FINAL;
```

Figure 18-3 Cross Referencing Between Different complexTypes in the Same XML Schema

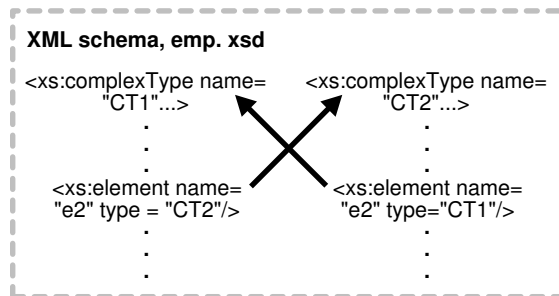

Another example of a cyclic complex type involves the declaration of the complex type that refers to itself. In [Example 18-30](#) (page 18-48), type `SectionT` does this.

For the XML schema of [Example 18-30](#) (page 18-48), Oracle XML DB generates the following types:

```
CREATE TYPE body_coll AS VARRAY(327676) OF VARCHAR2(3276711);
CREATE TYPE section_t AS OBJECT (SYS_XDBPD$ XDB.XDB$RAW_LIST_T,
                                "title"    VARCHAR2(3276711),
                                "body"     BODY_COLL,
                                "section"  XDB.XDB$REF_LIST_T) NOT FINAL;
```

Note:

In [Example 18-30](#) (page 18-48), object attribute `section` is declared as a varray of REF references to XMLType instances. Because there can be more than one occurrence of embedded sections, the attribute is a varray. It is a varray of REF references to XMLType instances, to avoid forming a cycle of SQL objects.

[Figure 18-4](#) (page 18-48) illustrates schematically how a complexType can reference itself.

⁶ This value of 32767 assumes that the value of initialization parameter `MAX_STRING_SIZE` is `EXTENDED`. See *Oracle Database SQL Language Reference*.

Figure 18-4 Self-Referencing Complex Type within an XML Schema

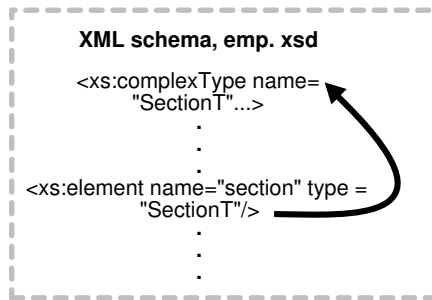

See Also:

[Cyclical References Among XML Schemas](#) (page 18-49)

Example 18-29 XML Schema: Cycling Between complexTypes

```

DECLARE
  doc VARCHAR2(3000) :=
    '<xs:schema xmlns:xs="http://www.w3.org/2001/XMLSchema"
      xmlns:xdb="http://xmlns.oracle.com/xdb">
      <xs:complexType name="CT1" xdb:SQLType="CT1">
        <xs:sequence>
          <xs:element name="e1" type="xs:string"/>
          <xs:element name="e2" type="CT2"/>
        </xs:sequence>
      </xs:complexType>
      <xs:complexType name="CT2" xdb:SQLType="CT2">
        <xs:sequence>
          <xs:element name="e1" type="xs:string"/>
          <xs:element name="e2" type="CT1"/>
        </xs:sequence>
      </xs:complexType>
    </xs:schema>';
BEGIN
  DBMS_XMLSCHEMA.registerSchema(
    SCHEMAURL => 'http://www.oracle.com/emp.xsd',
    SCHEMADOC => doc);
END;
    
```

Example 18-30 XML Schema: Cycling Between complexTypes, Self-Reference

```

DECLARE
  doc VARCHAR2(3000) :=
    '<xs:schema xmlns:xs="http://www.w3.org/2001/XMLSchema"
      xmlns:xdb="http://xmlns.oracle.com/xdb">
      <xs:complexType name="SectionT" xdb:SQLType="SECTION_T">
        <xs:sequence>
          <xs:element name="title" type="xs:string"/>
          <xs:choice maxOccurs="unbounded">
            <xs:element name="body" type="xs:string"
              xdb:SQLCollType="BODY_COLL"/>
            <xs:element name="section" type="SectionT"/>
          </xs:choice>
        </xs:sequence>
      </xs:complexType>
    </xs:schema>';
BEGIN
    
```

```

DBMS_XMLSCHEMA.registerSchema(
  SCHEMAURL => 'http://www.oracle.com/section.xsd',
  SCHEMADOC => doc);
END;
    
```

18.9.1.3 Cyclical References Among XML Schemas

XML schemas can depend on each other in such a way that they cannot be registered one after the other in the usual manner.

This is illustrated in [Figure 18-5](#) (page 18-49).

In the top half of the illustration, an example of indirect cyclical references between three XML schemas is shown.

In the bottom half of the illustration, an example of cyclical dependencies between two XML schemas is shown. The details of this simpler example are presented first.

Figure 18-5 Cyclical References Between XML Schemas

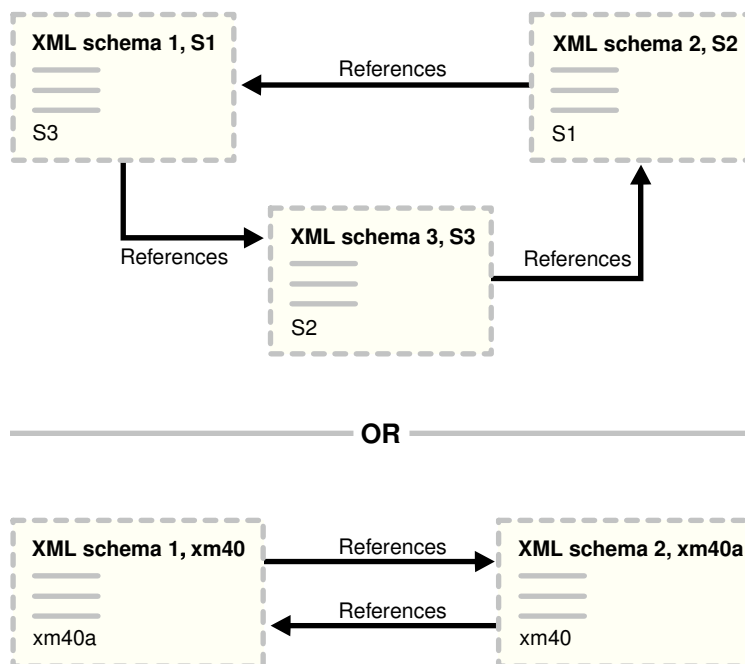

An XML schema that includes another XML schema cannot be created if the included XML schema does not exist. The registration of XML schema `xm40.xsd` in [Example 18-31](#) (page 18-50) fails, if `xm40a.xsd` does not exist.

XML schema `xm40.xsd` can, however, be created if you specify option `FORCE => TRUE`, as in [Example 18-32](#) (page 18-50):

However, an attempt to use XML schema `xm40.xsd`, as in [Example 18-33](#) (page 18-50), fails.

If you register `xm40a.xsd` using the `FORCE` option, as in [Example 18-34](#) (page 18-51), then both XML schemas can be used, as shown by the `CREATE TABLE` statements.

Thus, to register these XML schemas, which depend on each other, you must use the `FORCE` parameter in `DBMS_XMLSCHEMA.registerSchema` for each schema, as follows:

1. Register `xm40.xsd` with `FORCE` mode set to `TRUE`:

```

DBMS_XMLSCHEMA.registerSchema("xm40.xsd", "<schema ...", ..., FORCE => TRUE)
    
```

At this point, `xm40.xsd` *cannot* be used.

2. Register `xm40a.xsd` in FORCE mode set to TRUE:

```
DBMS_XMLSCHEMA.registerSchema("xm40a.xsd", "<schema ...", ..., FORCE => TRUE)
```

The second operation automatically compiles `xm40.xsd` and makes both XML schemas usable.

Example 18-31 An XML Schema that Includes a Non-Existent XML Schema

```
BEGIN DBMS_XMLSCHEMA.registerSchema(
  SCHEMAURL => 'xm40.xsd',
  SCHEMADOC => '<schema xmlns="http://www.w3.org/2001/XMLSchema"
               xmlns:my="xm40"
               targetNamespace="xm40">
               <include schemaLocation="xm40a.xsd"/>
               <!-- Define a global complextype here -->
               <complexType name="Company">
                 <sequence>
                   <element name="Name" type="string"/>
                   <element name="Address" type="string"/>
                 </sequence>
               </complexType>
               <!-- Define a global element depending on included schema -->
               <element name="Emp" type="my:Employee"/>
             </schema>',
  LOCAL      => TRUE,
  GENTYPES   => TRUE,
  GENTABLES  => TRUE);
END;
/
```

Example 18-32 Using the FORCE Option to Register XML Schema `xm40.xsd`

```
BEGIN DBMS_XMLSCHEMA.registerSchema(
  SCHEMAURL => 'xm40.xsd',
  SCHEMADOC => '<schema xmlns="http://www.w3.org/2001/XMLSchema"
               xmlns:my="xm40"
               targetNamespace="xm40">
               <include schemaLocation="xm40a.xsd"/>
               <!-- Define a global complextype here -->
               <complexType name="Company">
                 <sequence>
                   <element name="Name" type="string"/>
                   <element name="Address" type="string"/>
                 </sequence>
               </complexType>
               <!-- Define a global element depending on included schema -->
               <element name="Emp" type="my:Employee"/>
             </schema>',
  LOCAL      => TRUE,
  GENTYPES   => TRUE,
  GENTABLES  => TRUE,
  FORCE       => TRUE);
END;
/
```

Example 18-33 Trying to Create a Table Using a Cyclic XML Schema

```
CREATE TABLE foo OF XMLType XMLSCHEMA "xm40.xsd" ELEMENT "Emp";
```

Example 18-34 Using the FORCE Option to Register XML Schema xm40a.xsd

```

BEGIN DBMS_XMLSCHEMA.registerSchema(
  SCHEMAURL => 'xm40a.xsd',
  SCHEMADOC => '<schema xmlns="http://www.w3.org/2001/XMLSchema"
               xmlns:my="xm40"
               targetNamespace="xm40">
               <include schemaLocation="xm40.xsd"/>
               <!-- Define a global complextype here -->
               <complexType name="Employee">
                 <sequence>
                   <element name="Name" type="string"/>
                   <element name="Age" type="positiveInteger"/>
                   <element name="Phone" type="string"/>
                 </sequence>
               </complexType>
               <!-- Define a global element depending on included schema -->
               <element name="Comp" type="my:Company"/>
             </schema>',
  LOCAL      => TRUE,
  GENTYPES   => TRUE,
  GENTABLES  => TRUE,
  FORCE       => TRUE);
END;
/

CREATE TABLE foo OF XMLType XMLSCHEMA "xm40.xsd" ELEMENT "Emp";
CREATE TABLE foo2 OF XMLType XMLSCHEMA "xm40a.xsd" ELEMENT "Comp";

```

18.9.2 Support for Recursive Schemas

A REF to a recursive structure in an out-of-line table can make it difficult to rewrite XPath queries, because it is not known at compile time how deep the structure is. To enable XPath rewrite, a DOCID column points back to the root document in any recursive structure.

This enables some XPath queries to use the out-of-line tables directly and join back using this column.

A **document-correlated recursive query** is a query using a SQL function that accepts an XPath or XQuery expression and an XMLType instance, where that XPath or XQuery expression contains '//'. A document-correlated recursive query can be *rewritten* if it can be determined at query compilation time that both of the following conditions are met:

- All fragments of the XMLType instance that are targeted by the XPath or XQuery expression reside in a single out-of-line table.
- No other fragments of the XMLType instance reside in the same out-of-line table.

The rewritten query is a join with the out-of-line table, based on the DOCID column.

Other queries with '/' can also be rewritten. For example, if there are several address elements, all of the same type, in different sections of a schema, and you often query all address elements with '/', not caring about their specific location in the document, rewrite can occur.

During schema registration, an additional DOCID column is generated for out-of-line XMLType tables. This column stores the OID (Object Identifier Values) of the document, that is, the root element. This column is automatically populated when data

is inserted in the tables. You can export tables containing DOCID columns and import them later.

Example 18-35 Recursive XML Schema

```
<schema targetNamespace="AbcNS" xmlns="http://www.w3.org/2001/XMLSchema"
        xmlns:abc="AbcNS" xmlns:xdb="http://xmlns.oracle.com/xdb">
  <element name="AbcCode" xdb:defaultTable="ABCCODETAB">
    <complexType>
      <sequence>
        <element ref="abc:AbcSection"/>
      </sequence>
    </complexType>
  </element>

  <element name="AbcSection">
    <complexType>
      <sequence>
        <element name="ID" type="integer"/>
        <element name="Contents" type="string"/>
        <element ref="abc:AbcSection"/>
      </sequence>
    </complexType>
  </element>
</schema>
```

18.9.2.1 defaultTable Shared Among Common Out-Of-Line Elements

Out-of-line elements of the same qualified name (namespace and local name) and same type are stored in the same default table. As a special case, you can store the root element of a cyclic element structure out of line in the same table as the sub-elements.

Both of the elements sharing the default table must be out-of-line elements, that is, the default table for an out-of-line element cannot be the same as the table for a top-level element. To do this, specify `xdb:SQLInline = "false"` for both elements and specify an explicit `xdb:defaultTable` attribute having the same value in both elements.

[Example 18-36](#) (page 18-52) shows an XML schema with an out-of-line table that is stored in ABCSECTIONTAB.

Both of the out-of-line `AbcSection` elements in [Example 18-36](#) (page 18-52) share the same default table, ABCSECTIONTAB.

However, [Example 18-37](#) (page 18-53) illustrates *invalid* default table sharing: recursive elements (`XyzSection`) do not share the same out-of-line table.

The following query cannot be rewritten.

```
SELECT XMLQuery('//XyzSection' PASSING OBJECT_VALUE RETURNING CONTENT)
       FROM xyzcode;
```

Example 18-36 Out-of-line Table

```
<schema targetNamespace="AbcNS" xmlns="http://www.w3.org/2001/XMLSchema"
        xmlns:abc="AbcNS" xmlns:xdb="http://xmlns.oracle.com/xdb">
  <element name="AbcCode" xdb:defaultTable="ABCCODETAB">
    <complexType>
      <sequence>
        <element ref="abc:AbcSection" xdb:SQLInline="false"/>
      </sequence>
    </complexType>
  </element>
```

```

<element name="AbcSection" xdb:defaultTable="">
  <complexType>
    <sequence>
      <element name="ID" type="integer"/>
      <element name="Contents" type="string"/>
      <element ref="abc:AbcSection" xdb:SQLInline="false"
        xdb:defaultTable="ABCSECTIONTAB"/>
    </sequence>
  </complexType>
</element>
</schema>
    
```

Example 18-37 Invalid Default Table Sharing

```

<schema targetNamespace="XyzNS" xmlns="http://www.w3.org/2001/XMLSchema"
  xmlns:xyz="XyzNS" xmlns:xdb="http://xmlns.oracle.com/xdb">
  <element name="XyzCode" xdb:defaultTable="XYZCODETAB">
    <complexType>
      <sequence>
        <element name="CodeNumber" type="integer" minOccurs="0"/>
        <element ref="xyz:XyzChapter" xdb:SQLInline="false"/>
        <element ref="xyz:XyzPara" xdb:SQLInline="false" />
      </sequence>
    </complexType>
  </element>

  <element name="XyzChapter" xdb:defaultTable="XYZCHAPTAB">
    <complexType>
      <sequence>
        <element name="Title" type="string"/>
        <element ref="xyz:XyzSection" xdb:SQLInline="false"
          xdb:defaultTable="XYZSECTIONTAB"/>
      </sequence>
    </complexType>
  </element>

  <element name="XyzPara" xdb:defaultTable="XYZPARATAB">
    <complexType>
      <sequence>
        <element name="Title" type="string"/>
        <element ref="xyz:XyzSection" xdb:SQLInline="false"
          xdb:defaultTable="Other_XYZSECTIONTAB"/>
      </sequence>
    </complexType>
  </element>

  <element name="XyzSection">
    <complexType>
      <sequence>
        <element name="ID" type="integer"/>
        <element name="Contents" type="string"/>
        <element ref="xyz:XyzSection" xdb:defaultTable="XYZSECTIONTAB"/>
      </sequence>
    </complexType>
  </element>
</schema>
    
```

18.9.2.2 Query Rewrite when DOCID is Present

Before processing // XPath expressions, check to find multiple occurrences of the same element. If all occurrences under the // share the same defaultTable then the query can be rewritten against that table, using the DOCID.

If there are other occurrences of the same element under the root sharing that table, but not under //, then the query cannot be rewritten.

For example, consider this element structure:

<Book> contains a <Chapter> and a <Part>. <Part> contains a <Chapter>.

Assume that both of the <Chapter> elements are stored out of line and they share the same default table. The query /Book//Chapter can be rewritten to go against the default table for the <Chapter> elements because all of the <Chapter> elements under <Book> share the same default table. Thus, this XPath query is a document-correlated recursive XPath query.

However, a query such as /Book/Part//Chapter cannot be rewritten, even though all the <Chapter> elements under <Part> share the same table, because there is another <Chapter> element under <Book>, which is the document root that also shares that table.

Consider the case where you are extracting //AbcSection with DOCID present, as in the XML schema described in [Example 18-36](#) (page 18-52):

```
SELECT XMLQuery('//AbcSection' PASSING OBJECT_VALUE RETURNING CONTENT)
FROM abccodetab;
```

Both of the AbcSection elements are stored in the same table, abcsectiontab. The extraction applies to the underlying table, abcsectiontab.

Consider this query when DOCID is present:

```
SELECT XMLQuery('/AbcCode/AbcSection//AbcSection'
PASSING OBJECT_VALUE RETURNING CONTENT)
FROM abccodetab;
```

In both this case and the previous case, all reachable AbcSection elements are stored in the same out-of-line table. However, the first AbcSection element at /AbcCode/AbcSection cannot be retrieved by this query. Since the join condition is a DOCID, which cannot distinguish between different positions in the parent document, the correct result cannot be achieved by a direct query on table abcsectiontab. In this case, query rewrite does not occur since it is not a document-correlated recursive XPath. If this top-level AbcSection were not stored out of line with the rest, then the query could be rewritten.

18.9.2.3 DOCID Column Creation Disabling

You can disable the creation of column DOCID by specifying an OPTIONS parameter when calling DBMS_XMLSCHEMA.registerSchema. This disables DOCID creation in all XMLType tables generated during schema registration.

OPTIONS is an input parameter of data type PLS_INTEGER. Its default value is 0, meaning that no options are used. To inhibit the generation of column DOCID, set parameter OPTIONS to DBMS_XMLSCHEMA.REGISTER_NODOCID (which is 1).

See Also:

Oracle Database PL/SQL Packages and Types Reference

18.9.3 XML Fragments Can Be Mapped to Large Objects (LOBs)

You can specify the SQL data type to use for a complex element as being CLOB or BLOB.

In [Figure 18-6](#) (page 18-55), for example, an entire XML fragment is stored in a LOB attribute.

In [Example 18-38](#) (page 18-55), the XML schema defines element `Addr` using the annotation `SQLType = "CLOB"`:

Figure 18-6 Mapping complexType XML Fragments to CLOB Instances

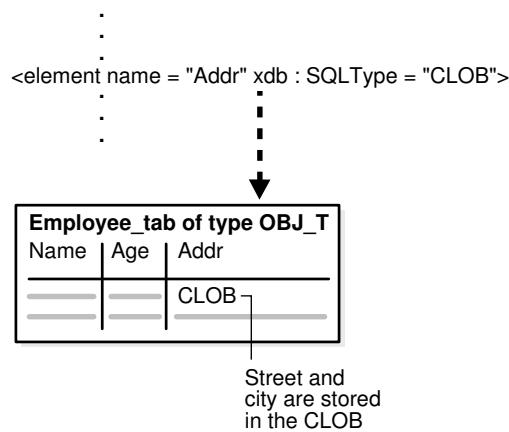

Example 18-38 Oracle XML DB XML Schema: Mapping complexType XML Fragments to LOBs

```

DECLARE
  doc VARCHAR2(3000) :=
    '<schema xmlns="http://www.w3.org/2001/XMLSchema"
      targetNamespace="http://www.oracle.com/emp.xsd"
      xmlns:emp="http://www.oracle.com/emp.xsd"
      xmlns:xdb="http://xmlns.oracle.com/xdb">
    <complexType name="Employee" xdb:SQLType="OBJ_T">
      <sequence>
        <element name="Name" type="string"/>
        <element name="Age" type="decimal"/>
        <element name="Addr" xdb:SQLType="CLOB">
          <complexType >
            <sequence>
              <element name="Street" type="string"/>
              <element name="City" type="string"/>
            </sequence>
          </complexType>
        </element>
      </sequence>
    </complexType>
  </schema>';
BEGIN
  DBMS_XMLSCHEMA.registerSchema(
    SCHEMAURL => 'http://www.oracle.com/PO.xsd',

```

```
SCHEMADOC => doc);
END;
```

When registering this XML schema, Oracle XML DB generates the following types and `XMLType` tables:

```
CREATE TYPE obj_t AS OBJECT(SYS_XDBPD$ XDB.XDB$RAW_LIST_T,
                           Name VARCHAR2(4000),
                           Age NUMBER,
                           Addr CLOB);
```

18.9.4 ORA-01792 and ORA-04031: Issues with Large XML Schemas

Errors ORA-01792 and ORA-04031 can be raised when you work with large or complex XML schemas. You can encounter them when you register an XML schema or you create a table that is based on a global element defined by an XML schema.

- ORA-01792: maximum number of columns in a table or view is 1000
- ORA-04031: unable to allocate *string* bytes of shared memory ("*string*", "*string*", "*string*", "*string*")

These errors are raised when you try to create an `XMLType` table or column based on a global element and the global element is defined as a `complexType` that contains a very large number of element and attribute definitions.

They are raised only when creating an `XMLType` table or column that uses object-relational storage. The table or column is persisted using a SQL type, and each object attribute defined by the SQL type counts as one column in the underlying table. If the SQL type contains object attributes that are based on other SQL types, then the attributes defined by those types also count as columns in the underlying table.

If the total number of object attributes in all of the SQL types exceeds the Oracle Database limit of 1000 columns in a table, then the storage table cannot be created. When the total number of elements and attributes defined by a `complexType` reaches 1000, it is not possible to create a single table that can manage the SQL objects that are generated when an instance of that type is stored in the database.

Tip:

You can use the following query to determine the number of columns for a given `XMLType` table stored object-relationally:

```
SELECT count(*) FROM USER_TAB_COLS WHERE TABLE_NAME = '<the table>'
```

where *<the table>* is the table you want to check.

Error ORA-01792 reports that the 1000-column limit has been exceeded. Error ORA-04031 reports that memory is insufficient during the processing of a large number of element and attribute definitions. To resolve this problem of having too many element and attribute definitions, you must reduce the total number of object attributes in the SQL types that are used to create the storage tables.

There are two ways to achieve this reduction:

- Use a top-down technique, with *multiple XMLType tables* that manage the XML documents. This reduces the number of SQL attributes in the SQL type hierarchy for a given storage table. As long as none of the tables need to manage more than 1000 object attributes, the problem is resolved.

- Use a bottom-up technique, which reduces the number of SQL attributes in the SQL type hierarchy, *collapsing some elements and attributes* defined by the XML schema so that they are stored as a single CLOB value.

Both techniques rely on annotating the XML schema to define how a particular `complexType` is stored in the database.

For the top-down technique, annotations `SQLInline = "false"` and `defaultTable` force some subelements in the XML document to be stored as rows in a separate `XMLType` table. Oracle XML DB maintains the relationship between the two tables using a `REF` of `XMLType`. Good candidates for this approach are XML schemas that do either of the following:

- Define a *choice*, where each element within the choice is defined as a `complexType`
- Define an element based on a `complexType` that contains a *large number of element and attribute definitions*

The bottom-up technique involves reducing the total number of attributes in the SQL object types by choosing to store some of the lower-level `complexType` elements as CLOB values, rather than as objects. This is achieved by annotating the `complexType` or the usage of the `complexType` with `SQLType = "CLOB"`.

Which technique you use depends on the application and the type of queries and updates to be performed against the data.

18.9.5 Considerations for Loading and Retrieving Large Documents with Collections

Oracle XML DB configuration file `xdbconfig.xml` has parameters that control the amount of memory used by the loading operation: `xdbcore-loadableunit-size` and `xdbcore-xobmem-bound`.

These let you optimize the loading process, provided the following conditions are met:

- The document is loaded using one of the following:
 - Protocols (FTP, HTTP(S), or DAV)
 - PL/SQL function `DBMS_XDB_REPOS.createResource`
 - A SQL `INSERT` statement into an `XMLType` table (but not an `XMLType` column)
- The document is XML schema-based and contains large collections (elements with `maxOccurs` set to a large number).
- Collections in the document are stored as OCTs. This is the default behavior.

In the following situations, the optimizations are sometimes suboptimal:

- When there are triggers on the base table.
- When the base table is partitioned.
- When collections are stored out of line (applies only to SQL `INSERT`).

The basic idea behind this optimization is that it lets the collections be swapped into or out of the memory in bounded sizes. As an illustration of this idea consider the following example conforming to a purchase-order XML schema:

```
<PurchaseOrder>
  <LineItem itemID="1">
    ...
```

```

    </LineItem>
    .
    .
    <LineItem itemID="10240">
    ...
    </LineItem>
</PurchaseOrder>

```

The purchase-order document here contains a collection of 10240 `LineItem` elements. Creating the entire document in memory and then pushing it out to disk can lead to excessive memory usage and in some instances a load failure due to inadequate system memory.

To avoid that, you can create the documents in finite chunks of memory called **loadable units**.

In the example case, assume that each line item needs 1 KB of memory and that you want to use loadable units of 512 KB each. Each loadable unit then contains 512 line items, and there are approximately 20 such units. If you want the entire memory representation of the document to never exceed 2 MB, then you must ensure that at any time no more than 4 loadable units are maintained in the memory. You can use an LRU mechanism to swap out the loadable units.

By controlling the size of the loadable unit and the bound on the size of the document you can tune the memory usage and performance of the load or retrieval. Typically a larger loadable unit size translates into a smaller number of disk accesses, but it requires more memory. This is controlled by configuration parameter `xdbc_core-loadableunit-size`, whose default value is 16 KB. You can indicate the amount of memory to be given to a document by setting parameter `xdbc_core-xobmem-bound`, which defaults to 1 MB. The values of these parameters are specified in kilobytes. So, the default value of `xdbc_core-xobmem-bound` is 1024 and that of `xdbc_core-loadableunit-size` is 16. These are soft limits that provide some guidance to the system about how to use the memory optimally.

When a document is loaded using FTP, the pattern in which the loadable units (LU) are created and flushed to the disk is as follows:

```

No LUs
Create LU1[LineItems(LI):1-512]
LU1[LI:1-512], Create LU2[LI:513-1024]
.
.
LU1[LI:1-512],...Create LU4[LI:1517-2028] <- Total memory size = 2M
Swap Out LU1[LI:1-512], LU2[LI:513-1024],...LU4[LI:1517-2028], Create LU5[LI:
2029-2540]
Swap Out LU2[LI:513-1024], LU3, LU4, LU5, Create LU6[LI:2541-2052]
.
.
.
Swap Out LU16, LU17, LU18, LU10, Create LU20[LI:9729-10240]
Flush LU17,LU18,LU19,LU20

```

18.9.5.1 Guidelines for Configuration Parameters `xdbc_core-loadableunit-size` and `xdbc_core-xobmem-bound`

Use PGA size and trial and error to determine the best values for configuration parameters `xdbc_core-loadableunit-size` and `xdbc_core-xobmem-bound`.

Typically, if you have 1 GB of addressable PG then give about 1/10th of PGA to the document. Set `xobcore-xobmem-bound` to 1/10 of addressable PGA, which is 100M.

During full document retrievals and loads, the value of `xdbcore-loadableunit-size` should be as close as possible to the value of `xobcore-xobmem-bound`.

Start by setting `xdbcore-loadableunit-size` to half the value of `xdbcore-xobmem-bound` (50 MB). Then try to load the document.

If you run out of memory then reduce the value of `xdbcore-xobmem-bound` and set `xdbcore-loadableunit-size` to half of that value. Continue this way until the documents load successfully.

If the load operation succeeds then try to increase `xdbcore-loadableunit-size`, to obtain better performance. If `xdbcore-loadableunit-size` equals `xdbcore-xobmem-bound`, then try to increase both parameter values for further performance improvements.

18.10 Debugging XML Schema Registration for XML Data Stored Object-Relationally

For XML data stored object-relationally, you can monitor the object types and tables created during XML schema registration by setting the event 31098 before invoking PL/SQL procedure `DBMS_XMLSCHEMA.registerSchema`.

```
ALTER SESSION SET EVENTS = '31098 TRACE NAME CONTEXT FOREVER'
```

Setting this event causes the generation of a log of all of the `CREATE TYPE` and `CREATE TABLE` statements. The log is written to the user session trace file, typically found in `ORACLE_BASE/diag/rdbms/ORACLE_SID/ORACLE_SID/udump`. This trace output can be a useful aid in diagnosing problems during XML schema registration.

XPath Rewrite for Object-Relational Storage

For `XMLType` data stored object-relationally, queries involving XPath expression arguments to various SQL functions can often be automatically rewritten to queries against the underlying SQL tables, which are highly optimized.

- [Overview of XPath Rewrite for Object-Relational Storage](#) (page 19-1)
- [Common XPath Expressions that Are Rewritten](#) (page 19-2)
- [Guidelines for Using Execution Plans to Analyze and Optimize XPath Queries](#) (page 19-4)

See Also:

[Performance Tuning for XQuery](#) (page 5-40)

19.1 Overview of XPath Rewrite for Object-Relational Storage

Oracle XML DB can often optimize queries that use XPath expressions — for example, queries involving SQL functions such as `XMLQuery`, `XMLTable`, and `XMLExists`, which take XPath (XQuery) expressions as arguments. The XPath expression is, in effect, evaluated against the XML document without ever constructing the XML document in memory.

This optimization is called **XPath rewrite**. It is a proper subset of XML query optimization, which also involves optimization of XQuery expressions, such as FLWOR expressions, that are not XPath expressions. XPath rewrite also enables indexes, if present on the column, to be used in query evaluation by the Optimizer.

The XPath expressions that can be rewritten by Oracle XML DB are a proper subset of those that are supported by Oracle XML DB. Whenever you can do so without losing functionality, use XPath expressions that can be rewritten.

XPath rewrite can occur in these contexts (or combinations thereof):

- When `XMLType` data is stored in an object-relational column or table or when an `XMLType` view is built on relational data.

See Also:

- [Relational Views over XML Data](#) (page 9-1)
 - [XMLType Views](#) (page 10-1)
 - [Indexing XMLType Data Stored Object-Relationally](#) (page 6-62)
-
-

- When you use an `XMLIndex` index.

See Also:

[XMLIndex](#) (page 6-7)

The first case, rewriting queries that use object-relational XML data or `XMLType` views, is covered here. The `XMLType` views can be XML schema-based or not. Object-relational storage of `XMLType` data is always XML schema-based. Examples in this chapter are related to XML schema-based tables.

When XPath rewrite is possible for object-relational XML data, the database optimizer can derive an execution plan based on conventional relational algebra. This in turn means that Oracle XML DB can leverage all of the features of the database and ensure that SQL statements containing XQuery and XPath expressions are executed in a highly performant and efficient manner. There is little overhead with this rewriting, so Oracle XML DB executes XQuery-based and XPath-based queries at near-relational speed.

In certain cases, XPath rewrite is not possible. This typically occurs when there is no SQL equivalent of the XPath expression. In this situation, Oracle XML DB performs a functional evaluation of the XPath expressions, which is generally more costly, especially if the number of documents to be processed is large.

[Example 19-1](#) (page 19-2) illustrates XPath rewrite for a simple query that uses an XPath expression.

See Also:

[XML Schema Annotation Guidelines for Object-Relational Storage](#)
(page 18-16)

Example 19-1 XPath Rewrite

```
SELECT po.OBJECT_VALUE FROM purchaseorder po
   WHERE XMLCast(XMLQuery('$p/PurchaseOrder/Requestor'
                          PASSING po.OBJECT_VALUE AS "p" RETURNING CONTENT)
                 AS VARCHAR2(128))
   = 'Sarah J. Bell';
```

The `XMLCast(XMLQuery...)` expression here is rewritten to the underlying relational column that stores the requestor information for the purchase order. The query is rewritten to something like the following:¹

```
SELECT OBJECT_VALUE FROM purchaseorder p
   WHERE CAST(p."XMLDATA"."REQUESTOR" AS VARCHAR2(128)) = 'Sarah J. Bell';
```

19.2 Common XPath Expressions that Are Rewritten

The most common XPath expressions that are rewritten during XPath rewrite are described.

¹ This example uses sample database schema OE and its table `purchaseorder`. The XML schema for this table is annotated with attribute `SQLName` to specify SQL object attribute names such as `REQUESTOR` — see [Example A-2](#) (page A-34). Without such annotations, this example would use `p."XMLDATA"."Requestor"`, not `p."XMLDATA"."REQUESTOR"`.

Table 19-1 (page 19-3) presents the descriptions

Table 19-1 Sample of XPath Expressions that Are Rewritten to Underlying SQL Constructs

XPath Expression for Translation	Description
Simple XPath expressions (expressions with <code>child</code> and <code>attribute</code> axes only): <code>/PurchaseOrder/@Reference</code> <code>/PurchaseOrder/Requestor</code>	Involves traversals over object type attributes only, where the attributes are simple scalar or object types themselves.
Collection traversal expressions: <code>/PurchaseOrder/LineItems/LineItem/Part/@Id</code>	Involves traversal of collection expressions. The only axes supported are <code>child</code> and <code>attribute</code> axes. Collection traversal is not supported if the SQL function is used during a <code>CREATE INDEX</code> operation.
Predicates: <code>[Requestor = "Sarah J. Bell"]</code>	Predicates in the XPath are rewritten into SQL predicates.
List index (positional predicate): <code>LineItem[1]</code>	Indexes are rewritten to access the <i>n</i> th item in a collection.
Wildcard traversals: <code>/PurchaseOrder/*/Part/@Id</code>	If the wildcard can be translated to one or more simple XPath expressions, then it is rewritten.
Descendant axis (XML schema-based data only), without recursion: <code>/PurchaseOrder//Part/@Id</code>	Similar to a wildcard expression. The <code>descendant</code> axis is rewritten if it can be mapped to one or more simple XPath expressions.
Descendant axis (XML schema-based data only), with recursion: <code>/PurchaseOrder//Part/@Id</code>	The <code>descendant</code> axis is rewritten if both of these conditions holds: <ul style="list-style-type: none"> All simple XPath expressions to which this XPath expression expands map to the same out-of-line table. Any simple XPath expression to which this XPath expression does not expand does not map to that out-of-line table.
XPath functions	Some XPath functions are rewritten. These functions include <code>not</code> , <code>floor</code> , <code>ceiling</code> , <code>substring</code> , and <code>string-length</code> .

See Also:

[Performance Tuning for XQuery](#) (page 5-40) for information about rewrite of XQuery expressions

19.3 XPath Rewrite for Out-Of-Line Tables

XPath expressions that involve elements stored out of line can be automatically rewritten. The rewritten query involves a join with the out-of-line table.

[Example 19-2](#) (page 19-4) shows such a query. The XQuery expression is rewritten to a SQL `EXISTS` subquery that queries table `addr_tab`, joining it with table `emp_tab` using the object identifier column in `addr_tab`. The optimizer uses full table scans of tables `emp_tab` and `addr_tab`. If there are many entries in the `addr_tab`, then you

can try to make this query more efficient by creating an index on the city, as shown in [Example 19-3](#) (page 19-4). An explain-plan fragment for the same query as in [Example 19-2](#) (page 19-4) shows that the city index is picked up.

Note:

When gathering statistics for the optimizer on an XMLType table that is stored object-relationally, Oracle recommends that you gather statistics on *all* of the tables defined by the XML schema, that is, all of the tables in USER_XML_TABLES. You can use procedure DBMS_STATS.gather_schema_stats to do this, or use DBMS_STATS.gather_table_stats on each such table. This informs the optimizer about all of the dependent tables that are used to store the XMLType data.

Example 19-2 XPath Rewrite for an Out-Of-Line Table

```
SELECT XMLCast(XMLQuery('declare namespace x = "http://www.oracle.com/emp.xsd"; (: :)
                        /x:Employee/Name' PASSING OBJECT_VALUE RETURNING CONTENT)
              AS VARCHAR2(20))
FROM emp_tab
WHERE XMLEExists('declare namespace x = "http://www.oracle.com/emp.xsd"; (: :)
                 /x:Employee/Addr[City="San Francisco"]' PASSING OBJECT_VALUE);
```

XMLCAST(XMLQUERY(...

```
-----
Abe Bee
Eve Fong
George Hu
Iris Jones
Karl Luomo
Marina Namur
Omar Pinano
Quincy Roberts
```

8 rows selected.

Example 19-3 Using an Index with an Out-Of-Line Table

```
CREATE INDEX addr_city_idx
ON addr_tab (extractValue(OBJECT_VALUE, '/Addr/City'));
```

	2		TABLE ACCESS BY INDEX ROWID		ADDR_TAB		1		2012		1		(0)		00:00:01		
	*	3		INDEX RANGE SCAN		ADDR_CITY_IDX		1				1		(0)		00:00:01	
		4		TABLE ACCESS FULL		EMP_TAB		16		32464		2		(0)		00:00:01	

19.4 Guidelines for Using Execution Plans to Analyze and Optimize XPath Queries

Guidelines are presented for using execution plans to analyze query execution in order to (a) determine whether XPath rewrite occurs and (b) optimize query execution by using secondary indexes. These guidelines apply only to XMLType data that is stored object-relationally.

Use these guidelines together, taking all that apply into consideration.

XPath rewrite for object-relational storage means that a query that selects XML fragments defined by an XPath expression is rewritten to a SQL SELECT statement on

the underlying object-relational tables and columns. These underlying tables can include out-of-line tables.

You can use PL/SQL procedure `DBMS_XMLSTORAGE_MANAGE.XPath2TabColMapping` to find the names of the underlying tables and columns that correspond to a given XPath expression.

See Also:

- [XPath Rewrite for Out-Of-Line Tables](#) (page 19-3)
 - *Oracle Database PL/SQL Packages and Types Reference* for information about procedure `XPath2TabColMapping`
-
-

19.4.1 Guideline: Look for underlying tables versus XML functions in execution plans

The execution plan of a query that is rewritten refers to the names of the object-relational tables and columns that underlie the queried `XMLType` data. These names can be meaningful to you if they are derived from XML element or attribute names or if XML Schema annotation `xdb:defaultTable` was used.

Otherwise, these names are system-generated and have no obvious meaning. In particular, they do not reflect the corresponding XML element or attribute names.

Also, some system-generated columns are generally hidden. You do not see them if you use the SQL `describe` command. They nevertheless show up in execution plans.

The plan of a query that has not been rewritten shows only the base table names, and it typically refers to user-level XML functions, such as `XMLExists`. Look for this difference to determine whether a query has been optimized. The XML function name shown in an execution plan is actually the internal name (for example, `XMLEXISTS2`), which is sometimes slightly different from the user-level name.

Example 19-4 (page 19-5) shows the kind of execution plan output that is generated when Oracle XML DB cannot perform XPath rewrite. The plan here is for a query that uses SQL/XML function `XMLExists`. The corresponding internal function `XMLExists2` appears in the plan output, indicating that the query is not rewritten.

In this situation, Oracle XML DB constructs a pre-filtered result set based on any other conditions specified in the query `WHERE` clause. It then filters the rows in this potential result set to determine which rows belong in the result set. The filtering is performed by *constructing a DOM on each document* and performing a **functional evaluation** using the methods defined by the DOM API to determine whether or not each document is a member of the result set.

Example 19-4 Execution Plan Generated When XPath Rewrite Does Not Occur

Predicate Information (identified by operation id):

```
-----
1 - filter(XMLEXISTS2('$p/PurchaseOrder[User="SBELL"]' PASSING BY VALUE
SYS_MAKEXML('61687B202644E297E040578C8A175C1D',4215,"PO"."XMLEXTRA","PO"."X
MLDATA") AS "p")=1)
```

19.4.2 Guideline: Name the object-relational tables, so you recognize them in execution plans

When designing an XML schema, use annotation `xdb:defaultTable` to name the underlying tables that correspond to elements that you select in queries where performance is important. This lets you easily recognize them in an execution plan, indicating by their presence or absence whether the query has been rewritten.

For collection tables, there is no corresponding XML schema annotation. To give user-friendly names to your collection tables you must first register the XML schema. Then you can use PL/SQL procedure

`DBMS_XMLSTORAGE_MANAGE.renameCollectionTable` to rename the tables that were created during registration, which have system-generated names.

See Also:

Oracle Database PL/SQL Packages and Types Reference for information about procedure `renameCollectionTable`

19.4.3 Guideline: Create an index on a column targeted by a predicate

You can sometimes improve the performance of a query that is rewritten to include a SQL predicate, by creating an index that applies to the column targeted by the predicate.

A query resulting from XPath rewrite sometimes includes a SQL predicate (`WHERE` clause). This can happen even if the original query does not use an XPath predicate, and it can happen even if the original query does not have a SQL `WHERE` clause.

When this happens, you can sometimes improve performance by creating an index on the column that is targeted by the SQL predicate, or by creating an index on a function application to that column.

[Example 19-1](#) (page 19-2) illustrates XPath rewrite for a query that includes a `WHERE` clause. [Example 19-5](#) (page 19-7) shows the predicate information from an execution plan for this query.

The predicate information indicates that the expression `XMLCast(XMLQuery...)` is rewritten to an application of SQL function `cast` to the underlying relational column that stores the requestor information for the purchase order, `SYS_NC0021$`. This column name is system-generated. The execution plan refers to this system-generated name, in spite of the fact that the governing XML schema uses annotation `SQLName` to name this column `REQUESTOR`.

Because these two names (user-defined and system-generated) refer to the same column, you can create a B-tree index on this column using either name. Alternatively, you can use the `extractValue` shortcut to create the index, by specifying an XPath expression that targets the purchase-order requestor data.

You can obtain the names of the underlying table and columns that correspond to a given XPath expression using procedure `DBMS_XMLSTORAGE_MANAGE.XPath2TabColMapping`. [Example 19-6](#) (page 19-7) illustrates this for the XPath expression `/PurchaseOrder/Requestor` used in the `WHERE` clause of [Example 19-1](#) (page 19-2).

If you provide an XPath expression that contains a wildcard or a descendent axis then multiple tables and columns might be selected. In that case procedure

XPath2TabColMapping returns multiple <Mapping> elements, one for each table-column pair.

You can then use the table and column names retrieved this way in a CREATE INDEX statement to create an index that corresponds to the XPath expression. [Example 19-7](#) (page 19-8) shows three equivalent ways to create a B-tree index on the predicate-targeted column.

However, for this particular query it makes sense to create a function-based index, using a functional expression that matches the one in the rewritten query. [Example 19-8](#) (page 19-8) illustrates this.

[Example 19-9](#) (page 19-8) shows an execution plan that indicates that the index is picked up.

In the particular case of this query, the original functional expression applies XMLCast to XMLQuery to target a singleton element, Requestor. This is a special case, where you can as a shortcut use such a functional expression directly in the CREATE INDEX statement. That statement is rewritten to create an index on the underlying scalar data. [Example 19-10](#) (page 19-8), which targets an XPath expression, thus has the same effect as [Example 19-8](#) (page 19-8), which targets the corresponding object-relational column.

See Also:

- [Indexing Non-Repeating Text Nodes or Attribute Values](#) (page 6-62) for information about using the shortcut of XMLCast applied to XMLQuery and the extractValue shortcut to index singleton data
 - *Oracle Database PL/SQL Packages and Types Reference* for information about procedure XPath2TabColMapping
-
-

Example 19-5 Analyzing an Execution Plan to Determine a Column to Index

Predicate Information (identified by operation id):

```
1 - filter(CAST("PURCHASEORDER"."SYS_NC00021$" AS VARCHAR2(128))='Sarah
      J. Bell' AND SYS_CHECKACL("ACLOID", "OWNERID", xmltype('<privilege
      xmlns="http://xmlns.oracle.com/xdb/acl.xsd"
      xmlns:xsi="http://www.w3.org/2001/XMLSchema-instance"
      xsi:schemaLocation="http://xmlns.oracle.com/xdb/acl.xsd
      http://xmlns.oracle.com/xdb/acl.xsd DAV:http://xmlns.oracle.com/xdb/dav.xsd
      "><read-properties/><read-contents/></privilege>'))=1)
```

Example 19-6 Using DBMS_XMLSTORAGE_MANAGE.XPATH2TABCOLMAPPING

```
SELECT DBMS_XMLSTORAGE_MANAGE.XPath2TabColMapping(USER,
                                                    'PURCHASEORDER',
                                                    '',
                                                    '/PurchaseOrder/Requestor',
                                                    '')
      FROM DUAL;

DBMS_XMLSTORAGE_MANAGE.XPath2TabColMapping(US
-----
<Result>
  <Mapping TableName="PURCHASEORDER" ColumnName="SYS_NC00021$" />
</Result>
```

Example 19-7 Creating an Index on a Column Targeted by a Predicate

```
CREATE INDEX requestor_index ON purchaseorder ("SYS_NC00021$");

CREATE INDEX requestor_index ON purchaseorder ("XMLDATA"."REQUESTOR");

CREATE INDEX requestor_index ON purchaseorder
  (extractvalue(OBJECT_VALUE, '/PurchaseOrder/Requestor'));
```

Example 19-8 Creating a Function-Based Index for a Column Targeted by a Predicate

```
CREATE INDEX requestor_index ON purchaseorder
  (cast("XMLDATA"."REQUESTOR" AS VARCHAR2(128)));
```

Example 19-9 Execution Plan Showing that Index Is Picked Up

Id	Operation	Name	Rows	Bytes	Cost (%CPU)	Time
0	SELECT STATEMENT		1	524	2 (0)	00:00:01
* 1	TABLE ACCESS BY INDEX ROWID	PURCHASEORDER	1	524	2 (0)	00:00:01
* 2	INDEX RANGE SCAN	REQUESTOR_INDEX	1		1 (0)	00:00:01

Predicate Information (identified by operation id):

```
1 - filter(SYS_CHECKACL("ACLOID","OWNERID",xmltype('<privilege
  xmlns="http://xmlns.oracle.com/xdb/acl.xsd"
  xmlns:xsi="http://www.w3.org/2001/XMLSchema-instance"
  xsi:schemaLocation="http://xmlns.oracle.com/xdb/acl.xsd
    http://xmlns.oracle.com/xdb/acl.xsd
  DAV:http://xmlns.oracle.com/xdb/dav.xsd">
  <read-properties/><read-contents/></privilege>'))=1)
2 - access(CAST("SYS_NC00021$" AS VARCHAR2(128))='Sarah J. Bell')
```

Example 19-10 Creating a Function-Based Index for a Column Targeted by a Predicate

```
CREATE INDEX requestor_index
  ON purchaseorder po
  (XMLCast(XMLQuery('$p/PurchaseOrder/Requestor' PASSING po.OBJECT_VALUE AS "p"
    RETURNING CONTENT)
    AS VARCHAR2(128)));
```

19.4.4 Guideline: Create indexes on ordered collection tables

If a collection is stored as an ordered collection table (OCT) or as an XMLType instance, then you can directly access members of the collection. Each member becomes a table row, so you can access it directly with SQL. You can often improve performance by indexing such collection members.

You do this by creating a *composite* index on (a) the object attribute that corresponds to the collection XML element or its attribute and (b) pseudocolumn NESTED_TABLE_ID.

Example 19-11 (page 19-9) shows the execution plan for a query to find the Reference elements in documents that contain an order for part number 717951002372 (Part element with an Id attribute of value 717951002372). The

collection of `LineItem` elements is stored as rows in the ordered collection table `lineitem_table`.

Note:

[Example 19-11](#) (page 19-9) does not use the `purchaseorder` table from sample database schema `OE`. It uses a `purchaseorder` table that uses an ordered collection table (OCT) named `lineitem_table` for the collection element `LineItem`.

The execution plan shows a full scan of ordered collection table `lineitem_table`. This could be acceptable if there were only a few hundred documents in the `purchaseorder` table, but it would be unacceptable if there were thousands or millions of documents in the table.

To improve the performance of such a query, you can create an index that provides direct access to pseudocolumn `NESTED_TABLE_ID`, given the value of attribute `Id`. Unfortunately, Oracle XML DB does not allow indexes on collections to be created using XPath expressions directly. To create the index, you must understand the structure of the SQL object that is used to manage the `LineItem` elements. Given this information, you can create the required index using conventional object-relational SQL.

In this case, element `LineItem` is stored as an instance of object type `lineitem_t`. Element `Part` is stored as an instance of SQL data type `part_t`. XML attribute `Id` is mapped to object attribute `part_number`. Given this information, you can create a *composite index* on attribute `part_number` and pseudocolumn `NESTED_TABLE_ID`, as shown in [Example 19-12](#) (page 19-10). This index provides direct access to those purchase-order documents that have `LineItem` elements that reference the required part.

Example 19-11 Execution Plan for a Selection of Collection Elements

```
SELECT XMLCast(XMLQuery('$p/PurchaseOrder/Reference'
    PASSING OBJECT_VALUE AS "p" RETURNING CONTENT)
    AS VARCHAR2(4000)) "Reference"
FROM purchaseorder
WHERE XMLExists('$p/PurchaseOrder/LineItems/LineItem/Part[@Id="717951002372"]'
    PASSING OBJECT_VALUE AS "p");
```

Id	Operation	Name	Rows	Bytes	Cost (%CPU)	Time
0	SELECT STATEMENT		21	2352	20 (10)	00:00:01
* 1	HASH JOIN RIGHT SEMI		21	2352	20 (10)	00:00:01
2	JOIN FILTER CREATE	:BF0000	22	880	14 (8)	00:00:01
* 3	TABLE ACCESS FULL	LINEITEM_TABLE	22	880	14 (8)	00:00:01
4	JOIN FILTER USE	:BF0000	132	9504	5 (0)	00:00:01
* 5	TABLE ACCESS FULL	PURCHASEORDER	132	9504	5 (0)	00:00:01

Predicate Information (identified by operation id):

- 1 - access("NESTED_TABLE_ID"="PURCHASEORDER"."SYS_NC0003400035\$")
- 3 - filter("SYS_NC00011\$"='717951002372')
- 5 - filter(SYS_OP_BLOOM_FILTER(:BF0000,"PURCHASEORDER","SYS_NC0003400035\$"))

Example 19-12 *Creating an Index for Direct Access to an Ordered Collection Table*

```
CREATE INDEX lineitem_part_index ON lineitem_table l (l.part.part_number, l.NESTED_TABLE_ID);
```

19.4.5 Guideline: Use `XMLOptimizationCheck` to determine why a query is not rewritten

If a query has not been optimized, you can use system variable `XMLOptimizationCheck` to try to determine why.

See Also:

[Diagnosis of XQuery Optimization: `XMLOptimizationCheck`](#) (page 5-46)

XML Schema Evolution

You can use XML schema evolution to update your XML schema after you have registered it with Oracle XML DB.

- [Overview of XML Schema Evolution](#) (page 20-1)
- [Copy-Based Schema Evolution](#) (page 20-2)
- [In-Place XML Schema Evolution](#) (page 20-15)

Oracle XML DB supports the W3C XML Schema recommendation. XML instance documents that conform to an XML schema can be stored and retrieved using SQL and protocols such as FTP, HTTP(S), and WebDAV. In addition to specifying the structure of XML documents, XML schemas determine the mapping between XML and object-relational storage.

See Also:

[XML Schema Storage and Query: Basic](#) (page 17-1)

20.1 Overview of XML Schema Evolution

A major challenge for developers using an XML schema with Oracle XML DB is how to deal with changes in the content or structure of XML documents. In some environments, the need for changes may be frequent or extensive, arising from new regulations, internal needs, or external opportunities.

For example, you might need to add new elements or attributes to an XML schema definition, modify a data type, or relax or tighten certain minimum and maximum occurrence requirements.

In such cases, you need to "evolve" the XML schema so that new requirements are accommodated, while any existing instance documents (the data) remain valid (or can be made valid), and existing applications can continue to run.

If you do not care about any existing documents, you can of course simply drop the `XMLType` tables that are dependent on the XML schema, delete the old XML schema, and register the new XML schema at the same URL. In most cases, however, you need to keep the existing documents, possibly transforming them to accommodate the new XML schema.

Oracle XML DB supports two kinds of schema evolution:

- **Copy-based schema evolution**, in which all instance documents that conform to the schema are copied to a temporary location in the database, the old schema is deleted, the modified schema is registered, and the instance documents are inserted into their new locations from the temporary area

- **In-place schema evolution**, which does not require copying, deleting, and inserting existing data and thus is much faster than copy-based evolution, but which has restrictions that do not apply to copy-based evolution

In general, in-place evolution is permitted if you are not changing the storage model and if the changes do not invalidate existing documents (that is, if existing documents are conformant with the new schema or can be made conformant with it). A more detailed explanation of restrictions and guidelines is presented in [In-Place XML Schema Evolution](#) (page 20-15).

Each approach has its own PL/SQL procedure: `DBMS_XMLSCHEMA.copyEvolve` for copy-based evolution, `DBMS_XMLSCHEMA.inPlaceEvolve` for in-place evolution. This chapter explains the use of each procedure and presents guidelines for using its associated approach to schema evolution.

20.2 Copy-Based Schema Evolution

You perform copy-based XML schema evolution using PL/SQL procedure `DBMS_XMLSCHEMA.copyEvolve`. This backs up existing instance documents to temporary `XMLType` tables, drops the old version of the XML schema (which also deletes the associated instance documents), registers the new version, and copies the backed-up instance documents to new `XMLType` tables.

In case of a problem, the backup copies are restored — see [Rollback When Procedure `DBMS_XMLSCHEMA.COPYEVOLVE` Raises an Error](#) (page 20-9).

Using procedure `copyEvolve`, you can evolve your registered XML schema in such a way that existing XML instance documents continue to be valid.

20.2.1 Scenario for Copy-Based Evolution

An evolved version of a purchase-order XML schema is shown. It is used in examples that illustrate the use of copy-based XML schema evolution.

[Example 20-1](#) (page 20-2) shows a *partial* listing of a revised version of the purchase-order XML schema of [Example A-2](#) (page A-34). See [Example A-3](#) (page A-36) for the *complete* revised schema listing. Text that is in **bold** here is new or different from that in the original schema.

Example 20-1 Revised Purchase-Order XML Schema

```
<xs:schema xmlns:xs="http://www.w3.org/2001/XMLSchema"
  xmlns:xdb="http://xmlns.oracle.com/xdb"
  version="1.0">
  <xs:element
    name="PurchaseOrder" type="PurchaseOrderType"
    xdb:defaultTable="PURCHASEORDER"
    xdb:columnProps=
      "CONSTRAINT purchaseorder_pkey PRIMARY KEY (XMLDATA.reference),
      CONSTRAINT valid_email_address FOREIGN KEY (XMLDATA.userid)
      REFERENCES hr.employees (EMAIL)"
    xdb:tableProps=
      "VARRAY XMLDATA.ACTIONS.ACTION STORE AS TABLE ACTION_TABLE
      ((CONSTRAINT action_pkey PRIMARY KEY (NESTED_TABLE_ID, SYS_NC_ARRAY_INDEX$)))
      VARRAY XMLDATA.LINEITEMS.LINEITEM STORE AS TABLE LINEITEM_TABLE
      ((constraint LINEITEM_PKEY primary key (NESTED_TABLE_ID, SYS_NC_ARRAY_INDEX$)))
      lob (XMLDATA.NOTES) STORE AS (ENABLE STORAGE IN ROW STORAGE(INITIAL 4K NEXT 32K))"/>
  <xs:complexType name="PurchaseOrderType" xdb:SQLType="PURCHASEORDER_T">
    <xs:sequence>
      <xs:element name="Actions" type="ActionsType" xdb:SQLName="ACTIONS"/>
      <xs:element name="Reject" type="RejectionType" minOccurs="0" xdb:SQLName="REJECTION"/>
      <xs:element name="Requestor" type="RequestorType" xdb:SQLName="REQUESTOR"/>
      <xs:element name="User" type="UserType" xdb:SQLName="USERID"/>
      <xs:element name="CostCenter" type="CostCenterType" xdb:SQLName="COST_CENTER"/>
    
```

```

<xs:element name="BillingAddress" type="AddressType" minOccurs="0"
  xdb:SQLName="BILLING_ADDRESS"/>
<xs:element name="ShippingInstructions" type="ShippingInstructionsType"
  xdb:SQLName="SHIPPING_INSTRUCTIONS"/>
<xs:element name="SpecialInstructions" type="SpecialInstructionsType"
  xdb:SQLName="SPECIAL_INSTRUCTIONS"/>
<xs:element name="LineItems" type="LineItemsType" xdb:SQLName="LINEITEMS"/>
<xs:element name="Notes" type="NotesType" minOccurs="0" xdb:SQLType="CLOB"
  xdb:SQLName="NOTES"/>
</xs:sequence>
<xs:attribute name="Reference" type="ReferenceType" use="required" xdb:SQLName="REFERENCE"/>
<xs:attribute name="DateCreated" type="xs:dateTime" use="required"
  xdb:SQLType="TIMESTAMP WITH TIME ZONE"/>
</xs:complexType>
<xs:complexType name="LineItemsType" xdb:SQLType="LINEITEMS_T">
  <xs:sequence>
    <xs:element name="LineItem" type="LineItemType" maxOccurs="unbounded" xdb:SQLName="LINEITEM"
      xdb:SQLCollType="LINEITEM_V"/>
  </xs:sequence>
</xs:complexType>
<xs:complexType name="LineItemType" xdb:SQLType="LINEITEM_T">
  <xs:sequence>
    <xs:element name="Part" type="PartType" xdb:SQLName="PART"/>
    <xs:element name="Quantity" type="quantityType"/>
  </xs:sequence>
  <xs:attribute name="ItemNumber" type="xs:integer" xdb:SQLName="ITEMNUMBER"
    xdb:SQLType="NUMBER"/>
</xs:complexType>
<xs:complexType name="PartType" xdb:SQLType="PART_T">
  <xs:simpleContent>
    <xs:extension base="UPCCCodeType">
      <xs:attribute name="Description" type="DescriptionType" use="required"
        xdb:SQLName="DESCRIPTION"/>
      <xs:attribute name="UnitCost" type="moneyType" use="required"/>
    </xs:extension>
  </xs:simpleContent>
</xs:complexType>
<xs:simpleType name="ReferenceType">
  <xs:restriction base="xs:string">
    <xs:minLength value="18"/>
    <xs:maxLength value="30"/>
  </xs:restriction>
</xs:simpleType>
. . .
<xs:complexType name="RejectionType" xdb:SQLType="REJECTION_T">
  <xs:all>
    <xs:element name="User" type="UserType" minOccurs="0" xdb:SQLName="REJECTED_BY"/>
    <xs:element name="Date" type="DateType" minOccurs="0" xdb:SQLName="DATE_REJECTED"/>
    <xs:element name="Comments" type="CommentsType" minOccurs="0" xdb:SQLName="REASON_REJECTED"/>
  </xs:all>
</xs:complexType>
<xs:complexType name="ShippingInstructionsType" xdb:SQLType="SHIPPING_INSTRUCTIONS_T">
  <xs:sequence>
    <xs:element name="name" type="NameType" minOccurs="0" xdb:SQLName="SHIP_TO_NAME"/>
    <xs:choice>
      <xs:element name="address" type="AddressType" minOccurs="0"/>
      <xs:element name="fullAddress" type="FullAddressType" minOccurs="0"
        xdb:SQLName="SHIP_TO_ADDRESS"/>
    </xs:choice>
    <xs:element name="telephone" type="TelephoneType" minOccurs="0" xdb:SQLName="SHIP_TO_PHONE"/>
  </xs:sequence>
</xs:complexType>
. . .

```

```

<xs:simpleType name="NameType">
  <xs:restriction base="xs:string">
    <xs:minLength value="1"/>
    <xs:maxLength value="20"/>
  </xs:restriction>
</xs:simpleType>
<xs:simpleType name="FullAddressType">
  <xs:restriction base="xs:string">
    <xs:minLength value="1"/>
    <xs:maxLength value="256"/>
  </xs:restriction>
</xs:simpleType>
. . .

<xs:simpleType name="DescriptionType">
  <xs:restriction base="xs:string">
    <xs:minLength value="1"/>
    <xs:maxLength value="256"/>
  </xs:restriction>
</xs:simpleType>
<xs:complexType name="AddressType" xdb:SQLType="ADDRESS_T">
  <xs:sequence>
    <xs:element name="StreetLine1" type="StreetType"/>
    <xs:element name="StreetLine2" type="StreetType" minOccurs="0"/>
    <xs:element name="City" type="CityType"/>
    <xs:choice>
      <xs:sequence>
        <xs:element name="State" type="StateType"/>
        <xs:element name="ZipCode" type="ZipCodeType"/>
      </xs:sequence>
      <xs:sequence>
        <xs:element name="Province" type="ProvinceType"/>
        <xs:element name="PostCode" type="PostCodeType"/>
      </xs:sequence>
      <xs:sequence>
        <xs:element name="County" type="CountyType"/>
        <xs:element name="Postcode" type="PostCodeType"/>
      </xs:sequence>
    </xs:choice>
    <xs:element name="Country" type="CountryType"/>
  </xs:sequence>
</xs:complexType>
<xs:simpleType name="StreetType">
  <xs:restriction base="xs:string">
    <xs:minLength value="1"/>
    <xs:maxLength value="128"/>
  </xs:restriction>
</xs:simpleType>
<xs:simpleType name="CityType">
  <xs:restriction base="xs:string">
    <xs:minLength value="1"/>
    <xs:maxLength value="64"/>
  </xs:restriction>
</xs:simpleType>
<xs:simpleType name="StateType">
  <xs:restriction base="xs:string">
    <xs:minLength value="2"/>
    <xs:maxLength value="2"/>
    <xs:enumeration value="AK"/>
    <xs:enumeration value="AL"/>
    <xs:enumeration value="AR"/>
    . . . -- A value for each US state abbreviation
    <xs:enumeration value="WY"/>
  </xs:restriction>
</xs:simpleType>

```



```

<xs:simpleType name="ZipCodeType">
  <xs:restriction base="xs:string">
    <xs:pattern value="\d{5}"/>
    <xs:pattern value="\d{5}-\d{4}"/>
  </xs:restriction>
</xs:simpleType>
<xs:simpleType name="CountryType">
  <xs:restriction base="xs:string">
    <xs:minLength value="1"/>
    <xs:maxLength value="64"/>
  </xs:restriction>
</xs:simpleType>
<xs:simpleType name="CountyType">
  <xs:restriction base="xs:string">
    <xs:minLength value="1"/>
    <xs:maxLength value="32"/>
  </xs:restriction>
</xs:simpleType>
<xs:simpleType name="PostCodeType">
  <xs:restriction base="xs:string">
    <xs:minLength value="1"/>
    <xs:maxLength value="12"/>
  </xs:restriction>
</xs:simpleType>
<xs:simpleType name="ProvinceType">
  <xs:restriction base="xs:string">
    <xs:minLength value="2"/>
    <xs:maxLength value="2"/>
  </xs:restriction>
</xs:simpleType>
<xs:simpleType name="NotesType">
  <xs:restriction base="xs:string">
    <xs:maxLength value="32767"/>
  </xs:restriction>
</xs:simpleType>
<xs:simpleType name="UPCCodeType">
  <xs:restriction base="xs:string">
    <xs:minLength value="11"/>
    <xs:maxLength value="14"/>
    <xs:pattern value="\d{11}"/>
    <xs:pattern value="\d{12}"/>
    <xs:pattern value="\d{13}"/>
    <xs:pattern value="\d{14}"/>
  </xs:restriction>
</xs:simpleType>
</xs:schema>

```

20.2.2 COPYEVOLVE Parameters and Errors

The parameters of PL/SQL procedure `DBMS_XMLSCHEMA.copyEvolve` are described, as are the errors associated with this procedure.

This is the signature of procedure `DBMS_XMLSCHEMA.copyEvolve`:

```

procedure copyEvolve(schemaURLs      IN XDB$STRING_LIST_T,
                    newSchemas      IN XMLSequenceType,
                    transforms       IN XMLSequenceType := NULL,
                    preserveOldDocs  IN BOOLEAN := FALSE,
                    mapTabName       IN VARCHAR2 := NULL,
                    generateTables   IN BOOLEAN := TRUE,
                    force             IN BOOLEAN := FALSE,
                    schemaOwners     IN XDB$STRING_LIST_T := NULL,
                    parallelDegree   IN PLS_INTEGER := 0,
                    options           IN PLS_INTEGER := 0);

```

[Table 20-1](#) (page 20-6) describes the individual parameters. [Table 20-2](#) (page 20-7) describes the errors associated with the procedure.

Table 20-1 Parameters of Procedure `DBMS_XMLSCHEMA.COPYEVOLVE`

Parameter	Description
<code>schemaURLs</code>	Varray of URLs of XML schemas to be evolved (varray of <code>VARCHAR2(4000)</code>). This should include the dependent schemas as well. Unless the <code>force</code> parameter is <code>TRUE</code> , the URLs should be in the dependency order, that is, if URL A comes before URL B in the varray, then schema A should not be dependent on schema B but schema B may be dependent on schema A.
<code>newSchemas</code>	Varray of new XML schema documents (<code>XMLType</code> instances). Specify this in exactly the same order as the corresponding URLs. If no change is necessary in an XML schema, provide the unchanged schema.
<code>transforms</code>	Varray of XSL documents (<code>XMLType</code> instances) that are applied to XML schema based documents to make them conform to the new schemas. Specify these in exactly the same order as the corresponding URLs. If no transformations are required, this parameter need not be specified.
<code>preserveOldDocs</code>	If this is <code>TRUE</code> , then the temporary tables holding old data are not dropped at the end of schema evolution. See also Guidelines for Using Procedure <code>COPYEVOLVE</code> (page 20-8).
<code>mapTabName</code>	Specifies the name of table that maps old <code>XMLType</code> table or column names to names of corresponding temporary tables.
<code>generateTables</code>	By default this parameter is <code>TRUE</code> . If <code>FALSE</code> then <code>XMLType</code> tables or columns are not generated after registering new XML schemas. If <code>FALSE</code> , <code>preserveOldDocs</code> must be <code>TRUE</code> and <code>mapTabName</code> must not be <code>NULL</code> .
<code>force</code>	If this is <code>TRUE</code> , then errors during the registration of new schemas are ignored. If there are circular dependencies among the schemas, set this flag to <code>TRUE</code> to ensure that each schema is stored even though there may be errors in registration.
<code>schemaOwners</code>	Varray of names of schema owners. Specify these in exactly the same order as the corresponding URLs.
<code>parallelDegree</code>	Specifies the degree of parallelism to be used in a <code>PARALLEL</code> hint during the data-copy stage. If this is 0 (default value), a <code>PARALLEL</code> hint is absent from the data-copy statements.
<code>options</code>	Miscellaneous options. The only option is <code>COPYEVOLVE_BINARY_XML</code> , which means to register the new XML schemas for binary XML data and create the new tables or columns with binary XML as the storage model.

Table 20-2 Errors Associated with Procedure DBMS_XMLSCHEMA.COPYEVOLVE

Error Number and Message	Cause	Action
30942 XML Schema Evolution error for schema '<schema_url>' table "<owner_name>.<table_name>" column '<column_name>'	The given XMLType table or column that conforms to the given XML schema had errors during evolution. In the case of a table, the column name is empty. See also the more specific error that follows this.	Based on the schema, table, and column information in this error and the more specific error that follows, take corrective action.
30943 XML Schema '<schema_url>' is dependent on XML schema '<schema_url>'	Not all dependent XML schemas were specified or the schemas were not specified in dependency order, that is, if schema S1 is dependent on schema S, S must appear before S1.	Include the previously unspecified schema in the list of schemas or correct the order in which the schemas are specified. Then retry the operation.
30944 Error during rollback for XML schema '<schema_url>' table "<owner_name>.<table_name>" column '<column_name>'	The given XMLType table or column that conforms to the given XML schema had errors during a rollback of XML schema evolution. For a table, the column name is empty. See also the more specific error that follows this.	Based on the schema, table, and column information in this error and the more specific error that follows, take corrective action.
30945 Could not create mapping table '<table_name>'	A mapping table could not be created during XML schema evolution. See also the more specific error that follows this.	Ensure that a table with the given name does not exist and retry the operation.
30946 XML Schema Evolution warning: temporary tables not cleaned up	An error occurred after the schema was evolved while cleaning up temporary tables. The schema evolution was successful.	If you need to remove the temporary tables, use the mapping table to get the temporary table names and drop them.

20.2.3 Limitations of Procedure COPYEVOLVE

The use of PL/SQL procedure DBMS_XMLSCHEMA.copyEvolve involves certain limitations.

- Indexes, triggers, constraints, row-level security (RLS) policies, and other metadata related to the XMLType tables that are dependent on the schemas are not preserved. These must be re-created after evolution.
- If top-level element names are changed, additional steps are required after copyEvolve finishes executing. See [Top-Level Element Name Changes](#) (page 20-8).
- Copy-based evolution cannot be used if there is a table with an object-type column that has an XMLType attribute that is dependent on any of the schemas to be evolved. For example, consider this table:

```
CREATE TYPE t1 AS OBJECT (n NUMBER, x XMLType);
CREATE TABLE tab1 (e NUMBER, o t1) XMLType
  COLUMN o.x XMLSchema "s1.xsd" ELEMENT "Employee";
```

This assumes that an XML schema with a top-level element `Employee` has been registered under URL `s1.xsd`. It is not possible to evolve this XML schema, because table `tab1` with column `o` with `XMLType` attribute `x` is dependent on the XML schema. Although `copyEvolve` does not handle `XMLType` object attributes, it does raise an error in such cases.

20.2.4 Guidelines for Using Procedure `COPYEVOLVE`

General guidelines for using PL/SQL procedure `DBMS_XMLSCHEMA.copyEvolve` are presented, as well as guidelines that are specific to particular contexts.

The following general guideline applies to using `copyEvolve`. The rest of this section describes specific guidelines that can also be appropriate in particular contexts.

1. Turn off the recycle bin, to prevent dropped tables from being copied to it:

```
ALTER SESSION SET RECYCLEBIN=off;
```

2. Identify the XML schemas that are dependent on the XML schema that is to be evolved. You can acquire the URLs of the dependent XML schemas using the following query, where `schema_to_be_evolved` is the schema to be evolved, and `owner_of_schema_to_be_evolved` is its owner (database user).

```
SELECT dxs.SCHEMA_URL, dxs.OWNER
  FROM DBA_DEPENDENCIES dd, DBA_XML_SCHEMAS dxs
  WHERE dd.REFERENCED_NAME = (SELECT INT_OBJNAME
                               FROM DBA_XML_SCHEMAS
                               WHERE SCHEMA_URL = schema_to_be_evolved
                               AND OWNER = owner_of_schema_to_be_evolved)
  AND dxs.INT_OBJNAME = dd.NAME;
```

In many cases, no changes are needed in the dependent XML schemas. But if the dependent XML schemas need to be changed, then you must also prepare new versions of those XML schemas.

3. If the existing instance documents do not conform to the new XML schema, then you must provide an XSL stylesheet that, when applied to an instance document, transforms it to conform to the new schema. You must do this for each XML schema identified in Step 2 (page 20-8). The transformation must handle documents that conform to all top-level elements in the new XML schema.
4. Call procedure `DBMS_XMLSCHEMA.copyEvolve`, specifying the XML schema URLs, new schemas, and transformation stylesheet.

20.2.4.1 Top-Level Element Name Changes

PL/SQL procedure `DBMS_XMLSCHEMA.copyEvolve` assumes that top-level elements have not been dropped in new schemas and that their names have not been changed. If there are such changes then call procedure `copyEvolve` with parameter `generateTables` set to `FALSE` and parameter `preserveOldDocs` set to `TRUE`, so that backup document copies are available.

With those parameter values, new tables are not generated, and the temporary tables holding the old documents (backup copies) are not dropped at the end of the procedure. You can then store the old documents in whatever form is appropriate and

drop the temporary tables. See [COPYEVOLVE Parameters and Errors](#) (page 20-5) for more details on using these parameters.

20.2.4.2 User-Created Virtual Columns of Tables Other Than Default Tables

For tables that are not default tables, any virtual columns that you create are not re-created during copy-based evolution. If such columns are needed then set `copyEvolve` parameter `preserveOldDocs` to `TRUE`, create the tables, and copy the old documents after procedure `copyEvolve` has finished.

20.2.4.3 Ensure That the XML Schema and Dependents Are Not Used by Concurrent Sessions

Ensure that the XML schema to be evolved, as well as its dependents, are not used by any concurrent session during the XML schema evolution process.

If other, concurrent sessions have shared locks on this schema at the beginning of the evolution process, then procedure `DBMS_XMLSCHEMA.copyEvolve` waits for these sessions to release the locks so that it can acquire an exclusive lock. However, this lock is released immediately to allow the rest of the process to continue.

20.2.4.4 Rollback When Procedure `DBMS_XMLSCHEMA.COPYEVOLVE` Raises an Error

Procedure `DBMS_XMLSCHEMA.copyEvolve` either completely succeeds or it raises an error. If it raises an error then it tries to roll back as much of the operation as possible.

Evolving an XML schema involves many database DDL statements. When an error occurs, compensating DDL statements are executed to undo the effect of all steps executed to that point. If the old tables or schemas have been dropped, they are re-created, but any table, column, and storage properties and any auxiliary structures (such as indexes, triggers, constraints, and RLS policies) associated with the tables and columns are lost.

20.2.4.5 Failed Rollback From Insufficient Privileges

In certain cases you cannot roll back a copy-based evolution operation. For example, if table creation fails due to reasons not related to the new XML schema, then there is no way to roll back.

An example is failure due to insufficient privileges. The temporary tables are not deleted even if `preserveOldDocs` is `FALSE`, so the data can be recovered. If the `mapTabName` parameter is null, the mapping table name is `XDB$MAPTAB` followed by a sequence number. The exact table name can be found using a query such as the following:

```
SELECT TABLE_NAME FROM USER_TABLES WHERE TABLE_NAME LIKE 'XDB$MAPTAB%';
```

20.2.4.6 Privileges Needed for XML Schema Evolution

There are several database privileges that you might need, in order to perform copy-based XML schema evolution.

Copy-based XML schema evolution can involve dropping or creating SQL data types, so you need type-related privileges such as `DROP TYPE`, `CREATE TYPE`, and `ALTER TYPE`. You need privileges to delete and register the XML schemas involved in the evolution. You need all privileges on `XMLType` tables that conform to the schemas being evolved. For `XMLType` columns, the `ALTER TABLE` privilege is needed on corresponding tables. If there are schema-based `XMLType` tables or columns in other database schemas, you need privileges such as the following:

- CREATE ANY TABLE
- CREATE ANY INDEX
- SELECT ANY TABLE
- READ ANY TABLE
- UPDATE ANY TABLE
- INSERT ANY TABLE
- DELETE ANY TABLE
- DROP ANY TABLE
- ALTER ANY TABLE
- DROP ANY INDEX

To avoid needing to grant all these privileges to the database- schema owner, Oracle recommends that a database administrator perform the evolution if there are XML schema-based XMLType table or columns belonging to other database schemas.

20.2.5 Update of Existing XML Instance Documents Using an XSLT Stylesheet

After you modify a registered XML schema, you must update any existing XML instance documents that use the schema. You do this by applying an XSLT stylesheet to each of the instance documents. The stylesheet represents the difference between the old and new XML schemas.

[Example 20-2](#) (page 20-10) shows an XSLT stylesheet, in file `evolvePurchaseOrder.xsl`, that transforms existing purchase-order documents that use the old XML schema, so they use the new XML schema instead.

Example 20-2 *evolvePurchaseOrder.xsl: XSLT Stylesheet to Update Instance Documents*

```
<?xml version="1.0" encoding="UTF-8"?>
<xsl:stylesheet
  version="1.0"
  xmlns:xsl="http://www.w3.org/1999/XSL/Transform"
  xmlns:xsi="http://www.w3.org/2001/XMLSchema-instance">
  <xsl:output method="xml" encoding="UTF-8"/>
  <xsl:template match="/PurchaseOrder">
    <PurchaseOrder>
      <xsl:attribute name="xsi:noNamespaceSchemaLocation">
        http://localhost:8080/source/schemas/poSource/xsd/purchaseOrder.xsd
      </xsl:attribute>
      <xsl:for-each select="Reference">
        <xsl:attribute name="Reference">
          <xsl:value-of select="."/>
        </xsl:attribute>
      </xsl:for-each>
      <xsl:variable name="V264_394" select="'2004-01-01T12:00:00.000000-08:00'"/>
      <xsl:attribute name="DateCreated">
        <xsl:value-of select="$V264_394"/>
      </xsl:attribute>
      <xsl:for-each select="Actions">
        <Actions>
          <xsl:for-each select="Action">
            <Action>
              <xsl:for-each select="User">
                <User>
                  <xsl:value-of select="."/>
                </User>
              </xsl:for-each>
            </Action>
          </xsl:for-each>
        </Actions>
      </xsl:for-each>
    </PurchaseOrder>
  </xsl:template>
</xsl:stylesheet>
```

```

        </xsl:for-each>
        <xsl:for-each select="Date">
            <Date>
                <xsl:value-of select="."/>
            </Date>
        </xsl:for-each>
    </Action>
</xsl:for-each>
</Actions>
</xsl:for-each>
<xsl:for-each select="Reject">
    <Reject>
        <xsl:for-each select="User">
            <User>
                <xsl:value-of select="."/>
            </User>
        </xsl:for-each>
        <xsl:for-each select="Date">
            <Date>
                <xsl:value-of select="."/>
            </Date>
        </xsl:for-each>
        <xsl:for-each select="Comments">
            <Comments>
                <xsl:value-of select="."/>
            </Comments>
        </xsl:for-each>
    </Reject>
</xsl:for-each>
<xsl:for-each select="Requestor">
    <Requestor>
        <xsl:value-of select="."/>
    </Requestor>
</xsl:for-each>
<xsl:for-each select="User">
    <User>
        <xsl:value-of select="."/>
    </User>
</xsl:for-each>
<xsl:for-each select="CostCenter">
    <CostCenter>
        <xsl:value-of select="."/>
    </CostCenter>
</xsl:for-each>
<ShippingInstructions>
    <xsl:for-each select="ShippingInstructions">
        <xsl:for-each select="name">
            <name>
                <xsl:value-of select="."/>
            </name>
        </xsl:for-each>
    </xsl:for-each>
    <xsl:for-each select="ShippingInstructions">
        <xsl:for-each select="address">
            <fullAddress>
                <xsl:value-of select="."/>
            </fullAddress>
        </xsl:for-each>
    </xsl:for-each>
    <xsl:for-each select="ShippingInstructions">
        <xsl:for-each select="telephone">
            <telephone>
                <xsl:value-of select="."/>
            </telephone>
        </xsl:for-each>
    </xsl:for-each>
</ShippingInstructions>
<xsl:for-each select="SpecialInstructions">
    <SpecialInstructions>

```

```

    <xsl:value-of select="."/>
  </SpecialInstructions>
</xsl:for-each>
<xsl:for-each select="LineItems">
  <LineItems>
    <xsl:for-each select="LineItem">
      <xsl:variable name="V22" select="."/>
      <LineItem>
        <xsl:for-each select="@ItemNumber">
          <xsl:attribute name="ItemNumber">
            <xsl:value-of select="."/>
          </xsl:attribute>
        </xsl:for-each>
        <xsl:for-each select="$V22/Part">
          <xsl:variable name="V24" select="."/>
          <xsl:for-each select="@Id">
            <Part>
              <xsl:for-each select="$V22/Description">
                <xsl:attribute name="Description">
                  <xsl:value-of select="."/>
                </xsl:attribute>
              </xsl:for-each>
              <xsl:for-each select="$V24/@UnitPrice">
                <xsl:attribute name="UnitCost">
                  <xsl:value-of select="."/>
                </xsl:attribute>
              </xsl:for-each>
              <xsl:value-of select="."/>
            </Part>
          </xsl:for-each>
        </xsl:for-each>
        <xsl:for-each select="$V22/Part">
          <xsl:for-each select="@Quantity">
            <Quantity>
              <xsl:value-of select="."/>
            </Quantity>
          </xsl:for-each>
        </xsl:for-each>
      </LineItem>
    </xsl:for-each>
  </LineItems>
</xsl:for-each>
</PurchaseOrder>
</xsl:template>
</xsl:stylesheet>

```

20.2.6 Examples of Using Procedure COPYEVOLVE

Several examples are presented of using PL/SQL procedure `DBMS_XMLSCHEMA.copyEvolve` to update an XML schema. (Be sure to back up all registered XML schemas and XML documents that reference them, before using the procedure.)

Example 20-3 (page 20-15) loads a revised XML schema and evolution XSL stylesheet into Oracle XML DB Repository.

Example 20-4 (page 20-15) shows how to use procedure `DBMS_XMLSCHEMA.copyEvolve` to evolve the XML schema `purchaseOrder.xsd` to `revisedPurchaseOrder.xsd` using the XSLT stylesheet `evolvePurchaseOrder.xsl`.

Procedure `DBMS_XMLSCHEMA.copyEvolve` evolves registered XML schemas in such a way that existing instance documents continue to remain valid.

Caution:

Before executing procedure `DBMS_XMLSCHEMA.copyEvolve`, always *back up* all registered XML schemas and all XML documents that conform to them. Procedure `copyEvolve` *deletes* all documents that conform to registered XML schemas.

First, procedure `copyEvolve` copies the data in XML schema-based XMLType tables and columns to temporary tables. It then drops the original tables and columns, and deletes the old XML schemas. After registering the new XML schemas, it creates XMLType tables and columns and populates them with data (unless parameter `GENTABLES` is `FALSE`) but it does not create any auxiliary structures such as indexes, constraints, triggers, and row-level security (RLS) policies. Procedure `copyEvolve` creates the tables and columns as follows:

- It creates default tables while registering the new schemas.
- It creates tables that are not default tables using a statement of the following form:

```
CREATE TABLE table_name OF XMLType OID 'oid'
  XMLSCHEMA schema_url ELEMENT element_name
```

where `OID` is the original OID of the table, before it was dropped.

- It adds XMLType columns using a statement of the following form:

```
ALTER TABLE table_name ADD (column_name XMLType) XMLType COLUMN
  column_name XMLSCHEMA schema_url ELEMENT element_name
```

When a new XML schema is registered, types are generated if the registration of the corresponding old schema had generated types. If an XML schema was global before the evolution, then it is also global after the evolution. Similarly, if an XML schema was local before the evolution, then it is also local (owned by the same user) after the evolution. You have the option to preserve the temporary tables that contain the old documents, by setting parameter `preserveOldDocs` to `TRUE`. All temporary tables are created in the database schema of the current user. For XMLType tables, the temporary table has the columns shown in [Table 20-3](#) (page 20-13).

Table 20-3 XML Schema Evolution: XMLType Table Temporary Table Columns

Name	Type	Comment
Data	CLOB	XML document from the old table, in CLOB format.
OID	RAW(16)	OID of the corresponding row in the old table.
ACLOID	RAW(16)	This column is present only if the old table is hierarchy-enabled. ACLOID of corresponding row in old table.
OWNERID	RAW(16)	This column is present only if old table is hierarchy-enabled. OWNERID of corresponding row in old table.

For XMLType columns, the temporary table has the columns shown in [Table 20-4](#) (page 20-14).

Table 20-4 XML Schema Evolution: XMLType Column Temporary Table Columns

Name	Type	Comment
Data	CLOB	XML document from the old column, in CLOB format.
RID	ROWID	ROWID of the corresponding row in the table containing this column.

Procedure `copyEvolve` stores information about the mapping from the old table or column name to the corresponding temporary table name in a separate table specified by parameter `mapTabName`. If `preserveOldDocs` is `TRUE`, then the `mapTabName` parameter must not be `NULL`, and it must not be the name of any existing table in the current database schema. Each row in the mapping table has information about one of the old tables/columns. [Table 20-5](#) (page 20-14) shows the mapping table columns.

Table 20-5 Procedure COPYEVOLVE Mapping Table

Column Name	Column Type	Comment
SCHEMA_URL	VARCHAR2(700)	URL of the schema to which this table or column conforms.
SCHEMA_OWNER	VARCHAR2(30)	Owner of the schema.
ELEMENT_NAME	VARCHAR2(256)	Element to which this table or column conforms.
TABLE_NAME	VARCHAR2(65)	Qualified name of the table (<code><owner_name>.<table_name></code>).
TABLE_OID	RAW(16)	OID of table.
COLUMN_NAME	VARCHAR2(4000)	Name of the column (<code>NULL</code> for <code>XMLType</code> tables).
TEMP_TABNAME	VARCHAR2(30)	Name of temporary table that holds the data for this table or column.

You can avoid generating any tables or columns after registering the new XML schema by setting parameter `GENTABLES` to `FALSE`. If `GENTABLES` is `FALSE`, parameter `PRESERVEOLDDOCS` must be `TRUE` and parameter `MAPTABNAME` must not be `NULL`. This ensures that the data in the old tables is not lost. This is useful if you do not want the tables to be created by the procedure, as described in section [COPYEVOLVE Parameters and Errors](#) (page 20-5).

By default, it is assumed that all XML schemas are owned by the current user. If this is not true, then you must specify the owner of each XML schema in the `schemaOwners` parameter.

See Also:

Oracle Database SQL Language Reference for the complete description of ALTER TABLE

Example 20-3 Loading Revised XML Schema and XSLT Stylesheet

```

DECLARE
  res BOOLEAN;
BEGIN
  res := DBMS_XDB_REPOS.createResource(          -- Load revised XML schema
    '/source/schemas/poSource/revisedPurchaseOrder.xsd',
    bfilename('XMLDIR', 'revisedPurchaseOrder.xsd'),
    nls_charset_id('AL32UTF8'));
  res := DBMS_XDB_REPOS.createResource(          -- Load revised XSL stylesheet
    '/source/schemas/poSource/evolvePurchaseOrder.xsl',
    bfilename('XMLDIR', 'evolvePurchaseOrder.xsl'),
    nls_charset_id('AL32UTF8'));
END;

```

Example 20-4 Updating an XML Schema Using DBMS_XMLSCHEMA.COPYEVOLVE

```

BEGIN
  DBMS_XMLSCHEMA.copyEvolve(
    xdb$string_list_t('http://localhost:8080/source/schemas/poSource/xsd/purchaseOrder.xsd'),
    XMLSequenceType(XDBURITYPE('/source/schemas/poSource/revisedPurchaseOrder.xsd').getXML()),
    XMLSequenceType(XDBURITYPE('/source/schemas/poSource/evolvePurchaseOrder.xsl').getXML()));
END;

SELECT XMLQuery('$p/PurchaseOrder/LineItems/LineItem[1]'
  PASSING po.OBJECT_VALUE AS "p" RETURNING CONTENT) line_item
  FROM purchaseorder po
  WHERE XMLEExists('$p/PurchaseOrder[Reference="SBELL-2003030912333601PDT]')
    PASSING po.OBJECT_VALUE AS "p");

LINE_ITEM
-----
<LineItem ItemNumber="1">
  <Part Description="A Night to Remember" UnitCost="39.95">715515009058</Part>
  <Quantity>2</Quantity>
</LineItem>

```

The same query would have produced the following result before the schema evolution:

```

LINE_ITEM
-----
<LineItem ItemNumber="1">
  <Description>A Night to Remember</Description>
  <Part Id="715515009058" UnitPrice="39.95" Quantity="2"/>
</LineItem>

```

20.3 In-Place XML Schema Evolution

In-place XML schema evolution makes changes to an XML schema without requiring that existing data be copied, deleted, and reinserted. In-place evolution is thus much faster than copy-based evolution. However, in-place evolution also has several restrictions that do not apply to copy-based evolution.

You use procedure `DBMS_XMLSCHEMA.inPlaceEvolve` to perform in-place evolution. Using this procedure, you identify the changes to be made to an existing XML schema by specifying an XML schema-differences document, and you optionally specify flags to be applied to the evolution process.

In-place evolution constructs a new version of an XML schema by applying changes specified in a `diffXML` document, validates that new XML schema (against the XML schema for XML schemas), constructs DDL statements to evolve the disk structures used to store the XML instance documents associated with the XML schema, executes these DDL statements, and replaces the old version of the XML schema with the new, in that order. If the new version of the XML schema is not a valid schema, then in-place evolution fails.

20.3.1 Restrictions for In-Place XML Schema Evolution

Because in-place XML schema evolution avoids copying data, it does not permit arbitrary changes to an XML schema. The primary restriction on using in-place evolution can be stated generally as a requirement that a given XML schema can be evolved in place in only a backward-compatible way.

For the complete list of changes supported by in-place evolution, see [Supported Operations for In-Place XML Schema Evolution](#) (page 20-18).

Backward-compatible here means that any possible instance document that would validate against a given XML schema must also validate against a later (evolved) version of that XML schema. This applies to *all possible* conforming instance documents, not only to *existing* instance documents. For XML data that is stored as binary XML, backward compatibility also means that any XML schema annotations that affect binary XML treatment must not change during evolution. Backward compatibility is described further in section [Backward-Compatibility Restrictions](#) (page 20-16).

In addition to this general backward-compatibility restriction, there are some other restrictions for in-place evolution. These are described in section [Other Restrictions on In-Place Evolution](#) (page 20-17).

20.3.1.1 Backward-Compatibility Restrictions

Restrictions on in-place XML schema evolution are described that ensure backward compatibility of an evolved schema, so that any possible instance documents that satisfy the old XML schema also satisfy the new one.

20.3.1.1.1 Changes in Data Layout on Disk

Certain changes to an XML schema alter the layout of the associated instance documents on disk, and are therefore not permitted. This situation is more common when the storage layer is tightly integrated with information derived from the XML schema, as is the case for object-relational storage.

One such example is an XML schema, registered for object-relational storage mapping, that is evolved by splitting a complex type into two complex types. In [Example 20-5](#) (page 20-17), complex type `ShippingInstructionsType` is split into two complex types, `Person-Name` and `Contact-Info`, and the `ShippingInstructionsType` complex type is deleted.

Even if this XML schema has no associated instance documents, and therefore no data copy is required, a change in the layout of existing tables is required to accommodate future instance documents.

Example 20-5 Splitting a Complex Type into Two Complex Types

These code excerpts show the definitions of the original `ShippingInstructionsType` type and the new `Person-Name` and `Contact-Info` types.

```
<complexType name="ShippingInstructionsType">
  <sequence>
    <element name="name" type="NameType" minOccurs="0"/>
    <element name="address" type="AddressType" minOccurs="0"/>
    <element name="telephone" type="TelephoneType" minOccurs="0"/>
  </sequence>
</complexType>

<complexType name="Person-Name">
  <sequence>
    <element name="name" type="NameType" minOccurs="0"/>
  </sequence>
</complexType>

<complexType name="Contact-Info">
  <sequence>
    <element name="address" type="AddressType" minOccurs="0"/>
    <element name="telephone" type="TelephoneType" minOccurs="0"/>
  </sequence>
</complexType>
```

20.3.1.1.2 Reorder of XML Schema Constructs

You cannot use in-place evolution to reorder XML schema elements in a way that affects the DOM fidelity of XML instance documents. For example, you cannot change the order of elements within a `<sequence>` element in a complex type definition.

As an example, if a complex type named `ShippingInstructionsType` requires that its child elements `name`, `address`, and `telephone` be in that order, you cannot use in-place evolution to change the order to `name`, `telephone`, and `address`.

20.3.1.1.3 Changes from a Collection to a Non-Collection

You cannot use in-place evolution to change a collection to a non-collection. An example would be changing from `maxOccurs` greater than one to `maxOccurs` equal to one. In-place evolution thus cannot delete an element from a complex type if the deletion requires that a collection be evolved to a non-collection.

20.3.1.1.4 Model Changes within a complexType Element

A **model** is a group, choice, sequence, or all element. Within a `complexType` element you cannot use in-place evolution to either add a new model or replace an existing model with a model of another type (for example, replace a choice element with a sequence element).

You can, however, add a global group element, that is, add a `group` element outside of a `complexType` element.

20.3.1.2 Other Restrictions on In-Place Evolution

Some restrictions on in-place XML schema evolution are necessary for reasons other than backward compatibility of the evolved XML schema.

20.3.1.2.1 Changes to Attributes in Namespace xdb

Except for attribute `xdb:defaultTable`, you cannot use in-place evolution to modify any attributes in namespace `http://xmlns.oracle.com/xdb` (which has the predefined prefix `xdb`).

20.3.1.2.2 Changes from a Non-Collection to a Collection

For object-relational `XMLType` data, you cannot use in-place evolution to change a non-collection object type to a collection object type. An example would be adding an element to a complex type if the element is already present in the type (or in a type related through inheritance).

20.3.2 Supported Operations for In-Place XML Schema Evolution

Some of the operations that are supported for in-place schema evolution are described. Some of these are not permitted in specific contexts, which are specified.

- Add an optional element to a complex type or group: Always permitted. An example is the addition of the optional element `shipmethod` in the following complex type definition:

```
<xs:complexType name="ShippingInstructionsType">
  <xs:sequence>
    <xs:element name="name" type="NameType" minOccurs="0"/>
    <xs:element name="address" type="AddressType" minOccurs="0"/>
    <xs:element name="telephone" type="TelephoneType" minOccurs="0"/>
    <xs:element name = "shipmethod" type = "xs:string" minOccurs = "0"/>
  </xs:sequence>
</xs:complexType>
```

- Add an optional attribute to a complex type or attribute group: Always permitted. An example is the addition of the optional attribute `shipbydate` in the following complex type definition:

```
<xs:complexType name="ShippingInstructionsType">
  <xs:sequence>
    <xs:element name="name" type="NameType" minOccurs="0"/>
    <xs:element name="address" type="AddressType" minOccurs="0"/>
    <xs:element name="telephone" type="TelephoneType" minOccurs="0"/>
  </xs:sequence>
  <xs:attribute name="shipbydate" type="DateType" use="optional"/>
</xs:complexType>
```

- Convert an element from simple type to complex type with simple content: Supported only if the storage model is binary XML.
- Modify the value attribute of an existing `maxLength` element: Always permitted. The value can only be increased, not decreased.
- Add an enumeration value: You can add a new enumeration value only to the end of an enumeration list.
- Add a global element: Always permitted. An example is the addition of the global element `PurchaseOrderComment` in the following schema definition:

```
<xs:schema ...>
...
  <xs:element name="PurchaseOrderComment" type="string" xdb:defaultTable=""/>
```

```
..
</xs:schema>
```

- Add a global attribute: Always permitted.
- Add or delete a global complex type: Always permitted. An example is the addition of the global complex type `ComplexAddressType` in the following schema definition:

```
<xs:schema ...>
...
  <xs:complexType name="ComplexAddressType">
    <xs:sequence>
      <xs:element name="street" type="string"/>
      <xs:element name="city" type="string"/>
      <xs:element ref="zip" type="positiveInteger"/>
      <xs:element name="country" type="string"/>
    </xs:sequence>
  </xs:complexType>
...
</xs:schema>
```

- Add or delete a global simple type: Always permitted.
- Change the `minOccurs` attribute value: The value of `minOccurs` can only be decreased.
- Change the `maxOccurs` attribute value: The value of `maxOccurs` can only be increased, and this is only possible for data stored as binary XML. That is, you cannot make any change to the `maxOccurs` attribute for data stored object-rationally.
- Add or delete a global group or `attributeGroup`: Always permitted. An example is the addition of an `Instructions` group in the following type definition:

```
<xsd:schema ...>
...
  <xsd:group name="Instructions">
    <xsd:sequence>
      <xsd:element name="ShippingInstructions" type="ShippingInstructionsType"/>
      <xsd:element name="SpecialInstructions" type="SpecialInstructionsType"/>
    </xsd:sequence>
  </xsd:group>
...
</xsd:schema>
```

- Change the `xdb:defaultTable` attribute value: Always permitted. Changes are *not* permitted to any other attributes in the `xdb` namespace.
- Add, modify, or delete a comment or processing instruction: Always permitted.

20.3.3 Guidelines for Using In-Place XML Schema Evolution

Guidelines that apply to in-place XML-schema evolution are presented. (Be sure to back up your data before performing in-place schema evolution.)

- *Before* you perform an in-place XML-schema evolution:
 - *Back up all existing data* (instance documents) for the XML schema to be evolved.

Caution:

Make sure that you back up your data before performing in-place XML schema evolution, in case the result is not what you intended. There is *no rollback* possible after an in-place evolution. If any errors occur during evolution, or if you make a major mistake and need to redo the entire operation, you must be able to go back to the backup copy of your original data.

- *Perform a dry run* using trace only, that is, without actually evolving the XML schema or updating any instance documents, produce a trace of the update operations that would be performed during evolution. To do this, set the `flag` parameter value to only `INPLACE_TRACE`. Do not also use `INPLACE_EVOLVE`.

After performing the dry run, examine the trace file, verifying that the listed DDL operations are in fact those that you intend.

- *After you perform an in-place XML-schema evolution:*

If you are accessing the database using a client that caches data, or if you are not sure whether this is the case, then *restart your client*. Otherwise, the pre-evolution version of the XML schema might continue to be used locally, with unpredictable results.

See Also:

Oracle Database Administrator's Guide for information about using trace files

20.3.4 inPlaceEvolve Parameters

The parameters of PL/SQL procedure `DBMS_XMLSCHEMA.inPlaceEvolve` are described, as are the errors associated with this procedure.

This is the signature of procedure `DBMS_XMLSCHEMA.inPlaceEvolve`:

```
procedure inPlaceEvolve(schemaURL IN VARCHAR2,
                       diffXML   IN XMLType,
                       flags      IN NUMBER);
```

[Table 20-6](#) (page 20-20) describes the individual parameters.

Table 20-6 Parameters of Procedure `DBMS_XMLSCHEMA.INPLACEEVOLVE`

Parameter	Description
<code>schemaURL</code>	URL of the XML schema to be evolved (<code>VARCHAR2</code>).
<code>diffXML</code>	XML document (<code>XMLType</code> instance) that conforms to the <code>xdiff</code> XML schema, and that specifies the changes to apply and the locations in the XML schema where the changes are to be applied. For information about how to create the document for this parameter, see The diffXML Parameter Document (page 20-21).

Table 20-6 (Cont.) Parameters of Procedure DBMS_XMLSCHEMA.INPLACEEVOLVE

Parameter	Description
<code>flags</code>	<p>A bit mask that controls the behavior of the procedure. You can set the following bit values in this mask independently, summing them to define the overall effect. The default <code>flags</code> value is 1 (bit 1 on, bit 2 off), meaning that in-place evolution is performed and no trace is written.</p> <ul style="list-style-type: none"> <code>INPLACE_EVOLVE</code> (value 1, meaning that bit 1 is on) – Perform in-place XML schema evolution. Construct a new XML schema and validate it (against the XML schema for XML schemas). Construct the DDL statements needed to evolve the instance-document disk structures. Execute the DDL statements. Replace the old XML schema with the new. <code>INPLACE_TRACE</code> (value 2, meaning that bit 2 is on) – Perform all steps necessary for in-place evolution, <i>except</i> executing the DDL statements and overwriting the old XML schema with the new, then write both the DDL statements and the new XML schema to a trace file. <p>That is, each of the bits constructs the new XML schema, validates it, and determines the steps needed to evolve the disk structures underlying the instance documents. In addition:</p> <ul style="list-style-type: none"> Bit <code>INPLACE_EVOLVE</code> carries out those evolution steps and replaces the old XML schema with the new. Bit <code>INPLACE_TRACE</code> saves the evolution steps and the new XML schema in a trace file (it does not carry out the evolution steps).

Procedure `DBMS_XMLSCHEMA.inPlaceEvolve` raises an error in the following cases:

- An XPath expression is invalid, or is syntactically correct but does not target a node in the XML schema.
- The `diffXML` document does not conform to the `xdiff` XML schema.
- The change makes the XML schema invalid or not well formed.
- A generated DDL statement (`CREATE TYPE`, `ALTER TYPE`, and so on) causes a problem when it is executed.
- An index object associated with an `XMLType` table is in an unsafe state, which could be caused by partition management operations.

20.3.5 The diffXML Parameter Document

The value of parameter `diffXML` of procedure `DBMS_XMLSCHEMA.inPlaceEvolve` is an `XMLType` instance that specifies the changes to be applied to an XML schema for in-place evolution. This `diffXML` document contains a sequence of operations that describe the changes between the old XML schema and the new (the intended evolution result).

The changes specified by the `diffXML` document are applied in order.

You must create the XML document to be used for the `diffXML` parameter. You can do this in any of the following ways:

- The `XMLDiff` JavaBean (`oracle.xml.differ.XMLDiff`)
- The `xmldiff` command-line utility
- SQL function `XMLDiff`

The `diffXML` parameter document must conform to the `xdiff` XML schema.

The rest of this section presents examples of some operations in a document that conforms to the `xdiff` XML schema.

See Also:

- [xdiff.xsd: XML Schema for Comparing Schemas for In-Place Evolution](#) (page A-29)
 - *Oracle XML Developer's Kit Programmer's Guide* for information on using the `XMLDiff` JavaBean
 - *Oracle XML Developer's Kit Programmer's Guide* for information on command-line utility `xmldiff`
 - *Oracle Database SQL Language Reference* for information on SQL function `XMLDiff`
-
-

20.3.5.1 diffXML Operations and Examples

Operations that can be specified in the `diffXML` document supplied to procedure `DBMS_XMLSCHEMA.inPlaceEvolve` are described. An example XML document that conforms to the `xdiff` XML schema is shown.

The `<append-node>` element is used for most of the supported changes, such as adding a new attribute to a complex type or appending a new element to a group.

The `<insert-node-before>` element specifies that a node of the given type should be inserted before the specified node. The `xpath` attribute specifies the location of the specified node and the `node-type` attribute specifies the type of node to be inserted. The node to be inserted is specified by the `<content>` child element. The `<insert-node-before>` element is mainly used for inserting comments and processing instructions, and for changing and adding add annotation elements.

The `<delete-node>` element specifies that the node with the given XPath (specified by the `xpath` attribute) should be deleted along with all its children. For example, you can use this element to delete comments and annotation elements. You can also use this element, in conjunction with `<append-node>` or `<insert-node-before>`, to make changes to an existing node.

[Example 20-6](#) (page 20-22) shows an XML document for the `diffXML` parameter that specifies the following changes:

- Delete complex type `PartType`.
- Add complex type `PartType` with a maximum length of 28.
- Add a comment before element `ShippingInstructions`.
- Add a required element `shipmethod` to element `ShippingInstructions`.

Example 20-6 *diffXML Parameter Document*

```
<xdiff xmlns="http://www.w3c.org/2001/XMLSchema"
  xmlns:xd="http://xmlns.oracle.com/xdb/xdiff.xsd"
  xmlns:xsi="http://www.w3c.org/2001/XMLSchema-Instance"
  xsi:schemaLocation="http://xmlns.oracle.com/xdb/xdiff.xsd
  http://xmlns.oracle.com/xdb/xdiff.xsd">
  <xd:delete-node xpath="/schema/complexType[@name='PartType']//maxLength/>
```

```
<xd:append-node
  parent-xpath = "/schema/complexType[@name=&quote;PartType&quote;]//restriction"
  node-type = "element">
  <xd:content>
    <xs:maxLength value = "28"/>
  </xd:content>
</xd:append-node>
<xd:insert-node-before
  xpath="/schema/complexType[@name =&quote;ShippingInstructionsType&quote;]/sequence"
  node-type="comment">
  <xd:content>
    <!-- A type representing instructions for shipping -->
  </xd:content>
</xd:insert-node-before>
<xd:append-node
  parent-xpath="/schema/complexType[@name=&quote;ShippingInstructionsType&quote;]/sequence"
  node-type="element">
  <xd:content>
    <xs:element name = "shipmethod" type = "xs:string" minOccurs = "1"/>
  </xd:content>
</xd:append-node>
</xd:xdiff>
```

Part VI

Oracle XML DB Repository

Oracle XML DB Repository lets you version your data, implement and manage security, and use APIs to access and manipulate repository resources.

- [Access to Oracle XML DB Repository Data](#) (page 21-1)
- [Configuration of Oracle XML DB Repository](#) (page 22-1)
- [Use of XLink and XInclude with Oracle XML DB](#) (page 23-1)
- [Repository Access Using RESOURCE_VIEW and PATH_VIEW](#) (page 24-1)
- [Resource Versions](#) (page 25-1)
- [PL/SQL Access to Oracle XML DB Repository](#) (page 26-1)
- [Repository Access Control](#) (page 27-1)
- [Repository Access Using Protocols](#) (page 28-1)
- [User-Defined Repository Metadata](#) (page 29-1)
- [Oracle XML DB Repository Events](#) (page 30-1)
- [Guidelines for Oracle XML DB Applications in Java](#) (page 31-1)
- [Data Access Using URIs](#) (page 32-1)
- [Native Oracle XML DB Web Services](#) (page 33-1)

Access to Oracle XML DB Repository Data

There are several ways to access and manipulate data in Oracle XML DB Repository, including using standard protocols such as FTP and HTTP(S)/WebDAV; Oracle XML DB resource Application Program Interfaces (APIs); and the repository views `RESOURCE_VIEW` and `PATH_VIEW`.

- [Overview of Oracle XML DB Repository](#) (page 21-1)
- [Repository Terminology and Supplied Resources](#) (page 21-5)
- [Oracle XML DB Repository Resources](#) (page 21-7)
- [Navigational or Path Access to Repository Resources](#) (page 21-14)
- [Query-Based Access to Repository Resources](#) (page 21-19)
- [Servlet Access to Repository Resources](#) (page 21-20)
- [Operations on Repository Resources](#) (page 21-20)
- [Accessing the Content of Repository Resources Using SQL](#) (page 21-28)
- [Access to the Content of XML Schema-Based Documents](#) (page 21-29)
- [Update of the Content of Repository Documents](#) (page 21-30)
- [Querying Resources in `RESOURCE_VIEW` and `PATH_VIEW`](#) (page 21-34)
- [Oracle XML DB Hierarchical Repository Index](#) (page 21-37)

21.1 Overview of Oracle XML DB Repository

Using Oracle XML DB Repository you can store content in the database in hierarchical structures, as opposed to traditional relational database structures. Although the repository can manage any kind of content, it provides specialized capabilities and optimizations related to managing resources with XML content.

Relational databases are traditionally poor at managing hierarchical structures and traversing a path or a URL. Oracle XML DB Repository provides you with a hierarchical organization of XML content in the database. You can query and manage it as if it were organized using files and folders.

The relational table-row-column metaphor is an effective model for managing highly structured data. It can be less effective for managing semi-structured and unstructured data, such as document-oriented XML data.

For example, a book is not easily represented as a set of rows in a table. It might be more natural to represent a book as a hierarchy, book — chapter — section — paragraph, and to represent the hierarchy as a set of folders and subfolders.

A hierarchical repository index speeds up folder and path traversals. Oracle XML DB includes a patented hierarchical index that speeds up folder and path traversals in Oracle XML DB Repository. The hierarchical repository index is transparent to end users, and lets Oracle XML DB perform folder and path traversals at speeds comparable to or faster than conventional file systems.

Figure 21-1 (page 21-2) is an example of a hierarchical structure that shows a typical tree of folders and files in Oracle XML DB Repository. The top of the tree shows /, the root folder.

Figure 21-1 A Folder Tree, Showing Hierarchical Structures in the Repository

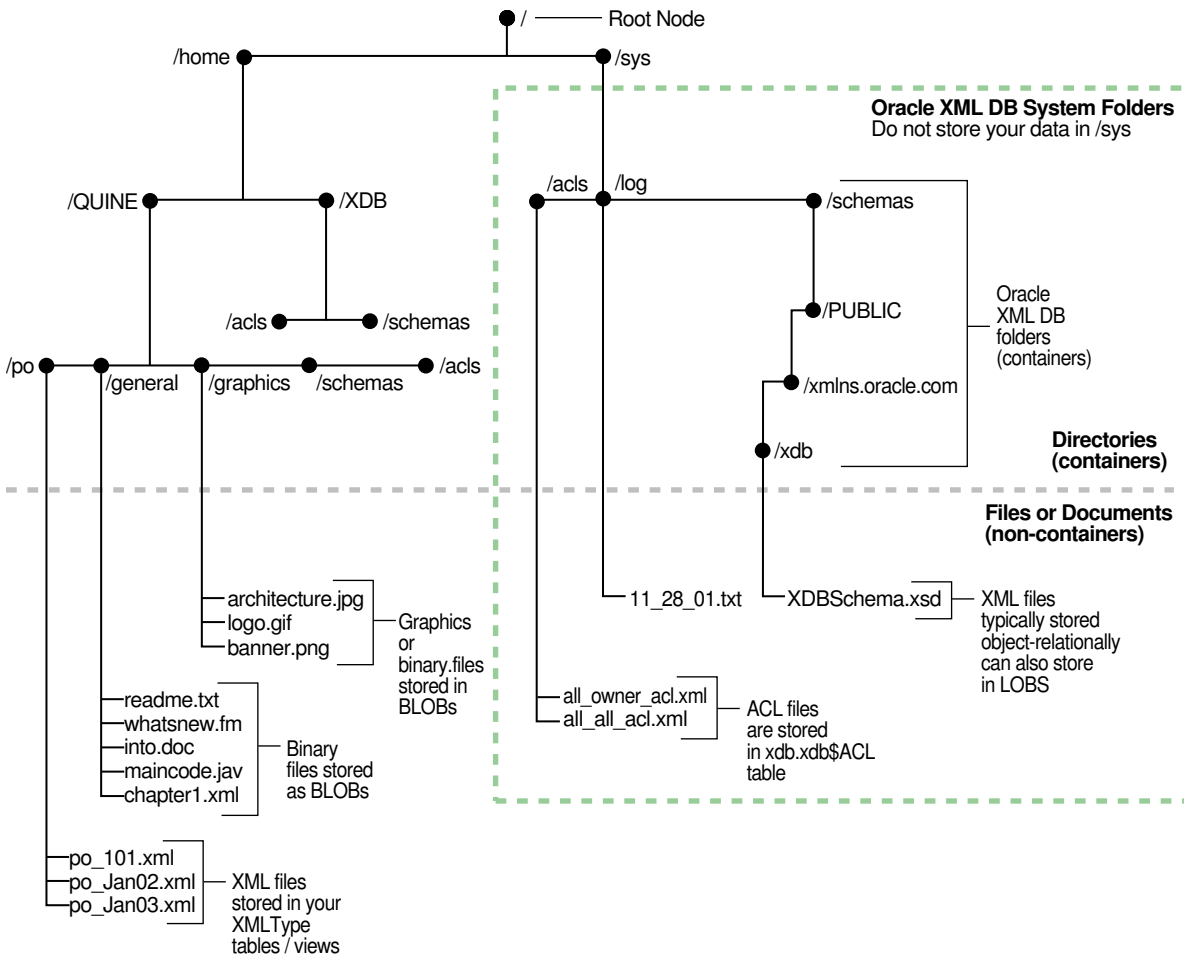

Caution:

Folder /sys is used by Oracle XML DB to maintain *system-defined* XML schemas, access control lists (ACLs), and so on. Do *not* add or modify any data in folder /sys.

Your applications can access content in Oracle XML DB Repository using standard connect-access protocols such as FTP, HTTP(S), and WebDAV, in addition to languages SQL, PL/SQL, Java, and C. Oracle XML DB adds native support to Oracle Database for these protocols, which were designed for document-centric operations. By providing support for these protocols, Oracle XML DB lets Microsoft Windows

Explorer, Microsoft Office, and products from vendors such as Altova and Adobe work directly with XML content stored in the repository.

The repository gives you direct access to XML content stored in Oracle Database, as if it were stored in a file system. You can set access control privileges on repository files and folders.

These features are available because the repository is modeled on **WebDAV**, an IETF standard that defines a set of extensions to the HTTP protocol. WebDAV lets an HTTP server act as a file server for a DAV-enabled client. For example, a WebDAV-enabled editor can interact with an HTTP/WebDAV server as if it were a file system.

The WebDAV standard uses the term **resource** to describe a file or a folder. Each resource managed by a WebDAV server is identified by a URL. A resource has not only content but also associated metadata.

The following topics cover how to access data in Oracle XML DB Repository folders using the standard protocols. They discuss APIs that you can use to access the repository object hierarchy using Java, SQL, and PL/SQL.

See Also:

- [Repository Access Using RESOURCE_VIEW and PATH_VIEW](#) (page 24-1)
 - [PL/SQL Access to Oracle XML DB Repository](#) (page 26-1)
 - [Repository Access Control](#) (page 27-1)
 - [Repository Access Using Protocols](#) (page 28-1)
-
-

21.1.1 Oracle XML DB Provides Name-Level Locking

One key advantage of Oracle XML DB Repository is the ability to use SQL for repository operations in the context of a logical transaction. Applications can create long-running transactions that include updates to multiple folders. To provide high levels of concurrency, the repository uses name-level locking rather than folder-level locking

When using a relational database to maintain hierarchical folder structures, ensuring a high degree of concurrency when adding and removing items in a folder is a challenge. In conventional file systems there is no concept of a transaction. Each operation (add a file, create a subfolder, rename a file, delete a file, and so on) is treated as an atomic transaction. Once the operation has completed the change is immediately available to all other users of the file system.

In this situation, a conventional locking strategy that takes an exclusive lock on each updated folder or directory tree would quickly result in significant concurrency problems. Oracle XML DB solves this by providing for name-level locking rather than folder-level locking. Repository operations such as creating, renaming, moving, or deleting a sub-folder or file do not require that your operation be granted an exclusive write lock on the target folder. The repository manages concurrent folder operations by locking the name within the folder rather than the folder itself. The name and the modification type are put on a queue.

Only when the transaction is committed is the folder locked and its contents modified. Hence Oracle XML DB lets multiple applications perform concurrent updates on the

contents of a folder. The queue is also used to manage folder concurrency by preventing two applications from creating objects with the same name.

Queuing folder modifications until commit time also minimizes I/O when a number of changes are made to a single folder in the same transaction. This is useful when several applications generate files quickly in the same directory, for example when generating trace or log files, or when maintaining a spool directory for printing or e-mail delivery.

Note:

As a consequence of transactional semantics enforced by the database, folders created using SQL statements are *not* visible to other database users until the transaction is committed. *Concurrent* access to Oracle XML DB Repository is controlled by the same mechanism used to control concurrency in Oracle Database. The integration of the repository with Oracle Database provides *strong management options for XML content*.

21.1.2 Two Ways to Access Oracle XML DB Repository Resources

You can access and manipulate Oracle XML DB Repository resources using SQL with special views or by navigating paths using a hierarchical index.

- SQL access. This is done using special views that expose resource properties and path names, and map hierarchical access operators onto the Oracle XML DB schema. See [Query-Based Access to Repository Resources](#) (page 21-19).
- Navigational or path-based access. This uses a hierarchical index of resources. Each resource has one or more unique path names that reflect its location in the hierarchy. You can navigate, using XPath expressions, to any repository resource.

A repository resource can be created as a reference to an existing `XMLTYPE` object in the database. You can navigate to any such database object using XPath. See [Navigational or Path Access to Repository Resources](#) (page 21-14).

See Also:

- [Oracle XML DB Repository Access](#) (page 2-5) for guidance on selecting an access method
 - [Table 21-3](#) (page 21-21) for a summary comparison of the access methods
-
-

A Uniform Resource Locator (URL) is used to access an Oracle XML DB resource. A URL includes the host name, protocol information, path name, and resource name of the object.

21.1.3 Database Schema (User Account) XDB and Oracle XML DB Repository

Database schema (user account) XDB owns `XMLTYPE` table `XDB$RESOURCE`, which contains all of the resources (files and folders) in Oracle XML DB Repository. It also contains all of the *metadata* for managing the repository.

Database schema XDB is created during Oracle XML DB installation. The primary table in this schema is an `XMLTYPE` table called `XDB$RESOURCE`, which contains one row for each resource (file or folder) in Oracle XML DB Repository. Documents in this table

are referred to as **resource documents**. The XML schema that defines the structure of an Oracle XML DB resource document is registered under URL "<http://xmlns.oracle.com/xdb/XDBResource.xsd>."

The tables owned by database schema (user) XDB are *internal*. Oracle recommends the following:

- Create a *dedicated tablespace* for use only by user XDB, which means also for Oracle XML DB Repository. Ensure that the tablespace is *not* read-only.
- Do *not* directly manipulate any tables or data owned by user XDB. For example, do not compress or uncompress them.

Use only the PL/SQL subprograms and database views provided by Oracle XML DB to carry out operations on any tables or data owned by user XDB.

- *Never unlock* user XDB, under any circumstance.

See Also:

- [Package DBMS_XDB_ADMIN](#) (page 34-14), for information about creating a dedicated tablespace for user XDB and the repository
 - *Oracle Database 2 Day + Security Guide* for information about database schema XDB
-
-

21.2 Repository Terminology and Supplied Resources

Oracle XML DB Repository can be thought of as a file system of database objects rather than files. It is a hierarchical set of database objects, across all XML and database schemas, that are mapped to path names.

The repository is a connected, directed, acyclic¹ graph of resources, with a single root node (/). Each resource in the graph has one or more associated path names: the repository supports multiple links to a given resource.

21.2.1 Repository Terminology

Some terms that apply to Oracle XML DB Repository include resource, resource name, resource content, folder or directory, path name, path components, link name, access control list (ACL), and XDBBinary element. Some of these terms have common synonyms in other contexts.

- **resource** – Any object or node in the repository hierarchy. A resource is identified by a Uniform Resource Locator (URL), which includes the path name and resource name of the object.

See Also:

- [Oracle XML DB Repository: Overview](#) (page 1-16)
 - [Oracle XML DB Repository Resources](#) (page 21-7)
-
-

¹ The graph is established by the hard links that define the repository structure, and cycles are not permitted using hard links. You can, however, introduce cycles using weak links. See [Hard Links and Weak Links](#) (page 21-11).

- **folder** – A resource that can contain other resources. Sometimes called a **directory**.
- **path name** – A hierarchical name representing an absolute path to a resource. It is composed of a slash (/) representing the repository root, followed by zero or more **path components** separated by slashes. A path component cannot be only . or .., but a period (.) can otherwise be used in a path component. A path component is composed of any characters in the database character set *except* slash (/), backslash (\), and those characters specified in the Oracle XML DB configuration file, `xdbconfig.xml`, by configuration parameter `/xdbconfig/sysconfig/invalid-pathname-chars`.
- **resource name (or link name)** – The name of a resource within its parent folder. This is the rightmost path component of a path name. Resource names must be unique within their immediately containing folder, and they are case-sensitive.
- **resource content** – The body, or data, of a resource. This is what you get when you treat the resource as a file and ask for its content. This is always of type `XMLType`.
- **access control list (ACL)** – An ordered list of rules that specify access privileges for principals (users or roles) to one or more repository resources.

See Also:

[Repository Access Control](#) (page 27-1)

- **XDBBinary element** – An XML element that contains binary data. It is defined by the Oracle XML DB XML schema. `XDBBinary` elements are stored in the repository whenever unstructured binary data is uploaded into Oracle XML DB.

Many terms used by Oracle XML DB have common synonyms in other contexts, as shown in [Table 21-1](#) (page 21-6).

Table 21-1 Synonyms for Oracle XML DB Repository Terms

Synonym	Repository Term	Usage
collection	folder	WebDAV
directory	folder	operating systems
privilege	privilege	permission
right	privilege	various
WebDAV folder	folder	Web folder
role	group	access control
revision	version	RCS, CVS
file system	repository	operating systems
hierarchy	repository	various
file	resource	operating systems
binding	link	WebDAV

21.2.2 Predefined Repository Files and Folders

Certain files and folders are predefined for Oracle XML DB Repository. You can create additional ones for your own use.

These are the predefined Oracle XML DB Repository files and folders:

```

/dbfs22
/public
/sys
/sys/acls
/sys/acls/all_all_acl.xml
/sys/acls/all_owner_acl.xml
/sys/acls/bootstrap_acl.xml
/sys/acls/ro_all_acl.xml
/sys/apps
/sys/asm
/sys/log
/sys/schemas
/sys/schemas/PUBLIC
/sys/schemas/PUBLIC/www.w3.org
/sys/schemas/PUBLIC/www.w3.org/2001
/sys/schemas/PUBLIC/www.w3.org/2001/xml.xsd
/sys/schemas/PUBLIC/xmlns.oracle.com
/sys/schemas/PUBLIC/xmlns.oracle.com/xdb
/sys/schemas/PUBLIC/xmlns.oracle.com/xdb/XDBResource.xsd
/sys/schemas/PUBLIC/xmlns.oracle.com/xdb/XDBSchema.xsd
/sys/schemas/PUBLIC/xmlns.oracle.com/xdb/XDBStandard.xsd
/sys/schemas/PUBLIC/xmlns.oracle.com/xdb/acl.xsd
/sys/schemas/PUBLIC/xmlns.oracle.com/xdb/dav.xsd
/sys/schemas/PUBLIC/xmlns.oracle.com/xdb/log
/sys/schemas/PUBLIC/xmlns.oracle.com/xdb/stats.xsd
/sys/schemas/PUBLIC/xmlns.oracle.com/xdb/xdbconfig.xsd
/xdbconfig.xml

```

21.3 Oracle XML DB Repository Resources

Oracle XML DB Repository resources conform to the Oracle XML DB XML schema `XDBResource.xsd`. The elements in a resource include those needed to persistently store WebDAV-defined properties, such as creation date, modification date, WebDAV locks, owner, ACL, language, and character set.

See Also:

[XDBResource.xsd: XML Schema for Oracle XML DB Resources](#) (page A-1)

A resource index has a special element called **Contents** that contains the contents of the resource.

The XML schema for a resource also defines an **any** element, with `maxOccurs` attribute unbounded. An **any** element can contain any element outside of the Oracle XML DB XML namespace. Arbitrary instance-defined properties can be associated with the resource.

²² Repository folder `/dbfs` gives you protocol access to your DBFS content. See *Oracle Database SecureFiles and Large Objects Developer's Guide* for information about DBFS.

21.3.1 Where Is Repository Data Stored?

Oracle XML DB stores Oracle XML DB Repository data in a set of tables and indexes to which you have access.

If you register an XML schema and request that the tables be generated by Oracle XML DB, then the tables are created in your database schema. You are then able to see or modify them. Other users cannot see your tables unless you grant them permission to do so.

21.3.1.1 Names of Generated Tables

The names of generated tables are assigned by Oracle XML DB. They can be obtained by finding the `xdb:defaultTable` attribute in your XML schema document (or in the default XML schema document).

When you register an XML schema, you can alternatively provide your own table name, instead of using the default name supplied by Oracle XML DB. If the table specifies binary XML storage, then a document is encoded in binary XML format before storing it in the table.

See Also:

[Default Tables Created during XML Schema Registration](#) (page 18-5)

21.3.1.2 How Object-Relational Storage Is Defined for Repository Resources

You can define object-relational storage for repository resources by subclassing or by storing data that conforms to a registered XML schema.

Applications that need to define object-relational storage for repository resources can do so in either of these ways:

- Subclass the Oracle XML DB resource type. Subclassing Oracle XML DB resources requires privileges on the table `XDB$RESOURCE`.
- Store data that conforms to a visible, registered XML schema.

See Also:

[XML Schema Storage and Query: Basic](#) (page 17-1)

21.3.1.3 Oracle ASM Virtual Folder

The contents of the Oracle Automatic Storage Management (Oracle ASM) virtual folder, `/sys/asm` are Oracle ASM files and folders that are managed automatically by Oracle ASM.

See Also:

- [Access to Oracle ASM Files Using Protocols and Resource APIs – For DBAs](#) (page 21-17)
 - *Oracle Automatic Storage Management Administrator's Guide*
-
-

21.3.2 How Documents are Stored in Oracle XML DB Repository

When an XML document that is based on a registered XML schema is loaded into the repository, the document is parsed and decomposed according to the schema into a set of SQL objects; and a corresponding resource document is created to provide repository access for the source XML document.

Oracle XML DB provides special handling for XML documents. The rules for storing the contents of an XML Schema-based XML document are defined by its XML schema. The content of the document is stored in the default table associated with the global element definition.

Oracle XML DB Repository also stores files that do not contain XML data, such as JPEG images or Word documents. The XML schema for each resource defines which elements are allowed, and specifies whether the content of these files is to be stored as BLOB or CLOB instances. The content of a non-schema-based XML document is stored as a CLOB instance in the repository.

There is one resource and one link-properties document for each file or folder in the repository. If there are multiple access paths to a given document then there is a link-properties document for each possible link. Both the resource document and the link-properties are stored as XML documents. All these documents are stored in tables in the repository.

When an XML file is loaded into the repository, the following sequence of events takes place:

1. Oracle XML DB examines the root element of the XML document to see if it is associated with a known (registered) XML schema. This involves looking to see if the document includes a namespace declaration for the `XMLSchema-instance` namespace, and then looking for a `schemaLocation` or `noNamespaceSchemaLocation` attribute that identifies which XML schema the document is associated with.
2. If the document is based on a known XML schema, then the metadata for the XML schema is loaded from the XML schema cache.
3. The XML document is parsed and decomposed into a set of SQL objects derived from the XML schema.
4. The SQL objects created from the XML file are stored in the default table defined when the XML schema was registered with the database.
5. A resource document is created for each document processed. This lets the content of the document be accessed using the repository. The resource document for an XML Schema-based `XMLType` instance includes an `XMLRef` element. This element contains a `REF` of `XMLType` that can be used to locate the row in the default table containing the content associated with the resource.

21.3.3 Repository Data Access Control

You can control access to the resources in Oracle XML DB Repository by using access control lists (ACLs), which are composed of access control entries (ACEs). An ACE grants or denies a set of privileges to a specific principal.

A principal can be a database user, a database role, an LDAP user, an LDAP group or the special principal `DAV:owner`, which refers to the owner of the resource. Each resource in the repository is protected by an ACL. The ACL determines which

privileges, such as `read-properties` and `update`, a user has on the resource. Each repository operation includes a check of the ACL to determine if the current user is allowed to perform the operation.

By default, a new resource inherits the ACL of its parent folder. But you can set the ACL of a resource using PL/SQL procedure `DBMS_XDB_REPOS.setACL`. For more details on Oracle XML DB resource security, see [Repository Access Control](#) (page 27-1).

In the following example, the current user is `QUINE`. The query gives the number of resources in the folder `/public`. Assume that there are only two resources in this folder: `f1` and `f2`. Also assume that the ACL on `f1` grants the `read-properties` privilege to `QUINE` while the ACL on `f2` does not grant `QUINE` any privileges. A user needs the `read-properties` privilege on a resource for it to be visible to the user. The result of the query is 1, because only `f1` is visible to `QUINE`.

```
SELECT count(*) FROM RESOURCE_VIEW r WHERE under_path(r.res, '/public') = 1;
```

```
COUNT(*)  
-----  
1
```

21.3.4 Repository Path-Name Resolution

The data relating a folder to its contents is managed by the Oracle XML DB hierarchical repository index. This provides a fast mechanism for evaluating path names which is similar to the directory mechanisms that are used by operating-system file systems. You need certain privileges to resolve a path name.

Resources that are folders have the `Container` attribute of element `Resource` set to `true`.

To resolve a resource name in a folder, the current user must have the following privileges:

- `resolve` privilege on the folder
- `read-properties` on the resource in that folder

If the user does not have these privileges, then the user receives an `access denied` error. Folder listings and other queries do not return a row when the `read-properties` privilege is denied on its resource.

Caution:

Error handling in path-name resolution differentiates between invalid resource names and resources that are not folders, for compatibility with file systems. Because Oracle XML DB resources are accessible from outside Oracle XML DB Repository (using SQL), denying read access on a folder that contains a resource does *not prevent* read access to that resource.

See Also:

[XDBResource.xsd: XML Schema for Oracle XML DB Resources](#) (page A-1) for the definition of element `Resource` and its attribute `Container`

21.3.5 Link Types

Links in Oracle XML DB can be repository links or document links. Repository links can be hard links or weak links. Document links can also be hard links or weak links, when their targets are repository resources.

21.3.5.1 Repository Links and Document Links

In addition to containing resources, a folder resource can contain links to other resources (files or folders). These repository links represent hierarchical repository relationships. By contrast, document links are arbitrary links among XML documents that are not necessarily repository resources.

Repository links are sometimes called **folder links**. They are not to be confused with **document links**, which correspond to the links provided by the XLink and XInclude standards, and which are also supported by Oracle XML DB (but XLink support is *deprecated*). Repository links are navigational, folder-child links among repository resources. Document links are arbitrary links among documents that are not necessarily repository resources.

Repository links represent repository hierarchical relationships. Document links represent arbitrary relationships whose semantics derives from the applications that use them. Because they represent repository hierarchical relationships, repository links can be navigated using file system-related protocols. This is not true of document links. Because document links can represent arbitrary relationships, they can also represent repository relationships. When document links thus target resources, they can also be hard or weak.

See Also:

[Use of XLink and XInclude with Oracle XML DB](#) (page 23-1) for information about document links

21.3.5.2 Hard Links and Weak Links

Links that target repository resources can be hard or weak. Hard and weak links have different dependencies with respect to the resources that they target. Hard links cannot target ancestor folders; weak links can. You can query the repository path view, `PATH_VIEW`, to determine the type of a repository link.

Both **hard links** and **weak links** are references, or pointers, to physical data — (internal) repository resource identifiers. They do not point to symbolic names or paths to other links. Their targets are resolved at the time of link creation. Because they point directly to resource identifiers, hard and weak links cannot dangle: they remain valid even when their targets are renamed or moved. You need the same privileges to create or delete hard and weak links.

The difference between hard and weak links lies in their relationship to target resource deletion. A target resource is dependent on its hard links, in the sense that it cannot be deleted as long as it remains the target of a hard link. Deletion of a hard link also deletes the resource targeted by the link, if the following are both true:

- The resource is not versioned.
- The hard link that was deleted was the last (that is, the only) hard link to the resource.

A weak link has no such hold on a resource: you can delete a resource, even if it is the target of a weak link (as long as it is not the target of a hard link). Because of this, weak links can be used as shortcuts to frequently accessed resources, without impacting deletion of those resources.

There is a dependency in the other direction, however: If you delete a resource that is the target of one or more weak links, then those links are automatically deleted, as well. In this sense, too, weak links cannot dangle. Both hard and weak links provide referential integrity: if a link exists, then so does its target.

Another difference between hard and weak links is this: Hard links to ancestor folders are not permitted, because they introduce cycles. There is no such restriction for weak links: a weak link can target any folder, possibly creating a cycle. It is the set of hard links that define the (acyclic) structure of Oracle XML DB Repository. Weak links represent an additional mapping on top of that basic structure.

You can query the repository path view, `PATH_VIEW`, to determine the type of a repository link: the link information contains the link type. `XMLType` column `LINK` of `PATH_VIEW` contains this information in element `LinkType`, which is a child of the root element, `LINK`. [Example 21-1](#) (page 21-12) illustrates this. You can also determine the type of a repository link by using the `getLink()` callback function on an event handler (`LinkIn`, `LinkTo`, `UnlinkIn`, or `UnlinkFrom`).

See Also:

- [Deleting Repository Resources: Examples](#) (page 24-14)
 - [Query-Based Access to Repository Resources](#) (page 21-19) for information about `PATH_VIEW`
 - *Oracle Database PL/SQL Packages and Types Reference* for information on PL/SQL function `getLink`
-
-

Example 21-1 Querying `PATH_VIEW` to Determine Link Type

```
SELECT RESID, XMLCast(XMLQuery('/LINK/LinkType' PASSING LINK RETURNING CONTENT)
                        AS VARCHAR2(24)) link_type
FROM PATH_VIEW WHERE equals_path(RES, '/home/QUINE/purchaseOrder.xml') = 1;
```

RESID	LINK_TYPE
DF9856CF2FE0829EE030578CCE0639C5	Weak

21.3.5.3 Creating a Weak Link with No Knowledge of Folder Hierarchy

Weak links represent a mapping on top of the repository structure, which is determined by hard links. You can create a weak link to a resource using its OID rather than its path. You can use weak links to access a resource without having access to the folders containing it.

Suppose that you want to read a file resource that belongs to one of your colleagues. You cannot create a hard link to that resource, to make it accessible for your use, unless you have the privilege `<xdb:resolve>` on *all* of the ancestor folders of that file. Having that privilege would mean that you could see all of your colleague's folder names and the structure of the hierarchy down to the target resource.

However, because weak links essentially represent a mapping on top of the real repository structure, which structure is determined by the set of hard links, you can

create a weak link to a resource using just its OID rather than its full, named path (URL). Your colleague can determine the OID path to the file, send you that instead of the named path, and you can create a weak link to the document using that OID path. [Example 21-2](#) (page 21-13) and [Example 21-3](#) (page 21-13) illustrate this.

[Example 21-2](#) (page 21-13) prints the OID path for the file resource `/home/QUINE/purchaseOrder.xml`. User `quine` can use this to obtain the OID path to the resource, and then send that path to user `curry`, who can create a weak link to the resource ([Example 21-3](#) (page 21-13)).

In [Example 21-3](#) (page 21-13), user `curry` creates a weak link named `quinePurchaseOrder.xml` in folder `/home/CURRY`. The target of the link is the OID path that corresponds to the URL `/home/QUINE/purchaseOrder.xml`. User `curry` need not be aware of the repository structure that is visible to user `quine`.

Example 21-2 Obtaining the OID Path of a Resource

```
DECLARE
  resoid RAW(16);
  oidpath VARCHAR2(100);
BEGIN
  SELECT RESID INTO resoid FROM RESOURCE_VIEW
     WHERE equals_path(RES, '/home/QUINE/purchaseOrder.xml') = 1;
  oidpath := DBMS_XDB_REPOS.createOIDPath(resoid);
  DBMS_OUTPUT.put_line(oidpath);
END;
```

Example 21-3 Creating a Weak Link Using an OID Path

```
CALL DBMS_XDB_REPOS.link('/sys/oid/1BDCB46477B59C20E040578CCE0623D3
                        '/home/CURRY', 'quinePurchaseOrder.xml',
                        DBMS_XDB_REPOS.LINK_TYPE_WEAK);
```

21.3.5.4 How and When to Prevent Multiple Hard Links

You can restrict the creation of hard links, disallowing multiple hard links to folders or files (or both). Allowing multiple hard links to file resources, but disallowing multiple hard links to folder resources, provides behavior that is similar to that for some file systems, including UNIX and Linux.

This can simplify application design, by, in effect, ensuring that each file resource has a unique, canonical hard-link path to it. In addition, preventing multiple hard links to a resource can lead to query performance improvements.

You can configure the prevention of multiple hard links using the following Boolean parameters in configuration file `xdbconfig.xml`. The default value of each parameter is `true`, meaning that multiple hard links can be created.

- `folder-hard-links` – Prevent the creation of multiple hard links to a folder resource, if `false`.
- `non-folder-hard-links` – Prevent the creation of multiple hard links to a file resource, if `false`.

See Also:

[Configuration of Oracle XML DB Using `xdbconfig.xml`](#) (page 34-5)

21.4 Navigational or Path Access to Repository Resources

Oracle XML DB Repository folders support the same protocol standards used by many operating systems. This lets a repository folder act like a native folder (directory) in supported operating-system environments.

For example:

- You can use Windows Explorer to open and access repository files and folders (resources) the same way you access other files and folders in the file system, as shown in [Figure 21-2](#) (page 21-14).
- You can access repository data using HTTP(S)/WebDAV from a Web browser, as shown in [Figure 21-3](#) (page 21-15) and [Figure 21-4](#) (page 21-15).

[Figure 21-3](#) (page 21-15) shows a browser visiting URL `http://xdbdemo:8080/`. The server it is connected to is `xdbdemo`, and its HTTP port number is 8080.

[Figure 21-4](#) (page 21-15) shows a browser using HTTP to visit an XML document (an XSL stylesheet) stored in the database. The URL is `http://localhost:8080/home/SCOTT/poSource/xsl/purchaseOrder.xsl`.

Figure 21-2 Oracle XML DB Folders in Windows Explorer

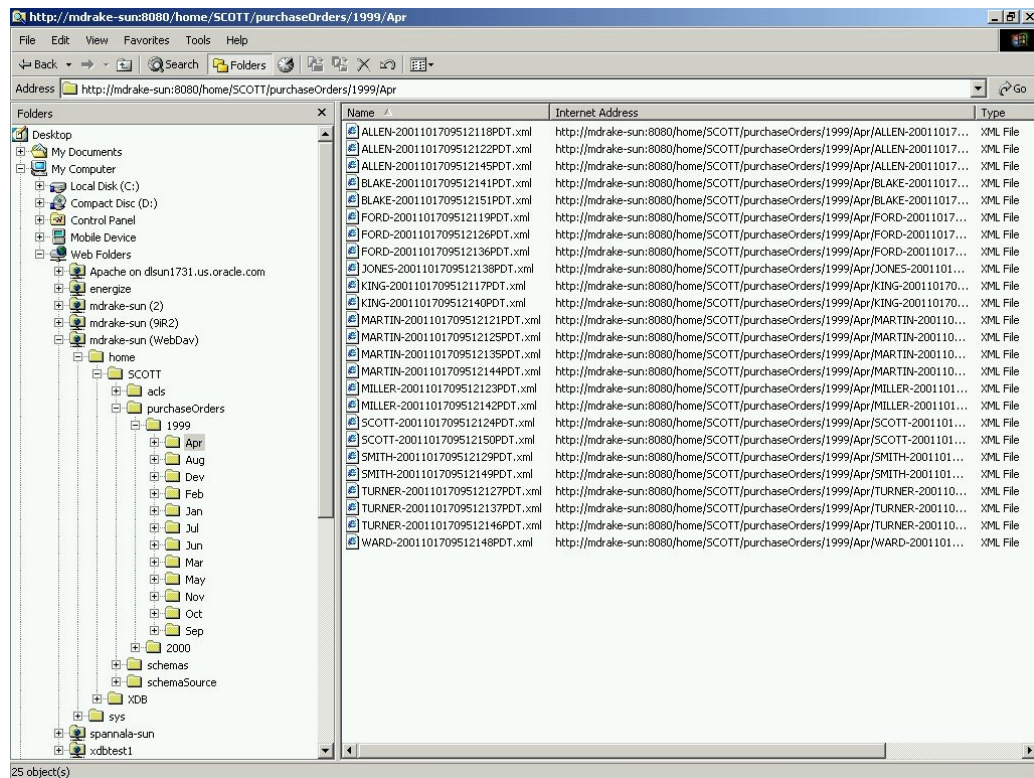

Figure 21-3 Accessing Repository Data Using HTTP(S)/WebDAV and a Web Browser

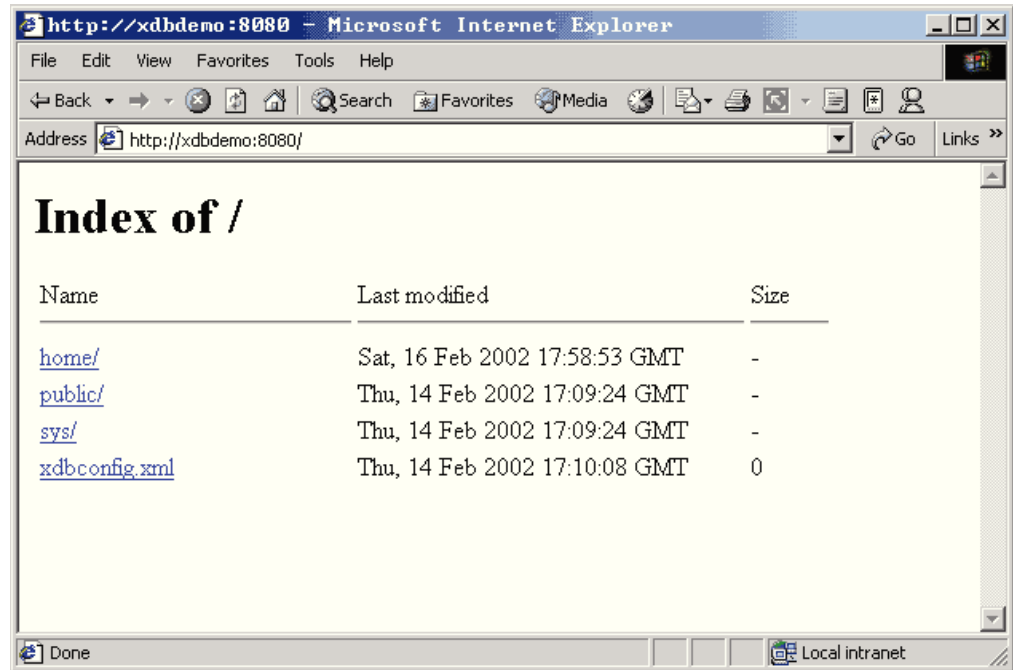
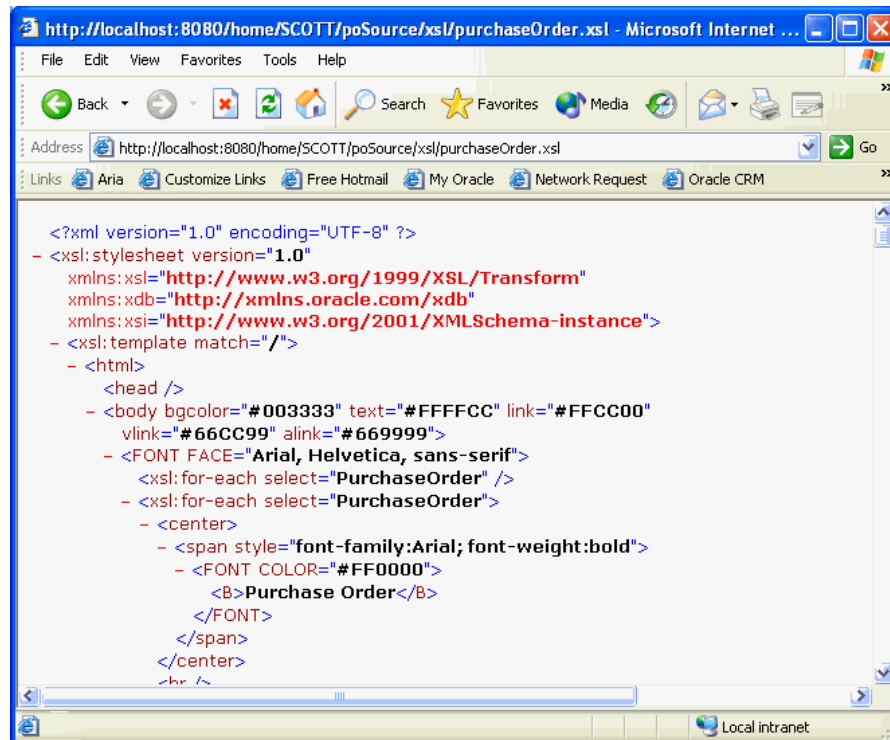

Figure 21-4 Path-Based Access Using HTTP and a URL



21.4.1 Access to Oracle XML DB Resources Using Internet Protocols

Oracle Net Services provides one way of accessing database resources. Oracle XML DB support for Internet protocols provides another way of accessing database resources.

21.4.1.1 Where You Can Use Oracle XML DB Protocol Access

Oracle Net Services is optimized for record-oriented data. Internet protocols are designed for stream-oriented data, such as binary files or XML text documents. Oracle XML DB protocol access is a valuable alternative to Net Services in certain scenarios.

- Direct database access from file-oriented applications using the database like a file system
- Heterogeneous application server environments that require a uniform data access method (such as XML over HTTP, which is supported by most data servers, including MS SQL Server, Exchange, Notes, many XML databases, stock quote services and news feeds)
- Application server environments that require data in the form of XML text
- Web applications that use client-side XSL to format datagrams that do not need much application processing
- Web applications that use Java servlets that run inside the database
- Web access to XML-oriented stored procedures

21.4.1.2 Overview of Protocol Access to Oracle XML DB

Protocol access to Oracle XML DB involves connecting, authenticating a user, parsing the request, and perhaps invoking a Java servlet.

Accessing Oracle XML DB using a protocol proceeds as follows:

1. A connection object is established, and the protocol might read part of the request.
2. The protocol decides whether the user is already authenticated and wants to reuse an existing session or the connection must be re-authenticated (the latter is more common).
3. An existing session is pulled from the session pool, or else a new one is created.
4. If authentication has not been provided, and the request is HTTP `get` or `head`, then the session is run as the `ANONYMOUS` user. If the session has already been authenticated as the `ANONYMOUS` user, then there is no cost to reuse the existing session. If authentication has been provided, then the database re-authentication routines are used to authenticate the connection.
5. The request is parsed.
6. (HTTP only) If the requested path name maps to a servlet, then the servlet is invoked using Java Virtual Machine (JVM). The servlet code writes the response to a response stream or asks `XMLType` instances to do so.

21.4.1.3 Retrieval of Oracle XML DB Resources

When a protocol indicates that a resource is to be retrieved, the path name to the resource is resolved and the resource is fetched, by streaming it as either XML data or in RAW form.

Resources being fetched are streamed as XML data, except for those containing element `XDBBinary`, which is the XML binary data type, which have their contents streamed out in RAW form.

21.4.1.4 Storage of Oracle XML DB Resources

When a protocol indicates that a resource that is an XML document is to be stored, its associated XML schema, if any, is consulted to determine the default table in which to store the document.

Oracle XML DB checks the document file name extension for `.xml`, `.xsl`, `.xsd`, and so on. If the document is XML then a pre-parse step is done, whereby enough of the resource is read to determine the XML `schemaLocation` and `namespace` of the root element in the document. If a registered schema is located at the `schemaLocation` URL, and it has a definition for the root element of the current document, then the default table specified for that root element is used to store the contents of the resource.

21.4.1.5 Internet Protocols and XMLType: XMLType Direct Stream Write

Oracle XML DB supports Internet protocols at the `XMLType` level by using Java `XMLType` method `writeToStream()`. This method is implemented natively and writes `XMLType` data directly to the protocol request stream.

This avoids Java VM execution costs and the overhead of converting database data through Java data types and creating Java objects, resulting in significantly higher performance. Performance is further enhanced if the Java code deals only with XML element trees that are close to the root, and does not traverse too many of the leaf elements, so that relatively few Java objects are created.

See Also:

[Repository Access Using Protocols](#) (page 28-1)

21.4.2 Access to Oracle ASM Files Using Protocols and Resource APIs – For DBAs

Oracle Automatic Storage Management (Oracle ASM) organizes database files into *disk groups* for simplified management, database mirroring, and I/O balancing. Repository access extends to Oracle ASM files, in the *virtual* repository folder `/sys/asm`. This access is reserved for database administrators (DBAs). It is *not* intended for developers.

A typical use of such access is to copy Oracle ASM files from one database instance to another. For example, a DBA can view folder `/sys/asm` in a graphical user interface using the WebDAV protocol, and then drag-and-drop a copy of a data-pump dump set from an Oracle ASM disk group to an operating-system file system.

Virtual folder `/sys/asm` is created by default during Oracle XML DB installation. If the database is not configured to use Oracle ASM, the folder is empty and no operations are permitted on it.

Folder `/sys/asm` contains folders and subfolders that follow the hierarchy defined by the structure of an Oracle ASM *fully qualified filename*:

- It contains a subfolder for each mounted *disk group*.
- A disk-group folder contains a subfolder for each *database* that uses that disk group. In addition, a disk-group folder may contain files and folders corresponding to Oracle ASM *aliases* created by the administrator.
- A database folder contains file-type folders.

- A file-type folder contains Oracle ASM files, which are binary.

This hierarchy is shown in [Figure 21-5](#) (page 21-18), which omits directories created for aliases, for simplicity.

Figure 21-5 Oracle ASM Virtual Folder Hierarchy

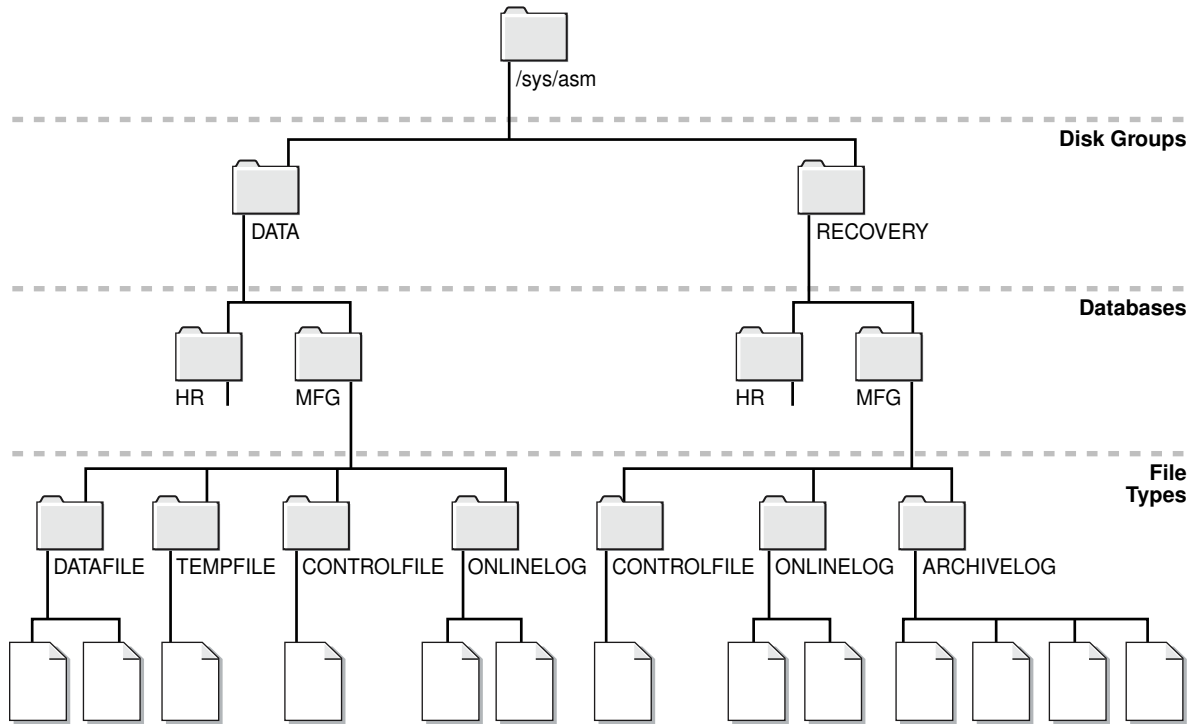

The following usage restrictions apply to virtual folder `/sys/asm`. You *cannot*:

- *query* `/sys/asm` using SQL
- put regular files under `/sys/asm` (you can put only Oracle ASM files there)
- *move* (rename) an Oracle ASM file to a different Oracle ASM disk group or to a folder outside Oracle ASM
- create *hard links* to existing Oracle ASM files or directories

In addition:

- You must have the privileges of role DBA to view folder `/sys/asm`.
- To access `/sys/asm` using Oracle XML DB protocols, you must log in as a user other than `SYS`.

Again, Oracle ASM virtual-folder operations are intended only for *database administrators*, not developers.

See Also:

- [Using FTP with Oracle ASM Files](#) (page 28-16) for an example of using protocol FTP with `/sys/asm`
- *Oracle Automatic Storage Management Administrator's Guide* for information about the syntax of a fully qualified Oracle ASM filename and details on the virtual folder structure

21.5 Query-Based Access to Repository Resources

PL/SQL package `DBMS_XDB_REPOS` provides subprograms that act on Oracle XML DB Repository resources. This API is based on the public views `RESOURCE_VIEW` and `PATH_VIEW`, which enable SQL access to repository data through protocols such as FTP and HTTP(S)/WebDAV.

- `PATH_VIEW` – Has one row for each unique repository path
- `RESOURCE_VIEW` – Has one row for each resource

Through these views, you can access and update both the metadata and the content of documents stored in the repository. Operations on the views use underlying repository tables such as `XDB$RESOURCE`.

Each view contains virtual column `RES`. You use column `RES` to access and update resource documents using SQL statements that accept a repository path notation.

View `RESOURCE_VIEW` contains column `ANY_PATH`. Column `ANY_PATH` contains a valid URL that the current user can pass to PL/SQL constructor `XDBURIType` to access the resource content. If this content is not binary data, then the resource itself also contains the content.

[Table 21-2](#) (page 21-19) summarizes the differences between the views.

Table 21-2 Differences Between `PATH_VIEW` and `RESOURCE_VIEW`

<code>PATH_VIEW</code>	<code>RESOURCE_VIEW</code>
Contains link properties	No link properties
Has one row for each unique <i>path</i> in repository	Has one row for each <i>resource</i> in repository

Rows in these views are of data type `XMLType`. In the `RESOURCE_VIEW`, the single path associated with a resource is arbitrarily chosen from among the possible paths that refer to the resource. Oracle XML DB provides SQL functions, such as `under_path`, that let applications search for the resources contained within a particular folder (recursively), obtain the resource depth, and so on.

DML code can be used on the repository views to insert, rename, delete, and update resource properties and contents. Programmatic APIs must be used for other operations, such as creating links to existing resources.

Oracle XML DB supports the concept of **linking**. Linking makes it possible to define multiple paths to a given document. A separate XML document, called the **link-properties document**, maintains metadata properties that are specific to the path, rather than to the resource. Whenever a resource is created, an initial link is also created.

`PATH_VIEW` exposes the link-properties documents. There is one entry in `PATH_VIEW` for each possible path to a document. Column `RES` of `PATH_VIEW` contains the resource document pointed to by this link. Column `PATH` contains the path that the link lets you use to access the resource. Column `LINK` contains the link-properties document (metadata) for this `PATH`.

See Also:

- [Link Types](#) (page 21-11)
 - [Repository Access Using `RESOURCE_VIEW` and `PATH_VIEW`](#) (page 24-1)
 - [Repository Access Control](#) (page 27-1)
 - *Oracle Database Reference* to learn about BPT for more information about view `PATH_VIEW`
 - *Oracle Database Reference* to learn about BPT for more information about view `RESOURCE_VIEW`
-

21.6 Servlet Access to Repository Resources

Oracle XML DB implements Java Servlet API, version 2.2.

Support is limited by these restrictions:

- All servlets must be distributable. They must expect to run in different virtual machines.
- WAR and `web.xml` files are not supported. Oracle XML DB supports a subset of the XML configurations in this file. An XSLT stylesheet can be applied to the `web.xml` to generate servlet definitions. An external tool must be used to create database roles for those defined in the `web.xml` file.
- JSP (Java Server Pages) support can be installed as a servlet and configured manually.
- `HTTPSession` and related classes are not supported.
- Only one servlet context (that is, one Web application) is supported.

See Also:

[Guidelines for Oracle XML DB Applications in Java](#) (page 31-1)

21.7 Operations on Repository Resources

You can operate on data stored in Oracle XML DB Repository resources using Java, PL/SQL, Internet protocols, and Oracle XML DB Content Connector (*deprecated*). The most common operations are described, along with the required database permissions to use them.

You can access repository data in any of these ways:

- Oracle XML DB resource APIs for Java

- A combination of Oracle XML DB resource views API and Oracle XML DB resource API for PL/SQL
- Internet protocols (HTTP(S)/WebDAV and FTP) and Oracle XML DB protocol server
- Oracle XML DB Content Connector (*deprecated*) and, through it, the standard Content Repository API for Java (JCR).

These access methods can be used equivalently. It does not matter how you add content to the repository or retrieve it from there. For example, you can add content to the repository using SQL or PL/SQL and then retrieve it using an Internet protocol, or the other way around.

[Table 21-3](#) (page 21-21) lists common Oracle XML DB Repository operations, and describes how these operations can be accomplished using each of several access methods. The table shows functionality common to the different methods, but not all of the methods are equally suited to any particular task. Unless mentioned otherwise, "resource" in this table can be either a file resource or a folder resource.

[Table 21-3](#) (page 21-21) also shows the resource privileges that are required for each operation.

Table 21-3 Accessing Oracle XML DB Repository: API Options

Data Access	SQL and PL/SQL	Protocols	Resource Privileges Required	JCR Support
Create resource	<pre>DBMS_XDB_REPOS.createResource('/public/T1/testcase.txt', 'ORIGINAL text'); INSERT INTO RESOURCE_VIEW (ANY_PATH, RES) SELECT '/public/T1/copy1.txt', RES FROM RESOURCE_VIEW WHERE equals_path(RES, '/public/T1/testcase.txt') = 1;</pre>	HTTP: PUT; FTP: PUT	DAV: bin d on parent folder	Yes
Update resource contents	<pre>UPDATE RESOURCE_VIEW SET RES = XMLQuery('declare default element namespace "http://xmlns.oracle.com/xdb/XDBResource.xsd"; (: :) copy \$i := \$p1 modify (for \$j in \$i/Resource/Contents/text return replace value of node \$j with \$p2) return \$i' PASSING RES AS "p1", 'NEW text' AS "p2" RETURNING CONTENT) WHERE equals_path(RES, '/public/T1/copy1.txt') = 1</pre>	HTTP: PUT; FTP: PUT	xdb:writ e- content on resource	Yes

Table 21-3 (Cont.) Accessing Oracle XML DB Repository: API Options

Data Access	SQL and PL/SQL	Protocols	Resource Privileges Required	JCR Support
Update resource properties	<pre>UPDATE RESOURCE_VIEW SET RES = XMLQuery('declare default element namespace "http://xmlns.oracle.com/xdb/XDBResource.xsd"; (: :) copy \$i := \$p1 modify (for \$j in \$i/Resource/DisplayName return replace value of node \$j with \$p2) return \$i' PASSING RES AS "p1", 'NewName1.txt' AS "p2" RETURNING CONTENT) WHERE equals_path(RES, '/public/T1/copy1.txt') = 1;</pre>	WebDAV: PROPPATCH;	DAV::write-properties on resource	Yes
Update resource ACL	<pre>EXEC DBMS_XDB_REPOS.setACL('/public/T1/copy1.txt', '/sys/acls/all_owner_acl.xml');</pre>	not applicable	DAV::write-acl on resource	No
Unlink resource (delete if last link)	<pre>EXEC DBMS_XDB_REPOS.deleteResource() or DELETE FROM RESOURCE_VIEW WHERE equals_path(RES, path) > 0</pre>	HTTP: DELETE; FTP: delete	DAV::unbind on parent folder xdb:unlink-from on resource	Yes
Forcibly remove all links to resource	<pre>DBMS_XDB_REPOS.deleteResource() or DELETE FROM PATH_VIEW WHERE XMLCast(XMLQuery('declare namespace n1= "http://xmlns.oracle.com/xdb/XDBResource.xsd"; (: :) //n1:DisplayName' PASSING RES RETURNING CONTENT) AS VARCHAR2(256)) = 'My resource'</pre>	FTP: quote rm_rf resource	DAV::unbind on all parent folders xdb:unlink-from on resource	Yes

Table 21-3 (Cont.) Accessing Oracle XML DB Repository: API Options

Data Access	SQL and PL/SQL	Protocols	Resource Privileges Required	JCR Support
Move resource	<pre>UPDATE PATH_VIEW SET path = '/public/T1/copy2.txt' WHERE equals_path(RES, '/public/T1/copy1.txt') = 1;</pre>	WebDAV: MOVE; FTP: rename	DAV::unbind on source parent folder DAV::bind on target parent folder xdb:unlink-from and xdb:link-to on resource	Yes
Copy resource	<pre>INSERT INTO PATH_VIEW (path, RES, link) SELECT '/public/T1/copy3.txt', RES, link FROM PATH_VIEW WHERE equals_path(RES, '/public/T1/copy2.txt') = 1;</pre>	WebDAV: COPY;	Copy to new: DAV::bind on target parent folder DAV::read on resource Copy to existing (replacement): DAV::read on resource DAV::write-properties and DAV::write-content on existing target resource	Yes
Create hard link to existing resource	<pre>EXEC DBMS_XDB_REPOS.link('/public/T1/copy3.txt', '/public/T1', 'myhardlink');</pre>	not applicable	DAV::bind on parent folder xdb:link-to on resource	No

Table 21-3 (Cont.) Accessing Oracle XML DB Repository: API Options

Data Access	SQL and PL/SQL	Protocols	Resource Privileges Required	JCR Support
Create weak link to existing resource	<pre>EXEC DBMS_XDB_REPOS.link('/public/T1/copy3.txt', '/public/T1', 'myweaklink', DBMS_XDB_REPOS.LINK_TYPE_WEAK);</pre>	not applicable	DAV::bind on parent folder xdb:link-to on resource	No
Change owner of resource	<pre>UPDATE RESOURCE_VIEW SET RES = XMLQuery('copy \$i := \$p1 modify (for \$j in \$i/Resource/Owner return replace value of node \$j with \$p2) return \$i' PASSING RES AS "p1", 'U2' AS "p2" RETURNING CONTENT) WHERE equals_path(RES, '/public/T1/copy3.txt') = 1;</pre>	not applicable	DAV::take-ownership on resource	Yes
Get binary or text representation of resource contents	<pre>SELECT XDBURIType(path).getBLOB() FROM DUAL; SELECT XMLQuery('declare default element namespace "http://xmlns.oracle.com/xdb/XDBResource.xsd";(: :) \$r/Resource/Contents' PASSING RES AS "r" RETURNING CONTENT) FROM RESOURCE_VIEW WHERE equals_path(RES, '/public/T1/copy2.text') = 1;</pre>	HTTP: GET; FTP: get	xdb:read - contents on resource	Yes
Get XMLType representation of resource contents	<pre>SELECT XDBURIType('/public/T1/res.xml').getXML FROM DUAL; SELECT XMLQuery('declare default element namespace "http://xmlns.oracle.com/xdb/XDBResource.xsd";(: :) \$r/Resource/Contents/*' PASSING RES AS "r" RETURNING CONTENT) FROM RESOURCE_VIEW WHERE equals_path(RES, '/public/T1/res.xml') = 1;</pre>	not applicable	xdb:read - contents on resource	No

Table 21-3 (Cont.) Accessing Oracle XML DB Repository: API Options

Data Access	SQL and PL/SQL	Protocols	Resource Privileges Required	JCR Support
Get resource properties	<pre>SELECT XMLCast(XMLQuery('declare default element namespace "http://xmlns.oracle.com/xdb/XDBResource.xsd";(: :) \$r/Resource/LastModifier' PASSING RES AS "r" RETURNING CONTENT) AS VARCHAR2(128)) FROM RESOURCE_VIEW WHERE equals_path(RES, '/public/T1/res.xml') = 1;</pre>	WebDAV: PROPFIND (depth = 0);	xdb:read - properties on resource	Yes
List resource s in folder	<pre>SELECT PATH FROM PATH_VIEW WHERE under_path(res, '/public/T1') = 1;</pre>	WebDAV: PROPFIND (depth = 0);	xdb:read - contents on folder	Yes
Create folder	<pre>Call DBMS_XDB_REPOS.createFolder('/public/T2');</pre>	WebDAV: MKCOL; FTP: mkdir	DAV::bind on parent folder	Yes
Unlink empty folder	<pre>DBMS_XDB_REPOS.deleteResource('/public/T2')</pre>	HTTP: DELETE; FTP: rmdir	DAV::unbind on parent folder xdb:unlink-from on resource	Yes
Forcibly delete folder and all links to it	<pre>DBMS_XDB_REPOS.deleteResource('/public/T2', DBMS_XDB.DELETE_RECURSIVE_FORCE);</pre>	not applicable	DAV::unbind on all parent folders xdb:unlink-from on folder resource	Yes

Table 21-3 (Cont.) Accessing Oracle XML DB Repository: API Options

Data Access	SQL and PL/SQL	Protocols	Resource Privileges Required	JCR Support
Get resource with a row lock	<pre>SELECT ... FROM RESOURCE_VIEW FOR UPDATE ...;</pre>	not applicable	xdb:read - properties and xdb:read - contents on resource	No
Add WebDAV lock on resource	<pre>EXEC DBMS_XDB_REPOS.LockResource('/public/T1/res.xml', TRUE, TRUE);</pre>	WebDAV: LOCK; FTP: quote lock	DAV::write-properties on resource	No
Remove WebDAV lock	<pre>DECLARE ... BEGIN DBMS_XDB_REPOS.GetLockToken('/public/T1/res.xml', locktoken); DBMS_XDB_REPOS.UnlockResource('/public/T1/res.xml', locktoken); END;</pre>	WebDAV: UNLOCK; FTP: quote unlock	DAV::write-properties and DAV::unlock on resource	No
Check out file resource	<pre>EXEC DBMS_XDB_VERSION.checkOut('/public/T1/res.xml');</pre>	not applicable	DAV::write-properties on resource	No
Check in file resource	<pre>EXEC DBMS_XDB_VERSION.checkIn('/public/T1/res.xml');</pre>	not applicable	DAV::write-properties on resource	No
Uncheck out file resource	<pre>EXEC DBMS_XDB_VERSION.unCheckOut('/public/T1/res.xml');</pre>	not applicable	DAV::write-properties on resource	No
Make file resource versioned	<pre>EXEC DBMS_XDB_VERSION.makeVersioned('/public/T1/res.xml');</pre>	not applicable	DAV::write-properties on resource	No

Table 21-3 (Cont.) Accessing Oracle XML DB Repository: API Options

Data Access	SQL and PL/SQL	Protocols	Resource Privileges Required	JCR Support
Remove an event handler	DBMS_XEVENT.remove	not applicable	xdb:write-config on resource or parent folder (depending on the context)	No
Commit changes	COMMIT;	Automatic commit after each request	not applicable	Yes
Rollback changes	ROLLBACK;	not applicable	not applicable	Yes

In addition to the privileges listed in [Table 21-3](#) (page 21-21), privilege `xdb:read-properties` is required on each resource affected by an operation. Operations that affect the parent folder of a resource, in addition to the resource targeted by the operation, also require privilege `xdb:read-properties` on that parent folder. For example, deleting a resource affects both the resource to delete and its parent folder, so you need privilege `xdb:read-properties` on both the resource and its parent folder.

See Also:

- [Repository Access Using RESOURCE_VIEW and PATH_VIEW](#) (page 24-1)
 - [PL/SQL Access to Oracle XML DB Repository](#) (page 26-1)
 - [Repository Access Using Protocols](#) (page 28-1)
 - [Deprecated Content Repository API for Java](#) (page E-1)
 - *Oracle Database PL/SQL Packages and Types Reference* for information about PL/SQL package DBMS_XDB_REPOS
 - *Oracle Database PL/SQL Packages and Types Reference* for information about PL/SQL package DBMS_XDB_VERSION
 - *Oracle Database PL/SQL Packages and Types Reference* for information about PL/SQL package DBMS_XEVENT
-

21.8 Accessing the Content of Repository Resources Using SQL

In SQL you can access the content of a document in Oracle XML DB Repository using PL/SQL constructor `XDBURITYPE` or using `RESOURCE_VIEW` and the corresponding resource document.

The easiest way is to use `XDBURITYPE`. You pass a URL to this constructor to specify which resource to access. The URL is assumed to start at the root of the repository. Object type `XDBURITYPE` provides methods `getBLOB()`, `getCLOB()`, and `getXML()`, to access the different kinds of content that can be associated with a resource.

[Example 21-4](#) (page 21-28) uses constructor `XDBURITYPE` to access the content of a text document.

The content of a document can also be accessed using `RESOURCE_VIEW` and the corresponding resource document. [Example 21-5](#) (page 21-28) does this to access the content of a text document.

The content of XML documents (XML Schema-based or non-schema-based) can also be accessed this way. [Example 21-6](#) (page 21-29) uses an XPath expression that includes nodes from an XML document and nodes from the corresponding resource document to access the contents of a `PurchaseOrder` document.

In [Example 21-6](#) (page 21-29), the namespace prefix, `r` identifies which nodes in the XPath expression are members of the resource namespace. Namespace prefix `r` is defined using the `XMLNAMESPACES` clause of SQL/XML function `XMLTable`. The namespace declaration is needed here because the purchase-order XML schema does not define a namespace, and it is not possible to apply a namespace prefix to nodes in the `PurchaseOrder` document.

See Also:

[XQuery and Oracle XML DB](#) (page 4-1) for more information about the `XMLNAMESPACES` clause of `XMLTable`

Example 21-4 Accessing a Text Document in the Repository Using XDBURITYPE

```
SELECT XDBURITYPE('/home/QUINE/NurseryRhyme.txt').getCLOB() FROM DUAL;

XDBURITYPE('/HOME/QUINE/NURSERYRHYME.TXT').GETCLOB()
-----
Mary had a little lamb
Its fleece was white as snow
and everywhere that Mary went
that lamb was sure to go

1 row selected.
```

Example 21-5 Accessing Resource Content Using RESOURCE_VIEW

```
SELECT CONTENT
FROM RESOURCE_VIEW,
XMLTable(XMLNAMESPACES (default 'http://xmlns.oracle.com/xdb/XDBResource.xsd'),
'/Resource/Contents' PASSING RES
COLUMNS content CLOB PATH 'text')
WHERE equals_path(RES, '/home/QUINE/NurseryRhyme.txt') = 1;
```

```
CONTENT
```

```
-----
Mary had a little lamb
Its fleece was white as snow
and everywhere that Mary went
that lamb was sure to go
```

```
1 row selected.
```

Example 21-6 Accessing XML Documents Using Resource and Namespace Prefixes

```
SELECT des.description
FROM RESOURCE_VIEW rv,
XMLTable(XMLNAMESPACES ('http://xmlns.oracle.com/xdb/XDBResource.xsd' AS "r"),
'/r:Resource/r:Contents/PurchaseOrder/LineItems/LineItem'
PASSING rv.RES
COLUMNS description VARCHAR2(256) PATH 'Description') des
WHERE
equals_path(rv.RES, '/home/QUINE/PurchaseOrders/2002/Mar/SBELL-2002100912333601PDT.xml') = 1;
```

```
DES.DESCRPTION
```

```
-----
A Night to Remember
The Unbearable Lightness Of Being
The Wizard of Oz
```

```
3 rows selected.
```

21.9 Access to the Content of XML Schema-Based Documents

You can access the content of an XML Schema-based document in the same way as for a non-schema-based document: use the corresponding resource document. Or you can access it as a row in the default table that was defined when the XML schema was registered with Oracle XML DB.

In the first case, you can use `RESOURCE_VIEW` to query different types of XML Schema-based documents with a single SQL statement.

21.9.1 Accessing Resource Content Using Element `XMLRef` in Joins

Element `XMLRef` in a resource document provides the join key required when a SQL statement needs to access or update metadata and content as part of a single operation.

Examples here show queries that access resource content using joins based on the value of element `XMLRef`.

[Example 21-7](#) (page 21-30) locates a row in the `defaultTable` based on a path in Oracle XML DB Repository. SQL function `ref` locates the target row in the default table, based on the value of the `XMLRef` element in the resource document, `RES`.

[Example 21-8](#) (page 21-30) shows how to select fragments from XML documents based on metadata, path, and content. The query returns the value of element `Reference` for documents under `/home/QUINE/PurchaseOrders/2002/Mar` that contain orders for part number 715515009058.

In general, when accessing the content of schema-based XML documents, joining `RESOURCE_VIEW` or `PATH_VIEW` with the default table is more efficient than using `RESOURCE_VIEW` or `PATH_VIEW` on its own. An explicit join between the resource document and the default table tells Oracle XML DB that the SQL statement works on

only one type of XML document. XPath rewrite can thus be used to optimize operations on the default table and the resource.

Example 21-7 Querying Repository Resource Data Using SQL Function REF and Element XMLRef

```
SELECT des.description
FROM RESOURCE_VIEW rv,
     purchaseorder p,
     XMLTable('$p/PurchaseOrder/LineItems/LineItem' PASSING p.OBJECT_VALUE AS "p"
              COLUMNS description VARCHAR2(256) PATH 'Description') des
WHERE equals_path(rv.RES, '/home/QUINE/PurchaseOrders/2002/Mar/SBELL-2002100912333601PDT.xml')
     = 1
AND ref(p) = XMLCast(XMLQuery('declare default element namespace
                              "http://xmlns.oracle.com/xdb/XDBResource.xsd"; (: :)
                              fn:data(/Resource/XMLRef)' PASSING rv.RES RETURNING CONTENT)
                    AS REF XMLType);
```

DES.DESCRPTION

```
-----
A Night to Remember
The Unbearable Lightness Of Being
The Wizard of Oz
```

3 rows selected.

Example 21-8 Selecting XML Document Fragments Based on Metadata, Path, and Content

```
SELECT XMLCast(XMLQuery('$p/PurchaseOrder/Reference'
                        PASSING po.OBJECT_VALUE AS "p" RETURNING CONTENT)
            AS VARCHAR2(30))
FROM RESOURCE_VIEW rv, purchaseorder po
WHERE under_path(rv.RES, '/home/QUINE/PurchaseOrders/2002/Mar') = 1
AND ref(po) = XMLCast(
    XMLQuery('declare default element namespace
              "http://xmlns.oracle.com/xdb/XDBResource.xsd"; (: :)
              fn:data(/Resource/XMLRef)'
              PASSING rv.RES RETURNING CONTENT)
    AS REF XMLType)
AND XMLElementExists('$p/PurchaseOrder/LineItems/LineItem/Part[@Id="715515009058"]'
                    PASSING po.OBJECT_VALUE AS "p");
```

XMLCAST(XMLQUERY('\$P/PURCHASEO

```
-----
CJOHNSON-20021009123335851PDT
LSMITH-2002100912333661PDT
SBELL-2002100912333601PDT
```

3 rows selected.

21.10 Update of the Content of Repository Documents

You can update the content of documents stored in Oracle XML DB Repository using Internet protocols or SQL.

21.10.1 Update of Repository Content Using Internet Protocols

The most popular content authoring tools support HTTP, FTP, and WebDAV protocols. Given appropriate access permissions, a simple URL targeting a document to update is all you need, to access and edit content stored in Oracle XML DB Repository.

Popular content authoring tools can use HTTP verb `get` to access the content of a document, given a URL to it, and they can use HTTP verb `put` to save the updated content.

Figure 21-6 (page 21-31) shows how, with the WebDAV support included in Microsoft Word, you can use Microsoft Word to update and edit a document stored in Oracle XML DB Repository.

Figure 21-6 Updating and Editing Content Stored in Oracle XML DB Using Microsoft Word

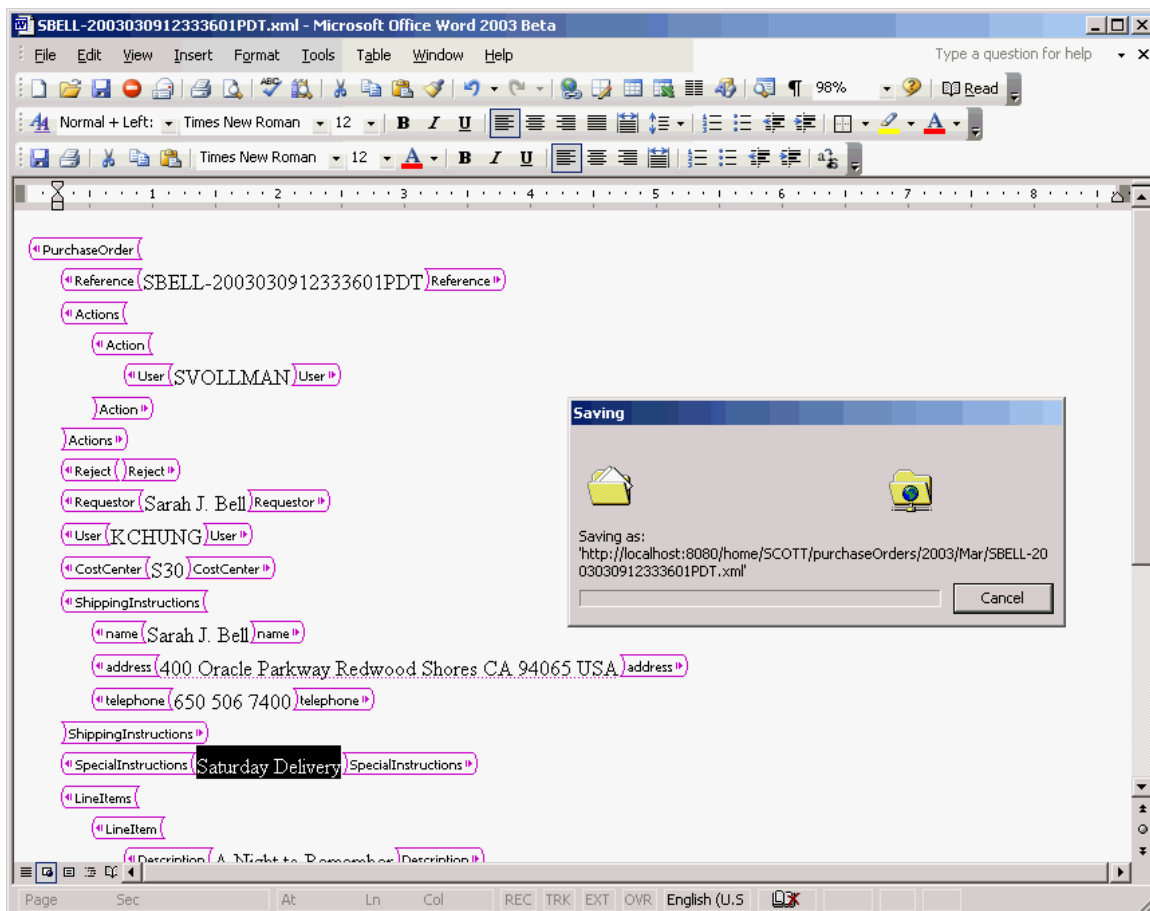

When an editing application such as Microsoft Word updates an XML document that is stored in Oracle XML DB, the database receives an input stream containing the new content of the document. Unfortunately, applications such as Word do not provide Oracle XML DB with any way of identifying which changes have taken place in the document. Partial updates are thus impossible. It is necessary to parse the entire document again, replacing all of the objects derived from the original document with objects derived from the new content.

21.10.2 Update of Repository Content Using SQL

You can use XQuery Update to update the content of any document stored in Oracle XML DB Repository. The content of the document can be modified by updating the resource document or by updating the default table that holds the content of the document.

21.10.2.1 Updating a Document in the Repository by Updating Its Resource Document

You can update the content of a document using a SQL UPDATE statement and SQL function XMLQuery with XQuery Update. An XQuery expression is passed to XMLQuery as the target of the update operation.

[Example 21-9](#) (page 21-32) updates the content of a simple text document. The XQuery expression passed to XMLQuery as the target of the update operation identifies the text node as belonging to element /Resource/Contents/text.

This technique for updating the content of a document by updating the associated resource has the advantage that it can be used to update any kind of document stored in Oracle XML DB Repository.

[Example 21-10](#) (page 21-32) updates a node in an XML document by performing a SQL UPDATE operation on the corresponding resource document. Here, XQuery Update is used to change the value of the text node associated with element User.

Example 21-9 Updating a Text Document Using UPDATE and XQuery Update on the Resource

```

DECLARE
  file          BFILE;
  contents      CLOB;
  dest_offset   NUMBER := 1;
  src_offset    NUMBER := 1;
  lang_context  NUMBER := 0;
  conv_warning  NUMBER := 0;
BEGIN
  file := bfilename('XMLDIR', 'tdadxdb-03-02.txt');
  DBMS_LOB.createTemporary(contents, true, DBMS_LOB.SESSION);
  DBMS_LOB.fileopen(file, DBMS_LOB.file_readonly);
  DBMS_LOB.loadClobFromFile(contents,
                           file,
                           DBMS_LOB.getLength(file),
                           dest_offset,
                           src_offset,
                           nls_charset_id('AL32UTF8'),
                           lang_context,
                           conv_warning);
  DBMS_LOB.fileclose(file);
  UPDATE RESOURCE_VIEW
  SET RES =
    XMLQuery('declare default element namespace
              "http://xmlns.oracle.com/xdb/XDBResource.xsd"; (: :)
              copy $i := $p1 modify
              (for $j in $i/Resource/Contents/text
               return replace value of node $j with $p2)
              return $i'
            PASSING RES AS "p1", contents AS "p2" RETURNING CONTENT)
  WHERE equals_path(res, '/home/QUINE/NurseryRhyme.txt') = 1;
  DBMS_LOB.freeTemporary(contents);
END;
/

```

Example 21-10 Updating an XML Node Using UPDATE and XQuery Update on the Resource

```

UPDATE RESOURCE_VIEW
SET RES =
  XMLQuery('declare namespace r="http://xmlns.oracle.com/xdb/XDBResource.xsd";

```

```

copy $i := $p1 modify
  (for $j in $i/r:Resource/r:Contents/PurchaseOrder/User
   return replace value of node $j with $p2)
return $i'
PASSING RES AS "p1", 'SKING' AS "p2" RETURNING CONTENT)
WHERE equals_path(res, '/home/QUINE/PurchaseOrders/2002/Mar/SBELL-2002100912333601PDT.xml')
= 1;

1 row updated.

SELECT XMLCast(XMLQuery(
  'declare namespace ns="http://xmlns.oracle.com/xdb/XDBResource.xsd"; (: : )
  $r/ns:Resource/ns:Contents/PurchaseOrder/User/text()'
  PASSING RES AS "r" RETURNING CONTENT)
  AS VARCHAR2(32))
FROM RESOURCE_VIEW
WHERE equals_path(RES,
  '/home/QUINE/PurchaseOrders/2002/Mar/SBELL-2002100912333601PDT.xml')
= 1;

XMLCAST(XMLQUERY('DECLARENAMESPA
-----
SKING

1 row selected.

```

21.10.2.2 Updating an XML Schema-Based Document in the Repository by Updating the Default Table

You can update XML Schema-based documents by performing an update operation directly on the default table that is used to manage the content of the document.

If the document must be located by a WHERE clause that includes a path or conditions based on metadata, then the SQL UPDATE statement must use a join between the resource and the default table.

In general, when updating the content of XML Schema-based documents, joining the RESOURCE_VIEW or PATH_VIEW with the default table is more efficient than using the RESOURCE_VIEW or PATH_VIEW on its own. The explicit join between the resource document and the default table tells Oracle XML DB that the SQL statement works on only one type of XML document. This lets a partial update be used on the default table and resource.

In [Example 21-11](#) (page 21-33), XQuery Update is used on the default table, with the target row identified by a path. The row to be updated is identified by a REF. The REF is identified by a repository path using Oracle SQL function equals_path. This limits the update to the row corresponding to the resource identified by the specified path.

Example 21-11 Updating XML Schema-Based Documents in the Repository

```

UPDATE purchaseorder p
SET p.OBJECT_VALUE =
  XMLQuery('copy $i := $p1 modify
    (for $j in $i/PurchaseOrder/User
     return replace value of node $j with $p2)
    return $i'
    PASSING p.OBJECT_VALUE AS "p1", 'SBELL' AS "p2" RETURNING CONTENT)
WHERE ref(p) =
  (SELECT XMLCast(XMLQuery('declare default element namespace
    "http://xmlns.oracle.com/xdb/XDBResource.xsd"; (: : )

```

```

                fn:data(/Resource/XMLRef)'
                PASSING rv.RES RETURNING CONTENT) AS REF XMLType)
FROM RESOURCE_VIEW rv
WHERE equals_path(rv.RES,
                '/home/QUINE/PurchaseOrders/2002/Mar/SBELL-2002100912333601PDT.xml')
        = 1);

SELECT XMLCast(XMLQuery('$p/PurchaseOrder/User/text()'
                PASSING p.OBJECT_VALUE AS "p" RETURNING CONTENT)
                AS VARCHAR2(32))
FROM purchaseorder p, RESOURCE_VIEW rv
WHERE ref(p) = XMLCast(XMLQuery('declare default element namespace
                "http://xmlns.oracle.com/xdm/XDBResource.xsd"; (: :)
                fn:data(/Resource/XMLRef)' PASSING rv.RES RETURNING CONTENT)
                AS REF XMLType)
        AND equals_path(rv.RES, '/home/QUINE/PurchaseOrders/2002/Mar/SBELL-2002100912333601PDT.xml')
        = 1;

XMLCAST(XMLQUERY('$P/PURCHASEO
-----
SBELL

```

21.11 Querying Resources in RESOURCE_VIEW and PATH_VIEW

Examples here illustrate folder-restricted queries of the repository using RESOURCE_VIEW and PATH_VIEW together with Oracle SQL functions equals_path and under_path.

Oracle XML DB provides two Oracle SQL functions, equals_path and under_path, that you can use to perform **folder-restricted queries**. Such queries limit SQL statements that operate on the RESOURCE_VIEW or PATH_VIEW to documents that are at a particular location in Oracle XML DB folder hierarchy.

Function equals_path restricts the statement to a single document identified by the specified path. Function under_path restricts the statement to those documents that exist beneath a certain point in the hierarchy.

Examples here demonstrate simple folder-restricted queries against resource documents stored in RESOURCE_VIEW and PATH_VIEW.

The query in [Example 21-12](#) (page 21-35) uses SQL function equals_path and RESOURCE_VIEW to access a resource. The resource queried is that which results from the update operation of [Example 21-9](#) (page 21-32): the original resource text shown in [Example 21-4](#) (page 21-28) and [Example 21-5](#) (page 21-28) has been replaced by a different nursery rhyme, "Hickory Dickory Dock..."

As [Example 21-12](#) (page 21-35) shows, a resource document is an XML document that captures the set of metadata defined by the DAV standard. The metadata includes information such as CreationDate, Creator, Owner, ModificationDate, and DisplayName. The content of the resource document can be queried and updated just like any other XML document, using SQL/XML access and query functions.

The query in [Example 21-13](#) (page 21-36) finds a path to each of the XSL stylesheets stored in Oracle XML DB Repository. It performs a search based on the DisplayName ending in .xsl.

The query in [Example 21-14](#) (page 21-36) counts the number of resources (files and folders) under the path /home/QUINE/PurchaseOrders. Using RESOURCE_VIEW rather than PATH_VIEW ensures that any resources that are the target of multiple links are only counted once. SQL function under_path restricts the result set to

documents that can be accessed using a path that starts from /home/QUINE/PurchaseOrders.

The query in [Example 21-15](#) (page 21-36) lists the contents of the folder identified by path /home/QUINE/PurchaseOrders/2002/Apr. This is effectively a directory listing of the folder.

The query in [Example 21-16](#) (page 21-37) lists the set of links contained in the folder identified by the path /home/QUINE/PurchaseOrders/2002/Apr where the DisplayName element in the associated resource starts with S.

The query in [Example 21-17](#) (page 21-37) finds a path to each resource in Oracle XML DB Repository that contains a PurchaseOrder document. The documents are identified based on the metadata property SchemaElement that identifies the XML schema URL and global element for schema-based XML data stored in the repository.

Example 21-12 Accessing Resources Using EQUALS_PATH and RESOURCE_VIEW

```
SELECT XMLSerialize(DOCUMENT r.res AS CLOB)
   FROM RESOURCE_VIEW r
   WHERE equals_path(res, '/home/QUINE/NurseryRhyme.txt') = 1;

XMLSERIALIZE(DOCUMENTR.RESASCLOB)
-----
<Resource xmlns="http://xmlns.oracle.com/xdb/XDBResource.xsd"
  Hidden="false"
  Invalid="false"
  Container="false"
  CustomRslv="false"
  VersionHistory="false"
  StickyRef="true">
  <CreationDate>2005-06-13T13:19:20.566623</CreationDate>
  <ModificationDate>2005-06-13T13:19:22.997831</ModificationDate>
  <DisplayName>NurseryRhyme.txt</DisplayName>
  <Language>en-US</Language>
  <CharacterSet>UTF-8</CharacterSet>
  <ContentType>text/plain</ContentType>
  <RefCount>1</RefCount>
  <ACL>
    <acl description=
      "Private:All privileges to OWNER only and not accessible to others"
      xmlns="http://xmlns.oracle.com/xdb/acl.xsd" xmlns:dav="DAV:"
      xmlns:xsi="http://www.w3.org/2001/XMLSchema-instance"
      xsi:schemaLocation="http://xmlns.oracle.com/xdb/acl.xsd
      http://xmlns.oracle.com/xdb/acl.xsd"
      shared="true">
      <ace>
        <grant>true</grant>
        <principal>dav:owner</principal>
        <privilege>
          <all/>
        </privilege>
      </ace>
    </acl>
  </ACL>
  <Owner>QUINE</Owner>
  <Creator>QUINE</Creator>
  <LastModifier>QUINE</LastModifier>
  <SchemaElement>http://xmlns.oracle.com/xdb/XDBSchema.xsd#text</SchemaElement>
  <Contents>
    <text>Hickory Dickory Dock
    The Mouse ran up the clock
```

```

The clock struck one
The Mouse ran down
Hickory Dickory Dock
    </text>
  </Contents>
</Resource>

```

1 row selected.

Example 21-13 Determining the Path to XSLT Stylesheets Stored in the Repository

```

SELECT ANY_PATH FROM RESOURCE_VIEW
  WHERE XMLCast(XMLQuery(
    'declare namespace ns="http://xmlns.oracle.com/xdb/XDBResource.xsd"; (: : )
    $r/ns:Resource/ns:DisplayName'
    PASSING RES AS "r" RETURNING CONTENT)
  AS VARCHAR2(100))
  LIKE '%.xsl';

```

```

ANY_PATH
-----
/home/MDSYS/epsg/sdoepsggrid2nadcon.xsl
/home/MDSYS/epsg/sdoepsggrid2ntv2/xsl
/source/schemas/poSource/xsl/empdept.xsl
/source/schemas/poSource/xsl/purchaseOrder.xsl

```

4 rows selected.

Example 21-14 Counting Resources Under a Path

```

SELECT count(*)
  FROM RESOURCE_VIEW
  WHERE under_path(RES, '/home/QUINE/PurchaseOrders') = 1;

```

```

COUNT(*)
-----
      145

```

1 row selected.

Example 21-15 Listing the Folder Contents in a Path

```

SELECT PATH
  FROM PATH_VIEW
  WHERE under_path(RES, '/home/QUINE/PurchaseOrders/2002/Apr') = 1;

```

```

PATH
-----
/home/QUINE/PurchaseOrders/2002/Apr/AMCEWEN-20021009123336171PDT.xml
/home/QUINE/PurchaseOrders/2002/Apr/AMCEWEN-20021009123336271PDT.xml
/home/QUINE/PurchaseOrders/2002/Apr/EABEL-20021009123336251PDT.xml
/home/QUINE/PurchaseOrders/2002/Apr/PTUCKER-20021009123336191PDT.xml
/home/QUINE/PurchaseOrders/2002/Apr/PTUCKER-20021009123336291PDT.xml
/home/QUINE/PurchaseOrders/2002/Apr/SBELL-20021009123336231PDT.xml
/home/QUINE/PurchaseOrders/2002/Apr/SBELL-20021009123336331PDT.xml
/home/QUINE/PurchaseOrders/2002/Apr/SKING-20021009123336321PDT.xml
/home/QUINE/PurchaseOrders/2002/Apr/SMCCAIN-20021009123336151PDT.xml
/home/QUINE/PurchaseOrders/2002/Apr/SMCCAIN-20021009123336341PDT.xml
/home/QUINE/PurchaseOrders/2002/Apr/VJONES-20021009123336301PDT.xml

```

11 rows selected.

Example 21-16 Listing the Links Contained in a Folder

```

SELECT PATH
  FROM PATH_VIEW
  WHERE XMLCast(XMLQuery(
    'declare namespace ns="http://xmlns.oracle.com/xdb/XDBResource.xsd"; (: : )
    $r/ns:Resource/ns:DisplayName'
    PASSING RES AS "r" RETURNING CONTENT)
    AS VARCHAR2(100))
    LIKE 'S%'
    AND under_path(RES, '/home/QUINE/PurchaseOrders/2002/Apr') = 1;

```

PATH

```

-----
/home/QUINE/PurchaseOrders/2002/Apr/SBELL-20021009123336231PDT.xml
/home/QUINE/PurchaseOrders/2002/Apr/SBELL-20021009123336331PDT.xml
/home/QUINE/PurchaseOrders/2002/Apr/SKING-20021009123336321PDT.xml
/home/QUINE/PurchaseOrders/2002/Apr/SMCCAIN-20021009123336151PDT.xml
/home/QUINE/PurchaseOrders/2002/Apr/SMCCAIN-20021009123336341PDT.xml

```

5 rows selected.

Example 21-17 Finding Paths to Resources that Contain Purchase-Order XML Documents

```

SELECT ANY_PATH
  FROM RESOURCE_VIEW
  WHERE XMLEExists(
    'declare namespace ns="http://xmlns.oracle.com/xdb/XDBResource.xsd"; (: : )
    $r/ns:Resource[ns:SchemaElement=
    "http://localhost:8080/source/schemas/poSource/xsd/purchaseOrder.xsd#PurchaseOrder"]'
    PASSING RES AS "r");

```

The query returns the following paths, each of which contains a PurchaseOrder document:

ANY_PATH

```

-----
/home/QUINE/PurchaseOrders/2002/Apr/AMCEWEN-20021009123336171PDT.xml
/home/QUINE/PurchaseOrders/2002/Apr/AMCEWEN-20021009123336271PDT.xml
/home/QUINE/PurchaseOrders/2002/Apr/EABEL-20021009123336251PDT.xml
/home/QUINE/PurchaseOrders/2002/Apr/PTUCKER-20021009123336191PDT.xml

```

...

132 rows selected.

21.12 Oracle XML DB Hierarchical Repository Index

Oracle XML DB uses a hierarchical index for Oracle XML DB Repository, to optimize the performance of path-based and folder-restricted queries of the repository. It is implemented as an Oracle domain index.

In a conventional relational database, path-based access and folder-restricted queries are implemented using `CONNECT BY` operations. Such queries are expensive, so path-based access and folder-restricted queries can become inefficient as the number of documents and depth of the folder hierarchy increases.

To address this issue, Oracle XML DB introduces a new index type, the **hierarchical repository index**. This lets the database resolve folder-restricted queries without relying on a `CONNECT BY` operation. Because of this, Oracle XML DB can execute path-based and folder-restricted queries efficiently. The hierarchical repository index

is implemented as an Oracle domain index. This is the same technique used to add Oracle Text indexing support and many other advanced index types to the database.

[Example 21-18](#) (page 21-38) shows the execution plan output generated for a folder-restricted query. As shown, the hierarchical repository index XDBHI_IDX is used to resolve the query.

Example 21-18 Execution Plan Output for a Folder-Restricted Query

```
SELECT PATH
FROM PATH_VIEW
WHERE XMLCast(
  XMLQuery(
    'declare namespace ns="http://xmlns.oracle.com/xdb/XDBResource.xsd"; (: : )
    $r/ns:Resource/ns:DisplayName'
    PASSING RES AS "r" RETURNING CONTENT)
  AS VARCHAR2(100))
LIKE 'S%'
AND under_path(RES, '/home/QUINE/PurchaseOrders/2002/Apr') = 1;
```

PLAN_TABLE_OUTPUT

Plan hash value: 2568289845

Id	Operation	Name	Rows	Bytes	Cost (%CPU)	Time
0	SELECT STATEMENT		17	3111	34 (6)	00:00:01
1	NESTED LOOPS		17	3111	34 (6)	00:00:01
2	NESTED LOOPS		17	2822	34 (6)	00:00:01
3	NESTED LOOPS		466	63842	34 (6)	00:00:01
* 4	TABLE ACCESS BY INDEX ROWID	XDB\$RESOURCE	1	135	3 (0)	00:00:01
* 5	DOMAIN INDEX	XDBHI_IDX				
6	COLLECTION ITERATOR PICKLER FETCH					
* 7	INDEX UNIQUE SCAN	XDB_PK_H_LINK	1	28	0 (0)	00:00:01
* 8	INDEX UNIQUE SCAN	SYS_C003900	1	17	0 (0)	00:00:01

Predicate Information (identified by operation id):

```
4 - filter(CAST("P"."SYS_NC00011$" AS VARCHAR2(100)) LIKE 'S%')
5 - access("XDB"."UNDER_PATH"(SYS_MAKEXML('8758D485E6004793E034080020B242C6',734,"XMLEXTRA",
"XMLDATA"),'/home/QUINE/PurchaseOrders/2002/Apr',9999)=1)
7 - access("H"."PARENT_OID"=SYS_OP_ATG(VALUE(KOKBF$),3,4,2) AND
"H"."NAME"=SYS_OP_ATG(VALUE(KOKBF$),2,3,2))
8 - access("R2"."SYS_NC_OID"=SYS_OP_ATG(VALUE(KOKBF$),3,4,2))
```

25 rows selected.

Configuration of Oracle XML DB Repository

Overall configuration of Oracle XML DB Repository applies to all repository resources. It does not include configuring parameters for handling events or managing XLink and XInclude processing. You use resource configuration files to configure resources.

- [Resource Configuration Files](#) (page 22-1)
- [Configuring a Resource](#) (page 22-2)
- [Common Configuration Parameters](#) (page 22-3)

See Also:

- [Oracle XML DB Protocol Server Configuration Management](#) (page 28-2)
 - [Configuration of Repository Events](#) (page 30-9)
 - [Configuration of Repository Resources for XLink and XInclude](#) (page 23-10)
 - [XDBResource.xsd: XML Schema for Oracle XML DB Resources](#) (page A-1)
 - [XDBResConfig.xsd: XML Schema for Resource Configuration](#) (page A-10)
 - [Package DBMS_XDB_ADMIN](#) (page 34-14), for information about using a dedicated tablespace for the repository
-
-

22.1 Resource Configuration Files

You configure an Oracle XML DB Repository resource for any purpose by associating it with a resource configuration file, which defines configurable parameters for the resource. A resource configuration file is itself a resource in Oracle XML DB Repository.

A **resource configuration file** is an XML file that conforms to the XML schema `XDBResConfig.xsd`, which is accessible in Oracle XML DB Repository at path `/sys/schemas/PUBLIC/xmlns.oracle.com/xdb/XDBResConfig.xsd`. This XML schema is defined by Oracle XML DB, and you cannot alter it.

You use PL/SQL procedure `DBMS_RESCONFIG.addResConfig` to map a resource to the file that configures it. A single resource configuration file can alternatively apply to all resources in the repository. In that case, you use PL/SQL procedure `DBMS_RESCONFIG.addRepositoryResConfig` to map it to the repository as a whole.

The same resource configuration file can be used to configure more than one resource, if appropriate. Oracle recommends that you have resources share a configuration file this way whenever the same configuration makes sense. This can improve run-time performance. It also simplifies repository management by letting you update a configuration in a single place and have the change affect multiple resources.

Avoid creating multiple, equivalent resource configuration files, because that can impact performance negatively. If Oracle XML DB detects duplicate resource configuration files, it raises an error.

Typically, you configure a resource for use with a particular application. In order for a resource to be shared by multiple applications, it must be possible for different applications to configure it differently. You do this by creating multiple resource configuration files and mapping them to the same resource. Each resource is thus associated with a list of configurations, a **resource configuration list**. Configurations in a configuration list are processed in the list order.

The repository itself has a list of resource configuration files, for repository-wide configuration, which really means configuration of all resources in the repository. The same configuration file must not be used for both the repository itself and a specific resource. Otherwise, an error is raised. An error is also raised if the same resource configuration file appears more than once in any given resource configuration list.

Note:

An error is raised if you try to create more than 125 resource configuration files for repository-wide configuration.

The resource configuration list of a new resource is based on the information in the `configuration` elements of all resource configuration files for the parent folder of the new resource. If there is no such information (no configuration file or no `defaultChildConfig` elements in the files), then the `configuration` elements of the repository resource configuration list are used. If that information is also missing, then the new resource has an empty resource configuration list.

You can view the configuration list for a particular resource by extracting element `/Resource/RCList` from column `RES` of view `RESOURCE_VIEW`, or by using PL/SQL procedure `DBMS_RESCONFIG.getResConfigPath`. You can view the configuration list for the repository as a whole by using PL/SQL procedure `DBMS_RESCONFIG.getRepositoryResConfigPath`. To modify the repository-wide configuration list, you must be granted role `XDBADMIN`.

See Also:

[Configuration Elements `defaultChildConfig` and `configuration`](#) (page 22-4)

22.2 Configuring a Resource

Configuring an Oracle XML DB Repository resource involves creating a configuration file, adding that file to the repository as a configuration resource, and mapping the configuration resource to the resources it configures or to the entire repository.

Follow these steps to configure an individual resource or the repository as a whole (all resources):

1. Create a resource configuration file that defines the configuration. This XML file must conform to XML schema `XDBResConfig.xsd`.
2. Add the resource configuration file to the repository as a resource in its own right: a configuration resource. You can use PL/SQL function `DBMS_XDB_REPOS.createResource` to do this.
3. Map this configuration resource to the resources that it configures, or to the repository if it applies to all resources. Use PL/SQL procedure `DBMS_RESCONFIG.addResConfig` or `DBMS_RESCONFIG.appendResConfig` to map an individual resource. Use `DBMS_RESCONFIG.addRepositoryResConfig` to map the repository as a whole.
4. Commit.

Note:

Before performing any operation that uses a resource configuration file, you must perform a `COMMIT` operation. Until you do that, an `ORA-22881` "dangling REF" error is raised whenever you use the configuration file.

PL/SQL package `DBMS_RESCONFIG` provides additional procedures to delete a configuration from a configuration list, obtain a list of paths to configurations in a configuration list, and more.

Note:

If you delete a resource configuration file that is referenced by another resource, a dangling `REF` error is raised whenever an attempt is made to access the configured resource.

See Also:

- [Example 22-1](#) (page 22-5) for an example of a simple resource configuration file
- [Configuration of Repository Events](#) (page 30-9) for complete examples of configuring resources
- [XDBResConfig.xsd: XML Schema for Resource Configuration](#) (page A-10)
- *Oracle Database PL/SQL Packages and Types Reference* for information about package `DBMS_RESCONFIG`

22.3 Common Configuration Parameters

Commonly used configuration parameters are described, that is, elements in a configuration file.

Parameters specific to particular types of configuration are described elsewhere.

22.3.1 Configuration Element ResConfig

The top-level element of a resource configuration file is `ResConfig`. You can use it to disable or enable the resource configuration file.

Besides attributes `namespace` and `schemaLocation`, element `ResConfig` can contain an optional `enable` attribute. Set the value of attribute `enable` to `false` to disable the resource configuration file, so that it has no effect on the resources mapped to it. This can be useful for debugging or disabling an application. The default value of `enable`, used if the attribute is not present, is `true`.

22.3.2 Configuration Elements `defaultChildConfig` and `configuration`

Configuration element `defaultChildConfig` applies to only folders. It holds configuration information to be applied to all child resources in the folder. Element `defaultChildConfig` has one or more `configuration` child elements, each of which defines a possible configuration for resources in the folder.

A `configuration` element has the following child elements:

- `pre-condition` (optional) – This element specifies a condition that must be met before the resource configuration identified by the `path` element (see next) can be used as the default configuration. If element `pre-condition` is absent, then the resource configuration file targeted by `path` applies to all resources in the folder. That is, the precondition is treated as `true`.

A `pre-condition` element has an optional `existsNode` child element. An `existsNode` element has a required `XPath` child element and an optional `namespace` child element, both strings. These define an XPath 1.0 expression and a namespace, respectively, that are used to check the existence of a resource. If that resource exists, then the precondition is satisfied, so the resource configuration file identified by `path` is used as a default resource configuration file for all child resources in the folder. The first component of the `XPath` element must be `Resource`.

Note:

A complex XPath expression for element `XPath` can impact performance negatively.

If multiple `configuration` elements have true preconditions, then each of the resource configuration files identified by their associated `path` elements applies to all of the resources in the folder.

- `path` (required) – This element specifies an absolute repository path to a resource configuration file that is to be used as the default configuration for a new resource whenever the precondition specified by element `pre-condition` is satisfied.

Typically, the value of the `path` element is a path to the current resource configuration file, that is, the file that contains the `path` element. [Example 22-1](#) (page 22-5) illustrates this, assuming that the resource configuration file is located at path `/cm/app_rc.xml` in the repository. In this example, the precondition is that there be a `Resource` node whose content is of type `xml`. When that precondition is met, the resource configuration file in [Example 22-1](#) (page 22-5) applies to all resources in same folder as the configuration file (`/cm/app_rc.xml`).

Example 22-1 Resource Configuration File

```

<ResConfig xmlns="http://xmlns.oracle.com/xdb/XDBResConfig.xsd"
  xmlns:xsi="http://www.w3.org/2001/XMLSchema-instance"
  xsi:schemaLocation="http://xmlns.oracle.com/xdb/XDBResConfig.xsd
    http://xmlns.oracle.com/xdb/XDBResConfig.xsd">
  <defaultChildConfig>
    <configuration>
      <pre-condition>
        <existsNode>
          <XPath>/Resource[ContentType="xml"]</XPath>
        </existsNode>
      </pre-condition>
      <path>/cm/app_rc.xml<path>
    </configuration>
  </defaultChildConfig>
</ResConfig>

```

22.3.3 Configuration Element applicationData

Element `applicationData` stores application-specific data. An application typically passes this data to an event handler when the handler is run. You can use any XML content you want inside element `applicationData`.

An event handler uses PL/SQL function `DBMS_XEVENT.getApplicationData` or Java function `oracle.xdb.XMLType.getApplicationData` to access the data in the `applicationData` of the resource configuration file for the event listener.

[Example 22-2](#) (page 22-5) shows an `applicationData` element for use with an Oracle Spatial and Graph application.

See Also:

- *Oracle Database PL/SQL Packages and Types Reference* for information about PL/SQL function `DBMS_XEVENT.getApplicationData`
- *Oracle Database XML Java API Reference*, class `XDBRepositoryEvent` for information about Java function `oracle.xdb.XMLType.getApplicationData`
- [Example 30-1](#) (page 30-12) for an example of a resource configuration file for event listeners

Example 22-2 applicationData Element

```

<applicationData>
  <spatial:data xmlns:spatial="http://oracle/cartridge/spatial.xsd">
    <spatial:xpos>5</spatial:xpos>
    <spatial:ypos>10</spatial:ypos>
  </spatial:data>
</applicationData>

```

Use of XLink and XInclude with Oracle XML DB

You can use XLink and XInclude with resources in Oracle XML DB Repository. But the use of XLink is *deprecated*.

- [Overview of XLink and XInclude](#) (page 23-1)
- [Link Types for XLink and XInclude](#) (page 23-2)
- [XInclude: Compound Documents](#) (page 23-3)
- [Oracle XML DB Support for XLink](#) (page 23-4)
- [Oracle XML DB Support for XInclude](#) (page 23-5)
- [Use View DOCUMENT_LINKS to Examine XLink and XInclude Links](#) (page 23-8)
- [Configuration of Repository Resources for XLink and XInclude](#) (page 23-10)
- [Manage XLink and XInclude Links Using DBMS_XDB_REPOS.processLinks](#) (page 23-16)

23.1 Overview of XLink and XInclude

A document-oriented, or **content-management**, application often tracks relationships, between documents, and those relationships are often represented and manipulated as links of various kinds. Such links can affect application behavior in various ways, including affecting the document content and the response to user operations such as mouse clicks.

W3C has two recommendations that are pertinent in this context, for documents that are managed in XML repositories:

- **XLink** – Defines various types of links between resources. These links can model arbitrary relationships between documents. Those documents can reside inside or outside the repository.
- **XInclude** – Defines ways to include the content of multiple XML documents or fragments in a single infoset. This provides for compound documents, which model inclusion relationships. **Compound documents** are documents that contain other documents. More precisely, they are file resources that include documents or document fragments. The included objects can be file resources in the same repository or documents or fragments outside the repository.

Each of these standards is very general, and it is not limited to modeling relationships between XML documents. There is no requirement that the documents linked using XLink or included in an XML document using XInclude be XML documents.

Using XLink and XInclude to represent document relationships provides flexibility for applications, facilitates reuse of component documents, and enables their fine-grained manipulation (access control, versioning, metadata, and so on). Whereas using XML data structure (an ancestor–descendants hierarchy) to model relationships requires those relationships to be relatively fixed, using XLink and XInclude to model relationships can easily allow for change in those relationships.

Note:

For XML schema-based documents to be able to use XLink and XInclude attributes, the XML schema must either explicitly declare those attributes or allow any attributes.

Note:

The use of XLink with Oracle XML DB Repository is *deprecated*, starting with Oracle Database 12c Release 2 (12.2.0.1).

See Also:

- <http://www.w3.org/TR/xlink> for information about the XLink standard
 - <http://www.w3.org/TR/xinclude> for information about the XInclude standard
-
-

23.2 Link Types for XLink and XInclude

XLink and XInclude link types are described, as well as the relation between these and Oracle XML DB Repository links. XLink links (*deprecated*) are more general than repository links. XLink links can be simple or extended. Oracle XML DB supports only simple, not extended, XLink links.

23.2.1 XLink and XInclude Links Model Document Relationships

XLink (*deprecated*) and XInclude links model arbitrary relationships among documents. The meaning and behavior of a relationship are determined by the applications that use the link. They are not inherent in the link itself. XLink and XInclude links can be mapped to Oracle XML DB document links.

When document links target Oracle XML DB Repository resources, they can (according to a configuration option) be hard or weak links. In this, they are similar to repository links in that context. Repository links can be navigated using file system-related protocols such as FTP and HTTP. Document links cannot, but they can be navigated using the XPath 2.0 function `fn:doc`.

See Also:

[Hard Links and Weak Links](#) (page 21-11)

23.2.2 XLink Link Types and XInclude Link Types

XLink (*deprecated*) and XInclude can provide links to other documents. In the case of XInclude, attributes `href` and `xpointer` are used to specify the target document.

Xlink links can be simple or extended. **Simple** links are unidirectional, from a source to a target. **Extended** links (sometimes called **complex**) can model relationships between multiple documents, with different directionalities. Both simple and extended links can include link metadata. XLink links are represented in XML data using various attributes of the namespace `http://www.w3.org/1999/xlink`, which has the predefined prefix `xlink`. Simple links are represented in XML data using attribute `type` with value `simple`, that is, `xlink:type = "simple"`. Extended Xlink links are represented using `xlink:type = "extended"`.

Third-party extended Xlink links are not contained in any of the documents whose relationships they model. Third-party links can thus be used to relate documents, such as binary files, that, themselves, have no way of representing a link.

The source end of a simple Xlink link (that is, the document containing the link) must be an XML document. The target end of a simple link can be any document. There are no such restrictions for extended links. [Example 23-3](#) (page 23-9) shows examples of simple links. The link targets are represented using attribute `xlink:href`.

Note:

The use of XLink with Oracle XML DB Repository is *deprecated*, starting with Oracle Database 12c Release 2 (12.2.0.1).

23.3 XInclude: Compound Documents

XInclude is the W3C recommendation for the syntax and processing model for merging the infosets of multiple XML documents into a single infoset. Element `xi:include` is used to include another document, specifying its URI as the value of an `href` attribute.

Element `xi:include` can be nested, so that an included document can itself include other documents.

(However, an inclusion cycle raises an error in Oracle XML DB. The resources are created, but an error is raised when the inclusions are expanded.)

XInclude thus provides for *compound* documents: repository file resources that include other XML documents or fragments. The included objects can be file resources in the same repository or documents or fragments outside the repository.

A book might be an example of a typical compound document, as managed by a content-management system. Each book includes chapter documents, which can each be managed as separate objects, with their own URLs. A chapter document can have its own metadata and access control, and it can be versioned. A book can include (reference) a specific version of a chapter document. The same chapter document can be included in multiple book documents, for reuse. Because inclusion is modeled using XInclude, content management is simplified. It is easy, for example, to replace one chapter in a book by another.

[Example 23-1](#) (page 23-4) illustrates an XML Book element that includes four documents. One of those documents, `part1.xml`, is also shown. Document `part1.xml` includes other documents, representing chapters.

These are some additional features of XInclude:

- Inclusion of plain text – You can include unparsed, non-XML text using attribute `parse` with a value of `text:parse = "text"`.
- Inclusion of XML fragments – You can use an `xpointer` attribute in an `xi:include` element to specify an XML fragment to include, instead of an entire document.
- Fallback processing – In case of error, such as inability to access the URI of an included document, an `xi:include` syntax error, or an `xpointer` reference that returns null, XInclude performs the treatment specified by element `xi:fallback`. This generally specifies an alternative element to be included. The alternative element can itself use `xi:include` to include other documents.

Example 23-1 XInclude Used in a Book Document to Include Parts and Chapters

The top-level document representing a book contains element `Book`.

```
<Book xmlns:xi="http://www.w3.org/2001/XInclude">
  <xi:include href=“toc.xml” />
  <xi:include href=“part1.xml” />
  <xi:include href=“part2.xml” />
  <xi:include href=“index.xml” />
</Book>
```

A major book part, file (resource) `part2.xml`, contains a `Part` element, which includes multiple chapter documents.

```
<?xml version=“1.0”?>
<Part xmlns:xi="http://www.w3.org/2001/XInclude">
  <xi:include href=“chapter5.xml” />
  <xi:include href=“chapter6.xml” />
  <xi:include href=“chapter8.xml” />
  <xi:include href=“chapter9.xml” />
</Part>
```

23.4 Oracle XML DB Support for XLink

You can configure Oracle XML DB Repository resources so that XLink links are ignored, or so that they are mapped to Oracle XML DB document links. However, the use of XLink with Oracle XML DB Repository is *deprecated*.

Oracle XML DB supports only simple XLink links, not extended XLink links.

When an XML document containing XLink attributes is added to Oracle XML DB Repository, either as resource content or as user-defined resource metadata, special processing can occur, depending on how the repository or individual repository resources are configured. Element `XLinkConfig` of the resource configuration document, `XDBResConfig.xsd`, determines this behavior.

If you configure resources so that XLink links are mapped to Oracle XML DB document links, you can specify that the document links are to be hard or weak. Hard and weak document links have the same properties as hard and weak repository links.

The privileges needed to create or update document links are the same as those needed to create or update repository links. Even partially updating a document requires the same privileges needed to delete the entire document and reinsert it. In particular, even if you update just one document link you must have delete and insert privileges for *each* of the documents linked by the document containing the link.

If configuration maps XLink links to document links, then, whenever a document containing XLink links is added to the repository, the XLink information is extracted and stored in a system link table. Link target (destination) locations are replaced by direct paths that are based on the resource OIDs. Configuration can also specify whether OID paths are to be replaced by named paths (URLs) upon document retrieval. Using OID paths instead of named paths generally offers a performance advantage when links are processed, including when resource contents are retrieved.

You can use XLink within resource content, but not within resource metadata.

Note:

The use of XLink with Oracle XML DB Repository is *deprecated*, starting with Oracle Database 12c Release 2 (12.2.0.1).

See Also:

- [Use View DOCUMENT_LINKS to Examine XLink and XInclude Links](#) (page 23-8)
 - [User-Defined Repository Metadata](#) (page 29-1)
 - [Hard Links and Weak Links](#) (page 21-11)
 - [Configuration of Repository Resources for XLink and XInclude](#) (page 23-10)
 - [XDBResConfig.xsd: XML Schema for Resource Configuration](#) (page A-10)
-
-

23.5 Oracle XML DB Support for XInclude

Oracle XML DB supports XInclude 1.0 as the standard mechanism for managing compound documents. It does not support attribute `xpointer` and the inclusion of document fragments, however. Only complete documents can be included (using attribute `href`).

You can use XInclude to create XML documents that include existing content. You can also configure the implicit decomposition of non-schema-based XML documents, creating a set of repository resources that contain XInclude inclusion references.

The content of included documents must be XML data or plain text (with attribute `parse = "text"`). You cannot include binary content directly using XInclude, but you can use XLink to link to binary content.

You can use XInclude within resource content, but not within resource metadata.

See Also:

[Use View DOCUMENT_LINKS to Examine XLink and XInclude Links](#) (page 23-8)

23.5.1 Expanding Compound-Document Inclusions

You can optionally expand `xi:include` elements with their targets when you retrieve a compound document from Oracle XML DB Repository.

When you retrieve a compound document you have a choice:

- Retrieve it as is, with the `xi:include` elements remaining as such. This is the default behavior.
- Retrieve it after replacing the `xi:include` elements with their targets, recursively, that is, after expansion of all inclusions. An error is raised if any `xi:include` element cannot be resolved.

To retrieve the document in expanded form, use PL/SQL constructor `XDBURIType`, passing a value of '1' or '3' as the second argument (flags). [Example 23-2](#) (page 23-6) illustrates this. These are the possible values for the second argument of constructor `XDBURIType`:

- 1 – Expand all XInclude inclusions before returning the result. If any such inclusion cannot be resolved according to the XInclude standard fallback semantics, then raise an error.
- 2 – Suppress all errors that might occur during document retrieval. This includes dangling `href` pointers.
- 3 – Same as 1 and 2 together.

[Example 23-2](#) (page 23-6) retrieves all documents that are under repository folder `public/bookdir`, expanding each inclusion:

(The result shown here corresponds to the resource `bookfile.xml` shown in [Example 23-8](#) (page 23-15), together with its included resources, `chap1.xml` and `chap2.xml`.)

See Also:

- [Compound Document Versioning, Locking, and Access Control](#) (page 23-7) for information about access control during expansion
 - *Oracle Database PL/SQL Packages and Types Reference* for more information about `XDBURIType`
-
-

Example 23-2 Expanding Document Inclusions Using XDBURIType

```
SELECT XDBURIType(ANY_PATH, '1').getXML() FROM RESOURCE_VIEW
WHERE under_path(RES, '/public/bookdir') = 1;
```

```
XDBURITYPE(ANY_PATH, '1').GETXML()
```

```
-----
<Book>
  <Title>A book</Title>
  <Chapter id="1">
    <Title>Introduction</Title>
    <Body>
      <Para>blah blah</Para>
      <Para>foo bar</Para>
    </Body>
  </Chapter>
  <Chapter id="2">
    <Title>Conclusion</Title>
    <Body>
      <Para>xyz xyz</Para>
      <Para>abc abc</Para>
    </Body>
  </Chapter>
</Book>
```



```

    </Body>
  </Chapter>
</Book>

<Chapter id="1">
  <Title>Introduction</Title>
  <Body>
    <Para>blah blah</Para>
    <Para>foo bar</Para>
  </Body>
</Chapter>

<Chapter id="2">
  <Title>Conclusion</Title>
  <Body>
    <Para>xyz xyz</Para>
    <Para>abc abc</Para>
  </Body>
</Chapter>

3 rows selected.

```

23.5.2 Validation of Compound Documents

You validate a compound document the way you would any XML document. However, you can choose to validate it in either form: with `xi:include` elements as is or after replacing them with their targets.

You can also choose to use one XML schema to validate the unexpanded form, and another to validate the expanded form. For example, you might use one XML schema to validate without first expanding, in order to set up storage structures, and then use another XML schema to validate the expanded document after it is stored.

23.5.3 Update of a Compound Document

You can update a compound document just as you would update any resource. This replaces the resource with a new value.

It thus corresponds to a resource deletion followed by a resource insertion. This means, in particular, that any `xi:include` elements in the original resource are deleted. Any `xi:include` elements in the replacement (inserted) document are processed as usual, according to the configuration defined at the time of insertion.

23.5.4 Compound Document Versioning, Locking, and Access Control

The components of a compound document are separate resources. They are versioned and locked independently, and their access is controlled independently.

- Document links to version-controlled resources (VCRs) always resolve to the latest version of the target resource, or the selected version within the current workspace. You can, however, explicitly refer to any specific version, by identifying the target resource by its OID-based path.
- Locking a document that contains `xi:include` elements does not also lock the included documents. Locking an included document does not also lock documents that include it.
- The access control list (ACL) on each referenced document is checked whenever you retrieve a compound document with expansion. This is done using the

privileges of the current user (invoker's rights). If privileges are insufficient for any of the included documents, the expansion is canceled and an error is raised.

See Also:

- [Expanding Compound-Document Inclusions](#) (page 23-5)
 - [Resource Versions](#) (page 25-1) for information about VCRs
 - [Repository Access Control](#) (page 27-1) for information about resource ACLs
-
-

23.6 Use View DOCUMENT_LINKS to Examine XLink and XInclude Links

You can query the read-only public view DOCUMENT_LINKS to obtain system information about document links derived from both XLink (*deprecated*) and XInclude links. The information in this view includes the following columns, for each link:

- SOURCE_ID – The source resource OID. RAW(16).
- TARGET_ID – The target resource OID. RAW(16).
- TARGET_PATH – Always NULL. Reserved for future use. VARCHAR2(4000).
- LINK_TYPE – The document link type: Hard or Weak. VARCHAR2(8).
- LINK_FORM – Whether the original link was of form XLink or XInclude. VARCHAR2(8).
- SOURCE_TYPE – Always Resource Content. VARCHAR2(17).

You can obtain information about a resource from this view only if one of the following conditions holds:

- The resource is a link source, and you have the privilege read-contents or read-properties on it.
- The resource is a link target, and you have the privilege read-properties on it.

See Also:

Oracle Database Reference for more information on public view DOCUMENT_LINKS

23.6.1 Querying DOCUMENT_LINKS for XLink Information

If the folder containing a given resource has been configured to map XLink links to document hard links then you can query public view DOCUMENT_LINKS to obtain system information about the document links.

Note:

The use of XLink with Oracle XML DB Repository is *deprecated*, starting with Oracle Database 12c Release 2 (12.2.0.1).

[Example 23-3](#) (page 23-9) shows how XLink links are treated when resources are created, and how to obtain system information about document links from view DOCUMENT_LINKS. It assumes that the folder containing the resource has been configured to map XLink links to document hard links.

See Also:

[Example 23-5](#) (page 23-15) for an example of configuring a folder to map XLink links to hard links

Example 23-3 Querying Document Links Mapped From XLink Links

```

DECLARE
  b BOOLEAN;
BEGIN
  b := DBMS_XDB_REPOS.createResource(
    '/public/hardlinkdir/po101.xml',
    '<PurchaseOrder id="101" xmlns:xlink="http://www.w3.org/1999/xlink">
      <Company xlink:type="simple"
        xlink:href="/public/hardlinkdir/oracle.xml">Oracle Corporation</Company>
      <Approver xlink:type="simple"
        xlink:href="/public/hardlinkdir/quine.xml">Willard Quine</Approver>
    </PurchaseOrder>');

  b := DBMS_XDB_REPOS.createResource(
    '/public/hardlinkdir/po102.xml',
    '<PurchaseOrder id="102" xmlns:xlink="http://www.w3.org/1999/xlink">
      <Company xlink:type="simple"
        xlink:href="/public/hardlinkdir/oracle.xml">Oracle Corporation</Company>
      <Approver xlink:type="simple"
        xlink:href="/public/hardlinkdir/curry.xml">Haskell Curry</Approver>
      <ReferencePO xlink:type="simple"
        xlink:href="/public/hardlinkdir/po101.xml"/>
    </PurchaseOrder>');

END;
/

SELECT r1.ANY_PATH source, r2.ANY_PATH target, dl.LINK_TYPE, dl.LINK_FORM
FROM DOCUMENT_LINKS dl, RESOURCE_VIEW r1, RESOURCE_VIEW r2
WHERE dl.SOURCE_ID = r1.RESID and dl.TARGET_ID = r2.RESID;

SOURCE                                TARGET                                LINK_TYPE LINK_FORM
-----                                -
/public/hardlinkdir/po101.xml /public/hardlinkdir/oracle.xml Hard      XLink
/public/hardlinkdir/po101.xml /public/hardlinkdir/quine.xml Hard      XLink
/public/hardlinkdir/po102.xml /public/hardlinkdir/oracle.xml Hard      XLink
/public/hardlinkdir/po102.xml /public/hardlinkdir/curry.xml Hard      XLink
/public/hardlinkdir/po102.xml /public/hardlinkdir/po101.xml Hard      XLink

```

23.6.2 Querying DOCUMENT_LINKS for XInclude Information

You can query view DOCUMENT_LINKS to show the document links that are mapped from XInclude links.

[Example 23-4](#) (page 23-9) queries view DOCUMENT_LINKS to show all document links.

Example 23-4 Querying Document Links Mapped From XInclude Links

```

DECLARE
  ret BOOLEAN;

```

```

BEGIN
  ret := DBMS_XDB_REPOS.createResource(
    '/public/hardlinkdir/book.xml',
    '<Book xmlns:xi="http://www.w3.org/2001/XInclude">
      <xi:include href="/public/hardlinkdir/toc.xml"/>
      <xi:include href="/public/hardlinkdir/part1.xml"/>
      <xi:include href="/public/hardlinkdir/part2.xml"/>
      <xi:include href="/public/hardlinkdir/index.xml"/>
    </Book>');
END;

SELECT r1.ANY_PATH source, r2.ANY_PATH target, dl.LINK_TYPE, dl.LINK_FORM
FROM DOCUMENT_LINKS dl, RESOURCE_VIEW r1, RESOURCE_VIEW r2
WHERE dl.SOURCE_ID = r1.RESID and dl.TARGET_ID = r2.RESID;

```

SOURCE	TARGET	LINK_TYPE	LINK_FORM
/public/hardlinkdir/book.xml	/public/hardlinkdir/toc.xml	Hard	XInclude
/public/hardlinkdir/book.xml	/public/hardlinkdir/part1.xml	Hard	XInclude
/public/hardlinkdir/book.xml	/public/hardlinkdir/part2.xml	Hard	XInclude
/public/hardlinkdir/book.xml	/public/hardlinkdir/index.xml	Hard	XInclude

23.7 Configuration of Repository Resources for XLink and XInclude

The resource configuration file that you use as a resource to configure XLink (*deprecated*) and XInclude processing for other resources is described.

You configure XLink and XInclude treatment for Oracle XML DB Repository resources as you would configure any other treatment of repository resources: using a resource configuration file. See [Configuring a Resource](#) (page 22-2) for an example.

A resource configuration file is an XML file that conforms to the XML schema `XDBResConfig.xsd`, which is accessible in Oracle XML DB Repository at path `/sys/schemas/PUBLIC/xmlns.oracle.com/xdb/XDBResConfig.xsd`.

You use elements `XLinkConfig` and `XIncludeConfig`, children of element `ResConfig`, to configure XLink and XInclude treatment, respectively. If one of these elements is absent, then there is no treatment of the corresponding type of links.

Both `XLinkConfig` and `XIncludeConfig` can have attribute `UnresolvedLink` and child elements `LinkType` and `PathFormat`. Element `XIncludeConfig` can also have child element `ConflictRule`. If the `LinkType` element content is `None`, however, then there must be no `PathFormat` or `ConflictRule` element.

You cannot define any preconditions for `XLinkConfig` or `XIncludeConfig`. During repository resource creation, the `ResConfig` element of the parent folder determines the treatment of XLink and XInclude links for the new resource. If the parent folder has no `ResConfig` element, then the repository-wide configuration applies.

Any change to the resource configuration file applies only to documents that are created or updated after the configuration-file change. To process links in existing documents, use PL/SQL procedure `DBMS_XDB_REPOS.processLinks`, after specifying the appropriate resource configuration parameters.

Note:

The use of XLink with Oracle XML DB Repository is *deprecated*, starting with Oracle Database 12c Release 2 (12.2.0.1).

See Also:

- [Manage XLink and XInclude Links Using DBMS_XDB_REPOS.processLinks](#) (page 23-16)
 - [Configuration of Oracle XML DB Repository](#) (page 22-1)
-

23.7.1 Configure the Treatment of Unresolved Links: Attribute UnresolvedLink

A `LinkConfig` element can have an `UnresolvedLink` attribute with a value of `Error` (default value) or `Skip`. This determines what happens if an XLink (*deprecated*) or XInclude link cannot be resolved at the time of document insertion into the repository (resource creation).

`Error` means raise an error and roll back the current operation. `Skip` means skip any treatment of the XLink or XInclude link. Skipping treatment creates the resource with no corresponding document links, and sets the resource's `HasUnresolvedLinks` attribute to `true`, to indicate that the resource has unresolved links.

Using `Skip` as the value of attribute `UnresolvedLink` can be especially useful when you create a resource that contains a cycle of weak links, which would otherwise lead to unresolved-link errors during resource creation. After the resource and all of its linked resources have been created, you can use PL/SQL procedure `DBMS_XDB_REPOS.processLinks` to process the skipped links. If all XLink and XInclude links have been resolved by this procedure, then attribute `HasUnresolvedLinks` is set to `false`.

Resource attribute `HasUnresolvedLinks` is also set to `true` for a resource that has a weak link to a resource that has been deleted. Deleting a resource thus effectively also deletes any weak links pointing to that resource. In particular, whenever the last hard link to a resource is deleted, the resource is itself deleted, and all resources that point to the deleted resource with a weak link have attribute `HasUnresolvedLinks` set to `true`.

Note:

The use of XLink with Oracle XML DB Repository is *deprecated*, starting with Oracle Database 12c Release 2 (12.2.0.1).

See Also:

- [Hard Links and Weak Links](#) (page 21-11)
 - [Manage XLink and XInclude Links Using DBMS_XDB_REPOS.processLinks](#) (page 23-16)
-

23.7.2 Configure the Type of Document Links to Create: Element LinkType

You use the `LinkType` element of a resource configuration file to specify the type of document link to be created whenever an XLink (*deprecated*) or XInclude link is encountered when a document is stored in Oracle XML DB Repository. The `LinkType` element has these possible values (element content):

- **None** (default) – Ignore XLink or XInclude links: create no corresponding document links.
- **Hard** – Map XLink or XInclude links to hard document links in repository documents.
- **Weak** – Map XLink or XInclude links to weak document links in repository documents.

Note:

The use of XLink with Oracle XML DB Repository is *deprecated*, starting with Oracle Database 12c Release 2 (12.2.0.1).

See Also:

- [Example 23-5](#) (page 23-15)
 - [Example 23-6](#) (page 23-15)
-
-

23.7.3 Configure the Path Format for Retrieval: Element PathFormat

You use the `PathFormat` element of a resource configuration file to specify the path format to be used when retrieving documents with `xlink:href` or `xi:include:href` attributes.

The `PathFormat` element has these possible values (element content) for hard and weak document links:

- **OID** (default) – Map XLink or XInclude `href` paths to OID-based paths in repository documents — that is, use OIDs directly.
- **Named** – Map XLink or XInclude `href` paths to named paths (URLs) in repository documents. The path is computed from the internal OID when the document is retrieved, so retrieval can be slower than in the case of using OID paths directly.

Note:

The use of XLink with Oracle XML DB Repository is *deprecated*, starting with Oracle Database 12c Release 2 (12.2.0.1).

See Also:

- [Example 23-5](#) (page 23-15)
 - [Example 23-6](#) (page 23-15)
-
-

23.7.4 Configure Conflict-Resolution for XInclude: Element ConflictRule

You use the `ConflictRule` element of a resource configuration file to specify the conflict-resolution rules to use if the path computed for a component document is

already present in Oracle XML DB Repository. The `ConflictRule` element has these possible values (element content):

- `Error` (default) – Raise an error.
- `Overwrite` – Update the document targeted by the existing repository path, replacing it with the document to be included. If the existing document is a version-controlled resource, then it must already be checked out, unless it is autoversioned. Otherwise, an error is raised.
- `Syspath` – Change the path to the included document to a new, system-defined path.

See Also:

[Resource Versions](#) (page 25-1) for information about version-controlled resources

23.7.5 Configure the Decomposition of Documents Using XInclude: Element `SectionConfig`

You use element `SectionConfig` of a resource configuration file to specify how non-schema-based XML documents are to be decomposed when they are added to Oracle XML DB Repository to create a set of resources that contain XInclude inclusion references.

You use simple XPath expressions in the resource configuration file to identify which parts of a document to map to separate resources, and which resources to map them to.

Element `SectionConfig` contains one or more `Section` elements, each of which contains the following child elements:

- `sectionPath` – Simple XPath 1.0 expression that identifies a section root. This must use only child and descendant axes, and it must not use wildcards.
- `documentPath` (optional) – Simple XPath 1.0 expression that is evaluated to identify the resources to be created from decomposing the document according to `sectionPath`. The XPath expression must use only child, descendant, and attribute axes.
- `namespace` (optional) – Namespace in effect for `sectionPath` and `documentPath`.

Element `Section` also has a `type` attribute that specifies the type of section to be created. Value `Document` means create a document. The default value, `None`, means do not create anything. Using `None` is equivalent to removing the `SectionConfig` element. You can thus set the `type` attribute to `None` to disable a `SectionConfig` element temporarily, without removing it, and then set it back to `Document` to enable it again.

If an element in the document being added to the repository matches more than one `sectionPath` value, only the first such expression (in document order) is used.

If no `documentPath` element is present, then the resource created has a system-defined name, and is put into the folder specified for the original document.

See Also:

- [Example 23-7](#) (page 23-15)
 - [Example 23-8](#) (page 23-15)
-

23.7.6 XLink and XInclude Configuration Examples

Examples show how XLink (*deprecated*) and XInclude are to be related to Oracle XML DB Repository resources and links.

[Example 23-5](#) (page 23-15) shows a configuration-file section that configures XInclude treatment, mapping XInclude attributes to Oracle XML DB Repository hard document links. Repository paths in retrieved resources are configured to be based on resource OIDs.

[Example 23-6](#) (page 23-15) shows an `XLinkConfig` section that maps XLink links to weak document links in the repository. In this case, retrieval of a document uses named paths (URLs).

[Example 23-7](#) (page 23-15) shows a `SectionConfig` section that specifies that each `Chapter` element in an input document is to become a separate repository file, when the input document is added to Oracle XML DB Repository. The repository path for the resulting file is specified using configuration element `documentPath`, and this path is relative to the location of the resource configuration file of [Example 23-6](#) (page 23-15).

The XPath expression here uses XPath function `concat` to concatenate the following strings to produce the resulting repository path to use:

- `chap – (prefix) chap.`
- The value of attribute `id` of element `Chapter` in the input document.
- `.xml` as a file extension.

For example, a repository path of `chap27.xml` would result from an input document with a `Chapter` element that has an `id` attribute with value `27`:

```
<Chapter id="27"> ... </Chapter>
```

If the configuration document of [Example 23-6](#) (page 23-15) and the book document that contains the XInclude elements are in repository folder `/public/bookdir`, then the individual chapter files generated from XInclude decomposition are in files `/public/bookdir/chapN.xml`, where the values of `N` are the values of the `id` attributes of `Chapter` elements.

The book document that is added to the repository is derived from the input book document. The embedded `Chapter` elements in the input book document are replaced by `xi:include` elements that reference the generated chapter documents — [Example 23-8](#) (page 23-15) illustrates this.

Note:

The use of XLink with Oracle XML DB Repository is *deprecated*, starting with Oracle Database 12c Release 2 (12.2.0.1).

See Also:

- [Configuration of Oracle XML DB Repository](#) (page 22-1)
- [XDBResConfig.xsd: XML Schema for Resource Configuration](#) (page A-10)
- [Configure the Decomposition of Documents Using XInclude: Element SectionConfig](#) (page 23-13)

Example 23-5 Mapping XInclude Links to Hard Document Links, with OID Retrieval

```
<ResConfig>
  . . .
  <XIncludeConfig UnresolvedLink="Skip">
    <LinkType>Hard</LinkType>
    <PathFormat>OID</PathFormat>
  </XIncludeConfig>
  . . .
</ResConfig>
```

Example 23-6 Mapping XLink Links to Weak Links, with Named-Path Retrieval

```
<ResConfig>
  . . .
  <XLinkConfig UnresolvedLink="Skip">
    <LinkType>Weak</LinkType>
    <PathFormat>Named</PathFormat>
  </XLinkConfig>
  . . .
</ResConfig>
```

Example 23-7 Configuring XInclude Document Decomposition

```
<ResConfig>
  . . .
  <SectionConfig>
    <Section type = "Document">
      <sectionPath>//Chapter</sectionPath>
      <documentPath>concat("chap", @id, ".xml")</documentPath>
    </Section>
  </SectionConfig>
  . . .
</ResConfig>
```

Example 23-8 Repository Document, Showing Generated xi:include Elements

```
SELECT XDBURITYPE('/public/bookdir/bookfile.xml').getclob() FROM DUAL;
```

```
XDBURITYPE('/PUBLIC/BOOKDIR/BOOKFILE.XML').GETCLOB()
```

```
-----
<Book>
  <Title>A book</Title>
  <xi:include xmlns:xi="http://www.w3.org/2001/XInclude" href="/public/bookdir/chap1.xml"/>
  <xi:include xmlns:xi="http://www.w3.org/2001/XInclude" href="/public/bookdir/chap2.xml"/>
</Book>
```

23.8 Manage XLink and XInclude Links Using DBMS_XDB_REPOS.processLinks

You can use PL/SQL procedure `DBMS_XDB_REPOS.processLinks` to manually process all XLink (*deprecated*) and XInclude links in a single document or in all documents of a folder.

Pass `RECURSIVE` as the mode argument to this procedure, if you want to process all hard-linked subfolders recursively. All XLink and XInclude links are processed according to the corresponding configuration parameters. If any of the links within a resource cannot be resolved, the resource's `HasUnresolvedLinks` attribute is set to `true`, to indicate that the resource has unresolved links. The default value of attribute `HasUnresolvedLinks` is `false`.

See Also:

[Configure the Treatment of Unresolved Links: Attribute `UnresolvedLink`](#)
(page 23-11)

Repository Access Using RESOURCE_VIEW and PATH_VIEW

Predefined public views `RESOURCE_VIEW` and `PATH_VIEW` provide access to Oracle XML DB repository data. You can use Oracle SQL functions `under_path` and `equals_path` to query resources based on their path names, and functions `path` and `depth` to return resource path names and depths.

- [Overview of Oracle XML DB RESOURCE_VIEW and PATH_VIEW](#) (page 24-1)
- [Oracle SQL Functions That Use RESOURCE_VIEW and PATH_VIEW](#) (page 24-5)
- [Accessing Repository Data Paths, Resources and Links: Examples](#) (page 24-8)
- [Deleting Repository Resources: Examples](#) (page 24-14)
- [Updating Repository Resources: Examples](#) (page 24-16)
- [Working with Multiple Oracle XML DB Resources](#) (page 24-18)
- [Performance Guidelines for Oracle XML DB Repository Operations](#) (page 24-20)
- [Searching for Resources Using Oracle Text](#) (page 24-21)

See Also:

- *Oracle Database Reference* for more information about view `PATH_VIEW`
 - *Oracle Database Reference* for more information about view `RESOURCE_VIEW`
-

24.1 Overview of Oracle XML DB RESOURCE_VIEW and PATH_VIEW

Public views `RESOURCE_VIEW` and `PATH_VIEW` provide a mechanism for using SQL to access data stored in Oracle XML DB Repository. You can use these views to access data stored in the repository using Internet protocols such as FTP and WebDAV or using application program interfaces (APIs).

[Figure 24-1](#) (page 24-2) illustrates this.

`RESOURCE_VIEW` consists of a resource, itself an `XMLType` instance, that contains the name of the resource, its ACLs, and its properties, static or extensible.

- If the content of a resource is XML data stored somewhere in an `XMLType` table or view then the `RESOURCE_VIEW` points to the `XMLType` row that stores the content.
- If the content of a resource is not XML data then the `RESOURCE_VIEW` stores the content as a LOB.

Note:

As of Oracle Database Release 11.2.0.1.0, repository content stored in line as a LOB uses SecureFiles LOB storage. Prior to that, it used BasicFiles LOB storage.

Parent-child relationships between folders are maintained and traversed efficiently using the hierarchical repository index. Text indexes are available to search the properties of a resource, and internal B-tree indexes over names and ACLs speed up access to these attributes of the resource XMLType data.

RESOURCE_VIEW and PATH_VIEW, along with PL/SQL package DBMS_XDB_REPOS, provide all query-based access to Oracle XML DB and DML functionality that is available through the API.

The base table for RESOURCE_VIEW is XDB.XDB\$RESOURCE. Access this table only using RESOURCE_VIEW or PL/SQL package DBMS_XDB_REPOS.

See Also:

[Overview of How To Use Oracle XML DB](#) (page 3-1)

Figure 24-1 Accessing Repository Resources Using RESOURCE_VIEW and PATH_VIEW

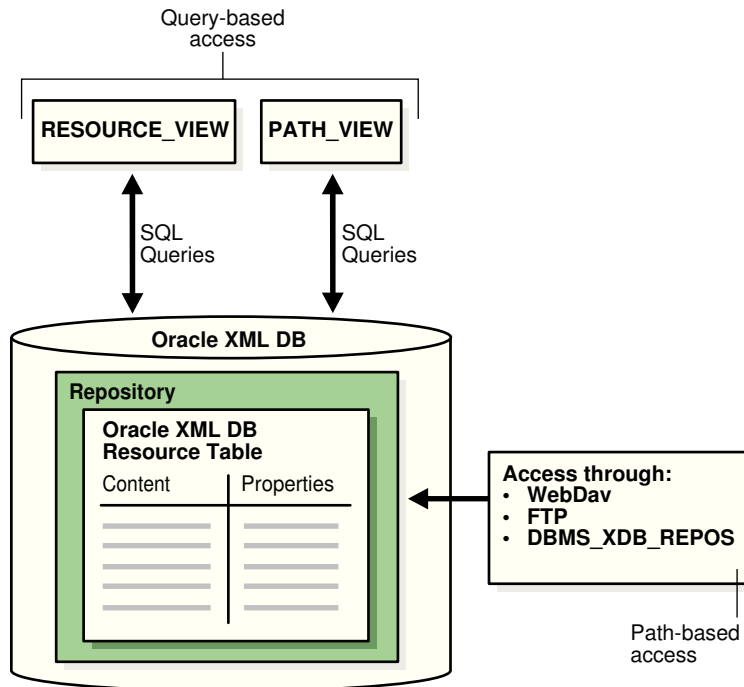

Figure 24-2 (page 24-3) illustrates the structure of RESOURCE_VIEW and PATH_VIEW.

Figure 24-2 RESOURCE_VIEW and PATH_VIEW Structure

RESOURCE_VIEW Columns			PATH_VIEW Columns			
Resource as an XMLType	Path	Resource OID	Path	Resource as an XMLType	Link as XMLType	Resource OID
_____	_____	_____	_____	_____	_____	_____
_____	_____	_____	_____	_____	_____	_____
_____	_____	_____	_____	_____	_____	_____
_____	_____	_____	_____	_____	_____	_____

Note:

Neither RESOURCE_VIEW nor PATH_VIEW contains the *root* folder (/) resource. All other repository resources are included.

A path in the RESOURCE_VIEW is an arbitrary one of the paths that can be used to access the given resource. Oracle SQL function `under_path` lets applications search for resources that are contained (recursively) within a particular folder, get the resource depth, and so on. Each row in the PATH_VIEW and RESOURCE_VIEW columns is of data type XMLType. DML on repository views can be used to insert, rename, delete, and update resource properties and contents. Programmatic APIs must be used for some operations, such as creating links to existing resources.

Paths in the ANY_PATH column of the RESOURCE_VIEW and the PATH column in the PATH_VIEW are *absolute* paths: they start at the root.

Note:

Test resource paths for equality using Oracle SQL function `equals_path`: `equals_path('/my/path') = 1`. Do *not* test ANY_PATH for equality against an absolute path: `ANY_PATH = '/my/path'`.

Paths returned by the `path` function are *relative* paths under the path name specified by function `under_path`. For example, if there are two resources referenced by path names `/a/b/c` and `/a/d`, respectively, then a path expression that retrieves paths under folder `/a` returns relative paths `b/c` and `d`.

When there are multiple hard links to the same resource, only paths under the path name specified by function `under_path` are returned. If `/a/b/c`, `/a/b/d`, and `/a/e` are all links to the same resource, then a query on PATH_VIEW that retrieves all of the paths under `/a/b` returns only `/a/b/c` and `/a/b/d`, not `/a/e`.

24.1.1 RESOURCE_VIEW Definition and Structure

Public view RESOURCE_VIEW contains one row for each resource in Oracle XML DB Repository (except for the root folder resource).

Table 24-1 (page 24-3) describes the structure of RESOURCE_VIEW.

Table 24-1 Structure of RESOURCE_VIEW

Column	Data Type	Description
RES	XMLType	A resource in the repository (except for the root folder resource)

Table 24-1 (Cont.) Structure of RESOURCE_VIEW

Column	Data Type	Description
ANY_PATH	VARCHAR2	An (absolute) path to the resource
RESID	RAW	Resource OID, which is a unique handle to the resource

24.1.2 PATH_VIEW Definition and Structure

Public view `PATH_VIEW` contains one row for each unique path that accesses a resource in Oracle XML DB Repository (except for the root folder resource). Each resource can have multiple paths, also called **links**.

[Table 24-2](#) (page 24-4) describes the structure of `PATH_VIEW`.

Table 24-2 Structure of PATH_VIEW

Column	Data Type	Description
PATH	VARCHAR2	An (absolute) path to repository resource RES
RES	XMLType	The resource referred to by column PATH
LINK	XMLType	Link property
RESID	RAW	Resource OID

24.1.3 The Difference Between RESOURCE_VIEW and PATH_VIEW

`PATH_VIEW` includes *all* the path names to a particular resource. `RESOURCE_VIEW` includes *one* of the possible path names to the resource. `PATH_VIEW` also includes the link properties. For better performance, use `RESOURCE_VIEW`, not `PATH_VIEW`, whenever possible.

[Figure 24-3](#) (page 24-5) illustrates this difference.

Because many Internet applications need only one URL to access a resource, `RESOURCE_VIEW` is widely applicable.

`PATH_VIEW` contains both *link* properties and resource properties, whereas the `RESOURCE_VIEW` contains only resource properties.

Because it handles the information for multiple paths, `PATH_VIEW` access can be slower. If you use `RESOURCE_VIEW` then the database can take advantage of the fact that only one path is needed; the index can do less work to determine all the possible paths.

Note:

When using `RESOURCE_VIEW`, if you specify a path using function `under_path` or `equals_path`, the function finds the resource regardless of whether or not the specified path is the arbitrary one chosen to normally appear with that resource using `RESOURCE_VIEW`.

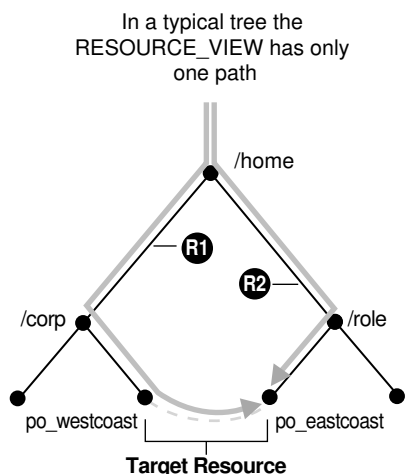
Figure 24-3 RESOURCE_VIEW and PATH_VIEW Explained

With PATH_VIEW, to access the target resource node; You can create a link. This provides two access paths **R1** or **R2** to the target node, for faster access.

RESOURCE_VIEW Example:

```
select path(1) from RESOURCE_VIEW where under_path(res, '/sys',1);
displays one path to the resource:
/home/corp/po_westcoast
```

PATH_VIEW Example:

```
select path from PATH_VIEW;
displays all pathnames to the resource:
/home/corp/po_westcoast
/home/role/po_eastcoast
```

24.1.4 Operations You Can Perform Using UNDER_PATH and EQUALS_PATH

You can use Oracle SQL functions `under_path` and `equals_path` to get a resource or its OID; create, delete, or update a resource; or list a directory that corresponds to a path name.

- Given a path name, you can:
 - Get a resource or its OID
 - List the directory given by the path name
 - Create a resource
 - Delete a resource
 - Update a resource
- Given a condition that uses `under_path` or other SQL functions, you can:
 - Update resources
 - Delete resources
 - Get resources or their OID

24.2 Oracle SQL Functions That Use RESOURCE_VIEW and PATH_VIEW

Oracle SQL functions used with public views `RESOURCE_VIEW` and `PATH_VIEW` include `under_path`, `equals_path`, `path`, and `depth`.

24.2.1 UNDER_PATH SQL Function

Oracle SQL function `under_path` uses the hierarchical index of Oracle XML DB Repository to return the paths to all hard links under a particular path. This index is designed to speed access when traversing a path (the most common usage).

If the other parts of a query predicate are very selective, however, then a functional implementation of `under_path` can be chosen that walks back up the repository. This can be more efficient, because fewer links must be traversed. [Figure 24-4](#) (page 24-6) shows the `under_path` syntax.

Figure 24-4 UNDER_PATH Syntax

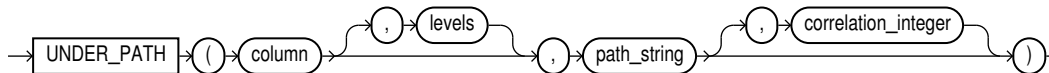

[Table 24-3](#) (page 24-6) details the signature of Oracle SQL function `under_path`.

Table 24-3 UNDER_PATH SQL Function Signature

Syntax	Description
<code>under_path(resource_column, pathname);</code>	<p>Determines whether a resource is under a specified path.</p> <p>Parameters:</p> <ul style="list-style-type: none"> <code>resource_column</code> – The column name or column alias of the <code>RESOURCE</code> column in the <code>PATH_VIEW</code> or <code>RESOURCE_VIEW</code>. <code>pathname</code> – The path name to resolve.
<code>under_path(resource_column, depth, pathname);</code>	<p>Determines whether a resource is under a specified path, with a depth argument to restrict the number of levels to search.</p> <p>Parameters:</p> <ul style="list-style-type: none"> <code>resource_column</code> – The column name or column alias of the <code>RESOURCE</code> column in the <code>PATH_VIEW</code> or <code>RESOURCE_VIEW</code>. <code>depth</code> – The maximum depth to search. A nonnegative integer. <code>pathname</code> – The path name to resolve.
<code>under_path(resource_column, pathname, correlation);</code>	<p>Determines if a resource is under a specified path, with a correlation argument for related SQL functions.</p> <p>Parameters:</p> <ul style="list-style-type: none"> <code>resource_column</code> – The column name or column alias of the <code>RESOURCE</code> column in the <code>PATH_VIEW</code> or <code>RESOURCE_VIEW</code>. <code>pathname</code> – The path name to resolve. <code>correlation</code> – An integer that can be used to correlate <code>under_path</code> with related SQL functions (path and depth).

Table 24-3 (Cont.) UNDER_PATH SQL Function Signature

Syntax	Description
<pre>under_path(resource_column, depth, pathname, correlation);</pre>	<p>Determines if a resource is under a specified path with a depth argument to restrict the number of levels to search, and with a correlation argument for related SQL functions.</p> <p>Parameters:</p> <ul style="list-style-type: none"> <i>resource_column</i> – The column name or column alias of the RESOURCE column in the PATH_VIEW or RESOURCE_VIEW. <i>depth</i> – The maximum depth to search. A nonnegative integer. <i>pathname</i> – The path name to resolve. <i>correlation</i> – An integer that can be used to correlate under_path with related SQL functions (path and depth). <p>For a resource to be returned, only one of the accessible paths to the resource must be under the <i>pathname</i> argument. If no such path is under argument <i>pathname</i> then a NULL value is returned.</p>

Note:

Function `under_path` does not follow weak links, because such traversal could lead to cycles. A weak-link argument to `under_path` is resolved correctly, but weak links are not followed when traversing resources under that path.

24.2.2 EQUALS_PATH SQL Function

You use Oracle SQL function `equals_path` to find a resource that has a given path name. It is functionally equivalent to `under_path` with a depth restriction of zero.

```
equals_path(resource_column, pathname);
```

where:

- resource_column* is the column name or column alias of the RESOURCE column in PATH_VIEW or RESOURCE_VIEW.
- pathname* is the (absolute) path name to resolve. This can contain components that are hard or weak resource links.

Figure 24-5 (page 24-7) illustrates the complete `equals_path` syntax.

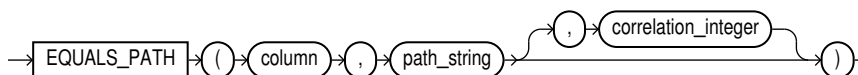
Figure 24-5 EQUALS_PATH Syntax

Note:

- Test resource paths for equality using Oracle SQL function `equals_path`: `equals_path('/my/path') = 1`. Do *not* test `ANY_PATH` for equality against an absolute path: `ANY_PATH = '/my/path'`.
- Use bind variables, instead of hard-coded strings, with `equals_path`.

24.2.3 PATH SQL Function

Oracle SQL function `path` returns the relative path name of the resource under a given `pathname` argument to function `under_path` or `equal_path`.

The `path` column in the `RESOURCE_VIEW` always contains the absolute path of the resource. The syntax of function `path` is:

```
path(correlation);
```

where:

- `correlation` is an integer that can be used to correlate `path` with `under_path` or `equals_path`.

Figure 24-6 (page 24-8) illustrates the syntax for function `path`.

Figure 24-6 PATH Syntax

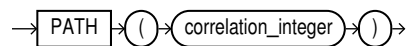

24.2.4 DEPTH SQL Function

Oracle SQL function `depth` returns the folder depth of the resource under the specified starting path.

```
depth(correlation);
```

where:

`correlation` is an integer that can be used to correlate `depth` with `path` with `under_path` or `equals_path`.

24.3 Accessing Repository Data Paths, Resources and Links: Examples

Examples here illustrate how to access Oracle XML DB Repository paths, resources, and link properties.

The first few examples use resources specified by the following paths:

```
/a/b/c
/a/b/c/d
/a/e/c
/a/e/c/d
```

Example 24-1 (page 24-9) uses Oracle SQL function `path` to retrieve the *relative* paths under path `/a/b`.

Example 24-2 (page 24-9) uses `ANY_PATH` to retrieve the *absolute* paths under path `/a/b`.

[Example 24-3](#) (page 24-9) is the same as [Example 24-2](#) (page 24-9), except that the test is *not*-equals (!=) instead of equals (=). The query in [Example 24-3](#) (page 24-9) finds *all paths in the repository* that are *not* under path /a/b.

[Example 24-4](#) (page 24-10) shows the relative paths that are under repository folders a/b and /a/e, respectively. The expression `path(1)` represents the paths that are under folder a/b, since it uses the same correlation number, `1`, as the expression `under_path(RES, '/a/b', 1)`, which specifies folder a/b. Similarly for `path(2)` and folder /a/e. Expression `ANY_PATH` returns the corresponding absolute paths.

Example 24-1 Determining Paths Under a Path: Relative

```
SELECT path(1) FROM RESOURCE_VIEW WHERE under_path(RES, '/a/b', 1) = 1;
```

```
PATH(1)
-----
c
c/d
```

2 rows selected.

Example 24-2 Determining Paths Under a Path: Absolute

```
SELECT ANY_PATH FROM RESOURCE_VIEW WHERE under_path(RES, '/a/b') = 1;
```

```
ANY_PATH
-----
/a/b/c
/a/b/c/d
```

2 rows selected.

Example 24-3 Determining Paths Not Under a Path

```
SELECT ANY_PATH FROM RESOURCE_VIEW WHERE under_path(RES, '/a/b') != 1
```

```
ANY_PATH
-----
/a
/a/b
/a/e
/a/e/c
/a/e/c/d
/home
/home/OE
/home/OE/PurchaseOrders
/home/OE/PurchaseOrders/2002
/home/OE/PurchaseOrders/2002/Apr
/home/OE/PurchaseOrders/2002/Apr/AMCEWEN-20021009123336171PDT.xml
/home/OE/PurchaseOrders/2002/Apr/AMCEWEN-20021009123336271PDT.xml
/home/OE/PurchaseOrders/2002/Apr/EABEL-20021009123336251PDT.xml
. . .
/public
/sys
/sys/acls
/sys/acls/all_all_acl.xml
/sys/acls/all_owner_acl.xml
/sys/acls/bootstrap_acl.xml
/sys/acls/ro_all_acl.xml
/sys/apps
/sys/apps/plsql
/sys/apps/plsql/xs
```

```

/sys/apps/plsql/xs/netaclrc.xml
/sys/apps/plsql/xs/netaclsc.xml
/sys/databaseSummary.xml
/sys/log
/sys/schemas
/sys/schemas/OE
/sys/schemas/OE/localhost:8080
. . .

```

326 rows selected.

Example 24-4 Determining Paths Using Multiple Correlations

```

SELECT ANY_PATH, path(1), path(2)
FROM RESOURCE_VIEW
WHERE under_path(RES, '/a/b', 1) = 1 OR under_path(RES, '/a/e', 2) = 1;

```

```

ANY_PATH  PATH(1)  PATH(2)
-----
/a/b/c    c
/a/b/c/d  c/d
/a/e/c                    c
/a/e/c/d                    c/d

```

4 rows selected.

Example 24-5 Relative Path Names for Three Levels of Resources

```

SELECT path(1) FROM RESOURCE_VIEW WHERE under_path(RES, 3, '/sys', 1) = 1;

```

This produces a result similar to the following.

```

PATH(1)
-----
acls
acls/all_all_acl.xml
acls/all_owner_acl.xml
acls/bootstrap_acl.xml
acls/ro_all_acl.xml
apps
apps/plsql
apps/plsql/xs
databaseSummary.xml
log
schemas
schemas/OE
schemas/OE/localhost:8080
schemas/PUBLIC
schemas/PUBLIC/www.w3.org
schemas/PUBLIC/xmlns.oracle.com

```

93 rows selected.

Example 24-6 Extracting Resource Metadata Using UNDER_PATH

```

SELECT ANY_PATH,
XMLQuery('declare namespace ns = "http://xmlns.oracle.com/xdb/XDBResource.xsd"; (: : )
        $r/ns:Resource' PASSING RES AS "r" RETURNING CONTENT)
FROM RESOURCE_VIEW WHERE under_path(RES, '/sys') = 1;

```

This produces a result similar to the following:

```

ANY_PATH
-----
XMLQUERY('DECLARE NAMESPACES="HTTP://XMLNS.ORACLE.COM/XDB/XDBRESOURCE.XSD";(::)$
-----
/sys/acls
<Resource xmlns="http://xmlns.oracle.com/xdb/XDBResource.xsd">
  <CreationDate>2008-06-25T13:17:45.164662</CreationDate>
  <ModificationDate>2008-06-25T13:17:47.865163</ModificationDate>
  <DisplayName>acls</DisplayName>
  <Language>en-US</Language>
  <CharacterSet>UTF-8</CharacterSet>
  <ContentType>application/octet-stream</ContentType>
  <RefCount>1</RefCount>
</Resource>

/sys/acls/all_all_acl.xml
<Resource xmlns="http://xmlns.oracle.com/xdb/XDBResource.xsd">
  <CreationDate>2008-06-25T13:17:47.759806</CreationDate>
  <ModificationDate>2008-06-25T13:17:47.759806</ModificationDate>
  <DisplayName>all_all_acl.xml</DisplayName>
  <Language>en-US</Language>
  <CharacterSet>UTF-8</CharacterSet>
  <ContentType>text/xml</ContentType>
  <RefCount>1</RefCount>
</Resource>
. . .
41 rows selected.

```

Example 24-7 Using Functions PATH and DEPTH with PATH_VIEW

```

SELECT path(1) path, depth(1) depth FROM PATH_VIEW
WHERE under_path(RES, 3, '/sys', 1) = 1;

```

This produces a result similar to the following:

PATH	DEPTH
----	-----
acls	1
acls/all_all_acl.xml	2
acls/all_owner_acl.xml	2
acls/bootstrap_acl.xml	2
acls/ro_all_acl.xml	2
apps	1
apps/plsql	2
apps/plsql/xs	3
databaseSummary.xml	1
log	1
schemas	1
schemas/OE	2
schemas/OE/localhost:8080	3
schemas/PUBLIC	2
schemas/PUBLIC/www.w3.org	3
schemas/PUBLIC/xmlns.oracle.com	3
. . .	

Example 24-8 Extracting Link and Resource Information from PATH_VIEW

```

SELECT PATH,
XMLCast(XMLQuery(
  'declare namespace ns =
    "http://xmlns.oracle.com/xdb/XDBResource.xsd"; (: :)'

```

```

        $l/ns:LINK/ns:Name' PASSING LINK AS "l" RETURNING CONTENT)
    AS VARCHAR2(256)),
XMLCast(XMLQuery(
    'declare namespace ns =
        "http://xmlns.oracle.com/xdm/XDBResource.xsd"; (: :)
    $l/ns:LINK/ns:ParentName' PASSING LINK AS "l" RETURNING CONTENT)
    AS VARCHAR2(256)),
XMLCast(XMLQuery(
    'declare namespace ns =
        "http://xmlns.oracle.com/xdm/XDBResource.xsd"; (: :)
    $l/ns:LINK/ns:ChildName' PASSING LINK AS "l" RETURNING CONTENT)
    AS VARCHAR2(256)),
XMLCast(XMLQuery(
    'declare namespace ns =
        "http://xmlns.oracle.com/xdm/XDBResource.xsd"; (: :)
    $r/ns:Resource/ns:DisplayName'
    PASSING RES AS "r" RETURNING CONTENT)
    AS VARCHAR2(128))
FROM PATH_VIEW WHERE PATH LIKE '/sys%';

```

This produces a result similar to the following:

```

/sys/schemas/PUBLIC/www.w3.org/1999/xlink.xsd
xlink.xsd

/sys/schemas/PUBLIC/www.w3.org/1999/xlink
xlink

/sys/schemas/PUBLIC/www.w3.org/1999/csx.xlink.xsd
csx.xlink.xsd

. . .

118 rows selected.

```

Example 24-9 All Repository Paths to a Certain Depth Under a Path

```
SELECT path(1) FROM PATH_VIEW WHERE under_path(RES, 3, '/sys', 1) > 0;
```

This produces a result similar to the following:

```

PATH(1)
-----
acls
acls/all_all_acl.xml
acls/all_owner_acl.xml
acls/bootstrap_acl.xml
acls/ro_all_acl.xml
apps
apps/plsql
apps/plsql/xs
databaseSummary.xml
log
principals
principals/groups
principals/users
schemas
schemas/PUBLIC
schemas/PUBLIC/www.opengis.net
schemas/PUBLIC/www.w3.org
schemas/PUBLIC/xmlns.oracle.com
workspaces

```

. . .

43 rows selected.

Example 24-10 Locating a Repository Path Using EQUALS_PATH

```
SELECT ANY_PATH FROM RESOURCE_VIEW WHERE equals_path(RES, '/sys') > 0;
```

```
ANY_PATH
-----
/sys
```

1 row selected.

Example 24-11 Retrieve RESID of a Given Resource

```
SELECT RESID FROM RESOURCE_VIEW
WHERE XMLCast(XMLQuery(
    'declare namespace ns =
      "http://xmlns.oracle.com/xdm/XDBResource.xsd"; (: :)
      $r/ns:Resource/ns:DisplayName'
    PASSING RES AS "r" RETURNING CONTENT)
  AS VARCHAR2(128))
  = 'example';
```

This produces a result similar to the following:

```
RESID
-----
F301A10152470252E030578CB00B432B
```

1 row selected.

Example 24-12 Obtaining the Path Name of a Resource from its RESID

```
DECLARE
  resid_example RAW(16);
  path          VARCHAR2(4000);
BEGIN
  SELECT RESID INTO resid_example FROM RESOURCE_VIEW
  WHERE XMLCast(XMLQuery(
    'declare namespace ns =
      "http://xmlns.oracle.com/xdm/XDBResource.xsd"; (: :)
      $r/ns:Resource/ns:DisplayName'
    PASSING RES AS "r" RETURNING CONTENT)
    AS VARCHAR2(128))
    = 'example';
  SELECT ANY_PATH INTO path FROM RESOURCE_VIEW WHERE RESID = resid_example;
  DBMS_OUTPUT.put_line('The path is: ' || path);
END;
```

The path is: /public/example

PL/SQL procedure successfully completed.

Example 24-13 Folders Under a Given Path

```
SELECT ANY_PATH FROM RESOURCE_VIEW
WHERE under_path(RES, 1, '/sys') = 1
AND XMLExists('declare namespace ns =
  "http://xmlns.oracle.com/xdm/XDBResource.xsd"; (: :)
```

```
$r/ns:Resource[@Container = xs:boolean("true")]'  
PASSING RES AS "r");
```

This produces a result like the following:

```
ANY_PATH  
-----  
/sys/acls  
/sys/apps  
/sys/log  
/sys/schemas  
  
4 rows selected.
```

Example 24-14 Joining RESOURCE_VIEW with an XMLType Table

```
SELECT ANY_PATH, XMLQuery('$p/PurchaseOrder/LineItems'  
                          PASSING po.OBJECT_VALUE AS "p" RETURNING CONTENT)  
FROM purchaseorder po, RESOURCE_VIEW rv  
WHERE ref(po)  
      = XMLCast(XMLQuery('declare default element namespace  
                          "http://xmlns.oracle.com/xdb/XDBResource.xsd"; (: :)  
                          fn:data(/Resource/XMLRef)'  
                          PASSING rv.RES RETURNING CONTENT)  
              AS REF XMLType)  
AND ROWNUM < 2;
```

```
ANY_PATH  
-----  
XMLQUERY(' $P/PURCHASEORDER/LINEITEMS' PASSINGPO.OBJECT_VALUEAS"P"RETURNINGCONTENT  
-----  
/home/OE/PurchaseOrders/2002/Apr/AMCEWEN-20021009123336171PDT.xml  
<LineItems>  
  <LineItem ItemNumber="1">  
    <Description>Salesman</Description>  
    <Part Id="37429158920" UnitPrice="39.95" Quantity="2"/>  
  </LineItem>  
  <LineItem ItemNumber="2">  
    <Description>Big Deal on Madonna Street</Description>  
    <Part Id="37429155424" UnitPrice="29.95" Quantity="1"/>  
  </LineItem>  
  <LineItem ItemNumber="3">  
    <Description>Hearts and Minds</Description>  
    <Part Id="37429166321" UnitPrice="39.95" Quantity="1"/>  
  </LineItem>  
  
  . . .  
  
  <LineItem ItemNumber="23">  
    <Description>Great Expectations</Description>  
    <Part Id="37429128022" UnitPrice="39.95" Quantity="4"/>  
  </LineItem>  
</LineItems>  
  
1 row selected.
```

24.4 Deleting Repository Resources: Examples

Examples here illustrate how to delete Oracle XML DB Repository resources and paths.

If you delete only *leaf* resources, then you can use `DELETE FROM RESOURCE_VIEW`, as in [Example 24-15](#) (page 24-15).

For multiple links to the same resource, deleting from `RESOURCE_VIEW` deletes the resource together with *all* of its links. Deleting from `PATH_VIEW` deletes only the link with the specified path.

[Example 24-16](#) (page 24-15) illustrates this.

Example 24-15 Deleting Resources

```
DELETE FROM RESOURCE_VIEW WHERE equals_path(RES, '/public/myfile') = 1;
```

Example 24-16 Deleting Links to Resources

Suppose that `'/home/myfile1'` is a link to `'/public/myfile'`:

```
CALL DBMS_XDB_REPOS.link('/public/myfile', '/home', 'myfile1');
```

The following SQL DML statement deletes everything in Oracle XML DB Repository that is found at path `/home/myfile1` – both the link and the resource:

```
DELETE FROM RESOURCE_VIEW WHERE equals_path(RES, '/home/myfile1') = 1;
```

The following DML statement deletes *only the link* with path `/home/file1`:

```
DELETE FROM PATH_VIEW WHERE equals_path(RES, '/home/file1') = 1;
```

24.4.1 Deleting Nonempty Folder Resources

The `DELETE` DML operator is not allowed on a nonempty folder. If you try to delete a nonempty folder, you must first delete its contents and then delete the resulting empty folder. This rule must be applied recursively to any folders contained in the target folder.

However, the order of the paths returned from a `WHERE` clause is not guaranteed, and the `DELETE` operator does not allow an `ORDER BY` clause in its table-expression subclause. You *cannot* do the following:

```
DELETE FROM (SELECT 1 FROM RESOURCE_VIEW
             WHERE under_path(RES, '/public', 1) = 1
             ORDER BY depth(1) DESCENDING);
```

[Example 24-17](#) (page 24-15) illustrates how to delete a nonempty folder: folder `example` is deleted, along with its subfolder `example1`.

Note:

As always, take care to avoid deadlocks with concurrent transactions when operating on multiple rows.

Example 24-17 Deleting a Nonempty Folder

```
SELECT PATH FROM PATH_VIEW WHERE under_path(RES, '/home/US1') = 1;
```

```
PATH
-----
/home/US1/example
/home/US1/example/example1
```

2 rows selected.

```
DECLARE
  CURSOR c1 IS
    SELECT ANY_PATH p FROM RESOURCE_VIEW
      WHERE under_path(RES, '/home/US1', 1) = 1
        AND XMLExists('declare namespace ns =
          "http://xmlns.oracle.com/xdb/XDBResource.xsd"; (: :)
          $r/ns:Resource[ns:Owner="US1"]' PASSING RES AS "r")
      ORDER BY depth(1) DESC;
  del_stmt VARCHAR2(500) :=
    'DELETE FROM RESOURCE_VIEW WHERE equals_path(RES, :1)=1';
BEGIN
  FOR r1 IN c1 LOOP
    EXECUTE IMMEDIATE del_stmt USING r1.p;
  END LOOP;
END;
/
```

PL/SQL procedure successfully completed.

```
SELECT PATH FROM PATH_VIEW WHERE under_path(RES, '/home/US1') = 1;
```

no rows selected

24.5 Updating Repository Resources: Examples

Examples here illustrate how to update Oracle XML DB Repository resources and paths.

[Example 24-18](#) (page 24-17) changes the resource at path `/test/HR/example/paper`.

See Also:

[User-Defined Repository Metadata](#) (page 29-1) for additional examples of updating resource metadata

By default, the `DisplayName` element content, `paper`, was the same text as the last location step of the resource path, `/test/HR/example/paper`. This is only the default value, however. The `DisplayName` is independent of the resource path, so updating it does not change the path.

Element `DisplayName` is defined by the WebDAV standard, and it is recognized by WebDAV applications. Applications, such as an FTP client, that are not WebDAV-based do not recognize the `DisplayName` of a resource. An FTP client lists the resource as `paper` (using FTP command `ls`, for example) even after the `UPDATE` operation.

[Example 24-19](#) (page 24-18) changes the path for the resource from `/test/HR/example/paper` to `/test/myexample`. It is analogous to using the UNIX or Linux command `mv /test/HR/example/paper /test/myexample`.

See Also:

[Table 21-3](#) (page 21-21) for additional examples that use SQL functions that apply to `RESOURCE_VIEW` and `PATH_VIEW`

Example 24-18 Updating a Resource

This is the complete resource before the update operation:

```
SELECT XMLSerialize(DOCUMENT r.RES AS CLOB)
   FROM RESOURCE_VIEW r WHERE equals_path(r.RES, '/test/HR/example/paper') = 1;

XMLSERIALIZE(DOCUMENTR.RESASCLOB)
-----
<Resource xmlns="http://xmlns.oracle.com/xdb/XDBResource.xsd" Hidden="false" Invalid="false" Container="false" CustomRslv="false" VersionHistory="false" StickyRef="true">
  <CreationDate>2005-04-29T16:30:01.588835</CreationDate>
  <ModificationDate>2005-04-29T16:30:01.588835</ModificationDate>
  <DisplayName>paper</DisplayName>
  <Language>en-US</Language>
  <CharacterSet>UTF-8</CharacterSet>
  <ContentType>application/octet-stream</ContentType>
  <RefCount>1</RefCount>
  <ACL>
    <acl description="Public:All privileges to PUBLIC" xmlns="http://xmlns.oracle.com/xdb/acl.xsd" xmlns:xsi="http://www.w3.org/2001/XMLSchema-instance" xsi:schemaLocation="http://xmlns.oracle.com/xdb/acl.xsd http://xmlns.oracle.com/xdb/acl.xsd">
      <ace>
        <principal>PUBLIC</principal>
        <grant>true</grant>
        <privilege>
          <all/>
        </privilege>
      </ace>
    </acl>
  </ACL>
  <Owner>TESTUSER1</Owner>
  <Creator>TESTUSER1</Creator>
  <LastModifier>TESTUSER1</LastModifier>
  <SchemaElement>http://xmlns.oracle.com/xdb/XDBSchema.xsd#binary</SchemaElement>
  <Contents>
    <binary>4F7261636C65206F7220554E4958</binary>
  </Contents>
</Resource>

1 row selected.
```

All of the XML elements shown here are resource *metadata* elements, with the exception of *Contents*, which contains the resource *content*.

This UPDATE statement updates (only) the *DisplayName* metadata element.

```
UPDATE RESOURCE_VIEW r
   SET r.RES =
       XMLQuery('copy $i := $p1 modify
                (for $j in $i/Resource/DisplayName
                 return replace value of node $j with $p2)
                return $i'
              PASSING r.RES AS "p1", 'My New Paper' AS "p2"
              RETURNING CONTENT)
   WHERE equals_path(r.RES, '/test/HR/example/paper') = 1;

1 row updated.
```

```

SELECT XMLSerialize(DOCUMENT r.RES AS CLOB)
   FROM RESOURCE_VIEW r WHERE equals_path(r.RES, '/test/HR/example/paper') = 1;

XMLSERIALIZE(DOCUMENTR.RESASCLOB)
-----
<Resource xmlns="http://xmlns.oracle.com/xdb/XDBResource.xsd" Hidden="false" Inva
alid="false" Container="false" CustomRslv="false" VersionHistory="false" StickyR
ef="true">
  <CreationDate>2005-04-29T16:30:01.588835</CreationDate>
  <ModificationDate>2005-04-29T16:30:01.883838</ModificationDate>
  <DisplayName>My New Paper</DisplayName>
  <Language>en-US</Language>

  . . .

  <Contents>
    <binary>4F7261636C65206F7220554E4958</binary>
  </Contents>
</Resource>

1 row selected.

```

Example 24-19 Updating a Path in the PATH_VIEW

```

SELECT ANY_PATH FROM RESOURCE_VIEW WHERE under_path(RES, '/test') = 1;

ANY_PATH
-----
/test/HR
/test/HR/example
/test/HR/example/paper

3 rows selected.

UPDATE PATH_VIEW
   SET PATH = '/test/myexample' WHERE PATH = '/test/HR/example/paper';

ANY_PATH
-----
/test/HR
/test/HR/example
/test/myexample

3 rows selected.

```

24.6 Working with Multiple Oracle XML DB Resources

To perform an operation on multiple Oracle XML DB resources, or to find one or more Oracle XML DB resources that meet a certain set of criteria, use SQL with `RESOURCE_VIEW` and `PATH_VIEW`.

For example, you can perform the following operations:

- Update resources based on attributes – see [Example 24-20](#) (page 24-19)
- Finding resources inside a folder – see [Example 24-21](#) (page 24-19)
- Copy a set of Oracle XML DB resources – see [Example 24-22](#) (page 24-19)

The SQL DML statement in [Example 24-22](#) (page 24-19) copies all of the resources in folder `public` to folder `newlocation`. It is analogous to the UNIX or Linux

command `cp /public/* /newlocation`. Target folder `newlocation` must exist before the copy.

Example 24-20 Updating Resources Based on Attributes

```
UPDATE RESOURCE_VIEW
SET RES =
  XMLQuery('copy $i := $p1 modify
           (for $j in $i/Resource/DisplayName
            return replace value of node $j with $p2)
           return $i'
  PASSING RES AS "p1", 'My New Paper' AS "p2"
  RETURNING CONTENT)
WHERE XMLCast(XMLQuery('declare namespace ns =
                       "http://xmlns.oracle.com/xdb/XDBResource.xsd"; (: :)
                       $r/ns:Resource/ns:DisplayName'
                       PASSING RES AS "r" RETURNING CONTENT)
              AS VARCHAR2(128))
          = 'My Paper';
```

1 row updated.

```
SELECT ANY_PATH FROM RESOURCE_VIEW
WHERE XMLCast(XMLQuery('declare namespace ns =
                       "http://xmlns.oracle.com/xdb/XDBResource.xsd"; (: :)
                       $r/ns:Resource/ns:DisplayName'
                       PASSING RES AS "r" RETURNING CONTENT)
              AS VARCHAR2(128))
          = 'My New Paper';
```

```
ANY_PATH
-----
/test/myexample
```

1 row selected.

Example 24-21 Finding Resources Inside a Folder

```
SELECT ANY_PATH FROM RESOURCE_VIEW
WHERE under_path(resource, '/sys/schemas/PUBLIC/xmlns.oracle.com/xdb') = 1;
```

```
ANY_PATH
-----
/sys/schemas/PUBLIC/xmlns.oracle.com/xdb/XDBResource.xsd
/sys/schemas/PUBLIC/xmlns.oracle.com/xdb/XDBSchema.xsd
/sys/schemas/PUBLIC/xmlns.oracle.com/xdb/XDBStandard.xsd
/sys/schemas/PUBLIC/xmlns.oracle.com/xdb/acl.xsd
/sys/schemas/PUBLIC/xmlns.oracle.com/xdb/dav.xsd
/sys/schemas/PUBLIC/xmlns.oracle.com/xdb/log
/sys/schemas/PUBLIC/xmlns.oracle.com/xdb/log/xdblog.xsd
/sys/schemas/PUBLIC/xmlns.oracle.com/xdb/stats.xsd
/sys/schemas/PUBLIC/xmlns.oracle.com/xdb/xdbconfig.xsd
```

12 rows selected.

Example 24-22 Copying Resources

```
SELECT PATH FROM PATH_VIEW WHERE under_path(RES, '/test') = 1;
```

```
PATH
-----
/test/HR
```

```

/test/HR/example
/test/myexample

3 rows selected.

INSERT INTO PATH_VIEW
  SELECT '/newlocation/' || path(1), RES, LINK, NULL FROM PATH_VIEW
  WHERE under_path(RES, '/test', 1) = 1
  ORDER BY depth(1);

3 rows created.

SELECT PATH FROM PATH_VIEW WHERE under_path(RES, '/newlocation') = 1;

PATH
-----
/newlocation/HR
/newlocation/HR/example
/newlocation/myexample

3 rows selected.

```

24.7 Performance Guidelines for Oracle XML DB Repository Operations

Guidelines are presented for improving the performance of repository operations such as resource creation and querying.

Folders that contain a large number of resources can negatively affect concurrency, particularly when many resources are created or deleted. As a rule of thumb, do not have folders that contain more than 10,000 resources. This empirical limit is based on the database block size and the average filename length.

If you create resources in bulk, perform a `COMMIT` operation at least every 1,000 resources. Performance can be negatively impacted if you commit very often or you commit less often than every 1,000 resource creations.

When creating a file resource that is an XML Schema-based document for which the XML schema is known, specify the XML schema URL as a parameter to PL/SQL function `DBMS_XDB_REPOS.createResource`. This saves parsing the document to determine the XML schema.

Oracle XML DB uses configuration file `xdbconfig.xml` for configuring the system and protocol environment. This file includes an element parameter, `resource-view-cache-size`, that defines the size in dynamic memory of the `RESOURCE_VIEW` cache. The default value is 1048576.

The performance of some queries on `RESOURCE_VIEW` and `PATH_VIEW` can be improved by tuning `resource-view-cache-size`. In general, the bigger the cache size, the faster the query. The default `resource-view-cache-size` is appropriate for most cases, but you may want to enlarge your `resource-view-cache-size` element when querying a sizable `RESOURCE_VIEW`.

The default limits for the following elements are soft limits. The system automatically adapts when these limits are exceeded.

- `xdbcore-loadableunit-size` – This element indicates the maximum size to which a loadable unit (partition) can grow in Kilobytes. When a partition is read into memory or a partition is built while consuming a new document, the partition is built until it reaches the maximum size. The default value is 16 KB.

- `xdbc_core-xobmem-bound` – This element indicates the maximum memory in kilobytes that a document is allowed to occupy. The default value is 1024 KB. Once the document exceeds this number, some loadable units (partitions) are swapped out.

See Also:

- [Administration of Oracle XML DB](#) (page 34-1)
 - *Oracle Database PL/SQL Packages and Types Reference* for information about PL/SQL function `DBMS_XDB_REPOS.createResource`
-
-

24.8 Searching for Resources Using Oracle Text

Table `XDB$RESOURCE` in database schema `XDB` stores the metadata and content of repository resources. You can search for resources that contain a specific keyword by using Oracle SQL function `contains` with `RESOURCE_VIEW` or `PATH_VIEW`.

To evaluate such queries, you must first create a context index on the `XDB$RESOURCE` table. Depending on the type of documents stored in Oracle XML DB, choose one of the following options for creating your context index:

- *If Oracle XML DB contains only XML documents, that is, no binary data, then a regular Context Index can be created on the `XDB$RESOURCE` table. This is the case for [Example 24-24](#) (page 24-22).*

```
CREATE INDEX xdb$resource_ctx_i ON XDB.XDB$RESOURCE(OBJECT_VALUE)
INDEXTYPE IS CTXSYS.CONTEXT;
```

See Also:

[Query and Update of XML Data](#) (page 5-1)

- *If Oracle XML DB contains binary data such as Microsoft Word documents, then a user filter is required to filter such documents prior to indexing. Use package `DBMS_XDBT` (`dbmsxdbt.sql`) to create and configure the Context Index.*

```
-- Install the package - connected as SYS
@dbmsxdbt
-- Create the preferences
EXEC DBMS_XDBT.createPreferences;
-- Create the index
EXEC DBMS_XDBT.createIndex;
```

See Also:

- *Oracle Database PL/SQL Packages and Types Reference* for information about installing and using `DBMS_XDBT`.
 - [PL/SQL APIs for XMLType: References](#) (page 11-2)
-
-

Package `DBMS_XDBT` also includes procedures to synchronize and optimize the index. You can use procedure `configureAutoSync()` to automatically sync the index by using job queues.

Example 24-23 Find All Resources Containing "Paper"

```
SELECT PATH FROM PATH_VIEW WHERE contains(RES, 'Paper') > 0;
```

```
PATH
-----
/newlocation/myexample
/test/myexample
```

2 rows selected.

Example 24-24 Find All Resources Containing "Paper" that are Under a Specified Path

```
SELECT ANY_PATH FROM RESOURCE_VIEW
       WHERE contains(RES, 'Paper') > 0 AND under_path(RES, '/test') > 0;
```

```
ANY_PATH
-----
/test/myexample
```

1 row selected.

Resource Versions

Oracle XML DB Repository resources can be versioned. A record is kept of all changes to a resource that is under version control.

- [Overview of Oracle XML DB Repository Resource Versioning](#) (page 25-1)
- [Resource Versions and Resource IDs](#) (page 25-4)
- [Resource Versions and ACLs](#) (page 25-5)
- [Resource Versioning Examples](#) (page 25-6)

25.1 Overview of Oracle XML DB Repository Resource Versioning

You can create and manage different versions of a repository resource. A record is kept of all changes to a resource that is under version control. When you update a version-controlled resource, the pre-update contents are stored as a separate resource version – a snapshot for the historical record.

Versioning features include the following:

- Version control for a resource.

You can turn version control on or off for an Oracle XML DB Repository resource.

- Updating a version-controlled resource.

When Oracle XML DB updates a version-controlled resource, it creates a new version of the resource. This new version is not deleted from the database when you delete the version-controlled resource.

- Accessing a version-controlled resource.

You can access a version-controlled resource the same way you access any other resource.

- Accessing a resource version.

To access a particular version of a resource, you use the resource ID of that version. The resource ID can be obtained from the resource version history or from the version-controlled resource itself. See [Resource Versions and Resource IDs](#) (page 25-4).

[Table 25-1](#) (page 25-1) lists some terms used in this chapter.

Table 25-1 Oracle XML DB Versioning Terms

Term	Description
Versionable resource	A resource that can be put under version control. All Oracle XML DB resources except folders and ACLs are versionable.

Table 25-1 (Cont.) Oracle XML DB Versioning Terms

Term	Description
Version-controlled resource	A resource that is under version control.
Version resource	A particular version of a version-controlled resource. A version resource is itself a resource. It is system-generated, and it has no associated path name. It is read-only (it cannot be updated or deleted).
<code>checkOut</code> , <code>checkIn</code> , <code>unCheckOut</code>	Operations for managing version-controlled resources. You must use <code>checkOut</code> before you can modify a version-controlled resource. Use <code>checkIn</code> to make your changes permanent. Use <code>unCheckOut</code> to cancel your changes. (Use <code>COMMIT</code> after each of these operations.)

Note:

Oracle XML DB supports version control only for Oracle XML DB resources. It does *not* support version control for user-defined tables or data in Oracle Database.

Oracle does *not* guarantee preservation of the resource ID of a version across check-in and check-out. Everything except the resource ID of the latest version is preserved.

Oracle XML DB supports versioning of XML resources that are not XML schema-based. It also supports versioning of XML schema-based resources and resources that contain XML schema-based metadata, but only if the underlying tables have *no* associated triggers or constraints.

If hierarchy is enabled for a table, then the table has a trigger. This includes tables that are created as part of XML schema registration, for which the default behavior is to enable hierarchy.

Be aware also that if you query one of the tables underlying a resource, the query can return data from multiple versions of the resource. This is because the data for the different resource versions is stored in the same underlying table, using different rows.

25.2 Overview of PL/SQL Package DBMS_XDB_VERSION

You use PL/SQL package `DBMS_XDB_VERSION` to work with Oracle XML DB Repository resource versions.

[Table 25-2](#) (page 25-3) summarizes the main `DBMS_XDB_VERSION` subprograms.

Table 25-2 PL/SQL Functions and Procedures in Package DBMS_XDB_VERSION

Function or Procedure	Description
<pre>makeVersioned(pathname VARCHAR2) RETURN DBMS_XDB_VERSION.RESID _TYPE;</pre>	<p>Turn a resource with the given path name into a version controlled resource.</p> <p>If two or more path names refer to the same resource, then the resource is copied, and argument path name is bound with the copy. The new resource is put under version control. All other path names continue to refer to the original resource.</p> <p>The argument is the path name of the resource to be put under version control.</p> <p>Returns the resource ID of the first version resource of the version-controlled resource.</p> <p>This is not an auto-commit SQL operation. An error is raised if you call <code>makeVersioned</code> for a folder, version resource, or ACL, or if the target resource does not exist. Note: No error or warning is raised if you call <code>makeVersioned</code> for a version-controlled resource.</p>
<pre>checkout(pathname VARCHAR2);</pre>	<p>Check out a version-controlled resource. You cannot update or delete a version-controlled resource until you check it out. Check-out is for all users: any user can modify a resource that has been checked out.</p> <p>The argument is the path name of the version-controlled resource to be checked out. This is not an auto-commit SQL operation. If two users check out the same version-controlled resource at the same time, then one user must roll back. As a precaution, commit after checking out and before updating a resource. An error is raised if the target resource is not under version control, does not exist, or is already checked out.</p>
<pre>checkin(pathname VARCHAR2) RETURN DBMS_XDB_VERSION.RESID _TYPE;</pre>	<p>Check in a version-controlled resource that has been checked out.</p> <p><code>pathname</code> - Path name of the checked-out resource.</p> <p>Returns the resource id of the newly created version.</p> <p>This is not an auto-commit SQL operation. You need not use the same path name that was used for check-out. However, the check-in path name and the check-out path name must reference the same resource, or else results are unpredictable.</p> <p>If the resource has been renamed, then the new name must be used when checking it in. An error is raised if the path name refers to no resource.</p>
<pre>uncheckOut(pathname VARCHAR2) RETURN DBMS_XDB_VERSION.RESID _TYPE;</pre>	<p>Check in a checked-out resource.</p> <p>The argument is the path name of the checked-out resource.</p> <p>Returns the resource id of the version before the resource was checked out. This is not an auto-commit SQL operation. You need not use the same path name that was used for check-out. However, the <code>uncheckOut</code> path name and the check-out path name must reference the same resource, or else results are unpredictable.</p> <p>If the resource has been renamed, then the new name must be used for <code>uncheckOut</code>. An error is raised if the path name refers to no resource.</p>
<pre>getPredecessors(pathname VARCHAR2) RETURN RESID_LIST_TYPE; getPredsByRESID(resid DBMS_XDB_VERSION.RESID _TYPE) RETURN RESID_LIST_TYPE;</pre>	<p>Given a path name that references a version resource or a version-controlled resource, return the predecessors of the resource.</p> <p>Retrieving predecessors by resource ID, using function <code>getPredsByRESID</code> is more efficient than by path name, using function <code>getPredecessors</code>.</p> <p>The list of predecessors returned has only one element (the parent): Oracle XML DB does not support version branching.</p>

Table 25-2 (Cont.) PL/SQL Functions and Procedures in Package DBMS_XDB_VERSION

Function or Procedure	Description
<code>getSuccessors(pathname VARCHAR2) RETURN RESID_LIST_TYPE;</code>	Given a version resource or a version-controlled resource, return the successors of the resource.
<code>getSuccsByRESID(resid DBMS_XDB_VERSION.RESID_TYPE) RETURN RESID_LIST_TYPE;</code>	Retrieving successors by resource ID, using function <code>getSuccsByRESID</code> is more efficient than by path name, using function <code>getSuccessors</code> . The list of successors returned has only one element (the parent): Oracle XML DB does not support version branching.
<code>getResourceByRESID(resid DBMS_XDB_VERSION.RESID_TYPE) RETURN XMLType;</code>	Given a resource ID, return the resource as an <code>XMLType</code> instance.

25.3 Resource Versions and Resource IDs

A resource object ID, or **resource ID**, is a unique, constant, system-generated identifier for a resource. Each resource has a resource ID. This includes *version resources*, which are system-generated resources that do not have any path names. A resource ID is sometimes called a **RESID**.

You use PL/SQL package `DBMS_XDB_VERSION` to put a resource under version-control and manage different versions of it. Some of the `DBMS_XDB_VERSION` routines accept the path name of a version-controlled resource as argument and return the resource ID of the relevant version resource.

For example, you use function `DBMS_XDB_VERSION.makeVersioned` to put a resource under version control, that is, to turn it into a version-controlled resource. It accepts as argument a repository path to the resource.

You need not use the same path name for a given version-controlled resource when you perform various versioning operations on it, but the path names you use must all refer to the same resource.

Whenever a path name is passed as an argument representing a version-controlled resource, it is the latest (that is, the current) version of the resource that is used. A *path name always stands for the latest version*. The only way you can refer to a version other than the current version is to use its resource ID.

The resource ID of a given version is constant. Remember that a version is itself a resource, and the resource ID of a resource never changes.

Each time you check in a version-controlled resource, Oracle XML DB creates a new version resource. A **version resource** is a snapshot of a resource (its content and metadata) together with a resource ID. The collection of version resources for a given version-controlled resource constitutes a historical sequence of previous versions, the **version series** or history of the resource.

When you check in a version-controlled resource that has resource ID *R*, Oracle XML DB creates a new resource ID, *P*, which refers to a snapshot of the resource (both content and metadata), as it was before it was last checked out. The snapshot was made before check-out, but the associated version resource (and its resource ID *P*) are created at check-in time. Together, the new resource ID *P* and the snapshot it refers to thus represent the *previous*, not the current, version of the resource. Resource ID *R* continues to refer to the current version.

Put another way, when you check in a version-controlled resource, a version resource is created that represents the previous state of the version-controlled resource. Like any new resource, this new version resource is allocated a new resource ID (*P*).

You can think about making a version resource (check-in) the way you think about making a backup copy of a file: Just as you give a new name to the backup file, so the previous-version snapshot of a resource is given a new resource ID. The current resource retains the original resource ID, just as your working file keeps its original name.

What this means is that when you check in a resource, in order to "create a new version", what's really new is the version resource (resource ID *P* and the snapshot it references) that represents the *old* (previous) version. The newest, or latest, version of the resource (*R*) is really just the current version. Remember: new version resource = old (previous) version of the resource content and metadata.

Resource ID *R* refers to the *current* version of the version-controlled resource throughout its lifetime, from the moment it was put under version control until it is deleted. You can always access the latest version of a resource using its original resource ID.

When you need to refer to a previous version of a resource, you must use its resource ID to reference it. You cannot use a path name. You can use function `DBMS_XDB_VERSION.getPredsByRESID` to obtain the resource ID of the previous version of a given resource.

Note:

If you *delete* a resource, then any subsequent reference to it, whether by resource ID or path name, raises an error (typically `ORA-31001: Invalid resource handle or path name`). You *cannot* access any version of a version-controlled resource that has been deleted.

25.4 Resource Versions and ACLs

A version resource is immutable. It is a snapshot of resource content and metadata, plus a resource ID, and both snapshot and ID are static. Likewise, the access control list (ACL) of a version resource cannot be changed.

You can modify the ACL of a version-controlled resource that you have checked out. When you check it in, the modified ACL continues to be associated with the current (latest) version of the resource, and the previous version, that is, the newly created version resource, is associated with the ACL before it was modified. That is, the previous version is associated with the previous ACL, and the current version is associated with the updated ACL.

What is important to keep in mind is this:

- Different versions of a resource can have different ACLs associated with them.
- You can modify the ACL associated with the current version after you check out the resource.
- Check-in associates the ACL as it was before check-out with the newly created version resource, that is, with the previous version of the resource.
- The ACL associated with a given version remains the same.

25.5 Resource Versioning Examples

Examples here create a version-controlled resource; retrieve the content of a resource using its resource ID; check out a version-controlled resource (for all users); update the content of a resource; check in a resource; retrieve the content and metadata of different versions of a resource; and cancel a resource check-out.

- Putting a resource under version control – [Example 25-2](#) (page 25-7)
- Retrieving the content of the resource using its resource ID – [Example 25-3](#) (page 25-8)
- Checking out a version-controlled resource (for all users) – [Example 25-4](#) (page 25-8)
- Updating the content of a resource – [Example 25-5](#) (page 25-8)
- Checking in a resource – [Example 25-6](#) (page 25-9)
- Retrieving the content and metadata of different versions of a resource – [Example 25-7](#) (page 25-9), [Example 25-8](#) (page 25-9), [Example 25-9](#) (page 25-10)
- Canceling a resource check-out – [Example 25-10](#) (page 25-11)

[Example 25-3](#) (page 25-8) creates an Oracle XML DB Repository resource at repository path `/public/t1.txt`. The resource has as content the text `Mary had a little lamb`. The example uses SQL*Plus command `VARIABLE` to declare bind variables `targetPath`, `current_RESID`, and `previous_RESID`, which are used in other examples in this section.

The new resource is *not* version-controlled. [Example 25-2](#) (page 25-7) uses PL/SQL function `DBMS_XDB_VERSION.makeVersioned` to put it under version control. This function returns the resource ID of the first version resource for the version-controlled resource. The function does not auto-commit. You must explicitly use `COMMIT`.

[Example 25-2](#) (page 25-7) also copies the resource ID of the new version resource to bind variable `current_RESID`. [Example 25-3](#) (page 25-8) shows how to use PL/SQL constructor `XDBURitype` together with PL/SQL function `createOIDPath` to retrieve the resource content by referencing the resource ID.

[Example 25-4](#) (page 25-8) checks out the version-controlled resource (and commits), so that it can be modified. Any user can modify a resource that has been checked out.

[Example 25-5](#) (page 25-8) updates the content of the checked-out resource. Before the (LOB) content can be updated, you must lock the resource. The example uses a dummy update of the resource display name (a scalar attribute) to do this.

[Example 25-5](#) (page 25-8) retrieves the LOB content using the LOB locator, which is element `/ns:Resource/ns:XMLlob`. It empties the existing content and adds new content using PL/SQL procedures `trim` and `append` in package `DBMS_LOB`. It commits the content change.

See Also:

Oracle Database SecureFiles and Large Objects Developer's Guide for information about updating a LOB

At this point, the content has been modified, but this change has not been recorded in the version series. [Example 25-6](#) (page 25-9) checks in the resource and commits the check-in.

PL/SQL function `checkIn` returns the resource ID of the current version, which is the same as `current_RESID`. [Example 25-6](#) (page 25-9) passes this value to PL/SQL function `getPredsByRESID`. This function returns the list of resource IDs for the (immediate) predecessors of its argument resource.¹¹ [Example 25-6](#) (page 25-9) assigns the first (and only) element of this list to bind variable `previous_RESID`.

At this point, the value of `current_RESID` is the resource ID of the current version, and the value of `previous_RESID` is the resource ID of the previous version.

You can retrieve the content or metadata of a resource using any of the following methods:

- PL/SQL constructor `XDBURIType`, together with PL/SQL function `DBMS_XDB_REPOS.createOIDPath` – Retrieve content. See [Example 25-3](#) (page 25-8) and [Example 25-7](#) (page 25-9).
- PL/SQL function `DBMS_XDB_VERSION.getContentsCLOBByRESID` – Retrieve content. See [Example 25-8](#) (page 25-9).
- PL/SQL function `DBMS_XDB_VERSION.getResourceByRESID` – Retrieve metadata. See [Example 25-9](#) (page 25-10).

You can use constructor `XDBURIType` with function `createOIDPath` to access resource content using protocols. For example, you could have Oracle XML DB serve up various versions of a graphic image file resource for a Web page, setting the `HREF` for the HTML `IMAGE` tag to a value returned by `createOIDPath`.

[Example 25-7](#) (page 25-9) through [Example 25-9](#) (page 25-10) use these different methods to retrieve the two versions of the resource addressed by bind variables `current_RESID` and `previous_RESID` after check-in.

You can cancel a check-out using PL/SQL function `DBMS_XDB_VERSION.unCheckOut`. [Example 25-10](#) (page 25-11) illustrates this.

Example 25-1 Creating a Repository Resource

```
VARIABLE targetPath      VARCHAR2(700)
VARIABLE current_RESID  VARCHAR2(32)
VARIABLE previous_RESID VARCHAR2(32)

DECLARE
  res BOOLEAN;
BEGIN
  :targetPath := '/public/t1.txt';
  IF (DBMS_XDB_REPOS.existsResource(:targetPath))
    THEN DBMS_XDB_REPOS.deleteResource(:targetPath);
  END IF;
  res := DBMS_XDB_REPOS.createResource(:targetPath, 'Mary had a little lamb');
END;
/
```

Example 25-2 Creating a Version-Controlled Resource

```
DECLARE
  resid DBMS_XDB_VERSION.RESID_TYPE;
```

¹¹ In Oracle XML DB, a version resource always has a *single* predecessor, that is, a single version that immediately precedes it. The WebDAV standard provides for the possibility of multiple predecessors.

```

BEGIN
  resid := DBMS_XDB_VERSION.makeVersioned(:targetPath);
  :current_RESID := resid;
  COMMIT;
END;
/

```

Example 25-3 Retrieving Resource Content by Referencing the Resource ID

```

SELECT XDBURIType(DBMS_XDB_REPOS.createOIDPath(:current_RESID)).getClob()
  FROM DUAL;

XDBURITYPE(DBMS_XDB_REPOS.CREATEOIDPATH(:CURRENT_RESID)).GETCLOB()
-----
Mary had a little lamb

1 row selected.

```

Example 25-4 Checking Out a Version-Controlled Resource

```

BEGIN
  DBMS_XDB_VERSION.checkOut(:targetPath);
  COMMIT;
END;
/

```

Example 25-5 Updating Resource Content

```

DECLARE
  content          BLOB;
  newContentBlob  BLOB;
  newContentClob  CLOB;
  source_offset   INTEGER := 1;
  target_offset   INTEGER := 1;
  warning         INTEGER;
  lang_context    INTEGER := 0;
BEGIN
  -- Lock the resource using a dummy update.
  UPDATE RESOURCE_VIEW
  SET RES =
    XMLQuery('copy $i := $p1 modify
              (for $j in $i/Resource/DisplayName
               return replace value of node $j with $p2)
              return $i'
            PASSING
              RES AS "p1",
              XMLCast(XMLQuery('declare namespace ns =
                                "http://xmlns.oracle.com/xdb/XDBResource.xsd"; (: :)
                                $r/ns:Resource/ns:DisplayName/text()'
                                PASSING RES AS "r" RETURNING CONTENT)
                      AS VARCHAR2(128)) AS "p2"
            RETURNING CONTENT)
  WHERE equals_path(res, :targetPath) = 1;
  -- Get the LOB locator.
  SELECT XMLCast(XMLQuery('declare namespace ns =
                            "http://xmlns.oracle.com/xdb/XDBResource.xsd"; (: :)
                            $r/ns:Resource/ns:XMLLob'
                            PASSING RES AS "r" RETURNING CONTENT)
          AS BLOB)
  INTO content FROM RESOURCE_VIEW
  WHERE equals_path(RES, :targetPath) = 1;
  -- Update the LOB.

```



```

newContentClob := 'Hickory dickory dock, the mouse ran up the clock';
DBMS_LOB.createTemporary(newContentBlob, false, DBMS_LOB.CALL);
DBMS_LOB.convertToBlob(newContentBlob, newContentClob,
                      DBMS_LOB.getLength(newContentClob),
                      source_offset, target_offset,
                      nls_charset_id('AL32UTF8'), lang_context, warning);
DBMS_LOB.open(content, DBMS_LOB.lob_readwrite);
DBMS_LOB.trim(content, 0);
DBMS_LOB.append(content, newContentBlob);
DBMS_LOB.close(content);
DBMS_LOB.freeTemporary(newContentBlob);
DBMS_LOB.freeTemporary(newContentClob);
COMMIT;
END;
/

```

Example 25-6 Checking In a Version-Controlled Resource

```

DECLARE
  resid DBMS_XDB_VERSION.RESID_TYPE;
BEGIN
  resid := DBMS_XDB_VERSION.checkIn(:targetPath);
  :previous_RESID := DBMS_XDB_VERSION.getPredsByRESID(resid)(1);
  COMMIT;
END;
/

```

Example 25-7 Retrieving Resource Version Content Using XDBURITYPE and CREATEOIDPATH

```

SELECT XDBURITYPE(DBMS_XDB_REPOS.createOIDPath(:current_RESID)).getClob()
       FROM DUAL;

XDBURITYPE(DBMS_XDB_REPOS.CREATEOIDPATH(:CURRENT_RESID)).GETCLOB()
-----
Mary had a little lamb

1 row selected.

SELECT XDBURITYPE(DBMS_XDB_REPOS.createOIDPath(:previous_RESID)).getClob()
       FROM DUAL;

XDBURITYPE(DBMS_XDB_REPOS.CREATEOIDPATH(:PREVIOUS_RESID)).GETCLOB()
-----
Hickory dickory dock, the mouse ran up the clock

1 row selected.

```

Example 25-8 Retrieving Resource Version Content Using GETCONTENTSCLOBBYRESID

```

SELECT DBMS_XDB_VERSION.getContentsCLOBByRESID(:current_RESID) FROM DUAL;

DBMS_XDB_VERSION.GETCONTENTSCLOBBYRESID(:CURRENT_RESID)
-----
Mary had a little lamb

1 row selected.

SELECT DBMS_XDB_VERSION.getContentsCLOBByRESID(:previous_RESID) FROM DUAL;

DBMS_XDB_VERSION.GETCONTENTSCLOBBYRESID(:PREVIOUS_RESID)

```

```
-----
Hickory dickory dock, the mouse ran up the clock
```

```
1 row selected.
```

Example 25-9 Retrieving Resource Version Metadata Using GETRESOURCEBYRESID

```
SELECT XMLSerialize(DOCUMENT DBMS_XDB_VERSION.getResourceByRESID(:current_RESID)
                   AS CLOB INDENT SIZE = 2)
FROM DUAL;
<Resource xmlns="http://xmlns.oracle.com/xdb/XDBResource.xsd" Hidden="false"
  Invalid="false" VersionID="2" ActivityID="0" Container="false"
  CustomRslv="false" VersionHistory="false" StickyRef="true">
  <CreationDate>2009-05-06T12:33:34.012133</CreationDate>
  <ModificationDate>2009-05-06T12:33:34.280199</ModificationDate>
  <DisplayName>t1.txt</DisplayName>
  <Language>en-US</Language>
  <CharacterSet>UTF-8</CharacterSet>
  <ContentType>text/plain</ContentType>
  <RefCount>1</RefCount>
  <ACL>
    <acl description="Public:All privileges to PUBLIC"
      xmlns="http://xmlns.oracle.com/xdb/acl.xsd"
      xmlns:xsi="http://www.w3.org/2001/XMLSchema-instance"
      xsi:schemaLocation="http://xmlns.oracle.com/xdb/acl.xsd
        http://xmlns.oracle.com/xdb/acl.xsd"
      shared="true">
      <ace>
        <grant>true</grant>
        <principal>PUBLIC</principal>
        <privilege>
          <all/>
        </privilege>
      </ace>
    </acl>
  </ACL>
  <Owner>HR</Owner>
  <Creator>HR</Creator>
  <LastModifier>HR</LastModifier>
  <SchemaElement>http://xmlns.oracle.com/xdb/XDBSchema.xsd#text</SchemaElement>
  <Contents>
    <text>Mary had a little lamb</text>
  </Contents>
  <VCRUID>69454F2EF12E3375E040578C8A1764B5</VCRUID>
  <Parents>69454F2EF12F3375E040578C8A1764B5</Parents>
</Resource>
```

```
1 row selected.
```

```
SELECT XMLSerialize(DOCUMENT DBMS_XDB_VERSION.getResourceByRESID(:previous_RESID)
                   AS CLOB INDENT SIZE = 2)
FROM DUAL;
<Resource xmlns="http://xmlns.oracle.com/xdb/XDBResource.xsd" Hidden="false"
  Invalid="false" VersionID="1" Container="false" CustomRslv="false"
  VersionHistory="false" StickyRef="true">
  <CreationDate>2009-05-06T12:33:34.012133</CreationDate>
  <ModificationDate>2009-05-06T12:33:34.012133</ModificationDate>
  <DisplayName>t1.txt</DisplayName>
  <Language>en-US</Language>
  <CharacterSet>UTF-8</CharacterSet>
```

```

<ContentType>text/plain</ContentType>
<RefCount>0</RefCount>
<ACL>
  <acl description="Public:All privileges to PUBLIC"
    xmlns="http://xmlns.oracle.com/xdb/acl.xsd"
    xmlns:xsi="http://www.w3.org/2001/XMLSchema-instance"
    xsi:schemaLocation="http://xmlns.oracle.com/xdb/acl.xsd
      http://xmlns.oracle.com/xdb/acl.xsd"
    shared="true">
    <ace>
      <grant>true</grant>
      <principal>PUBLIC</principal>
      <privilege>
        <all/>
      </privilege>
    </ace>
  </acl>
</ACL>
<Owner>HR</Owner>
<Creator>HR</Creator>
<LastModifier>HR</LastModifier>
<SchemaElement>http://xmlns.oracle.com/xdb/XDBSchema.xsd#text</SchemaElement>
<Contents>
  <text>Hickory dickory dock, the mouse ran up the clock</text>
</Contents>
<VCRUID>69454F2EF12E3375E040578C8A1764B5</VCRUID>
</Resource>

```

1 row selected.

Example 25-10 *Canceling a Check-Out Using UNCHECKOUT*

```

DECLARE
  resid DBMS_XDB_VERSION.RESID_TYPE;
BEGIN
  resid := DBMS_XDB_VERSION.unCheckOut(:targetPath);
END;
/

```

PL/SQL Access to Oracle XML DB Repository

PL/SQL packages `DBMS_XDB_CONFIG` and `DBMS_XDB_REPOS` together provide the Oracle XML DB resource application program interface (API) for PL/SQL. You use the former to configure Oracle XML DB and its repository. You use the latter to perform other, non-configuration operations on the repository.

- [DBMS_XDB_REPOS: Access and Manage Repository Resources](#) (page 26-1)
- [DBMS_XDB_REPOS: ACL-Based Security Management](#) (page 26-3)
- [DBMS_XDB_CONFIG: Configuration Management](#) (page 26-7)

See Also:

- [PL/SQL APIs for XMLType: References](#) (page 11-2)
 - [Package DBMS_XDB_ADMIN](#) (page 34-14)
-

26.1 DBMS_XDB_REPOS: Access and Manage Repository Resources

You use PL/SQL package `DBMS_XDB_REPOS` to access and manage resources in Oracle XML DB Repository. It includes methods for managing resource security based on access control lists (ACLs). An ACL is a list of access control entries (ACEs) that determines which principals (users and roles) have access to which resources.

See Also:

Oracle Database PL/SQL Packages and Types Reference

[Table 26-1](#) (page 26-1) describes the functions and procedures in package `DBMS_XDB_REPOS`.

Table 26-1 DBMS_XDB_REPOS Resource Access and Management Subprograms

Function/Procedure	Description
<code>addResource</code>	Insert a new file resource into the repository hierarchy, with the given string as its contents.
<code>appendResourceMetadata</code>	Add user-defined metadata to a resource.
<code>createFolder</code>	Create a new folder resource.

Table 26-1 (Cont.) DBMS_XDB_REPOS Resource Access and Management Subprograms

Function/Procedure	Description
<code>createOIDPath</code>	Create a virtual path to a resource, based on its object identifier (OID).
<code>createResource</code>	Create a new file resource.
<code>deleteResource</code>	Delete a resource from the repository.
<code>deleteResourceMetadata</code>	Delete specific user-defined metadata from a resource.
<code>existsResource</code>	Indicate whether or not a resource exists, given its absolute path.
<code>getContentBLOB</code>	Return the contents of a resource as a BLOB instance.
<code>getContentVARCHAR2</code>	Return the contents of a resource as a VARCHAR2 value.
<code>getContentXMLRef</code>	Return the contents of a resource as a reference to an XMLType instance.
<code>getContentXMLType</code>	Return the contents of a resource as an XMLType instance.
<code>getLockToken</code>	Return a resource lock token for the current user, given a path to the resource.
<code>getResOID</code>	Return the object identifier (OID) of a resource, given its absolute path.
<code>getResource</code>	Return the instance of class <code>DBMS_XDBRESOURCE.XDBResource</code> that is located at a given path in the repository.
<code>getXDB_tablespace</code>	Return the current tablespace of database schema (user account) XDB.
<code>hasBLOBContent</code>	Return TRUE if a given resource has BLOB content.
<code>hasCharContent</code>	Return TRUE if a given resource has character content.
<code>hasXMLContent</code>	Return TRUE if a given resource has XMLType content.
<code>hasXMLReference</code>	Return TRUE if a given resource has a reference to XMLType content.
<code>isFolder</code>	Return TRUE if a given resource is a folder.
<code>link</code>	Create a link to an existing resource.
<code>lockResource</code>	Obtain a WebDAV-style lock on a resource, given a path to the resource.
<code>processLinks</code>	Process all XLink (<i>deprecated</i>) and XInclude links in a document or folder.
<code>purgeResourceMetadata</code>	Delete all user-defined metadata from a given resource.
<code>refreshContentSize</code>	Recompute the content size of a given resource.
<code>renameResource</code>	Rename a given resource.
<code>touchResource</code>	Change the last-modified time to the current time.
<code>unlockResource</code>	Unlock a resource, given its lock token and path.
<code>updateResourceMetadata</code>	Modify user-defined resource metadata.

[Example 26-1](#) (page 26-3) uses package `DBMS_XDB_REPOS` to manage repository resources. It creates the following:

- A folder, `mydocs`, under folder `/public`
- Two file resources, `emp_selby.xml` and `emp_david.xml`
- Two links to the file resources `person_selby.xml` and `person_david.xml`

It then deletes each of the newly created resources and links. The folder contents are deleted before the folder itself.

See Also:

[User-Defined Repository Metadata](#) (page 29-1) for examples using `appendResourceMetadata` and `deleteResourceMetadata`

Example 26-1 Managing Resources Using DBMS_XDB_REPOS

```

DECLARE
    retb BOOLEAN;
BEGIN
    retb := DBMS_XDB_REPOS.createfolder('/public/mydocs');
    retb := DBMS_XDB_REPOS.createresource('/public/mydocs/emp_selby.xml',
                                         '<emp_name>selby</emp_name>');
    retb := DBMS_XDB_REPOS.createresource('/public/mydocs/emp_david.xml',
                                         '<emp_name>david</emp_name>');
END;
/
PL/SQL procedure successfully completed.

CALL DBMS_XDB_REPOS.link('/public/mydocs/emp_selby.xml',
                        '/public/mydocs',
                        'person_selby.xml');

Call completed.

CALL DBMS_XDB_REPOS.link('/public/mydocs/emp_david.xml',
                        '/public/mydocs',
                        'person_david.xml');

Call completed.

CALL DBMS_XDB_REPOS.deleteresource('/public/mydocs/emp_selby.xml');
Call completed.

CALL DBMS_XDB_REPOS.deleteresource('/public/mydocs/person_selby.xml');
Call completed.

CALL DBMS_XDB_REPOS.deleteresource('/public/mydocs/emp_david.xml');
Call completed.

CALL DBMS_XDB_REPOS.deleteresource('/public/mydocs/person_david.xml');
Call completed.

CALL DBMS_XDB_REPOS.deleteresource('/public/mydocs');
Call completed.

```

26.2 DBMS_XDB_REPOS: ACL-Based Security Management

PL/SQL package `DBMS_XDB_REPOS` provides Oracle XML DB ACL-based security management functions and procedures.

Table 26-2 DBMS_XDB_REPOS: Security Management Subprograms

Function/Procedure	Description
ACLCheckPrivileges	Check the access privileges granted to the current user by an ACL.
changeOwner	Change the owner of a given resource to a given user.
changePrivileges	Add an ACE to a resource ACL.
checkPrivileges	Check the access privileges granted to the current user for a resource.
getACLDocument	Return the ACL document that protects a resource, given the path name of the resource.
getPrivileges	Return all privileges granted to the current user for a resource.
setACL	Set the ACL for a resource.

See Also:

Oracle Database PL/SQL Packages and Types Reference

In [Example 26-2](#) (page 26-4), database user HR creates two resources: a folder, /public/mydocs, with a file in it, emp_selby.xml. Procedure getACLDocument is called on the file resource, showing that the <principal> user for the document is PUBLIC.

In [Example 26-3](#) (page 26-5), the system manager connects and uses procedure setACL to give the owner (database schema HR) all privileges on the file resource created in [Example 26-2](#) (page 26-4). Procedure getACLDocument then shows that the <principal> user is dav:owner, the owner (HR).

In [Example 26-4](#) (page 26-6), user HR connects and uses function changePrivileges to add a new access control entry (ACE) to the ACL, which gives all privileges on resource emp_selby.xml to user oe. Procedure getACLDocument shows that the new ACE was added to the ACL.

In [Example 26-5](#) (page 26-7), user oe connects and calls DBMS_XDB_REPOS.getPrivileges, which shows all of the privileges granted to user oe on resource emp_selby.xml.

Example 26-2 Using DBMS_XDB_REPOS.GETACLDOCUMENT

```
CONNECT hr
Enter password: password

Connected.

DECLARE
  retb BOOLEAN;
BEGIN
  retb := DBMS_XDB_REPOS.createFolder('/public/mydocs');
  retb := DBMS_XDB_REPOS.createResource('/public/mydocs/emp_selby.xml',
                                         '<emp_name>selby</emp_name>');
END;
```



```

/
PL/SQL procedure successfully completed.

SELECT XMLSerialize(DOCUMENT
                    DBMS_XDB_REPOS.getACLDocument('/public/mydocs/emp_selby.xml')
                    AS CLOB)
FROM DUAL;

XMLSERIALIZE(DOCUMENTDBMS_XDB_REPOS.GETACLDOCUMENT('/PUBLIC/MYDOCS/EMP_SELBY.XML
-----
<acl description="Public:All privileges to PUBLIC" xmlns="http://xmlns.oracle.co
m/xdb/acl.xsd" xmlns:xsi="http://www.w3.org/2001/XMLSchema-instance" xsi:schemaL
ocation="http://xmlns.oracle.com/xdb/acl.xsd" http://xm
lns.oracle.com/xdb/acl.xsd" shared="true">
  <ace>
    <grant>true</grant>
    <principal>PUBLIC</principal>
    <privilege>
      <all/>
    </privilege>
  </ace>
</acl>

1 row selected.

```

Example 26-3 Using DBMS_XDB_REPOS.SETACL

```

CONNECT SYSTEM
Enter password: password

Connected.

-- Give all privileges to owner, HR.
CALL DBMS_XDB_REPOS.setACL('/public/mydocs/emp_selby.xml',
                          '/sys/acls/all_owner_acl.xml');

Call completed.
COMMIT;
Commit complete.

SELECT XMLSerialize(DOCUMENT
                    DBMS_XDB_REPOS.getACLDocument('/public/mydocs/emp_selby.xml')
                    AS CLOB)
FROM DUAL;

XMLSERIALIZE(DOCUMENTDBMS_XDB_REPOS.GETACLDOCUMENT('/PUBLIC/MYDOCS/EMP_SELBY.XML
-----
<acl description="Private:All privileges to OWNER only and not accessible to oth
ers" xmlns="http://xmlns.oracle.com/xdb/acl.xsd" xmlns:dav="DAV:" xmlns:xsi="htt
p://www.w3.org/2001/XMLSchema-instance" xsi:schemaLocation="http://xmlns.oracle.
com/xdb/acl.xsd http://xmlns.oracle.com/xdb/acl.xsd" shared="true">
  <ace>
    <grant>true</grant>
    <principal>dav:owner</principal>
    <privilege>
      <all/>
    </privilege>
  </ace>
</acl>

1 row selected.

```

Example 26-4 Using DBMS_XDB_REPOS.CHANGEPRIVILEGES

```

CONNECT hr
Enter password: password

Connected.

SET SERVEROUTPUT ON

-- Add an ACE giving privileges to user OE
DECLARE
  r          PLS_INTEGER;
  ace        XMLType;
  ace_data   VARCHAR2(2000);
BEGIN
  ace_data := '<ace xmlns="http://xmlns.oracle.com/xdb/acl.xsd"
              xmlns:xsi="http://www.w3.org/2001/XMLSchema-instance"
              xsi:schemaLocation="http://xmlns.oracle.com/xdb/acl.xsd
              http://xmlns.oracle.com/xdb/acl.xsd
              DAV:http://xmlns.oracle.com/xdb/dav.xsd">
              <principal>OE</principal>
              <grant>true</grant>
              <privilege><all/></privilege>
              </ace>';
  ace := XMLType.createXML(ace_data);
  r := DBMS_XDB_REPOS.changePrivileges('/public/mydocs/emp_selby.xml', ace);
END;
/

PL/SQL procedure successfully completed.

COMMIT;

SELECT XMLSerialize(DOCUMENT
                   DBMS_XDB_REPOS.getACLDocument('/public/mydocs/emp_selby.xml')
                   AS CLOB)

FROM DUAL;

XMLSERIALIZE(DOCUMENTDBMS_XDB_REPOS.GETACLDOCUMENT('/PUBLIC/MYDOCS/EMP_SELBY.XML
-----
<acl description="Private:All privileges to OWNER only and not accessible to oth
ers" xmlns="http://xmlns.oracle.com/xdb/acl.xsd" xmlns:dav="DAV:" xmlns:xsi="htt
p://www.w3.org/2001/XMLSchema-instance" xsi:schemaLocation="http://xmlns.oracle.
com/xdb/acl.xsd http://xmlns.oracle.com/xdb/acl.xsd" s
hared="false">
  <ace>
    <grant>true</grant>
    <principal>dav:owner</principal>
    <privilege>
      <all/>
    </privilege>
  </ace>
  <ace>
    <grant>true</grant>
    <principal>OE</principal>
    <privilege>
      <all/>
    </privilege>
  </ace>
</acl>

```

1 row selected.

Example 26-5 Using DBMS_XDB_REPOS.GETPRIVILEGES

```
CONNECT oe
```

```
Enter password: password
```

```
Connected.
```

```
SELECT XMLSerialize(DOCUMENT
                    DBMS_XDB_REPOS.getPrivileges('/public/mydocs/emp_selby.xml')
                    AS CLOB)
FROM DUAL;
```

```
XMLSERIALIZE(DOCUMENTDBMS_XDB_REPOS.GETPRIVILEGES('/PUBLIC/MYDOCS/EMP_SELBY.XML'
```

```
-----
<privilege xmlns="http://xmlns.oracle.com/xdb/acl.xsd" xmlns:xsi="http://www.w3.
org/2001/XMLSchema-instance" xsi:schemaLocation="http://xmlns.oracle.com/xdb/acl
.xsd http://xmlns.oracle.com/xdb/acl.xsd DAV: http://xmlns.oracle.com/xdb/dav.xs
d" xmlns:xdbacl="http://xmlns.oracle.com/xdb/acl.xsd" xmlns:dav="DAV:">
  <read-properties/>
  <read-contents/>
  <write-config/>
  <link/>
  <unlink/>
  <read-acl/>
  <write-acl-ref/>
  <update-acl/>
  <resolve/>
  <link-to/>
  <unlink-from/>
  <dav:lock/>
  <dav:unlock/>
  <dav:write-properties/>
  <dav:write-content/>
  <dav:execute/>
  <dav:take-ownership/>
  <dav:read-current-user-privilege-set/>
</privilege>
```

1 row selected.

26.3 DBMS_XDB_CONFIG: Configuration Management

PL/SQL package DBMS_XDB_CONFIG provides Oracle XML DB configuration management functions and procedures.

Note:

Oracle recommends that you use the subprograms of PL/SQL package DBMS_XDB_CONFIG to set or change FTP or HTTP port numbers. Do *not* set ports by directly editing configuration file `xdbconfig.xml`

Table 26-3 DBMS_XDB_CONFIG: Configuration Management Subprograms

Subprogram	Description
addHTTPExpireMapping	Add a mapping of a URL pattern to an expiration date to table XDB\$CONFIG. The mapping controls the <code>Expire</code> headers for URLs that match the pattern.
addMIMEMapping	Add a MIME mapping to table XDB\$CONFIG.
addSchemaLocMapping	Add a schema-location mapping to table XDB\$CONFIG.
addServlet	Add a servlet to table XDB\$CONFIG.
addServletMapping	Add a servlet mapping to table XDB\$CONFIG.
addServletSecRole	Add a security role reference to a servlet.
addXMLExtension	Add an XML extension to table XDB\$CONFIG.
cfg_get	Return the configuration information for the current session.
cfg_refresh	Refresh the session configuration information using the current Oracle XML DB configuration file, <code>xdbconfig.xml</code> .
cfg_update	Update the Oracle XML DB configuration information. This writes the configuration file, <code>xdbconfig.xml</code> .
deleteHTTPExpireMapping	Delete <i>all</i> mappings of a given URL pattern to an expiration date from table XDB\$CONFIG.
deleteMIMEMapping	Delete a MIME mapping from table XDB\$CONFIG.
deleteSchemaLocMapping	Delete a schema-location mapping from table XDB\$CONFIG.
deleteServlet	Delete a servlet from table XDB\$CONFIG.
deleteServletMapping	Delete a servlet mapping from table XDB\$CONFIG.
deleteServletSecRole	Delete a security role reference from a servlet.
deleteXMLExtension	Delete an XML extension from table XDB\$CONFIG.
enableDigestAuthentication	Enable digest authentication.
getFTPPort	Return the current FTP port number.
getHTTPConfigRealm	Return the HTTP configuration realm.
getHTTPPort, getHTTPSPort	Return the current HTTP(S) port number.
getListenerEndPoint	Return the parameters of a listener end point for the HTTP server.
GetRemoteHTTPPort, GetRemoteHTTPSPort	Return the number of the current remote HTTP(S) port.
setFTPPort	Set the Oracle XML DB FTP port to the specified port number.
setHTTPConfigRealm	Set the HTTP configuration realm.
setHTTPPort, setHTTPSPort	Set the Oracle XML DB HTTP(S) port to the specified port number.

Table 26-3 (Cont.) DBMS_XDB_CONFIG: Configuration Management Subprograms

Subprogram	Description
setListenerEndPoint	Set the parameters of a listener end point for the HTTP server.
setListenerLocalAccess	Either (a) restrict all listener end points to listen on only the localhost interface or (b) allow all listener end points to listen on both localhost and non-localhost interfaces.
SetRemoteHTTPPort, SetRemoteHTTPSPort	Define the port number of a remote HTTP or HTTPS port, respectively. A remote port number is stored similarly to a non-remote HTTP(S) port, except they it is not specified in the configuration file, <code>xdbconfig.xml</code> file or in the configuration XML schema, <code>xdbconfig.xsd</code> .
usedPort	Return the ports used by other pluggable databases (PDBs) in the same multitenant container database (CDB). The return value is an <code>XMLType</code> instance that lists each PDB by id number and its associated ports by type and number.

See Also:

Oracle Database PL/SQL Packages and Types Reference, Chapter "DBMS_XDB_CONFIG"

[Example 26-6](#) (page 26-9) uses function `cfg_get` to retrieve the Oracle XML DB configuration file, `xdbconfig.xml`.

[Example 26-7](#) (page 26-10) illustrates the use of procedure `cfg_update`. The current configuration is retrieved as an `XMLType` instance and modified. It is then rewritten using `cfg_update`.

Example 26-6 Using DBMS_XDB_CONFIG.CFG_GET

```
CONNECT SYSTEM
Enter password: password

Connected.

SELECT DBMS_XDB_CONFIG.cfg_get() FROM DUAL;

DBMS_XDB_CONFIG.CFG_GET()
-----
<xdbconfig xmlns="http://xmlns.oracle.com/xdb/xdbconfig.xsd" xmlns:xsi="http://ww.w3.org/2001/XMLSchema-instance" xsi:schemaLocation="http://xmlns.oracle.com/xdb/xdbconfig.xsd http://xmlns.oracle.com/xdb/xdbconfig.xsd">
  <sysconfig>
    <acl-max-age>19</acl-max-age>
    <acl-cache-size>32</acl-cache-size>
    <invalid-pathname-chars/>
    <case-sensitive>true</case-sensitive>
    <call-timeout>6000</call-timeout>
    <max-link-queue>65536</max-link-queue>
    <max-session-use>100</max-session-use>
    <persistent-sessions>>false</persistent-sessions>
    <default-lock-timeout>3600</default-lock-timeout>
    <xdbcore-logfile-path>/sys/log/xdblog.xml</xdbcore-logfile-path>
```

```

<xdbcore-log-level>0</xdbcore-log-level>
<resource-view-cache-size>1048576</resource-view-cache-size>
<protocolconfig>
  <common>
    . . .
  </common>
  <ftpconfig>
    . . .
  </ftpconfig>
  <httpconfig>
    <http-port>0</http-port>
    <http-listener>local_listener</http-listener>
    <http-protocol>tcp</http-protocol>
    <max-http-headers>64</max-http-headers>
    <max-header-size>16384</max-header-size>
    <max-request-body>2000000000</max-request-body>
    <session-timeout>6000</session-timeout>
    <server-name>XDB HTTP Server</server-name>
    <logfile-path>/sys/log/httplog.xml</logfile-path>
    <log-level>0</log-level>
    <servlet-realm>Basic realm="XDB"</servlet-realm>
    <webappconfig>
      . . .
    </webappconfig>
    <authentication>
      . . .
    </authentication>
  </httpconfig>
</protocolconfig>
<xdbcore-xobmem-bound>1024</xdbcore-xobmem-bound>
<xdbcore-loadableunit-size>16</xdbcore-loadableunit-size>
<acl-evaluation-method>ace-order</acl-evaluation-method>
</sysconfig>
</xdbconfig>

```

1 row selected.

Example 26-7 Using DBMS_XDB_CONFIG.CFG_UPDATE

```

DECLARE
  configxml    SYS.XMLType;
  configxml2   SYS.XMLType;
BEGIN
  -- Get the current configuration
  configxml := DBMS_XDB_CONFIG.cfg_get();

  -- Modify the configuration
  SELECT XMLQuery(
    'declare default element namespace
     "http://xmlns.oracle.com/xdb/xdbconfig.xsd"; (: : )
    copy $i := $p1 modify
      (for $j in $i/xdbconfig/sysconfig/protocolconfig/httpconfig/http-port
       return replace value of node $j with $p2)
    return $i'
    PASSING CONFIGXML AS "p1", '8000' AS "p2" RETURNING CONTENT)
  INTO configxml2 FROM DUAL;

  -- Update the configuration to use the modified version
  DBMS_XDB_CONFIG.cfg_update(configxml2);
END;
/

```

PL/SQL procedure successfully completed.

```
SELECT DBMS_XDB_CONFIG.cfg_get() FROM DUAL;
```

```
DBMS_XDB_CONFIG.CFG_GET()
```

```
-----
<xdbconfig xmlns="http://xmlns.oracle.com/xdb/xdbconfig.xsd" xmlns:xsi="http://www.w3.org/2001/XMLSchema-instance" xsi:schemaLocation="http://xmlns.oracle.com/xdb/xdbconfig.xsd http://xmlns.oracle.com/xdb/xdbconfig.xsd">
  <sysconfig>
    <acl-max-age>15</acl-max-age>
    <acl-cache-size>32</acl-cache-size>
    <invalid-pathname-chars/>
    <case-sensitive>true</case-sensitive>
    <call-timeout>6000</call-timeout>
    <max-link-queue>65536</max-link-queue>
    <max-session-use>100</max-session-use>
    <persistent-sessions>false</persistent-sessions>
    <default-lock-timeout>3600</default-lock-timeout>
    <xdbcore-logfile-path>/sys/log/xdblog.xml</xdbcore-logfile-path>
    <resource-view-cache-size>1048576</resource-view-cache-size>
  <protocolconfig>
    <common>
      . . .
    </common>
    <ftpconfig>
      . . .
    </ftpconfig>
    <httpconfig>
      <http-port>8000</http-port>
      . . .
    </httpconfig>
  </protocolconfig>
  <xdbcore-xobmem-bound>1024</xdbcore-xobmem-bound>
  <xdbcore-loadableunit-size>16</xdbcore-loadableunit-size>
  <acl-evaluation-method>ace-order</acl-evaluation-method>
</xdbconfig>
```

1 row selected.

Repository Access Control

Oracle Database provides classic database security such as row-level and column-level secure access by database users. It also provides fine-grained access control for resources in Oracle XML DB Repository. You can create, set, and modify access control lists (ACLs).

- [Access Control Concepts](#) (page 27-1)
- [Database Privileges for Repository Operations](#) (page 27-5)
- [Privileges](#) (page 27-5)
- [ACLs and ACEs](#) (page 27-7)
- [Overview of Working with Access Control Lists \(ACLs\)](#) (page 27-10)
- [ACL Caching](#) (page 27-18)
- [Repository Resources and Database Table Security](#) (page 27-18)
- [Integration Of Oracle XML DB with LDAP](#) (page 27-20)

See Also:

- [Repository Access Using Protocols](#) (page 28-1) for more information about WebDAV
 - [Administration of Oracle XML DB](#) (page 34-1) for information about configuring and administering resource security
 - [PL/SQL APIs for XMLType: References](#) (page 11-2) for information about the PL/SQL APIs you can use to manage resource security
-

27.1 Access Control Concepts

Access control terms and concepts are explained. Each of the access-control entity — user, role, principal, privilege, access control list (ACL), and access control entry (ACE) — is implemented declaratively as an XML document or fragment.

Secure authorization requires defining which users, applications, or functions can have access to which data, to perform which kinds of operations. There are thus three dimensions: (1) *which users* can (2) perform *which operations* (3) on *which data*. We speak of (1) principals, (2) privileges, and (3) objects, corresponding to these three dimensions, respectively. Principals are users or roles.

Principals and privileges (dimensions 1 and 2) are related in a declarative way by defining *access control lists*. These are then related to the third dimension, data, in various ways, either declaratively or procedurally. For example, you can protect an

Oracle XML DB Repository resource or table data by using PL/SQL procedure `DBMS_XDB_REPOS.setACL` to set its controlling ACL.

27.1.1 Authentication and Authorization

The term **authentication** refers to verifying the *identity* of something (for example, a user, device, or application). The term **authorization** refers to verifying whether something that has been authenticated is allowed to *access* something else (for example, a database table or WebDAV resource).

Principals of various kinds can be authorized to access Oracle XML DB Repository resources. Application-specific principals can be authenticated.

See Also:

- [Principal: A User or Role](#) (page 27-2) for information about principals
 - "Custom Authentication and Authorization by Applications" on page 27-31 for information about authentication and authorization of application-specific principals
-
-

27.1.2 Principal: A User or Role

In the context of fine-grained database access control, a principal is ultimately a set of one or more people or applications that access information in the database. A principal can be a database user or role, or an LDAP user or group.

A **principal** is a user or a role. A **user** can be any person or application that accesses information in the database. A **role** is composed of users and possibly other roles, but this recursion cannot be circular. Ultimately, each role, and thus each principal, corresponds to a *set of users*.

A user is represented for access control purposes by an XML fragment with element `user`. A role is represented by a fragment with element `role`.

Oracle Database supports the following as principals:

- Database users and **database roles**. A **database user** is also sometimes referred to as a database **schema** or a user **account**. When a person or application logs onto the database, it uses a database user (schema) and password. A **database role** corresponds to a set of database privileges that can be granted to database users, applications, or other database roles — see [Database Roles and ACLs Map Privileges to Users](#) (page 27-2).
- LDAP users and groups of LDAP users. For details about using **LDAP principals** see [Integration Of Oracle XML DB with LDAP](#) (page 27-20).

When a term such as "user" or "role" is used here without qualification, it applies to all types of user or role. When it is important to distinguish the type, the qualifier "database" or "LDAP" is used.

27.1.2.1 Database Roles and ACLs Map Privileges to Users

A database role maps privileges to users. In the context of fine-grained access control, an ACL maps privileges to users, and a role is just a set of users.

A database role is *granted* privileges, just as a database user can be granted privileges. A database role serves as an intermediary for mapping database privileges to database

users (and applications): a role is granted privileges, and the role is then granted to users (giving them the privileges).

The line between a group of users and a group of privileges that are granted to those users is blurred a bit in the concept of database role: the role can serve to group the privileges that are mapped to the users and to group the users to which the privileges are mapped. The mapping is done by defining the role and granting it to users, and traditional database terminology considers the role to be the same thing as the set of privileges that are granted to it.

In the context of fine-grained access control, a different mechanism, an *access control list* (ACL), is used as the intermediary that maps privileges to users. A role is simply a set of users. In this context, the act of associating privileges with users and with roles is not a database grant. It is a declarative ACL entry, together with a run-time evaluation of ACLs and resolution of ACL conflicts.

Please keep this terminology difference in mind, to avoid confusion. As a means of mapping privileges to users, a database role combines some of the functionality that in an access-control context is divided into (1) principals, (2) privileges, and (3) ACLs. In access control terminology, roles are classified with users as principals. In traditional database terminology, roles are instead classified as sets of privileges.

27.1.2.2 Principal DAV::owner

You can use principal `DAV::owner` to refer to the owner of a given repository resource. The owner of a resource is one of the properties of the resource. You can use principal `DAV::owner` to facilitate ACL sharing among principals, because the owner of a resource often has special rights.

27.1.3 Privilege: A Permission

A **privilege** is a particular right or permission that can be granted or denied to a principal. A privilege is aggregate or atomic. An aggregate privilege includes other privileges; an atomic privilege does not.

- **Aggregate** privilege – A privilege that includes other privileges.
- **Atomic** privilege – A privilege that does not include other privileges. It cannot be subdivided.

Aggregate privileges simplify usability when the number of privileges becomes large, and they promote interoperability between ACL clients. See [Privileges](#) (page 27-5).

Aggregate privileges retain their identity: they are not decomposed into the corresponding atomic (leaf) privileges. In WebDAV terms, Oracle Database aggregate privileges are not abstract. This implies that an aggregate privilege acts as a set of pointers to its component privileges, rather than a copy of those components. Thus, an aggregate privilege is always up to date, even if the definition of a component changes.

The set of privileges granted to a principal controls whether that principal can perform a given operation on the data that it protects. For example, if the principal (database user) `HR` wants to perform the `read` operation on a given resource, then `read` privileges must be granted to principal `HR` prior to the `read` operation.

27.1.4 Access Control Entry (ACE)

An **access control entry (ACE)** is an XML element (`ace`) that is an entry in an access control list (ACL). An ACE either grants or denies access to some repository resource or other database data by a particular principal.

The ACE does not, itself, specify which data to protect. That is done outside the ACE and the ACL, by associating the ACL with target data. One way to make that association is by using PL/SQL procedure `DBMS_XDB_REPOS.setACL`.

See [ACL and ACE Evaluation](#) (page 27-9).

An Oracle XML DB ACE either grants or denies privileges for a principal. An **ace** element has the following:

- **Operation grant:** either `true` (to grant) or `false` (to deny) access.
- Either a valid principal (element `principal`) or a completed list of principals (element `invert`).
- **Privileges:** A set of privileges to be granted or denied for a particular principal (element `privilege`).
- **Principal format (optional):** The format of the principal. An LDAP distinguished name (DN), a short name (database user/role or LDAP nickname), or an LDAP globally unique identifier (GUID). The default value is `short name`. If the principal name matches both a database user and an LDAP nickname, it is assumed to refer to the LDAP nickname.
- **Collection (optional):** A `BOOLEAN` attribute that specifies whether the principal is a collection of users (LDAP group or database role) or a single user (LDAP user or database user).

Example 27-1 (page 27-4) shows a simple ACE that grants privilege `DAV::all` to principal `DAV::owner`. It thus grants all privileges to the owner of the resource to which its ACL applies.

Example 27-1 Simple Access Control Entry (ACE) that Grants a Privilege

```
<ace>
  <grant>true</grant>
  <principal>DAV::owner</principal>
  <privilege>
    <DAV::all/>
  </privilege>
</ace>
```

27.1.5 Access Control List (ACL)

An **access control list (ACL)** is a list of access control entries (ACEs). By default, order in the list is relevant.

See Also:

[ACL and ACE Evaluation](#) (page 27-9)

Example 27-2 (page 27-5) shows a simple ACL that contains only the ACE of **Example 27-1** (page 27-4).

Example 27-2 Simple Access Control List (ACL) that Grants a Privilege

```

<acl description="myacl"
  xmlns="http://xmlns.oracle.com/xdb/acl.xsd"
  xmlns:dav="DAV:"
  xmlns:xsi="http://www.w3.org/2001/XMLSchema-instance"
  xsi:schemaLocation="http://xmlns.oracle.com/xdb/acl.xsd
                    http://xmlns.oracle.com/xdb/acl.xsd">
  <ace>
    <grant>true</grant>
    <principal>dav:owner</principal>
    <privilege>
      <dav:all/>
    </privilege>
  </ace>
</acl>

```

27.2 Database Privileges for Repository Operations

The database privileges needed for common operations on resources in Oracle XML DB Repository are described.

[Table 27-1](#) (page 27-5) shows the database privileges required for some common operations on resources in Oracle XML DB Repository. In addition to the privileges listed in column **Privileges Required** you must have the `resolve` privilege for the folder containing the resource and for all of its parent folders, up to the root folder.

Table 27-1 Database Privileges Needed for Operations on Oracle XML DB Resources

Operation	Description	Privileges Required
CREATE	Create a new resource in folder F	update and link on folder F
DELETE	Delete resource R from folder F	update and unlink-from on R, update and unlink on folder F
UPDATE	Update the contents or properties of resources R	update on R
GET	An FTP or HTTP(S) retrieval of resource R	read-properties, read-contents on R
SET_ACL	Set the ACL of a resource R	DAV::write-acl on R
LIST	List the resources in folder F	read-properties on folder F, read-properties on resources in folder F. Only those resources on which the user has read-properties privilege are listed.

See Also:

[Upgrade or Downgrade of an Existing Oracle XML DB Installation](#) (page 34-1) for information about treatment of database access privileges when upgrading

27.3 Privileges

The privileges provided with Oracle Database include the standard WebDAV privileges as well as Oracle-specific privileges.

The standard WebDAV privileges use the WebDAV namespace **DAV:**¹¹. The Oracle-specific privileges use the Oracle XML DB ACL namespace, `http://xmlns.oracle.com/xdb/acl.xsd`, which has the predefined prefix **xdb**.

See Also:

RFC 3744: "Web Distributed Authoring and Versioning (WebDAV) Access Control Protocol", IETF Network Working Group Request For Comments #3744, May 2004

27.3.1 Atomic Privileges

An atomic privilege does not include other privileges. The available atomic privileges for repository operations are described, and their database counterparts are listed.

Table 27-2 Atomic Privileges

Atomic Privilege	Description	Database Counterpart
DAV::lock	Lock a resource using WebDAV locks.	UPDATE
DAV::read-current-user-privilege-set	Access the DAV::current-user-privilege-set property of a resource.	N/A
DAV::take-ownership	Take ownership of a resource.	N/A
DAV::unlock	Unlock a resource locked using a WebDAV lock.	UPDATE
DAV::write-content	Modify the content of a resource.	UPDATE
DAV::write-properties	Modify the properties of a resource. Lock or unlock a resource. Modifiable properties include Author, DisplayName, Language, CharSet, ContentType, SResExtra, Owner, OwnerID, CreationDate, Modification Date, ACL, ACLOID, Lock, and Locktoken.	UPDATE
xdb:link	Allow creation of links from a resource.	INSERT
xdb:link-to	Allow creation of links to a resource.	N/A
xdb:read-acl	Read the ACL of a resource.	SELECT
xdb:read-contents	Read the contents of a resource.	SELECT
xdb:read-properties	Read the properties of a resource.	SELECT
xdb:resolve	Traverse a folder (for folders only).	SELECT
xdb:unlink	Allow deletion of links from a resource.	DELETE
xdb:unlink-from	Allow deletion of links to a resource.	N/A

¹¹ Note the colon (:) as part of the namespace name. DAV: is the namespace itself, *not* a prefix. A prefix commonly used for namespace DAV: is dav, but this is only conventional. dav is not a predefined prefix for Oracle XML DB.

Table 27-2 (Cont.) Atomic Privileges

Atomic Privilege	Description	Database Counterpart
xdb:update-acl	Change the contents of the resource ACL.	UPDATE
xdb:write-acl-ref	Change the ACLOID of a resource.	UPDATE

27.3.2 Aggregate Privileges

An Aggregate privilege contains other privileges, atomic or aggregate. The available aggregate privileges for repository operations are listed together with their component atomic privileges.

Table 27-3 Aggregate Privileges

Aggregate Privilege	Component Atomic Privileges
DAV::all	All atomic DAV privileges.
xdb:all	All atomic DAV privileges plus xdb:link-to.
DAV::bind	xdb:link
DAV::unbind	xdb:unlink
DAV::read	xdb:read-properties, xdb:read-contents, xdb:resolve
DAV::read-acl	xdb:read-acl
DAV::write	DAV::write-content, DAV::write-properties, xdb:link, xdb:unlink, xdb:unlink-from
DAV::write-acl	xdb:write-acl-ref, xdb:update-acl
DAV::update	DAV::write-content, DAV::write-properties
xdb:update	DAV::write-properties, DAV::write-content

27.4 ACLs and ACEs

ACLs are used to protect resources, which in the case of Oracle Database are resources (files and folders) in Oracle XML DB Repository. ACLs are composed of ACEs.

An access control list (ACL) is a standard security mechanism that is used in some languages, such as Java, and some operating systems, such as Microsoft Windows. ACLs are also a part of the WebDAV standard.

Repository resources can be accessed using WebDAV, and their protecting ACLs act as WebDAV ACLs. Each repository resource is protected by some ACL. ACLs that protect a resource are enforced no matter how the resource is accessed, whether by WebDAV, SQL, or any other way.

When a new resource is created in Oracle XML DB Repository, by default the ACL on its parent folder is used to protect the resource. After the resource is created, a new ACL can be set on it.

ACLs in Oracle Database are XML documents that are validated against the Oracle Database ACL XML schema, which is located in Oracle XML DB Repository at `/sys/schemas/PUBLIC/xmlns.oracle.com/xdb/acl.xsd`. ACLs are themselves stored and managed as resources in the repository.

Before a principal performs an operation on ACL-protected data, the user privileges for the protected data are checked. The set of privileges checked depends on the operation to be performed.

Aggregate privileges are composed of other privileges. When an ACL is stored, the aggregate privileges it refers to act as sets of pointers to their component privileges.

All ACLs are stored in table `XDB$ACL`, which is owned by database schema (user account) `XDB`. This is an XML schema-based `XMLType` table. Each row in this table (and therefore each ACL) has a system-generated object identifier (**OID**) that can be accessed as a column named `OBJECT_ID`.

Each Oracle XML DB Repository resource has a property named **ACLOID**. The `ACLOID` stores the OID of the ACL that protects the resource. An ACL is itself a resource, and the `XMLRef` property of an ACL, for example, `/sys/acls/all_all_acl.xml`, is a `REF` to the row in table `XDB$ACL` that contains the content of the ACL. These two properties form the link between table `XDB$RESOURCE`, which stores Oracle XML DB resources, and table `XDB$ACL`.

See Also:

- [Oracle-Supplied XML Schemas and Examples](#) (page A-1) for the ACL XML schema
 - *Oracle Database 2 Day + Security Guide* for information about database schema `XDB`
-
-

27.4.1 System ACLs

The system ACLs, which are predefined and supplied with Oracle Database, are described.

Some ACLs are predefined and supplied with Oracle Database. They are referred to as **system ACLs**.

There is only one ACL that is self-protected, that is, protected by its own contents. It is the **bootstrap ACL**, a system ACL that is located in Oracle XML DB Repository at `/sys/acls/bootstrap_acl.xml`. The bootstrap ACL grants `READ` privilege to all users. It also grants `FULL ACCESS` to database roles `XDBADMIN` (the Oracle XML DB administrator) and `DBA`. Database role `XDBADMIN` is particularly useful for users who must register global XML schemas.

Other system ACLs include the following. Each is protected by the bootstrap ACL.

- `all_all_acl.xml` – Grants all privileges to all users.
- `all_owner_acl.xml` – Grants all privileges to the owner of the resource.
- `ro_all_acl.xml` – Grants read privileges to all users.

System ACLs use the file-naming convention `<privilege>_<users>_acl.xml`, where `<privilege>` represents the privilege granted, and `<users>` represents the

users that are granted access to the resource. When you define your own ACLs, you can use any names you like.

See Also:

[Local and Global XML Schemas](#) (page 17-12)

27.4.2 ACL and ACE Evaluation

Privileges are checked before a principal is allowed to access a repository resource that is protected by ACLs. This check is done by evaluating the protecting ACLs for that principal, in order. For each such ACL, the ACEs in it that apply to the principal are examined, in order.

If one ACE grants a certain privilege to the current user and another ACE denies that privilege to the user, then a conflict arises. There are two possible ways to manage conflicts among ACEs for the same principal.

- The default behavior, termed **ace-order**, is to use only the *first* ACE that occurs for a given principal. Additional ACEs for that principal have no effect. In this case, *ACE order is relevant*.
- You can, however, configure the database to use an alternate behavior, **deny-trumps-grant**. In this case, any ACE with child deny for a given principal denies permission to that principal, whether or not there are other ACEs for that principal that have a grant child. In this case, deny always takes precedence over grant, and *ACE order is irrelevant*.

You can configure ACL evaluation behavior by setting configuration parameter **acl-evaluation-method**, in configuration file `xdbconfig.xml`, to either `ace-order` or `deny-trumps-grant`. The default configuration file specifies `ace-method`, but the default value for element `acl-evaluation-method`, used when no method is given, is `deny-trumps-grant`.

Note:

In releases prior to Oracle Database 11g Release 1, only one ACL evaluation behavior was available: `deny-trumps-grant` (though it was not specified in the configuration file).

The change to use `ace-order` as the default behavior has important consequences for upgrading and downgrading between database versions. See [Upgrade or Downgrade of an Existing Oracle XML DB Installation](#) (page 34-1).

27.4.3 ACL Validation

When an ACL is created, it is validated against the XML schema for ACLs, and some correctness tests are run, such as ensuring that start and end dates for ACEs are in chronological order. There is no complete check at ACL creation time of relations among ACLs.

Such a complete check of ACL correctness is called **ACL validity** checking, but it is not to be confused with its XML *schema* validity. For an ACL to be valid (as an ACL), it must also be XML schema-valid, but the converse does not hold.

A full ACL validity check is made at run time, whenever an ACL is evaluated to check whether a principal has the proper privileges for some operation. If this check finds that the ACL is invalid, then all privileges that the ACL would grant are *denied* to the specified principals.

27.4.4 Element `invert`: Complement the Principals in an ACE

It is sometimes more convenient to define a set of principals by complementing another set of principals — that is the purpose of ACE element `invert`. Instead of listing each of the principals that you want to include, wrap the list of principals that you want to exclude with element `invert`.

In [Example 27-3](#) (page 27-10), the first ACE denies privilege `privilege1` to all principals except `IntranetUsers`. Because (by default) ACEs are considered in the order they appear, all subsequent ACEs are overridden by the first ACE, so principal `NonIntraNetUser` is denied privilege `privilege1` in spite of the explicit grant.

Example 27-3 Complementing a Set of Principals with Element `invert`

```
<acl description="invert ACL"
  xmlns="http://xmlns.oracle.com/xdb/acl.xsd"
  xmlns:dav="DAV:"
  xmlns:xsi="http://www.w3.org/2001/XMLSchema-instance"
  xsi:schemaLocation="http://xmlns.oracle.com/xdb/acl.xsd
    http://xmlns.oracle.com/xdb/acl.xsd">
<extends-from type="simple" href="/sys/acls/parent_acl.xml"/>
<ace>
  <grant>false</grant>
  <invert><principal>dav:owner</principal></invert>
  <privilege><read-contents/></privilege>
</ace>
<ace>
  <grant>true</grant>
  <principal>GERONIMO</principal>
  <privilege><read-contents/></privilege>
</ace>
</acl>
```

27.5 Overview of Working with Access Control Lists (ACLs)

Oracle Database access control lists (ACLs) are themselves (file) resources in Oracle XML DB Repository, so all of the access methods that operate on repository resources also apply to ACLs. In addition, there are several APIs specific to ACLs in PL/SQL package `DBMS_XDB_REPOS`.

Those ACL procedures and functions let you use PL/SQL to access Oracle XML DB security mechanisms, check user privileges based on a particular ACL, and list the set of privileges the current user has for a particular ACL and resource.

See Also:

[Administration of Oracle XML DB](#) (page 34-1)

27.5.1 Creating an ACL Using `DBMS_XDB_REPOS.CREATERESOURCE`

An example illustrates using `DBMS_XDB_REPOS.createResource` to create an ACL.

[Example 27-4](#) (page 27-11) creates an ACL as file resource `/TESTUSER/ac11.xml`. If applied to a resource, this ACL grants all privileges to the owner of the resource.

Note:

Before performing any operation that uses an ACL file resource that was created during the current transaction, you must perform a COMMIT operation. Until you do that, an ORA-22881 "dangling REF" error is raised whenever you use the ACL file.

Example 27-4 Creating an ACL Using CREATERESOURCE

```
DECLARE
  b BOOLEAN;
BEGIN
  b := DBMS_XDB_REPOS.createFolder('/TESTUSER');
  b := DBMS_XDB_REPOS.createResource(
    '/TESTUSER/ac11.xml',
    '<acl description="myacl"
      xmlns="http://xmlns.oracle.com/xdb/acl.xsd"
      xmlns:dav="DAV:"
      xmlns:xsi="http://www.w3.org/2001/XMLSchema-instance"
      xsi:schemaLocation="http://xmlns.oracle.com/xdb/acl.xsd
        http://xmlns.oracle.com/xdb/acl.xsd">
      <ace>
        <grant>true</grant>
        <principal>dav:owner</principal>
        <privilege>
          < dav:all />
        </privilege>
      </ace>
    </acl>',
    'http://xmlns.oracle.com/xdb/acl.xsd',
    'acl');
END;
```

27.5.2 Retrieving an ACL Document, Given its Repository Path

An example shows how to retrieve an ACL document, given its location in Oracle XML DB Repository.

Example 27-5 Retrieving an ACL Document, Given its Repository Path

```
SELECT a.OBJECT_VALUE FROM RESOURCE_VIEW rv, XDB.XDB$ACL a
  WHERE ref(a)
        = XMLCast(XMLQuery('declare default element namespace
          "http://xmlns.oracle.com/xdb/XDBResource.xsd"; (: :)
          fn:data(/Resource/XMLRef)'
          PASSING rv.RES RETURNING CONTENT)
        AS REF XMLType)
  AND equals_path(rv.RES, '/TESTUSER/ac11.xml') = 1;

OBJECT_VALUE
-----
<acl description="myacl" xmlns="http://xmlns.oracle.com/xdb/acl.xsd" xmlns:dav="
DAV:" xmlns:xsi="http://www.w3.org/2001/XMLSchema-instance" xsi:schemaLocation="
http://xmlns.oracle.com/xdb/acl.xsd http://xm
lns.oracle.com/xdb/acl.xsd" shared="true">
<ace>
```

```
<grant>true</grant>
<principal>dav:owner</principal>
<privilege>
  <dav:all/>
</privilege>
</ace>
</acl>
```

27.5.3 Setting the ACL of a Resource

An example uses PL/SQL procedure `DBMS_XDB_REPOS.setACL` to set the ACL of a resource.

[Example 27-6](#) (page 27-12) creates resource `/TESTUSER/po1.xml` and sets its ACL to `/TESTUSER/ac11.xml` using PL/SQL procedure `DBMS_XDB_REPOS.setACL`.

Example 27-6 Setting the ACL of a Resource

```
DECLARE
  b BOOLEAN;
BEGIN
  b := DBMS_XDB_REPOS_REPOS.createResource('/TESTUSER/po1.xml', 'Hello');
END;
/

CALL DBMS_XDB_REPOS_REPOS.setACL('/TESTUSER/po1.xml', '/TESTUSER/ac11.xml');
```

27.5.4 Deleting an ACL

An example uses PL/SQL procedure `DBMS_XDB_REPOS.deleteResource` to delete an ACL.

[Example 27-7](#) (page 27-12) deletes the ACL created in [Example 27-4](#) (page 27-11).

If a resource is being protected by an ACL that you want to delete, change the ACL of that resource before deleting the ACL.

Example 27-7 Deleting an ACL

```
CALL DBMS_XDB_REPOS_REPOS.deleteResource('/TESTUSER/ac11.xml');
```

27.5.5 Updating an ACL

You can update an ACL using any of the standard ways of updating resources. In particular, since an ACL is an XML document, you can use Oracle SQL/XML function `XMLQuery` with XQuery Update to manipulate ACLs. You must `COMMIT` after making any ACL changes.

Oracle XML DB ACLs are *cached*, for fast evaluation. When a transaction that updates an ACL is committed, the modified ACL is picked up by existing database sessions, after the timeout specified in the Oracle XML DB configuration file, `xdbconfig.xml`. The XPath location for this timeout parameter is `/xdbconfig/sysconfig/acl-max-age`. The value is expressed in seconds. Sessions initiated after the ACL is modified use the new ACL without any delay.

If an ACL resource is updated with non-ACL content, the same rules apply as for deletion. Thus, if any resource is being protected by an ACL that is being updated, you must first change the ACL.

See Also:

[Updating XML Data](#) (page 5-27) for information about the Oracle SQL functions used here to update XML data

You can use FTP or WebDAV to update an ACL. For more details on how to use these protocols, see [Repository Access Using Protocols](#) (page 28-1). You can update an ACL or an access control entry (ACE) using RESOURCE_VIEW.

Example 27-8 (page 27-13) uses SQL/XML function XMLQuery together with XQuery Update to update the ACL /TESTUSER/ac11.xml by replacing it entirely. The effect is to replace the principal value DAV::owner by TESTUSER, because the rest of the replacement ACL is the same as it was before.

Example 27-9 (page 27-13) uses XQuery Update to append an ACE to an existing ACL. The ACE gives privileges read-properties and read-contents to user HR.

Example 27-10 (page 27-14) uses Oracle SQL function deleteXML to delete an ACE from an ACL. The first ACE is deleted.

Example 27-8 Updating (Replacing) an Access Control List

```
UPDATE RESOURCE_VIEW r
SET r.RES =
XMLQuery(
'declare namespace r="http://xmlns.oracle.com/xdb/XDBResource.xsd"; (: :)
declare namespace a="http://xmlns.oracle.com/xdb/acl.xsd"; (: :)
copy $i := $p1 modify
(for $j in $i/r:Resource/r:Contents/a:acl
return replace node $j with $p2)
return $i'
PASSING r.RES AS "p1",
'<acl description="myacl"
xmlns="http://xmlns.oracle.com/xdb/acl.xsd"
xmlns:dav="DAV:"
xmlns:xsi="http://www.w3.org/2001/XMLSchema-instance"
xsi:schemaLocation="http://xmlns.oracle.com/xdb/acl.xsd
http://xmlns.oracle.com/xdb/acl.xsd">
<ace>
<grant>true</grant>
<principal>TESTUSER</principal>
<privilege><dav:all/></privilege>
</ace>
</acl>' AS "p2"
RETURNING CONTENT)
WHERE equals_path(r.RES, '/TESTUSER/ac11.xml') = 1;
```

Example 27-9 Appending ACEs to an Access Control List

```
UPDATE RESOURCE_VIEW r
SET r.RES =
XMLQuery('declare namespace r="http://xmlns.oracle.com/xdb/XDBResource.xsd"; (: :)
declare namespace a="http://xmlns.oracle.com/xdb/acl.xsd"; (: :)
copy $i := $p1 modify
(for $j in $i/r:Resource/r:Contents/a:acl
return insert nodes $p2 as last into $j)
return $i'
PASSING r.RES AS "p1",
XMLType('<ace xmlns="http://xmlns.oracle.com/xdb/acl.xsd">
<grant>true</grant>
```

```

                <principal>HR</principal>
                <privilege>
                    <read-properties/>
                    <read-contents/>
                </privilege>
            </ace>') as "p2"
        RETURNING CONTENT)
WHERE equals_path(r.RES, '/TESTUSER/ac11.xml') = 1;

```

Example 27-10 Deleting an ACE from an Access Control List

```

UPDATE RESOURCE_VIEW r
SET r.RES =
    XMLQuery('declare namespace r="http://xmlns.oracle.com/xdb/XDBResource.xsd"; (: :)
        declare namespace a="http://xmlns.oracle.com/xdb/acl.xsd"; (: :)
        copy $i := $p modify delete nodes $i/r:Resource/r:Contents/a:acl/a:ace[1]
        return $i'
        PASSING r.RES AS "p" RETURNING CONTENT)
WHERE equals_path(r.RES, '/TESTUSER/ac11.xml') = 1;

```

27.5.6 Retrieving the ACL Document that Protects a Given Resource

An example illustrates how to use PL/SQL function `DBMS_XDB_REPOS.getACLDocument` to retrieve the ACL document that protects a given resource.

See Also:

[Example 26-2](#) (page 26-4)

Example 27-11 Retrieving the ACL Document for a Resource

```

SELECT XMLSerialize(DOCUMENT DBMS_XDB_REPOS.getACLDocument('/TESTUSER/po1.xml')
                    AS CLOB)
FROM DUAL;

XMLSERIALIZE(DOCUMENTDBMS_XDB_REPOS.GETACLDOCUMENT('/TESTUSER/PO1.XML')ASCLOB)
-----
<acl description="myacl" xmlns="http://xmlns.oracle.com/xdb/acl.xsd" xmlns:dav="
DAV:" xmlns:xsi="http://www.w3.org/2001/XMLSchema-instance" xsi:schemaLocation="
http://xmlns.oracle.com/xdb/acl.xsd http://x
mlns.oracle.com/xdb/acl.xsd">
  <ace>
    <grant>true</grant>
    <principal>TESTUSER</principal>
    <privilege>
      <dav:all/>
    </privilege>
  </ace>
  <ace xmlns="http://xmlns.oracle.com/xdb/acl.xsd">
    <grant>true</grant>
    <principal>HR</principal>
    <privilege>
      <read-properties/>
      <read-contents/>
    </privilege>
  </ace>
</acl>

```

1 row selected.

27.5.7 Retrieving Privileges Granted to the Current User for a Particular Resource

An example illustrates how to use PL/SQL function

`DBMS_XDB_REPOS.getPrivileges` to retrieve privileges granted to the current user.

Example 27-12 Retrieving Privileges Granted to the Current User for a Particular Resource

```
SELECT XMLSerialize(DOCUMENT DBMS_XDB_REPOS.getPrivileges('/TESTUSER/po1.xml')
                   AS CLOB)
FROM DUAL;
```

```
XMLSERIALIZE(DOCUMENTDBMS_XDB_REPOS.GETPRIVILEGES('/TESTUSER/PO1.XML')ASCLOB)
```

```
-----
<privilege xmlns="http://xmlns.oracle.com/xdb/acl.xsd" xmlns:xsi="http://www.w3.
org/2001/XMLSchema-instance" xsi:schemaLocation="http://xmlns.oracle.com/xdb/acl
.xsd http://xmlns.oracle.com/xdb/acl.xsd DAV: http://xmlns.oracle.com/xdb/dav.xs
d" xmlns:xdbacl="http://xmlns.oracle.com/xdb/acl.xsd" xmlns:dav="DAV: ">
  <read-acl/>
  <dav:execute/>
  <read-contents/>
  <update-acl/>
  <dav:write-content/>
  <dav:read-current-user-privilege-set/>
  <link-to/>
  <resolve/>
  <dav:lock/>
  <unlink-from/>
  <write-config/>
  <dav:write-properties/>
  <dav:unlock/>
  <link/>
  <write-acl-ref/>
  <read-properties/>
  <dav:take-ownership/>
  <unlink/>
</privilege>
```

1 row selected.

27.5.8 Checking Whether the Current User Has Privileges on a Resource

An example illustrates how to use PL/SQL function

`DBMS_XDB_REPOS.checkPrivileges` to check whether the current user has a given set of privileges on a resource. The function returns a nonzero value if the user has the privileges.

[Example 27-13](#) (page 27-15) checks to see if the access privileges `read-contents` and `read-properties` have been granted to the current user on resource `/TESTUSER/po1.xml`. The positive-integer return value shows that they have.

Example 27-13 Checking If a User Has a Certain Privileges on a Resource

```
SELECT DBMS_XDB_REPOS.checkPrivileges(
        '/TESTUSER/po1.xml',
        XMLType('<privilege
```

```

        xmlns="http://xmlns.oracle.com/xdb/acl.xsd"
        xmlns:dav="DAV:"
        xmlns:xsi="http://www.w3.org/2001/XMLSchema-instance"
        xsi:schemaLocation="http://xmlns.oracle.com/xdb/acl.xsd
                           http://xmlns.oracle.com/xdb/acl.xsd">
        <read-contents/>
        <read-properties/>
    </privilege>'))
FROM DUAL;

DBMS_XDB_REPOS.CHECKPRIVILEGES('/TESTUSER/PO1.XML',
-----
                                     1

1 row selected.
```

27.5.9 Checking Whether a User Has Privileges Using the ACL and Resource Owner

Function `DBMS_XDB_REPOS.ACLCheckPrivileges` is typically used by applications that must perform ACL evaluation on their own, before allowing a user to perform an operation.

Example 27-14 (page 27-16) checks whether the ACL `/TESTUSER/acl1.xml` grants the privileges `read-contents` and `read-properties` to the current user, `sh`. The second argument, `TESTUSER`, is the user that is substituted for `DAV::owner` in the ACL when checking. Since user `sh` does *not* match any of the users granted the specified privileges, the return value is zero.

Example 27-14 Checking User Privileges Using `ACLCheckPrivileges`

```

CONNECT sh
Enter password: <password>

Connected.

SELECT DBMS_XDB_REPOS.ACLCheckPrivileges(
        '/TESTUSER/acl1.xml',
        'TESTUSER',
        XMLType('<privilege
                xmlns="http://xmlns.oracle.com/xdb/acl.xsd"
                xmlns:dav="DAV:"
                xmlns:xsi="http://www.w3.org/2001/XMLSchema-instance"
                xsi:schemaLocation="http://xmlns.oracle.com/xdb/acl.xsd
                                   http://xmlns.oracle.com/xdb/acl.xsd">
                <read-contents/>
                <read-properties/>
            </privilege>'))
FROM DUAL;

DBMS_XDB_REPOS.ACLCHECKPRIVILEGES('/TESTUSER/ACL1.XML', 'TESTUSER',
-----
                                     0

1 row selected.
```

27.5.10 Retrieving the Path of the ACL that Protects a Given Resource

An example uses a `RESOURCE_VIEW` query to retrieve the path of the ACL that protects a given resource. The query uses the fact that the `XMLRef` and `ACLOID` elements of a resource form the link between an ACL and a resource.

[Example 27-15](#) (page 27-17) retrieves the path to an ACL, given a resource protected by the ACL. The ACLOID of a protected resource (r) stores the OID of the ACL resource (a) that protects it. The REF of the ACL resource is the same as that of the object identified by the protected-resource ACLOID.

The REF of the resource ACLOID can be obtained using Oracle SQL function `make_ref`, which returns a REF to an object-table row with a given OID.

In [Example 27-15](#) (page 27-17), `make_ref` returns a REF to the row of table `XDB$ACL` whose OID is the `/Resource/ACLOID` for the resource `/TESTUSER/pol.xml`. The inner query returns the ACLOID of the resource. The outer query returns the path to the corresponding ACL.

Example 27-15 Retrieving the Path of the ACL that Protects a Given Resource

```
SELECT rv1.ANY_PATH
FROM RESOURCE_VIEW rv1
WHERE
  XMLCast(XMLQuery('declare default element namespace
                    "http://xmlns.oracle.com/xdb/XDBResource.xsd"; (: :)
                    fn:data(/Resource/XMLRef)')
          PASSING rv1.RES RETURNING CONTENT)
  AS REF XMLType)
= make_ref(XDB.XDB$ACL,
  (SELECT XMLCast(XMLQuery('declare default element namespace
                            "http://xmlns.oracle.com/xdb/XDBResource.xsd"; (: :)
                            fn:data(/Resource/ACLOID)')
              PASSING rv2.RES RETURNING CONTENT)
      AS REF XMLType)
  FROM RESOURCE_VIEW rv2
  WHERE equals_path(rv2.RES, '/TESTUSER/pol.xml') = 1));

ANY_PATH
-----
/TESTUSER/ac11.xml
```

27.5.11 Retrieving the Paths of All Resources Protected by a Given ACL

An example retrieves the paths of all resources protected by a given ACL.

[Example 27-16](#) (page 27-17) retrieves the paths to the resources whose ACLOID REF matches the REF of the ACL resource whose path is `/TESTUSER/ac11.xml`. Function `make_ref` returns the resource ACLOID REF.

The inner query retrieves the REF of the specified ACL. The outer query selects the paths of the resources whose ACLOID REF matches the REF of the specified ACL.

Example 27-16 Retrieving the Paths of All Resources Protected by a Given ACL

```
SELECT rv1.ANY_PATH
FROM RESOURCE_VIEW rv1
WHERE make_ref(XDB.XDB$ACL,
  XMLCast(XMLQuery('declare default element namespace
                    "http://xmlns.oracle.com/xdb/XDBResource.xsd"; (: :)
                    fn:data(/Resource/ACLOID)')
          PASSING rv1.RES RETURNING CONTENT)
  AS REF XMLType))
= (SELECT XMLCast(XMLQuery('declare default element namespace
                            "http://xmlns.oracle.com/xdb/XDBResource.xsd"; (: :)
                            fn:data(/Resource/XMLRef)')
              PASSING rv2.RES RETURNING CONTENT)
      AS REF XMLType)
```

```
FROM RESOURCE_VIEW rv2
WHERE equals_path(rv2.RES, '/TESTUSER/ac11.xml') = 1);
```

```
ANY_PATH
```

```
-----
/TESTUSER/po1.xml
```

```
1 row selected.
```

27.6 ACL Caching

Since ACLs are checked for each access to the data they protect, the performance of the ACL check operation is critical to the performance of such data, including Oracle XML DB Repository resources. In Oracle XML DB, the required performance for this repository operation is achieved by employing several caches.

ACLs are saved in a cache that is shared by all sessions in the database instance. When an ACL is updated, its entry in the cache is invalidated, together with all objects dependent on it. The next time the ACL is used, a new copy of it is brought into the cache. Oracle recommends that you share ACLs among resources as much as possible.

There is a session-specific cache of privileges granted to a given user by a given ACL. The entries in this cache have a time out (in seconds) specified by the element `<acl-max-age>` in the Oracle XML DB configuration file (`xdbconfig.xml`). For maximum performance, set this timeout as large as possible. But there is a trade-off here: the greater the timeout, the longer it takes for current sessions to pick up an updated ACL.

Oracle XML DB also maintains caches to improve performance when using ACLs that have LDAP principals (LDAP groups or users). The goal of these caches is to minimize network communication with the LDAP server. One is a shared cache that maps LDAP GUIDs to the corresponding LDAP nicknames and Distinguished Names (DNs). This is used when an ACL document is being displayed (or converted to CLOB or VARCHAR2 values from an XMLType instance). To purge this cache, use procedure `DBMS_XDBZ.purgeLDAPCache`. The other cache is session-specific and maps LDAP groups to their members (nested membership). Whenever Oracle XML DB encounters an LDAP group for the first time (in a session) it gets the nested membership of that group from the LDAP server. Hence it is best to use groups with as few members and levels of nesting as possible.

27.7 Repository Resources and Database Table Security

A uniform security mechanism for accessing REF-based repository resources is provided by enabling hierarchy on the tables used to store them. When ACL-based security is not needed for particular resources, you can optimize their access by using PL/SQL procedure `DBMS_XDBZ.disable_hierarchy` to turn off ACL checking.

Resources in Oracle XML DB Repository are of two types:

- LOB-based (the content is stored in a LOB which is part of the resource). Access is determined only by the ACL that protects the resource.
- REF-based (the content is XML data and is stored in a database table). Users must have the appropriate privilege for the underlying table or view where the XML content is stored in addition to ACL permissions for the resource.

Since the content of a REF-based resource can be stored in a table, it is possible to access this data directly using SQL queries on the table. A **uniform** access control mechanism is one where the privileges needed for access are independent of the method of access (for example, FTP, HTTP, or SQL). To provide a uniform security

mechanism using ACLs, the underlying table must first be **hierarchy-enabled**, before resources that reference the rows in the table are inserted into Oracle XML DB.

The default tables produced by XML schema registration are hierarchy-enabled. Enabling hierarchy is the default behavior when you register an XML schema with Oracle XML DB. You can also enable hierarchy after registration, using procedure `DBMS_XDBZ.enable_hierarchy`.

Enabling hierarchy on a resource table does the following:

- Adds two hidden columns to store the `ACLOID` and the `OWNER` of the resources that reference the rows in the table.
- Adds a row-level security (RLS) policy to the table, which checks the ACL whenever a `SELECT`, `UPDATE`, or `DELETE` operation is executed on the table.
- Creates a database trigger, called the **path-index trigger**, that ensures that the last-modified information for a resource is updated whenever the corresponding row is updated in the `XMLType` table where the content is stored.

See Also:

- *Oracle Database PL/SQL Packages and Types Reference* for information about procedure `DBMS_XMLSCHEMA.registerSchema`
 - *Oracle Database PL/SQL Packages and Types Reference* for information about procedure `DBMS_XDBZ.enable_hierarchy`
-
-

In any given table, it is possible that only some of the objects are mapped to Oracle XML DB resources. Only those objects that are mapped undergo ACL checking, but *all* of the objects have table-level security.

Note:

You cannot hide data in `XMLType` tables from other users if *out-of-line* storage of is used. Out-of-line data is *not* protected by ACL security.

27.7.1 Optimization: Do not enforce ACL-based security if you do not need it

ACL-based security provides control of access to XML content document-by-document, rather than just table-by-table. When you call PL/SQL procedure `DBMS_XMLSCHEMA.register_chema`, the tables it creates have ACL-based security enabled, by default.

One effect of this is that when the XML content of such a table is accessed using a SQL statement, a call to `sys_checkACL` is automatically added to the query `WHERE` clause, to ensure that the ACL security that was defined is enforced at the SQL level.

Enforcing ACL-based security adds overhead to the SQL query, however. If ACL-based security is *not* required, then use procedure `DBMS_XDBZ.disable_hierarchy` to turn *off* ACL checking.

When ACL-based security is enabled for an `XMLType` table, the execution plan output for a query of that table contains a filter similar to the following:

```
3 - filter(SYS_CHECKACL("ACLOID", "OWNERID", xmltype(' '<privilege
      xmlns="http://xmlns.oracle.com/xdb/acl.xsd"
      xmlns:xsi="http://www.w3.org/2001/XMLSchema-instance"
      xsi:schemaLocation="http://xmlns.oracle.com/xdb/acl.xsd
      http://xmlns.oracle.com/xdb/acl.xsd
      DAV:http://xmlns.oracle.com/xdb/dav.xsd">
      <read-properties/><read-contents/></privilege>'))=1)
```

In this example, the filter checks that the user performing the SQL query has `read-contents` privilege on each of the documents to be accessed.

After calling `DBMS_XDBZ.disable_hierarchy`, an execution plan of the same query does not show `SYS_CHECKACL` in the filter.

See Also:

Oracle Database PL/SQL Packages and Types Reference for information about procedure `DBMS_XDBZ.disable_hierarchy`

27.8 Integration Of Oracle XML DB with LDAP

You can allow Lightweight Directory Access Protocol (LDAP) users to use the features of Oracle XML DB, including ACLs.

The typical scenario is a single, shared database schema (user), to which multiple LDAP users are mapped. This mapping is maintained in the Oracle Internet Directory. End users can log into the database using their LDAP user name and password. They are then automatically mapped to the corresponding shared database schema. (Users can log in using SQL or any of the supported Oracle XML DB protocols.) The implicit ACL resolution is based on the current LDAP user and the corresponding LDAP group membership information.

Before you can use LDAP users and groups (also known as LDAP roles) as principals in Oracle XML DB ACLs, the following prerequisites must be satisfied:

- An Oracle Internet Directory must be set up, and the database must be registered with it.
- SSL authentication must be set up between the database and the Oracle Internet Directory.
- A database user must be created that corresponds to the shared database schema.
- The LDAP users must be created and mapped in the Oracle Internet Directory to the shared database schema.
- The LDAP groups must be created and their members must be specified.
- ACLs must be defined for the LDAP groups and users, and they must be used to protect the repository resources to be accessed by the LDAP users.

See Also:

- *Fusion Middleware Administering Oracle Internet Directory*
- *Oracle Database Security Guide* for information about setting up SSL authentication
- *Oracle Database Enterprise User Security Administrator's Guide* for information about using shared database schemas for enterprise (LDAP) users

[Example 27-17](#) (page 27-21) shows an ACL for an LDAP user. Element `<principal>` contains the full *distinguished name* of the LDAP user – in this case, `cn=user1,ou=Americas,o=oracle,l=redwoodshores,st=CA,c=US`.

[Example 27-18](#) (page 27-21) shows an ACL for an LDAP group. Element `<principal>` contains the full distinguished name of the LDAP group.

Example 27-17 ACL Referencing an LDAP User

```
<acl description="/public/txmlacl1/acl1.xml"
  xmlns="http://xmlns.oracle.com/xdb/acl.xsd" xmlns:dav="DAV:"
  xmlns:xsi="http://www.w3.org/2001/XMLSchema-instance"
  xsi:schemaLocation="http://xmlns.oracle.com/xdb/acl.xsd
    http://xmlns.oracle.com/xdb/acl.xsd">
  <ace principalFormat="DistinguishedName">
    <grant>true</grant>
    <principal>cn=user1,ou=Americas,o=oracle,l=redwoodshores,st=CA,c=US
  </principal>
    <privilege>
      <dav:all/>
    </privilege>
  </ace>
</acl>
```

Example 27-18 ACL Referencing an LDAP Group

```
<acl xmlns="http://xmlns.oracle.com/xdb/acl.xsd" xmlns:dav="DAV:"
  xmlns:xsi="http://www.w3.org/2001/XMLSchema-instance"
  xsi:schemaLocation="http://xmlns.oracle.com/xdb/acl.xsd
    http://xmlns.oracle.com/xdb/acl.xsd">
  <ace principalFormat="DistinguishedName">
    <grant>true</grant>
    <principal>cn=grp1,ou=Americas,o=oracle,l=redwoodshores,st=CA,c=US</principal>
    <privilege>
      <dav:read/>
    </privilege>
  </ace>
</acl>
```

Repository Access Using Protocols

You can access Oracle XML DB Repository data using protocols FTP and HTTP(S)/WebDAV.

- [Overview of Oracle XML DB Protocol Server](#) (page 28-1)
- [Oracle XML DB Protocol Server Configuration Management](#) (page 28-2)
- [FTP and the Oracle XML DB Protocol Server](#) (page 28-12)
- [HTTP\(S\) and Oracle XML DB Protocol Server](#) (page 28-20)
- [WebDAV and Oracle XML DB](#) (page 28-26)

28.1 Overview of Oracle XML DB Protocol Server

Oracle XML DB also provides the Oracle XML DB *protocol server*. This supports standard Internet protocols, FTP, WebDAV, and HTTP(S), for accessing its hierarchical repository or file system. HTTPS provides *secure* access to Oracle XML DB Repository.

These protocols can provide direct access to Oracle XML DB for many users without having to install additional software. The user names and passwords to be used with the protocols are the same as those for SQL*Plus. Enterprise users are also supported. Database administrators can use these protocols and resource APIs such as DBMS_XDB_REPOS to access Oracle Automatic Storage Management (Oracle ASM) files and folders in the repository virtual folder `/sys/asm`.

As described in [Getting Started with Oracle XML DB](#) (page 2-1) and [Access to Oracle XML DB Repository Data](#) (page 21-1), Oracle XML DB Repository provides a hierarchical data repository in the database, designed for XML. Oracle XML DB Repository maps path names (or URLs) onto database objects of XMLType and provides management facilities for these objects.

See Also:

[Access to Oracle XML DB Repository Data](#) (page 21-1) for more information about accessing repository information, and restrictions on that access

Note:

- When accessing virtual folder `/sys/asm` using Oracle XML DB protocols, you must log in with the privileges of role DBA but as a user other than SYS.
 - Oracle XML DB protocols are *not* supported on EBCDIC platforms.
-

28.1.1 Session Pooling

Oracle XML DB protocol server maintains a shared pool of sessions. Each protocol connection is associated with one session from this pool. After a connection is closed the session is put back into the shared pool and can be used to serve later connections.

Session pooling improves performance of HTTP(S) by avoiding the cost of re-creating session states, especially when using HTTP 1.0, which creates new connections for each request. For example, a couple of small files can be retrieved by an existing HTTP/1.1 connection in the time necessary to create a database session. You can tune the number of sessions in the pool by setting `session-pool-size` in the Oracle XML DB configuration file, `xdbconfig.xml`, or disable it by setting pool size to zero.

Session pooling can affect users writing *Java servlets*, because other users can see session state initialized by another request for a different user. Hence, servlet writers should only use session memory, such as Java static variables, to hold data for the entire application rather than for a particular user. State for each user must be stored in the database or in a lookup table, rather than assuming that a session only exists for a single user.

See Also:

[Guidelines for Oracle XML DB Applications in Java](#) (page 31-1)

[Figure 28-1](#) (page 28-2) illustrates the Oracle XML DB protocol server components and how they are used to access files in Oracle XML DB Repository and other data. Only the relevant components of the repository are shown

Figure 28-1 Oracle XML DB Architecture: Protocol Server

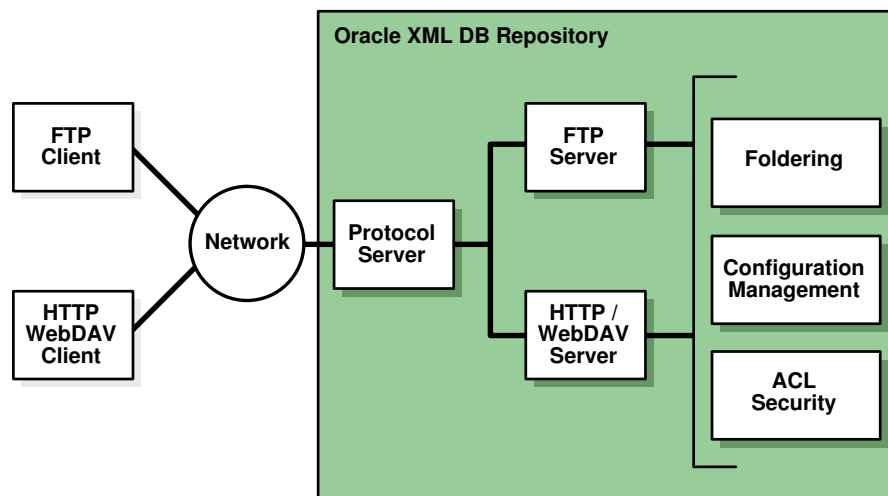

28.2 Oracle XML DB Protocol Server Configuration Management

Oracle XML DB protocol server uses configuration parameters stored in file `xdbconfig.xml` to initialize its startup state and manage session level configuration. The session pool size and timeout parameters cannot be changed dynamically, that is, you must restart the database in order for these changes to take effect.

See Also:

[Configuration of Oracle XML DB Using xdbconfig.xml](#) (page 34-5)

28.2.1 Protocol Server Configuration Parameters

The Oracle XML DB protocol configuration parameters are described. They include those common to all protocols, those specific to FTP, and those specific to HTTP(S)/WebDAV.

[Table 28-1](#) (page 28-3) shows the parameters common to all protocols. All of their parameter names, except those starting with `/xdbconfig`, are relative to the following XPath in the Oracle XML DB configuration schema:

```
/xdbconfig/sysconfig/protocolconfig/common
```

- *FTP-specific parameters* – [Table 28-2](#) (page 28-5) shows the FTP-specific parameters. These are relative to the following XPath in the Oracle XML DB configuration schema:

```
/xdbconfig/sysconfig/protocolconfig/ftpconfig
```

- *HTTP(S)/WebDAV specific parameters, except servlet-related parameters* – [Table 28-3](#) (page 28-5) shows the HTTP(S)/WebDAV-specific parameters. These parameters are relative to the following XPath in the Oracle XML DB configuration schema:

```
/xdbconfig/sysconfig/protocolconfig/httpconfig
```

See Also:

- [Administration of Oracle XML DB](#) (page 34-1) for more information about the configuration file `xdbconfig.xml`
- [xdbconfig.xsd: XML Schema for Configuring Oracle XML DB](#) (page A-16)
- [Configuration of Mappings from Default Namespace to Schema Location](#) (page 34-11) for more information about the `schemaLocation-mappings` parameter
- [Configuration of XML File Extensions](#) (page 34-13) for more information about the `xml-extensions` parameter

For examples of the usage of these parameters, see the configuration file, `xdbconfig.xml`.

Table 28-1 Common Protocol Configuration Parameters

Parameter	Description
<code>extension-mappings/mime-mappings</code>	Specifies the mapping of file extensions to mime types. When a resource is stored in Oracle XML DB Repository, and its mime type is not specified, this list of mappings is used to set its mime type.

Table 28-1 (Cont.) Common Protocol Configuration Parameters

Parameter	Description
<code>extension-mappings/lang-mappings</code>	Specifies the mapping of file extensions to languages. When a resource is stored in Oracle XML DB Repository, and its language is not specified, this list of mappings is used to set its language.
<code>extension-mappings/encoding-mappings</code>	Specifies the mapping of file extensions to encodings. When a resource is stored in Oracle XML DB Repository, and its encoding is not specified, this list of mappings is used to set its encoding.
<code>xml-extensions</code>	Specifies the list of filename extensions that are treated as XML content by Oracle XML DB.
<code>session-pool-size</code>	Maximum number of sessions that are kept in the protocol server session pool
<code>/xdbconfig/sysconfig/call-timeout</code>	If a connection is idle for this time (in hundredths of a second), then the shared server serving the connection is freed up to serve other connections.
<code>session-timeout</code>	Time (in hundredths of a second) after which a session (and consequently the corresponding connection) is terminated by the protocol server if the connection has been idle for that time. This parameter is used only if the specific protocol session timeout is not present in the configuration
<code>schemaLocation-mappings</code>	Specifies the default schema location for a given namespace. This is used if the instance XML document does not contain an explicit <code>xsi:schemaLocation</code> attribute.
<code>/xdbconfig/sysconfig/default-lock-timeout</code>	Time period after which a WebDAV lock on a resource becomes invalid. This could be overridden by a Timeout specified by the client that locks the resource.

Table 28-2 Configuration Parameters Specific to FTP

Parameter	Description
<code>buffer-size</code>	Size of the buffer, in bytes, used to read data from the network during an FTP <code>put</code> operation. Set <code>buffer-size</code> to larger values for higher <code>put</code> performance. There is a trade-off between <code>put</code> performance and memory usage. The value can be from 1024 to 1048496, inclusive. The default value is 8192.
<code>ftp-port</code>	Port on which FTP server listens. By default, this is 0, which means that FTP is <i>disabled</i> . FTP is disabled by default because the FTP specification requires that passwords be transmitted in clear text, which can present a security hazard. To enable FTP, set this parameter to the FTP port to use, such as 2100.
<code>ftp-protocol</code>	Protocol over which the FTP server runs. By default, this is <code>tcp</code> .
<code>ftp-welcome-message</code>	A user-defined welcome message that is displayed whenever an FTP client connects to the server. If this parameter is empty or missing, then the following default welcome message is displayed: "Unauthorized use of this FTP server is prohibited and may be subject to civil and criminal prosecution."
<code>host-name</code>	Name used to access the host system. The value can be an IP address or a name that is mapped to an IP address using <i>host naming</i> (e.g., in file <code>/etc/hosts</code> on Linux) — see <i>Oracle Database Net Services Reference</i> . By default, the IP address returned by the operating system is used.
<code>session-timeout</code>	Time (in hundredths of a second) after which an FTP connection is terminated by the protocol server if the connection has been idle for that time.

Table 28-3 Configuration Parameters Specific to HTTP(S)/WebDAV (Except Servlet)

Parameter	Description
<code>http-port</code>	Port on which the HTTP(S)/WebDAV server listens, using protocol <code>http-protocol</code> . By default, this is 0, which means that HTTP is <i>disabled</i> . If this parameter is empty (<code><http-port /></code>), then the default value of 0 applies. An empty parameter is <i>not</i> recommended. This parameter <i>must</i> be present, whether or not it is empty. Otherwise, validation of <code>xdbconfig.xml</code> against XML schema <code>xdbconfig.xsd</code> fails. The value must be different from the value of <code>http2-port</code> . Otherwise, an error is raised.

Table 28-3 (Cont.) Configuration Parameters Specific to HTTP(S)/WebDAV (Except Servlet)

Parameter	Description
<code>http2-port</code>	<p>Port on which the HTTP(S)/WebDAV server listens, using protocol <code>http2-protocol</code>.</p> <p>This parameter is <i>optional</i>, but, if present, then <code>http2-protocol</code> must also be present. Otherwise, an error is raised. The value must be different from the value of <code>http-port</code>. Otherwise, an error is raised. An empty parameter (<code><http2-port/></code>) also raises an error.</p>
<code>http-protocol</code>	<p>Protocol over which the HTTP(S)/WebDAV server runs on port <code>http-port</code>. Must be either TCP or TCPS.</p> <p>This parameter <i>must</i> be present. Otherwise, validation of <code>xdbconfig.xml</code> against XML schema <code>xdbconfig.xsd</code> fails. An empty parameter (<code><http-protocol/></code>) also raises an error.</p>
<code>http2-protocol</code>	<p>Protocol over which the HTTP(S)/WebDAV server runs on port <code>http2-port</code>. Must be either TCP or TCPS. If this parameter is empty (<code><http2-protocol/></code>), then the default value of TCP applies. (An empty parameter is <i>not</i> recommended.)</p> <p>This parameter is <i>optional</i>, but, if present, then <code>http2-port</code> must also be present. Otherwise, an error is raised.</p>
<code>session-timeout</code>	<p>Time (in hundredths of a second) after which an HTTP(S) session (and consequently the corresponding connection) is terminated by the protocol server if the connection has been idle for that time.</p>
<code>max-header-size</code>	<p>Maximum size (in bytes) of an HTTP(S) header</p>
<code>max-request-body</code>	<p>Maximum size (in bytes) of an HTTP(S) request body</p>
<code>webappconfig/welcome-file-list</code>	<p>List of filenames that are considered welcome files. When an HTTP(S) <code>get</code> request for a container is received, the server first checks if there is a resource in the container with any of these names. If so, then the contents of that file are sent, instead of a list of resources in the container.</p>
<code>default-url-charset</code>	<p>The character set in which an HTTP(S) protocol server assumes incoming URL is encoded when it is not encoded in UTF-8 or the Content-Type field Charset parameter of the request.</p>

Table 28-3 (Cont.) Configuration Parameters Specific to HTTP(S)/WebDAV (Except Servlet)

Parameter	Description
allow-repository-anonymous-access	Indication of whether or not anonymous HTTP access to Oracle XML DB Repository data is allowed using an unlocked ANONYMOUS user account. The default value is <code>false</code> , meaning that unauthenticated access to repository data is <i>blocked</i> . See Anonymous Access to Oracle XML DB Repository Using HTTP (page 28-23).
authentication	The HTTP authentication mechanisms allowed. See Configuration and Management of Authentication Mechanisms for HTTP (page 28-10)
expire	HTTP header that specifies the expiration date and time for a URL. See Control of URL Expiration Time (page 28-23).

Note:

Oracle recommends that you use the subprograms of PL/SQL package `DBMS_XDB_CONFIG` to set or change FTP or HTTP port numbers. Do *not* set ports by directly editing configuration file `xdbconfig.xml`

28.2.2 Configuring Secure HTTP (HTTPS)

To enable the repository to use *secure* HTTP connections (HTTPS), a database administrator (DBA) must configure the database accordingly: configure parameters `http2-port` and `http2-protocol`, enable the HTTP Listener to use SSL, and enable launching of the TCPS Dispatcher. The DBA must then stop and restart the database and the listener.

See Also:

[Configuration of Oracle XML DB Using `xdbconfig.xml`](#) (page 34-5) for information about configuring Oracle XML DB parameters

28.2.2.1 Enabling the HTTP Listener to Use SSL

To configure the HTTP Listener for SSL, a database administrator (DBA) must create a wallet for the server and import a certificate; specify the wallet location to the server; disable client authentication; add an `SSL_DH_anon` cipher suite to `SSL_CIPHER_SUITES`; and create a listening end point that uses TCP/IP with SSL.

More precisely, a DBA must carry out the following steps to configure the HTTP Listener for SSL.

1. *Create a wallet for the server and import a certificate* – Use Oracle Wallet Manager to do the following:
 - a. Create a wallet for the server.

- b. If a valid certificate with distinguished name (DN) of the server is not available, create a certificate request and submit it to a certificate authority. Obtain a valid certificate from the authority.
- c. Import a valid certificate with the distinguished name (DN) of the server into the server.
- d. Save the new wallet in *obfuscated* form, so that it can be opened without a password.

See Also:

Oracle Database Enterprise User Security Administrator's Guide for information about how to create a wallet

2. *Specify the wallet location to the server* – Use Oracle Net Manager to do this. Ensure that the configuration is saved to disk. This step updates files `sqlnet.ora` and `listener.ora`.
3. *Disable client authentication* at the server, since most Web clients do not have certificates. Use Oracle Net Manager to do this. This step updates file `sqlnet.ora`.
4. *Add an SSL_DH_anon cipher suite to SSL_CIPHER_SUITES* – Use any of these:
 - `SSL_DH_anon_WITH_3DES_EDE_CBC_SHA`
 - `SSL_DH_anon_WITH_RC4_128_MD5`
 - `SSL_DH_anon_WITH_DES_CBC_SHA`This step updates file `sqlnet.ora`.
5. *Create a listening end point that uses TCP/IP with SSL* – Use Oracle Net Manager to do this. This step updates file `listener.ora`.

See Also:

Oracle Database Security Guide for detailed information regarding steps 1 (page 28-7) through 5 (page 28-8)

28.2.2.2 Enabling TCPS Dispatcher

To enable launching of a TCPS dispatcher during database startup, a database administrator (DBA) must edit the database `pfile`.

The following line must be added to the `pfile`, where *SID* is the SID of the database:

```
dispatchers=(protocol=tcps)(service=SIDxdb)
```

The database `pfile` location depends on your operating system, as follows:

- *MS Windows* – `PARENT/admin/orcl/pfile`, where *PARENT* is the parent folder of folder `ORACLE_HOME`
- *UNIX, Linux* – `$ORACLE_HOME/admin/$ORACLE_SID/pfile`

28.2.3 Using Listener Status to Check Port Configuration

You can use the TNS Listener command, `lsnrctl status`, to verify that HTTP(S) and FTP support has been enabled. An example illustrates this.

See Also:

[Repository Access Using Protocols](#) (page 28-1)

Example 28-1 Listener Status with FTP and HTTP(S) Protocol Support Enabled

LSNRCTL for 32-bit Windows: Version 11.1.0.5.0 - Production on 20-AUG-2007 16:02:34

Copyright (c) 1991, 2007, Oracle. All rights reserved.

Connecting to (DESCRIPTION=(ADDRESS=(PROTOCOL=IPC)(KEY=EXTPROC1521))) STATUS of the LISTENER

```
-----
Alias                               LISTENER
Version                             TNSLSNR for 32-bit Windows: Version 11.1.0.5.0 - Beta
Start Date                           20-JUN-2007 15:35:40
Uptime                               0 days 16 hr. 47 min. 42 sec
Trace Level                           off
Security                             ON: Local OS Authentication
SNMP                                  OFF
Listener Parameter File               C:\oracle\product\11.1.0\db_1\network\admin\listener.ora
Listener Log File                     c:\oracle\diag\tnslsnr\quine-pc\listener\alert\log.xml
-----
```

Listening Endpoints Summary...

```
(DESCRIPTION=(ADDRESS=(PROTOCOL=ipc)(PIPENAME=\\.\pipe\EXTPROC1521ipc)))
(DESCRIPTION=(ADDRESS=(PROTOCOL=tcp)(HOST=quine-pc.example.com)(PORT=1521)))
(DESCRIPTION=(ADDRESS=(PROTOCOL=tcp)(HOST=quine-pc.example.com)
(PORT=21))(Presentation=FTP)(Session=RAW))
(DESCRIPTION=(ADDRESS=(PROTOCOL=tcp)(HOST=quine-pc.example.com)
(PORT=443))(Presentation=HTTP)(Session=RAW))
```

Services Summary...

```
Service "orcl.example.com" has 1 instance(s).
  Instance "orcl", status READY, has 1 handler(s) for this service...
Service "orclXDB.example.com" has 1 instance(s).
  Instance "orcl", status READY, has 1 handler(s) for this service...
Service "orcl_XPT.example.com" has 1 instance(s).
  Instance "orcl", status READY, has 1 handler(s) for this service...
The command completed successfully
```

28.2.4 Configuring Protocol Port Parameters after Database Consolidation

In a multitenant container database (CDB), protocol server port numbers distinguish the plugged-in pluggable databases (PDBs): each such database must have unique port numbers. A database administrator (DBA) must ensure that each port number used by a PDB is unique.

To avoid port conflicts and to resolve any port conflicts that might result from consolidation, a database administrator must proceed as follows:

1. Use PL/SQL function `DBMS_XDB_CONFIG.usedPort` to obtain the port numbers used by the other PDBs in the same CDB.

2. Use PL/SQL subprogram `DBMS_XDB_CONFIG.setFTPPort` or `DBMS_XDB_CONFIG.setHTTPPort`, as needed, to change each port number that conflicts so that it is unique.

Note:

After a PDB plug-in or clone operation, and until Oracle XML DB has been fully initialized, the port parameter settings in the configuration file, `xdbconfig.xml`, might be *undefined*. Oracle recommends that you use `DBMS_XDB_CONFIG` subprogram `getFTPPort`, `getHTTPPort`, `getHTTPSPort`, `setFTPPort`, `setHTTPPort`, or `setHTTPSPort` to obtain or modify a port value.

28.2.5 Configuration and Management of Authentication Mechanisms for HTTP

You configure the authentication mechanisms to allow for HTTP access to Oracle XML DB Repository by setting element `authentication`, a child of element `httpconfig`, in configuration file `xdbconfig.xml`.

Starting with 12c Release 1 (12.1.0.1), Oracle Database supports not only basic authentication but also digest access authentication.

User credentials are case-sensitive. In particular, to be authenticated, a user name must exactly match the name as it was created (which by default is all uppercase).

Digest access authentication, also known as **digest authentication** provides encryption of user credentials (name, password, etc.) without the overhead of complete data encryption.

You can configure the authentication mechanism to use by setting element `authentication`, a child of element `httpconfig`, in configuration file `xdbconfig.xml`. Element `authentication` is optional. If absent then only basic authentication is used.

Element `authentication` has two possible child elements:

- Element `allow-mechanism` specifies an allowed mechanism: `basic`, `digest`, or `custom`. Use a separate `allow-mechanism` element to specify each mechanism you want to allow.
- Element `digest-auth` is optional. It specifies information for a digest mechanism. Its child element `nonce-timeout` specifies the number of seconds that a given nonce remains valid. The default value is 300 seconds.

The default value is used if there is an `allow-mechanism` that specifies `digest` but there is no `digest-auth` element. A `digest-auth` element is ignored if there is no `allow-mechanism` that specifies `digest`.

HTTP requests are accepted for each `allow-mechanism` specified. Authentication challenges are presented in the order of the specified `allow-mechanism` types. For example, if both `digest` and `basic` are present, in that order, then a `digest` challenge is presented before a `basic` challenge. Oracle recommends that you *always* put a stronger authentication before a weaker one. (Digest authentication is stronger than basic authentication.)

See Also:

- [Upgrade or Downgrade of an Existing Oracle XML DB Installation](#) (page 34-1) for installation, upgrade, and downgrade considerations
 - RFC2617, *HTTP Authentication: Basic and Digest Access Authentication*, <http://tools.ietf.org/html/rfc2617>
-
-

28.2.5.1 Nonces for Digest Authentication

With digest authentication, the server generates a nonce whenever it issues an unauthorized response. Clients include the nonce in requests to the server. The server checks nonces received from the client to see if it needs to refuse the client authentication. A client can authenticate the server the same way.

A **nonce** is a unique string that the server generates each time it issues an HTTP 401 (unauthorized) response. Clients include the nonce in subsequent requests that they issue to the server. The server checks the nonce it receives from the client. If incorrect or if the `nonce-timeout` period has expired, the server can immediately refuse to authenticate.

(A client can use the same mechanism to authenticate the server: it can generate its own nonce. Both client and server can use this client nonce to help prevent particular plain-text attacks.)

A new nonce is created each time the server sends a digest challenge to a client. A nonce is based on a **nonce key**. The initial nonce key is generated randomly when you install or upgrade the database.

If you use digest authentication then Oracle also recommends that you create a new nonce key periodically, to ensure the integrity of the key. You use PL/SQL procedure `DBMS_XDB_ADMIN.createNonceKey` to do this.

28.2.6 Oracle XML DB Repository and File-System Resources

Protocol specifications, RFC 959 (FTP), RFC 2616 (HTTP), and RFC 2518 (WebDAV) implicitly assume an abstract, hierarchical file system on the server side. This is mapped to Oracle XML DB Repository. The repository provides name resolution, ACL-based security, and an ability to store and retrieve any content.

The repository can store binary data input through FTP and XML schema-based documents.

See Also:

- <http://www.ietf.org/rfc/rfc959.txt>
 - <http://www.ietf.org/rfc/rfc2616.txt>
 - <http://www.ietf.org/rfc/rfc2518.txt>
-
-

28.2.7 Protocol Server Handles XML Schema-Based or Non-Schema-Based XML Documents

Oracle XML DB protocol server always checks whether a document being inserted is based on an XML schema that is registered with Oracle XML DB Repository. If it is,

then the `XMLType` storage model to use is determined by that XML schema. If it is not, then the document is stored as a BLOB.

28.2.8 Event-Based Logging

You can log the requests received and responses sent by a protocol server by setting event number 31098 to level 2.

To set this event, add the following line to your `init.ora` file and restart the database:

```
event="31098 trace name context forever, level 2"
```

28.3 FTP and the Oracle XML DB Protocol Server

File Transfer Protocol (FTP), specified in RFC959, is one of the oldest and most popular protocols. It provides access to heterogeneous file systems in a uniform manner. You can use FTP to access and update data stored in Oracle XML DB Repository.

28.3.1 Oracle XML DB Protocol Server: FTP Features

File Transfer Protocol (FTP) is implemented by dedicated clients at the operating system level, file-system explorer clients, and browsers. FTP is typically session-oriented: a user session is created through an explicit logon, a number of files or directories are downloaded and browsed, and then the connection is closed.

The transfer of command messages and the return of status happens on a single connection. However, a new connection is opened between the client and the server for data transfer. With HTTP(S), by contrast, commands and data are transferred using a single connection.

Note:

For security reasons, FTP is *disabled*, by default, for Oracle Database. This is because the IETF FTP protocol specification requires that passwords be transmitted in clear text. Disabling is done by configuring the FTP server port as zero (0). To enable FTP, set the `ftp-port` parameter to the FTP port to use, such as 2100.

See Also:

- RFC 959: FTP Protocol Specification – <http://www.ietf.org/rfc/rfc959.txt>
 - [Configuration of Oracle XML DB Using `xdbconfig.xml`](#) (page 34-5) for information about configuring parameters
-
-

28.3.1.1 FTP Features That Are Not Supported

FTP features that are not supported by Oracle XML DB include record-oriented files and operations `append`, `allocate`, `account`, and `abort`.

Oracle XML DB implements FTP, as defined by RFC 959, with the *exception* of the following optional features:

- Record-oriented files, for example, only the `FILE` structure of the `STRU` method is supported. This is the most widely used structure for transfer of files. It is also the default specified by the specification. Structure mount is not supported.
- Append.
- Allocate. This pre-allocates space before file transfer.
- Account. This uses the insecure Telnet protocol.
- Abort.

28.3.1.2 Supported FTP Client Methods

Oracle XML DB supports several FTP client methods for access to Oracle XML DB Repository.

- `cdup` – change working directory to parent directory
- `cwd` – change working directory
- `dele` – delete file (not directory)
- `list`, `nlst` – list files in working directory
- `mkd` – create directory
- `noop` – do nothing (but timeout counter on connection is reset)
- `pasv`, `port` – establish a TCP data connection
- `pwd` – get working directory
- `quit` – close connection and quit FTP session
- `retr` – retrieve data using an established connection
- `rmd` – remove directory
- `rnfr`, `rnto` – rename file (two-step process: from file, to file)
- `stor` – store data using an established connection
- `syst` – get system version
- `type` – change data type: `ascii` or image binary types only
- `user`, `pass` – user login

See Also:

- [FTP Quote Methods](#) (page 28-13) for supported FTP `quote` methods
 - [Using FTP with Oracle ASM Files](#) (page 28-16) for an example of using FTP method `proxy`
-
-

28.3.1.3 FTP Quote Methods

Oracle Database supports several FTP `quote` methods, which provide information directly to Oracle XML DB.

- **rm_r** – Remove file or folder *<resource_name>*. If a folder, recursively remove all files and folders contained in *<resource_name>*.

```
quote rm_r <resource_name>
```

- **rm_f** – Forcibly remove a resource.

```
quote rm_f <resource_name>
```

- **rm_rf** – Combines **rm_r** and **rm_f**: Forcibly and recursively removes files and folders.

```
quote rm_rf <resource_name>
```

- **set_nls_locale** – Specify the character-set encoding (*<charset_name>*) to be used for file and directory names in FTP methods (including names in method responses).

```
quote set_nls_locale {<charset_name> | NULL}
```

Only IANA character-set names can be specified for *<charset_name>*. If *nls_locale* is set to NULL or is not set, then the database character set is used.

- **set_charset** – Specify the character set of the data to be sent to the server.

```
quote set_charset {<charset_name> | NULL}
```

The *set_charset* method applies to only *text* files, not binary files, as determined by the file-extension mapping to MIME types that is defined in configuration file *xdbconfig.xml*.

If the parameter provided to *set_charset* is **<charset_name>** (*not* NULL), then it specifies the character set of the data.

If the parameter provided to *set_charset* is NULL, or if no *set_charset* command is given, then the *MIME type* of the data determines the character set for the data.

- If the MIME type is *not* *text/xml*, then the data is not assumed to be XML. The database character set is used.

- If the MIME type is **text/xml**, then the data represents an XML document.

If a *byte order mark*¹ (BOM) is present in the XML document, then it determines the character set of the data.

If there is *no* BOM, then:

- If there is an *encoding declaration* in the XML document, then it determines the character set of the data.
- If there is *no* encoding declaration, then the UTF-8 character set is used.

28.3.1.4 Uploading Content to Oracle XML DB Repository Using FTP

An example shows the commands issued and the output generated when a standard command line FTP tool loads documents into Oracle XML DB Repository:

The key point demonstrated by [Figure 28-3](#) (page 28-30) and [Example 28-2](#) (page 28-15) is that neither Windows Explorer nor an FTP tool is aware that it is

¹ BOM is a Unicode-standard signature that indicates the order of the stream of bytes that follows it.

working with Oracle XML DB. Since such tools and Oracle XML DB both support open Internet protocols they work with each other out of the box.

Any tool that understands the WebDAV or FTP protocol can be used to create content managed by Oracle XML DB Repository. No additional software needs to be installed on the client or the mid-tier.

When the contents of folders are viewed using a tool such as Windows Explorer or FTP, the lengths of any XML Schema-based documents contained in the folder are shown as zero (0) bytes. This was designed as such for two reasons:

- It is not clear what the size of a document should be. Is it the size of the CLOB instance generated by printing the document, or the number of bytes required to store the objects used to persist the document inside the database?
- Regardless of which definition is chosen, calculating and maintaining this information is costly.

Example 28-2 Uploading Content to the Repository Using FTP

```
$ ftp mdrake-sun 2100
Connected to mdrake-sun.
220 mdrake-sun FTP Server (Oracle XML DB/Oracle Database 10g Enterprise Edition
Release 10.1.0.1.0 - Beta) ready.
Name (mdrake-sun:oracle10): QUINE
331 Password required for QUINE
Password: password
230 QUINE logged in
ftp> cd /source/schemas
250 CWD Command successful
ftp> mkdir PurchaseOrders
257 MKD Command successful
ftp> cd PurchaseOrders
250 CWD Command successful
ftp> mkdir 2002
257 MKD Command successful
ftp> cd 2002
250 CWD Command successful
ftp> mkdir "Apr"
257 MKD Command successful
ftp> put "Apr/AMCEWEN-20021009123336171PDT.xml"
"Apr/AMCEWEN-20021009123336171PDT.xml"
200 PORT Command successful
150 ASCII Data Connection
226 ASCII Transfer Complete
local: Apr/AMCEWEN-20021009123336171PDT.xml remote:
Apr/AMCEWEN-20021009123336171PDT.xml
4718 bytes sent in 0.0017 seconds (2683.41 Kbytes/s)
ftp> put "Apr/AMCEWEN-20021009123336271PDT.xml"
"Apr/AMCEWEN-20021009123336271PDT.xml"
200 PORT Command successful
150 ASCII Data Connection
226 ASCII Transfer Complete
local: Apr/AMCEWEN-20021009123336271PDT.xml remote:
Apr/AMCEWEN-20021009123336271PDT.xml
4800 bytes sent in 0.0014 seconds (3357.81 Kbytes/s)
.....
ftp> cd "Apr"
250 CWD Command successful
ftp> ls -l
200 PORT Command successful
150 ASCII Data Connection
```

```
-rw-r--r1 QUINE oracle 0 JUN 24 15:41 AMCEWEN-20021009123336171PDT.xml
-rw-r--r1 QUINE oracle 0 JUN 24 15:41 AMCEWEN-20021009123336271PDT.xml
-rw-r--r1 QUINE oracle 0 JUN 24 15:41 EABEL-20021009123336251PDT.xml
-rw-r--r1 QUINE oracle 0 JUN 24 15:41 PTUCKER-20021009123336191PDT.xml
-rw-r--r1 QUINE oracle 0 JUN 24 15:41 PTUCKER-20021009123336291PDT.xml
-rw-r--r1 QUINE oracle 0 JUN 24 15:41 SBELL-20021009123336231PDT.xml
-rw-r--r1 QUINE oracle 0 JUN 24 15:41 SBELL-20021009123336331PDT.xml
-rw-r--r1 QUINE oracle 0 JUN 24 15:41 SKING-20021009123336321PDT.xml
-rw-r--r1 QUINE oracle 0 JUN 24 15:41 SMCCAIN-20021009123336151PDT.xml
-rw-r--r1 QUINE oracle 0 JUN 24 15:41 SMCCAIN-20021009123336341PDT.xml
-rw-r--r1 QUINE oracle 0 JUN 24 15:41 VJONES-20021009123336301PDT.xml
226 ASCII Transfer Complete
remote: -l
959 bytes received in 0.0027 seconds (349.45 Kbytes/s)
ftp> cd ".."
250 CWD Command successful
....
ftp> quit
221 QUIT Goodbye.
$
```

28.3.1.5 Using FTP with Oracle ASM Files

Oracle Automatic Storage Management (Oracle ASM) organizes database files into disk groups for simplified management and added benefits such as database mirroring and I/O balancing. You can use protocols and resource APIs to access Oracle ASM files in repository *virtual folder* `/sys/asm`. All files in `/sys/asm` are binary.

Typical uses are listing, copying, moving, creating, and deleting Oracle ASM files and folders. [Example 28-3](#) (page 28-17) is an example of navigating the Oracle ASM virtual folder and listing the files in a subfolder.

The structure of the Oracle ASM virtual folder, `/sys/asm`, is described in [Access to Oracle XML DB Repository Data](#) (page 21-1). In [Example 28-3](#) (page 28-17), the disk groups are `DATA` and `RECOVERY`; the database name is `MFG`; and the directories created for aliases are `db`s and `tmp`. This example navigates to a subfolder, lists its files, and copies a file to the local file system.

In [Example 28-3](#) (page 28-17), after connecting to and logging onto database `myhost` (first four lines), FTP methods `cd` and `ls` are used to navigate and list folders, respectively. When in folder `/sys/asm/DATA/db`s, FTP command `get` is used to copy files `t_db1.f` and `t_ax1.f` to the current folder of the local file system. Then, FTP command `put` is used to copy file `my_db2.f` from the local file system to folder `/sys/asm/DATA/db`s.

Database administrators can copy Oracle Automatic Storage Management (Oracle ASM) files from *one database server to another* or between the database and a local file system. [Example 28-4](#) (page 28-17) shows copying between two databases. For this, the `proxy` FTP client method can be used, if available. The `proxy` method provides a *direct* connection to two different remote FTP servers.

[Example 28-4](#) (page 28-17) copies an Oracle ASM file from one database to another. Terms with the suffix `1` correspond to database `server1`. Terms with the suffix `2` correspond to database `server2`. Depending on your FTP client, the passwords you type might be echoed on your screen. Take the necessary precautions so that others do not see these passwords.

In [Example 28-4](#) (page 28-17):

- Line 1 opens an FTP control connection to the Oracle XML DB FTP server, `server1`.
- Lines 2–4 log the database administrator onto `server1` as `USERNAME1`.
- Line 5 navigates to `/sys/asm/DATAFILE/MFG/DATAFILE` on `server1`.
- Line 6 opens an FTP control connection to the second database server, `server2`. At this point, the FTP command `proxy ?` could be issued to see the available FTP commands on the secondary connection. (This is not shown.)
- Lines 7–9 log the database administrator onto `server2` as `USERNAME2`.
- Line 10 navigates to `/sys/asm/DATAFILE/MFG/DATAFILE` on `server2`.
- Line 11 copies Oracle ASM file `db2.f` from `server2` to Oracle ASM file `tmp1.f` on `server1`.
- Line 12 copies Oracle ASM file `db1.f` from `server1` to Oracle ASM file `tmp2.f` on `server2`.

Example 28-3 Navigating Oracle ASM Folders

```
ftp> open myhost 7777
ftp> user system
Password required for SYSTEM
Password: password
ftp> cd /sys/asm
ftp> ls
DATA
RECOVERY
ftp> cd DATA
ftp> ls
db2
MFG
ftp> cd db2
ftp> ls
t_dbl.f
t_axl.f
ftp> binary
ftp> get t_dbl.f, t_axl.f
ftp> put my_db2.f
```

Example 28-4 Transferring Oracle ASM Files Between Databases with FTP proxy Method

```
1 ftp> open server1 port1
2 ftp> user username1
3 Password required for USERNAME1
4 Password: password-for-username1
5 ftp> cd /sys/asm/DATAFILE/MFG/DATAFILE
6 ftp> proxy open server2 port2
7 ftp> proxy user username2
8 Password required for USERNAME2
9 Password: password-for-username2
10 ftp> proxy cd /sys/asm/DATAFILE/MFG/DATAFILE
11 ftp> proxy put db2.f tmp1.f
12 ftp> proxy get db1.f tmp2.f
```

28.3.1.6 Using FTP on the Standard Port Instead of the Oracle XML DB Default Port

You can use the Oracle XML DB configuration file, `xdbconfig.xml`, to configure FTP to listen on any port. By default, FTP listens on a non-standard, unprotected port.

To use FTP on the standard port, 21, your database administrator must do the following:

1. (UNIX only) Use this shell command to ensure that the owner and group of executable file `tnslsnr` are root:

```
% chown root:root $ORACLE_HOME/bin/tnslsnr
```

2. (UNIX only) Add the following entry to the listener file, `listener.ora`, where `hostname` is your host name:

```
(DESCRIPTION =  
  (ADDRESS = (PROTOCOL = TCP) (HOST = hostname) (PORT = 21))  
  (PROTOCOL_STACK = (PRESENTATION = FTP) (SESSION = RAW)))
```

3. (UNIX only) Use shell command `id` to determine the `user_id` and `group_id` that were used to install Oracle Database. `oracle_installation_user` is the name of the user who installed the database.

```
% id oracle_installation_user  
uid=user_id(oracle_installation_user) gid=group_id(dba)
```

4. (UNIX only) Stop, then restart the listener, using the following shell commands, where `user_id` and `group_id` are the UNIX user and group identifiers obtained in step 3 (page 28-18).

```
% lsnrctl stop  
% tnslnsr LISTENER -user user_id -group group_id &
```

Use the ampersand (&), to execute the second command in the background. Do not use `lsnrctl start` to start the listener.

5. Use PL/SQL procedure `DBMS_XDB_CONFIG.setFTPPort` with `SYS` as `SYSDBA` to set the FTP port number to 21 in the Oracle XML DB configuration file, `xdbconfig.xml`.

```
SQL> exec DBMS_XDB_CONFIG.setFTPPort(21);
```

6. Force the database to reregister with the listener, using this SQL statement:

```
SQL> ALTER SYSTEM REGISTER;
```

7. Check that the listener is correctly configured, using this shell command:

```
% lsnrctl status
```

See Also:

- *Oracle Database Net Services Reference* for information about listener parameters and file `listener.ora`
 - *Oracle Database Net Services Reference*, section "Port Number Limitations" for information about running on privileged ports
-
-

28.3.1.7 Using IPv6 IP Addresses with FTP

Starting with 11g Release 2 (11.2), Oracle Database supports the use of Internet Protocol Version 6, IPv6 (in addition to Internet Protocol Version 4).

[Example 28-5](#) (page 28-19) shows how to make an FTP connection with the IPv6 address `2001::0db8:ffff:ffff:ffff`.

See Also:

Oracle Database Net Services Reference for information about IPv6

Example 28-5 FTP Connection Using IPv6

```
ftp> open 2001::0db8:ffff:ffff:ffff 1521
Connected to 2001::0db8:ffff:ffff:ffff.
220- xmlhost.example.com
Unauthorized use of this FTP server is prohibited and may be subject to civil
and criminal prosecution.
220- xmlhost.example.com FTP server (Oracle XML DB/Oracle Database) ready.
User (2001::0db8:ffff:ffff:ffff:(none)): username
331 pass required for USERNAME
Password: password-for-username
230 USERNAME logged in
ftp>
```

28.3.1.8 FTP Server Session Management

Oracle XML DB protocol server provides session management for FTP. After a short wait for a new command, FTP returns to the protocol layer and the shared server is freed up to serve other connections.

The duration of this short wait is configurable by changing parameter `call-timeout` in the Oracle XML DB configuration file. For high traffic sites, `call-timeout` should be shorter, so that more connections can be served. When new data arrives on the connection, the FTP server is re-invoked with fresh data. So, the long running nature of FTP does not affect the number of connections which can be made to the protocol server.

See Also:

[Configuration of Oracle XML DB Using `xdbconfig.xml`](#) (page 34-5) for information about configuring Oracle XML DB parameters

28.3.1.9 Handling Error 421. Modifying the Default Timeout Value of an FTP Session

If you are frequently disconnected from the server and you must reconnect and traverse the entire directory before performing the next operation, then you might need to modify the default timeout value for FTP sessions. If the session is idle for more than this period, it is disconnected.

You can increase the timeout value (default = 6000 centiseconds) by modifying the configuration document as follows and then restarting the database:

Example 28-6 Modifying the Default Timeout Value of an FTP Session

```
DECLARE
  newconfig XMLType;
BEGIN
  SELECT XMLQuery('copy $i := $p1 modify
    (for $j in $i/xdbconfig/sysconfig/protocolconfig/ftpconfig/session-timeout
      return replace value of node $j with $p2)
    return $i'
    PASSING DBMS_XDB_CONFIG.cfg_get() AS "p1", 123456789 AS "p2" RETURNING CONTENT)
  INTO newconfig FROM DUAL;
  DBMS_XDB_CONFIG.cfg_update(newconfig);
END;/
COMMIT;
```

28.3.1.10 FTP Client Failure in Passive Mode

Do not use FTP in *passive mode* to connect remotely to a server that has `HOSTNAME` configured in `listener.ora` as `localhost` or `127.0.0.1`.

If the `HOSTNAME` specified in server file `listener.ora` is `localhost` or `127.0.0.1`, then the server is configured for *local use only*. If you try to connect remotely to the server using FTP in passive mode, the FTP client fails. This is because the server passes IP address `127.0.0.1` (derived from `HOSTNAME`) to the client, which makes the client try to connect to itself, not to the server.

28.4 HTTP(S) and Oracle XML DB Protocol Server

Oracle XML DB implements HyperText Transfer Protocol (HTTP), HTTP 1.1 as defined in the RFC2616 specification.

28.4.1 Oracle XML DB Protocol Server: HTTP(S) Features

The Oracle XML DB HTTP(S) component of the Oracle XML DB protocol server implements the RFC2616 specification with the *exception* of a few optional features.

These are the optional HTTP(S) features that are not supported:

- `gzip` and compress transfer encodings
- byte-range headers
- The `TRACE` method (used for proxy error debugging)
- Cache-control directives (these require you to specify expiration dates for content, and are not generally used)
- `TE`, `Trailer`, `Vary` & `Warning` headers
- Weak entity tags
- Web common log format
- Multi-homed Web server

See Also:

RFC 2616, *HTTP 1.1 Protocol Specification*, <http://www.ietf.org/rfc/rfc2616.txt>

28.4.1.1 Supported HTTP(S) Client Methods

Oracle XML DB supports several HTTP(S) client methods for access to Oracle XML DB Repository.

- OPTIONS – get information about available communication options
- GET – get document/data (including headers)
- HEAD – get headers only, without document body
- PUT – store data in resource
- DELETE – delete resource

The semantics of these HTTP(S) methods are in accordance with WebDAV. Servlets and Web services may support additional HTTP(S) methods, such as POST.

See Also:

[WebDAV Client Methods Supported by Oracle XML DB](#) (page 28-28) for supported HTTP(S) client methods involving WebDAV

28.4.1.2 Using HTTP(S) on a Standard Port Instead of an Oracle XML DB Default Port

You can use the Oracle XML DB configuration file, `xdbconfig.xml`, to configure HTTP(S) to listen on any port. By default, HTTP(S) listens on a non-standard, unprotected port.

To use HTTP or HTTPS on a standard port (80 for HTTP, 443 for HTTPS), your database administrator must do the following:

1. (UNIX only) Use this shell command to ensure that the owner and group of executable file `tnslsnr` are root:

```
% chown root:root $ORACLE_HOME/bin/tnslsnr
```

2. (UNIX only) Add the following entry to the listener file, `listener.ora`, where *hostname* is your host name, and *port_number* is 80 for HTTP or 443 for HTTPS:

```
(DESCRIPTION =
  (ADDRESS = (PROTOCOL = TCP) (HOST = hostname) (PORT = port_number))
  (PROTOCOL_STACK = (PRESENTATION = HTTP) (SESSION = RAW)))
```

3. (UNIX only) Use shell command `id` to determine the *user_id* and *group_id* that were used to install Oracle Database. *oracle_installation_user* is the name of the user who installed the database.

```
% id oracle_installation_user
uid=user_id(oracle_installation_user) gid=group_id(dba)
```

4. (UNIX only) Stop, then restart the listener, using the following shell commands, where *user_id* and *group_id* are the UNIX user and group identifiers obtained in step 3 (page 28-21).

```
% lsnrctl stop
% tnslnsr LISTENER -user user_id -group group_id &
```

Use the ampersand (&), to execute the second command in the background. Do not use `lsnrctl start` to start the listener.

5. Use PL/SQL procedure `DBMS_XDB_CONFIG.setHTTPPort` with `SYS` as `SYSDBA` to set the HTTP(S) port number to `port_number` in the Oracle XML DB configuration file `xdbconfig.xml`, where `port_number` is 80 for HTTP or 443 for HTTPS:

```
SQL> exec DBMS_XDB_CONFIG.setHTTPPort(port_number);
```

6. Force the database to reregister with the listener, using this SQL statement:

```
SQL> ALTER SYSTEM REGISTER;
```

7. Check that the listener is correctly configured:

```
% lsnrctl status
```

See Also:

- *Oracle Database Net Services Reference* for information about listener parameters and file `listener.ora`
 - *Oracle Database Net Services Reference*, section "Port Number Limitations" for information about running on privileged ports
-
-

28.4.1.3 Use of IPv6 IP Addresses with HTTP(S)

Starting with 11g Release 2 (11.2), Oracle Database supports the use of Internet Protocol Version 6, IPv6 (in addition to Internet Protocol Version 4). IPv6 addresses in URLs are enclosed in brackets ([]).

Here is an example:

```
http://[2001::0db8:ffff:ffff:ffff]:8080/
```

See Also:

Oracle Database Net Services Administrator's Guide for information about IPv6

28.4.1.4 HTTPS: Support for Secure HTTP

If properly configured, you can access Oracle XML DB Repository in a *secure* fashion, using HTTPS.

See [Configuring Secure HTTP \(HTTPS\)](#) (page 28-7) for configuration information.

Note:

If Oracle Database is installed on Microsoft Windows XP with *Service Pack 2* (SP2), then you must use HTTPS for WebDAV access to Oracle XML DB Repository, or else you must make appropriate modifications to the Windows XP Registry. For information about the latter, see <http://www.microsoft.com/technet/prodtechnol/winxp/pro/maintain/sp2netwk.aspx#XSLTsection129121120120>

28.4.1.5 Control of URL Expiration Time

Optional configuration parameter `expire` specifies an HTTP `Expires` header. This header acts as a directive to the HTTP client, to specify the expiration date and time for a URL.

If cached, the document targeted by a URL can be fetched from the client cache rather than from the server, until this expiration time has passed. After that time, the cache copy is out-of-date and a new copy must be obtained from the source (server).

The Oracle XML DB syntax for the `Expires` header, which is used in the `expire` configuration element, is a subset of the so-called alternate syntax defined for the `ExpiresDefault` directive of the Apache module `mod_expires`. See http://httpd.apache.org/docs/2.0/mod/mod_expires.html#AltSyn for that syntax.

These are the Oracle XML DB restrictions to the `ExpiresDefault` syntax:

- You cannot use `access` as the `<base>`. Only `now` and `modification` are allowed.
- The `<type>` values must appear in order of decreasing time period. For example, `year` must appear before, not after, `month`, since a year is a longer time period than a month.
- You can use at most one occurrence of each of the different `<type>` values. For example, you cannot have multiple `year` entries or multiple `day` entries.

28.4.1.6 Anonymous Access to Oracle XML DB Repository Using HTTP

Optional configuration parameter `allow-repository-anonymous-access` controls whether or not anonymous HTTP access to Oracle XML DB Repository data is allowed using an unlocked `ANONYMOUS` user account. The default value is `false`, meaning that unauthenticated access to repository data is *blocked*.

To allow anonymous HTTP access to the repository, you must set this parameter to `true`, and unlock the `ANONYMOUS` user account.

Caution:

There is an inherent *security risk* associated with allowing anonymous access to the repository.

Parameter `allow-repository-anonymous-access` does *not* control anonymous access to the repository using *servlets*. Each servlet has its own `security-role-ref` parameter value to control its access.

Note:

If user account `ANONYMOUS` is *locked* for a multitenant container database (CDB) then locking or unlocking `ANONYMOUS` for a pluggable database (PDB) plugged into that CDB has *no effect* on access by `ANONYMOUS` to the PDB.

See Also:

- [Table 28-3](#) (page 28-5) for information about parameter `allow-repository-anonymous-access`
 - [Configuration of Oracle XML DB Using `xdbconfig.xml`](#) (page 34-5) for information about configuring Oracle XML DB parameters
 - [Configuration of Oracle XML DB Servlets](#) (page 31-3) for information about parameter `security-role-ref`
-

28.4.1.7 Use of Java Servlets with HTTP(S)

Oracle XML DB supports the use of Java servlets. Each must each be registered with a unique name in the Oracle XML DB configuration file, along with parameters to customize its action. It should be compiled and loaded into the database. The servlet name must be associated with a pattern.

The pattern can be an extension such as `*.jsp` or a path name such as `/a/b/c` or `/sys/*`, as described in Java servlet application program interface (API) version 2.2.

While processing an HTTP(S) request, the path name for the request is matched against the registered patterns. If there is a match then the protocol server invokes the corresponding servlet with the appropriate initialization parameters. The Java Virtual Machine (JVM) is started, and it invokes a Java method to initialize the servlet, create response and request objects, pass these on to the servlet, and run the servlet.

See Also:

[Guidelines for Oracle XML DB Applications in Java](#) (page 31-1)

28.4.1.8 Embedded PL/SQL Gateway

You can use the embedded PL/SQL gateway to implement a Web application entirely in PL/SQL. It runs in the Oracle XML DB HTTP listener.

With the embedded PL/SQL gateway, a Web browser sends an HTTP(S) request in the form of a URL that identifies a stored procedure and provides it with parameter values. The gateway translates the URL, calls the stored procedure with the parameter values, and returns output (typically HTML) to the Web-browser client.

Using the embedded PL/SQL gateway simplifies installation, configuration, and administration of PL/SQL based Web applications. The embedded gateway uses the Oracle XML DB protocol server, not Oracle HTTP Server. Its configuration is defined by the Oracle XML DB configuration file, `xdbconfig.xml`. However, the *recommended* way to configure the embedded gateway is to use the procedures in PL/SQL package `DBMS_EPG`, *not* to edit file `xdbconfig.xml`.

Note:

If you are currently using `mod_plsql`, which is a plug-in of *Oracle HTTP Server* that lets you invoke PL/SQL stored procedures using HTTP(S), Oracle recommends that you migrate to using the embedded PL/SQL gateway instead.

See Also:

- *Oracle Database Development Guide* for information about configuring and using the embedded PL/SQL gateway
 - [Administration of Oracle XML DB](#) (page 34-1) for information on the configuration definition of the embedded gateway in `xdbconfig.xml`
-
-

28.4.1.9 Transmission of Multibyte Data From a Client

When a client sends multibyte data in a URL, RFC 2718 specifies that the client should use the `%HH` format, where `HH` is the hexadecimal notation of the byte value in UTF-8 encoding.

The following are URL examples that can be sent to Oracle XML DB in an HTTP(S) or WebDAV context:

```
http://urltest/xyz%E3%81%82%E3%82%A2
http://%E3%81%82%E3%82%A2
http://%E3%81%82%E3%82%A2/abc%E3%81%86%E3%83%8F.xml
```

Oracle XML DB processes the requested URL, any URLs within an `IF` header, any URLs within the `DESTINATION` header, and any URLs in the `REFERRED` header that contains multibyte data.

The `default-url-charset` configuration parameter can be used to accept requests from some clients that use other, nonconforming, forms of URL, with characters that are not ASCII. If a request with such characters fails, try setting this value to the native character set of the client environment. The character set used in such URL fields must be specified with an IANA charset name.

`default-url-charset` controls the encoding for nonconforming URLs. It is not required to be set unless a nonconforming client that does not send the `Content-Type` charset is used.

See Also:

- RFC 2616, *HTTP 1.1 Protocol Specification*, <http://www.ietf.org/rfc/rfc2616.txt>
 - [Configuration of Oracle XML DB Using xdbconfig.xml](#) (page 34-5) for information about configuring Oracle XML DB parameters
-
-

28.4.1.10 Characters That Are Not ASCII in URLs

Convert non-ASCII characters that appear in URLs passed to an HTTP server to UTF-8 and escape them using the `%HH` format, where `HH` is the hexadecimal notation of the byte value.

For flexibility, the Oracle XML DB protocol server interprets the incoming URLs by testing whether it is encoded in one of the following character sets, in the order presented here:

- UTF-8
- Charset parameter of the `Content-Type` field of the request, if specified

- Character set, if specified, in the `default-url-charset` configuration parameter
- Character set of the database

See Also:

[Configuration of Oracle XML DB Using `xdbconfig.xml`](#) (page 34-5) for information about configuring Oracle XML DB parameters

28.4.1.11 Character Sets for HTTP(S)

You can control the character sets used for data that is transferred using HTTP(S).

28.4.1.11.1 HTTP(S) Request Character Set

The character set of an HTTP(S) request body is determined using a straightforward but somewhat complex algorithm.

1. The Content-Type header is evaluated. If the Content-Type header specifies a charset value, the specified charset is used.
2. The MIME type of the document is evaluated as follows:
 - a. If the MIME type is `* /xml` then the character set is determined as follows:
 - i. If neither a BOM nor an encoding declaration is present then UTF-8 is used.
 - ii. If a BOM is present then UTF-16 is used.
 - iii. If an encoding declaration is present then the specified encoding is used.
 - b. If the MIME type is `text` then ISO8859-1 is used.
 - c. If the MIME type is neither `* /xml` nor `text` then the database character set is used.

There is a difference between HTTP(S) and SQL or FTP. For text documents, the default is ISO8859-1, as specified by the IETF.org *RFC 2616: HTTP 1.1 Protocol Specification*.

28.4.1.11.2 HTTP(S) Response Character Set

The response generated by the Oracle XML DB HTTP server is in a character set specified in the `Accept-Charset` field of the request.

`Accept-Charset` can specify a list of character sets. Based on the q-value, Oracle XML DB chooses one of them that does not require conversion. This might not necessarily be the character set with the highest q-value. If Oracle XML DB cannot find one that does not require conversion, then the conversion used is based on the highest q-value.

28.5 WebDAV and Oracle XML DB

Web Distributed Authoring and Versioning (WebDAV) is an IETF standard protocol that Oracle XML DB uses to provide users with a file-system interface to Oracle XML Repository over the Internet. The most popular way of accessing a WebDAV server folder is through WebFolders using Microsoft Windows.

WebDAV is an extension to the HTTP 1.1 protocol that lets an HTTP server act as a file server. It lets clients perform remote Web content authoring through a coherent set of methods, headers, request body formats and response body formats. For example, a DAV-enabled editor can interact with an HTTP/WebDAV server as if it were a file system. WebDAV provides operations to store and retrieve resources, create and list contents of resource collections, lock resources for concurrent access in a coordinated manner, and to set and retrieve resource properties.

28.5.1 Oracle XML DB WebDAV Features

Oracle XML DB supports the foldering and access-control features of WebDAV. Foldering is specified by RFC2518.

WebDAV is a set of extensions to the HTTP(S) protocol that allow you to share, edit, and manage your files on remote Web servers.

See Also:

RFC 2518: WebDAV Protocol Specification, <http://www.ietf.org/rfc/rfc2518.txt>

28.5.1.1 WebDAV Features That Are Not Supported by Oracle XML DB

Oracle XML DB supports specification RFC2518, with the *exception* of a few features. For methods COPY, MOVE and DELETE it also supports the binding of resources as described in specification RFC5842.

These are the WebDAV features from RFC2518 that Oracle XML DB does not support:

- Using the name of a write-locked null resource (a lock-null resource) as a folder name is not supported, because it is represented as a zero-length resource in the file system. This is an optional feature.
- For method LOCK, you cannot specify infinity for the depth, to simultaneously lock a resource and all of its descendents. This feature is not optional, but it is not supported by Oracle XML DB.

In addition, for methods COPY, MOVE and DELETE Oracle XML DB supports the binding of resources as described in section 2 of RFC5842, "Binding Extensions to Web Distributed Authoring and Versioning (WebDAV)". A binding is a mapping of a URI to a resource, for a given folder.

See Also:

- Section 7.4 of the RFC2518 specification, <http://www.webdav.org/specs/rfc2518.html#rfc.section.7.4> for information about lock-null resources
 - Section 9.2 of the RFC2518 specification, <http://www.webdav.org/specs/rfc2518.html#rfc.section.9.2> for information about depth-infinity locks
 - Section 2 of the RFC5842 specification, <https://tools.ietf.org/html/rfc5842#section-2> for information about resource bindings
-
-

28.5.1.2 WebDAV Client Methods Supported by Oracle XML DB

Oracle XML DB supports several HTTP(S)/WebDAV client methods for access to Oracle XML DB Repository.

- `PROPFIND` (WebDAV-specific) – get properties for a resource
- `PROPPATCH` (WebDAV-specific) – set or remove resource properties
- `LOCK` (WebDAV-specific) – lock a resource (create or refresh a lock)
- `UNLOCK` (WebDAV-specific) – unlock a resource (remove a lock)
- `COPY` (WebDAV-specific) – copy a resource
- `MOVE` (WebDAV-specific) – move a resource
- `MKCOL` (WebDAV-specific) – create a folder resource (collection)

See Also:

- [Supported HTTP\(S\) Client Methods](#) (page 28-21) for additional supported HTTP(S) client methods
 - [Privileges](#) (page 27-5) for information about WebDAV privileges
 - [Adding Metadata Using WebDAV PROPPATCH](#) (page 29-9)
-

28.5.2 WebDAV and Microsoft Windows XP SP2

For Microsoft Windows XP with *Service Pack 2* (SP2), you must use a secure connection (HTTPS) for WebDAV access to Oracle XML DB Repository, or else you must make appropriate modifications to the Windows XP Registry.

See Also:

- <http://www.microsoft.com/technet/prodtechnol/winxpro/maintain/sp2netwk.mspx#XSLTsection129121120120> for information about making necessary modifications to the Windows XP registry
 - [Configuring Secure HTTP \(HTTPS\)](#) (page 28-7)
-

28.5.3 Creating a WebFolder in Microsoft Windows For Use With Oracle XML DB Repository

Create a WebFolder in Windows 2000 and use it with Oracle XML DB Repository.

Create a WebFolder in Windows 2000:

1. **Start > My Network Places.**
2. Double-click **Add Network Place.**
3. Click **Next.**

4. Type the location of the folder, for example:

```
http://Oracle_server_name:HTTP_port_number
```

See [Figure 28-2](#) (page 28-29).

5. Click **Next**.
6. Enter any name to identify this WebFolder
7. Click **Finish**.

You can access Oracle XML DB Repository the same way you access any Windows folder.

Figure 28-2 *Creating a WebFolder in Microsoft Windows*



28.5.3.1 Use of WebDAV with Windows Explorer to Copy Files into Oracle XML DB Repository

You can use Windows Explorer to insert a folder from a local hard drive into Oracle Database.

[Figure 28-3](#) (page 28-30) illustrates this.

Windows Explorer includes support for the WebDAV protocol. WebDAV extends the HTTP standard, adding additional verbs that allow an HTTP server to act as a file server.

When a Windows Explorer copy operation or FTP input command is used to transfer a number of documents into Oracle XML DB Repository, each `put` or `post` command is treated as a separate atomic operation. This ensures that the client does not get confused if one of the file transfers fails. It also means that changes made to a document through a protocol are visible to other users as soon as the request has been processed.

Figure 28-3 Copying Files into Oracle XML DB Repository

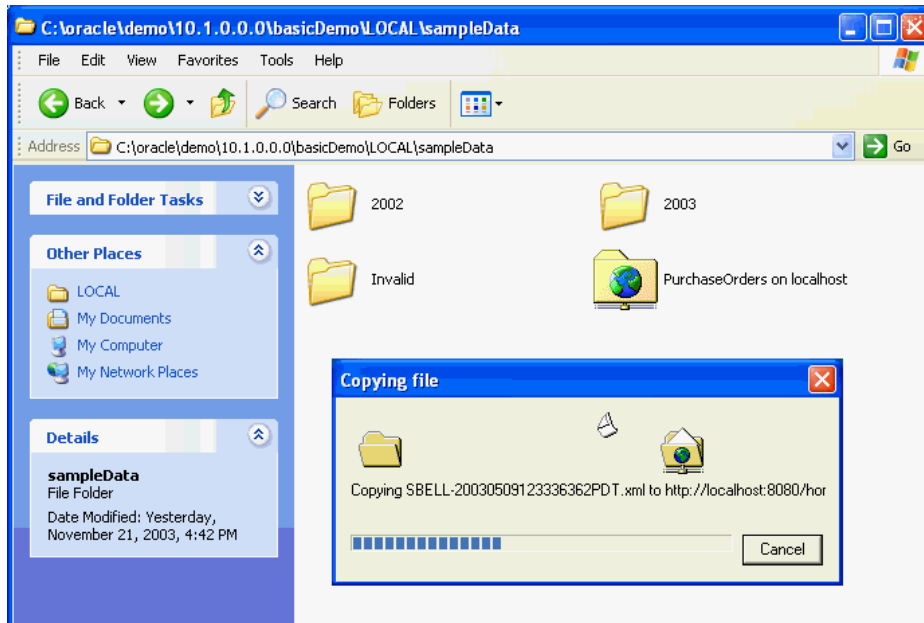

User-Defined Repository Metadata

You can create your own metadata to associate with XML data stored in Oracle XML DB Repository.

- [Overview of Metadata and XML](#) (page 29-1)
- [Using XML Schemas to Define Resource Metadata](#) (page 29-3)
- [Addition, Modification, and Deletion of Resource Metadata](#) (page 29-5)
- [Querying XML Schema-Based Resource Metadata](#) (page 29-9)
- [XML Image Metadata from Binary Image Metadata](#) (page 29-11)
- [Adding Non-Schema-Based Resource Metadata](#) (page 29-11)
- [PL/SQL Procedures Affecting Resource Metadata](#) (page 29-13)

29.1 Overview of Metadata and XML

Data that you use is often associated with additional information that is not part of the content. To process it in different ways, you can use such **metadata** to group or classify data.

For example, you might have a collection of digital photographs, and you might associate metadata with each picture, such as information about the photographic characteristics (color composition, focal length) or context (location, kind of subject: landscape, people).

An Oracle XML DB repository **resource** is an XML document that contains both metadata and data. The data is the contents of element `Contents`. All other elements in the resource contain metadata. The data of a resource can be XML, but it need not be.

You can associate resources in the Oracle XML DB repository with metadata that you define. In addition to such *user-defined metadata*, each repository resource also has associated metadata that Oracle XML DB creates automatically and uses (transparently) to manage the resource. Such *system-defined metadata* includes properties such as the owner and creation date of each resource.

Except for system-defined metadata, you decide which resource information should be treated as data and which should be treated as metadata. For a photo resource, supplemental information about the photo is normally not considered to be part of the photo data, which is a binary image. For text, however, you sometimes have a choice of whether to include particular information in the resource contents (data) or keep it separate and associate it with the contents as metadata — that choice is often influenced by the applications that use or produce the data.

29.1.1 Kinds of Metadata – Uses of the Term

The term "metadata" is used in the context of XML in various ways, including XML Schema definitions, XML tags, and Oracle XML DB Repository resource information that supplements the resource content.

In addition to resource metadata (system-defined and user-defined), the term "metadata" is sometimes used to refer to the following:

- An XML *schema* is metadata that describes a class of XML documents.
- An XML *tag* (element or attribute name) is metadata that is used to label and organize the element content or attribute value.

You can associate metadata with an XML document that is the content of a repository resource in any of these ways:

- You can add additional XML elements containing the metadata information to the resource *contents*. For example, you could wrap digital image data in an XML document that also includes elements describing the photo. In this case, the data and its metadata are associated by being in the contents of the same resource. It is up to applications to separate the two and relate them correctly.
- You can add metadata information for a particular resource to the repository as the contents of a *separate resource*. In this case, it is up to applications to treat this resource as metadata and associate it with the data.
- You can add metadata information for a resource as repository *resource metadata*. In this case, Oracle XML DB recognizes the metadata as such. Applications can *discover* this metadata by querying the repository for it. They need not be informed separately of its existence and its association with the data.

See Also:

[Oracle XML DB Repository Resources](#) (page 21-7)

29.1.2 User-Defined Resource Metadata

User-defined resource metadata is itself represented as XML: it is XML data that is associated with other XML data, describing it or providing supplementary, related information.

User-defined metadata for resources can be either XML schema-based or not:

- Resource metadata that is *schema-based* is stored in separate (out-of-line) tables. These are related to the resource table by the resource OID, which is stored in the hidden object column `RESID` of the metadata tables.
- Resource metadata that is *not* schema-based is stored as part of the resource document in the resource table, `XDB.XDB$RESOURCE`.

You can take advantage of schema-based metadata, in particular, to perform efficient queries and DML operations on resources. In this chapter, you learn how to perform the following tasks involving schema-based resource metadata:

- Create and register an *XML schema* that defines the metadata for a particular kind of resource.

- *Add* metadata to a repository resource, and *update* (modify) such metadata.
- *Query* resource metadata to find associated content.
- *Delete* specific metadata associated with a resource and *purge* all metadata associated with a resource.

In addition, you learn how to add non-schema-based metadata to a resource.

You can generally use user-defined resource metadata just as you would use resource data. In particular, versioning and access control management apply.

Typical uses of resource metadata include workflow applications, enforcing user rights management, tracking resource ownership, and controlling resource validity dates.

29.1.3 Scenario: Metadata for a Photo Collection

A scenario used to illustrate the use of schema-based resource metadata uses metadata associated with photographic image files that are stored in repository resources. You can create any number of different kinds of metadata to be associated with the same resource.

For image files, examples create metadata for information about both 1) the technical aspects of a photo and 2) the photo subject or the uses to which a photo might be put. These two kinds of associated metadata are used to query photo resources.

29.2 Using XML Schemas to Define Resource Metadata

Before you can add user metadata to photo resources, you must define the structure of such metadata using XML Schema. An XML schema is created and registered for each kind (technique, category) of photo resource metadata.

See Also:

[Scenario: Metadata for a Photo Collection](#) (page 29-3) for general information about the example user-defined metadata scenario

The XML schema in [Example 29-1](#) (page 29-4) defines metadata used to describe the technical aspects of a photo image file. It uses PL/SQL procedure `DBMS_XMLSCHEMA.registerSchema` to register the XML schema. To identify this schema as defining repository resource *metadata*, it uses `ENABLE_HIERARCHY_RESMETADATA` as the value for parameter `enableHierarchy`. Resource contents (data) are defined by using value `ENABLE_HIERARCHY_CONTENTS` (the default value), instead.

The properties defined in [Example 29-1](#) (page 29-4) are the image height, width, color depth, title, and brief description.

The XML schema in [Example 29-2](#) (page 29-4) defines metadata used to categorize a photo image file: to describe its content or possible uses. This simple example defines a single, general property for classification, named `Category`.

Notice that there is nothing in the XML schema definitions of metadata that restrict that information to being associated with any particular kind of data. You are free to associate any type of metadata with any type of resource. And multiple types of metadata can be associated with the same resource.

Notice, too, that the XML schema does not, by itself, define its associated data as being metadata — it is the schema *registration* that makes this characterization, through `enableHierarchy` value `ENABLE_HIERARCHY_RESMETADATA`. If the same schema were registered instead with `enableHierarchy` value `ENABLE_HIERARCHY_CONTENTS` (the default value), then it would define not metadata for resources, but resource *contents* with the same information. The same XML schema cannot be registered more than once under the same name.

Note:

By default, user metadata is stored object-rationally if it is XML schema-based and as a CLOB instance if non XML schema-based. You can store either as binary XML instead, by setting the `OPTIONS` parameter for XML schema registration to `REGISTER_BINARYXML`.

Example 29-1 Registering an XML Schema for Technical Photo Information

```
BEGIN
DBMS_XMLSCHEMA.registerSchema(
  SCHEMAURL      => 'imagetechique.xsd',
  SCHEMADOC      => '<xsd:schema targetNamespace="inamespace"
                    xmlns:xsd="http://www.w3.org/2001/XMLSchema"
                    xmlns:xdb="http://xmlns.oracle.com/xdb"
                    xmlns="inamespace">
<xsd:element name="ImgTechMetadata"
              xdb:defaultTable="IMGTECHMETADATATABLE">
<xsd:complexType>
<xsd:sequence>
  <xsd:element name="Height"      type="xsd:float"/>
  <xsd:element name="Width"      type="xsd:float"/>
  <xsd:element name="ColorDepth" type="xsd:integer"/>
  <xsd:element name="Title"      type="xsd:string"/>
  <xsd:element name="Description" type="xsd:string"/>
</xsd:sequence>
</xsd:complexType>
</xsd:element>
</xsd:schema>',
  enableHierarchy => DBMS_XMLSCHEMA.ENABLE_HIERARCHY_RESMETADATA);
END;
/
```

Example 29-2 Registering an XML Schema for Photo Categorization

```
BEGIN
DBMS_XMLSCHEMA.registerSchema(
  SCHEMAURL      => 'imagecategories.xsd',
  SCHEMADOC      => '<xsd:schema targetNamespace="cnamespace"
                    xmlns:xsd="http://www.w3.org/2001/XMLSchema"
                    xmlns:xdb="http://xmlns.oracle.com/xdb"
                    xmlns="cnamespace">
<xsd:element name="ImgCatMetadata"
              xdb:defaultTable="IMGCATMETADATATABLE">
<xsd:complexType>
<xsd:sequence>
  <xsd:element name="Categories"
                type="CategoriesType"/>
</xsd:sequence>
</xsd:complexType>
</xsd:element>
```



```

        <xsd:complexType name="CategoriesType">
            <xsd:sequence>
                <xsd:element name="Category" type="xsd:string"
                    maxOccurs="unbounded" />
            </xsd:sequence>
        </xsd:complexType>
    </xsd:schema>',
    enableHierarchy => DBMS_XMLSCHEMA.ENABLE_HIERARCHY_RESMETADATA);
END;
/

```

29.3 Addition, Modification, and Deletion of Resource Metadata

You can add, update, and delete user-defined resource metadata using PL/SQL procedures in package `DBMS_XDB_REPOS`, SQL DML statements `INSERT`, `UPDATE`, and `DELETE`, or WebDAV protocol method `PROPPATCH`.

You can add, update, and delete user-defined resource metadata in any of the following ways:

- Use PL/SQL procedures in package `DBMS_XDB_REPOS`:
 - `appendResourceMetadata` – add metadata to a resource
 - `updateResourceMetadata` – modify resource metadata
 - `deleteResourceMetadata` – delete specific metadata from a resource
 - `purgeResourceMetadata` – delete *all* metadata from a resource
- Use SQL DML statements `INSERT`, `UPDATE`, and `DELETE` to update the resource directly
- Use WebDAV protocol method `PROPPATCH`

You use SQL DM statements and WebDAV method `PROPPATCH` to update or delete metadata in the same way as you add metadata. If you supply a complete `Resource` element for one of these operations, then keep in mind that each resource metadata property must be a child (not just a descendant) of element `Resource` — if you want multiple metadata elements of the same kind, you must collect them as children of a single parent metadata element. The order among such top-level user-defined resource metadata properties is unimportant and is not necessarily maintained by Oracle XML DB.

The separate PL/SQL procedures in package `DBMS_XDB_REPOS` are similar in their use. Each can be used with either XML schema-based or non-schema-based metadata. Some forms (signatures) of some of the procedures apply only to schema-based metadata. Procedures `appendResourceMetadata` and `deleteResourceMetadata` are illustrated here with examples.

See Also:

Oracle Database PL/SQL Packages and Types Reference for information about the procedures in PL/SQL package `DBMS_XDB_REPOS`

29.3.1 Adding Metadata Using APPENDRESOURCEMETADATA

You can use procedure `DBMS_XDB_REPOS.appendResourceMetadata` to add user-defined metadata to resources.

[Example 29-3](#) (page 29-6) creates a photo resource and adds XML schema-based metadata of type `ImgTechMetadata` to it, recording the technical information about the photo.

[Example 29-4](#) (page 29-6) adds metadata of type `ImgTechMetadata` to the same resource as [Example 29-3](#) (page 29-6), placing the photo in several user-defined content categories.

Example 29-3 Add Metadata to a Resource – Technical Photo Information

```
DECLARE
    returnbool BOOLEAN;
BEGIN
    returnbool := DBMS_XDB_REPOS.createResource(
        '/public/horse_with_pig.jpg',
        bfilename('MYDIR', 'horse_with_pig.jpg'));
    DBMS_XDB_REPOS.appendResourceMetadata(
        '/public/horse_with_pig.jpg',
        XMLType('<i:ImgTechMetadata
                xmlns:i="inamespace"
                xmlns:xsi="http://www.w3.org/2001/XMLSchema-instance"
                xsi:schemaLocation="inamespace imagetechnique.xsd">
                <Height>1024</Height>
                <Width>768</Width>
                <ColorDepth>24</ColorDepth>
                <Title>Pig Riding Horse</Title>
                <Description>Picture of a pig riding a horse on the beach,
taken outside hotel window.</Description>
                </i:ImgTechMetadata>'));
END;
/
```

Example 29-4 Add Metadata to a Resource – Photo Content Categories

```
BEGIN
    DBMS_XDB_REPOS.appendResourceMetadata(
        '/public/horse_with_pig.jpg',
        XMLType('<c:ImgCatMetadata
                xmlns:c="cnamespace"
                xmlns:xsi="http://www.w3.org/2001/XMLSchema-instance"
                xsi:schemaLocation="cnamespace imagecategories.xsd">
                <Categories>
                <Category>Vacation</Category>
                <Category>Animals</Category>
                <Category>Humor</Category>
                <Category>2005</Category>
                </Categories>
                </c:ImgCatMetadata>'));
END;
/
```

PL/SQL procedure successfully completed.

```
SELECT * FROM imgcatmetadatatable;
```

```
SYS_NC_ROWINFO$
```

```
-----
<c:ImgCatMetadata xmlns:c="cnamespace" xmlns:xsi="http://www.w3.org/2001/XMLSchema-instance" xsi:schemaLocation="cnamespace imagecategories.xsd">
  <Categories>
    <Category>Vacation</Category>
    <Category>Animals</Category>
    <Category>Humor</Category>
    <Category>2005</Category>
  </Categories>
</c:ImgCatMetadata>
```

1 row selected.

29.3.2 Deleting Metadata Using DELETERESOURCEMETADATA

You can use procedure `DBMS_XDB_REPOS.deleteResourceMetadata` to delete specific metadata associated with a resource. To delete *all* of the metadata associated with a resource, you can use procedure `DBMS_XDB_REPOS.purgeResourceMetadata`.

[Example 29-5](#) (page 29-7) deletes the category metadata that was added to the photo resource in [Example 29-4](#) (page 29-6). By default, both the resource link (REF) to the metadata and the metadata table identified by that link are deleted. An optional parameter can be used to specify that only the link is to be deleted. The metadata table is then left as is but becomes unrelated to the resource. In this example, the default behavior is used.

Example 29-5 Delete Specific Metadata from a Resource

```
BEGIN
  DBMS_XDB_REPOS.deleteResourceMetadata('/public/horse_with_pig.jpg',
                                         'cnamespace',
                                         'ImgCatMetadata');
END;
```

PL/SQL procedure successfully completed.

```
SELECT * FROM imgcatmetadatatable;
```

no rows selected

29.3.3 Adding Metadata Using SQL DML

An alternative to using procedure `DBMS_XDB_REPOS.appendResourceMetadata` to add, update, or delete resource metadata is to update the `RESOURCE_VIEW` directly using DML statements `INSERT` and `UPDATE`.

Adding resource metadata in this way is illustrated by [Example 29-6](#) (page 29-7). It shows how to accomplish the same thing as [Example 29-3](#) (page 29-6) by inserting the metadata directly into `RESOURCE_VIEW` using SQL statement `UPDATE`. Other SQL DML statements may be used similarly.

Example 29-6 Adding Metadata to a Resource Using DML with RESOURCE_VIEW

```
UPDATE RESOURCE_VIEW
  SET RES =
    insertChildXML(
      RES,
      '/r:Resource',
      'c:ImgCatMetadata',
```

```

XMLType('<c:ImgCatMetadata
      xmlns:c="cnamespace"
      xmlns:xsi="http://www.w3.org/2001/XMLSchema-instance"
      xsi:schemaLocation="cnamespace imagecategories.xsd">
    <Categories>
      <Category>Vacation</Category>
      <Category>Animals</Category>
      <Category>Humor</Category>
      <Category>2005</Category>
    </Categories>
  </c:ImgCatMetadata>'),
  'xmlns:r="http://xmlns.oracle.com/xdb/XDBResource.xsd"
  xmlns:c="cnamespace"')
WHERE equals_path(RES, '/public/horse_with_pig.jpg') = 1;
/

SELECT * FROM imgcatmetadatatable;

SYS_NC_ROWINFO$
-----
<c:ImgCatMetadata xmlns:c="cnamespace" xmlns:xsi="http://www.w3.org/2001/XMLSche
ma-instance" xsi:schemaLocation="cnamespace imagecategories.xsd">
  <Categories>
    <Category>Vacation</Category>
    <Category>Animals</Category>
    <Category>Humor</Category>
    <Category>2005</Category>
  </Categories>
</c:ImgCatMetadata>

1 row selected.

```

The following query extracts the inserted metadata using RESOURCE_VIEW, rather than directly using metadata table imgcatmetadatatable. (The result is shown here pretty-printed, for clarity.)

```

SELECT XMLQuery('declare namespace r
      = "http://xmlns.oracle.com/xdb/XDBResource.xsd"; (: :)
      declare namespace c
      = "cnamespace"; (: :)
      /r:Resource/c:ImgCatMetadata'
      PASSING RES RETURNING CONTENT)
FROM RESOURCE_VIEW
WHERE equals_path(RES, '/public/horse_with_pig.jpg') = 1;

XMLQUERY('DECLARENAMESPACE="HTTP://XMLNS.ORACLE.COM/XDB/XDBRESOURCE.XSD"; (: :)DE
-----
<c:ImgCatMetadata xmlns:c="cnamespace"
      xmlns:xsi="http://www.w3.org/2001/XMLSchema-instance"
      xsi:schemaLocation="cnamespace imagecategories.xsd">
  <Categories>
    <Category>Vacation</Category>
    <Category>Animals</Category>
    <Category>Humor</Category>
    <Category>2005</Category>
  </Categories>
</c:ImgCatMetadata>

1 row selected.

```

29.3.4 Adding Metadata Using WebDAV PROPPATCH

An alternative to using procedure `DBMS_XDB_REPOS.appendResourceMetadata` to add resource metadata is to use WebDAV method `PROPPATCH`.

This is illustrated in [Example 29-7](#) (page 29-9). You can update and delete metadata similarly.

[Example 29-7](#) (page 29-9) shows how to accomplish the same thing as [Example 29-4](#) (page 29-6) by inserting the metadata using WebDAV method `PROPPATCH`. Using appropriate tools, your application creates such a `PROPPATCH` WebDAV request and sends it to the WebDAV server for processing.

To update user-defined metadata, you proceed in the same way. To *delete* user-defined metadata, the WebDAV request is similar, but it has `D:remove` in place of `D:set`.

Example 29-7 Adding Metadata Using WebDAV PROPPATCH

```
PROPPATCH /public/horse_with_pig.jpg HTTP/1.1
Host: www.example.com
Content-Type: text/xml; charset="utf-8"
Content-Length: 609
Authorization: Basic dGRhZHhkYl9tZXRhOnRkYWYWR4ZGJfbWV0YQ==
Connection: close

<?xml version="1.0" encoding="utf-8" ?>
<D:propertyupdate xmlns:D="DAV:" xmlns:Z="http://www.w3.com/standards/z39.50/">
  <D:set>
    <D:prop>
      <c:ImgCatMetadata
        xmlns:c="cnamespace"
        xmlns:xsi="http://www.w3.org/2001/XMLSchema-instance"
        xsi:schemaLocation="cnamespace imagecategories.xsd">
        <Categories>
          <Category>Vacation</Category>
          <Category>Animals</Category>
          <Category>Humor</Category>
          <Category>2005</Category>
        </Categories>
      </c:ImgCatMetadata>
    </D:prop>
  </D:set>
</D:propertyupdate>
```

29.4 Querying XML Schema-Based Resource Metadata

You can use metadata column `RESID` when querying resource metadata, to join the metadata with the associated data.

When you register an XML schema using the `enableHierarchy` value `ENABLE_HIERARCHY_RESMETADATA`, an additional column, `RESID`, is added automatically to the `XMLType` tables used to store the metadata. This column stores the object identifier (OID) of the resource associated with the metadata. You can use column `RESID` when querying metadata, to join the metadata with the associated data.

You can query metadata in these ways:

- Query `RESOURCE_VIEW` for the metadata. For example:

```

SELECT count(*) FROM RESOURCE_VIEW
WHERE
  XMLExists(
    'declare namespace r
     = "http://xmlns.oracle.com/xdb/XDBResource.xsd"; (: :)
    declare namespace c
     = "cnamespace"; (: :)
    /r:Resource/c:ImgCatMetadata/Categories/Category[text()="Vacation"]'
    PASSING RES);

COUNT(*)
-----
1

1 row selected.

```

- Query the XML schema-based table for the user-defined metadata directly, and join this metadata back to the resource table, identifying which resource to select. Use column RESID of the metadata table to do this. For example:

```

SELECT COUNT(*) FROM RESOURCE_VIEW rs, imgcatmetadatatable ct
WHERE
  XMLExists(
    'declare namespace r
     = "http://xmlns.oracle.com/xdb/XDBResource.xsd"; (: :)
    declare namespace c
     = "cnamespace"; (: :)
    /r:Resource/c:ImgCatMetadata/Categories/Category'
    PASSING RES)
  AND rs.RESID = ct.RESID;

COUNT(*)
-----
1

1 row selected.

```

Oracle recommends querying for user-defined metadata directly, for performance reasons. Direct queries of the RESOURCE_VIEW alone *cannot be optimized* using XPath rewrite, because there is no way to determine whether or not target elements like Category are stored in the CLOB value or in an out-of-line table.

To improve performance further, create an index on each metadata column you intend to query.

[Example 29-8](#) (page 29-10) queries both kinds of photo resource metadata, retrieving the paths to the resources that are categorized as vacation photos and have the title "Pig Riding Horse".

Example 29-8 Query XML Schema-Based Resource Metadata

```

SELECT ANY_PATH
FROM RESOURCE_VIEW rs, imgcatmetadatatable ct, imgtechmetadatatable tt
WHERE XMLExists(
  'declare namespace r
   = "http://xmlns.oracle.com/xdb/XDBResource.xsd"; (: :)
  declare namespace c
   = "cnamespace"; (: :)
  /r:Resource/c:ImgCatMetadata/Categories/Category[text()="Vacation"]'
  PASSING RES)
AND XMLExists(
  'declare namespace r
   = "http://xmlns.oracle.com/xdb/XDBResource.xsd"; (: :)
  declare namespace i

```

```

        = "inamespace"; (: :)
        /r:Resource/i:ImgTechMetadata/Title[text()='Pig Riding Horse']'
    PASSING RES)
    AND rs.RESID = ct.RESID
    AND rs.RESID = tt.RESID;

ANY_PATH
-----
/public/horse_with_pig.jpg

1 row selected.

```

29.5 XML Image Metadata from Binary Image Metadata

Digital cameras include image metadata as part of the image files they produce. Oracle Multimedia provides tools for extracting and converting this binary metadata to XML. Oracle Multimedia XML schemas are automatically registered with Oracle XML DB Repository, to convert binary image metadata of various kinds to XML data.

- EXIF – Exchangeable Image File Format
- IPTC-NAA IIM – International Press Telecommunications Council-Newspaper Association of America Information Interchange Model
- XMP – Extensible Metadata Platform

EXIF is the metadata standard for digital still cameras. EXIF metadata is stored in TIFF and JPEG image files. IPTC and XMP metadata is commonly embedded in image files by desktop image-processing software.

See Also:

- *Oracle Multimedia User's Guide* for information about working with digital image metadata, including examples of extracting binary image metadata and converting it to XML
 - *Oracle Multimedia Reference* for information about the XML schemas supported by Oracle Multimedia for use with image metadata
-

29.6 Adding Non-Schema-Based Resource Metadata

You store user-defined resource metadata that is *not* XML Schema-based as a CLOB instance under the `Resource` element of the associated resource.

The default XML schema for a resource has a top-level element **any** (declared with `maxOccurs= "unbounded"`), which admits any valid XML data as part of the resource document in the resource table, `XDB.XDB$RESOURCE`.

The following skeleton shows the structure and position of non-schema-based resource metadata:

```

<Resource xmlns="http://xmlns.oracle.com/xdb/XDBResource.xsd"
  <Owner>DESELBY</Owner>
  ... <!-- other system-defined metadata -->
  <!-- contents of the resource>
  <Contents>
    ...
  </Contents>
  <!-- User-defined metadata (appearing within different namespace) -->

```

```

    <MyOwnMetadata xmlns="http://www.example.com/custommetadata">
      <MyElement1>value1</MyElement1>
      <MyElement2>value2</MyElement2>
    </MyOwnMetadata>
  </Resource>

```

You can set and access non-schema-based resource metadata belonging to namespaces other than `XDBResource.xsd` by using any of the means described previously for accessing XML schema-based resource metadata.

[Example 29-9](#) (page 29-12) illustrates this for the case of SQL DML operations, adding user-defined metadata directly to the `<RESOURCE>` document. It shows how to add non-schema-based metadata to a resource using SQL DML.

Example 29-9 Add Non-Schema-Based Metadata to a Resource

```

DECLARE
  res BOOLEAN;
BEGIN
  res := DBMS_XDB_REPOS.createResource(
    '/public/NurseryRhyme.txt',
    bfilename('MYDIR',
      'tdadxdb-xdb_repos_meta-011.txt'),
    nls_charset_id('AL32UTF8'));
UPDATE RESOURCE_VIEW
  SET RES = insertChildXML(RES,
    '/r:Resource',
    'n:NurseryMetadata',
    XMLType('<n:NurseryMetadata xmlns:n="nurserynamespace">
      <Author>Mother Goose</Author>
      <n:NurseryMetadata>'),
    'xmlns:r="http://xmlns.oracle.com/xdb/XDBResource.xsd"
    xmlns:n="nurserynamespace"')
  WHERE equals_path(RES, '/public/NurseryRhyme.txt') = 1;
END;
/

```

PL/SQL procedure successfully completed.

```

SELECT XMLSerialize(DOCUMENT rs.RES AS CLOB) FROM RESOURCE_VIEW rs
  WHERE equals_path(RES, '/public/NurseryRhyme.txt') = 1;

```

```

XMLSERIALIZE(DOCUMENTRS.RESASCLOB)

```

```

-----
<Resource xmlns="http://xmlns.oracle.com/xdb/XDBResource.xsd" Hidden="false" Invalid="false" Container="false" CustomRslv="false" VersionHistory="false" StickyRef="true">
  <CreationDate>2005-05-24T13:51:48.043234</CreationDate>
  <ModificationDate>2005-05-24T13:51:48.290144</ModificationDate>
  <DisplayName>NurseryRhyme.txt</DisplayName>
  <Language>en-US</Language>
  <CharacterSet>UTF-8</CharacterSet>
  <ContentType>text/plain</ContentType>
  <RefCount>1</RefCount>
  <ACL>
    <acl description="Public:All privileges to PUBLIC" xmlns="http://xmlns.oracle.com/xdb/acl.xsd" xmlns:xsi="http://www.w3.org/2001/XMLSchema-instance" xsi:schemaLocation="http://xmlns.oracle.com/xdb/acl.xsd http://xmlns.oracle.com/xdb/acl.xsd" shared="true">
      <ace>
        <principal>PUBLIC</principal>

```



```

        <grant>true</grant>
        <privilege>
          <all/>
        </privilege>
      </ace>
    </acl>
  </ACL>
  <Owner>TDADXDB_META</Owner>
  <Creator>TDADXDB_META</Creator>
  <LastModifier>TDADXDB_META</LastModifier>
  <SchemaElement>http://xmlns.oracle.com/xdb/XDBSchema.xsd#text</SchemaElement>
  <Contents>
    <text>Mary had a little lamb
Its fleece was white as snow
and everywhere that Mary went
that lamb was sure to go
</text>
  </Contents>
  <n:NurseryMetadata xmlns:n="nurserynamespace">
    <Author xmlns="">Mother Goose</Author>
  </n:NurseryMetadata>
</Resource>

```

1 row selected.

29.7 PL/SQL Procedures Affecting Resource Metadata

You can use PL/SQL procedures `DBMS_XMLSCHEMA.registerSchema`, `DBMS_XDBZ.enable_hierarchy`, `DBMS_XDBZ.disable_hierarchy`, `DBMS_XDBZ.is_hierarchy_enabled`, `DBMS_XDB_REPOS.appendResourceMetadata`, `DBMS_XDB_REPOS.deleteResourceMetadata`, `DBMS_XDB_REPOS.purgeResourceMetadata`, and `DBMS_XDB_REPOS.updateResourceMetadata` to perform resource metadata operations.

- `DBMS_XMLSCHEMA.registerSchema` – Register an XML schema. Parameter `ENABLEHIERARCHY` affects resource metadata.
- `DBMS_XDBZ.enable_hierarchy` – Enable repository support for an XMLType table or view. Use parameter `HIERARCHY_TYPE` with a value of `DBMS_XDBZ.ENABLE_HIERARCHY_RESMETADATA` to enable resource metadata. This adds column `RESID` to track the resource associated with the metadata.
- `DBMS_XDBZ.disable_hierarchy` – Disable all repository support for an XMLType table or view.
- `DBMS_XDBZ.is_hierarchy_enabled` – Tests, using parameter `HIERARCHY_TYPE`, whether the specified type of hierarchy is currently enabled for the specified XMLType table or view. Value `DBMS_XDBZ.IS_ENABLED_RESMETADATA` for `HIERARCHY_TYPE` tests whether resource metadata is enabled.
- `DBMS_XDB_REPOS.appendResourceMetadata` – Add metadata to a resource.
- `DBMS_XDB_REPOS.deleteResourceMetadata` – Delete specified metadata from a resource.

- `DBMS_XDB_REPOS.purgeResourceMetadata` – Delete all user-defined metadata from a resource. For schema-based resources, optional parameter `DELETE_OPTION` can be used to specify whether or not to delete the metadata information, in addition to unlinking it.
- `DBMS_XDB_REPOS.updateResourceMetadata` – Update the metadata for a resource.

See Also:

Oracle Database PL/SQL Packages and Types Reference for detailed information about these PL/SQL procedures

Oracle XML DB Repository Events

You can use Oracle XML DB Repository to store and access data of any kind, in the form of repository resources. You can access repository data from any application. Sometimes your application needs to perform certain actions whenever a particular repository operation occurs. You can do this using repository events.

- [Overview of Repository Events](#) (page 30-1)
- [Possible Repository Events](#) (page 30-3)
- [Repository Operations and Events](#) (page 30-6)
- [Repository Event Handler Considerations](#) (page 30-7)
- [Configuration of Repository Events](#) (page 30-9)

See Also:

[Configuration of Oracle XML DB Repository](#) (page 22-1) for general information about configuring repository resources

30.1 Overview of Repository Events

Your application can perform specific actions when events associated with repository operations occur. For example, you might want to perform a move-to-wastebasket or another backup action whenever a resource is deleted.

Repository resource operations include creating, deleting, locking, unlocking, rendering, linking, unlinking, placing under version control, checking in, checking out, unchecking out (reverting a checked out version), opening, and updating.

30.1.1 Repository Events: Use Cases

Examples of cases where you can use repository events include moving a resource to a wastebasket and categorizing a resource based on its MIME type.

- *Wastebasket* – You can use an UnLink pre-event handler to effectively move a resource to a wastebasket instead of deleting it. Create a link in a wastebasket folder before removing the original link. The link in the wastebasket ensures that the resource is not removed. When you subsequently undelete a resource from the waste basket, the original link can be created again and the wastebasket link removed. The wastebasket link name can be different from the name of the link being removed because a resource at a certain path could be unlinked more than once from that path. The wastebasket would then have multiple links corresponding to that path, with different link properties and possibly pointing to different resources.

- *Categorization* – An application might categorize the resources it manages based on MIME type or other properties. It might keep track of GIF, text, and XML files by maintaining links to them from repository folders `/my-app/gif`, `/my-app/txt`, and `/my-app/xml`. Three post-event handlers could be used here: `LinkIn`, `UnlinkIn`, and `Update`. The `LinkIn` post-event handler would examine the resource and create a link in the appropriate category folder, if not already present. The `UnlinkIn` post-event handler would remove the link from the category folder. The `Update` post-event handler would effectively move the resource from one category folder to another if its category changes.

30.1.2 Repository Events and Database Triggers

You cannot use a database trigger to let your application react to repository operations. A given repository operation can consist of multiple database operations on multiple underlying, internal tables. Because these underlying tables are internal to Oracle XML DB, you cannot easily map them to specific repository operations.

For example, internal table `XDB$H_INDEX` might be updated by either a database update operation, if an ACL is changed, or a link operation. Even in cases where you might be able to accomplish the same thing using database triggers, you would not want to do that: A repository event is a higher-level abstraction than would be a set of database triggers on the underlying tables.

When a repository event occurs, information associated with the operation, such as the resource path used, can be passed to the corresponding event handler. Such information is not readily available using database triggers.

Repository events and database triggers can both be applied to XML data. You can use triggers on `XMLType` tables, for instance. However, if an `XMLType` table is also a repository table (hierarchy-enabled), then do not duplicate in an event handler any trigger code that applies to the table. Otherwise, that code is executed twice.

30.1.3 Repository Event Listeners and Event Handlers

Each repository operation is associated with events. Your application can configure event listeners for particular resources or the entire repository. A listener can be restricted by a node-existence precondition. A listener is a set of PL/SQL or Java handlers, each of which processes a single event.

A repository **event listener** is a Java class or a PL/SQL package or object type. It comprises a set of PL/SQL procedures or Java methods, each of which is called an **event handler**.

You associate a repository event listener with a resource by mapping a **resource configuration file** to the resource. You use PL/SQL package `DBMS_RESCONFIG` to manipulate resource configuration files, including associating them with the resources they configure. In particular, PL/SQL function `DBMS_RESCONFIG.getListeners` lists all event listeners for a given resource.

30.1.4 Repository Event Configuration

Repository event configuration involves defining resource configuration files and defining the order in which they are processed. The files define event listeners. Such configuration applies to events on individual resources and events for the repository as a whole.

A given resource can be configured by multiple resource configuration files. These are stored in a **resource configuration list**, and they are processed in list order. Events for

the repository as a whole can also be configured by multiple resource configuration files. Similarly, the repository also has a resource configuration list. Event handling that is configured for the repository as a whole takes effect before any resource-specific event handling. All applicable repository-wide events are processed before any resource-specific events.

A given resource configuration file can define multiple event listeners for the resources it configures, and each event listener can define multiple event handlers.

See Also:

- [Configuration of Repository Events](#) (page 30-9)
 - [Resource Configuration Files](#) (page 22-1) for general information about resource configuration and resource configuration lists
-
-

30.2 Possible Repository Events

Repository operations are associated with predefined events. Except for a rendering operation, events come in pre and post pairs.

A rendering operation is associated with a single repository event. Except for rendering, all repository operations are associated with one or more *pairs* of events.

For example, a resource creation is associated with three pairs of events, with the events occurring in this order:

1. Pre-creation event
2. Post-creation event
3. Pre-link-in event
4. Pre-link-to event
5. Post-link-to event
6. Post-link-in event

[Table 30-1](#) (page 30-4) lists the events associated with each repository operation. Their order is indicated in the handler columns.

Table 30-1 Predefined Repository Events

Repository Event Type	Description	Pre Handler Execution	Post Handler Execution
Render	<p>A Render event occurs only for <i>file</i> resources, never for folder resources.</p> <p>Occurs when resource contents are accessed using any of the following:</p> <ul style="list-style-type: none"> • Protocols • XDBURIType methods <code>getCLOB()</code>, <code>getBLOB()</code>, and <code>getXML()</code> <p>Does <i>not</i> occur when resource contents are accessed using any of the following:</p> <ul style="list-style-type: none"> • <code>SELECT ... FROM RESOURCE_VIEW</code> • XDBURIType method <code>getResource()</code> <p>Only one handler for a Render event can set the rendered output. The first handler to call <code>setRenderStream</code> or <code>setRenderPath</code> controls the rendering.</p>	N/A	N/A
Create	Occurs when a resource is created. The pre and post handlers executed are those defined on the folder of the new resource.	After pre-parsing, after validating the parent resource ACL and locks, and before assigning default values to undefined properties.	After inserting the resource into the system resource table.
Delete	Occurs when the resource and its contents are removed from disk, that is, when the resource REF count is zero (0).	After validating the resource ACL and locks and before removing the resource from disk.	After removing the resource and its contents from disk and after touching the parent folder to update its last modifier and modification time.
Update	Occurs when a resource is updated on disk.	After validating the resource ACL and locks and before updating the last modifier and modification time.	After writing the resource to disk.
Lock	Occurs during a lock-resource operation.	After validating the resource ACL and locks and before creating the new lock on the resource.	After creating the new lock.
Unlock	Occurs during an unlock-resource operation.	After validating the resource ACL and delete token.	After removing the lock.

Table 30-1 (Cont.) Predefined Repository Events

Repository Event Type	Description	Pre Handler Execution	Post Handler Execution
LinkIn	Occurs before a LinkTo event during a link operation. The event target is the folder in which the link is created. Always accompanied by a LinkTo event.	After validating the resource ACL and locks and before creating the link.	After executing LinkTo post handler.
LinkTo	Occurs after a LinkIn event during a link operation. The event target is the resource that is the link destination.	After executing LinkIn pre handler and before creating the link.	After creating the link and after updating the last modifier and modification time of the parent folder.
UnLinkIn	Occurs before an UnlinkFrom event during an unlink operation. Always accompanied by an UnlinkFrom event.	After validating the resource ACL and locks and before removing the link.	After executing the UnlinkFrom post handler.
UnlinkFrom	Occurs after an UnlinkIn event during an unlink operation.	After executing the UnlinkIn pre handler.	After removing the link.
CheckIn	Occurs during check-in of a resource.	After validating the resource ACL and locks and after verifying that the resource is version-controlled and has been checked out.	After checking in the resource.
CheckOut	Occurs during check-out of a resource.	After validating the resource ACL and locks and after verifying that the resource is version-controlled and is not already checked out.	After checking out the resource.
UncheckOut	Occurs during uncheck-out of a resource.	Before removing the record that the resource is checked out.	After unchecking out the resource.
VersionControl	Occurs when a version history is created for a resource. Note: You can call <code>DBMS_XDB_VERSION.MakeVersioned()</code> multiple times, but the version history is created only at the first call. Subsequent calls have no effect, so no <code>VersionControl</code> event occurs.	Before creating the version history for the resource.	After creating the first version of the resource.

For simplicity, the documentation generally treats both members of a repository event pair together, referring, for example, to the `LinkIn` event type as shorthand for the pre-link-in and post-link-in event types. For the same reason, the event-type names used here are derived from the Java interface `XDBRepositoryEventListener` by dropping the prefixes `handlePre` and `handlePost`.

See Also:

Oracle Database PL/SQL Packages and Types Reference for the PL/SQL repository event types

30.3 Repository Operations and Events

The same repository event can occur with different Oracle XML DB Repository operations, and a given repository operation can produce more than one repository event.

[Table 30-2](#) (page 30-6) lists the events that are associated with each repository operation. See [Table 30-1](#) (page 30-4) for the event order when multiple repository events occur for the same operations.

Table 30-2 Oracle XML DB Repository Operations and Events

Operation	Repository Events Occurring
Get binary representation of resource contents by path name	Render
Get XML representation of resource contents by path name	Render
Create or update a resource	If the resource already exists: Create, LinkIn, LinkTo If resource does not yet exist (HTTP and FTP only): Update
Create a folder	Create, LinkIn, LinkTo
Create a link to an existing resource	LinkIn on the folder containing the link target, LinkTo on the target resource to be linked
Unlink a file resource or an empty folder resource. (Decrement RefCount, and if it becomes zero then delete the resource from disk.)	UnlinkIn, UnlinkFrom, and, if RefCount is zero, Delete
Forcibly delete a folder and its contents	Recursively produce events for unlinking a resource. Folder child resources are deleted recursively, then the folder is deleted.
Forcibly remove all links to a resource	Produce unlinking events for each link removed.
Update the contents, properties, or ACL of a resource by path name	Update
Put a depth-zero WebDAV lock on a resource	Lock
Remove a depth-zero WebDAV lock from a resource	Lock
Rename (move) a resource	LinkIn and LinkTo on the new location, UnlinkIn and UnlinkFrom on the old location
Copy a resource	Create, LinkIn, and LinkTo on the new location
Check out a resource	CheckOut
Check in a resource	CheckIn

Table 30-2 (Cont.) Oracle XML DB Repository Operations and Events

Operation	Repository Events Occurring
Place a resource under version control	VersionControl
Uncheck out a resource	UncheckOut

All operations listed in [Table 30-2](#) (page 30-6) are atomic, except for these:

- Forced deletion of a folder and its contents
- Update of resource properties by path name using HTTP (only)
- Copy of a folder using HTTP (only)

See Also:

[Table 21-3](#) (page 21-21) for information on accessing resources using APIs and protocols

30.4 Repository Event Handler Considerations

Some considerations are listed for defining handlers for Oracle XML DB Repository events.

- In any handler: Do not use COMMIT, ROLLBACK, or data definition language (DDL) statements in a handler. Do not call PL/SQL functions or procedures, such as `DBMS_XMLSCHEMA.registerSchema`, that behave similarly to DDL statements. In a Render handler: Do not use data manipulation language (DML) statements.

To work around these restrictions, a handler can use such statements inside an autonomous transaction, but it must ensure that lock conflicts cannot arise.

- In a Render handler, do not close an output stream. (You can append to a stream.)
- Do *not* use modifier methods from class `XDBResource` in a handler, unless it is a Pre-Create or Pre-Update handler. Do *not* use method `XDBResource.save()` in any handler.
- Oracle recommends that you develop only safe repository event handlers. In particular:
 - Write only resource properties that are in namespaces owned by your application, never in the `xdb` namespace.
 - Do not delete a resource while it is being created.
- A repository event handler is passed an `XDBRepositoryEvent` object, which exists only during the current SQL statement or protocol operation. You can use PL/SQL procedures and Java methods on this object to obtain information about the resource, the event, and the associated event handlers.
- When an event handler performs operations that cause other repository events to occur, those cascading events occur immediately. They are not queued to occur

after the handlers for the current event are finished. Each event thus occurs in the context of its corresponding operation.

- Repository event handlers are called synchronously. They are executed in the process, session, and transaction context of the corresponding operation. However, handlers can use Oracle Streams Advanced Queuing (AQ) to queue repository events that are then handled asynchronously by some other process.
- Because a repository event handler is executed in the transaction context of its corresponding operation, any locks acquired by that operation, or by other operations run previously in the transaction, are still active. An event handler must not start a separate session or transaction that tries to acquire such a lock. Otherwise, the handler hangs.
- Repository event handlers are called in the order that they appear in a resource configuration file. If preconditions are defined for a resource configuration, then only those handlers are called for which the precondition is satisfied.
- Although handlers are called in the order they are defined in a configuration file, avoid letting your code depend upon this. If the user who is current when a handler is invoked has privilege `write-config`, then the handler invocation order could be changed inside an executing handler.
- The entire list of handlers applicable to a given repository event occurrence is determined before any of the handlers is invoked. This means, in particular, that the precondition for each handler is evaluated before any handlers are invoked.
- The following considerations apply to *error handling* for repository events:
 - A pre-operation event handler is never invoked if access checks for the operation fail.
 - All handlers for a given event are checked before any of them are called. If any of them is not usable (for example, no longer exists), then *none* of them are called.
 - If an error is raised during event handling, then other, subsequent event handlers are not invoked for the same SQL statement or protocol operation. The current statement or operation is canceled and all of its changes are rolled back.
- The following considerations apply to *resource security* for repository events:
 - An event handler can have invoker's rights or definer rights. You specify the execution rights of a PL/SQL package when you create the package. You specify the execution rights of Java classes when you load them into the database using the `loadjava` utility. If you specify invoker's rights, but a given handler is not configured for invoker's rights, then an insufficient-privilege error is raised.
 - Within an event handler, the current user privileges, whether obtained by invoker or definer rights, are determined in detail for a given resource by its ACL. These privileges determine what the handler can do with the resource. For example, if the current user has privileges `read-properties` and `read-contents` for a particular resource, then an event handler can read that resource.
- The following considerations apply to repository events for *linking* and *unlinking*:

- After creating a link to a resource, if you want any resource configuration files of the parent folder to also apply to the linked resource, then use procedure `DBMS_RESCONFIG.appendResConfig` to add the configuration files to the linked resource. You can invoke this procedure from a `Post-LinkTo` event handler for the linked resource.
- After unlinking a resource, if you want to remove any such resource configuration files added when linking, then use procedure `DBMS_RESCONFIG.deleteResConfig` to remove them from the unlinked resource. You can invoke this procedure from a `Post-UnlinkFrom` event handler for the unlinked resource.
- Do not define handlers for events on folder `/sys/schemas` or on resources under this folder. Events do not occur for any such resources, so such event handlers are ignored. This implies that XML schema operations that affect the repository (registration, deletion, and so on) do not produce events.

See Also:

- *Oracle Database PL/SQL Packages and Types Reference* for information about PL/SQL functions and procedures for manipulating repository events
 - *Oracle Database XML Java API Reference*, classes `XDBRepositoryEvent` and `XDBEvent` for information about Java methods for manipulating repository events
 - [Configuration of Repository Events](#) (page 30-9) for information about defining repository event handlers with invoker's rights
-
-

30.5 Configuration of Repository Events

In a resource configuration file, you use element `event-listeners`, child of element `ResConfig`, to configure Oracle XML DB Repository event handling.

You configure event treatment for Oracle XML DB Repository resources as you would configure any other treatment of repository resources — see "[Configuring a Resource](#) (page 22-2)".

By default, repository events are enabled, but you can disable them by setting parameter `XML_DB_EVENTS` to `DISABLE`. To disable repository events at the session level, use the following SQL*Plus command. You must have role `XDBADMIN` to do this.

```
ALTER SESSION SET XML_DB_EVENTS = DISABLE;
```

To disable repository events at the system level, use the following SQL*Plus command, and then restart your database. Repository events are disabled for subsequent sessions. You must have privilege `ALTER SYSTEM` to do this.

```
ALTER SYSTEM SET XML_DB_EVENTS = DISABLE;
```

To enable repository events again, set the value of `XML_DB_EVENTS` to `ENABLE`.

A resource configuration file is an XML file that conforms to the XML schema `XDBResConfig.xsd`, which is accessible in Oracle XML DB Repository at path `/sys/schemas/PUBLIC/xmlns.oracle.com/xdm/XDBResConfig.xsd`. You use element `event-listeners`, child of element `ResConfig`, to configure repository event handling.

See Also:

[Configuration of Oracle XML DB Repository](#) (page 22-1) for general information about configuring repository resources

30.5.1 Configuration Element event-listeners

Each resource configuration file can have one `event-listeners` element, as a child of element `ResConfig`. This configures all event handling for the target resource. If the resource configuration file applies to the entire repository, not to a particular resource, then it defines event handling for all resources in the repository.

Element `event-listeners` has the following optional attributes:

- `set-invoker` – Set this to `true` to if the resource configuration defines one or more repository event handlers to have invoker's rights. The default value is `false`, meaning that definer rights are used.

To define an invoker-rights repository event handler, you must have database role `XDB_SET_INVOKER`. This role is granted to `DBA`, but not to `XDBADMIN`. Role `XDB_SET_INVOKER` is checked only when a resource configuration file is created or updated. Only attribute `set-invoker`, not role `XDB_SET_INVOKER`, is checked at run time to ensure sufficient privilege.

See Also:

[Repository Event Handler Considerations](#) (page 30-7) for information about insufficient-privilege errors

- `default-schema` – The default schema value, used for listeners for which no schema element is defined.
- `default-language` – The default language value, used for listeners for which no language element is defined.

Element `event-listeners` has a sequence of `listener` elements as children. These configure individual repository event listeners. The listeners are processed at run time in the order of the `listener` elements.

30.5.2 Configuration Element listener

Element `listener` is a child of element `event-listeners`, and it configures an individual repository event listener.

Each `listener` element has the following child elements. All of these are optional except `source`, and they can appear in any order (their order is irrelevant).

- `description` – Description of the listener.
- `schema` – Database schema for the Java or PL/SQL implementation of the repository event handlers. If neither this nor `default-schema` is defined, then an error is raised.
- `source` (required) – Name of the Java class, PL/SQL package, or object type that provides the handler methods. Java class names must be qualified with a package

name. Use an empty `source` element to indicate that the repository event handlers are standalone PL/SQL stored procedures.

- `language` – Implementation language of the listener class (Java) or package (PL/SQL). If neither this nor `default-language` is defined, then an error is raised.
- `pre-condition` – Precondition to be met for any repository event handlers in this listener to be executed. This is identical to the `pre-condition` child of general resource configuration element `configuration` – see [Configuration Elements defaultChildConfig and configuration](#) (page 22-4).
- `events` – Sequence of unique repository event type names: `Render`, `Pre-Create`, and so on. Only handlers for repository events of these types are enabled for the listener. See [Possible Repository Events](#) (page 30-3) for the list of possible repository event types. If element `events` is not present, then handlers of repository events of all types are enabled for the listener, which can be wasteful. Provide element `events` to eliminate handler invocations for insignificant repository events.

30.5.3 Repository Events Configuration Examples

Examples of configuring repository events are presented. Resource configuration files define Java and PL/SQL event listeners, with and without preconditions, respectively. An example categorizes resources according to MIME type. It includes PL/SQL code to create the resource configuration file. Examples implement listeners in Java and PL/SQL.

[Example 30-1](#) (page 30-12) shows the content of a resource configuration file that defines two event listeners. Each listener defines handlers for repository events of types `Post-LinkIn`, `Post-UnlinkIn`, and `Post-Update`. It defines preconditions, the default language (Java), and the default database schema.

The implementation of the handlers of the first listener is in Java class `oracle.cm.quota` defined in database schema `CM`. These handlers are invoked only for events on resources of Content Type `image/gif`.

The implementation of the handlers of the second listener is in Java class `oracle.ifs.quota` defined in database schema `IFS` (the default schema for this resource configuration file). These handlers are invoked only for events on resources of type `ifs-file` in namespace `http://foo.xsd`.

See Also:

[Configuration Elements defaultChildConfig and configuration](#) (page 22-4) for a description of elements `defaultChildConfig` and `applicationData`

As a simple end-to-end illustration, suppose that an application needs to categorize the resources in folder `/public/res-app` according to their MIME types. It creates links to resources in folders `/public/app/XML-TXT`, `/public/app/IMG`, and `/public/app/FOLDER`, depending on whether the resource MIME type is `text/xml`, `image/gif`, or `application/octet-stream`, respectively. This is illustrated in [Example 30-2](#) (page 30-13), [Example 30-3](#) (page 30-14), and [Example 30-5](#) (page 30-17).

[Example 30-2](#) (page 30-13) shows the PL/SQL code to create the configuration file for this categorization illustration. It defines a single listener that handles events of types

Pre-`UnlinkIn` and `Post-LinkIn`. It explicitly defines the language (PL/SQL) and database schema. No preconditions are defined.

[Example 30-3](#) (page 30-14) shows the PL/SQL code that implements the event handlers that are configured in [Example 30-2](#) (page 30-13). The `Post-LinkIn` event handler creates a link to the `eventObject` resource in one of the folders `/public/app/XML-TXT`, `/public/app/IMG`, and `/public/app/FOLDER`, depending on the resource MIME type. The `Pre-UnlinkIn` event handler deletes the links that are created by the `Post-LinkIn` event handler.

See Also:

- *Oracle Database PL/SQL Packages and Types Reference* for information about PL/SQL package `DBMS_XDBRESOURCE`
 - *Oracle Database PL/SQL Packages and Types Reference* for information about PL/SQL package `DBMS_XEVEN`
 - *Oracle Database PL/SQL Packages and Types Reference* for information about PL/SQL package `DBMS_XDB_REPOS`
-
-

A Java example would be configured the same as in [Example 30-2](#) (page 30-13), with the exception of these two lines, which would replace the elements with the same names in [Example 30-2](#) (page 30-13):

```
<source>category</source>
<language>Java</language>
```

[Example 30-4](#) (page 30-15) shows the Java code that implements the event handlers. The logic is identical to that in [Example 30-3](#) (page 30-14).

[Example 30-5](#) (page 30-17) demonstrates the invocation of the event handlers that are implemented in [Example 30-3](#) (page 30-14) or [Example 30-4](#) (page 30-15).

Example 30-1 Resource Configuration File for Java Event Listeners with Preconditions

```
<ResConfig xmlns="http://xmlns.oracle.com/xdb/XDBResConfig.xsd"
  xmlns:xsi="http://www.w3.org/2001/XMLSchema-instance"
  xsi:schemaLocation="http://xmlns.oracle.com/xdb/XDBResConfig.xsd
    http://xmlns.oracle.com/xdb/XDBResConfig.xsd">
  <event-listeners default-language="Java" default-schema="IFS">
    <listener>
      <description>Category application</description>
      <schema>CM</schema>
      <source>oracle.cm.category</source>
      <events>
        <Post-LinkIn/>
        <Post-UnlinkIn/>
        <Post-Update/>
      </events>
      <pre-condition>
        <existsNode>
          <XPath>/Resource[ContentType="image/gif"]</XPath>
        </existsNode>
      </pre-condition>
    </listener>
    <listener>
      <description>Check quota</description>
```

```

<source>oracle.ifs.quota</source>
<events>
  <Post-LinkIn/>
  <Post-UnlinkIn/>
  <Post-Update/>
</events>
<pre-condition>
  <existsNode>
    <XPath>r:/Resource/[ns:type="ifs-file"]</XPath>
    <namespace>xmlns:r="http://xmlns.oracle.com/xdb/XDBResource.xsd"
      xmlns:ns="http://foo.xsd"
    </namespace>
  </existsNode>
</pre-condition>
</listener>
</event-listeners>
<defaultChildConfig>
  <configuration>
    <path>/sys/xdb/resconfig/user_rc.xml</path>
  </configuration>
</defaultChildConfig>
<applicationData>
  <foo:data xmlns:foo="http://foo.xsd">
    <foo:item1>1234</foo:item1>
  </foo:data>
</applicationData>
</ResConfig>

```

Example 30-2 Resource Configuration File for PL/SQL Event Listeners with No Preconditions

```

DECLARE
  b BOOLEAN := FALSE;
BEGIN
  b := DBMS_XDB_REPOS.createFolder('/public/resconfig');
  b := DBMS_XDB_REPOS.createResource(
    '/public/resconfig/appcatg-rc1.xml',
    '<ResConfig xmlns="http://xmlns.oracle.com/xdb/XDBResConfig.xsd"
      xmlns:xsi="http://www.w3.org/2001/XMLSchema-instance"
      xsi:schemaLocation="http://xmlns.oracle.com/xdb/XDBResConfig.xsd
        http://xmlns.oracle.com/xdb/XDBResConfig.xsd">
<event-listeners>
  <listener>
    <description>Category application</description>
    <schema>APPCATGUSER1</schema>
    <source>APPCATG_EVT_PKG1</source>
    <language>PL/SQL</language>
    <events>
      <Pre-UnlinkIn/>
      <Post-LinkIn/>
    </events>
  </listener>
</event-listeners>
<defaultChildConfig>
  <configuration>
    <path>/public/resconfig/appcatg-rc1.xml</path>
  </configuration>
</defaultChildConfig>
</ResConfig>',
    'http://xmlns.oracle.com/xdb/XDBResConfig.xsd',
    'ResConfig');
END;

```

```

/
BEGIN
  DBMS_RESCONFIG.appendResConfig('/public/res-app',
                                '/public/resconfig/appcatg-rc1.xml',
                                DBMS_RESCONFIG.APPEND_RECURSIVE);
END;
/

```

Example 30-3 PL/SQL Code Implementing Event Listeners

```

CREATE OR REPLACE PACKAGE appcatg_evt_pkg1 AS

  PROCEDURE handlePreUnlinkIn (eventObject DBMS_XEVENT.XDBRepositoryEvent);
  PROCEDURE handlePostLinkIn (eventObject DBMS_XEVENT.XDBRepositoryEvent);

END;
/
CREATE OR REPLACE PACKAGE BODY appcatg_evt_pkg1 AS

  PROCEDURE handlePreUnlinkIn (eventObject DBMS_XEVENT.XDBRepositoryEvent) AS
    XDBResourceObj DBMS_XDBRESOURCE.XDBResource;
    ResDisplayName VARCHAR2(100);
    ResPath        VARCHAR2(1000);
    ResOwner       VARCHAR2(1000);
    ResDeletedBy   VARCHAR2(1000);
    XDBPathobj     DBMS_XEVENT.XDBPath;
    XDBEventobj    DBMS_XEVENT.XDBEvent;
    SeqChar        VARCHAR2(1000);
    LinkName       VARCHAR2(10000);
    ResType        VARCHAR2(100);
    LinkFolder     VARCHAR2(100);
  BEGIN
    XDBResourceObj := DBMS_XEVENT.getResource(eventObject);
    ResDisplayName := DBMS_XDBRESOURCE.getDisplayName(XDBResourceObj);
    ResOwner       := DBMS_XDBRESOURCE.getOwner(XDBResourceObj);
    XDBPathobj     := DBMS_XEVENT.getPath(eventObject);
    ResPath        := DBMS_XEVENT.getName(XDBPathobj);
    XDBEventobj    := DBMS_XEVENT.getXDBEvent(eventObject);
    ResDeletedBy   := DBMS_XEVENT.getCurrentUser(XDBEventobj);
    BEGIN
      SELECT XMLCast(
        XMLQuery(
          'declare namespace ns = "http://xmlns.oracle.com/xdb/XDBResource.xsd";
          /ns:Resource/ns:ContentType'
          PASSING r.RES RETURNING CONTENT) AS VARCHAR2(100))
        INTO ResType
        FROM PATH_VIEW r WHERE r.PATH=ResPath;
      EXCEPTION WHEN OTHERS THEN NULL;
    END;
    IF ResType = 'text/xml' THEN LinkFolder := '/public/app/XML-TXT/';
    END IF;
    IF ResType = 'image/gif' THEN LinkFolder := '/public/app/IMG/';
    END IF;
    IF ResType = 'application/octet-stream' THEN LinkFolder := '/public/app/FOLDER/';
    END IF;
    DBMS_XDB_REPOS.deleteResource(LinkFolder || ResDisplayName);
  END;

  PROCEDURE handlePostLinkIn (eventObject DBMS_XEVENT.XDBRepositoryEvent) AS
    XDBResourceObj DBMS_XDBRESOURCE.XDBResource;

```



```

ResDisplayName VARCHAR2(100);
ResPath        VARCHAR2(1000);
ResOwner       VARCHAR2(1000);
ResDeletedBy  VARCHAR2(1000);
XDBPathobj    DBMS_XEVENT.XDBPath;
XDBEventobj   DBMS_XEVENT.XDBEvent;
SeqChar       VARCHAR2(1000);
LinkName      VARCHAR2(10000);
ResType       VARCHAR2(100);
LinkFolder    VARCHAR2(100);
BEGIN
XDBResourceObj := DBMS_XEVENT.getResource(eventObject);
ResDisplayName := DBMS_XDBRESOURCE.getDisplayName(XDBResourceObj);
ResOwner       := DBMS_XDBRESOURCE.getOwner(XDBResourceObj);
XDBPathobj    := DBMS_XEVENT.getPath(eventObject);
ResPath       := DBMS_XEVENT.getName(XDBPathObj);
XDBEventobj   := DBMS_XEVENT.getXDBEvent(eventObject);
ResDeletedBy  := DBMS_XEVENT.getCurrentUser(XDBEventobj);
SELECT XMLCast(
        XMLQuery(
            'declare namespace ns = "http://xmlns.oracle.com/xdb/XDBResource.xsd";
            /ns:Resource/ns:ContentType'
            PASSING r.RES RETURNING CONTENT) AS VARCHAR2(100))
    INTO ResType
    FROM PATH_VIEW r WHERE r.PATH=ResPath;
IF ResType = 'text/xml' THEN LinkFolder := '/public/app/XML-TXT';
END IF;
IF ResType = 'image/gif' THEN LinkFolder := '/public/app/IMG';
END IF;
IF ResType = 'application/octet-stream' THEN LinkFolder := '/public/app/FOLDER';
END IF;
DBMS_XDB_REPOS.link(ResPath, LinkFolder, ResDisplayName);
END;
END;
/

```

Example 30-4 Java Code Implementing Event Listeners

```

import oracle.xdb.event.*;
import oracle.xdb.spi.*;
import java.sql.*;
import java.io.*;
import java.net.*;
import oracle.jdbc.*;
import oracle.sql.*;
import oracle.xdb.XMLType;
import oracle.xdb.dom.*;

public class category
extends oracle.xdb.event.XDBBasicEventListener
{
    public Connection connectToDB() throws java.sql.SQLException
    {
        try
        {
            String strUrl="jdbc:oracle:kprb:";
            String strUname="appcatguser1";
            String strPwd="appcatguser1 ";
            Connection conn=null;
            OraclePreparedStatement stmt=null;
            DriverManager.registerDriver(new oracle.jdbc.OracleDriver());

```

```

        conn = DriverManager.getConnection(strUrl, strUname, strPwd);
        return conn;
    }
    catch(Exception e1)
    {
        System.out.println("Exception in connectToDB java function");
        System.out.println("e1:" + e1.toString());
        return null;
    }
}
}
public void handlePostLinkIn (XDBRepositoryEvent eventObject)
{
    XDBPath objXDBPath = null;
    String strPathName="";
    objXDBPath = eventObject.getPath();
    strPathName = objXDBPath.getName();
    XDBResource objXDBResource1;
    objXDBResource1 = eventObject.getResource();
    String textResDisplayName = objXDBResource1.getDisplayName();
    String resType = objXDBResource1.getContentType();
    String linkFolder="";
    System.out.println("resType" + resType+"sumit");
    System.out.println("strPathName:" + strPathName);
    System.out.println("textResDisplayName:" + textResDisplayName);
    if (resType.equals("text/xml")) linkFolder = "/public/app/XML-TXT/";
    else if (resType.equals("image/gif")) linkFolder = "/public/app/IMG/";
    else if (resType.equals("application/octet-stream"))
        linkFolder = "/public/app/FOLDER/";
    System.out.println("linkFolder:" + linkFolder);
    try
    {
        Connection con1 = connectToDB();
        OraclePreparedStatement stmt=null;
        stmt = (OraclePreparedStatement)con1.prepareStatement(
            "CALL DBMS_XDB_REPOS.link(?,?,?)");
        stmt.setString(1,strPathName);
        stmt.setString(2,linkFolder);
        stmt.setString(3,textResDisplayName);
        stmt.execute();
        stmt.close();
        con1.close();
    }
    catch(java.sql.SQLException e1)
    {
        System.out.println("e1:" + e1.toString());
    }
}
/* Make sure the link is not in the category folders.
   Then check the target resource's mime type and create a link
   in the appropriate category folder. */
}
public void handlePreUnlinkIn (XDBRepositoryEvent eventObject)
{
    XDBPath objXDBPath = null;
    String strPathName="";
    objXDBPath = eventObject.getPath();
    strPathName = objXDBPath.getName();
    XDBResource objXDBResource1;
    objXDBResource1 = eventObject.getResource();
    String textResDisplayName = objXDBResource1.getDisplayName();
    String resType = objXDBResource1.getContentType();

```

```

String linkFolder="";
if (resType.equals("text/xml")) linkFolder = "/public/app/XML-TXT/";
else if (resType.equals("image/gif")) linkFolder = "/public/app/IMG/";
else if (resType.equals("application/octet-stream"))
    linkFolder = "/public/app/FOLDER/";
try
{
    Connection con1 = connectToDB();
    OraclePreparedStatement stmt=null;
    stmt = (OraclePreparedStatement)con1.prepareStatement(
        "CALL DBMS_XDB_REPOS.deleteResource(?)");
    stmt.setString(1,linkFolder+textResDisplayName);
    stmt.execute();
    stmt.close();
    con1.close();
}
catch(java.sql.SQLException e1)
{
    System.out.println("e1:" + e1.toString());
}
}
}

```

Example 30-5 Invoking Event Handlers

```

DECLARE
    ret BOOLEAN;
BEGIN
    ret := DBMS_XDB_REPOS.createResource('/public/res-app/res1.xml',
                                        '<name>TestForEventType-1</name>');
END;
/
DECLARE
    b BOOLEAN := FALSE;
    dummy_data CLOB := 'AAA';
BEGIN
    b := DBMS_XDB_REPOS.createResource('/public/res-app/res2.gif', dummy_data);
END;
/
DECLARE
    b BOOLEAN := FALSE;
    dummy_data CLOB := 'AAA';
BEGIN
    b := DBMS_XDB_REPOS.createFolder('/public/res-app/res-appfolder1');
END;

SELECT PATH FROM PATH_VIEW WHERE PATH LIKE '/public/app/%' ORDER BY PATH;

PATH
-----
/public/app/FOLDER
/public/app/FOLDER/res-appfolder1
/public/app/IMG
/public/app/IMG/res2.gif
/public/app/XML-TXT
/public/app/XML-TXT/res1.xml

6 rows selected.

-- Delete the /res-app resources. The /app resources are deleted also.
EXEC DBMS_XDB_REPOS.deleteResource('/public/res-app/res2.gif');

```

```
EXEC DBMS_XDB_REPOS.deleteResource('/public/res-app/res1.xml');
EXEC DBMS_XDB_REPOS.deleteResource('/public/res-app/res-appfolder1');

SELECT PATH FROM PATH_VIEW WHERE PATH LIKE '/public/app/%' ORDER BY PATH;

PATH
-----
/public/app/FOLDER
/public/app/IMG
/public/app/XML-TXT

3 rows selected.
```

Guidelines for Oracle XML DB Applications in Java

Design guidelines are presented for writing Oracle XML DB applications in Java. This includes guidelines for writing and configuring Java servlets for Oracle XML DB.

- [Overview of Oracle XML DB Java Applications](#) (page 31-1)
- [HTTP\(S\): Access Java Servlets or Directly Access XMLType Resources](#) (page 31-2)
- [Use JDBC XMLType Support to Access Many XMLType Object Elements](#) (page 31-2)
- [Use Servlets to Manipulate and Write Out Data Quickly as XML](#) (page 31-2)
- [Oracle XML DB Java Servlet Support Restrictions](#) (page 31-2)
- [Configuration of Oracle XML DB Servlets](#) (page 31-3)
- [HTTP Request Processing for Oracle XML DB Servlets](#) (page 31-7)
- [Session Pool and Oracle XML DB Servlets](#) (page 31-7)
- [Native XML Stream Support](#) (page 31-7)
- [Oracle XML DB Servlet APIs](#) (page 31-8)
- [Oracle XML DB Servlet Example](#) (page 31-8)

31.1 Overview of Oracle XML DB Java Applications

You can use Java code either in a client or an application server, using the OCI driver for JDBC, or in the Java Virtual Machine (JVM).

Because Java runs in the database in the context of the database server process, the ways you can deploy and run Java code are restricted to the following:

- You can run Java code as a stored procedure invoked from SQL or PL/SQL.
- You can run a Java servlet.

Stored procedures are easier to integrate with SQL and PL/SQL code. They require Oracle Net Services as the protocol to access Oracle Database.

Servlets work better as the top-level entry point into Oracle Database, and require using HTTP(S) as the protocol to access Oracle Database.

All Oracle XML DB application program interfaces (APIs) for Java are available to applications running both in the server and outside the database.

These APIs include:

- JDBC support for XMLType
- XMLType class
- Java DOM implementation

31.2 HTTP(S): Access Java Servlets or Directly Access XMLType Resources

If a downstream client needs to work with XML in its textual representation then using HTTP(S) to either access Java servlets or directly access XMLType resources performs the best, especially if the XML node tree is not being manipulated much by the Java program.

The Java implementation in the server can natively move data from the database to the network without converting character data through UCS-2 Unicode (which is required by Java strings). In many cases data is copied directly from the database buffer cache to the HTTP(S) connection. There is no need to convert data from the buffer cache into the SQL serialization format used by Oracle Net Services, then move it to the JDBC client, and then convert to XML. Loading on demand and the LRU cache for XMLType are most effective inside the database server.

31.3 Use JDBC XMLType Support to Access Many XMLType Object Elements

If a downstream client is an application that programmatically accesses many or most of the elements of an XMLType instance using Java, then use JDBC XMLType support for best performance. It is often easier to debug Java programs outside of the database server, as well.

31.4 Use Servlets to Manipulate and Write Out Data Quickly as XML

Oracle XML DB servlets are best used for applications that want to get into the database, manipulate the data, and write it out quickly as XML, not to format HTML pages for end-users.

Servlets are intended for writing HTTP stored procedures in Java that can be accessed using HTTP(S). If you need to develop an entire Internet application then deploy your application servlet in Oracle Fusion Middleware and have the servlet access data in the database using either JDBC or APIs such as `java.net.*`.

31.5 Oracle XML DB Java Servlet Support Restrictions

The Oracle XML DB protocol server supports FTP, HTTP 1.1, WebDAV, and Java Servlets. It supports Java Servlet version 2.2, with a few exceptions.

Support for Java Servlet version 2.2. has these restrictions:

- The servlet WAR file (`web.xml`) is not supported in its entirety. Some `web.xml` configuration parameters must be handled manually. For example, creating roles must be done using the SQL `CREATE ROLE` command.
- `RequestDispatcher` and associated methods are *not* supported.
- Method `HttpServletRequest.getCookies()` is *not* supported.
- Only one `ServletContext` (and one `web-app`) is currently supported.

- Stateful servlets (and thus the `HttpSession` class methods) are *not* supported. Servlets must maintain state in the database itself.

31.6 Configuration of Oracle XML DB Servlets

Oracle XML DB servlets are configured using file `xdbcconfig.xml` in Oracle XML DB Repository. Many of the XML elements in this file are the same as those defined by the Java Servlet 2.2 specification portion of Java 2 Enterprise Edition (J2EE), and they have the same semantics.

[Table 31-1](#) (page 31-3) lists the XML elements defined for the servlet deployment descriptor by the Java Servlet specification, along with extension elements supported by Oracle XML DB.

Table 31-1 XML Elements Defined for Servlet Deployment Descriptors

XML Element Name	Defined By	Supported?	Description	Comment
<code>auth-method</code>	Java	no	Specifies an HTTP authentication method required for access	N/A
<code>charset</code>	Oracle	yes	Specifies an IANA character set name	For example: ISO8859, UTF-8
<code>charset-mapping</code>	Oracle	yes	Specifies a mapping between a filename extension and a charset	N/A
<code>context-param</code>	Java	no	Specifies a parameter for a Web application	Not yet supported
<code>description</code>	Java	yes	A string for describing a servlet or Web application	Supported for servlets
<code>display-name</code>	Java	yes	A string to display with a servlet or Web application	Supported for servlets
<code>distributable</code>	Java	no	Indicates whether or not this servlet can function if all instances are not running in the same Java virtual machine	All servlets running in Oracle Database <i>must</i> be distributable.
<code>errnum</code>	Oracle	yes	Oracle error number	See <i>Oracle Database Error Messages Reference</i>
<code>error-code</code>	Java	yes	HTTP(S) error code	Defined by RFC 2616
<code>error-page</code>	Java	yes	Defines a URL to redirect to if an error is encountered.	Can be specified through an HTTP(S) error, an uncaught Java exception, or through an uncaught Oracle error message
<code>exception-type</code>	Java	yes	Classname of a Java exception mapped to an error page	N/A
<code>extension</code>	Java	yes	A filename extension used to associate with MIME types, character sets, and so on.	N/A

Table 31-1 (Cont.) XML Elements Defined for Servlet Deployment Descriptors

XML Element Name	Defined By	Supported?	Description	Comment
facility	Oracle	yes	Oracle facility code for mapping error pages	For example: ORA, PLS, and so on.
form-error-page	Java	no	Error page for form login attempts	Not yet supported
form-login-config	Java	no	Config spec for form-based login	Not yet supported
form-login-page	Java	no	URL for the form-based login page	Not yet supported
icon	Java	Yes	URL of icon to associate with a servlet	Supported for servlets
init-param	Java	Yes	Initialization parameter for a servlet	N/A
jsp-file	Java	No	Java Server Page file to use for a servlet	Not supported
lang	Oracle	Yes	IANA language name	For example: en-US
lang-mapping	Oracle	Yes	Specifies a mapping between a filename extension and language content	N/A
large-icon	Java	Yes	Large sized icon for icon display	N/A
load-on-startup	Java	Yes	Specifies if a servlet is to be loaded on startup	N/A
location	Java	Yes	Specifies the URL for an error page	Can be a local path name or HTTP(S) URL
login-config	Java	No	Specifies a method for authentication	Not supported
mime-mapping	Java	Yes	Specifies a mapping between filename extension and the MIME type of the content	N/A
mime-type	Java	Yes	MIME type name for resource content	For example: text/xml or application/octet-stream
OracleError	Oracle	Yes	Specifies an Oracle error to associate with an error page	N/A
param-name	Java	Yes	Name of a parameter for a Servlet or ServletContext	Supported for servlets
param-value	Java	Yes	Value of a parameter	N/A
realm-name	Java	No	HTTP(S) realm used for authentication	Not supported

Table 31-1 (Cont.) XML Elements Defined for Servlet Deployment Descriptors

XML Element Name	Defined By	Supported?	Description	Comment
role-link	Java	Yes	Specifies a role a particular user must have for accessing a servlet	Refers to a database role name. Make sure to capitalize by default!
role-name	Java	Yes	A servlet name for a role	Just another name to call the database role. Used by the Servlet APIs
security-role	Java	No	Defines a role for a servlet to use	Not supported. You must manually create roles using the SQL CREATE ROLE
security-role-ref	Java	Yes	A reference between a servlet and a role	N/A
servlet	Java	Yes	Configuration information for a servlet	N/A
servlet-class	Java	Yes	Specifies the classname for the Java servlet	N/A
servlet-language	Oracle	Yes	Specifies the programming language in which the servlet is written.	Either Java, C, or PL/SQL. Currently, only Java is supported for customer-defined servlets.
servlet-mapping	Java	Yes	Specifies a filename pattern with which to associate the servlet	All of the mappings defined by Java are supported
servlet-name	Java	Yes	String name for a servlet	Used by servlet APIs
servlet-schema	Oracle	Yes	The Oracle Schema in which the Java class is loaded. If not specified, then the schema is searched using the default resolver specification.	If this is not specified, then the servlet must be loaded into the SYS schema to ensure that everyone can access it, or the default Java class resolver must be altered. The servlet schema is capitalized unless the value is enclosed in double quotation marks.
session-config	Java	No	Configuration information for an HttpSession	HttpSession is not supported
session-timeout	Java	No	Timeout for an HTTP(S) session	HttpSession is not supported

Table 31-1 (Cont.) XML Elements Defined for Servlet Deployment Descriptors

XML Element Name	Defined By	Supported?	Description	Comment
small-icon	Java	Yes	Small icon to associate with a servlet	N/A
taglib	Java	No	JSP tag library	JSPs currently not supported
taglib-uri	Java	No	URI for JSP tag library description file relative to file <code>web.xml</code>	JSPs currently not supported
taglib-location	Java	No	Path name relative to the root of the Web application where the tag library is stored	JSPs currently not supported
url-pattern	Java	Yes	URL pattern to associate with a servlet	See Section 10 of Java Servlet 2.2 spec
web-app	Java	No	Configuration for a Web application	Only one Web application is currently supported
welcome-file	Java	Yes	Specifies a welcome-file name	N/A
welcome-file-list	Java	Yes	Defines a list of files to display when a folder is referenced through an HTTP GET request	Example: <code>index.html</code>

Note:

- The following parameters defined for the `web.xml` file by Java are usable only by J2EE-compliant Enterprise Java Bean containers, and are not required for Java Servlet containers that do not support a full J2EE environment: `env-entry`, `env-entry-name`, `env-entry-value`, `env-entry-type`, `ejb-ref`, `ejb-ref-type`, `home`, `remote`, `ejb-link`, `resource-ref`, `res-ref-name`, `res-type`, `res-auth`.
- The following elements are used to define access control for resources: `security-constraint`, `web-resource-collection`, `web-resource-name`, `http-method`, `user-data-constraint`, `transport-guarantee`, `auth-constrain`. Oracle XML DB provides this functionality through access control lists (ACLs). An ACL is a list of access control entries (ACEs) that determines which principals have access to a given resource or resources. A future release will support using a `web.xml` file to generate ACLs.

See Also:

[Administration of Oracle XML DB](#) (page 34-1) for more information about configuring the `xdbconfig.xml` file

31.7 HTTP Request Processing for Oracle XML DB Servlets

Oracle XML DB processing of an HTTP request is described.

HTTP request handling proceeds as follows:

1. If a connection has not yet been established, then Oracle Listener hands the connection to a shared server dispatcher.
2. When a new HTTP request arrives, the dispatcher wakes up a shared server.
3. The HTTP headers are parsed into appropriate structures.
4. The shared server attempts to allocate a database session from the Oracle XML DB session pool, if available, but otherwise creates a new session.
5. A new database call and a new database transaction are started.
6. If HTTP(S) has included authentication headers, then the session is authenticated as that database user (just as if the user logged into SQL*Plus). If no authentication information is included, and the request is GET or HEAD, then Oracle XML DB attempts to authenticate the session as the ANONYMOUS user. If that database user account is locked, then no unauthenticated access is allowed.
7. The URL in the HTTP request is matched against the servlets in the `xdbconfig.xml` file, as specified by the Java Servlet 2.2 specification.
8. The Oracle XML DB Servlet container is invoked in the Java VM inside Oracle. If the specified servlet has not been initialized yet, then the servlet is initialized.
9. The Servlet reads input from the `ServletInputStream`, and writes output to the `ServletOutputStream`, and returns from method `service()`.
10. If no uncaught Oracle error occurred, then the session is put back into the session pool.

See Also:

[Repository Access Using Protocols](#) (page 28-1)

31.8 Session Pool and Oracle XML DB Servlets

Oracle Database uses one Java virtual machine (VM) for each database session. A session that is reused from the session pool retains any state that is left over in the Java VM (Java static variables) from the last time that session was used.

This can be useful in caching Java state that is not user-specific, such as metadata, but do not store secure user data in Java static memory. This could turn into a security hole inadvertently introduced by your application if you are not careful.

31.9 Native XML Stream Support

Java node class `DOM` has Oracle-specific method `write()`, which provides native XML stream support.

Java method `write()` takes the following arguments and returns `void`:

- `java.io.OutputStream stream`: A Java stream for writing the XML text.

- `String charEncoding`: The character encoding for writing the XML text. If `NULL`, then the database character set is used.
- `Short indent`: The number of characters to indent nested XML elements.

Method `write()` has a shortcut implementation if the stream is the `ServletOutputStream` provided inside the database. The contents of the `Node` are written as XML data in native code directly to the output socket. This bypasses any conversions into and out of Java objects or Unicode (required for Java strings), and provides very high performance.

31.10 Oracle XML DB Servlet APIs

The APIs supported by Oracle XML DB servlets are described. They are defined by the Java Servlet 2.2 specification.

The Javadoc for this is available at <http://download.oracle.com/javaee/1.2.1/api/index.html>.

Table 31-2 (page 31-8) lists Java Servlet 2.2 methods that are not implemented. They result in run-time exceptions.

Table 31-2 Java Servlet 2.2 Methods that Are Not Implemented

Interface	Methods Not Implemented
<code>HttpServletRequest</code>	<code>getSession()</code> , <code>isRequestedSessionIdValid()</code>
<code>HttpSession</code>	all
<code>HttpSessionBindingListener</code>	all

31.11 Oracle XML DB Servlet Example

Examples show the definition of a simple Oracle XML DB servlet that prints the content of a file resource, and how to register and map that servlet.

The servlet shown in Example 31-1 (page 31-8) prints the content of file resource `public/test/fool.text`.

To install the servlet, you compile it, then load it into Oracle Database:

```
% loadjava -grant public -u quine/curry -r test.class
```

Finally, register and map the servlet, associating it with a URL, as shown in Example 31-2 (page 31-9).

Example 31-1 An Oracle XML DB Servlet

```
import javax.servlet.http.*;
import javax.servlet.*;
import java.util.*;
import java.io.*;
import java.util.*;
import java.io.IOException;
import java.io.OutputStreamWriter;
import java.io.Reader;
import java.io.Writer;
```

```

import java.sql.DriverManager;
import java.sql.SQLException;
import oracle.jdbc.OracleConnection;
import oracle.jdbc.OracleDriver;
import oracle.jdbc.OraclePreparedStatement;
import oracle.jdbc.OracleResultSet;
import oracle.sql.CLOB;
import oracle.xdb.XMLType;
import oracle.xdb.spi.XDBResource;

public class test extends HttpServlet {
    public void doGet(HttpServletRequest request, HttpServletResponse response)
        throws ServletException,
            IOException {
        try {
            try {
                // Get the database connection for the current HTTP session
                DriverManager.registerDriver(new oracle.jdbc.OracleDriver());
                OracleDriver ora = new OracleDriver();
                OracleConnection databaseConnection =
                    (OracleConnection) ora.defaultConnection();
                String statementText =
                    "SELECT XDBURIType('/public/test/fool.txt').getClob() FROM DUAL";
                OraclePreparedStatement statement =
                    (OraclePreparedStatement)
                    databaseConnection.prepareStatement(statementText);
                OracleResultSet resultSet = null;
                CLOB content = null;
                // Execute the statement
                resultSet = (OracleResultSet) statement.executeQuery();
                while (resultSet.next())
                    { // The statement returns a CLOB.
                    // Copy content of CLOB to server's output stream.
                    content = resultSet.getCLOB(1);
                    Reader reader = content.getCharacterStream();
                    Writer writer =
                        new OutputStreamWriter(response.getOutputStream());
                    int bytesSent = 0;
                    int n;
                    char[] buffer = new char[CLOB.MAX_CHUNK_SIZE];
                    while (-1 != (n = reader.read(buffer)))
                        { bytesSent = bytesSent + n;
                        writer.write(buffer, 0, n); }
                    writer.flush();
                    if (content.isOpen()) { content.close(); }}
                resultSet.close();
                statement.close();
                databaseConnection.close();
                response.getOutputStream().write('\n'); }
            catch (SQLException sql)
                { throw new ServletException(sql); }
            catch (ServletException se )
                { se.printStackTrace(); }
            finally
                { System.out.flush(); }}}

```

Example 31-2 Registering and Mapping an Oracle XML DB Servlet

```

EXEC DBMS_XDB_CONFIG.addServlet('TestServletFoo', 'Java', 'TestServletFoo',
                                NULL, NULL, 'test', NULL, NULL, 'XDB');

```

```
EXEC DBMS_XDB_CONFIG.addServletMapping('/public/test/fool.txt', 'TestServletFoo');  
  
COMMIT;
```

Data Access Using URIs

You can generate and store URIs in the database and use them to retrieve the database data they target. There are three kinds of URIs you can use this way: DBUri, XDBUri, and HTTPUri.

- [Overview of Oracle XML DB URI Features](#) (page 32-1)
- [URIs and URLs](#) (page 32-1)
- [URIType and its Subtypes](#) (page 32-2)
- [Accessing Data Using URIType Instances](#) (page 32-7)
- [XDBUri: Pointers to Repository Resources](#) (page 32-10)
- [DBUri: Pointers to Database Data](#) (page 32-13)
- [Create New Subtypes of URIType Using Package URIFACTORY](#) (page 32-21)
- [SYS_DBURIGEN SQL Function](#) (page 32-23)
- [DBUriServlet](#) (page 32-27)

32.1 Overview of Oracle XML DB URI Features

You can use a URI as an indirection mechanism to access database data, and you can use a URI that targets database data to produce XML documents.

- *Using paths as an indirection mechanism* – You can store a path in the database and then access its target *indirectly* by referring to the path. The paths in question are various kinds of Uniform Resource Identifier (URI).
- *Using paths that target database data to produce XML documents* – One kind of URI that you can use for indirection in particular, a *DBUri*, provides a convenient XPath notation for addressing *database data*. You can use a *DBUri* to construct an *XML document* that contains database data and whose structure reflects the database structure.

32.2 URIs and URLs

In developing Web-based XML applications, you often refer to data located on a network using **Uniform Resource Identifiers**, or **URIs**. A **URL**, or **Uniform Resource Locator**, is a URI that accesses an object using an Internet protocol.

A URI has two parts, separated by a number sign (#):

- A URL part, that identifies a document.

- A fragment part, that identifies a fragment within the document. The notation for the fragment depends on the document type. For HTML documents, it is an anchor name. For XML documents, it is an XPath expression.

These are typical URIs:

- For HTML – `http://www.example.com/document1#some_anchor`, where `some_anchor` is a named anchor in the HTML document.
- For XML – `http://www.example.com/xml_doc#/po/cust/custname`, where:
 - `http://www.example.com/xml_doc` identifies the location of the XML document.
 - `/po/cust/custname` identifies a fragment within the document. This portion is defined by the W3C XPointer recommendation.

See Also:

- <http://www.w3.org/2002/ws/Activity.html> an explanation of HTTP(S) URL notation
 - <http://www.w3.org/TR/xpath> for an explanation of the XML XPath notation
 - <http://www.w3.org/TR/xptr/> for an explanation of the XML XPointer notation
 - <http://xml.coverpages.org/xmlMediaMIME.html> for a discussion of MIME types
-
-

32.3 URIType and its Subtypes

You can represent paths of various kinds as database objects. These provide unified access to data stored inside and outside the server, and they can be used to map URIs in XML documents to database columns, letting documents reference data stored in relational columns and expose it externally.

The available path object types are `HTTPURIType`, `DBURIType`, and `XDBURIType`, all of which are derived from abstract object type `URIType`.

- **HTTPURIType** – An object of this type is called an **HTTPUri** and represents a URL that begins with `http://`. With `HTTPURIType`, you can create objects that represent links to remote *Web pages* (or files) and retrieve those Web pages by calling object methods. Applications using `HTTPUriType` must have the proper access privileges. `HTTPUriType` implements the Hyper Text Transfer Protocol (HTTP(S)) for accessing remote Web pages. `HTTPURIType` uses package `UTL_HTTP` to fetch data, so session settings and access control for this package can also be used to influence HTTP fetches.

See Also:

- [HTTPURIType PL/SQL Method GETCONTENTTYPE\(\)](#) (page 32-5)
 - *Oracle Database Security Guide* for information about managing fine-grained access to external network services
-
-

- **DBURIType** – An object of this type is called a **DBUri** and represents a URI that targets database data – a table, one or more rows, or a single column. With **DBURIType**, you can create objects that represent links to *database data*, and retrieve such data *as XML* by calling object methods. A **DBUri** uses a simple form of XPath expression as its URI syntax – for example, the following XPath expression is a **DBUri** reference to the row of table `HR.employees` where column `first_name` has value Jack:

```
/HR/EMPLOYEES/ROW[FIRST_NAME="Jack"]
```

See Also :

[DBUris: Pointers to Database Data](#) (page 32-13)

- **XDBURIType** – An object of this type is called an **XDBUri**, and represents a URI that targets a resource in Oracle XML DB Repository. With PL/SQL constructor **XDBURIType** you can create objects that represent links to *repository resources*. You can then retrieve all or part of any resource by calling methods on those objects. The URI syntax for an **XDBUri** is a repository resource address, optionally followed by an XPath expression. For example, `/public/hr/doc1.xml#/purchaseOrder/lineItem` is an **XDBUri** reference to the `lineItem` child element of the root element `purchaseOrder` in repository file `doc1.xml` in folder `/public/hr`.
-
-

See Also :

[XDBUris: Pointers to Repository Resources](#) (page 32-10)

Each of these object types is derived from an *abstract* object type, **URIType**. As an abstract type, it has *no* instances (objects). Only its subtypes have instances.

Type **URIType** provides the following features:

- *Unified access to data stored inside and outside the server.* Because you can use **URIType** values to store pointers to HTTP(S) and **DBUris**, you can create queries and indexes without worrying about where the data resides.
- *Mapping of URIs in XML Documents to Database Columns.* When an XML document is broken up and stored in object-relational tables and columns, any URIs contained in the document are mapped to database columns of the appropriate **URIType** subtype.

You can reference data stored in relational columns and expose it to the external world using URIs. Oracle Database provides a standard servlet, `DBUriServlet`, that interprets **DBUris**. It also provides PL/SQL package `UTL_HTTP` and Java class `java.net.URL`, which you can use to fetch URL references.

URIType columns can be indexed natively in Oracle Database using Oracle Text – no special data store is needed.

See Also:

- [Create New Subtypes of URIType Using Package URIFACTORY](#) (page 32-21) for information about defining new URIType subtypes
 - [Indexes for XMLType Data](#) (page 6-1)
-

32.3.1 Overview of DBUris and XDBUris

Important uses of DBUris and XDBUris include referencing XSLT stylesheets from Web pages, referencing data in database tables or in repository folders without using SQL, and improving performance by bypassing the Web server.

- You can reference XSLT stylesheets from within database-generated Web pages. PL/SQL package `DBMS_METADATA` uses DBUris to reference XSLT stylesheets. An XDBUri can be used to reference XSLT stylesheets stored in Oracle XML DB Repository.
- You can reference HTML text, images and other data stored in the database. URLs can be used to point to data stored in database tables or in repository folders.
- You can improve performance by bypassing the Web server. Replace a global URL in your XML document with a reference to the database, and use a servlet, a DBUri, or an XDBUri to retrieve the targeted content. Using a DBUri or an XDBUri generally provides better performance than using a servlet, because you interact directly with the database rather than through a Web server.
- With a DBUri, you can access an XML document in the database without using SQL.
- Whenever a repository resource is stored in a database table to which you have access, you can use either an XDBUri or a DBUri to access its content.

See Also:

Oracle Database PL/SQL Packages and Types Reference, "DBMS_METADATA package"

32.3.2 URIType PL/SQL Methods

Abstract object type URIType includes PL/SQL methods that can be used with each of its subtypes. Each of these methods can be overridden by any of the subtypes.

[Table 32-1](#) (page 32-5) lists the URIType PL/SQL methods. In addition, each of the subtypes has a constructor with the same name as the subtype.

Table 32-1 URIType PL/SQL Methods

URIType Method	Description
<code>getURL()</code>	Returns the URL of the URIType instance. Use this method instead of referencing a URL directly. URIType subtypes override this method to provide the correct URL. For example, HTTPURIType stores a URL without prefix <code>http://</code> . Method <code>getURL()</code> then prepends the prefix and returns the entire URL.
<code>getExternalURL()</code>	Similar to <code>getURL()</code> , but <code>getExternalURL()</code> escapes characters in the URL, to conform with the URL specification. For example, spaces are converted to the escaped value <code>%20</code> .
<code>getContentType()</code>	Returns the MIME content type for the URI. <i>HTTPUri</i> : To return the content type, the URL is followed and the MIME header examined. <i>DBUri</i> : The returned content type is either <code>text/plain</code> (for a scalar value) or <code>text/xml</code> (otherwise). <i>XDBUri</i> : The value of the <code>ContentType</code> metadata property of the repository resource is returned.
<code>getCLOB()</code>	Returns the target of the URI as a CLOB instance. The database character set is used for encoding the data. <i>DBUri</i> : XML data is returned (unless <code>node-test text()</code> is used, in which case the targeted data is returned as is). When a BLOB column is targeted, the binary data in the column is <i>translated as hexadecimal character data</i> .
<code>getBLOB()</code>	Returns the target of the URI as a BLOB value. No character conversion is performed, and the character encoding is that of the URI target. This method can also be used to fetch binary data. <i>DBUri</i> : When applied to a DBUri that targets a BLOB column, <code>getBLOB()</code> returns the binary data <i>translated as hexadecimal character data</i> . When applied to a DBUri that targets <i>non-binary</i> data, the data is returned in the database character set.
<code>getXML()</code>	Returns the target of the URI as an XMLType instance. Using this, an application that performs operations other than <code>getCLOB()</code> and <code>getBLOB()</code> can use XMLType methods to do those operations. This throws an exception if the URI does not target a well-formed XML document.
<code>createURI()</code>	Constructs an instance of one of the URIType subtypes.

See Also:

Oracle Database PL/SQL Packages and Types Reference

32.3.2.1 HTTPURIType PL/SQL Method GETCONTENTTYPE()

HTTPURIType PL/SQL method `getContentType()` returns the MIME information for its targeted document. You can use this information to decide whether to retrieve the document as a BLOB instance or a CLOB instance.

For example, you might treat a Web page with a MIME type of `x/jpeg` as a BLOB instance, and one with a MIME type of `text/plain` or `text/html` as a CLOB instance.

Example 32-1 (page 32-6) tests the HTTP content type to determine whether to retrieve data as a CLOB or BLOB instance. The content-type data is the HTTP header, for `HTTPURIType`, or the metadata of the database column, for `DBURIType`.

Example 32-1 Using HTTPURIType PL/SQL Method GETCONTENTTYPE()

```
DECLARE
  httpuri HTTPURIType;
  y CLOB;
  x BLOB;
BEGIN
  httpuri := HTTPURIType('http://www.oracle.com/index.html');
  DBMS_OUTPUT.put_line(httpuri.getContent());
  IF httpuri.getContent() = 'text/html'
  THEN
    y := httpuri.getCLOB();
  END IF;
  IF httpuri.getContent() = 'application-x/bin'
  THEN
    x := httpuri.getBLOB();
  END IF;
END;
/
text/html
```

32.3.2.2 DBURIType PL/SQL Method GETCONTENTTYPE()

PL/SQL method `getContent()` returns the MIME information for a URL. If a `DBUri` targets a scalar value, then the MIME content type returned is `text/plain`. Otherwise, the type returned is `text/xml`.

```
CREATE TABLE dbtab (a VARCHAR2(20), b BLOB);
```

`DBUris` corresponding to the following XPath expressions have content type `text/xml`, because each targets a complete column of XML data.

- `/HR/DBTAB/ROW/A`
- `/HR/DBTAB/ROW/B`

`DBUris` corresponding to the following XPath expressions have content type `text/plain`, because each targets a scalar value.

- `/HR/DBTAB/ROW/A/text()`
- `/HR/DBTAB/ROW/B/text()`

32.3.2.3 DBURIType PL/SQL Method GETCLOB()

When PL/SQL method `getCLOB()` is applied to a `DBUri`, the targeted data is returned as XML data, using the targeted column or table name as an XML element name. If the target XPath uses node-test `text()` then the data is returned as text without an enclosing XML tag.

In both cases, the returned data is in the database character set.

For example: If applied to a DBUri with XPath `/HR/DBTAB/ROW/A/text()`, where `A` is a non-binary column, the data in column `A` is returned as is. Without XPath node-test `text()`, the result is the data wrapped in XML:

```
<HR><DBTAB><ROW><A>...data_in_column_A...</A></ROW></DBTAB></HR>
```

When applied to a DBUri that targets a *binary* (BLOB) column, the binary data in the column is *translated as hexadecimal character data*.

For example: If applied to a DBUri with XPath `/HR/DBTAB/ROW/B/text()`, where `B` is a BLOB column, the targeted binary data is translated to hexadecimal character data and returned. Without XPath node-test `text()`, the result is the translated data wrapped in XML:

```
<HR><DBTAB><ROW><B>...data_translated_to_hex...</B></ROW></DBTAB></HR>
```

32.3.2.4 DBURITYPE PL/SQL Method GETBLOB()

When applied to a DBUri that targets a BLOB column, PL/SQL method `getBLOB()` returns the binary data *translated as hexadecimal character data*. When applied to a DBUri that targets *non*-binary data, method `getBLOB()` returns the data (as a BLOB value) in the database character set.

For example, consider table `dbtab`:

```
CREATE TABLE dbtab (a VARCHAR2(20), b BLOB);
```

When `getBLOB()` is applied to a DBUri corresponding to XPath expression `/HR/DBTAB/ROW/B`, it returns a BLOB value containing an XML document with root element `B` whose content is the hexadecimal-character translation of the binary data of column `B`.

When `getBLOB()` is applied to a DBUri corresponding to XPath expression `/HR/DBTAB/ROW/B/text()`, it returns a BLOB value containing only the hexadecimal-character translation of the binary data of column `B`.

When `getBLOB()` is applied to a DBUri corresponding to XPath expression `/HR/DBTAB/ROW/A/text()`, which targets *non*-binary data, it returns a BLOB value containing the data of column `A`, in the database character set.

32.4 Accessing Data Using URIType Instances

To use instances of URITYPE subtypes for indirection, you store such instances in the database and then query to retrieve the targeted data with a PL/SQL method such as `getCLOB()`.

You can create database columns using URITYPE or any of its subtypes, or you can store just the text of each URI as a string and then create the needed URITYPE instances on demand, when the URIs are accessed. You can store objects of different URITYPE subtypes in the same URITYPE database column.

You can also define your own object types that inherit from the URITYPE subtypes. Deriving new types lets you use custom techniques to retrieve, transform, or filter data.

See Also:

- [Create New Subtypes of URIType Using Package URIFACTORY](#) (page 32-21) for information about defining new URIType subtypes
- [XSL Transformation and Oracle XML DB](#) (page 7-1) for information about transforming XML data

Example 32-2 (page 32-8) stores an HTTPUri and a DBUri (instances of URIType subtypes HTTPURIType and DBURIType) in the same database column of type URIType. A query retrieves the data addressed by each of the URIs. The first URI is a Web-page URL. The second URI references data in table employees of standard database schema HR. (For brevity, only the beginning of the Web page is shown.)

To use URIType PL/SQL method `createURI()`, you must know the particular URIType subtype to use. PL/SQL method `getURI()` of package URIFACTORY lets you instead use the flexibility of late binding, determining the particular type information at run time.

PL/SQL factory method `URIFACTORY.getURI()` takes as argument a URI string. It returns a URIType instance of the appropriate subtype (`HTTPURIType`, `DBURIType`, or `XDBURIType`), based on the form of the URI string:

- If the URI starts with `http://`, then `getURI()` creates and returns an HTTPUri.
- If the URI starts with either `/oradb/` or `/dburi/`, then `getURI()` creates and returns a DBUri.
- Otherwise, `getURI()` creates and returns an XDBUri.

Example 32-3 (page 32-9) is similar to **Example 32-2** (page 32-8), but it uses two different ways to obtain documents targeted by URIs:

- PL/SQL method `SYS.URIFACTORY.getURI()` with *absolute* URIs:
 - an HTTPUri that targets HTTP address `http://www.oracle.com`
 - a DBUri that targets database address `/oradb/HR/EMPLOYEES/ROW[EMPLOYEE_ID=200]`
- Constructor `SYS.HTTPURITYPE()` with a *relative* URL (no `http://`). The same HTTPUri is used as for the absolute URI: the Oracle home page.

In **Example 32-3** (page 32-9), the URI strings passed to `getURI()` are hard-coded, but they could just as easily be string values that are obtained by an application at run time.

Example 32-2 Creating and Querying a URI Column

```
CREATE TABLE uri_tab (url URIType);
Table created.

INSERT INTO uri_tab VALUES (HTTPURITYPE.createURI('http://www.oracle.com'));
1 row created.

INSERT INTO uri_tab VALUES (DBURITYPE.createURI(
    '/HR/EMPLOYEES/ROW[FIRST_NAME="Jack"]'));
1 row created.
```

```

SELECT e.url.getCLOB() FROM uri_tab e;

E.URL.GETCLOB()
-----
<!DOCTYPE HTML PUBLIC "-//W3C//DTD HTML 4.0 Transitional//EN">
<html>
<head>
. . .

<?xml version="1.0"?>
<ROW>
  <EMPLOYEE_ID>177</EMPLOYEE_ID>
  <FIRST_NAME>Jack</FIRST_NAME>
  <LAST_NAME>Livingston</LAST_NAME>
  <EMAIL>JLIVINGS</EMAIL>
  <PHONE_NUMBER>011.44.1644.429264</PHONE_NUMBER>
  <HIRE_DATE>23-APR-06</HIRE_DATE>
  <JOB_ID>SA_REP</JOB_ID>
  <SALARY>8400</SALARY>
  <COMMISSION_PCT>.2</COMMISSION_PCT>
  <MANAGER_ID>149</MANAGER_ID>
  <DEPARTMENT_ID>80</DEPARTMENT_ID>
</ROW>

2 rows selected.

```

Example 32-3 Using Different Kinds of URI, Created in Different Ways

```

CREATE TABLE uri_tab (docUrl SYS.URIType, docName VARCHAR2(200));
Table created.

-- Insert an HTTPUri with absolute URL into SYS.URIType using URIFACTORY.
-- The target is Oracle home page.
INSERT INTO uri_tab VALUES
  (SYS.URIFACTORY.getURI('http://www.oracle.com'), 'AbsURL');
1 row created.

-- Insert an HTTPUri with relative URL using constructor SYS.HTTPURIType.
-- Note the absence of prefix http://. The target is the same.
INSERT INTO uri_tab VALUES (SYS.HTTPURIType('www.oracle.com'), 'RelURL');
1 row created.

-- Insert a DBUri that targets employee data from table HR.employees.
INSERT INTO uri_tab VALUES
  (SYS.URIFACTORY.getURI('/oradb/HR/EMPLOYEES/ROW[EMPLOYEE_ID=200]'), 'Emp200');
1 row created.

-- Extract all of the documents.
SELECT e.docUrl.getCLOB(), docName FROM uri_tab e;

E.DOCURL.GETCLOB()
-----
DOCNAME
-----
<!DOCTYPE HTML PUBLIC "-//W3C//DTD HTML 4.0 Transitional//EN">
<html>
<head>
. . .
AbsURL

<!DOCTYPE HTML PUBLIC "-//W3C//DTD HTML 4.01 Transitional//EN">

```

```

<html>
<head>
. . .
ReURL

<?xml version="1.0"?>
<ROW>
  <EMPLOYEE_ID>200</EMPLOYEE_ID>
  <FIRST_NAME>Jennifer</FIRST_NAME>
  <LAST_NAME>Whalen</LAST_NAME>
  <EMAIL>JWHALEN</EMAIL>
  <PHONE_NUMBER>515.123.4444</PHONE_NUMBER>
  <HIRE_DATE>17-SEP-03</HIRE_DATE>
  <JOB_ID>AD_ASST</JOB_ID>
  <SALARY>4400</SALARY>
  <MANAGER_ID>101</MANAGER_ID>
  <DEPARTMENT_ID>10</DEPARTMENT_ID>
</ROW>
Emp200

3 rows selected.

-- In PL/SQL
CREATE OR REPLACE FUNCTION returnclob
  RETURN CLOB
  IS a SYS.URIType;
BEGIN
  SELECT docUrl INTO a FROM uri_Tab WHERE docName LIKE 'Emp200%';
  RETURN a.getCLOB;
END;
/
Function created.

SELECT returnclob() FROM DUAL;

RETURNCLOB()
-----
<?xml version="1.0"?>
<ROW>
  <EMPLOYEE_ID>200</EMPLOYEE_ID>
  <FIRST_NAME>Jennifer</FIRST_NAME>
  <LAST_NAME>Whalen</LAST_NAME>
  <EMAIL>JWHALEN</EMAIL>
  <PHONE_NUMBER>515.123.4444</PHONE_NUMBER>
  <HIRE_DATE>17-SEP-03</HIRE_DATE>
  <JOB_ID>AD_ASST</JOB_ID>
  <SALARY>4400</SALARY>
  <MANAGER_ID>101</MANAGER_ID>
  <DEPARTMENT_ID>10</DEPARTMENT_ID>
</ROW>

1 row selected.

```

32.5 XDBUris: Pointers to Repository Resources

XDBURIType is a subtype of URIType that exposes resources in Oracle XML DB Repository using URIs. Instances of object type XDBURIType are called **XDBUris**.

32.5.1 XDBUri URI Syntax

The URL portion of an XDBUri URI is the hierarchical address of the targeted repository resource – it is a *repository* path (*not* an XPath expression). An optional fragment portion of the URI, after the number-sign (#), uses XPath syntax to target parts of an XML document.

The optional fragment portion of the URI is appropriate only if the targeted resource is an XML document, in which case the fragment portion targets one or more its parts. If the targeted resource is not an XML document, then omit the fragment and number-sign.

The following are examples of XDBUri URIs:

- `/public/hr/image27.jpg`
- `/public/hr/doc1.xml#/PurchaseOrder/LineItem`

Based on the form of these URIs:

- `/public/hr` is a folder resource in Oracle XML DB Repository.
- `image27.jpg` and `doc1.xml` are resources in folder `/public/hr`.
- Resource `doc1.xml` is a file resource, and it contains an XML document.
- The XPath expression `/PurchaseOrder/LineItem` refers to the `LineItem` child element in element `PurchaseOrder` of XML document `doc1.xml`.

You can create an XDBUri using PL/SQL method `getURI()` of package `URIFACTORY`.

`XDBURITYPE` is the *default* `URITYPE` used when generating instances using `URIFACTORY` PL/SQL method `getURI()`, unless the URI has one of the recognized prefixes `http://`, `/dburi`, or `/oradb`.

For example, if resource `doc1.xml` is present in repository folder `/public/hr`, then the following query returns an XDBUri that targets that resource.

```
SELECT SYS.URIFACTORY.getURI('/public/hr/doc1.xml') FROM DUAL;
```

It is the lack of a special prefix that determines that the object type is `XDBURITYPE`, not any particular resource file extension or the presence of # followed by an XPath expression. Even if the resource were named `foo.bar` instead of `doc1.xml`, the returned `URITYPE` instance would still be an XDBUri.

32.5.2 Using XDBUri: Examples

XDBUri examples here use URIs in a table to access a repository resource and, together with PL/SQL method `getXML`, to query and retrieve XML documents.

[Example 32-4](#) (page 32-12) creates an XDBUri, inserts values into a purchase-order table, and then selects all of the purchase orders. Because there is no special prefix used in the URI passed to `URIFACTORY.getURI()`, the created `URITYPE` instance is an XDBUri.

Because PL/SQL method `getXML()` returns an `XMLTYPE` instance, you can use it with SQL/XML functions such as `XMLQuery`. The query in [Example 32-5](#) (page 32-13) illustrates this. The query retrieves all purchase orders numbered 999.

Example 32-4 Access a Repository Resource by URI Using an XDBUri

```

DECLARE
res BOOLEAN;
postring VARCHAR2(100):= '<?xml version="1.0"?>
<ROW>
<PO>999</PO>
</ROW>';
BEGIN
res:=DBMS_XDB_REPOS.createFolder('/public/orders/');
res:=DBMS_XDB_REPOS.createResource('/public/orders/po1.xml', postring);
END;
/
PL/SQL procedure successfully completed.

CREATE TABLE uri_tab (poUrl SYS.URIType, poName VARCHAR2(1000));
Table created.

-- Create an abstract type column so any type of URI can be used
-- Insert an absolute URL into poUrl.
-- The factory will create an XDBURIType because there is no prefix.
-- Here, po1.xml is an XML file that is stored in /public/orders/
-- of the XML repository.
INSERT INTO uri_tab VALUES
  (URIFACTORY.getURI('/public/orders/po1.xml'), 'SomePurchaseOrder');
1 row created.

-- Get all the purchase orders
SELECT e.poUrl.getCLOB(), poName FROM uri_tab e;

E.POURL.GETCLOB()
-----
PONAME
-----
<?xml version="1.0"?>
<ROW>
<PO>999</PO>
</ROW>
SomePurchaseOrder

1 row selected.

-- Using PL/SQL, you can access table uri_tab as follows:
CREATE OR REPLACE FUNCTION returnclob
  RETURN CLOB
  IS a URIType;
BEGIN
  -- Get absolute URL for purchase order named like 'Some%'
  SELECT poUrl INTO a FROM uri_tab WHERE poName LIKE 'Some%';
  RETURN a.getCLOB();
END;
/
Function created.

SELECT returnclob() FROM DUAL;

RETURNCLOB()
-----
<?xml version="1.0"?>
<ROW>
<PO>999</PO>

```

```
</ROW>
```

```
1 row selected.
```

Example 32-5 Using PL/SQL Method GETXML with XMLCAST and XMLQUERY

```
SELECT e.poUrl.getCLOB() FROM uri_tab e
       WHERE XMLCast(XMLQuery(' $po/ROW/PO'
                              PASSING e.poUrl.getXML() AS "po"
                              RETURNING CONTENT)
                    AS VARCHAR2(24))
          = '999';
```

```
E.POURL.GETCLOB()
-----
<?xml version="1.0"?>
<ROW>
<PO>999</PO>
</ROW>
```

```
1 row selected.
```

32.6 DBUri: Pointers to Database Data

A DBUri is a URI that targets *database data*. As for all instances of URIType subtypes, a DBUri provides indirect access to data. DBURIType also lets you address database data using XPath and construct XML documents containing database data that is targeted by a DBUri that reflects the database structure.

- Address database data using XPath notation. This, in effect, lets you visualize and access the database as if it were XML data.

For example, a DBUri can use an expression such as `/HR/EMPLOYEES/ROW[FIRST_NAME="Jack"]` to target the row of table `HR.employees` where column `first_name` has value `Jack`.

- Construct an XML document that contains database data targeted by a DBUri and whose structure reflects the database structure.

For example: A DBUri with XPath `/HR/DBTAB/ROW/A` can be used to construct an XML document that wraps the data of column `A` in XML elements that reflect the database structure and are named accordingly:

```
<HR><DBTAB><ROW><A>...data_in_column_A...</A></ROW></DBTAB></HR>
```

A DBUri does not reference a global location as does an HTTPUri. You can, however, also access objects addressed by a DBUri in a global manner, by appending the DBUri to an HTTPUri that identifies a servlet that handles DBUris – see [DBUriServlet](#) (page 32-27).

32.6.1 View the Database as XML Data

Using DBURIType, you can have what amounts to XML views of the portions of the database to which you have access, presented *in the form of XML data*. When visualized this way, the database data is effectively wrapped in XML elements, resulting in one or more XML documents.

You can access only those database schemas to which you have been granted access privileges. This portion of the database is, in effect, your own view of the database. This applies to all kinds database data, not just data that is stored as XML.

Such "XML views" are not database views, in the technical sense of the term. "View" here means only an abstract perspective that can be useful for understanding `DBURIType`. You can think of `DBURIType` as providing a way to visualize and access the database *as if it were* XML data.

However, `DBURIType` does not just provide an exercise in visualization and an additional means to access database data. Each "XML view" can be realized as an XML document – that is, you can use `DBURIType` to generate XML documents using database data.

All of this is another way of saying that `DBURIType` lets you use XPath notation to 1) address and access any database data to which you have access and 2) construct XML representations of that data.

Figure 32-1 (page 32-14) illustrates the relation between a relational table, `HR.employees`, a corresponding XML view of a portion of that table, and the corresponding DBUri URI (a simple XPath expression). In this case, the portion of the data exposed as XML is the row where `employee_id` is 200. The URI can be used to access the data and construct an XML document that reflects the "XML view".

Figure 32-1 A DBUri Corresponds to an XML Visualization of Relational Data

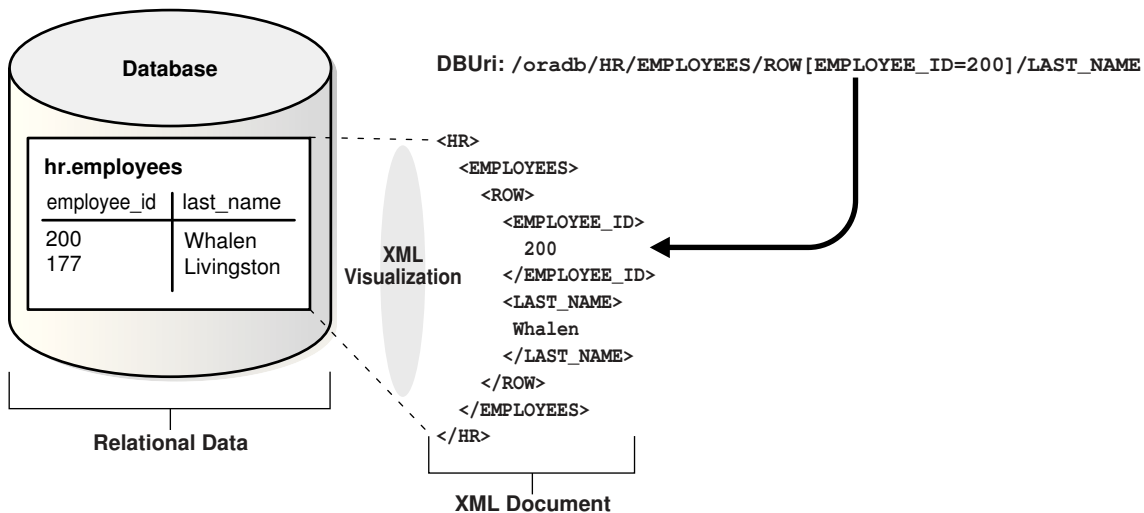

The XML elements in the "XML view" and the steps in the URI XPath expression both reflect the database table and column names. Note the use of **ROW** to indicate a row in the database table – both in the "XML view" and in the URI XPath expression.

Note also that the XPath expression contains a root-element step, `oradb`. This is used to indicate that the URI corresponds to a DBUri, not an HTTPUri or an XDBUri. Whenever this correspondence is understood from context, this XPath step can be skipped. For example, if it is known that the path in question is a path to database data, the following URIs are equivalent:

- `/oradb/HR/EMPLOYEES/ROW[EMPLOYEE_ID=200]/LAST_NAME`
- `/HR/EMPLOYEES/ROW[EMPLOYEE_ID=200]/LAST_NAME`

Whenever the URI context is not clear, however, you must use the prefix `/oradb` to distinguish a URI as corresponding to a DBUri. In particular, you must supply the prefix to `URIFACTORY PL/SQL` methods and to `DBUriServlet`.

See Also:

- [Create New Subtypes of URIType Using Package URIFACTORY](#) (page 32-21)
- [DBUriServlet](#) (page 32-27)
- [Generation of XML Data from Relational Data](#) (page 8-1) for other ways to generate XML from database data

32.6.2 DBUri URI Syntax

An XPath expression is a path into XML data that addresses one or more nodes. A DBUri exploits virtual XML visualization of the database to use a *simple form* of XPath expression as a URI to address database data. This is so, whether or not the data is XML.

Thus, for `DBURIType`, Oracle Database supports only a subset of the full XPath or XPointer syntax. There are no syntax restrictions for `XDBUri` XPath expressions. There is also an exception in the DBUri case: data in `XMLType` tables. For an `XMLType` table, the simple XPath form is used to address the table itself within the database. Then, to address particular XML data in the table, the remainder of the XPath expression can use the full XPath syntax. This exception applies only to `XMLType` tables, not to `XMLType` columns.

In any case, unlike an `XDBUri`, a DBUri URI does not use a number-sign (#) to separate the URL portion of a URI from a fragment (XPath) portion. `DBURIType` does not use URI fragments. Instead, the entire URI is treated as a (simple) XPath expression.

You can create DBUris to any database data to which you have access. XPath expressions such as the following are allowed:

- `/database_schema/table`
- `/database_schema/table/ROW[predicate_expression]/column`
- `/database_schema/table/ROW[predicate_expression]/object_column/attribute`
- `/database_schema/XMLType_table/ROW/XPath_expression`

In the last case, `XMLType_table` is an `XMLType` table, and `XPath_expression` is *any* XPath expression. For tables that are *not* `XMLType`, a DBUri XPath expression must end at a column (it cannot address specific data inside a column). This restriction includes `XMLType` columns, LOB columns, and `VARCHAR2` columns that contain XML data.

A DBUri XPath expression can do any of the following:

- Target an entire table.

For example, `/HR/EMPLOYEES` targets table `employees` of database schema `HR`.

- Include XPath predicates at any step in the path, except the database schema and table steps.

For example, `/HR/EMPLOYEES/ROW[EMPLOYEE_ID=200]/EMAIL` targets column `email` of table `HR.employees`, where `employee_id` is 200.

- Use the `text()` XPath node test on data with scalar content. This is the *only* node test that can be used, and it cannot be used with the table or row step.

The following can be used in DBUri (XPath) *predicate* expressions:

- Boolean operators `and`, `or`, and `not`
- Relational operators `<`, `>`, `<=`, `!=`, `>=`, `=`, `mod`, `div`, `*` (multiply)

A DBUri XPath expression *must* do all of the following:

- Use only the *child* XPath axis – other axes, such as *parent*, are not allowed.
- Either specify a database schema or specify `PUBLIC` to resolve the table name without a specific schema.
- Specify a database view or table name.
- Include a `ROW` step, if a database column is targeted.
- Identify a *single* data value, which can be an object-type instance or a collection.
- Result in well-formed XML when it is used to generate XML data using database data.

An example of a DBUri that does *not* result in well-formed XML is `/HR/EMPLOYEES/ROW/LAST_NAME`. It returns more than one `<LAST_NAME>` element fragment, with no single root element.

- Use *none* of the following:
 - `*` (wildcard)
 - `.` (self)
 - `..` (parent)
 - `//` (descendant or self)
 - XPath functions, such as `count`

A DBUri XPath expression can optionally be prefixed by `/oradb` or `/dburi` (the two are equivalent) to distinguish it. This prefix is case-insensitive. However, the rest of the DBUri XPath expression is *case-sensitive*, as are XPath expressions generally. Thus, for example, to specify table `HR.employees` as a DBUri XPath expression, you must use `HR/EMPLOYEES`, not `hr/employees` (or a mixed-case combination), because table and column names are uppercase, by default.

See Also:

<http://www.w3.org/TR/xpath> on XPath notation

32.6.3 DBUris are Scoped to a Database and Session

A DBUri is scoped to a given database session, so the same DBUri can give different results in the same query, depending on the session context (which user is connected and what privileges the user has).

The content of the XML “views” you have of the database, and hence of the XML documents that you can construct, reflects the permissions you have for accessing particular database data at a given time.

To complicate things a bit, there is also an XML element `PUBLIC`, under which database data is accessible without any database-schema qualification. This is a convenience feature, but it can also lead to some confusion if you forget that the XML views of the database for a given user depend on the specific access the user has to the database at a given time.

XML element `PUBLIC` corresponds to the use of a *public synonym*. For example, when queried by user `quine`, the following query tries to match table `foo` under database schema `quine`, but if no such table exists, it tries to match a public synonym named `foo`.

```
SELECT * FROM foo;
```

In the same way, XML element `PUBLIC` contains all of the database data visible to a given user and all of the data visible to that user through public synonyms. So, the same DBUri URI `/PUBLIC/FOO` can resolve to `quine.foo` when user `quine` is connected, and resolve to `curry.foo` when user `curry` is connected.

32.6.4 Using DBUris —Examples

A DBUri can identify a table, a row, a column in a row, or an attribute of an object column. Examples here show how to target different object types.

32.6.4.1 Targeting a Table Using a DBUri

An example uses a DBUri that targets a complete table. An XML document is returned that corresponds to the table contents. The top-level XML element is named for the table. The values of each row are enclosed in a `ROW` element.

This is shown in [Example 32-6](#) (page 32-17). You target a complete database table using this syntax:

```
/database_schema/table
```

Example 32-6 Targeting a Complete Table Using a DBUri

```
CREATE TABLE uri_tab (url URIType);
Table created.
```

```
INSERT INTO uri_tab VALUES
      (DBURIType.createURI('/HR/EMPLOYEES'));
1 row created.
```

```
SELECT e.url.getCLOB() FROM uri_tab e;
```

```
E.URL.GETCLOB()
-----
<?xml version="1.0"?>
<EMPLOYEES>
  <ROW>
    <EMPLOYEE_ID>100</EMPLOYEE_ID>
    <FIRST_NAME>Steven</FIRST_NAME>
    <LAST_NAME>King</LAST_NAME>
    <EMAIL>SKING</EMAIL>
    <PHONE_NUMBER>515.123.4567</PHONE_NUMBER>
    <HIRE_DATE>17-JUN-03</HIRE_DATE>
    <JOB_ID>AD_PRES</JOB_ID>
```

```

<SALARY>24000</SALARY>
<DEPARTMENT_ID>90</DEPARTMENT_ID>
</ROW>
<ROW>
<EMPLOYEE_ID>101</EMPLOYEE_ID>
<FIRST_NAME>Neena</FIRST_NAME>
<LAST_NAME>Kochhar</LAST_NAME>
<EMAIL>NKOCHHAR</EMAIL>
<PHONE_NUMBER>515.123.4568</PHONE_NUMBER>
<HIRE_DATE>21-SEP-05</HIRE_DATE>
<JOB_ID>AD_VP</JOB_ID>
<SALARY>17000</SALARY>
<MANAGER_ID>100</MANAGER_ID>
<DEPARTMENT_ID>90</DEPARTMENT_ID>
</ROW>
. . .

```

1 row selected.

32.6.4.2 Targeting a Row in a Table Using a DBUri

An example uses a DBUri that targets a single table row. The XPath predicate expression identifies the single table row that corresponds to employee number 200. The result is an XML document with ROW as the top-level element.

This is shown in [Example 32-7](#) (page 32-18). You target one or more specific rows of a table using this syntax:

```
/database_schema/table/ROW[predicate_expression]
```

Example 32-7 Targeting a Particular Row in a Table Using a DBUri

```

CREATE TABLE uri_tab (url URIType);
Table created.

INSERT INTO uri_tab VALUES
    (DBURIType.createURI('/HR/EMPLOYEES/ROW[EMPLOYEE_ID=200]'));
1 row created.

SELECT e.url.getCLOB() FROM uri_tab e;

E.URL.GETCLOB()
-----
<?xml version="1.0"?>
<ROW>
  <EMPLOYEE_ID>200</EMPLOYEE_ID>
  <FIRST_NAME>Jennifer</FIRST_NAME>
  <LAST_NAME>Whalen</LAST_NAME>
  <EMAIL>JWHALEN</EMAIL>
  <PHONE_NUMBER>515.123.4444</PHONE_NUMBER>
  <HIRE_DATE>17-SEP-03</HIRE_DATE>
  <JOB_ID>AD_ASST</JOB_ID>
  <SALARY>4400</SALARY>
  <MANAGER_ID>101</MANAGER_ID>
  <DEPARTMENT_ID>10</DEPARTMENT_ID>
</ROW>

1 row selected.

```

32.6.4.3 Targeting a Column Using a DBUri

You can target a given column, a given attribute of an object column, or an object column whose attributes have given values. Examples illustrate these possibilities.

You can target a specific column, using this syntax:

```
/database_schema/table/ROW[predicate_expression]/column
```

You can target a specific attribute of an object column, using this syntax:

```
/database_schema/table/ROW[predicate_expression]/object_column/attribute
```

You can target a specific object column whose attributes have specific values, using this syntax:

```
/database_schema/table/ROW[predicate_expression_with_attributes]/object_column
```

[Example 32-8](#) (page 32-19) uses a DBUri that targets column `last_name` for the same employee as in [Example 32-7](#) (page 32-18). The top-level XML element is named for the targeted column.

[Example 32-9](#) (page 32-19) uses a DBUri that targets a `CUST_ADDRESS` object column containing city and postal code attributes with certain values. The top-level XML element is named for the column, and it contains child elements for each of the object attributes.

Example 32-8 Targeting a Specific Column Using a DBUri

```
CREATE TABLE uri_tab (url URIType);
Table created.

INSERT INTO uri_tab VALUES
    (DBURIType.createURI('/HR/EMPLOYEES/ROW[EMPLOYEE_ID=200]/LAST_NAME'));
1 row created.

SELECT e.url.getCLOB() FROM uri_tab e;

E.URL.GETCLOB()
-----
<?xml version="1.0"?>
  <LAST_NAME>Whalen</LAST_NAME>

1 row selected.
```

Example 32-9 Targeting an Object Column with Specific Attribute Values Using a DBUri

```
CREATE TABLE uri_tab (url URIType);
Table created.

INSERT INTO uri_tab VALUES
    (DBURIType.createURI(
        '/OE/CUSTOMERS/ROW[CUST_ADDRESS/CITY="Poughkeepsie" and
        CUST_ADDRESS/POSTAL_CODE=12601]/CUST_ADDRESS'));
1 row created.

SELECT e.url.getCLOB() FROM uri_tab e;

E.URL.GETCLOB()
-----
<?xml version="1.0"?>
```

```

<CUST_ADDRESS>
  <STREET_ADDRESS>33 Fulton St</STREET_ADDRESS>
  <POSTAL_CODE>12601</POSTAL_CODE>
  <CITY>Poughkeepsie</CITY>
  <STATE_PROVINCE>NY</STATE_PROVINCE>
  <COUNTRY_ID>US</COUNTRY_ID>
</CUST_ADDRESS>

```

1 row selected.

The DBUri here identifies the object that has a CITY attribute with Poughkeepsie as value and a POSTAL_CODE attribute with 12601 as value.

32.6.4.4 Retrieving the Text Value of a Column Using a DBUri

In many cases, it can be useful to retrieve only the text values of a column and not the enclosing tags. For example, if XSLT stylesheets are stored in a CLOB column, you can retrieve the document text without having any enclosing column-name tags. An example illustrates this.

You can use the `text()` XPath node test for this. It specifies that you want only the text value of the node. Use the following syntax:

```
/oradb/database_schema/table/ROW[predicate_expression]/column/text()
```

Example 32-10 (page 32-20) retrieves the text value of the employee `last_name` column for employee number 200, without the XML tags.

Example 32-10 Retrieve Only the Text Value of a Node Using a DBUri

```
CREATE TABLE uri_tab (url URIType);
Table created.
```

```
INSERT INTO uri_tab VALUES
  (DBURIType.createURI(
    '/HR/EMPLOYEES/ROW[EMPLOYEE_ID=200]/LAST_NAME/text()'));

```

1 row created.

```
SELECT e.url.getCLOB() FROM uri_tab e;
```

```
E.URL.GETCLOB()
-----
Whalen
```

1 row selected.

32.6.4.5 Targeting a Collection Using a DBUri

You can target a database collection, such as an ordered collection table (OCT). You must, however, target the entire collection – you cannot target individual members.

When a collection is targeted, the XML document produced by the DBUri contains each collection member as an XML element, with all such elements enclosed in a element named for the *type* of the collection.

Example 32-11 (page 32-21) uses a DBUri that targets a collection of numbers. The top-level XML element is named for the collection, and its children are named for the collection *type* (NUMBER).

Example 32-11 Targeting a Collection Using a DBUri

```

CREATE TYPE num_collection AS VARRAY(10) OF NUMBER;
/
Type created.

CREATE TABLE orders (item VARCHAR2(10), quantities num_collection);
Table created.

INSERT INTO orders VALUES ('boxes', num_collection(3, 7, 4, 9));
1 row created.

SELECT * FROM orders;

ITEM
----
QUANTITIES
-----
boxes
NUM_COLLECTION(3, 7, 4, 9)

1 row selected.

SELECT DBURITYPE('/HR/ORDERS/ROW[ITEM="boxes"]/QUANTITIES').getCLOB() FROM DUAL;

DBURITYPE('/HR/ORDERS/ROW[ITEM="BOXES"]/QUANTITIES').GETCLOB()
-----
<?xml version="1.0"?>
<QUANTITIES>
<NUMBER>3</NUMBER>
<NUMBER>7</NUMBER>
<NUMBER>4</NUMBER>
<NUMBER>9</NUMBER>
</QUANTITIES>

1 row selected.

```

32.7 Create New Subtypes of URIType Using Package URIFACTORY

You can define your own subtypes of URIType that correspond to particular protocols. You can use PL/SQL package URIFACTORY to obtain the URI of a URIType instance, escape characters in a URI string or remove such escaping, and register or unregister a type name for handling a given URL.

Additional PL/SQL methods are listed in [Table 32-2](#) (page 32-21).

Table 32-2 URIFACTORY PL/SQL Methods

PL/SQL Method	Description
<code>getURI()</code>	Returns the URI of the URIType instance.
<code>escapeURI()</code>	Escapes the URI string by replacing characters that are not permitted in URIs by their equivalent escape sequence.
<code>unescapeURI()</code>	Removes escaping from a given URI.
<code>registerURLHandler()</code>	Registers a particular type name for handling a particular URL. This is called by <code>getURI()</code> to generate an instance of the type. A Boolean argument can be used to indicate that the prefix must be stripped off before calling the appropriate type constructor.

Table 32-2 (Cont.) URIFACTORY PL/SQL Methods

PL/SQL Method	Description
<code>unregisterURLHandler()</code>	Unregisters a URL handler.

Of particular note is that you can use package `URIFACTORY` to define new subtypes of type `URIType`. You can then use those subtypes to provide specialized processing of URIs. In particular, you can define `URIType` subtypes that correspond to particular protocols – `URIFACTORY` then recognizes and processes instances of those subtypes accordingly.

Defining new types and creating database columns specific to the new types has these advantages:

- It provides an implicit *constraint* on the columns to contain only instances of those types. This can be useful for implementing specialized indexes on a column for specific protocols. For a `DBUri`, for instance, you can implement specialized indexes that fetch data directly from disk blocks, rather than executing SQL queries.
- You can have different constraints on different columns, based on the type. For a `HTTPUri`, for instance, you can define proxy and firewall constraints on a column, so that any access through the HTTP uses the proxy server.

32.7.1 Registering New URIType Subtypes with Package URIFACTORY

To provide specialized processing of URIs, you define and register a new `URIType` subtype.

1. Create the new type using SQL statement `CREATE TYPE`. The type must implement PL/SQL method `createURI()`.
2. Optionally override the default methods, to perform specialized processing when retrieving data or to transform the XML data before displaying it.
3. Choose a new URI prefix, to identify URIs that use this specialized processing.
4. Register the new prefix using PL/SQL method `registerURLHandler()`, so that package `URIFACTORY` can create an instance of your new subtype when it receives a URI starting with the new prefix you defined.

After the new subtype is defined, a URI with the new prefix is recognized by `URIFACTORY` methods, and you can create and use instances of the new type.

For example, suppose that you define a new protocol prefix, `ecom://`, and define a subtype of `URIType` to handle it. Perhaps the new subtype implements some special logic for PL/SQL method `getCLOB()`, or perhaps it makes some changes to XML tags or data in method `getXML()`. After you register prefix `ecom://` with `URIFACTORY`, a call to `getURI()` generates an instance of the new `URIType` subtype for a URI with that prefix.

[Example 32-12](#) (page 32-23) creates a new type, `ECOMURIType`, to handle a new protocol, `ecom://`. The example stores three different kinds of URIs in a single table: an `HTTPUri`, a `DBUri`, and an instance of the new type, `ECOMURIType`. To run this example, you would need to define each of the `ECOMURIType` member functions.

Example 32-12 URIFACTORY: Registering the ECOM Protocol

```

CREATE TABLE url_tab (urlcol varchar2(80));
Table created.

-- Insert an HTTP URL reference
INSERT INTO url_tab VALUES ('http://www.oracle.com/');
1 row created.

-- Insert a DBUri
INSERT INTO url_tab VALUES ('/oradb/HR/EMPLOYEES/ROW[FIRST_NAME="Jack"]');
1 row created.

-- Create a new type to handle a new protocol called ecom://
-- This is just an example template. For this to run, the implementations
-- of these functions must be specified.
CREATE OR REPLACE TYPE ECOMURITYPE UNDER SYS.URITYPE (
    OVERRIDING MEMBER FUNCTION getCLOB RETURN CLOB,
    OVERRIDING MEMBER FUNCTION getBLOB RETURN BLOB,
    OVERRIDING MEMBER FUNCTION getExternalURL RETURN VARCHAR2,
    OVERRIDING MEMBER FUNCTION getURI RETURN VARCHAR2,
    -- Must have this for registering with the URL handler
    STATIC FUNCTION createURI(url IN VARCHAR2) RETURN ECOMURITYPE);
/

-- Register a new handler for the ecom:// prefixes
BEGIN
    -- The handler type name is ECOMURITYPE; schema is HR
    -- Ignore the prefix case, so that URIFACTORY creates the same subtype
    -- for URIs beginning with ECOM://, ecom://, eCom://, and so on.
    -- Strip the prefix before calling PL/SQL method createURI(),
    -- so that the string 'ecom://' is not stored inside the
    -- ECOMURITYPE object. It is added back automatically when
    -- you call ECOMURITYPE.getURI().
    URIFACTORY.registerURLHandler (prefix => 'ecom://',
                                   schemaname => 'HR',
                                   typename => 'ECOMURITYPE',
                                   ignoreprefixcase => TRUE,
                                   stripprefix => TRUE);
END;
/
PL/SQL procedure successfully completed.

-- Insert this new type of URI into the table
INSERT INTO url_tab VALUES ('ECOM://company1/company2=22/comp');
1 row created.

-- Use the factory to generate an instance of the appropriate
-- subtype for each URI in the table.

-- You would need to define the member functions for this to work:
SELECT urifactory.getURI(urlcol) FROM url_tab;

-- This would generate:
HTTPURITYPE('www.oracle.com'); -- an HTTPUri
DBURITYPE('/oradb/HR/EMPLOYEES/ROW[FIRST_NAME="Jack"]', null); -- a DBUri
ECOMURITYPE('company1/company2=22/comp'); -- an ECOMURITYPE instance

```

32.8 SYS_DBURIGEN SQL Function

You can create a DBUri by providing an XPath expression to constructor DBURITYPE or to appropriate URIFACTORY PL/SQL methods. With Oracle SQL function

`sys_DburiGen`, you can alternatively create a DBUri using an *XPath* that is composed from database columns and their values.

Oracle SQL function `sys_DburiGen` takes as its argument one or more database columns or attributes, and optionally a rowid, and generates a DBUri that targets a particular column or row object. Function `sys_DburiGen` takes an additional parameter that indicates whether the text value of the node is needed. See [Figure 32-2](#) (page 32-24).

Figure 32-2 SYS_DBURIGEN Syntax

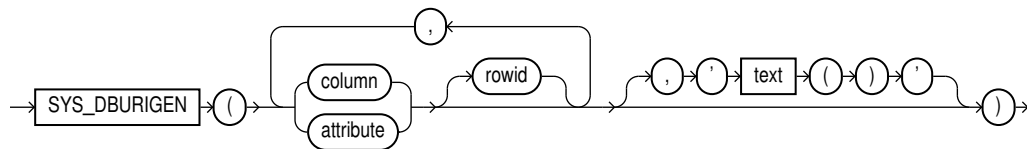

All columns or attributes referenced must reside in the same table. They must each reference a unique value. If you specify multiple columns, then the initial columns identify the row, and the last column identifies the column within that row. If you do not specify a database schema, then the table name is interpreted as a public synonym.

See Also:

Oracle Database SQL Language Reference

[Example 32-13](#) (page 32-24) uses Oracle SQL function `sys_DburiGen` to generate a DBUri that targets column `email` of table `HR.employees` where `employee_id` is 206:

Example 32-13 SYS_DBURIGEN: Generating a DBUri that Targets a Column

```
SELECT sys_DburiGen(employee_id, email)
FROM employees
WHERE employee_id = 206;

SYS_DBURIGEN(EMPLOYEE_ID,EMAIL)(URL, SPARE)
-----
DBURITYPE('/PUBLIC/EMPLOYEES/ROW[EMPLOYEE_ID = "206"]/EMAIL', NULL)

1 row selected.
```

32.8.1 Rules for Passing Columns or Object Attributes to SYS_DBURIGEN

A column or attribute passed to Oracle SQL function `sys_DburiGen` must obey certain rules.

- *Same table:* All columns referenced in function `sys_DburiGen` must come from the same table or view.
- *Unique mapping:* The column or object attribute must be uniquely mappable back to the table or view from which it came. The only virtual columns allowed are those produced with `value` or `ref`. The column can come from a subquery with a SQL `TABLE` collection expression, that is, `TABLE(. . .)`, or from an inline view (as long as the inline view does not rename the columns).

See *Oracle Database SQL Language Reference* for information about the SQL `TABLE` collection expression.

- *Key columns:* Either the rowid or a set of key columns must be specified. The list of key columns is not required to be declared as a unique or primary key, as long as the columns uniquely identify a particular row in the result.
- **PUBLIC** *element:* If the table or view targeted by the rowid or key columns does not specify a database schema, then the PUBLIC keyword is used. When a DBUri is accessed, the table name resolves to the same table, synonym, or database view that was visible by that name when the DBUri was created.
- *Optional text() argument:* By default, DBURIType constructs an XML document. Use text() as the third argument to sys_DburiGen to create a DBUri that targets a text node (no XML elements). For example:

```
SELECT sys_DburiGen(employee_id, last_name, 'text()') FROM hr.employees,
       WHERE employee_id=200;
```

This constructs a DBUri with the following URI:

```
/HR/EMPLOYEES/ROW[EMPLOYEE_ID=200]/LAST_NAME/text()
```

- *Single-column argument:* If there is a single-column argument, then the column is used as both the key column to identify the row and the referenced column.

The query in [Example 32-14](#) (page 32-25) uses employee_id as both the key column and the referenced column. It generates a DBUri that targets the row with employee_id 200.

Example 32-14 *Passing Columns with Single Arguments to SYS_DBURIGEN*

```
SELECT sys_DburiGen(employee_id) FROM employees
       WHERE employee_id=200;

SYS_DBURIGEN(EMPLOYEE_ID)(URL, SPARE)
-----
DBURITYPE('/PUBLIC/EMPLOYEES/ROW[EMPLOYEE_ID='200']/EMPLOYEE_ID', NULL)

1 row selected.
```

32.8.2 Using SQL Function SYS_DBURIGEN: Examples

Examples are presented that use SQL function sys_DburiGen to insert database references, return partial results from a large column, and return URLs to inserted objects.

32.8.2.1 Inserting Database References Using SYS_DBURIGEN

You can use SQL function sys_DburiGen to insert DBUris that reference specific database data. An example illustrates this.

Example 32-15 *Inserting Database References Using SYS_DBURIGEN*

```
CREATE TABLE doc_list_tab (docno NUMBER PRIMARY KEY, doc_ref SYS.DBURIType);
Table created.

-- Insert a DBUri that targets the row with employee_id=177
INSERT INTO doc_list_tab VALUES(1001, (SELECT sys_DburiGen(rowid, employee_id)
                                       FROM employees WHERE employee_id=177));

1 row created.

-- Insert a DBUri that targets the last_name column of table employees
INSERT INTO doc_list_tab VALUES(1002,
                                 (SELECT sys_DburiGen(employee_id, last_name)
```

```

FROM employees WHERE employee_id=177));

1 row created.

SELECT * FROM doc_list_tab;

      DOCNO
-----
DOC_REF(URL, SPARE)
-----
      1001
DBURITYPE('/PUBLIC/EMPLOYEES/ROW[ROWID=' 'AAAQCcAAFAAAAABSABN' ']/EMPLOYEE_ID', NULL)

      1002
DBURITYPE('/PUBLIC/EMPLOYEES/ROW[EMPLOYEE_ID=' '177' ']/LAST_NAME', NULL)

2 rows selected.

```

32.8.2.2 Returning Partial Results Using SYS__DBURIGEN

When selecting data from a large column, you might sometimes want to retrieve only a portion of the result, and create a URL that provides access to the full column.

For example, consider the case of a travel story website. If travel stories are stored in a table and users search for a set of relevant stories, you do not want to list each entire story in the search-result page. Instead, you might show just the first 20 characters of each story, to represent the gist, and then return a URL to the full story. This can be done as follows:

[Example 32-16](#) (page 32-26) creates the travel story table.

[Example 32-17](#) (page 32-26) creates a function that returns only the first 20 characters from the story.

[Example 32-18](#) (page 32-26) creates a view that selects only the first twenty characters from the travel story, and returns a DBUri to the story column.

Example 32-16 Creating the Travel Story Table

```

CREATE TABLE travel_story (story_name VARCHAR2(100), story CLOB);
Table created.

INSERT INTO travel_story
VALUES ('Egypt', 'This is the story of my time in Egypt...');
1 row created.

```

Example 32-17 A Function that Returns the First 20 Characters

```

CREATE OR REPLACE FUNCTION charfunc(clobval IN CLOB) RETURN VARCHAR2 IS
res VARCHAR2(20);
amount NUMBER := 20;
BEGIN
DBMS_LOB.read(clobval, amount, 1, res);
RETURN res;
END;
/
Function created.

```

Example 32-18 Creating a Travel View for Use with SYS_DBURIGEN

```

CREATE OR REPLACE VIEW travel_view AS
SELECT story_name, charfunc(story) short_story,
sys_DburiGen(story_name, story, 'text()') story_link
FROM travel_story;

```



```

View created.

SELECT * FROM travel_view;

STORY_NAME
-----
SHORT_STORY
-----
STORY_LINK(URL, SPARE)
-----
Egypt
This is the story of
DBURITYPE('/PUBLIC/TRAVEL_STORY/ROW[STORY_NAME='Egypt']/STORY/text()', NULL)

1 row selected.

```

32.8.2.3 Returning URLs to Inserted Objects Using SYS_DBURIGEN

You can use Oracle SQL function `sys_DburiGen` in the `RETURNING` clause of DML statements to retrieve the URL of an object as it is inserted.

In [Example 32-19](#) (page 32-27), whenever a document is inserted into table `clob_tab`, its URL is inserted into table `uri_tab`. This is done using Oracle SQL function `sys_DburiGen` in the `RETURNING` clause of the `INSERT` statement.

Example 32-19 Retrieving a URL Using SYS_DBURIGEN in RETURNING Clause

```

CREATE TABLE clob_tab (docid NUMBER, doc CLOB);
Table created.

```

```

CREATE TABLE uri_tab (docs SYS.DBURITYPE);
Table created.

```

In PL/SQL, specify the storage of the URL of the inserted document as part of the insertion operation, using the `RETURNING` clause and `EXECUTE IMMEDIATE`:

```

DECLARE
  ret SYS.DBURITYPE;
BEGIN
  -- execute the insert operation and get the URL
  EXECUTE IMMEDIATE
    'INSERT INTO clob_tab VALUES (1, ''TEMP CLOB TEST'')
     RETURNING sys_DburiGen(docid, doc, ''text()'') INTO :1'
    RETURNING INTO ret;
  -- Insert the URL into uri_tab
  INSERT INTO uri_tab VALUES (ret);
END;
/

SELECT e.docs.getURL() FROM hr.uri_tab e;
E.DOCS.GETURL()
-----
/ORADB/PUBLIC/CLOB_TAB/ROW[DOCID='1']/DOC/text()

1 row selected.

```

32.9 DBUriServlet

You can retrieve repository resources using the Oracle XML DB HTTP server. Oracle Database also includes a servlet, **DBUriServlet**, that makes any kind of database data available through HTTP(S) URLs. The data can be returned as plain text, HTML, or XML.

A Web client or application can access such data without using SQL or a specialized database API. You can retrieve the data by linking to it on a Web page or by requesting it through HTTP-aware APIs of Java, PL/SQL, and Perl. You can display or process the data using an application such as a Web browser or an XML-aware spreadsheet. DBUriServlet can generate content that is XML data or not, and it can transform the result using XSLT stylesheets.

You make database data Web-accessible by using a URI that is composed of a servlet address (URL) plus a DBUri URI that specifies which database data to retrieve. This is the syntax, where `http://server:port` is the URL of the servlet (server and port), and `/oradb/database_schema/table` is the DBUri URI (any DBUri URI can be used):

```
http://server:port/oradb/database_schema/table
```

When using XPath notation in a URL for the servlet, you might need to escape certain characters. You can use URITYPE PL/SQL method `getExternalURL()` to do this.

You can either use `DBUriServlet`, which is pre-installed as part of Oracle XML DB, or write your own servlet that runs on a servlet engine. The servlet reads the URI portion of the invoking URL, creates a DBUri using that URI, calls URITYPE PL/SQL methods to retrieve the data, and returns the values in a form such as a Web page, an XML document, or a plain-text document.

The MIME type to use is specified to the servlet through the URI:

- By default, the servlet produces MIME types `text/xml` and `text/plain`. If the DBUri path ends in `text()`, then `text/plain` is used. Otherwise, an XML document is generated with MIME type `text/xml`.
- You can override the default MIME type, setting it to `binary/x-jpeg` or some other value, by using the `contenttype` argument to the servlet.

See Also:

[Guidelines for Oracle XML DB Applications in Java](#) (page 31-1), for information about Oracle XML DB servlets

[Table 32-3](#) (page 32-28) describes each of the optional URL parameters you can pass to DBUriServlet to customize its output.

Table 32-3 DBUriServlet: Optional Arguments

Argument	Description
<code>rowsettag</code>	Changes the default root tag name for the XML document. For example: <code>http://server:8080/oradb/HR/EMPLOYEES?rowsettag=OracleEmployees</code>
<code>contenttype</code>	Specifies the MIME type of the generated document. For example: <code>http://server:8080/oradb/HR/EMPLOYEES?contenttype=text/plain</code>

Table 32-3 (Cont.) DBUriServlet: Optional Arguments

Argument	Description
<code>transform</code>	<p>Passes a URL to <code>URIFACTORY</code>, which retrieves the XSLT stylesheet at that location. This stylesheet is then applied to the XML document being returned by the servlet. For example:</p> <pre>http://server:8080/oradb/HR/EMPLOYEES?transform= /oradb/QUINE/XSL/DOC/text()&contentType=text/html¹</pre>

¹ This URL is split across two lines for the purpose of documentation.

32.9.1 Overriding the MIME Type Using a URL

You can override MIME content type by using a URL that passes a different MIME type to the servlet as the `contentType` parameter.

To retrieve column `employee_id` of table `employee`, you can use a URL such as one of the following, where computer `server.oracle.com` is running Oracle Database with a Web service listening to requests on port 8080. Step `oradb` is the virtual path that maps to the servlet.

- `http://server.oracle.com:8080/oradb/QUINE/A/ROW[B=200]/C/text()`

Produces a content type of `text/plain`

- `http://server.oracle.com:8080/oradb/QUINE/A/ROW[B=200]/C`

Produces a content type of `text/xml`

To override the content type, you can use a URL that passes `text/html` to the servlet as the `contentType` parameter:

- `http://server.oracle.com:8080/oradb/QUINE/A/ROW[B=200]/C?contentType=text/html`

Produces a content type of `text/html`

32.9.2 Customizing DBUriServlet

To customize DBUriServlet you modify the Oracle XML DB configuration file, `xdbconfig.xml`.

See Also:

- [Guidelines for Oracle XML DB Applications in Java](#) (page 31-1)
 - [Administration of Oracle XML DB](#) (page 34-1)
 - [Oracle XML DB Configuration API](#) (page 34-10)
 - *Oracle Database 2 Day + Security Guide* for information about database schema XDB
-
-

You can edit the Oracle XML DB configuration file, `xdbconfig.xml`, using database schema (user account) XDB with WebDAV, FTP, Oracle Enterprise Manager, or PL/

SQL. To update the file using FTP or WebDAV, download the document, edit it, and save it back into the database. PL/SQL package `DBMS_XDB_CONFIG` provides a particularly convenient way to access the file, and it provides subprograms that perform specific configuration modifications. For example, you can use `DBMS_XDB_CONFIG.deleteServletMapping` to remove a servlet mapping.

DBUriServlet is installed at `/oradb/*`, which is the address specified in the `servlet-pattern` tag of `xdbconfig.xml`. The asterisk (*) is necessary to indicate that any path following `oradb` is to be mapped to the same servlet. `oradb` is published as the virtual path. You can change the path that is used to access the servlet.

In [Example 32-20](#) (page 32-30), the configuration file is modified to install DBUriServlet under `/dburi/*`. (The long XPath expression has been split here for documentation purposes. It actually needs to be on a single line.)

Security parameters, the servlet display-name, and the description can also be customized in configuration file `xdbconfig.xml`. The servlet can be removed by deleting its `servlet-pattern`. This can also be done using XQuery Update to update the `servlet-mapping` element to NULL.

Example 32-20 Changing the Installation Location of DBUriServlet

```
DECLARE
  doc XMLType;
  doc2 XMLType;
BEGIN
  doc := DBMS_XDB_CONFIG.cfg_get();
  SELECT XMLQuery('declare default element namespace
    "http://xmlns.oracle.com/xdb/xdbconfig.xsd";
    copy $i := $doc modify
    for $j in
  $i/xdbconfig/sysconfig/protocolconfig/httpconfig/webappconfig/servletconfig/servlet-mappings11
/servlet-mapping[servlet-name="DBUriServlet"]/servlet-pattern
    return replace value of node $j with $i/dburi/*
    return $i'
    PASSING DBMS_XDB_CONFIG.cfg_get() AS "doc"
    RETURNING CONTENT) INTO doc2 FROM DUAL;
  DBMS_XDB_CONFIG.cfg_update(doc2);
COMMIT;
END;
/
```

32.9.3 Using Roles for DBUriServlet Security

Servlet security is handled by Oracle Database using roles. When users log in to the servlet, they use their database user name and password. The servlet checks to ensure that the user logging has one of the roles specified in the configuration file using parameter `security-role-ref`).

By default, the servlet is available to role `authenticatedUser`, and any user who logs into the servlet with a valid database password has this role.

The role parameter can be changed to restrict access to any specific database roles. To change from the default `authenticatedUser` role to a role that you have created, you modify the Oracle XML DB configuration file.

[Example 32-21](#) (page 32-31) changes the default role `authenticatedUser` to role `servlet-users` (which you must have created).

¹ This XQuery expression is split across two lines only for the purpose of documentation.

Example 32-21 Restricting Servlet Access to a Database Role

```

DECLARE
  doc XMLType;
  doc2 XMLType;
  doc3 XMLType;
BEGIN
  doc := DBMS_XDB_CONFIG.cfg_get();
  SELECT XMLQuery('copy $i := $p1 modify
    (for $j in $i/xdbconfig/sysconfig/protocolconfig/httpconfig/webappconfig/
servletconfig/22
servlet-list/servlet[servlet-name="DBUriServlet"]/security-role-ref/role-name
    return replace value of node $j with $p2)
    return $i'
    PASSING DOC AS "p1", 'servlet-users' AS "p2" RETURNING CONTENT)
  INTO doc2 FROM DUAL;
  SELECT XMLQuery('copy $i := $p1 modify
    (for $j in $i/xdbconfig/sysconfig/protocolconfig/httpconfig/webappconfig/
servletconfig/
servlet-list/servlet[servlet-name="DBUriServlet"]/security-role-ref/role-link
    return replace value of node $j with $p2)
    return $i'
    PASSING DOC2 AS "p1", 'servlet-users' AS "p2" RETURNING CONTENT)
  INTO doc3 FROM DUAL;
  DBMS_XDB_CONFIG.cfg_update(doc3);
  COMMIT;
END;
/

```

32.9.4 Configuring Package URIFACTORY to Handle DBUris

To improve efficiency, you can teach URIFACTORY that a URI of a given form represents database access and so should be realized as a DBUri, not an HTTPUri. You do this by registering a handler for the URI as a prefix, specifying `DBURITYPE` as the type of instance to generate.

A URL such as `http://server/servlets/oradb` is handled by `DBUriServlet` (or by a custom servlet). When a URL such as this is stored as a `URITYPE` instance, it is generally desirable to use subtype `DBURITYPE`, since this URI targets database data.

However, if a `URITYPE` instance is created using the methods of PL/SQL package URIFACTORY then, by default, the subtype used is `HTTPURITYPE`, not `DBURITYPE`. This is because URIFACTORY looks only at the URI prefix, sees `http://`, and assumes that the URI targets a Web page. This results in unnecessary layers of communication and perhaps extra character conversions.

To teach URIFACTORY that URIs of the given form represent database accesses and so should be realized as DBUris, not HTTPUris, you register a handler for the URIs as a prefix, specifying `DBURITYPE` as the type of instance to generate.

[Example 32-22](#) (page 32-32) effectively tells URIFACTORY that any URI string starting with `http://server/servlets/oradb` corresponds to a database access.

After you execute this code, all `getURI()` calls in the same session automatically create DBUris for any URI strings with prefix `http://server/servlets/oradb`.

²² This XQuery expression is split across two lines only for the purpose of documentation.

See Also:

Oracle Database PL/SQL Packages and Types Reference for information about URIFACTORY functions

Example 32-22 Registering a Handler for a DBUri Prefix

```
BEGIN
  URIFACTORY.registerURLHandler('http://server/servlets/oradb',
                                'SYS', 'DBURITYPE', true, true);
END;
/
```

32.9.5 Table or View Access from a Web Browser Using DBUri Servlet

Oracle XML DB includes the DBUri servlet, which lets you access the content of any table or view directly from a web browser. It uses DBURITYPE to generate a simple XML document from the table contents. The servlet is C language-based and installed in the Oracle XML DB HTTP server.

By default, the servlet is installed under the virtual directory /oradb.

The URL passed to the DBUri Servlet is an extension of the URL passed to the DBURITYPE. The URL is extended with the address and port number of the Oracle XML DB HTTP server and the virtual root that directs HTTP(S) requests to the DBUri servlet. The default configuration for this is /oradb.

The URL `http://localhost:8080/oradb/HR/DEPARTMENTS` would thus return an XML document containing the contents of the DEPARTMENTS table in the HR database schema. This assumes that the Oracle XML DB HTTP server is running on port 8080, the virtual root for the DBUri servlet is /oradb, and that the user making the request has access to the HR database schema.

DBUri servlet accepts parameters that allow you to specify the name of the ROW tag and MIME-type of the document that is returned to the client.

Content in XMLTYPE table or view can also be accessed through the DBUri servlet. When the URL passed to the DBUri servlet references an XMLTYPE table or XMLTYPE view the URL can be extended with an XPath expression that can determine which documents in the table or row are returned. The XPath expression appended to the URL can reference any node in the document.

XML generated by DBUri servlet can be transformed using the XSLT processor built into Oracle XML DB. This lets XML that is generated by DBUri servlet be presented in a more legible format such as HTML.

See Also:

[DBUriServlet](#) (page 32-27)

XSLT stylesheet processing is initiated by specifying a transform parameter as part of the URL passed to DBUri servlet. The stylesheet is specified using a URI that references the location of the stylesheet within database. The URI can either be a DBURITYPE value that identifies a XMLTYPE column in a table or view, or a path to a document stored in Oracle XML DB Repository. The stylesheet is applied directly to the generated XML before it is returned to the client. When using DBUri servlet for

XSLT processing, it is good practice to use the `contentType` parameter to explicitly specify the MIME type of the generated output.

If the XML document being transformed is stored as an XML schema-based `XMLType` instance, then Oracle XML DB can reduce the overhead associated with XSL transformation by leveraging the capabilities of the lazily loaded virtual DOM.

The root of the URL is `/oradb`, so the URL is passed to the `DBUri` servlet that accesses the `purchaseorder` table in the `SCOTT` database schema, rather than as a resource in Oracle XML DB Repository. The URL includes an XPath expression that restricts the result set to those documents where node `/PurchaseOrder/Reference/text()` contains the value specified in the predicate. The `contentType` parameter sets the MIME type of the generated document to `text/xml`.

Native Oracle XML DB Web Services

Your applications can access Oracle Database using native Oracle XML DB Web services.

- [Overview of Native Oracle XML DB Web Services](#) (page 33-1)
- [Configuring and Enabling Web Services for Oracle XML DB](#) (page 33-2)
- [Query Oracle XML DB Using a Web Service](#) (page 33-4)
- [Access to PL/SQL Stored Procedures Using a Web Service](#) (page 33-6)

33.1 Overview of Native Oracle XML DB Web Services

Web services provide a standard way for applications to exchange information over the Internet and access services that implement business logic. Your applications can access Oracle Database using native Oracle XML DB Web services.

One available service lets you issue SQL and XQuery queries and receive results as XML data. Another service provides access to all PL/SQL stored functions and procedures.

You can customize the input and output document formats when you use the latter service. If you do that then the WSDL is automatically generated by the native database Web services engine.

SOAP 1.1 is the version supported by Oracle XML DB. Applications use HTTP method POST to submit SOAP requests to native Oracle XML DB Web services. You can configure the locations of all native Oracle XML DB Web services and WSDL documents using the Oracle XML DB configuration file, `xdbconfig.xml`. You can also configure security settings for the Web services using the same configuration file.

You can use the `Accept-Charsets` field of the input HTTP header to specify the character set of Web-service responses. If this header field is omitted, then responses are in the database character set. The language of the input document and any error responses is the locale language of the database.

Error handling for native Oracle XML DB Web services uses the SOAP framework for faults.

See Also:

- <http://www.w3.org/2002/ws/> for more information on Web services
 - The W3C SOAP primer, <http://www.w3.org/TR/2000/NOTE-SOAP-20000508>, for more information on SOAP
 - <http://www.w3.org/TR/wsdl> for information on the Web Services Description Language (WSDL)
 - <http://www.w3.org/TR/2003/REC-soap12-part0-20030624/#L11549> for information on SOAP fault handling
 - [Configuration of Oracle XML DB Using xdbconfig.xml](#) (page 34-5)
-

33.2 Configuring and Enabling Web Services for Oracle XML DB

To make Web services available, you must have the Oracle XML DB HTTP server up and running, and you must explicitly add Web service configuration. Then, to allow specific users to use Web services, you must grant them appropriate roles.

1. Configure Web services – see "[Configuring Web Services for Oracle XML DB](#) (page 33-2)".
2. Enable Web services for specific users, by granting them appropriate roles – [Enabling Web Services for a Specific User](#) (page 33-3).

For security reasons, Oracle XML DB is not preconfigured with native Web services enabled.

See Also:

[HTTP\(S\) and Oracle XML DB Protocol Server](#) (page 28-20) for information about Oracle XML DB HTTP server

33.2.1 Configuring Web Services for Oracle XML DB

To make Web services available for Oracle XML DB, configure the servlet by logging on as user `SYS` and adding the servlet configuration to your Oracle XML DB configuration file, `xdbconfig.xml`. Then use procedures in PL/SQL package `DBMS_XDB_CONFIG` to add the servlet that is named by the servlet configuration.

The servlet configuration to add is shown as the query output of [Example 33-2](#) (page 33-3).

[Example 33-1](#) (page 33-3) shows how to use procedures in PL/SQL package `DBMS_XDB_CONFIG` to add the servlet. [Example 33-2](#) (page 33-3) shows how to verify that the servlet was added correctly.

See Also:

[Configuration of Oracle XML DB Using xdbconfig.xml](#) (page 34-5) for more information about configuring Oracle XML DB with `xdbconfig.xml`

Example 33-1 Adding a Web Services Configuration Servlet

```

DECLARE
  SERVLET_NAME VARCHAR2(32) := 'orawsv';
BEGIN
  DBMS_XDB_CONFIG.deleteServletMapping(SERVLET_NAME);
  DBMS_XDB_CONFIG.deleteServlet(SERVLET_NAME);
  DBMS_XDB_CONFIG.addServlet(
    NAME      => SERVLET_NAME,
    LANGUAGE => 'C',
    DISPNAME => 'Oracle Query Web Service',
    DESCRIPT  => 'Servlet for issuing queries as a Web Service',
    SCHEMA   => 'XDB');
  DBMS_XDB_CONFIG.addServletSecRole(SERVNAME => SERVLET_NAME,
    ROLENAME => 'XDB_WEBSERVICES',
    ROLELINK => 'XDB_WEBSERVICES');
  DBMS_XDB_CONFIG.addServletMapping(PATTERN => '/orawsv/*',
    NAME      => SERVLET_NAME);
END;
/

```

Example 33-2 Verifying Addition of Web Services Configuration Servlet

```

XQUERY declare default element namespace "http://xmlns.oracle.com/xdb/xdbconfig.xsd"; (: :)
  (: This path is split over two lines for documentation purposes only.
  The path should actually be a single long line. :)
  for $doc in fn:doc("/xdbconfig.xml")/xdbconfig/sysconfig/protocolconfig/httpconfig/
  webappconfig/servletconfig/servlet-list/servlet[servlet-name='orawsv']
  return $doc
/

```

Result Sequence

```

-----
<servlet xmlns="http://xmlns.oracle.com/xdb/xdbconfig.xsd">
  <servlet-name>orawsv</servlet-name>
  <servlet-language>C</servlet-language>
  <display-name>Oracle Query Web Service</display-name>
  <description>Servlet for issuing queries as a Web Service</description>
  <servlet-schema>XDB</servlet-schema>
  <security-role-ref>
    <description/>
    <role-name>XDB_WEBSERVICES</role-name>
    <role-link>XDB_WEBSERVICES</role-link>
  </security-role-ref>
</servlet>

```

1 item(s) selected.

33.2.2 Enabling Web Services for a Specific User

To enable Web services for a specific user, log on as user SYS and grant role XDB_WEBSERVICES to the user. This role enables Web services over HTTPS. This role is *required* to be able to use Web services.

User SYS can, in *addition*, grant one or both of the following roles to the user:

- XDB_WEBSERVICES_OVER_HTTP – Enable use of Web services over HTTP (not just HTTPS).
- XDB_WEBSERVICES_WITH_PUBLIC – Enable access, using Web services, to database objects that are accessible to PUBLIC.

If a user is not granted `XDB_WEBSERVICES_WITH_PUBLIC`, then the user has access, using Web services, to all database objects (regardless of owner) that would normally be available to the user, *except* for `PUBLIC` objects. To make `PUBLIC` objects accessible to a user through Web services, `SYS` must grant role `XDB_WEBSERVICES_WITH_PUBLIC` to the user. With this role, a user can access any `PUBLIC` objects that would normally be available to the user if logged on to the database.

33.3 Query Oracle XML DB Using a Web Service

The Oracle XML DB Web service for database queries is located at URL `http://host:port/orawsv`, where `host` and `port` are the database host and HTTP(S) port. It has an associated WSDL that specifies the formats of the incoming and outgoing documents using XML Schema. This WSDL is located at URL `http://host:port/orawsv?wsdl`.

Your application sends database queries to the Web service as XML documents that conform to the XML schema listed in [Example 33-3](#) (page 33-5).

This XML schema is contained in the WSDL document. The important parts of incoming query documents are as follows:

- `query_text` – The text of your query. Attribute `type` specifies the type of your query: either `SQL` or `XQUERY`.
- `bind` – A scalar bind-variable value. Attribute name names the variable.
- `bindXML` – An `XMLType` bind-variable value.
- `null_handling` – How `NULL` values returned by the query are to be treated:
 - `DROP_NULLS` – Put nothing in the output (no element). This is the default behavior.
 - `NULL_ATTR` – Use an empty element for `NULL`-value output. Use attribute `xsi:nil = "true"` in the element.
 - `EMPTY_TAG` – Use an empty element for `NULL`-value output, without a `nil` attribute.
- `max_rows` – The maximum number of rows to output for the query. By default, all rows are returned.
- `skip_rows` – The number of query output rows to skip, before including rows in the data returned in the SOAP message. You can use this in connection with `max_rows` to provide paginated output. The default value is zero (0).
- `pretty_print` – Whether the output document should be formatted for pretty-printing. The default value is `true`, meaning that the document is pretty-printed. When the value is `false`, no pretty-printing is done, and output rows are not broken with newline characters.
- `indentation_width` – The number of characters to indent nested elements that start a new line. The default value is one (1).
- `rowset_tag` – Name of the root element of the output document.
- `row_tag` – Name of the element whose value is a single row of query output.

- `item_tags_for_coll` – Whether to generate collection elements with name `collection_name_item`, where `collection_name` is the name of the collection.

These elements have the same meanings as corresponding parameters of procedures in PL/SQL package `DBMS_XMLGEN`.

[Example 33-4](#) (page 33-6) and [Example 33-5](#) (page 33-6) show the input and output of a simple SQL query.

In [Example 33-4](#) (page 33-6), the query text is enclosed in `<![CDATA[...]]>`. Although not strictly necessary in this example, it is appropriate to do this generally, because queries often contain characters such as `<` and `>`. Element `bind` is used to bind a value (8300) to the bind variable named `e`. Element `pretty_print` turns off pretty-printing of the output.

Example 33-3 XML Schema for Database Queries To Be Processed by Web Service

```
<schema xmlns="http://www.w3.org/2001/XMLSchema"
  xmlns:xdb="http://xmlns.oracle.com/xdb"
  targetNamespace="http://xmlns.oracle.com/orawsv">
  <element name="query">
    <complexType>
      <sequence>
        <element name="query_text">
          <complexType>
            <simpleContent>
              <extension base="string">
                <attribute name="type">
                  <simpleType>
                    <restriction base="NMTOKEN">
                      <enumeration value="SQL"/>
                      <enumeration value="XQUERY"/>
                    </restriction>
                  </simpleType>
                </attribute>
              </extension>
            </simpleContent>
          </complexType>
        </element>
        <choice maxOccurs="unbounded">
          <element name="bind">
            <complexType>
              <simpleContent>
                <extension base="string">
                  <attribute name="name" type="string"/>
                </extension>
              </simpleContent>
            </complexType>
          </element>
          <element name="bindXML" type="any"/>
        </choice>
        <element name="null_handling" minOccurs="0">
          <simpleType>
            <restriction base="NMTOKEN">
              <enumeration value="DROP_NULLS"/>
              <enumeration value="NULL_ATTR"/>
              <enumeration value="EMPTY_TAG"/>
            </restriction>
          </simpleType>
        </element>
        <element name="max_rows" type="positiveInteger" minOccurs="0"/>
      </sequence>
    </complexType>
  </element>
</schema>
```

```

    <element name="skip_rows" type="positiveInteger" minOccurs="0"/>
    <element name="pretty_print" type="boolean" minOccurs="0"/>
    <element name="indentation_width" type="positiveInteger" minOccurs="0"/>
    <element name="rowset_tag" type="string" minOccurs="0"/>
    <element name="row_tag" type="string" minOccurs="0"/>
    <element name="item_tags_for_coll" type="boolean" minOccurs="0"/>
  </sequence>
</complexType>
</element>
</schema>

```

Example 33-4 Input XML Document for SQL Query Using Query Web Service

```

<?xml version="1.0" ?>
<env:Envelope xmlns:env="http://www.w3.org/2002/06/soap-envelope" >
  <env:Body>
    <query xmlns="http://xmlns.oracle.com/orawsv">
      <query_text type="SQL">
        <![CDATA[SELECT * FROM employees WHERE salary = :e]]>
      </query_text>
      <bind name="e">8300</bind>
      <pretty_print>>false</pretty_print>
    </query>
  </env:Body>
</env:Envelope>

```

Example 33-5 Output XML Document for SQL Query Using Query Web Service

```

<?xml version="1.0"?>
<soap:Envelope xmlns:soap="http://www.w3.org/2002/06/soap-envelope">
<soap:Body>
<ROWSET><ROW><EMPLOYEE_ID>206</EMPLOYEE_ID><FIRST_NAME>William</FIRST_NAME><LAST_NAME>G
ietz</LAST_NAME><EMAIL>WGIIETZ</EMAIL><PHONE_NUMBER>515.123.8181</PHONE_NUMBER><HIRE_DATE>07-JUN-
94</HIRE_DATE><JOB_ID>AC_ACCOUNT</JOB_ID><SALARY>8300</SALARY><MANAGER_ID>205</MANAGER_ID
><DEPARTMENT_ID>110</DEPARTMENT_ID></ROW></ROWSET>
</soap:Body>
</soap:Envelope>

```

33.4 Access to PL/SQL Stored Procedures Using a Web Service

The Oracle XML DB Web service for accessing PL/SQL stored functions and procedures is located at URL `http://host:port/orawsv/dbschema/package/fn_or_proc` or, for a function or procedure that is standalone (not in a package), `http://host:port/orawsv/dbschema/fn_or_proc`.

Here, *host* and *port* are the database host and HTTP(S) port, *fn_or_proc* is the stored function or procedure name, *package* is its package, and *dbschema* is the database schema owning that package.

The input XML document must contain the inputs needed by the function or procedure. The output XML document contains the return value and the values of all OUT variables.

The names of the XML elements in the input and output documents correspond to the variable names of the function or procedure. The generated WSDL document shows you the exact XML element names. This is the naming convention used:

- The XML element introducing the input to a PL/SQL function is named *function-name***Input**, where *function-name* is the name of the function (uppercase).

- The XML elements introducing input parameters for the function are named *param-name-param-type-io-mode*, where *param-name* is the name of the parameter (uppercase), *param-type* is its SQL data type, and *io-mode* is its input-output mode, as follows:
 - **IN** – IN mode
 - **OUT** – OUT mode
 - **INOUT** – IN OUT mode
- The XML element introducing the output from a PL/SQL function is named **Sreturn-type-function-nameOutput**, where *return-type* is the SQL data type of the return value (uppercase), and *function-name* is the name of the function (uppercase).
- The XML elements introducing output parameters for the function are named the same as the output parameters themselves (uppercase). The element introducing the return value is named RETURN.

The return value of a function is in the RETURN element of the output document, which is always the first element in the document. This return-value position disambiguates it from any OUT parameter that might be named "RETURN".

Each stored function or procedure is associated with a separate, dynamic Web service that has its own, generated WSDL document. This WSDL document is located at URL `http://host:port/orawsv/dbschema/package/fn_or_proc?wsdl` or `http://host:port/orawsv/dbschema/fn_or_proc?wsdl`. In addition, you can optionally generate a single WSDL document to be used for all stored functions and procedures in a given package. The URL for that WSDL document is `http://host:port/orawsv/dbschema/package?wsdl`.

Data types in the incoming and outgoing XML documents are mapped to SQL data types for use by the stored function or procedure, according to [Table 33-1](#) (page 33-7). These are the only data types that are supported.

Table 33-1 Web Service Mapping Between XML and Oracle Database Data Types

Oracle Database Data Type	XML Schema Data Type
CHAR, VARCHAR2, VARCHAR	xsd:string
DATE – Dates must be in the database format.	xsd:date
TIMESTAMP, TIMESTAMP WITH TIMEZONE, TIMESTAMP WITH LOCAL TIMEZONE	xsd:dateTime
INTERVAL YEAR TO MONTH, INTERVAL DAY TO SECOND	xsd:duration
NUMBER, BINARY_DOUBLE, BINARY_FLOAT	xsd:double
INT, INTEGER, SMALLINT, PLS_INTEGER, BINARY_INTEGER	xsd:integer
RAW, BLOB, REF	xsd:hexBinary
PL/SQL BOOLEAN	xsd:boolean

Table 33-1 (Cont.) Web Service Mapping Between XML and Oracle Database Data Types

Oracle Database Data Type	XML Schema Data Type
Object types	complexType
XMLType	empty complexType

An object type is represented in XML as a complex-type element named the same as the object type. The object attributes are represented as children of this element.

33.4.1 Using a PL/SQL Function with a Web Service: Example

Examples present a PL/SQL function and its access using a Web service. The function takes as input a department ID and name. It returns the salary total for the department. It also returns, as in-out and output parameters, respectively, the department name and the number of employees in the department.

The default value of the department ID is 20. In this simple example, the input value of the in-out parameter `dept_name` is not actually used. It is ignored, and the correct name is returned.

[Example 33-6](#) (page 33-8) shows the function definition. [Example 33-7](#) (page 33-9) shows the WSDL document that is created automatically from this function definition. [Example 33-8](#) (page 33-10) shows an input document that invokes the stored function. [Example 33-9](#) (page 33-10) shows the resulting output document.

Example 33-6 Definition of PL/SQL Function Used for Web-Service Access

```
CREATE OR REPLACE PACKAGE salary_calculator AUTHID CURRENT_USER AS
  FUNCTION TotalDepartmentSalary (dept_id IN NUMBER DEFAULT 20,
                                  dept_name IN OUT VARCHAR2,
                                  nummembers OUT NUMBER)
    RETURN NUMBER;
END salary_calculator;
/
CREATE OR REPLACE PACKAGE BODY salary_calculator AS
  FUNCTION TotalDepartmentSalary (dept_id IN NUMBER DEFAULT 20,
                                  dept_name IN OUT VARCHAR2,
                                  nummembers OUT NUMBER)
    RETURN NUMBER IS
    sum_sal NUMBER;
  BEGIN
    SELECT SUM(salary) INTO sum_sal FROM employees
      WHERE department_id = dept_id;
    SELECT department_name INTO dept_name FROM departments
      WHERE department_name = dept_name;
    SELECT count(*) INTO nummembers FROM employees
      WHERE department_id = dept_id;
    RETURN sum_sal;
  END;
END;
/
```

Example 33-7 WSDL Document Corresponding to a Stored PL/SQL Function

```

<definitions name="SALARY_CALCULATOR"
  targetNamespace="http://xmlns.oracle.com/orawsv/HR/SALARY_CALCULATOR"
  xmlns="http://schemas.xmlsoap.org/wsdl/"
  xmlns:tns="http://xmlns.oracle.com/orawsv/HR/SALARY_CALCULATOR"
  xmlns:xsd="http://www.w3.org/2001/XMLSchema"
  xmlns:soap="http://schemas.xmlsoap.org/wsdl/soap/">
  <types>
    <xsd:schema targetNamespace="http://xmlns.oracle.com/orawsv/HR/SALARY_CALCULATOR"
      elementFormDefault="qualified">
      <xsd:element name="SNUMBER-TOTALDEPARTMENTSALARYInput">
        <xsd:complexType>
          <xsd:sequence>
            <xsd:element name="NUMMEMBERS-NUMBER-OUT">
              <xsd:complexType/>
            </xsd:element>
            <xsd:element name="DEPT_NAME-VARCHAR2-INOUT" type="xsd:string"/>
            <xsd:element name="DEPT_ID-NUMBER-IN" type="xsd:double"/>
          </xsd:sequence>
        </xsd:complexType>
      </xsd:element>
      <xsd:element name="TOTALDEPARTMENTSALARYOutput">
        <xsd:complexType>
          <xsd:sequence>
            <xsd:element name="RETURN" type="xsd:double"/>
            <xsd:element name="NUMMEMBERS" type="xsd:double"/>
            <xsd:element name="DEPT_NAME" type="xsd:string"/>
          </xsd:sequence>
        </xsd:complexType>
      </xsd:element>
    </xsd:schema>
  </types>
  <message name="TOTALDEPARTMENTSALARYInputMessage">
    <part name="parameters" element="tns:SNUMBER-TOTALDEPARTMENTSALARYInput"/>
  </message>
  <message name="TOTALDEPARTMENTSALARYOutputMessage">
    <part name="parameters" element="tns:TOTALDEPARTMENTSALARYOutput"/>
  </message>
  <portType name="SALARY_CALCULATORPortType">
    <operation name="TOTALDEPARTMENTSALARY">
      <input message="tns:TOTALDEPARTMENTSALARYInputMessage"/>
      <output message="tns:TOTALDEPARTMENTSALARYOutputMessage"/>
    </operation>
  </portType>
  <binding name="SALARY_CALCULATORBinding" type="tns:SALARY_CALCULATORPortType">
    <soap:binding style="document" transport="http://schemas.xmlsoap.org/soap/http"/>
    <operation name="TOTALDEPARTMENTSALARY">
      <soap:operation soapAction="TOTALDEPARTMENTSALARY"/>
      <input>
        <soap:body parts="parameters" use="literal"/>
      </input>
      <output>
        <soap:body parts="parameters" use="literal"/>
      </output>
    </operation>
  </binding>
  <service name="SALARY_CALCULATORService">
    <documentation>Oracle Web Service</documentation>
    <port name="SALARY_CALCULATORPort" binding="tns:SALARY_CALCULATORBinding">
      <soap:address location="https://example:8088/orawsv/HR/SALARY_CALCULATOR"/>
    </port>
  </service>

```

```
</port>
</service>
</definitions>
```

Example 33-8 Input XML Document for PL/SQL Query Using Web Service

```
<?xml version="1.0" ?><soap:Envelope
xmlns:soap="http://www.w3.org/2002/06/soap-envelope"><soap:Body><SNUMBER-
TOTALDEPARTMENTSALARYinput
xmlns="http://xmlns.oracle.com/orawsv/HR/SALARY_CALCULATOR/TOTALDEPARTMENTSALARY">
<DEPT_ID-NUMBER-IN>30</DEPT_ID-NUMBER-IN><DEPT_NAME-VARCHAR2-INOUT>Purchasing
</DEPT_NAME-VARCHAR2-INOUT><NUMMEMBERS-NUMBER-OUT/></SNUMBER-
TOTALDEPARTMENTSALARYinput></soap:Body></soap:Envelope>
```

Example 33-9 Output XML Document for PL/SQL Query Using Web Service

```
<?xml version="1.0" ?>
<soap:Envelope xmlns:soap="http://www.w3.org/2002/06/soap-envelope">
  <soap:Body>
    <TOTALDEPARTMENTSALARYOutput
      xmlns="http://xmlns.oracle.com/orawsv/HR/SALARY_CALCULATOR/TOTALDEPARTMENTSALARY">
      <RETURN>24900</RETURN>
      <NUMMEMBERS>6</NUMMEMBERS>
      <DEPT_NAME>Purchasing</DEPT_NAME>
    </TOTALDEPARTMENTSALARYOutput>
  </soap:Body>
</soap:Envelope>
```

Part VII

Oracle Tools that Support Oracle XML DB

You can use various Oracle tools with Oracle XML DB. These include tools for managing Oracle XML DB, loading XML data, and exchanging XML data.

- [Administration of Oracle XML DB](#) (page 34-1)
- [How to Load XML Data](#) (page 35-1)
- [Export and Import of Oracle XML DB Data](#) (page 36-1)
- [XML Data Exchange Using Oracle Streams AQ](#) (page 37-1)

Administration of Oracle XML DB

Administration of Oracle XML DB includes installing, upgrading, and configuring it.

- [Upgrade or Downgrade of an Existing Oracle XML DB Installation](#) (page 34-1)
- [Administration of Oracle XML DB Using Oracle Enterprise Manager](#) (page 34-4)
- [Configuration of Oracle XML DB Using `xdbconfig.xml`](#) (page 34-5)

See Also:

[Configuration of Repository Resources for XLink and XInclude](#) (page 23-10) for information on configuring Oracle XML DB Repository resources for use with XLink (*deprecated*) and XInclude

34.1 Upgrade or Downgrade of an Existing Oracle XML DB Installation

Various considerations apply to all upgrades of Oracle Database from a release prior to Oracle Database 12c Release 1 (12.1.0.1).

- Run script `catproc.sql`, as always.
- Replication of hierarchy-enabled tables is not supported for any replication method, including rolling upgrade.
- If supplemental logging is turned on then these operations are not supported:
 - Use of the `APPEND` hint for `INSERT`
 - `SQL*Loader` direct-path insertion of `XMLType` data
- If you use rolling upgrade and any of the following operations are invoked on the primary database, then an *unsupported operation* error is raised on the standby database:
 - `DBMS_XDB_ADMIN` — all operations
 - `DBMS_XMLSCHEMA.copyEvolve`
 - `DBMS_XMLSCHEMA.compileSchema`
 - `DBMS_XMLINDEX.dropparameter`
 - `DBMS_XMLINDEX.modifyparameter`
 - `DBMS_XMLINDEX.registerparameter`

- ACL security: In releases prior to Oracle Database 11g Release 1, conflicts among ACEs for the same principal and same privilege were resolved by giving priority to any ACE that had `child deny`, whether or not preceding ACEs had `child grant`. That is, ACE order did not matter. In Oracle Database 11g and later this `deny-trumps-grant` behavior is still available, but it is not the default behavior.
- Prior to Oracle Database 12c Release 1 (12.1.0.1), basic access authentication was the only available HTTP authentication mechanism. Starting with 12c Release 1, digest access authentication is available. See [Authentication Considerations for Database Installation, Upgrade and Downgrade](#) (page 34-2) for authentication considerations that apply to database upgrades and downgrades.

See Also:

- *Oracle Data Guard Concepts and Administration* for information about performing a rolling upgrade
 - [ACL and ACE Evaluation](#) (page 27-9) for information about conflicts among ACEs
-
-

34.1.1 Authentication Considerations for Database Installation, Upgrade and Downgrade

Various authentication considerations apply to database installation, upgrades and downgrades.

See Also:

[Configuration and Management of Authentication Mechanisms for HTTP](#) (page 28-10) for how to configure authentication

34.1.1.1 Authentication Considerations for a Database Installation

In a default database installation, digest authentication is enabled, and basic authentication is disallowed. Digest verifiers are automatically generated for *all* users.

34.1.1.2 Authentication Considerations for a Database Upgrade

After an upgrade from a release prior to Oracle Database 12c Release 1 (12.1.0.1), digest authentication is appended to the list of allowed authentication mechanisms. But basic authentication remains the current authentication method if it was enabled before the upgrade. This is for backward compatibility *only*.

Oracle recommends that your database administrator *disable basic authentication as soon as possible* after upgrading. The reason that basic authentication remains in effect after such an upgrade is to allow users to change their passwords using a Web browser that does not support digest authentication.

For such an upgrade, digest verifiers are computed for all *new* users and for all previously existing *users whose passwords changed* during the upgrade. Other users do *not* have digest verifiers.

After an upgrade, a DBA can use database view `DBA_DIGEST_VERIFIERS` to check which users have digest verifiers and take appropriate action, as follows:

1. Configure *basic* authentication as the *first* allowed authentication mechanism in the Oracle XML DB configuration file, `xdbconfig.xml`. This ensures that basic authentication can be used for HTTP access.

2. Expire all passwords for those users who do not have digest verifiers. This query returns those users:

```
SELECT USERNAME FROM DBA_DIGEST_VERIFIERS
WHERE HAS_DIGEST_VERIFIERS = 'NO' AND DIGEST_TYPE is NULL;
```

3. After the passwords for all such users have been changed, configure `xdbconfig.xml` to re-enable digest as the first or (preferably) the only allowed authentication mechanism.

34.1.1.3 Authentication Considerations for a Database Downgrade

If you downgrade to a release where digest authentication was not supported, digest authentication is disabled and made unavailable as an authentication choice.

All digest verifiers are *erased* during a downgrade. This means, in particular, that if a downgrade is followed by an upgrade then users who were able to authenticate prior to the downgrade are denied digest authentication after the downgrade and the subsequent upgrade.

34.1.2 Automatic Installation of Oracle XML DB

Oracle XML DB is automatically installed during an upgrade. Ensure that the compatibility level is at least 12.1.0.1 if you intend to use Oracle XML DB.

If Oracle XML DB is not already installed in your database prior to an upgrade to Oracle Database 12c Release 1 (12.1.0.1) or later, then it is automatically installed in tablespace `SYSAUX` during the upgrade.

If Oracle XML DB has thus been automatically installed, and if you want to use Oracle XML DB, then, after the upgrade operation, you must set the database compatibility to at least 12.1.0.1. If the compatibility is less than 12.1.0.1 then an error is raised when you try to use Oracle XML DB.

If Oracle XML DB was automatically installed during an upgrade and the current compatibility level is less than 12.1.0.1, then Oracle DB is automatically uninstalled during any downgrade to a prior release.

34.1.3 Validation of ACL Documents and Configuration File

During upgrade, existing ACL documents and the Oracle XML DB configuration file are validated against their XML schemas. If validation fails then you need to take certain measures.

Access control list (ACL) documents are stored in table `XDB$ACL`. The Oracle XML DB configuration file, `xdbconfig.xml`, is stored in table `XDB$CONFIG`. Starting with Oracle Database 12c Release 1 (12.1.0.1), these tables use the post-parse (binary XML) storage model. This implies that ACL documents and the configuration file are fully validated against their respective XML schemas. Validation takes place during upgrade, using your existing ACL documents and configuration file and the corresponding existing XML schemas.

If an ACL document fails to validate during upgrade, then the document is moved to table `XDB$INVALID_ACL`.

If validation of configuration file `xdbconfig.xml` fails during upgrade, then the file is saved in table `XDB$INVALID_CONFIG`, the default configuration file replaces it in table `XDB$CONFIG`, and the XDB component of the database is marked invalid. You must then start the database in normal mode and fix the XDB component, before trying to use the database.

To fix the XDB component, you can fix the invalid files to make them valid, and then call PL/SQL procedure `RecoverUpgrade`. After validating, this procedure moves the fixed files to tables `XDB$ACL` and `XDB$CONFIG`, and marks the XDB component valid.

As an option, you can call procedure `RecoverUpgrade` with parameter `use_default` set to `TRUE`, to abandon any invalid files. In this case, any valid files are moved to tables `XDB$ACL` and `XDB$CONFIG`, and any remaining invalid files are deleted. Default files are used in place of any invalid files. For ACLs, the default ACL document is used. For the configuration file, the default `xdbconfig.xml` is used (in which ACE order matters).

Caution:

Use a `TRUE` value for parameter `use_default` *only* if you are certain that you no longer need the old ACL files or configuration file that are invalid. These files are *deleted*.

34.2 Administration of Oracle XML DB Using Oracle Enterprise Manager

You can use Oracle Enterprise Manager to easily perform Oracle XML DB administration tasks. This includes configuring Oracle XML DB; creating, searching, editing, and deleting XML schemas, `XMLType` tables and views, and Oracle XML DB Repository *resources* and their *access control lists* (ACLs); registering XML schemas; and creating function-based indexes.

See the online help available with Oracle Enterprise Manager for information about using Enterprise Manager to perform the following tasks:

- Configure Oracle XML DB. View or edit parameters for the Oracle XML DB configuration file, `xdbconfig.xml`.
- Search, create, edit, undelete Oracle XML DB Repository *resources* and their associated *access control lists* (ACLs).
- Search, create, edit, and delete `XMLType` *tables* and *views*.
- Search, create, register, and delete *XML schemas*.

See Also:

- [Configuration of Oracle XML DB Using `xdbconfig.xml`](#) (page 34-5) for information about configuring Oracle XML DB without using Oracle Enterprise Manager
 - [Oracle XML DB Repository](#) (page 1) for information about creating and managing resources without using Oracle Enterprise Manager
 - [XML Schema Storage and Query: Basic](#) (page 17-1) for information about manipulating XML schemas without using Oracle Enterprise Manager
-
-

34.3 Configuration of Oracle XML DB Using xdbconfig.xml

Oracle XML DB is managed internally through a configuration file, `xdbconfig.xml`, which is stored as a resource in Oracle XML DB Repository. As an alternative to using Oracle Enterprise Manager to configure Oracle XML DB, you can configure it directly using the Oracle XML DB configuration file.

The configuration file can be modified at run time. Updating the configuration file creates a new version of this repository resource. At the start of each session, the current version of the configuration file is bound to that session. The session uses this configuration-file version for its duration, unless you make an explicit call to refresh the session to the latest version.

34.3.1 Oracle XML DB Configuration File, xdbconfig.xml

The configuration of Oracle XML DB is defined and stored in an Oracle XML DB Repository resource, `xdbconfig.xml`, which conforms to the Oracle XML DB configuration XML schema, <http://xmlns.oracle.com/xdb/xdbconfig.xsd>. To configure or reconfigure Oracle XML DB, update the configuration file, `xdbconfig.xml`. You need administrator privileges to access file `xdbconfig.xml`.

The structure of the configuration file is described in the following sections.

See Also:

[xdbconfig.xsd: XML Schema for Configuring Oracle XML DB](#) (page A-16) for a complete listing of the Oracle XML DB configuration XML schema

34.3.1.1 Element xdbconfig (Top-Level)

Element `xdbconfig` is the top-level element of the Oracle XML DB configuration file.

Its structure is as follows:

```
<xdbconfig>
  <sysconfig> ... </sysconfig>
  <userconfig> ... </userconfig>
</xdbconfig>
```

Element `sysconfig` defines system-specific, built-in parameters. Element `userconfig` lets you store new custom parameters.

34.3.1.2 Element sysconfig (Child of xdbconfig)

Element `sysconfig` is a child of `xdbconfig`.

Its structure is as follows:

```
<sysconfig>
  general parameters
  <protocolconfig> ... </protocolconfig>
</sysconfig>
```

Element `sysconfig` includes as content several general parameters that apply to all of Oracle XML DB, such as the maximum age of an access control list (ACL). Child element `protocolconfig` contains protocol-specific parameters.

Note:

Element `case-sensitive`, child of element `sysconfig`, has no effect on the case-sensitivity of XQuery or full-text search. Otherwise, it affects the behavior of all of Oracle XML DB.

34.3.1.3 Element `userconfig` (Child of `xdbconfig`)

Element `userconfig` is a child of `xdbconfig`. It contains any parameters that you may want to add.

34.3.1.4 Element `protocolconfig` (Child of `sysconfig`)

Element `protocolconfig` is a child of `sysconfig`.

Its structure is as follows:

```
<protocolconfig>
  <common> ... </common>
  <ftpconfig> ... </ftpconfig>
  <httpconfig> ... </httpconfig> </protocolconfig>
```

Under element `common`, Oracle Database stores parameters that apply to all protocols, such as MIME-type information. Parameters that are specific to protocols FTP and HTTP(S) are in elements `ftpconfig` and `httpconfig`, respectively.

See Also:

[Repository Access Using Protocols](#) (page 28-1), [Table 28-1](#) (page 28-3), [Table 28-2](#) (page 28-5), and [Table 28-3](#) (page 28-5), for a list of protocol configuration parameters

34.3.1.5 Element `httpconfig` (Child of `protocolconfig`)

Element `httpconfig`, which is a child of `protocolconfig`, is described.

This is the structure of `httpconfig`:

```
<httpconfig>
  ...
  <webappconfig>
    ...
    <servletconfig>
      ...
      <servlet-list>
        <servlet> ... </servlet>
      ...
    </servlet-list>
  </servletconfig>
</webappconfig>
  ...
  <plsql> ... </plsql>
</httpconfig>
```

Element `httpconfig` has the following child elements, in addition to others:

- `webappconfig` – used to configure Web-based applications. This includes Web application-specific parameters, such as icon name, display name for the application, and a list of servlets.

Element `servletconfig` is a child of `webappconfig` that is used to define servlets. It has child element `servlet-list`, which has child element `servlet` (see [Element servlet \(Descendant of httpconfig\)](#) (page 34-7)).

- `plssql`¹ – used to define global configuration parameters when configuring the *embedded PL/SQL gateway*. Each global parameter is defined with a child element of `plssql`. The element name is the same as the global parameter name. The element content is the same as the parameter value.

The recommended way to configure the embedded PL/SQL gateway is to use the procedures in PL/SQL package `DBMS_EPG`, *not* to edit file `xdbconfig.xml`.

See Also:

- [Repository Access Using Protocols](#) (page 28-1), [Table 28-1](#) (page 28-3), [Table 28-2](#) (page 28-5), and [Table 28-3](#) (page 28-5), for a list of protocol configuration parameters
 - *Oracle Database Development Guide*, for complete information about configuring and using the embedded PL/SQL gateway
 - *Oracle Database PL/SQL Packages and Types Reference*, for information about package `DBMS_EPG`
-
-

34.3.1.6 Element `servlet` (Descendant of `httpconfig`)

Element `servlet` is a descendent of element `httpconfig`. It is used to configure servlets, including Java servlets and embedded PL/SQL gateway servlets.

See [Element httpconfig \(Child of protocolconfig\)](#) (page 34-6).

Note:

The following servlets are preconfigured in file `xdbconfig.xml`. Do *not* delete them.

- `ORSServlet`
 - `EMExpressServlet`
-
-

An optional element `plssql`, child of `servlet`¹, configures the embedded PL/SQL gateway servlet. However, the *recommended* way to configure the embedded gateway is to use the procedures in PL/SQL package `DBMS_EPG`, *not* to edit file `xdbconfig.xml`.

Element `plssql` has a child element for each embedded PL/SQL DAD attribute²² that is needed to configure the embedded gateway. All such children are optional. The

¹ There are two different `plssql` elements that are used to configure the embedded PL/SQL gateway. One, a child of `httpconfig`, defines *global parameters*. The other, a child of `servlet`, defines *DAD attributes*.

² DAD is an abbreviation for Database Access Descriptor. DAD attributes are parameters that define such a descriptor.

element name is the same as the DAD attribute name. The element content is the same as the DAD-attribute value.

See Also:

- [Guidelines for Oracle XML DB Applications in Java](#) (page 31-1) for information about configuring Java servlets
 - *Oracle Database Development Guide*, for complete information about configuring and using the embedded PL/SQL gateway
 - *Oracle Application Express App Builder User's Guide*, for information about Oracle Application Express
 - *Oracle Database PL/SQL Packages and Types Reference*, for information about package DBMS_EPG
-
-

34.3.1.7 Oracle XML DB Configuration File Example

A sample Oracle XML DB configuration file is presented.

Example 34-1 Oracle XML DB Configuration File

```
<xdbconfig xmlns="http://xmlns.oracle.com/xdb/xdbconfig.xsd"
           xmlns:xsi="http://www.w3.org/2001/XMLSchema-instance"
           xsi:schemaLocation="http://xmlns.oracle.com/xdb/xdbconfig.xsd
                               http://xmlns.oracle.com/xdb/xdbconfig.xsd">
  <sysconfig>
    <acl-max-age>900</acl-max-age>
    <acl-cache-size>32</acl-cache-size>
    <invalid-pathname-chars>,</invalid-pathname-chars>
    <case-sensitive>true</case-sensitive>
    <call-timeout>300</call-timeout>
    <max-link-queue>65536</max-link-queue>
    <max-session-use>100</max-session-use>
    <persistent-sessions>>false</persistent-sessions>
    <default-lock-timeout>3600</default-lock-timeout>
    <xdbcore-logfile-path>/sys/log/xdblog.xml</xdbcore-logfile-path>
    <xdbcore-log-level>0</xdbcore-log-level>
    <resource-view-cache-size>1048576</resource-view-cache-size>
  </sysconfig>
  <protocolconfig>
    <common>
      <extension-mappings>
        <mime-mappings>
          <mime-mapping>
            <extension>au</extension>
            <mime-type>audio/basic</mime-type>
          </mime-mapping>
          <mime-mapping>
            <extension>avi</extension>
            <mime-type>video/x-msvideo</mime-type>
          </mime-mapping>
          <mime-mapping>
            <extension>bin</extension>
            <mime-type>application/octet-stream</mime-type>
          </mime-mapping>
        </mime-mappings>
      </common>
    </extension-mappings>
  </protocolconfig>
</xdbconfig>
```

```

    <lang-mappings>
      <lang-mapping>
        <extension>en</extension>
        <lang>english</lang>
      </lang-mapping>
    </lang-mappings>

    <charset-mappings>
  </charset-mappings>

    <encoding-mappings>
      <encoding-mapping>
        <extension>gzip</extension>
        <encoding>zip file</encoding>
      </encoding-mapping>
      <encoding-mapping>
        <extension>tar</extension>
        <encoding>tar file</encoding>
      </encoding-mapping>
    </encoding-mappings>
  </extension-mappings>

    <session-pool-size>50</session-pool-size>
    <session-timeout>6000</session-timeout>
  </common>

  <ftpconfig>
    <ftp-port>2100</ftp-port>
    <ftp-listener>local_listener</ftp-listener>
    <ftp-protocol>tcp</ftp-protocol>
    <logfile-path>/sys/log/ftplog.xml</logfile-path>
    <log-level>0</log-level>
    <session-timeout>6000</session-timeout>
    <buffer-size>8192</buffer-size>
  </ftpconfig>

  <httpconfig>
    <http-port>8080</http-port>
    <http-listener>local_listener</http-listener>
    <http-protocol>tcp</http-protocol>
    <max-http-headers>64</max-http-headers>
    <session-timeout>6000</session-timeout>
    <server-name>XDB HTTP Server</server-name>
    <max-header-size>16384</max-header-size>
    <max-request-body>2000000000</max-request-body>
    <logfile-path>/sys/log/httplog.xml</logfile-path>
    <log-level>0</log-level>
    <servlet-realm>Basic realm="XDB"</servlet-realm>
  <webappconfig>
    <welcome-file-list>
      <welcome-file>index.html</welcome-file>
      <welcome-file>index.htm</welcome-file>
    </welcome-file-list>
    <error-pages>
  </error-pages>
    <servletconfig>
      <servlet-mappings>
        <servlet-mapping>
          <servlet-pattern>/oradb/*</servlet-pattern>
          <servlet-name>DBURIServlet</servlet-name>
        </servlet-mapping>

```

```
        </servlet-mappings>

        <servlet-list>
          <servlet>
            <servlet-name>DBURIServlet</servlet-name>
            <display-name>DBURI</display-name>
            <servlet-language>C</servlet-language>
            <description>Servlet for accessing DBURIs</description>
            <security-role-ref>
              <role-name>authenticatedUser</role-name>
              <role-link>authenticatedUser</role-link>
            </security-role-ref>
          </servlet>
        </servlet-list>
      </servletconfig>
    </webappconfig>
  </httpconfig>
</protocolconfig>
<xdbcore-xobmem-bound>1024</xdbcore-xobmem-bound>
<xdbcore-loadableunit-size>16</xdbcore-loadableunit-size>
</sysconfig>
</xdbconfig>
```

34.3.1.8 Oracle XML DB Configuration API

You can access the Oracle XML DB configuration file, `xdbconfig.xml`, the same way you access any other XML schema-based resource. You can use FTP, HTTP(S), WebDAV, Oracle Enterprise Manager, or any of the resource and Document Object Model (DOM) APIs for Java, PL/SQL, or C (OCI).

For convenience, you can use PL/SQL package `DBMS_XDB_CONFIG` package for configuration access. It exposes the following functions and procedures:

- `cfg_get` – Returns the configuration information for the current session.
- `cfg_refresh` – Refreshes the session configuration information using the current configuration file. Typical uses of `cfg_refresh` include the following:
 - You have modified the configuration and now want the session to pick up the latest version of the configuration information.
 - It has been a long running session, the configuration has been modified by a concurrent session, and you want the current session to pick up the latest version of the configuration information.
- `cfg_update` – Updates the configuration information, writing the configuration file. A `COMMIT` is performed.

Example 34-2 (page 34-11) updates parameters `ftp-port` and `http-port` in the configuration file.

If you have many parameters to update, then it can be easier to use FTP, HTTP(S), or Oracle Enterprise Manager to update the configuration.

See Also:

- [DBMS_XDB_CONFIG: Configuration Management](#) (page 26-7)
 - *Oracle Database PL/SQL Packages and Types Reference*
-

Example 34-2 Updating the Configuration File Using CFG_UPDATE and CFG_GET

```

DECLARE
  v_cfg XMLType;
BEGIN
  SELECT XMLQuery('declare default element namespace
    "http://xmlns.oracle.com/xdb/xdbconfig.xsd";
    copy $i := $cfg
    modify for $j in $i/xdbconfig
    return (replace value of node $j/descendant::ftp-port with
      "2121",
      replace value of node $j/descendant::http-port with
      "19090")
    return $i'
    PASSING DBMS_XDB_CONFIG.cfg_get() AS "cfg"
    RETURNING CONTENT)
  INTO v_cfg FROM DUAL;
  DBMS_XDB_CONFIG.cfg_update(v_cfg);
END;
/

```

34.3.1.9 Configuration of Mappings from Default Namespace to Schema Location

Oracle XML DB provides a mechanism to configure default XML schema location mappings.

Oracle XML DB identifies XML Schema-based `XMLType` instances by pre-parsing input XML documents. If the appropriate `xsi:schemaLocation` or `xsi:noNamespaceSchemaLocation` attribute is found, then the specified schema location URL is used to consult the registered schema.

If the appropriate `xsi:` attribute is not found, the XML document is considered to be non-schema-based. Oracle XML DB provides a mechanism to configure default schema location mappings. If the appropriate `xsi:` attribute is not specified in the XML document, the default schema location mappings is used.

Element `schemaLocation-mappings` of the Oracle XML DB configuration XML schema, `xdbconfig.xsd`, can be used to specify the mapping between (*namespace*, *element*) pairs and the default schema location. If the *element* value is empty, the mapping applies to all global elements in the specified namespace. If the *namespace* value is empty, it corresponds to the null namespace.

The definition of the `schemaLocation-mappings` element is as follows:

```

<element name="schemaLocation-mappings"
  type="xdbc:schemaLocation-mapping-type" minOccurs="0"/>
<complexType name="schemaLocation-mapping-type"><sequence>
  <element name="schemaLocation-mapping"
    minOccurs="0" maxOccurs="unbounded">
    <complexType><sequence>
      <element name="namespace" type="string"/>
      <element name="element" type="string"/>
      <element name="schemaURL" type="string"/>
    </sequence></complexType>
  </element></sequence>
</complexType>

```

The schema location used depends on mappings in the Oracle XML DB configuration file for the namespace used and the root document element. For example, assume that the document does not have the appropriate `xsi:` attribute to indicate the schema

location. Consider a document root element R in namespace N . The algorithm for identifying the default schema location is as follows:

1. If the Oracle XML DB configuration file has a mapping for N and R , the corresponding schema location is used.
2. If the configuration file has a mapping for N , but not R , the schema location for N is used.
3. If the document root R does not have any namespace, the schema location for R is used.

For example, suppose that your Oracle XML DB configuration file includes the following mapping:

```
<schemaLocation-mappings>
  <schemaLocation-mapping>
    <namespace>http://www.oracle.com/example</namespace>
    <element>root</element>
    <schemaURL>http://www.oracle.com/example/sch.xsd</schemaURL>
  </schemaLocation-mapping>
  <schemaLocation-mapping>
    <namespace>http://www.oracle.com/example2</namespace>
    <element></element>
    <schemaURL>http://www.oracle.com/example2/sch.xsd</schemaURL>
  </schemaLocation-mapping>
  <schemaLocation-mapping>
    <namespace></namespace>
    <element>specialRoot</element>
    <schemaURL>http://www.oracle.com/example3/sch.xsd</schemaURL>
  </schemaLocation-mapping>
</schemaLocation-mappings>
```

The following schema locations are used:

- Root element = root
 - Namespace = `http://www.oracle.com/example`
 - Schema URL = `http://www.oracle.com/example/sch.xsd`

This mapping is used when the instance document specifies:

```
<root xmlns="http://www.oracle.com/example">
```

- Root element = null (any global element in the namespace)
 - Namespace = `http://www.oracle.com/example2`
 - Schema URL = `http://www.oracle.com/example2/sch.xsd`

This mapping is used when the instance document specifies:

```
<root xmlns="http://www.oracle.example2">
```

- Root element = specialRoot
 - Namespace = null (i.e null namespace)
 - Schema URL = `http://www.oracle.com/example3/sch.xsd`

This mapping is used when the instance document specifies:

```
<specialRoot>
```

Note:

This functionality is available only on the server side, that is, when XML is parsed on the server. If XML is parsed on the client side, the appropriate `xsi:` attribute is still required.

34.3.1.10 Configuration of XML File Extensions

Oracle XML DB Repository treats certain files as XML documents, based on their file extensions. When such files are inserted into the repository, Oracle XML DB pre-parses them to identify the XML schema location (or uses the default mapping if present) and inserts the document into the appropriate default table.

By default, the following extensions are considered as XML file extensions: **xml**, **xsd**, **xsl**, **xlt**. In addition, Oracle XML DB provides a mechanism for applications to specify other file extensions as XML file extensions. The **xml-extensions** element is defined in the configuration schema, `http://xmlns.oracle.com/xdb/xdbconfig.xsd`, as follows:

```
<element name="xml-extensions"
         type="xdb:xml-extension-type" minOccurs="0"/>

<complexType name="xml-extension-type"><sequence>
  <element name="extension" type="xdb:exttype"
          minOccurs="0" maxOccurs="unbounded">
    </element></sequence>
</complexType>
```

For example, the following fragment from the Oracle XML DB configuration file, `xdbconfig.xml`, specifies that files with extensions `vsd`, `vml`, and `svgl` should be treated as XML files:

```
<xml-extensions>
  <extension>vsd</extension>
  <extension>vml</extension>
  <extension>svgl</extension>
</xml-extensions>
```

34.4 Oracle XML DB and Database Consolidation

Each pluggable database has its own Oracle XML DB Repository, and its own Oracle XML DB configuration file, `xdbconfig.xml`.

A multitenant container database (CDB) consists of zero or more pluggable databases (PDBs), a root, and a seed PDB (a template for creating PDBs). A given PDB can be associated with only one CDB at a time. A PDB appears to users and applications as a separate database. Your applications always interact with a single PDB at a time. Queries and dictionary views are local to a PDB. Each PDB has its own Oracle XML DB Repository, and its own Oracle XML DB configuration file, `xdbconfig.xml`.

The root of a CDB (CDB\$ROOT) contains no user data. It does, however, have its own configuration file, `xdbconfig.xml`.

The root configuration file for a CDB has only certain parameters, and those parameters are used only from the root configuration file. If any of those parameters are also present in a configuration file of a PDB that is part of a CDB, they are ignored in favor of the corresponding parameters in the root configuration file.

These are the configuration parameters that are used from the root (and ignored from any PDBs):

- `acl-cache-size`
- `acl-max-age`
- `resource-view-cache-size`
- `xdbcore-loadableunit-size`
- `xdbcore-xobmem-bound`

Parameters `xdbcore-loadableunit-size` and `xdbcore-xobmem-bound` are process-specific. The others are SGA configuration parameters.

Database schema (user account) XDB is a common user, which means that it can connect to, and perform operations within, both the root and any PDBs.

Note:

Oracle recommends that you never unlock database schema XDB, under any circumstances.

See Also:

- *Oracle Database Administrator's Guide* and *Oracle Database Concepts* for information about database consolidation and PDBs
 - [Performance Guidelines for Oracle XML DB Repository Operations](#) (page 24-20) for information about configuration parameters `resource-view-cache-size`, `xdbcore-loadableunit-size`, and `xdbcore-xobmem-bound`
 - [Considerations for Loading and Retrieving Large Documents with Collections](#) (page 18-57) for information about configuration parameters `xdbcore-loadableunit-size` and `xdbcore-xobmem-bound`
 - [ACL Caching](#) (page 27-18) for information about configuration parameter `acl-max-age`
-
-

34.5 Package DBMS_XDB_ADMIN

PL/SQL package DBMS_XDB_ADMIN has subprograms for managing and configuring Oracle XML DB and Oracle XML DB Repository.

[Table 34-1](#) (page 34-14) describes these subprograms.

Table 34-1 DBMS_XDB_ADMIN Management Procedures

Function/Procedure	Description
<code>moveXDB_tablespace</code>	Move database schema (user account) XDB to the specified tablespace.
<code>rebuildHierarchicalIndex</code>	Rebuild the hierarchical repository index. This can be needed from time to time, in particular after invoking <code>moveXDB_tablespace</code> .

Note:

Prior to Oracle Database 11g Release 2 (11.2.0.3), these procedures belonged to PL/SQL package DBMS_XDB. These two procedures in package DBMS_XDB are *deprecated* as of release 11.2.0.3.

Note:

The tablespace containing Oracle XML DB Repository *must not* be read-only, because that would adversely affect XML operations.

By default, Oracle XML DB Repository resides in tablespace `SYSAUX`, which is used for other things as well. Oracle recommends instead that you create a dedicated tablespace for use only by the repository.

Use procedure `DBMS_XDB_ADMIN.moveXDB_tablespace` to move database schema `XDB` to that tablespace dedicated to the repository. Ensure that the tablespace is not read-only.

See Also:

Oracle Database PL/SQL Packages and Types Reference

How to Load XML Data

The main way to load XML data into Oracle XML DB is to use SQL*Loader.

- [Overview of Loading XMLType Data Into Oracle Database](#) (page 35-1)
- [Load XMLType Data Using SQL*Loader](#) (page 35-2)
- [Loading Large XML Documents Using SQL*Loader](#) (page 35-4)

See Also:

[Overview of How To Use Oracle XML DB](#) (page 3-1)

35.1 Overview of Loading XMLType Data Into Oracle Database

You can load XMLType data with SQL*Loader, using either the conventional method or the direct-path method, regardless of how it is stored (object-relational or binary XML storage).

Starting with Oracle9i release 1 (9.0.1), the Export-Import utility and SQL*Loader support XMLType as a column type. Starting with Oracle Database 10g, SQL*Loader also supports loading XMLType tables.

Note:

For *object-relational storage* of XML data, if the data involves *inheritance* (extension or restriction) of XML Schema types, then SQL*Loader does *not* support direct-path loading.

That is, if an XML schema contains a complexType element that extends or restricts another complexType element (the base type), then this results in some SQL types being defined in terms of other SQL types. In this case, direct-path loading is not supported for object-relational storage.

See Also:

- [Export and Import of Oracle XML DB Data](#) (page 36-1)
 - *Oracle Database Utilities*
-

Oracle XML DB Repository information is *not* exported when user data is exported. Neither the resources nor any information are exported.

35.2 Load XMLType Data Using SQL*Loader

SQL*Loader treats XMLType columns and tables like object-relational columns and tables. All methods for loading LOB data from the primary datafile or from a LOBFILE value apply also to loading XMLType columns and tables when the XMLType data is stored as a LOB.

See Also:

Oracle Database Utilities

Note:

You cannot specify a SQL string for LOB fields. This is true even if you specify LOBFILE_spec.

XMLType data can be present in a control file or in a LOB file. In the former case, the LOB file name is present in the control file.

Because XMLType data can be quite large, SQL*Loader can load LOB data from either a primary datafile (in line with the rest of the data) or from LOB files, independent of how the data is stored (the underlying storage can, for example, still be object-relational).

35.2.1 Load XMLType LOB Data Using SQL*Loader

To load internal LOBs, Binary Large Objects (BLOBs), Character Large Objects (CLOBs), and National Character Large Object (NCLOBs), or XMLType columns and tables from a primary datafile, use standard SQL*Loader formats.

- Predetermined size fields
- Delimited fields
- Length-value pair fields

These formats are described in the following sections and in more detail in *Oracle Database Utilities*

35.2.1.1 Load LOB Data Using Predetermined Size Fields

Predetermined size fields constitute a very fast and conceptually simple SQL*Loader format for loading LOBs.

Note:

Because the LOBs you are loading might not be of equal size, you can use whitespace to pad the LOB data to make the LOBs all of equal length within a particular data field.

35.2.1.2 Load LOB Data Using Delimited Fields

The delimited fields format handles LOBs of different sizes within the same column (datafile field). However, this added flexibility can affect performance, because SQL*Loader must scan through the data, looking for the delimiter string.

As with single-character delimiters, when you specify string delimiters, you should consider the character set of the datafile. When the character set of the datafile is different than that of the control file, you can specify the delimiters in hexadecimal (that is, hexadecimal string). If the delimiters are specified in hexadecimal notation, then the specification must consist of characters that are valid in the character set of the input datafile. In contrast, if hexadecimal specification is not used, then the delimiter specification is considered to be in the client (that is, the control file) character set. In this case, the delimiter is converted into the datafile character set before SQL*Loader searches for the delimiter in the datafile.

35.2.1.3 Load XML Columns Containing LOB Data from LOBFILES

LOB data can be lengthy enough that it makes sense to load it from a LOBFILE instead of from a primary datafile.

In LOBFILES, LOB data instances are still considered to be in fields (predetermined size, delimited, length-value), but these fields are not organized into records (the concept of a record does not exist within LOBFILES). Therefore, the processing overhead of dealing with records is avoided. This type of organization of data is ideal for LOB loading.

There is no requirement that a LOB from a LOBFILE fit in memory. SQL*Loader reads LOBFILES in 64 KB chunks.

In LOBFILES the data can be in any of the following types of fields, any of which can be used to load XML columns:

- A single LOB field into which the entire contents of a file can be read
- Predetermined size fields (fixed-length fields)
- Delimited fields (that is, `TERMINATED BY` or `ENCLOSED BY`)

The clause `PRESERVE BLANKS` is not applicable to fields read from a LOBFILE.

- Length-value pair fields (variable-length fields) .

To load data from this type of field, use the `VARRAY`, `VARCHAR`, or `VARCHAR2` SQL*Loader data types.

35.2.1.4 Specify LOBFILES

You can specify LOBFILES either statically (you specify the name of the file) or dynamically (you use a `FILLER` field as the source of the filename).

In either case, when the EOF of a LOBFILE is reached, the file is closed and additional attempts to read data from that file produce results equivalent to reading data from an empty field.

You should not specify the same LOBFILE as the source of two different fields. If you do so, then typically, the two fields read the data independently.

35.2.2 Load XMLType Data Directly from a Control File Using SQL*Loader

You can load XMLType data directly from a control file. SQL*Loader treats XMLType data like any scalar type.

For example, consider a table containing a NUMBER column followed by an XMLType column that is stored object-relationally. The control file used for this table can contain the value of the NUMBER column followed by the value of the XMLType instance.

SQL*Loader accommodates XMLType instances that are very large. You also have the option to load such data from a LOB file.

35.2.3 Loading Large XML Documents Using SQL*Loader

You can use SQL*Loader to load large amounts of XML data into Oracle Database.

1. List in a data file, say `filelist.dat`, the locations of the XML documents to be loaded.
2. Create a control file, say `load_data.ctl`, with commands that process the files listed in the data file.
3. Invoke the SQL*Loader shell command, `sqlldr`, passing it the name of the control file.

This is illustrated in [Example 35-1](#) (page 35-4), [Example 35-2](#) (page 35-5), and [Example 35-3](#) (page 35-5). File `filelist.dat` lists XML files that contain purchase orders for the year 2002.

If your application uses indexes or constraints then processing of these can impact loading performance. You can temporarily disable this processing using PL/SQL subprograms `disableIndexesAndConstraints` and `enableIndexesAndConstraints` in package `DBMS_XMLSTORAGE_MANAGE`.

See Also:

- [Overview of How To Use Oracle XML DB](#) (page 3-1), [Loading Large XML Files Using SQL*Loader](#) (page 3-13)
 - *Oracle Database Utilities* for information about shell command `sqlldr`
 - *Oracle Database PL/SQL Packages and Types Reference* for information about `DBMS_XMLSTORAGE_MANAGE` subprograms `disableIndexesAndConstraints` and `enableIndexesAndConstraints`
-
-

Example 35-1 Data File `filelist.dat`: List of XML Files to Load

```
2002/Jan/AMCEWEN-20021009123335370PDT.xml
2002/Jan/AWALSH-2002100912333570PDT.xml
2002/Jan/CJOHNSON-20021009123335170PDT.xml
2002/Jan/LSMITH-20021009123335500PDT.xml
2002/Jan/PTUCKER-20021009123335430PDT.xml
2002/Jan/SBELL-20021009123335280PDT.xml
2002/Jan/SKING-20021009123335560PDT.xml
2002/Jan/SMCCAIN-20021009123335470PDT.xml
2002/Jan/TFOX-20021009123335520PDT.xml
```



```

2002/Jan/VJONES-20021009123335350PDT.xml
2002/Jan/WSMITH-20021009123335450PDT.xml
2002/Feb/AMCEWEN-20021009123335600PDT.xml
2002/Feb/AMCEWEN-20021009123335701PDT.xml
2002/Feb/DAUSTIN-20021009123335811PDT.xml
2002/Feb/EABEL-20021009123335791PDT.xml
2002/Feb/PTUCKER-20021009123335721PDT.xml
2002/Feb/PTUCKER-20021009123335821PDT.xml
2002/Feb/SBELL-20021009123335771PDT.xml
2002/Feb/SMCCAIN-20021009123335681PDT.xml
2002/Feb/WSMITH-20021009123335650PDT.xml
2002/Feb/WSMITH-20021009123335741PDT.xml
2002/Feb/WSMITH-20021009123335751PDT.xml
...

```

Example 35-2 Control File *load_data.ctl*, for Loading Purchase-Order XML Documents

```

load data
infile 'filelist.dat'
append
into table PURCHASEORDER
xmltype(XMLDATA)
(
  filename filler char(120),
  XMLDATA lobfile(filename) terminated by eof
)

```

Example 35-3 Loading XML Data Using Shell Command *sqlldr*

```
sqlldr load_data.ctl
```

For direct-path loading, use this instead:

```
sqlldr load_data.ctl direct=y
```

Export and Import of Oracle XML DB Data

You can use Oracle Data Pump to export and import `XMLType` tables for use with Oracle XML DB.

Note:

You can use the older export and import utilities `exp` and `imp` to migrate data to database releases that are prior to Oracle Database 11g. However, these older utilities do not support using `XMLType` data that is stored as binary XML.

- [Overview of Exporting and Importing XMLType Tables](#) (page 36-1)
- [Export/Import Limitations for Oracle XML DB Repository](#) (page 36-3)
- [Export/Import Syntax and Examples](#) (page 36-3)

36.1 Overview of Exporting and Importing XMLType Tables

Oracle XML DB supports export and import of `XMLType` tables and columns that store XML data, whether it is XML schema-based or not.

Oracle Data Pump enables high-speed movement of data and metadata from one database to another. There are two modes for using Oracle Data Pump: transportable tablespaces mode and non-transportable tablespaces mode.

For the transportable tablespaces mode there is this restriction regarding `XMLType` data: you cannot change the `XMLType` storage model.

As with other database objects, XML data is exported in the character set of the exporting server. During import, the data is converted to the character set of the importing server.

Oracle Data Pump has two command-line clients, `expdp` and `impdp`, that invoke Data Pump Export utility and Data Pump Import utility, respectively. The `expdp` and `impdp` clients use procedures provided in PL/SQL package `DBMS_DATAPUMP` to execute export and import commands, passing the parameters entered at the command-line. These parameters enable the exporting and importing of data and metadata for a complete database or subsets of a database.

The Data Pump Export and Import utilities (invoked with commands `expdp` and `impdp`, respectively) have a similar look and feel to the original Export (`exp`) and Import (`imp`) utilities, but they are completely separate.

Data Pump Export utility (invoked with `expdp`) unloads data and metadata into a set of operating system files called a *dump file set*. The dump file set can be imported only by the Data Pump Import utility (invoked using `impdp`).

Oracle XML DB supports export and import of XMLType tables and columns that store XML data, whether it is XML schema-based or not. If a table is XML schema-based, then it depends on the XML schema used to define its data. This XML schema can also have dependencies on SQL object types that are used to store the data, in the case of object-relational storage.

Therefore, exporting a user who has XML schema-based XMLType tables also exports the following:

- SQL objects types (if object-relational storage was used)
- XML schemas
- XML tables

You can export and import this data regardless of the XMLType storage format (object-relational or binary XML). However, Oracle Data Pump exports and imports XML data as text or binary XML data only. The underlying tables and columns used for object-relational storage of XMLType are thus not exported. Instead, they are converted to binary form and then exported as self-describing binary XML data.

Note:

Oracle Data Pump for Oracle Database 11g Release 1 (11.1) does not support the export of XML schemas, XML schema-based XMLType columns, or binary XML data to database releases prior to 11.1.

Regardless of the XMLType storage model, the format of the dump file is either text or self-describing binary XML with a token map preamble. By default, self-describing binary XML is used.

How Oracle Data Pump stores this data in the dump file depends on the value of the export parameter, `data_options` (the only valid value for this parameter is `xml_clobs`.) If you specify this value on the export command line then all XMLType data is stored in text format in the dump file. Otherwise, the dump file uses binary XML.

Note:

The value `xml_clobs` for export parameter `data_options` is *deprecated* starting with Oracle Database 12c Release 1 (12.1.0.1).

Since XMLType data is exported and imported as XML data, the source and target databases can use different XMLType storage models for that data. You can export data from a database that stores XMLType data one way and import it into a database that stores XMLType data a different way.

Note:

Do not use option `table_exists_action=append` to import more than once from the same dump file into an `XMLType` table, regardless of the `XMLType` storage model used. Doing so raises a unique-constraint violation error because rows in `XMLType` tables are always exported and imported using a unique object identifier.

See *Oracle Database Utilities* for information about `table_exists_action`.

36.2 Export/Import Limitations for Oracle XML DB Repository

When you export or import tables that store data for Oracle XML DB Repository resources that are based on a registered XML schema, only that XML data is exported. The repository structure is lost during export, so that when these tables are imported they are not hierarchy-enabled.

You can export and import the `XMLType` tables that store the XML data for Oracle XML DB Repository resources that are based on a registered XML schema.

However, only the XML data is exported. The repository structure is lost during export. Relationships in the folder hierarchy, row-level security (RLS) policies, and path-index triggers are not exported for hierarchy-enabled tables. When these tables are imported, they are not hierarchy-enabled.

36.3 Export/Import Syntax and Examples

Guidelines and examples are presented for using commands `expdp` and `impdp` with `XMLType` data.

The examples presented here use the command-line commands `expdp` and `impdp`. After submitting such a command with a user name and command parameters, you are prompted for a password. The examples here do not show this prompting.

Export and import using Oracle Data Pump is described fully in *Oracle Database Utilities*.

36.3.1 Performing a Table-Mode Export /Import

Examples are presented of performing a table-mode export and a table-mode import, to and from a dump file, respectively.

An `XMLType` table has a dependency on the XML schema that was used to define it. Similarly, that XML schema has dependencies on the SQL object types that were created or specified for it. Importing an `XMLType` table requires the existence of the corresponding XML schema and SQL object types.

When a `TABLE` mode export is used, only the table related metadata and data are exported. To be able to import this data successfully, you must ensure that the relevant XML schema and object types have been created.

The examples here assume that you are using a database with the following features:

- A database with schema `user23`
- A table `user23.tab41` with an `XMLType` column stored as binary XML
- A directory object `dpump_dir`, for which `READ` and `WRITE` privileges have been granted to the user running `expdp` or `impdp`

[Example 36-1](#) (page 36-4) shows a table-mode export, specified using the `TABLES` parameter. It exports table `tab41` to dump file `tab41.dmp`.

Note:

In table mode, if you do not specify a schema prefix in the `expdp` command then the schema of the exporter is used by default.

[Example 36-2](#) (page 36-4) shows a table-mode import. It imports table `tab41` from dump file `tab41.dmp`.

If a table named `tab41` already exists at the time of the import then specifying `table_exists_action = append` causes rows to be appended to that table. Whenever you use parameter value `append` the data is loaded into new space; existing space is never reused. For this reason you might need to compress your data after the load operation.

See Also:

Oracle Database Utilities, for more information about Oracle Data Pump and its command-line clients, `expdp` and `impdp`

Example 36-1 Exporting XMLType Data in TABLE Mode

```
expdp system directory=dpump_dir dumpfile=tab41.dmp tables=user23.tab41
```

Example 36-2 Importing XMLType Data in TABLE Mode

```
impdp system tables=user23.tab41 directory=dpump_dir dumpfile=tab41.dmp table_exists_action=append
```

36.3.2 Performing a Schema-Mode Export/Import

Examples here perform schema-mode exporting and importing. When performing a Schema mode export, if you have role `EXP_FULL_DATABASE`, then you can export a database schema, the database schema definition, and the system grants and privileges of that database schema.

The examples here assume that you are using a database with the following features:

- User `x4a` has created a table `po2`.
- User `x4a` has a registered XML schema, `ipo`, which created two ordered collection tables `item_oct2` and `sitem_nt2`.

User `x4a` creates table `po2` as shown in [Example 36-3](#) (page 36-5).

Table `po2` is then populated and exported, as shown in [Example 36-4](#) (page 36-5).

[Example 36-4](#) (page 36-5) exports all of the following:

- All data types that were generated during registration of XML schema `ipo`.
- XML schema `ipo`.
- Table `po2` and the ordered collection tables `item_oct2` and `sitem_nt2`, which were generated during registration of XML schema `ipo`.
- All data in all of those tables.

[Example 36-5](#) (page 36-5) imports all of the data in `x4a.dmp` to another database, in which the user `x4a` already exists.

[Example 36-6](#) (page 36-5) does the same thing as [Example 36-5](#) (page 36-5), but it also remaps the database schema from user `x4a` to user `quine`.

[Example 36-6](#) (page 36-5) imports all of the data in `x4a.dmp` (exported from the database schema of user `x4a`) into database schema `quine`. To remap the database schema, user `x4a` must have been granted role `IMP_FULL_DATABASE` on the local database and role `EXP_FULL_DATABASE` on the source database. `REMAP_SCHEMA` loads all of the objects from the source schema into the target schema.

Note:

If you import an XML schema into the same database that it was exported from, and if that XML schema is still registered with Oracle XML DB at the time of importing, do not use `remap_schema` unless you also specify `impdp` parameter `transform=oid:n`. See *Oracle Database Utilities* for information about parameter `transform`.

Example 36-3 Creating Table `po2`

```
CREATE TABLE po2 (po XMLType)
  XMLTYPE COLUMN po
  XMLSCHEMA "ipo.xsd"
  ELEMENT "purchaseOrder"
  VARRAY po.XMLDATA."items"."item"
  STORE AS TABLE item_oct2 ((PRIMARY KEY(NESTED_TABLE_ID, SYS_NC_ARRAY_INDEX$))
  NESTED TABLE po.XMLDATA."shippedItems"."item" STORE AS sitem_nt2;
```

Example 36-4 Exporting XMLType Data in SCHEMA Mode

```
expdp x4a directory=tkxm_xmdir dumpfile=x4a.dmp
```

Example 36-5 Importing XMLType Data in SCHEMA Mode

```
impdp x4a directory=tkxm_xmdir dumpfile=x4a.dmp
```

Example 36-6 Importing XMLType Data in SCHEMA Mode, Remapping Schema

```
impdp x4a directory=tkxm_xmdir dumpfile=x4a.dmp remap_schema=x4a:quine
```

XML Data Exchange Using Oracle Streams AQ

You can exchange XML data using Oracle Streams Advanced Queuing (AQ), which provides database-integrated message-queuing. AQ enables and manages asynchronous communication between applications, using messages. It supports point-to-point and publish/subscribe communication models.

Integration of message queuing with Oracle Database brings the integrity, reliability, recoverability, scalability, performance, and security features of Oracle Database to message queuing. It also facilitates the extraction of intelligence from message flows.

- [XML and Oracle Streams Advanced Queuing](#) (page 37-1)
- [Oracle Streams and Advanced Queuing](#) (page 37-3)
- [XMLType Attributes in Object Types](#) (page 37-4)
- [Internet Data Access Presentation \(iDAP\): SOAP for AQ](#) (page 37-4)
- [iDAP Architecture](#) (page 37-4)
- [Guidelines for Using XML and Oracle Streams Advanced Queuing](#) (page 37-7)

37.1 XML and Oracle Streams Advanced Queuing

Oracle Streams Advanced Queuing (AQ) supports native XML messages. AQ operations can be defined using the XML-based Internet-Data-Access-Presentation (iDAP) format. iDAP is an extensible message invocation protocol. It is built on Internet standards, using HTTP(S) and e-mail protocols as the transport mechanism. XML is the data representation language for iDAP.

37.1.1 Oracle Streams Advanced Queuing and XML Message Payloads

XML messages can be passed asynchronously among applications using Oracle Streams Advanced Queuing (AQ).

[Figure 37-1](#) (page 37-2) shows an Oracle database using AQ to communicate with three applications. The message payload is XML data. The general tasks performed by AQ in this scenario are:

- Message flow using subscription rules
- Message management
- Extraction of business intelligence from messages
- Message transformation

Use cases of passing XML messages asynchronously among applications using AQ:

- Intra-business. Typical examples include sales order fulfillment and supply-chain management.
- Inter-business. Multiple integration hubs can communicate over the Internet. Examples include travel reservations, coordination between manufacturers and suppliers, transfer of funds between banks, and insurance claims settlements.

Oracle uses this approach in its enterprise application integration products. XML messages are sent from applications to an Oracle AQ hub. The hub serves as a message server for any application that wants the message. Through this hub-and-spoke architecture, XML messages can be communicated asynchronously to multiple loosely coupled applications.

Figure 37-1 (page 37-2) shows XML payload messages transported using AQ in the following ways:

- A Web-based application uses an AQ operation over an HTTP(S) connection using iDAP
- An application uses AQ to propagate an XML message over a Net* connection
- An application uses AQ to propagate an Internet or XML message directly to the database using HTTP(S) or SMTP

Figure 37-1 (page 37-2) also shows that AQ clients can access data using OCI, Java, or PL/SQL.

Figure 37-1 Oracle Streams Advanced Queuing and XML Message Payloads

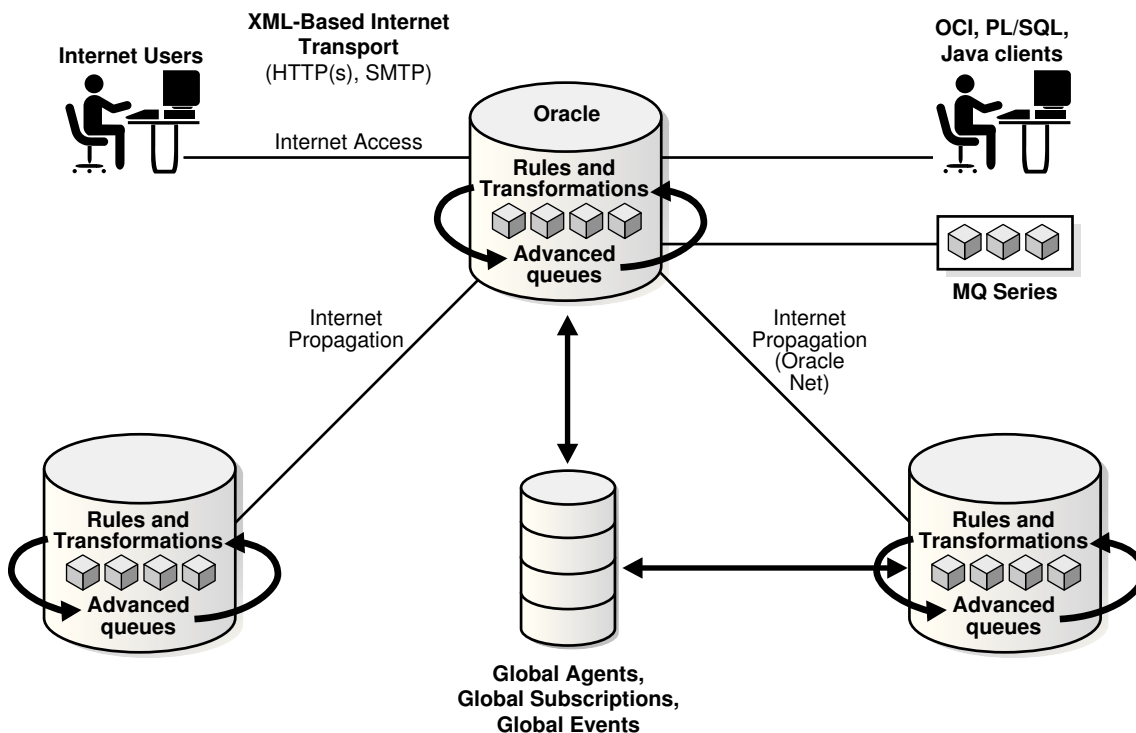

37.1.2 Advantages of Using Oracle Streams Advanced Queuing

Oracle Streams Advanced Queuing (AQ) provides flexibility in configuring communication between applications. It makes an integrated solution easy to manage, easy to configure, and easy to modify, to meet changing business needs. It enables

applications to cooperate, coordinate, and synchronize, to carry out complex business transactions.

Message management provided by AQ manages the flow of messages between different applications. AQ can also retain messages for auditing and tracking purposes, and for extracting business intelligence.

AQ provides SQL views to access messages. You can use these views to analyze trends.

37.2 Oracle Streams and Advanced Queuing

Oracle Streams lets you share data and events in a stream. A stream can propagate information within a database or from one database to another, routing information to specified destinations. It provides functionality and flexibility for capturing and managing events, and for sharing events with other databases and applications.

Oracle Streams lets you break the cycle of trading off one solution for another. You can build and operate distributed enterprises and applications, data warehouses, and high availability solutions.

You can use Oracle Streams to do all of the following:

- *Capture changes at a database.* You can configure a background capture process to capture changes made to tables, database schemas, or the entire database. A capture process captures changes from the redo log and formats each captured change into a logical change record (LCR). The database where changes are generated in the redo log is called the source database.
- *Enqueue events into a queue.* Two types of events may be staged in a Streams queue: LCRs and user messages. A capture process enqueues LCR events into a queue that you specify. The queue can then share the LCR events within the same database or with other databases. You can also enqueue user events explicitly with a user application. These explicitly enqueued events can be LCRs or user messages.
- *Propagate events from one queue to another.* These queues may be in the same database or in different databases.
- *Dequeue events.* A background apply process can dequeue events. You can also dequeue events explicitly with a user application.
- *Apply events at a database.* You can configure an apply process to apply all of the events in a queue or only the events that you specify. You can also configure an apply process to call your own PL/SQL subprograms to process events.

The database where LCR events are applied and other types of events are processed is called the destination database. In some configurations, the source database and the destination database may be the same.

37.2.1 Oracle Streams Message Queuing

Oracle Streams lets your applications enqueue, propagate, and dequeue messages.

Oracle Streams stages messages of type `SYS.AnyData`. Messages of almost any type can be wrapped in a `SYS.AnyData` wrapper and staged in `SYS.AnyData` queues. Oracle Streams Advanced Queuing (AQ) supports all of the standard features of message queuing systems, including multi-consumer queues, publishing and subscribing, content-based routing, internet propagation, transformations, and gateways to other messaging subsystems.

See Also:*Oracle Streams Concepts and Administration*

37.3 XMLType Attributes in Object Types

You can create queues that use Oracle object types containing `XMLType` attributes. These queues can be used to transmit and store messages that are XML documents.

Using `XMLType`, you can do the following:

- Store any type of message in a queue
- Store documents internally as `CLOB` instances
- Store more than one type of payload in a queue
- Query `XMLType` columns using `SQL/XML` functions such as `XMLExists`
- Specify the operators in subscriber rules or dequeue selectors

37.4 Internet Data Access Presentation (iDAP): SOAP for AQ

You can access Oracle Streams Advanced Queuing (AQ) over the Internet using Simple Object Access Protocol (SOAP). Internet Data Access Presentation (iDAP) is the SOAP specification for AQ operations. iDAP defines XML message structure for a SOAP request body.

An iDAP-structured message is transmitted over the Internet using transport protocols such as `HTTP(S)` and `SMTP`.

iDAP uses the `text/xml` content type to specify the body of the SOAP request. XML provides the presentation for iDAP request and response messages, as follows:

- All request and response tags are scoped in the SOAP namespace.
- AQ operations are scoped in the iDAP namespace.
- The sender includes namespaces in iDAP elements and attributes in the SOAP body.
- The receiver processes iDAP messages that have correct namespaces. For the requests with incorrect namespaces, the receiver returns an invalid request error.
- The SOAP namespace has this value: `http://schemas.xmlsoap.org/soap/envelope/`
- The iDAP namespace has this value: `http://ns.oracle.com/AQ/schemas/access`

See Also:*Oracle Database Advanced Queuing User's Guide*

37.5 iDAP Architecture

Oracle Streams Advanced Queuing operations that use `HTTP(S)` require an iDAP `HTTP` client, a Web server, and an Oracle server.

Figure 37-2 (page 37-5) shows the relationships among these components.

- A client program sends XML messages that conform to iDAP format, to the AQ Servlet. This can be any HTTP client, such as a Web browser.
- The Web server or ServletRunner hosts the AQ servlet that can interpret the incoming XML messages, for example, Apache/Jserv or Tomcat.
- Oracle Streams AQ servlet connects to Oracle Database to perform queue operations.

Figure 37-2 iDAP Architecture for Performing AQ Operations Using HTTP(S)

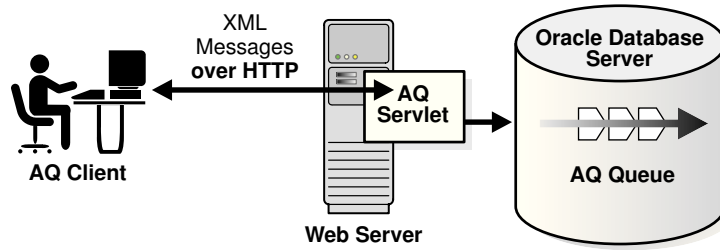

37.5.1 XMLType Queue Payloads

You can create queues with payloads that contain XMLType attributes. These can be used for transmitting and storing messages that contain XML documents.

By defining Oracle objects with XMLType attributes, you can do the following:

- Store more than one type of XML document in the same queue. The documents are stored internally as CLOB instances.
- Selectively dequeue messages with XMLType attributes using SQL/XML functions such as XMLExists and XMLQuery.
- Define transformations to convert Oracle objects to XMLType.
- Define rule-based subscribers that query message content using SQL/XML functions such as XMLExists and XMLQuery.

In the application sketched in the examples here, assume that an overseas shipping site represents an order using SYS.XMLType. An order-entry site represents an order as an Oracle object, ORDER_TYP.

[Example 37-1](#) (page 37-6) creates the queue table and queue for overseas shipping.

Because the representation of orders at the overseas shipping site is different from the representation of orders at the order-entry site, messages need to be transformed before sending them from the order-entry site to the overseas shipping site.

[Example 37-2](#) (page 37-6) creates the transformation, and [Example 37-3](#) (page 37-6) applies it.

For more information about defining transformations that convert the type used by the order entry application to the type used by overseas shipping, see *Oracle Database Advanced Queuing User's Guide*.

[Example 37-4](#) (page 37-7) shows how an application that processes orders for customers in another country, in this case Canada, can dequeue messages.

Example 37-1 Creating a Queue Table and Queue

```

BEGIN
    DBMS_AQADM.create_queue_table(
        queue_table      => 'OS_orders_pr_mqtab',
        comment          => 'Overseas Shipping MultiConsumer Orders queue table',
        multiple_consumers => TRUE,
        queue_payload_type => 'SYS.XMLtype',
        compatible       => '8.1');
END;
/

BEGIN
    DBMS_AQADM.create_queue(queue_name => 'OS_bookedorders_que',
                           queue_table => 'OS_orders_pr_mqtab');
END;
/

```

Example 37-2 Creating a Transformation to Convert Message Data to XML

```

CREATE OR REPLACE FUNCTION convert_to_order_xml(input_order ORDER_TYP)
    RETURN XMLType AS
    new_order XMLType;
BEGIN
    SELECT XMLElement("Row", input_order) INTO new_order FROM DUAL;
    RETURN new_order;
END convert_to_order_xml;
/

BEGIN
    SYS.DBMS_TRANSFORM.create_transformation(
        schema =>      'OE',
        name    =>      'OE2XML',
        from_schema => 'OE',
        from_type =>    'ORDER_TYP',
        to_schema =>    'SYS',
        to_type  =>      'XMLTYPE',
        transformation => 'convert_to_order_xml(source.user_data)');
END;
/

```

Example 37-3 Applying a Transformation before Sending Messages Overseas

```

-- Add a rule-based subscriber for overseas shipping to the booked-orders
-- queues with transformation.
DECLARE
    subscriber SYS.AQ$_AGENT;
BEGIN
    subscriber := SYS.AQ$_AGENT('Overseas_Shipping',
                               'OS.OS_bookedorders_que',
                               NULL);
    DBMS_AQADM.add_subscriber(
        queue_name      => 'OS_bookedorders_que',
        subscriber      => subscriber,
        rule            => 'XMLSerialize(CONTENT XMLQuery(''//orderregion'' ||
                                     'PASSING tab.user_data RETURNING CONTENT)' ||
                          ' AS VARCHAR2(1000)) = ''INTERNATIONAL'',
        transformation => 'OE.OE2XML');
END;
/

```

Example 37-4 XMLType and AQ: Dequeuing Messages

```

-- Create procedure to enqueue into single-consumer queues.
CREATE OR REPLACE PROCEDURE get_canada_orders AS
  deq_msgid          RAW(16);
  dopt               DBMS_AQ.dequeue_options_t;
  mprop              DBMS_AQ.message_properties_t;
  deq_order_data     SYS.XMLType;
  deq_order_data_text CLOB;
  no_messages         EXCEPTION;
  PRAGMA EXCEPTION_INIT (no_messages, -25228);
  new_orders          BOOLEAN := TRUE;
BEGIN
  dopt.wait := 1;
  -- Specify dequeue condition to select orders for Canada.
  dopt.deq_condition := 'XMLSerialize(CONTENT ' ||
                        'XMLQuery('/'/ORDER_TYP/CUSTOMER/COUNTRY/text()''' ||
                        ' PASSING tab.user_data RETURNING CONTENT)' ||
                        ' AS VARCHAR2(1000))=' 'CANADA''';
  dopt.consumer_name := 'Overseas_Shipping';
  WHILE (new_orders) LOOP
    BEGIN
      DBMS_AQ.dequeue(queue_name      => 'OS.OS_bookedorders_que',
                     dequeue_options => dopt,
                     message_properties => mprop,
                     payload          => deq_order_data,
                     msgid            => deq_msgid);

      COMMIT;
      SELECT XMLSerialize(DOCUMENT deq_order_data AS CLOB)
             INTO deq_order_data_text FROM DUAL;
      DBMS_OUTPUT.put_line('Order for Canada - Order: ' || deq_order_data_text);
    EXCEPTION
      WHEN no_messages THEN
        DBMS_OUTPUT.put_line (' ---- NO MORE ORDERS ---- ');
        new_orders := FALSE;
    END;
  END LOOP;
END;
/

```

37.6 Guidelines for Using XML and Oracle Streams Advanced Queuing

Guidelines are presented for using XML data with Oracle Streams Advanced Queuing.

37.6.1 Store Oracle Streams AQ XML Messages with Many PDFs as One Record

You can exchange XML documents between businesses using Oracle Streams Advanced Queuing (AQ), where each message includes an XML header, an XML attachment (XML data stream), DTDS, and PDF files. The data can be stored in a database table, such as a queue table.

You can enqueue the messages into Oracle queue tables as one record or piece. Or you can enqueue the messages as multiple records, for example, one record for XML data streams as CLOB type, one record for PDF files as RAW type, and so on. You can also then dequeue the messages.

You can achieve this in the following ways:

- By defining an object type with (CLOB, RAW,...) attributes, and storing it as a single message.

- By using the AQ message grouping feature and storing it in multiple messages. Here the message properties are associated with a group. To use the message grouping feature, all messages must be the same payload type.

To specify the payload, first create an object type, for example:

```
CREATE TYPE mypayload_type as OBJECT (xmlDataStream CLOB, dtd CLOB, pdf BLOB);
```

Then store it as a single message.

37.6.2 Add New Recipients After Messages Are Enqueued

You can use a queue table to support message assignments.

For example, when other businesses send messages to a specific company, they do not know who should be assigned to process the messages, but they know the messages are for department Human Resources (HR). Hence all messages go to the HR supervisor. At this point, the message is enqueued in the queue table. The HR supervisor is the only recipient of this message, and the entire HR staff have been predefined as subscribers for this queue.

You cannot change the recipient list after a message is enqueued. If you do not specify a recipient list then subscribers can subscribe to the queue and dequeue the message. Here, new recipients must be subscribers to the queue. Otherwise, you must dequeue the message and enqueue it again with new recipients.

37.6.3 Enqueue and Dequeue XML Messages

Oracle Streams AQ supports enqueueing and dequeuing objects. The objects can have an attribute of type `XMLType` that contains an XML document, in addition to having metadata attributes.

Refer to *Oracle Database Advanced Queuing User's Guide* for specific details and more examples.

37.6.4 Parse Messages with XML Content from Oracle Streams AQ Queues

You can parse messages with XML content from an Oracle Streams Advanced Queuing (AQ) queue and then update tables and fields in an Operational Data Store (ODS).

You can use Oracle XML Parser for Java and Java Stored Procedures together with Oracle Streams AQ to obtain metadata such as AQ enqueue or dequeue times and JMS header information, based on queries that target certain XML data. You can combine this with using Oracle Text XML search.

37.6.5 Prevent the Listener from Stopping Until an XML Document Is Processed

After receiving a message, you can submit a job using PL/SQL package `DBMS_JOB`. The job is invoked asynchronously in a different database session. This can prevent messages accumulating in the queue because the listener must wait until a received XML message is processed.

When receiving XML messages from clients you might need to process them as soon as they arrive. But each XML document might take several seconds to process. For PL/SQL, one procedure starts the listener, dequeues the message, and calls another procedure to process the XML document. The listener could be held up until the XML document is processed, and messages would accumulate in the queue.

After receiving a message, you can instead submit a job using PL/SQL package `DBMS_JOB`. The job is invoked asynchronously in a different database session.

You can register a PL/SQL callback, which is invoked asynchronously when a message shows up in a queue. PL/SQL callbacks are part of the Oracle Streams AQ notification framework.

37.6.6 HTTPS with AQ

You can use Oracle Streams Advanced Queuing (AQ) Internet access to send XML messages to suppliers using HTTPS and receive a response. You can enqueue and dequeue XML messages over HTTP(S) securely and transactionally.

See Also:

Oracle Database Advanced Queuing User's Guide

37.6.7 Store XML in Oracle Streams AQ Message Payloads

You can store XML data in Oracle Streams Advanced Queuing (AQ) message payloads natively other than having an ADT as the payload with `SYS.XMLType` as part of the ADT. You can create queues with payloads and attributes as `XMLType`.

37.6.8 iDAP and SOAP

iDAP is the SOAP specification for Oracle Streams Advanced Queuing (AQ) operations. SOAP defines a generic mechanism to invoke a service. iDAP defines these mechanisms to perform AQ operations.

iDAP has the following key properties not defined by SOAP:

- Transactional behavior. You can perform AQ operations in a transactional manner. A transaction can span multiple iDAP requests.
- Security. iDAP operations can be carried out only by authorized and authenticated users.

Part VIII

Appendixes

Appendixes here provide background material for Oracle XML DB.

- [Oracle-Supplied XML Schemas and Examples](#) (page A-1)
- [Oracle XML DB Restrictions](#) (page B-1)
- [Deprecated Functions for Updating XML Data](#) (page C-1)
- [Deprecated Constructs for XML Translation](#) (page D-1)
- [Deprecated Content Repository API for Java](#) (page E-1)

Oracle-Supplied XML Schemas and Examples

Full listings are provided here for the Oracle XML DB-supplied XML schemas, purchase-order XML schemas and an XSLT stylesheet used in various examples, and C-language (OCI) examples for loading XML content into Oracle XML DB and initializing and terminating an XML context.

- [XDBResource.xsd: XML Schema for Oracle XML DB Resources](#) (page A-1)
- [XDBResConfig.xsd: XML Schema for Resource Configuration](#) (page A-10)
- [acl.xsd: XML Schema for ACLs](#) (page A-13)
- [xdbconfig.xsd: XML Schema for Configuring Oracle XML DB](#) (page A-16)
- [xdiff.xsd: XML Schema for Comparing Schemas for In-Place Evolution](#) (page A-29)
- [Purchase-Order XML Schemas](#) (page A-31)
- [XSLT Stylesheet Example, PurchaseOrder.xsl](#) (page A-41)
- [Loading XML Data Using C \(OCI\)](#) (page A-46)
- [Initializing and Terminating an XML Context \(OCI\)](#) (page A-49)

A.1 XDBResource.xsd: XML Schema for Oracle XML DB Resources

A full listing is presented of the Oracle XML DB-supplied XML schema `XDBResource.xsd`, which is used to represent Oracle XML DB resources.

XDBResource.xsd

```
<schema xdb:schemaURL="http://xmlns.oracle.com/xdb/XDBResource.xsd"
  targetNamespace="http://xmlns.oracle.com/xdb/XDBResource.xsd" version="1.0"
  xdb:numProps="73" elementFormDefault="qualified" xdb:flags="23"
  xdb:mapStringToNCHAR="false" xdb:mapUnboundedStringToLob="false"
  xdb:storeVarrayAsTable="false" xdb:schemaOwner="XDB"
  xmlns="http://www.w3.org/2001/XMLSchema" xmlns:xdb="http://xmlns.oracle.com/xdb"
  xmlns:xdbres="http://xmlns.oracle.com/xdb/XDBResource.xsd">
  <simpleType name="OracleUserName">
    <restriction base="string">
      <minLength value="1" fixed="false"/>
      <maxLength value="4000" fixed="false"/>
    </restriction>
  </simpleType>
  <simpleType name="ResMetaStr">
    <restriction base="string">
```

```

    <minLength value="1" fixed="false"/>
    <maxLength value="128" fixed="false"/>
  </restriction>
</simpleType>
<simpleType name="SchElemType">
  <restriction base="string">
    <minLength value="1" fixed="false"/>
    <maxLength value="4000" fixed="false"/>
  </restriction>
</simpleType>
<simpleType name="GUID">
  <restriction base="hexBinary">
    <minLength value="8" fixed="false"/>
    <maxLength value="32" fixed="false"/>
  </restriction>
</simpleType>
<simpleType name="LocksRaw">
  <restriction base="hexBinary">
    <minLength value="0" fixed="false"/>
    <maxLength value="2000" fixed="false"/>
  </restriction>
</simpleType>
<simpleType name="lockModeType">
  <restriction base="string">
    <enumeration value="exclusive" fixed="false"/>
    <enumeration value="shared" fixed="false"/>
  </restriction>
</simpleType>
<simpleType name="lockTypeType">
  <restriction base="string">
    <enumeration value="read-write" fixed="false"/>
    <enumeration value="write" fixed="false"/>
    <enumeration value="read" fixed="false"/>
  </restriction>
</simpleType>
<simpleType name="lockDepthType">
  <restriction base="string">
    <enumeration value="0" fixed="false"/>
    <enumeration value="infinity" fixed="false"/>
  </restriction>
</simpleType>
<complexType name="lockType" abstract="false" mixed="false">
  <sequence minOccurs="1" maxOccurs="1">
    <element xdb:propNumber="768" name="LockOwner" type="string" xdb:memType="1"
      xdb:system="false" xdb:mutable="true" xdb:JavaType="String"
      xdb:global="false" nillable="false" abstract="false" xdb:SQLInline="true"
      xdb:JavaInline="false" xdb:MemInline="true" xdb:maintainDOM="false"
      xdb:defaultTableSchema="XDB" xdb:numCols="1" minOccurs="1" maxOccurs="1"/>
    <element xdb:propNumber="769" name="Mode" type="xdb:lockModeType" xdb:memType="1"
      xdb:system="false" xdb:mutable="true" xdb:JavaType="String"
      xdb:global="false" nillable="false" abstract="false" xdb:SQLInline="true"
      xdb:JavaInline="false" xdb:MemInline="true" xdb:maintainDOM="false"
      xdb:defaultTableSchema="XDB" xdb:numCols="1" minOccurs="1" maxOccurs="1"/>
    <element xdb:propNumber="770" name="Type" type="xdb:lockTypeType" xdb:memType="1"
      xdb:system="false" xdb:mutable="true" xdb:JavaType="String"
      xdb:global="false" nillable="false" abstract="false" xdb:SQLInline="true"
      xdb:JavaInline="false" xdb:MemInline="true" xdb:maintainDOM="false"
      xdb:defaultTableSchema="XDB" xdb:numCols="1" minOccurs="1" maxOccurs="1"/>
    <element xdb:propNumber="771" name="Depth" type="xdb:lockDepthType" xdb:memType="1"
      xdb:system="false" xdb:mutable="true" xdb:JavaType="String"
      xdb:global="false" nillable="false" abstract="false" xdb:SQLInline="true"

```

```

        xdb:JavaInline="false" xdb:MemInline="true" xdb:maintainDOM="false"
        xdb:defaultTableSchema="XDB" xdb:numCols="1" minOccurs="1" maxOccurs="1"/>
<element xdb:propNumber="772" name="Expiry" type="dateTime" xdb:memType="180"
        xdb:system="false" xdb:mutable="true" xdb:JavaType="TimeStamp"
        xdb:global="false" nillable="false" abstract="false" xdb:SQLInline="true"
        xdb:JavaInline="false" xdb:MemInline="true" xdb:maintainDOM="false"
        xdb:defaultTableSchema="XDB" xdb:numCols="1" minOccurs="0" maxOccurs="1"/>
<choice minOccurs="0" maxOccurs="unbounded">
  <element xdb:propNumber="773" name="Token" type="string" xdb:memType="1"
        xdb:system="false" xdb:mutable="true" xdb:JavaType="String"
        xdb:global="false" nillable="false" abstract="false" xdb:SQLInline="true"
        xdb:JavaInline="false" xdb:MemInline="true" xdb:maintainDOM="false"
        xdb:defaultTableSchema="XDB" xdb:numCols="1" minOccurs="0" maxOccurs="1"/>
  <element xdb:propNumber="774" name="NodeId" type="string" xdb:memType="1"
        xdb:system="false" xdb:mutable="true" xdb:JavaType="String"
        xdb:global="false" nillable="false" abstract="false" xdb:SQLInline="true"
        xdb:JavaInline="false" xdb:MemInline="true" xdb:maintainDOM="false"
        xdb:defaultTableSchema="XDB" xdb:numCols="1" minOccurs="0" maxOccurs="1"/>
</choice>
</sequence>
</complexType>
<complexType name="locksType" abstract="false" mixed="false">
  <sequence minOccurs="1" maxOccurs="1">
    <element xdb:propNumber="767" name="Lock" type="xdb:lockType" xdb:memType="258"
          xdb:system="false" xdb:mutable="true" xdb:JavaType="XMLType"
          xdb:global="false" nillable="false" abstract="false" xdb:SQLInline="true"
          xdb:JavaInline="false" xdb:MemInline="true" xdb:maintainDOM="false"
          xdb:defaultTableSchema="XDB" minOccurs="0" maxOccurs="2147483647"/>
  </sequence>
</complexType>
<complexType name="ResContentsType" abstract="false" mixed="false">
  <sequence minOccurs="1" maxOccurs="1">
    <any xdb:propNumber="736" name="ContentsAny" xdb:memType="258" xdb:system="false"
        xdb:mutable="false" xdb:JavaType="XMLType" minOccurs="0" maxOccurs="1"/>
  </sequence>
</complexType>
<complexType name="ResAclType" abstract="false" mixed="false">
  <sequence minOccurs="1" maxOccurs="1">
    <any xdb:propNumber="737" name="ACLAny" xdb:memType="258" xdb:system="false"
        xdb:mutable="false" xdb:JavaType="XMLType" minOccurs="0" maxOccurs="1"/>
  </sequence>
</complexType>
<complexType name="AttrCopyType" abstract="false" mixed="false">
  <sequence minOccurs="1" maxOccurs="1">
    <any xdb:propNumber="748" name="AttrCopyAny" xdb:memType="258" xdb:system="false"
        xdb:mutable="false" xdb:JavaType="XMLType" minOccurs="0" maxOccurs="65535"/>
  </sequence>
</complexType>
<complexType name="RCListType" abstract="false" mixed="false">
  <sequence minOccurs="1" maxOccurs="1">
    <element xdb:propNumber="755" name="OID" type="hexBinary" xdb:memByteLength="22"
          xdb:memType="23" xdb:system="false" xdb:mutable="false" xdb:SQLName="OID"
          xdb:SQLType="RAW" xdb:JavaType="byteArray" xdb:global="false"
          xdb:SQLCollType="XDB$OID_LIST_T" xdb:SQLCollSchema="XDB" xdb:hidden="false"
          nillable="false" abstract="false" xdb:SQLInline="true"
          xdb:JavaInline="false" xdb:MemInline="true" xdb:maintainDOM="false"
          xdb:defaultTableSchema="XDB" xdb:numCols="1" minOccurs="1"
          maxOccurs="65535"/>
  </sequence>
</complexType>
<complexType name="ResourceType" abstract="false" mixed="false">

```

```

<sequence minOccurs="1" maxOccurs="1">
  <element xdb:propNumber="709" name="CreationDate" type="dateTime" xdb:memType="180"
    xdb:system="false" xdb:mutable="false" xdb:SQLName="CREATIONDATE"
    xdb:SQLType="TIMESTAMP" xdb:JavaType="TimeStamp" xdb:global="false"
    nillable="false" abstract="false" xdb:SQLInline="true"
    xdb:JavaInline="false" xdb:MemInline="true" xdb:maintainDOM="false"
    xdb:defaultTableSchema="XDB" xdb:numCols="1" minOccurs="1" maxOccurs="1"/>
  <element xdb:propNumber="710" name="ModificationDate" type="dateTime"
    xdb:memType="180" xdb:system="false" xdb:mutable="false"
    xdb:SQLName="MODIFICATIONDATE" xdb:SQLType="TIMESTAMP"
    xdb:JavaType="TimeStamp" xdb:global="false" nillable="false"
    abstract="false" xdb:SQLInline="true" xdb:JavaInline="false"
    xdb:MemInline="true" xdb:maintainDOM="false" xdb:defaultTableSchema="XDB"
    xdb:numCols="1" minOccurs="1" maxOccurs="1"/>
  <element xdb:propNumber="711" name="Author" type="xdb:ResMetaStr" xdb:memType="1"
    xdb:system="false" xdb:mutable="false" xdb:SQLName="AUTHOR"
    xdb:SQLType="VARCHAR2" xdb:JavaType="String" xdb:global="false"
    nillable="false" abstract="false" xdb:SQLInline="true"
    xdb:JavaInline="false" xdb:MemInline="false" xdb:maintainDOM="false"
    xdb:defaultTableSchema="XDB" xdb:numCols="1" minOccurs="0" maxOccurs="1"/>
  <element xdb:propNumber="712" name="DisplayName" type="xdb:ResMetaStr"
    xdb:memType="1" xdb:system="false" xdb:mutable="false"
    xdb:SQLName="DISPNAME" xdb:SQLType="VARCHAR2" xdb:JavaType="String"
    xdb:global="false" nillable="false" abstract="false" xdb:SQLInline="true"
    xdb:JavaInline="false" xdb:MemInline="false" xdb:maintainDOM="false"
    xdb:defaultTableSchema="XDB" xdb:numCols="1" minOccurs="1" maxOccurs="1"/>
  <element xdb:propNumber="713" name="Comment" type="xdb:ResMetaStr" xdb:memType="1"
    xdb:system="false" xdb:mutable="false" xdb:SQLName="RESCOMMENT"
    xdb:SQLType="VARCHAR2" xdb:JavaType="String" xdb:global="false"
    nillable="false" abstract="false" xdb:SQLInline="true"
    xdb:JavaInline="false" xdb:MemInline="false" xdb:maintainDOM="false"
    xdb:defaultTableSchema="XDB" xdb:numCols="1" minOccurs="1" maxOccurs="1"/>
  <element xdb:propNumber="714" name="Language" type="xdb:ResMetaStr" xdb:memType="1"
    xdb:system="false" xdb:mutable="false" xdb:SQLName="LANGUAGE"
    xdb:SQLType="VARCHAR2" xdb:JavaType="String" default="en"
    xdb:global="false" nillable="false" abstract="false" xdb:SQLInline="true"
    xdb:JavaInline="false" xdb:MemInline="false" xdb:maintainDOM="false"
    xdb:defaultTableSchema="XDB" xdb:numCols="1" minOccurs="1" maxOccurs="1"/>
  <element xdb:propNumber="715" name="CharacterSet" type="xdb:ResMetaStr"
    xdb:memType="1" xdb:system="false" xdb:mutable="false"
    xdb:SQLName="CHARSET" xdb:SQLType="VARCHAR2" xdb:JavaType="String"
    xdb:global="false" nillable="false" abstract="false" xdb:SQLInline="true"
    xdb:JavaInline="false" xdb:MemInline="false" xdb:maintainDOM="false"
    xdb:defaultTableSchema="XDB" xdb:numCols="1" minOccurs="0" maxOccurs="1"/>
  <element xdb:propNumber="716" name="ContentType" type="xdb:ResMetaStr"
    xdb:memType="1" xdb:system="false" xdb:mutable="false"
    xdb:SQLName="CONTYPE" xdb:SQLType="VARCHAR2" xdb:JavaType="String"
    xdb:global="false" nillable="false" abstract="false" xdb:SQLInline="true"
    xdb:JavaInline="false" xdb:MemInline="false" xdb:maintainDOM="false"
    xdb:defaultTableSchema="XDB" xdb:numCols="1" minOccurs="0" maxOccurs="1"/>
  <element xdb:propNumber="717" name="RefCount" type="nonNegativeInteger"
    xdb:memByteLength="4" xdb:memType="68" xdb:system="false"
    xdb:mutable="true" xdb:SQLName="REFCOUNT" xdb:SQLType="RAW"
    xdb:JavaType="long" xdb:global="false" nillable="false" abstract="false"
    xdb:SQLInline="true" xdb:JavaInline="false" xdb:MemInline="true"
    xdb:maintainDOM="false" xdb:defaultTableSchema="XDB" xdb:numCols="1"
    minOccurs="1" maxOccurs="1"/>
  <element xdb:propNumber="718" name="LockBuf" type="xdb:LocksRaw" xdb:memType="23"
    xdb:system="false" xdb:mutable="true" xdb:SQLName="LOCKS" xdb:SQLType="RAW"
    xdb:JavaType="byteArray" xdb:global="false" nillable="false"
    abstract="false" xdb:SQLInline="true" xdb:JavaInline="false"

```



```

        xdb:MemInline="false" xdb:maintainDOM="false" xdb:defaultTableSchema="XDB"
        xdb:numCols="1" minOccurs="0" maxOccurs="1"/>
<element xdb:propNumber="732" name="ACL" type="xdb:ResAclType" xdb:memType="258"
        xdb:system="false" xdb:mutable="false" xdb:JavaType="XMLType"
        xdb:global="false" xdb:hidden="false" xdb:transient="generated"
        xdb:baseProp="false" nillable="false" abstract="false" xdb:SQLInline="true"
        xdb:JavaInline="false" xdb:MemInline="false" xdb:maintainDOM="false"
        xdb:defaultTableSchema="XDB" xdb:JavaClassname="oracle.xdb.ResAclTypeBean"
        xdb:beanClassname="oracle.xdb.ResAclTypeBean" xdb:numCols="0" minOccurs="0"
        maxOccurs="1"/>
<element xdb:propNumber="719" name="ACLOID" type="hexBinary" xdb:memType="23"
        xdb:system="false" xdb:mutable="false" xdb:SQLName="ACLOID"
        xdb:SQLType="RAW" xdb:JavaType="byteArray" xdb:global="false"
        xdb:hidden="true" xdb:baseProp="true" nillable="false" abstract="false"
        xdb:SQLInline="true" xdb:JavaInline="false" xdb:MemInline="true"
        xdb:maintainDOM="false" xdb:defaultTableSchema="XDB" xdb:numCols="1"
        minOccurs="1" maxOccurs="1"/>
<element xdb:propNumber="720" name="Owner" type="xdb:OracleUserName" xdb:memType="1"
        xdb:system="false" xdb:mutable="false" xdb:JavaType="String"
        xdb:global="false" xdb:hidden="false" xdb:transient="generated"
        xdb:baseProp="false" nillable="false" abstract="false" xdb:SQLInline="true"
        xdb:JavaInline="false" xdb:MemInline="false" xdb:maintainDOM="false"
        xdb:defaultTableSchema="XDB" xdb:numCols="0" minOccurs="0" maxOccurs="1"/>
<element xdb:propNumber="721" name="OwnerID" type="xdb:GUID" xdb:memType="23"
        xdb:system="false" xdb:mutable="false" xdb:SQLName="OWNERID"
        xdb:SQLType="RAW" xdb:JavaType="byteArray" xdb:global="false"
        xdb:hidden="true" xdb:baseProp="true" nillable="false" abstract="false"
        xdb:SQLInline="true" xdb:JavaInline="false" xdb:MemInline="true"
        xdb:maintainDOM="false" xdb:defaultTableSchema="XDB" xdb:numCols="1"
        minOccurs="1" maxOccurs="1"/>
<element xdb:propNumber="722" name="Creator" type="xdb:OracleUserName"
        xdb:memType="1" xdb:system="false" xdb:mutable="false"
        xdb:JavaType="String" xdb:global="false" xdb:hidden="false"
        xdb:transient="generated" xdb:baseProp="false" nillable="false"
        abstract="false" xdb:SQLInline="true" xdb:JavaInline="false"
        xdb:MemInline="false" xdb:maintainDOM="false" xdb:defaultTableSchema="XDB"
        xdb:numCols="0" minOccurs="0" maxOccurs="1"/>
<element xdb:propNumber="723" name="CreatorID" type="xdb:GUID" xdb:memType="23"
        xdb:system="false" xdb:mutable="false" xdb:SQLName="CREATORID"
        xdb:SQLType="RAW" xdb:JavaType="byteArray" xdb:global="false"
        xdb:hidden="true" xdb:baseProp="true" nillable="false" abstract="false"
        xdb:SQLInline="true" xdb:JavaInline="false" xdb:MemInline="true"
        xdb:maintainDOM="false" xdb:defaultTableSchema="XDB" xdb:numCols="1"
        minOccurs="1" maxOccurs="1"/>
<element xdb:propNumber="724" name="LastModifier" type="xdb:OracleUserName"
        xdb:memType="1" xdb:system="false" xdb:mutable="false"
        xdb:JavaType="String" xdb:global="false" xdb:hidden="false"
        xdb:transient="generated" xdb:baseProp="false" nillable="false"
        abstract="false" xdb:SQLInline="true" xdb:JavaInline="false"
        xdb:MemInline="false" xdb:maintainDOM="false" xdb:defaultTableSchema="XDB"
        xdb:numCols="0" minOccurs="0" maxOccurs="1"/>
<element xdb:propNumber="725" name="LastModifierID" type="xdb:GUID" xdb:memType="23"
        xdb:system="false" xdb:mutable="false" xdb:SQLName="LASTMODIFIERID"
        xdb:SQLType="RAW" xdb:JavaType="byteArray" xdb:global="false"
        xdb:hidden="true" xdb:baseProp="true" nillable="false" abstract="false"
        xdb:SQLInline="true" xdb:JavaInline="false" xdb:MemInline="true"
        xdb:maintainDOM="false" xdb:defaultTableSchema="XDB" xdb:numCols="1"
        minOccurs="1" maxOccurs="1"/>
<element xdb:propNumber="726" name="SchemaElement" type="xdb:SchElemType"
        xdb:memType="1" xdb:system="false" xdb:mutable="false"
        xdb:JavaType="String" xdb:global="false" xdb:hidden="false"

```

```

xdb:transient="generated" xdb:baseProp="false" nillable="false"
abstract="false" xdb:SQLInline="true" xdb:JavaInline="false"
xdb:MemInline="false" xdb:maintainDOM="false" xdb:defaultTableSchema="XDB"
xdb:numCols="0" minOccurs="0" maxOccurs="1"/>
<element xdb:propNumber="727" name="ElNum" type="nonNegativeInteger"
xdb:memByteLength="4" xdb:memType="3" xdb:system="false"
xdb:mutable="false" xdb:SQLName="ELNUM" xdb:SQLType="INTEGER"
xdb:JavaType="long" xdb:global="false" xdb:hidden="true"
xdb:baseProp="true" nillable="false" abstract="false" xdb:SQLInline="true"
xdb:JavaInline="false" xdb:MemInline="true" xdb:maintainDOM="false"
xdb:defaultTableSchema="XDB" xdb:numCols="1" minOccurs="1" maxOccurs="1"/>
<element xdb:propNumber="728" name="SchOID" type="hexBinary" xdb:memType="23"
xdb:system="false" xdb:mutable="false" xdb:SQLName="SCHOID"
xdb:SQLType="RAW" xdb:JavaType="byteArray" xdb:global="false"
xdb:hidden="true" xdb:baseProp="true" nillable="false" abstract="false"
xdb:SQLInline="true" xdb:JavaInline="false" xdb:MemInline="true"
xdb:maintainDOM="false" xdb:defaultTableSchema="XDB" xdb:numCols="1"
minOccurs="1" maxOccurs="1"/>
<element xdb:propNumber="733" name="Contents" type="xdb:ResContentsType"
xdb:memType="258" xdb:system="false" xdb:mutable="false"
xdb:JavaType="XMLType" xdb:global="false" xdb:hidden="false"
xdb:transient="manifested" xdb:baseProp="false" nillable="false"
abstract="false" xdb:SQLInline="true" xdb:JavaInline="false"
xdb:MemInline="false" xdb:maintainDOM="false" xdb:defaultTableSchema="XDB"
xdb:JavaClassname="oracle.xdb.ResContentsTypeBean"
xdb:beanClassname="oracle.xdb.ResContentsTypeBean" xdb:numCols="0"
minOccurs="0" maxOccurs="1"/>
<element xdb:propNumber="729" name="XMLRef" type="REF" xdb:memType="110"
xdb:system="false" xdb:mutable="true" xdb:SQLName="XMLREF"
xdb:SQLType="REF" xdb:JavaType="Reference" xdb:global="false"
xdb:hidden="true" xdb:baseProp="false" nillable="false" abstract="false"
xdb:SQLInline="true" xdb:JavaInline="false" xdb:MemInline="false"
xdb:maintainDOM="false" xdb:defaultTableSchema="XDB" xdb:numCols="0"
minOccurs="0" maxOccurs="1"/>
<element xdb:propNumber="730" name="XMLlob" type="hexBinary" xdb:memType="113"
xdb:system="false" xdb:mutable="true" xdb:SQLName="XMLLOB"
xdb:SQLType="BLOB" xdb:JavaType="String" xdb:global="false"
xdb:hidden="true" xdb:baseProp="false" nillable="false" abstract="false"
xdb:SQLInline="true" xdb:JavaInline="false" xdb:MemInline="false"
xdb:maintainDOM="false" xdb:defaultTableSchema="XDB" xdb:numCols="0"
minOccurs="0" maxOccurs="1"/>
<element xdb:propNumber="731" name="Flags" type="nonNegativeInteger"
xdb:memByteLength="4" xdb:memType="3" xdb:system="false" xdb:mutable="true"
xdb:SQLName="FLAGS" xdb:SQLType="RAW" xdb:JavaType="long"
xdb:global="false" xdb:hidden="true" xdb:baseProp="true" nillable="false"
abstract="false" xdb:SQLInline="true" xdb:JavaInline="false"
xdb:MemInline="true" xdb:maintainDOM="false" xdb:defaultTableSchema="XDB"
xdb:numCols="0" minOccurs="1" maxOccurs="1"/>
<element xdb:propNumber="740" name="VCRUID" type="xdb:GUID" xdb:memType="23"
xdb:system="false" xdb:mutable="false" xdb:SQLName="VCRUID"
xdb:SQLType="RAW" xdb:JavaType="byteArray" xdb:global="false"
nillable="false" abstract="false" xdb:SQLInline="true"
xdb:JavaInline="false" xdb:MemInline="false" xdb:maintainDOM="false"
xdb:defaultTableSchema="XDB" xdb:numCols="1" minOccurs="1" maxOccurs="1"/>
<element xdb:propNumber="741" name="Parents" type="hexBinary" xdb:memType="23"
xdb:system="false" xdb:mutable="false" xdb:SQLName="PARENTS"
xdb:SQLType="RAW" xdb:JavaType="Reference" xdb:global="false"
xdb:SQLCollType="XDB$PREDECESSOR_LIST_T" xdb:SQLCollSchema="XDB"
nillable="false" abstract="false" xdb:SQLInline="true"
xdb:JavaInline="false" xdb:MemInline="false" xdb:maintainDOM="false"
xdb:defaultTableSchema="XDB" xdb:numCols="0" minOccurs="0"

```

```

maxOccurs="1000"/>
<element xdb:propNumber="745" name="SBResExtra" type="REF" xdb:memType="110"
  xdb:system="false" xdb:mutable="true" xdb:SQLName="SBRESEXTRA"
  xdb:SQLType="REF" xdb:JavaType="Reference" xdb:global="false"
  xdb:SQLCollType="XDB$XMLTYPE_REF_LIST_T" xdb:SQLCollSchema="XDB"
  xdb:hidden="true" xdb:baseProp="false" nillable="false" abstract="false"
  xdb:SQLInline="true" xdb:JavaInline="false" xdb:MemInline="false"
  xdb:maintainDOM="false" xdb:defaultTableSchema="XDB" xdb:numCols="0"
  minOccurs="0" maxOccurs="2147483647"/>
<element xdb:propNumber="746" name="Snapshot" type="hexBinary" xdb:memType="23"
  xdb:system="false" xdb:mutable="true" xdb:SQLName="SNAPSHOT"
  xdb:SQLType="RAW" xdb:JavaType="byteArray" xdb:global="false"
  xdb:hidden="true" xdb:baseProp="true" nillable="false" abstract="false"
  xdb:SQLInline="true" xdb:JavaInline="false" xdb:MemInline="true"
  xdb:maintainDOM="false" xdb:defaultTableSchema="XDB" xdb:numCols="0"
  minOccurs="1" maxOccurs="1"/>
<element xdb:propNumber="747" name="AttrCopy" type="xdb:AttrCopyType"
  xdb:memType="258" xdb:system="false" xdb:mutable="true"
  xdb:SQLName="ATTRCOPY" xdb:SQLType="BLOB" xdb:JavaType="XMLType"
  xdb:global="false" xdb:hidden="true" xdb:baseProp="true" nillable="false"
  abstract="false" xdb:SQLInline="true" xdb:JavaInline="false"
  xdb:MemInline="false" xdb:maintainDOM="false" xdb:defaultTableSchema="XDB"
  xdb:numCols="0" minOccurs="0" maxOccurs="1"/>
<element xdb:propNumber="749" name="CtsCopy" type="hexBinary" xdb:memType="113"
  xdb:system="false" xdb:mutable="true" xdb:SQLName="CTSCOPY"
  xdb:SQLType="BLOB" xdb:JavaType="String" xdb:global="false"
  xdb:hidden="true" xdb:baseProp="false" nillable="false" abstract="false"
  xdb:SQLInline="true" xdb:JavaInline="false" xdb:MemInline="false"
  xdb:maintainDOM="false" xdb:defaultTableSchema="XDB" xdb:numCols="1"
  minOccurs="0" maxOccurs="1"/>
<element xdb:propNumber="750" name="NodeNum" type="hexBinary" xdb:memType="23"
  xdb:system="false" xdb:mutable="true" xdb:SQLName="NODENUM"
  xdb:SQLType="RAW" xdb:JavaType="byteArray" xdb:global="false"
  xdb:hidden="true" xdb:baseProp="true" nillable="false" abstract="false"
  xdb:SQLInline="true" xdb:JavaInline="false" xdb:MemInline="true"
  xdb:maintainDOM="false" xdb:defaultTableSchema="XDB" xdb:numCols="0"
  minOccurs="1" maxOccurs="1"/>
<element xdb:propNumber="751" name="ContentSize" type="integer"
  xdb:memByteLength="8" xdb:memType="3" xdb:system="false"
  xdb:mutable="false" xdb:JavaType="long" xdb:global="false"
  xdb:hidden="true" xdb:transient="generated" xdb:baseProp="false"
  nillable="false" abstract="false" xdb:SQLInline="true"
  xdb:JavaInline="false" xdb:MemInline="true" xdb:maintainDOM="false"
  xdb:defaultTableSchema="XDB" xdb:numCols="0" minOccurs="0" maxOccurs="1"/>
<element xdb:propNumber="752" name="SizeOnDisk" type="nonNegativeInteger"
  xdb:memByteLength="8" xdb:memType="3" xdb:system="false"
  xdb:mutable="false" xdb:SQLName="SIZEONDISK" xdb:SQLType="INTEGER"
  xdb:JavaType="long" xdb:global="false" xdb:hidden="true"
  xdb:baseProp="true" nillable="false" abstract="false" xdb:SQLInline="true"
  xdb:JavaInline="false" xdb:MemInline="true" xdb:maintainDOM="false"
  xdb:defaultTableSchema="XDB" xdb:numCols="0" minOccurs="0" maxOccurs="1"/>
<element xdb:propNumber="754" name="RCLList" type="xdb:RCLListType" xdb:memType="258"
  xdb:system="false" xdb:mutable="false" xdb:SQLName="RCLIST"
  xdb:SQLType="XDB$RCLIST_T" xdb:SQLSchema="XDB" xdb:JavaType="XMLType"
  xdb:global="true" xdb:hidden="true" xdb:baseProp="true" nillable="false"
  abstract="false" xdb:SQLInline="true" xdb:JavaInline="false"
  xdb:MemInline="false" xdb:maintainDOM="false" xdb:defaultTable="00"
  xdb:defaultTableSchema="XDB" xdb:JavaClassname="oracle.xdb.RCLListBean"
  xdb:beanClassname="oracle.xdb.RCLListBean" xdb:numCols="1" minOccurs="0"
  maxOccurs="1"/>
<element xdb:propNumber="762" name="Branch" type="string" xdb:memType="1"

```

```

xdb:system="false" xdb:mutable="false" xdb:SQLName="BRANCH"
xdb:SQLType="VARCHAR2" xdb:JavaType="String" xdb:global="false"
xdb:hidden="false" xdb:transient="generated" xdb:baseProp="false"
nillable="false" abstract="false" xdb:SQLInline="true"
xdb:JavaInline="false" xdb:MemInline="false" xdb:maintainDOM="false"
xdb:defaultTableSchema="XDB" xdb:numCols="1" minOccurs="0" maxOccurs="1"/>
<element xdb:propNumber="763" name="CheckedOutBy" type="xdb:OracleUserName"
xdb:memType="1" xdb:system="false" xdb:mutable="false"
xdb:JavaType="String" xdb:global="false" xdb:hidden="false"
xdb:transient="generated" xdb:baseProp="false" nillable="false"
abstract="false" xdb:SQLInline="true" xdb:JavaInline="false"
xdb:MemInline="false" xdb:maintainDOM="false" xdb:defaultTableSchema="XDB"
xdb:numCols="0" minOccurs="0" maxOccurs="1"/>
<element xdb:propNumber="764" name="CheckedOutByID" type="xdb:GUID" xdb:memType="23"
xdb:system="false" xdb:mutable="false" xdb:SQLName="CHECKEDOUTBYID"
xdb:SQLType="RAW" xdb:JavaType="byteArray" xdb:global="false"
xdb:hidden="true" xdb:baseProp="true" nillable="false" abstract="false"
xdb:SQLInline="true" xdb:JavaInline="false" xdb:MemInline="true"
xdb:maintainDOM="false" xdb:defaultTableSchema="XDB" xdb:numCols="1"
minOccurs="0" maxOccurs="1"/>
<element xdb:propNumber="765" name="BaseVersion" type="hexBinary" xdb:memType="23"
xdb:system="false" xdb:mutable="false" xdb:SQLName="BASEVERSION"
xdb:SQLType="RAW" xdb:JavaType="byteArray" xdb:global="false"
xdb:hidden="false" xdb:baseProp="false" nillable="false" abstract="false"
xdb:SQLInline="true" xdb:JavaInline="false" xdb:MemInline="true"
xdb:maintainDOM="false" xdb:defaultTableSchema="XDB" xdb:numCols="1"
minOccurs="0" maxOccurs="1"/>
<element xdb:propNumber="766" name="Locks" type="xdb:locksType" xdb:memType="258"
xdb:system="false" xdb:mutable="true" xdb:JavaType="XMLType"
xdb:global="false" xdb:hidden="true" xdb:transient="generated"
nillable="false" abstract="false" xdb:SQLInline="true"
xdb:JavaInline="false" xdb:MemInline="false" xdb:maintainDOM="false"
xdb:defaultTableSchema="XDB" xdb:numCols="1" minOccurs="0" maxOccurs="1"/>
<any xdb:propNumber="735" name="ResExtra" xdb:memType="258" xdb:system="false"
xdb:mutable="false" xdb:SQLName="RESEXTRA" xdb:SQLType="CLOB"
xdb:JavaType="XMLType" namespace="##other" minOccurs="0" maxOccurs="65535"/>
</sequence>
<attribute xdb:propNumber="705" name="Hidden" type="boolean" xdb:memByteLength="1"
xdb:memType="252" xdb:system="false" xdb:mutable="false"
xdb:JavaType="boolean" default="false" xdb:hidden="false"
xdb:transient="generated" xdb:baseProp="false"/>
<attribute xdb:propNumber="706" name="Invalid" type="boolean" xdb:memByteLength="1"
xdb:memType="252" xdb:system="false" xdb:mutable="false"
xdb:JavaType="boolean" default="false" xdb:hidden="false"
xdb:transient="generated" xdb:baseProp="false"/>
<attribute xdb:propNumber="707" name="VersionID" type="integer" xdb:memByteLength="4"
xdb:memType="3" xdb:system="false" xdb:mutable="false"
xdb:SQLName="VERSIONID" xdb:SQLType="INTEGER" xdb:JavaType="long"/>
<attribute xdb:propNumber="708" name="ActivityID" type="integer" xdb:memByteLength="4"
xdb:memType="3" xdb:system="false" xdb:mutable="false"
xdb:SQLName="ACTIVITYID" xdb:SQLType="INTEGER" xdb:JavaType="long"/>
<attribute xdb:propNumber="738" name="Container" type="boolean" xdb:memByteLength="1"
xdb:memType="252" xdb:system="false" xdb:mutable="true"
xdb:JavaType="boolean" default="false" xdb:hidden="false"
xdb:transient="generated" xdb:baseProp="false"/>
<attribute xdb:propNumber="739" name="CustomRslv" type="boolean" xdb:memByteLength="1"
xdb:memType="252" xdb:system="false" xdb:mutable="false"
xdb:JavaType="boolean" default="false" xdb:hidden="false"
xdb:transient="generated" xdb:baseProp="false"/>
<attribute xdb:propNumber="742" name="VersionHistory" type="boolean"
xdb:memByteLength="1" xdb:memType="252" xdb:system="false"

```

```

        xdb:mutable="false" xdb:JavaType="boolean" default="false"
        xdb:hidden="false" xdb:transient="generated" xdb:baseProp="false"/>
<attribute xdb:propNumber="743" name="StickyRef" type="boolean" xdb:memByteLength="1"
        xdb:memType="252" xdb:system="false" xdb:mutable="false"
        xdb:JavaType="boolean" default="false" xdb:hidden="false"
        xdb:transient="generated" xdb:baseProp="false"/>
<attribute xdb:propNumber="744" name="HierSchmResource" type="boolean"
        xdb:memByteLength="1" xdb:memType="252" xdb:system="false"
        xdb:mutable="false" xdb:JavaType="boolean" default="false"
        xdb:hidden="true" xdb:transient="generated" xdb:baseProp="false"/>
<attribute xdb:propNumber="753" name="SizeAccurate" type="boolean"
        xdb:memByteLength="1" xdb:memType="252" xdb:system="false"
        xdb:mutable="false" xdb:JavaType="boolean" default="false"
        xdb:hidden="true" xdb:transient="generated" xdb:baseProp="false"/>
<attribute xdb:propNumber="756" name="IsVersionable" type="boolean"
        xdb:memByteLength="1" xdb:memType="252" xdb:system="false"
        xdb:mutable="false" xdb:JavaType="boolean" default="false"
        xdb:hidden="true" xdb:transient="generated" xdb:baseProp="false"/>
<attribute xdb:propNumber="757" name="IsCheckedOut" type="boolean"
        xdb:memByteLength="1" xdb:memType="252" xdb:system="false"
        xdb:mutable="false" xdb:JavaType="boolean" default="false"
        xdb:hidden="true" xdb:transient="generated" xdb:baseProp="false"/>
<attribute xdb:propNumber="758" name="IsVersion" type="boolean" xdb:memByteLength="1"
        xdb:memType="252" xdb:system="false" xdb:mutable="false"
        xdb:JavaType="boolean" default="false" xdb:hidden="true"
        xdb:transient="generated" xdb:baseProp="false"/>
<attribute xdb:propNumber="759" name="IsVCR" type="boolean" xdb:memByteLength="1"
        xdb:memType="252" xdb:system="false" xdb:mutable="false"
        xdb:JavaType="boolean" default="false" xdb:hidden="true"
        xdb:transient="generated" xdb:baseProp="false"/>
<attribute xdb:propNumber="760" name="IsVersionHistory" type="boolean"
        xdb:memByteLength="1" xdb:memType="252" xdb:system="false"
        xdb:mutable="false" xdb:JavaType="boolean" default="false"
        xdb:hidden="true" xdb:transient="generated" xdb:baseProp="false"/>
<attribute xdb:propNumber="761" name="IsWorkspace" type="boolean"
        xdb:memByteLength="1" xdb:memType="252" xdb:system="false"
        xdb:mutable="false" xdb:JavaType="boolean" default="false"
        xdb:hidden="true" xdb:transient="generated" xdb:baseProp="false"/>
<attribute xdb:propNumber="776" name="HasUnresolvedLinks" type="boolean"
        xdb:memByteLength="1" xdb:memType="252" xdb:system="false"
        xdb:mutable="false" xdb:JavaType="boolean" default="false"
        xdb:hidden="false" xdb:transient="generated" xdb:baseProp="false"/>
<attribute xdb:propNumber="777" name="IsXMLIndexed" type="boolean"
        xdb:memByteLength="1" xdb:memType="252" xdb:system="false"
        xdb:mutable="true" xdb:JavaType="boolean" default="false" xdb:hidden="true"
        xdb:transient="generated" xdb:baseProp="false"/>
</complexType>
<element xdb:propNumber="734" name="Resource" type="xdb:ResourceType" xdb:memType="258"
        xdb:system="false" xdb:mutable="false" xdb:SQLName="RESOURCE"
        xdb:SQLType="XDB$RESOURCE_T" xdb:SQLSchema="XDB" xdb:JavaType="XMLType"
        xdb:global="true" nillable="false" abstract="false" xdb:SQLInline="false"
        xdb:JavaInline="false" xdb:MemInline="false" xdb:maintainDOM="false"
        xdb:defaultTable="XDB$RESOURCE" xdb:defaultTableSchema="XDB"
        xdb:JavaClassname="oracle.xdb.ResourceBean"
        xdb:beanClassname="oracle.xdb.ResourceBean" xdb:numCols="33" minOccurs="1"
        maxOccurs="1"/>
<element xdb:propNumber="775" name="Locks" type="xdb:locksType" xdb:memType="258"
        xdb:system="false" xdb:mutable="true" xdb:JavaType="XMLType" xdb:global="false"
        xdb:hidden="false" nillable="false" abstract="false" xdb:SQLInline="true"
        xdb:JavaInline="false" xdb:MemInline="false" xdb:maintainDOM="false"

```

```

        xdb:defaultTableSchema="XDB" xdb:numCols="1" minOccurs="0" maxOccurs="1"/>
</schema>

```

A.2 XDBResConfig.xsd: XML Schema for Resource Configuration

A full listing is presented of the Oracle XML DB-supplied XML schema used to configure repository resources. It is accessible in Oracle XML DB Repository at path `/sys/schemas/PUBLIC/xmlns.oracle.com/xdb/XDBResConfig.xsd`.

XDBResConfig.xsd

```

<schema xmlns="http://www.w3.org/2001/XMLSchema"
  targetNamespace="http://xmlns.oracle.com/xdb/XDBResConfig.xsd"
  xmlns:xdb="http://xmlns.oracle.com/xdb"
  xmlns:rescfg="http://xmlns.oracle.com/xdb/XDBResConfig.xsd"
  elementFormDefault="qualified" xdb:schemaOwner="XDB" version="1.0">
  <annotation>
    <documentation>
      This XML schema declares the schema of an XDB resource configuration,
      which includes default ACL, event listeners and user configuration.
      It lists all XDB repository events that will be supported.

      Future extension can be added to support user-defined events and
      XML events.
    </documentation>
  </annotation>
  <simpleType name="language">
    <restriction base="string">
      <enumeration value="Java"/>
      <enumeration value="C"/>
      <enumeration value="PL/SQL"/>
    </restriction>
  </simpleType>
  <complexType name="existsNode">
    <all>
      <element name="XPath" type="string" minOccurs="1" maxOccurs="1"/>
      <element name="namespace" type="string" minOccurs="0" maxOccurs="1"/>
    </all>
  </complexType>
  <!-- listener pre-condition element -->
  <complexType name="condition">
    <all>
      <element name="existsNode" type="rescfg:existsNode" minOccurs="0" maxOccurs="1"/>
    </all>
  </complexType>
  <complexType name="events">
    <all>
      <element name="Render" type="string" minOccurs="0" maxOccurs="1"/>
      <element name="Pre-Create" type="string" minOccurs="0" maxOccurs="1"/>
      <element name="Post-Create" type="string" minOccurs="0" maxOccurs="1"/>
      <element name="Pre-Delete" type="string" minOccurs="0" maxOccurs="1"/>
      <element name="Post-Delete" type="string" minOccurs="0" maxOccurs="1"/>
      <element name="Pre-Update" type="string" minOccurs="0" maxOccurs="1"/>
      <element name="Post-Update" type="string" minOccurs="0" maxOccurs="1"/>
      <element name="Pre-Lock" type="string" minOccurs="0" maxOccurs="1"/>
      <element name="Post-Lock" type="string" minOccurs="0" maxOccurs="1"/>
      <element name="Pre-Unlock" type="string" minOccurs="0" maxOccurs="1"/>
      <element name="Post-Unlock" type="string" minOccurs="0" maxOccurs="1"/>
      <element name="Pre-LinkIn" type="string" minOccurs="0" maxOccurs="1"/>
      <element name="Post-LinkIn" type="string" minOccurs="0" maxOccurs="1"/>
    </all>
  </complexType>

```

```

<element name="Pre-LinkTo" type="string" minOccurs="0" maxOccurs="1"/>
<element name="Post-LinkTo" type="string" minOccurs="0" maxOccurs="1"/>
<element name="Pre-UnlinkIn" type="string" minOccurs="0" maxOccurs="1"/>
<element name="Post-UnlinkIn" type="string" minOccurs="0" maxOccurs="1"/>
<element name="Pre-UnlinkFrom" type="string" minOccurs="0" maxOccurs="1"/>
<element name="Post-UnlinkFrom" type="string" minOccurs="0" maxOccurs="1"/>
<element name="Pre-CheckIn" type="string" minOccurs="0" maxOccurs="1"/>
<element name="Post-CheckIn" type="string" minOccurs="0" maxOccurs="1"/>
<element name="Pre-CheckOut" type="string" minOccurs="0" maxOccurs="1"/>
<element name="Post-CheckOut" type="string" minOccurs="0" maxOccurs="1"/>
<element name="Pre-UncheckOut" type="string" minOccurs="0" maxOccurs="1"/>
<element name="Post-UncheckOut" type="string" minOccurs="0" maxOccurs="1"/>
<element name="Pre-VersionControl" type="string" minOccurs="0" maxOccurs="1"/>
<element name="Post-VersionControl" type="string" minOccurs="0" maxOccurs="1"/>
<element name="Pre-Open" type="string" minOccurs="0" maxOccurs="1"/>
<element name="Post-Open" type="string" minOccurs="0" maxOccurs="1"/>
<element name="Pre-InconsistentUpdate" type="string" minOccurs="0" maxOccurs="1"/>
<element name="Post-InconsistentUpdate" type="string" minOccurs="0" maxOccurs="1"/>
</all>
</complexType>
<!-- event listener element -->
<complexType name="event-listener">
  <all>
    <element name="description" type="string" minOccurs="0" maxOccurs="1"/>
    <element name="schema" type="string" minOccurs="0" maxOccurs="1"/>
    <element name="source" type="string" minOccurs="1" maxOccurs="1"/>
    <element name="language" type="rescfg:language" minOccurs="0" maxOccurs="1"/>
    <element name="pre-condition" type="rescfg:condition" minOccurs="0" maxOccurs="1"/>
    <element name="events" type="rescfg:events" minOccurs="0" maxOccurs="1"/>
  </all>
</complexType>
<complexType name="event-listeners">
  <sequence>
    <element name="listener" type="rescfg:event-listener" minOccurs="1" maxOccurs="unbounded"/>
  </sequence>
  <attribute name="default-schema" type="string" xdb:baseProp="true" use="optional"/>
  <attribute name="default-language" type="rescfg:language" xdb:baseProp="true" use="optional"/>
  <attribute name="set-invoker" type="boolean" xdb:baseProp="true" default="false"/>
</complexType>
<complexType name="defaultPath">
  <all>
    <element name="pre-condition" type="rescfg:condition" minOccurs="0" maxOccurs="1"/>
    <element name="path" type="string" minOccurs="0" maxOccurs="1" xdb:transient="generated"/>
    <element name="resolvedpath" type="string" minOccurs="1" maxOccurs="1"
      xdb:baseProp="true" xdb:hidden="true"/>
    <element name="oid" type="hexBinary" minOccurs="1" maxOccurs="1"
      xdb:baseProp="true" xdb:hidden="true"/>
  </all>
</complexType>
<complexType name="defaultACL">
  <sequence>
    <element name="ACL" type="rescfg:defaultPath" minOccurs="1" maxOccurs="unbounded"/>
  </sequence>
</complexType>
<complexType name="defaultConfig">
  <sequence>
    <element name="configuration" type="rescfg:defaultPath"
      minOccurs="1" maxOccurs="unbounded"/>
  </sequence>
</complexType>
<simpleType name="link-type">

```

```
<restriction base="string">
  <enumeration value="None" />
  <enumeration value="Hard" />
  <enumeration value="Weak" />
  <enumeration value="Symbolic" />
</restriction>
</simpleType>
<simpleType name="path-format">
  <restriction base="string">
    <enumeration value="OID" />
    <enumeration value="Named" />
  </restriction>
</simpleType>
<simpleType name="link-metadata">
  <restriction base="string">
    <enumeration value="None" />
    <enumeration value="Attributes" />
    <enumeration value="All" />
  </restriction>
</simpleType>
<simpleType name="unresolved-link">
  <restriction base="string">
    <enumeration value="Error" />
    <enumeration value="SymLink" />
    <enumeration value="Skip" />
  </restriction>
</simpleType>
<simpleType name="conflict-rule">
  <restriction base="string">
    <enumeration value="Error" />
    <enumeration value="Overwrite" />
    <enumeration value="Syspath" />
  </restriction>
</simpleType>
<simpleType name="section-type">
  <restriction base="string">
    <enumeration value="None" />
    <enumeration value="Fragment" />
    <enumeration value="Document" />
  </restriction>
</simpleType>
<!-- XLinkConfig complex type -->
<complexType name="xlink-config">
  <sequence>
    <element name="LinkType" type="rescfg:link-type" />
    <element name="PathFormat" type="rescfg:path-format" minOccurs="0" default="OID" />
    <element name="LinkMetadata" type="rescfg:link-metadata" minOccurs="0" default="None" />
    <element name="pre-condition" type="rescfg:condition" minOccurs="0" maxOccurs="1" />
  </sequence>
  <attribute name="UnresolvedLink" type="rescfg:unresolved-link" default="Error" />
</complexType>
<!-- XIncludeConfig element -->
<complexType name="xinclude-config">
  <sequence>
    <element name="LinkType" type="rescfg:link-type" />
    <element name="PathFormat" type="rescfg:path-format" minOccurs="0" default="OID" />
    <element name="ConflictRule" type="rescfg:conflict-rule" minOccurs="0" default="Error" />
  </sequence>
  <attribute name="UnresolvedLink" type="rescfg:unresolved-link" default="Error" />
</complexType>
<!-- SectionConfig element -->
```



```

<complexType name="section-config">
  <sequence>
    <element name="Section" maxOccurs="unbounded">
      <complexType>
        <sequence>
          <element name="sectionPath" type="string"/>
          <element name="documentPath" type="string" minOccurs="0"/>
          <element name="namespace" type="string" minOccurs="0"/>
        </sequence>
        <attribute name="type" type="rescfg:section-type" default="None"/>
      </complexType>
    </element>
  </sequence>
</complexType>
<!-- ContentFormat element -->
<simpleType name="content-format">
  <restriction base="string">
    <enumeration value="text"/>
    <enumeration value="binary"/>
  </restriction>
</simpleType>
<!-- resource configuration element -->
<complexType name="ResConfig">
  <all>
    <element name="defaultChildConfig" type="rescfg:defaultConfig" minOccurs="0" maxOccurs="1"/>
    <element name="defaultChildACL" type="rescfg:defaultACL" minOccurs="0" maxOccurs="1"/>
    <element name="event-listeners" type="rescfg:event-listeners" minOccurs="0" maxOccurs="1"/>
    <element name="XLinkConfig" type="rescfg:xlink-config" minOccurs="0" maxOccurs="1"/>
    <element name="XIncludeConfig" type="rescfg:xinclude-config" minOccurs="0" maxOccurs="1"/>
    <element name="SectionConfig" type="rescfg:section-config" minOccurs="0" maxOccurs="1"/>
    <element name="ContentFormat" type="rescfg:content-format" minOccurs="0" maxOccurs="1"/>
    <!-- application data -->
    <element name="applicationData" minOccurs="0" maxOccurs="1">
      <complexType>
        <sequence>
          <any namespace="##other" maxOccurs="unbounded" processContents="lax"/>
        </sequence>
      </complexType>
    </element>
  </all>
  <attribute name="enable" type="boolean" xdb:baseProp="true" default="true"/>
  <attribute name="copy-on-inconsistent-update" type="boolean" use="optional"/>
</complexType>
<element name="ResConfig" type="rescfg:ResConfig" xdb:defaultTable="XDB$RESCONFIG"/>
</schema>

```

A.3 acl.xsd: XML Schema for ACLs

The Oracle Database-supplied XML schema used to represent access control lists (ACLs) is presented.

acl.xsd

```

<schema xmlns="http://www.w3.org/2001/XMLSchema"
  targetNamespace="http://xmlns.oracle.com/xdb/acl.xsd" version="1.0"
  xmlns:xdb="http://xmlns.oracle.com/xdb"
  xmlns:xdbacl="http://xmlns.oracle.com/xdb/acl.xsd"
  elementFormDefault="qualified">
  <annotation>
    <documentation>
      This XML schema describes the structure of XDB ACL documents.
    </documentation>
  </annotation>

```

Note : The "systemPrivileges" element below lists all supported system privileges and their aggregations.

See dav.xsd for description of DAV privileges

Note : The elements and attributes marked "hidden" are for internal use only.

```

</documentation>
<appinfo>
  <xdb:systemPrivileges>
    <xdbacl:all>
      <xdbacl:read-properties/>
      <xdbacl:read-contents/>
      <xdbacl:read-acl/>
      <xdbacl:update/>
      <xdbacl:link/>
      <xdbacl:unlink/>
      <xdbacl:unlink-from/>
      <xdbacl:write-acl-ref/>
      <xdbacl:update-acl/>
      <xdbacl:link-to/>
      <xdbacl:resolve/>
      <xdbacl:write-config/>
    </xdbacl:all>
  </xdb:systemPrivileges>
</appinfo>
</annotation>
<!-- privilegeNameType (this is an emptycontent type) -->
<complexType name = "privilegeNameType"/>
<!-- privilegeName element
  All system and user privileges are in the substitutionGroup
  of this element.
-->
<element name = "privilegeName" type="xdbacl:privilegeNameType"
  xdb:defaultTable=""/>
<!-- all system privileges in the XDB ACL namespace -->
<element name = "read-properties" type="xdbacl:privilegeNameType"
  substitutionGroup="xdbacl:privilegeName" xdb:defaultTable=""/>
<element name = "read-contents" type="xdbacl:privilegeNameType"
  substitutionGroup="xdbacl:privilegeName" xdb:defaultTable=""/>
<element name = "read-acl" type="xdbacl:privilegeNameType"
  substitutionGroup="xdbacl:privilegeName" xdb:defaultTable=""/>
<element name = "update" type="xdbacl:privilegeNameType"
  substitutionGroup="xdbacl:privilegeName" xdb:defaultTable=""/>
<element name = "link" type="xdbacl:privilegeNameType"
  substitutionGroup="xdbacl:privilegeName" xdb:defaultTable=""/>
<element name = "unlink" type="xdbacl:privilegeNameType"
  substitutionGroup="xdbacl:privilegeName" xdb:defaultTable=""/>
<element name = "unlink-from" type="xdbacl:privilegeNameType"
  substitutionGroup="xdbacl:privilegeName" xdb:defaultTable=""/>
<element name = "write-acl-ref" type="xdbacl:privilegeNameType"
  substitutionGroup="xdbacl:privilegeName" xdb:defaultTable=""/>
<element name = "update-acl" type="xdbacl:privilegeNameType"
  substitutionGroup="xdbacl:privilegeName" xdb:defaultTable=""/>
<element name = "link-to" type="xdbacl:privilegeNameType"
  substitutionGroup="xdbacl:privilegeName" xdb:defaultTable=""/>
<element name = "resolve" type="xdbacl:privilegeNameType"
  substitutionGroup="xdbacl:privilegeName" xdb:defaultTable=""/>
<element name = "all" type="xdbacl:privilegeNameType"
  substitutionGroup="xdbacl:privilegeName" xdb:defaultTable=""/>
<!-- privilege element -->
<element name = "privilege" xdb:defaultTable="">

```

```

    <complexType>
      <sequence>
        <any maxOccurs="unbounded" processContents="lax" />
      </sequence>
    </complexType>
  </element>
  <!-- ace element -->
  <element name = "ace" xdb:defaultTable="">
    <complexType>
      <sequence>
        <element name = "grant" type = "boolean" />
        <choice>
          <element name="invert" xdb:transient="generated">
            <complexType>
              <sequence>
                <element name="principal" type="string"
                  xdb:transient="generated" />
              </sequence>
            </complexType>
          </element>
          <element name="principal" type="string" xdb:transient="generated" />
        </choice>
        <element ref="xdbacl:privilege" minOccurs="1" />
        <!-- "any" contain all app info for an ACE e.g.reason for creation -->
        <any minOccurs="0" maxOccurs="unbounded" namespace="##other"
          processContents="lax" />
        <!-- HIDDEN ELEMENTS -->
        <choice minOccurs="0">
          <element name = "principalID" type = "hexBinary"
            xdb:baseProp="true" xdb:hidden="true" />
          <element name = "principalString" type = "string"
            xdb:baseProp="true" xdb:hidden="true" />
        </choice>
        <element name = "flags" type = "unsignedInt" minOccurs="0"
          xdb:baseProp="true" xdb:hidden="true" />
      </sequence>
      <attribute name = "collection" type = "boolean"
        xdb:transient="generated" use="optional" />
      <attribute name = "principalFormat"
        xdb:transient="generated" use="optional">
        <simpleType>
          <restriction base="string">
            <enumeration value="ShortName" />
            <enumeration value="DistinguishedName" />
            <enumeration value="GUID" />
            <enumeration value="XSName" />
            <enumeration value="ApplicationName" />
          </restriction>
        </simpleType>
      </attribute>
      <attribute name = "start_date" type = "dateTime" use = "optional" />
      <attribute name = "end_date" type = "dateTime" use = "optional" />
    </complexType>
  </element>
  <!-- acl element -->
  <complexType name="inheritanceType">
    <attribute name="type" type="string" use="required" />
    <attribute name="href" type="string" use="required" />
  </complexType>
  <complexType name="aclType">
    <sequence>

```

```

<element name = "schemaURL" type = "string" minOccurs="0"
  xdb:transient="generated"/>
<element name = "elementName" type = "string" minOccurs="0"
  xdb:transient="generated"/>
<element name = "security-class" type = "QName" minOccurs="0"/>
<choice minOccurs="0">
  <element name="extends-from" type="xdbacl:inheritanceType"/>
  <element name="constrained-with" type="xdbacl:inheritanceType"/>
</choice>
<element ref = "xdbacl:ace" minOccurs="0" maxOccurs = "unbounded"/>
<!-- this "any" contains all application specific info for an ACL,
  e.g., reason for creation -->
<any minOccurs="0" maxOccurs="unbounded" namespace="##other"
  processContents="lax"/>
<!-- HIDDEN ELEMENTS -->
<element name = "schemaOID" type = "hexBinary" minOccurs="0"
  xdb:baseProp="true" xdb:hidden="true"/>
<element name = "elementNum" type = "unsignedInt" minOccurs="0"
  xdb:baseProp="true" xdb:hidden="true"/>
</sequence>
<attribute name = "shared" type = "boolean" default="true"/>
<attribute name = "description" type = "string"/>
</complexType>
<complexType name="rule-based-acl">
  <complexContent>
    <extension base="xdbacl:aclType">
      <sequence>
        <element name = "param" minOccurs="0" maxOccurs="unbounded">
          <complexType>
            <simpleContent>
              <extension base="string">
                <attribute name = "name" type = "string" use = "required"/>
              </extension>
            </simpleContent>
          </complexType>
        </element>
      </sequence>
    </extension>
  </complexContent>
</complexType>
<element name = "acl" type="xdbacl:aclType" xdb:defaultTable = "XDB$ACL"/>
<element name = "write-config" type="xdbacl:privilegeNameType"
  substitutionGroup="xdbacl:privilegeName" xdb:defaultTable="" />
</schema>

```

A.4 xdbconfig.xsd: XML Schema for Configuring Oracle XML DB

A full listing is presented of file `xdbconfig.xsd`, which contains the XML schema used to configure Oracle XML DB.

Note:

The value of attribute `value` of element `pattern` has been split here for documentation purposes. In reality, the value is not split (no newline characters), but is one long string.

xdbcconfig.xsd

```

<schema targetNamespace="http://xmlns.oracle.com/xdb/xdbcconfig.xsd"
  xmlns="http://www.w3.org/2001/XMLSchema"
  xmlns:xdbc="http://xmlns.oracle.com/xdb/xdbcconfig.xsd"
  xmlns:xdb="http://xmlns.oracle.com/xdb"
  version="1.0" elementFormDefault="qualified">
  <element name="xdbcconfig" xdb:defaultTable="XDB$CONFIG">
    <complexType>
      <sequence>

        <!-- predefined XDB properties - these should NOT be changed -->
        <element name="sysconfig">
          <complexType>
            <sequence>

              <!-- generic XDB properties -->
              <element name="acl-max-age" type="unsignedInt" default="15"/>
              <element name="acl-cache-size" type="unsignedInt" default="32"/>
              <element name="invalid-pathname-chars" type="string" default=""/>
              <element name="case-sensitive" type="boolean" default="true"/>
              <element name="call-timeout" type="unsignedInt" default="300"/>
              <element name="max-link-queue" type="unsignedInt" default="65536"/>
              <element name="max-session-use" type="unsignedInt" default="100"/>
              <element name="persistent-sessions" type="boolean" default="false"/>
              <element name="default-lock-timeout" type="unsignedInt"
                default="3600"/>
              <element name="xdbccore-logfile-path" type="string"
                default="/sys/log/xdblog.xml"/>
              <element name="xdbccore-log-level" type="unsignedInt"
                default="0"/>
              <element name="resource-view-cache-size" type="unsignedInt"
                default="1048576"/>
              <element name="case-sensitive-index-clause" type="string"
                minOccurs="0"/>

              <!-- protocol specific properties -->
              <element name="protocolconfig">
                <complexType>
                  <sequence>

                    <!-- these apply to all protocols -->
                    <element name="common">
                      <complexType>
                        <sequence>
                          <element name="extension-mappings">
                            <complexType>
                              <sequence>
                                <element name="mime-mappings"
                                  type="xdbc:mime-mapping-type"/>
                                <element name="lang-mappings"
                                  type="xdbc:lang-mapping-type"/>
                                <element name="charset-mappings"
                                  type="xdbc:charset-mapping-type"/>
                                <element name="encoding-mappings"
                                  type="xdbc:encoding-mapping-type"/>
                                <element name="xml-extensions"
                                  type="xdbc:xml-extension-type"
                                  minOccurs="0"/>
                              </sequence>
                            </complexType>
                          </sequence>
                        </complexType>
                      </sequence>
                    </element>
                  </sequence>
                </complexType>
              </element>
            </sequence>
          </complexType>
        </element>
      </sequence>
    </complexType>
  </element>

```

```

        </element>
        <element name="session-pool-size" type="unsignedInt"
            default="50"/>
        <element name="session-timeout" type="unsignedInt"
            default="6000"/>
    </sequence>
</complexType>
</element>

<!-- FTP specific -->
<element name="ftpconfig">
    <complexType>
        <sequence>
            <element name="ftp-port" type="unsignedShort"
                default="2100"/>
            <element name="ftp-listener" type="string"/>
            <element name="ftp-protocol" type="string"/>
            <element name="logfile-path" type="string"
                default="/sys/log/ftplot.xml"/>
            <element name="log-level" type="unsignedInt"
                default="0"/>
            <element name="session-timeout" type="unsignedInt"
                default="6000"/>
            <element name="buffer-size" default="8192">
                <simpleType>
                    <restriction base="unsignedInt">
                        <minInclusive value="1024"/>      <!-- 1KB -->
                        <maxInclusive value="1048496"/>   <!-- 1MB -->
                    </restriction>
                </simpleType>
            </element>
            <element name="ftp-welcome-message" type="string"
                minOccurs="0" maxOccurs="1"/>
            <element name="host-name" type="string"
                minOccurs="0" maxOccurs="1"/>
        </sequence>
    </complexType>
</element>

<!-- HTTP specific -->
<element name="httpconfig">
    <complexType>
        <sequence>
            <element name="http-port" type="unsignedShort"
                default="8080"/>
            <element name="http-listener" type="string"/>
            <element name="http-protocol" type="string"/>
            <element name="max-http-headers" type="unsignedInt"
                default="64"/>
            <element name="max-header-size" type="unsignedInt"
                default="4096"/>
            <element name="max-request-body" type="unsignedInt"
                default="2000000000" minOccurs="1"/>
            <element name="session-timeout" type="unsignedInt"
                default="6000"/>
            <element name="server-name" type="string"/>
            <element name="logfile-path" type="string"
                default="/sys/log/httplog.xml"/>
            <element name="log-level" type="unsignedInt"
                default="0"/>
            <element name="servlet-realm" type="string"

```

```

        minOccurs="0"/>
<element name="webappconfig">
  <complexType>
    <sequence>
      <element name="welcome-file-list"
        type="xdbc:welcome-file-type"/>
      <element name="error-pages"
        type="xdbc:error-page-type"/>
      <element name="servletconfig"
        type="xdbc:servlet-config-type"/>
    </sequence>
  </complexType>
</element>
<element name="default-url-charset" type="string"
  minOccurs="0"/>
<element name="http2-port" type="unsignedShort"
  minOccurs="0"/>
<element name="http2-protocol" type="string"
  default="tcp" minOccurs="0"/>
<element name="plsql" minOccurs="0">
  <complexType>
    <sequence>
      <element name="log-level"
        type="unsignedInt" minOccurs="0"/>
      <element name="max-parameters"
        type="unsignedInt" minOccurs="0"/>
    </sequence>
  </complexType>
</element>
<element name="allow-repository-anonymous-access"
  minOccurs="0" default="false" type="boolean"/>
<element name="authentication" minOccurs="0"
  maxOccurs="1">
  <complexType>
    <sequence>
      <element name="allow-mechanism" minOccurs="1"
        maxOccurs="unbounded">
        <simpleType>
          <restriction base="string">
            <enumeration value="digest"/>
            <enumeration value="basic" />
            <enumeration value="custom"/>
          </restriction>
        </simpleType>
      </element>
      <element name="digest-auth" minOccurs="0"
        maxOccurs="1">
        <complexType>
          <sequence>
            <element name="nonce-timeout"
              type="unsignedInt"
              minOccurs="1" maxOccurs="1"
              default="300"/>
          </sequence>
        </complexType>
      </element>
    </sequence>
  </complexType>
</element>
<element name="http-host" type="string" minOccurs="0"/>
<element name="http2-host" type="string" minOccurs="0"/>

```

```

<element name="custom-authentication"
  type="xdbc:custom-authentication-type"
  minOccurs="0"/>
<element name="realm" type="string" minOccurs="0"/>
<element name="respond-with-server-info" type="boolean"
  default="true" minOccurs="0"/>
<element name="expire" type="xdbc:expire-type"
  minOccurs="0"/>
<element name="white-list" minOccurs="0">
  <complexType>
    <sequence>
      <element name="white-list-pattern" minOccurs="0"
        maxOccurs="unbounded">
        <simpleType>
          <restriction base="string">
            <pattern value="(/[^\*/]+)*(/[^\*])?"/>
          </restriction>
        </simpleType>
      </element>
    </sequence>
  </complexType>
</element>
<sequence>
  <complexType>
    <sequence>
      <element name="nfsconfig" minOccurs="0">
        <complexType>
          <sequence>
            <element name="nfs-port" type="unsignedShort"
              default="2049"/>
            <element name="nfs-listener" type="string"/>
            <element name="nfs-protocol" type="string"/>
            <element name="logfile-path" type="string"
              default="/sys/log/nfslog.xml"/>
            <element name="log-level" type="unsignedInt"
              default="0"/>
            <element name="nfs-exports"
              type="xdbc:nfs-exports-type"/>
          </sequence>
        </complexType>
      </element>
    </sequence>
  </complexType>
</element>
<element name="schemaLocation-mappings"
  type="xdbc:schemaLocation-mapping-type" minOccurs="0"/>
<element name="xdbccore-xobmem-bound" type="unsignedInt"
  default="1024" minOccurs="0"/>
<element name="xdbccore-loadableunit-size" type="unsignedInt"
  default="16" minOccurs="0"/>
<element name="folder-hard-links" type="boolean" default="false"
  minOccurs="0"/>
<element name="non-folder-hard-links" type="boolean" default="true"
  minOccurs="0"/>
<element name="copy-on-inconsistent-update" type="boolean"
  default="false" minOccurs="0"/>
<element name="rollback-on-sync-error" type="boolean"
  default="false" minOccurs="0"/>
<element name="acl-evaluation-method" default="deny-trumps-grant"
  minOccurs="0">
  <simpleType>

```



```

        <restriction base="string">
            <enumeration value="deny-trumps-grant" />
            <enumeration value="ace-order" />
        </restriction>
    </simpleType>
</element>
<element name="default-workspace" type="string" minOccurs="0" />
<element name="num_job_queue_processes" type="unsignedInt"
    minOccurs="0" />
<element name="allow-authentication-trust" type="boolean"
    default="false" minOccurs="0" />
<element name="custom-authentication-trust"
    type="xdbc:custom-authentication-trust-type"
    minOccurs="0" />
<element name="default-type-mappings" minOccurs="0">
    <simpleType>
        <restriction base="string">
            <enumeration value="pre-11.2" />
            <enumeration value="post-11.2" />
        </restriction>
    </simpleType>
</element>
<element name="localApplicationGroupStore" type="boolean"
    default="true" minOccurs="0" />
</sequence>
</complexType>
</element>

<!-- users can add any properties they want here -->
<element name="userconfig" minOccurs="0">
    <complexType>
        <sequence>
            <any maxOccurs="unbounded" namespace="##other" />
        </sequence>
    </complexType>
</element>
</sequence>
</complexType>
</element>
<complexType name="welcome-file-type">
    <sequence>
        <element name="welcome-file" minOccurs="0" maxOccurs="unbounded">
            <simpleType>
                <restriction base="string">
                    <pattern value="^[^/]*" />
                </restriction>
            </simpleType>
        </element>
    </sequence>
</complexType>

<!-- customized error pages -->
<complexType name="error-page-type">
    <sequence>
        <element name="error-page" minOccurs="0" maxOccurs="unbounded">
            <complexType>
                <sequence>
                    <choice>
                        <element name="error-code">
                            <simpleType>
                                <restriction base="positiveInteger">

```

```

        <minInclusive value="100"/>
        <maxInclusive value="999"/>
    </restriction>
</simpleType>
</element>

<!-- Fully qualified classname of a Java exception type -->
<element name="exception-type" type="string"/>
<element name="OracleError">
    <complexType>
        <sequence>
            <element name="facility" type="string" default="ORA"/>
            <element name="errnum" type="unsignedInt"/>
        </sequence>
    </complexType>
</element>
</choice>
<element name="location" type="anyURI"/>
</sequence>
</complexType>
</element>
</sequence>
</complexType>

<!-- parameter for a servlet: name, value pair and a description -->
<complexType name="param">
    <sequence>
        <element name="param-name" type="string"/>
        <element name="param-value" type="string"/>
        <element name="description" type="string"/>
    </sequence>
</complexType>
<complexType name="servlet-config-type">
    <sequence>
        <element name="servlet-mappings">
            <complexType>
                <sequence>
                    <element name="servlet-mapping" minOccurs="0"
                        maxOccurs="unbounded">
                        <complexType>
                            <sequence>
                                <element name="servlet-pattern" type="string"/>
                                <element name="servlet-name" type="string"/>
                            </sequence>
                        </complexType>
                    </element>
                </sequence>
            </complexType>
        </element>
    </sequence>
</complexType>
</element>
<element name="servlet-list">
    <complexType>
        <sequence>
            <element name="servlet" minOccurs="0" maxOccurs="unbounded">
                <complexType>
                    <sequence>
                        <element name="servlet-name" type="string"/>
                        <element name="servlet-language">
                            <simpleType>
                                <restriction base="string">
                                    <enumeration value="C"/>
                                    <enumeration value="Java"/>
                                </restriction>
                            </simpleType>
                        </element>
                    </sequence>
                </complexType>
            </element>
        </sequence>
    </complexType>
</element>

```

```

        <enumeration value="PL/SQL"/>
    </restriction>
</simpleType>
</element>
<element name="icon" type="string" minOccurs="0"/>
<element name="display-name" type="string"/>
<element name="description" type="string" minOccurs="0"/>
<choice>
    <element name="servlet-class" type="string" minOccurs="0"/>
    <element name="jsp-file" type="string" minOccurs="0"/>
    <element name="plsql" type="xdbc:plsql-servlet-config"
        minOccurs="0"/>
</choice>
<element name="servlet-schema" type="string" minOccurs="0"/>
<element name="init-param" minOccurs="0"
    maxOccurs="unbounded" type="xdbc:param"/>
<element name="load-on-startup" type="string" minOccurs="0"/>
<element name="security-role-ref" minOccurs="0"
    maxOccurs="unbounded">
    <complexType>
        <sequence>
            <element name="description" type="string" minOccurs="0"/>
            <element name="role-name" type="string"/>
            <element name="role-link" type="string"/>
        </sequence>
    </complexType>
</element>
<!-- session-state-cache-param captures all the parameters
    of the session state cache. expiration-timeout is
    specified in centi-seconds. -->
<element name="session-state-cache-param" minOccurs="0">
    <complexType>
        <sequence>
            <element name="cache-size" type="unsignedInt"/>
            <element name="expiration-timeout" type="unsignedInt"/>
        </sequence>
    </complexType>
</element>
</sequence>
</complexType>
</element>
</sequence>
</complexType>
<complexType name="lang-mapping-type">
    <sequence>
        <element name="lang-mapping" minOccurs="0" maxOccurs="unbounded">
            <complexType>
                <sequence>
                    <element name="extension" type="xdbc:extttype"/>
                    <element name="lang" type="string"/>
                </sequence>
            </complexType>
        </element>
    </sequence>
</complexType>
<complexType name="charset-mapping-type">
    <sequence>
        <element name="charset-mapping" minOccurs="0" maxOccurs="unbounded">

```

```
<complexType>
  <sequence>
    <element name="extension" type="xdbc:exttype"/>
    <element name="charset" type="string"/>
  </sequence>
</complexType>
</element>
</sequence>
</complexType>
<complexType name="encoding-mapping-type">
  <sequence>
    <element name="encoding-mapping" minOccurs="0" maxOccurs="unbounded">
      <complexType>
        <sequence>
          <element name="extension" type="xdbc:exttype"/>
          <element name="encoding" type="string"/>
        </sequence>
      </complexType>
    </element>
  </sequence>
</complexType>
<complexType name="mime-mapping-type">
  <sequence>
    <element name="mime-mapping" minOccurs="0" maxOccurs="unbounded">
      <complexType>
        <sequence>
          <element name="extension" type="xdbc:exttype"/>
          <element name="mime-type" type="string"/>
        </sequence>
      </complexType>
    </element>
  </sequence>
</complexType>
<complexType name="xml-extension-type">
  <sequence>
    <element name="extension" type="xdbc:exttype"
      minOccurs="0" maxOccurs="unbounded">
    </element>
  </sequence>
</complexType>
<complexType name="schemaLocation-mapping-type">
  <sequence>
    <element name="schemaLocation-mapping"
      minOccurs="0" maxOccurs="unbounded">
      <complexType>
        <sequence>
          <element name="namespace" type="string"/>
          <element name="element" type="string"/>
          <element name="schemaURL" type="string"/>
        </sequence>
      </complexType>
    </element>
  </sequence>
</complexType>
<complexType name="plsql-servlet-config">
  <sequence>
    <element name="database-username" type="string" minOccurs="0"/>
    <element name="authentication-mode" minOccurs="0">
      <simpleType>
        <restriction base="string">
          <enumeration value="Basic"/>
        </restriction>
      </simpleType>
    </element>
  </sequence>
</complexType>
```

```

        <enumeration value="SingleSignOn"/>
        <enumeration value="GlobalOwa"/>
        <enumeration value="CustomOwa"/>
        <enumeration value="PerPackageOwa"/>
    </restriction>
</simpleType>
</element>
<element name="session-cookie-name" type="string" minOccurs="0"/>
<element name="session-state-management" minOccurs="0">
    <simpleType>
        <restriction base="string">
            <enumeration value="StatelessWithResetPackageState"/>
            <enumeration value="StatelessWithFastResetPackageState"/>
            <enumeration value="StatelessWithPreservePackageState"/>
        </restriction>
    </simpleType>
</element>
<element name="max-requests-per-session" type="unsignedInt" minOccurs="0"/>
<element name="default-page" type="string" minOccurs="0"/>
<element name="document-table-name" type="string" minOccurs="0"/>
<element name="document-path" type="string" minOccurs="0"/>
<element name="document-procedure" type="string" minOccurs="0"/>
<element name="upload-as-long-raw" type="string" minOccurs="0"
    maxOccurs="unbounded"/>
<element name="path-alias" type="string" minOccurs="0"/>
<element name="path-alias-procedure" type="string" minOccurs="0"/>
<element name="exclusion-list" type="string" minOccurs="0"
    maxOccurs="unbounded"/>
<element name="cgi-environment-list" type="string" minOccurs="0"
    maxOccurs="unbounded"/>
<element name="compatibility-mode" type="unsignedInt" minOccurs="0"/>
<element name="nls-language" type="string" minOccurs="0"/>
<element name="fetch-buffer-size" type="unsignedInt" minOccurs="0"/>
<element name="error-style" minOccurs="0">
    <simpleType>
        <restriction base="string">
            <enumeration value="ApacheStyle"/>
            <enumeration value="ModplsqlStyle"/>
            <enumeration value="DebugStyle"/>
        </restriction>
    </simpleType>
</element>
<element name="transfer-mode" minOccurs="0">
    <simpleType>
        <restriction base="string">
            <enumeration value="Char"/>
            <enumeration value="Raw"/>
        </restriction>
    </simpleType>
</element>
<element name="before-procedure" type="string" minOccurs="0"/>
<element name="after-procedure" type="string" minOccurs="0"/>
<element name="bind-bucket-lengths" type="unsignedInt" minOccurs="0"
    maxOccurs="unbounded"/>
<element name="bind-bucket-widths" type="unsignedInt" minOccurs="0"
    maxOccurs="unbounded"/>
<element name="always-describe-procedure" minOccurs="0">
    <simpleType>
        <restriction base="string">
            <enumeration value="On"/>
            <enumeration value="Off"/>
        </restriction>
    </simpleType>

```

```

        </restriction>
    </simpleType>
</element>
<element name="info-logging" minOccurs="0">
    <simpleType>
        <restriction base="string">
            <enumeration value="InfoDebug" />
        </restriction>
    </simpleType>
</element>
<element name="owa-debug-enable" minOccurs="0">
    <simpleType>
        <restriction base="string">
            <enumeration value="On" />
            <enumeration value="Off" />
        </restriction>
    </simpleType>
</element>
<element name="request-validation-function" type="string" minOccurs="0"/>
<element name="input-filter-enable" minOccurs="0">
    <simpleType>
        <restriction base="string">
            <enumeration value="On" />
            <enumeration value="Off" />
            <enumeration value="SecurityOn" />
            <enumeration value="SecurityOff" />
        </restriction>
    </simpleType>
</element>
<element name="database-edition" type="string" minOccurs="0"/>
</sequence>
</complexType>
<simpleType name="extttype">
    <restriction base="string">
        <pattern value="[^*\.\.]*" />
    </restriction>
</simpleType>
<simpleType name="ipaddress">
    <restriction base="string">
        <maxLength value="40" />
    </restriction>
</simpleType>
<complexType name="nfs-exports-type">
    <sequence>
        <element name="nfs-export" minOccurs="1" maxOccurs="unbounded">
            <complexType>
                <sequence>
                    <element name="nfs-clientgroup">
                        <complexType>
                            <sequence>
                                <element name="nfs-client" minOccurs="1" maxOccurs="unbounded">
                                    <complexType>
                                        <sequence>
                                            <choice>
                                                <element name="nfs-client-subnet"
                                                    type="xdb:ipaddress" />
                                                <element name="nfs-client-dnsname" type="string" />
                                                <element name="nfs-client-address"
                                                    type="xdb:ipaddress" />
                                            </choice>
                                        </sequence>
                                    </complexType>
                                </element>
                            </sequence>
                        </complexType>
                    </element>
                </sequence>
            </complexType>
        </element>
    </sequence>
</complexType>

```

```

        type="xdbc:ipaddress"/>
    </sequence>
</complexType>
</element>
</sequence>
</complexType>
</element>
<element name="nfs-export-paths">
    <complexType>
        <sequence>
            <element name="nfs-export-path" minOccurs="1"
                maxOccurs="unbounded">
                <complexType>
                    <sequence>
                        <element name="path" type="string"/>
                        <element name="mode">
                            <simpleType>
                                <restriction base="string">
                                    <enumeration value="read-write"/>
                                    <enumeration value="read-only"/>
                                </restriction>
                            </simpleType>
                        </element>
                    </sequence>
                </complexType>
            </element>
        </sequence>
    </complexType>
</element>
</sequence>
</complexType>
</element>
</sequence>
</complexType>
<complexType name="custom-authentication-type">
    <sequence>
        <element name="custom-authentication-mappings">
            <complexType>
                <sequence>
                    <element name="custom-authentication-mapping" minOccurs="0"
                        maxOccurs="unbounded">
                        <complexType>
                            <sequence>
                                <element name="authentication-pattern" type="string"/>
                                <element name="authentication-name" type="string"/>
                                <element name="authentication-trust-name" type="string"
                                    minOccurs="0"/>
                                <element name="user-prefix" type="string" minOccurs="0"/>
                                <element name="on-deny" minOccurs="0">
                                    <simpleType><restriction base="string">
                                        <enumeration value="next-custom"/>
                                        <enumeration value="basic"/>
                                    </restriction></simpleType>
                                </element>
                            </sequence>
                        </complexType>
                    </element>
                </sequence>
            </complexType>
        </element>
    </sequence>
</complexType>
</element>
<element name="custom-authentication-list">

```

```

<complexType>
  <sequence>
    <element name="authentication" minOccurs="0" maxOccurs="unbounded">
      <complexType>
        <sequence>
          <element name="authentication-name" type="string"/>
          <element name="authentication-description" type="string"
            minOccurs="0"/>
          <element name="authentication-implement-schema" type="string"/>
          <element name="authentication-implement-method" type="string"/>
          <element name="authentication-implement-language">
            <simpleType>
              <restriction base="string">
                <enumeration value="PL/SQL"/>
              </restriction>
            </simpleType>
          </element>
        </sequence>
      </complexType>
    </element>
  </sequence>
</complexType>
<complexType name="custom-authentication-trust">
  <sequence>
    <element name="custom-authentication-trust"
      type="xdbc:custom-authentication-trust-type" minOccurs="0"/>
  </sequence>
</complexType>
<complexType name="custom-authentication-trust-type">
  <sequence>
    <element name="trust-scheme" minOccurs="0" maxOccurs="unbounded">
      <complexType>
        <sequence>
          <element name="trust-scheme-name" type="string"/>
          <element name="requireParsingSchema" type="boolean" default="true"
            minOccurs="0"/>
          <element name="allowRegistration" type="boolean" default="true"
            minOccurs="0"/>
          <element name="trust-scheme-description" type="string" minOccurs="0"/>
          <element name="trusted-session-user" type="string" minOccurs="1"
            maxOccurs="unbounded"/>
          <element name="trusted-parsing-schema" type="string" minOccurs="0"
            maxOccurs="unbounded"/>
        </sequence>
      </complexType>
    </element>
  </sequence>
</complexType>
<complexType name="expire-type">
  <sequence>
    <element name="expire-mapping" minOccurs="0" maxOccurs="unbounded">
      <complexType>
        <sequence>
          <element name="expire-pattern" type="string"/>
          <element name="expire-default">
            <simpleType>
              <restriction base="string">
                <pattern value=
" (now|modification)(\s(plus))?( \s(([1]\s(year))|
([0-9]*\s(years)))?( \s(([1]\s(month))|([0-9]*\s(months)))?( \s(([1]\s(week))|
([0-9]*\s(weeks)))?( \s(([1]\s(day))|([0-9]*\s(days)))?( \s(([1]\s(hour))|
([0-9]*\s(hours)))?( \s(([1]\s(minute))|

```



```

([0-9]*\s(minutes)))?(\s(((1)\s(second))|([0-9]*\s(seconds))))?"/>1
    </restriction>
  </simpleType>
</element>
</sequence>
</complexType>
</element>
</sequence>
</complexType>
</schema>

```

A.5 xdiff.xsd: XML Schema for Comparing Schemas for In-Place Evolution

A full listing is presented of `xdiff.xsd`, the Oracle XML DB-supplied XML schema to which the document specified as the `diffXML` parameter to procedure `DBMS_XMLSCHEMA.inPlaceEvolve` must conform.

xdiff.xsd

```

<schema targetNamespace="http://xmlns.oracle.com/xdb/xdiff.xsd"
  xmlns="http://www.w3.org/2001/XMLSchema"
  xmlns:xd="http://xmlns.oracle.com/xdb/xdiff.xsd"
  version="1.0" elementFormDefault="qualified"
  attributeFormDefault="qualified">
  <annotation>

```

```

    <documentation xml:lang="en">
      Defines the structure of XML documents that capture the difference
      between two XML documents. Changes that are not supported by Oracle
      XmlDiff may not be expressible in this schema.
    </documentation>

```

'oracle-xmldiff' PI:

We use 'oracle-xmldiff' PI to describe certain aspects of the diff. This should be the first element of top level xdiff element.

operations-in-docorder:

Can be either 'true' or 'false'.
If true, the operations in the diff document refer to the elements of the input doc in the same order as document order. Output of global algorithm meets this requirement while local does not.

output-model: output models for representing the diff. Can be either 'Snapshot' or 'Current'.

Snapshot model:

Each operation uses Xpaths as if no operations have been applied to the input document. (like UNIX diff) Default and works for both XmlDiff and XmlPatch. For XmlPatch to handle this model, "operations-in-docorder" must be true and the Xpaths must be simple. (see XmlDif C API documentation).

Current model :

Each operation uses Xpaths as if all operations till the previous one have been applied to the input document. Not implemented for XmlDiff. Works with XmlPatch.

<!-- Example:

¹ The value of attribute `value` has been split here for documentation purposes. In reality, the value is one long string, with no line breaks.

```

        <?oracle-xmldiff operations-in-docorder="true" output-model=
            "snapshot" diff-algorithm="global"?>
    -->
    </documentation>
</annotation>
<!-- Enumerate the supported node types -->
<simpleType name="xdiff-nodetype">
    <restriction base="string">
        <enumeration value="element"/>
        <enumeration value="attribute"/>
        <enumeration value="text"/>
        <enumeration value="cdata"/>
        <enumeration value="entity-reference"/>
        <enumeration value="entity"/>
        <enumeration value="processing-instruction"/>
        <enumeration value="notation"/>
        <enumeration value="comment"/>
    </restriction>
</simpleType>

<element name="xdiff">
    <complexType>
        <choice minOccurs="0" maxOccurs="unbounded">
            <element name="append-node">
                <complexType>
                    <sequence>
                        <element name="content" type="anyType"/>
                    </sequence>
                    <attribute name="node-type" type="xd:xdiff-nodetype"/>
                    <attribute name="xpath" type="string"/>
                    <attribute name="parent-xpath" type="string"/>
                    <attribute name="attr-local" type="string"/>
                    <attribute name="attr-uri" type="string"/>
                </complexType>
            </element>

            <element name="insert-node-before">
                <complexType>
                    <sequence>
                        <element name="content" type="anyType"/>
                    </sequence>
                    <attribute name="xpath" type="string"/>
                    <attribute name="node-type" type="xd:xdiff-nodetype"/>
                </complexType>
            </element>

            <element name="delete-node">
                <complexType>
                    <attribute name="node-type" type="xd:xdiff-nodetype"/>
                    <attribute name="xpath" type="string"/>
                    <attribute name="parent-xpath" type="string"/>
                    <attribute name="attr-local" type="string"/>
                    <attribute name="attr-uri" type="string"/>
                </complexType>
            </element>

            <element name="update-node">
                <complexType>
                    <sequence>
                        <element name="content" type="anyType"/>
                    </sequence>
                </complexType>
            </element>
        </choice>
    </complexType>
</element>

```

```

        <attribute name="node-type" type="xd:xdiff-nodetype"/>
        <attribute name="parent-xpath" type="string"/>
        <attribute name="xpath" type="string"/>
        <attribute name="attr-local" type="string"/>
        <attribute name="attr-uri" type="string"/>
    </complexType>
</element>
<element name="rename-node">
    <complexType>
        <sequence>
            <element name="content" type="anyType"/>
        </sequence>
        <attribute name="xpath" type="string"/>
        <attribute name="node-type" type="xd:xdiff-nodetype"/>
    </complexType>
</element>
</choice>
    <attribute name="xdiff-version" type="string"/>
</complexType>
</element>
</schema>

```

A.6 Purchase-Order XML Schemas

The full listings of purchase-order XML schemas that are used in various examples are presented.

[Example A-1](#) (page A-31) shows an unannotated purchase-order XML schema.

Example A-1 Unannotated Purchase-Order XML Schema

```

<xs:schema xmlns:xs="http://www.w3.org/2001/XMLSchema" version="1.0">
  <xs:element name="PurchaseOrder" type="PurchaseOrderType"/>
  <xs:complexType name="PurchaseOrderType">
    <xs:sequence>
      <xs:element name="Reference" type="ReferenceType"/>
      <xs:element name="Actions" type="ActionsType"/>
      <xs:element name="Reject" type="RejectionType" minOccurs="0"/>
      <xs:element name="Requestor" type="RequestorType"/>
      <xs:element name="User" type="UserType"/>
      <xs:element name="CostCenter" type="CostCenterType"/>
      <xs:element name="ShippingInstructions" type="ShippingInstructionsType"/>
      <xs:element name="SpecialInstructions" type="SpecialInstructionsType"/>
      <xs:element name="LineItems" type="LineItemsType"/>
    </xs:sequence>
  </xs:complexType>
  <xs:complexType name="LineItemsType">
    <xs:sequence>
      <xs:element name="LineItem" type="LineItemType" maxOccurs="unbounded"/>
    </xs:sequence>
  </xs:complexType>
  <xs:complexType name="LineItemType">
    <xs:sequence>
      <xs:element name="Description" type="DescriptionType"/>
      <xs:element name="Part" type="PartType"/>
    </xs:sequence>
    <xs:attribute name="ItemNumber" type="xs:integer"/>
  </xs:complexType>
  <xs:complexType name="PartType">
    <xs:attribute name="Id">
      <xs:simpleType>
        <xs:restriction base="xs:string">

```

```
        <xs:minLength value="10"/>
        <xs:maxLength value="14"/>
    </xs:restriction>
</xs:simpleType>
</xs:attribute>
<xs:attribute name="Quantity" type="moneyType"/>
<xs:attribute name="UnitPrice" type="quantityType"/>
</xs:complexType>
<xs:simpleType name="ReferenceType">
    <xs:restriction base="xs:string">
        <xs:minLength value="18"/>
        <xs:maxLength value="30"/>
    </xs:restriction>
</xs:simpleType>
<xs:complexType name="ActionsType">
    <xs:sequence>
        <xs:element name="Action" maxOccurs="4">
            <xs:complexType>
                <xs:sequence>
                    <xs:element name="User" type="UserType"/>
                    <xs:element name="Date" type="DateType" minOccurs="0"/>
                </xs:sequence>
            </xs:complexType>
        </xs:element>
    </xs:sequence>
</xs:complexType>
<xs:complexType name="RejectionType">
    <xs:all>
        <xs:element name="User" type="UserType" minOccurs="0"/>
        <xs:element name="Date" type="DateType" minOccurs="0"/>
        <xs:element name="Comments" type="CommentsType" minOccurs="0"/>
    </xs:all>
</xs:complexType>
<xs:complexType name="ShippingInstructionsType">
    <xs:sequence>
        <xs:element name="name" type="NameType" minOccurs="0"/>
        <xs:element name="address" type="AddressType" minOccurs="0"/>
        <xs:element name="telephone" type="TelephoneType" minOccurs="0"/>
    </xs:sequence>
</xs:complexType>
<xs:simpleType name="moneyType">
    <xs:restriction base="xs:decimal">
        <xs:fractionDigits value="2"/>
        <xs:totalDigits value="12"/>
    </xs:restriction>
</xs:simpleType>
<xs:simpleType name="quantityType">
    <xs:restriction base="xs:decimal">
        <xs:fractionDigits value="4"/>
        <xs:totalDigits value="8"/>
    </xs:restriction>
</xs:simpleType>
<xs:simpleType name="UserType">
    <xs:restriction base="xs:string">
        <xs:minLength value="0"/>
        <xs:maxLength value="10"/>
    </xs:restriction>
</xs:simpleType>
<xs:simpleType name="RequestorType">
    <xs:restriction base="xs:string">
        <xs:minLength value="0"/>
    </xs:restriction>
</xs:simpleType>
```

```

        <xs:maxLength value="128"/>
    </xs:restriction>
</xs:simpleType>
<xs:simpleType name="CostCenterType">
    <xs:restriction base="xs:string">
        <xs:minLength value="1"/>
        <xs:maxLength value="4"/>
    </xs:restriction>
</xs:simpleType>
<xs:simpleType name="VendorType">
    <xs:restriction base="xs:string">
        <xs:minLength value="0"/>
        <xs:maxLength value="20"/>
    </xs:restriction>
</xs:simpleType>
<xs:simpleType name="PurchaseOrderNumberType">
    <xs:restriction base="xs:integer"/>
</xs:simpleType>
<xs:simpleType name="SpecialInstructionsType">
    <xs:restriction base="xs:string">
        <xs:minLength value="0"/>
        <xs:maxLength value="2048"/>
    </xs:restriction>
</xs:simpleType>
<xs:simpleType name="NameType">
    <xs:restriction base="xs:string">
        <xs:minLength value="1"/>
        <xs:maxLength value="20"/>
    </xs:restriction>
</xs:simpleType>
<xs:simpleType name="AddressType">
    <xs:restriction base="xs:string">
        <xs:minLength value="1"/>
        <xs:maxLength value="256"/>
    </xs:restriction>
</xs:simpleType>
<xs:simpleType name="TelephoneType">
    <xs:restriction base="xs:string">
        <xs:minLength value="1"/>
        <xs:maxLength value="24"/>
    </xs:restriction>
</xs:simpleType>
<xs:simpleType name="DateType">
    <xs:restriction base="xs:date"/>
</xs:simpleType>
<xs:simpleType name="CommentsType">
    <xs:restriction base="xs:string">
        <xs:minLength value="1"/>
        <xs:maxLength value="2048"/>
    </xs:restriction>
</xs:simpleType>
<xs:simpleType name="DescriptionType">
    <xs:restriction base="xs:string">
        <xs:minLength value="1"/>
        <xs:maxLength value="256"/>
    </xs:restriction>
</xs:simpleType>
</xs:schema>

```

[Example A-3](#) (page A-36) represents a modified version of [Example A-2](#) (page A-34). The modification is used in [XML Schema Evolution](#) (page 20-1) to illustrate XML

schema evolution. [Example A-2](#) (page A-34) is the complete listing of the annotated XML schema used in examples of [XML Schema Storage and Query: Basic](#) (page 17-1).

Example A-2 Annotated Purchase-Order XML Schema

```

<xs:schema xmlns:xs="http://www.w3.org/2001/XMLSchema"
  xmlns:xdb="http://xmlns.oracle.com/xdb"
  version="1.0"
  xdb:storeVarrayAsTable="true">
  <xs:element name="PurchaseOrder" type="PurchaseOrderType" xdb:defaultTable="PURCHASEORDER"/>
  <xs:complexType name="PurchaseOrderType" xdb:SQLType="PURCHASEORDER_T">
    <xs:sequence>
      <xs:element name="Reference" type="ReferenceType" minOccurs="1" xdb:SQLName="REFERENCE"/>
      <xs:element name="Actions" type="ActionsType" xdb:SQLName="ACTIONS"/>
      <xs:element name="Reject" type="RejectionType" minOccurs="0" xdb:SQLName="REJECTION"/>
      <xs:element name="Requestor" type="RequestorType" xdb:SQLName="REQUESTOR"/>
      <xs:element name="User" type="UserType" minOccurs="1" xdb:SQLName="USERID"/>
      <xs:element name="CostCenter" type="CostCenterType" xdb:SQLName="COST_CENTER"/>
      <xs:element name="ShippingInstructions" type="ShippingInstructionsType"
        xdb:SQLName="SHIPPING_INSTRUCTIONS"/>
      <xs:element name="SpecialInstructions" type="SpecialInstructionsType"
        xdb:SQLName="SPECIAL_INSTRUCTIONS"/>
      <xs:element name="LineItems" type="LineItemsType" xdb:SQLName="LINEITEMS"/>
    </xs:sequence>
  </xs:complexType>
  <xs:complexType name="LineItemsType" xdb:SQLType="LINEITEMS_T">
    <xs:sequence>
      <xs:element name="LineItem" type="LineItemType" maxOccurs="unbounded"
        xdb:SQLName="LINEITEM" xdb:SQLCollType="LINEITEM_V"/>
    </xs:sequence>
  </xs:complexType>
  <xs:complexType name="LineItemType" xdb:SQLType="LINEITEM_T">
    <xs:sequence>
      <xs:element name="Description" type="DescriptionType"
        xdb:SQLName="DESCRIPTION"/>
      <xs:element name="Part" type="PartType" xdb:SQLName="PART"/>
    </xs:sequence>
    <xs:attribute name="ItemNumber" type="xs:integer" xdb:SQLName="ITEMNUMBER"
      xdb:SQLType="NUMBER"/>
  </xs:complexType>
  <xs:complexType name="PartType" xdb:SQLType="PART_T">
    <xs:attribute name="Id" xdb:SQLName="PART_NUMBER" xdb:SQLType="VARCHAR2">
      <xs:simpleType>
        <xs:restriction base="xs:string">
          <xs:minLength value="10"/>
          <xs:maxLength value="14"/>
        </xs:restriction>
      </xs:simpleType>
    </xs:attribute>
    <xs:attribute name="Quantity" type="moneyType" xdb:SQLName="QUANTITY"/>
    <xs:attribute name="UnitPrice" type="quantityType" xdb:SQLName="UNITPRICE"/>
  </xs:complexType>
  <xs:simpleType name="ReferenceType">
    <xs:restriction base="xs:string">
      <xs:minLength value="18"/>
      <xs:maxLength value="30"/>
    </xs:restriction>
  </xs:simpleType>
  <xs:complexType name="ActionsType" xdb:SQLType="ACTIONS_T">
    <xs:sequence>
      <xs:element name="Action" maxOccurs="4" xdb:SQLName="ACTION" xdb:SQLCollType="ACTION_V">
        <xs:complexType xdb:SQLType="action_t">
          <xs:sequence>
            <xs:element name="User" type="UserType" xdb:SQLName="ACTIONED_BY"/>
            <xs:element name="Date" type="DateType" minOccurs="0" xdb:SQLName="DATE_ACTIONED"/>
          </xs:sequence>
        </xs:complexType>
      </xs:element>
    </xs:sequence>
  </xs:complexType>

```

```

</xs:complexType>
<xs:complexType name="RejectionType" xdb:SQLType="REJECTION_T">
  <xs:all>
    <xs:element name="User" type="UserType" minOccurs="0" xdb:SQLName="REJECTED_BY"/>
    <xs:element name="Date" type="DateType" minOccurs="0" xdb:SQLName="DATE_REJECTED"/>
    <xs:element name="Comments" type="CommentsType" minOccurs="0" xdb:SQLName="REASON_REJECTED"/>
  </xs:all>
</xs:complexType>
<xs:complexType name="ShippingInstructionsType" xdb:SQLType="SHIPPING_INSTRUCTIONS_T">
  <xs:sequence>
    <xs:element name="name" type="NameType" minOccurs="0" xdb:SQLName="SHIP_TO_NAME"/>
    <xs:element name="address" type="AddressType" minOccurs="0" xdb:SQLName="SHIP_TO_ADDRESS"/>
    <xs:element name="telephone" type="TelephoneType" minOccurs="0" xdb:SQLName="SHIP_TO_PHONE"/>
  </xs:sequence>
</xs:complexType>
<xs:simpleType name="moneyType">
  <xs:restriction base="xs:decimal">
    <xs:fractionDigits value="2"/>
    <xs:totalDigits value="12"/>
  </xs:restriction>
</xs:simpleType>
<xs:simpleType name="quantityType">
  <xs:restriction base="xs:decimal">
    <xs:fractionDigits value="4"/>
    <xs:totalDigits value="8"/>
  </xs:restriction>
</xs:simpleType>
<xs:simpleType name="UserType">
  <xs:restriction base="xs:string">
    <xs:minLength value="0"/>
    <xs:maxLength value="10"/>
  </xs:restriction>
</xs:simpleType>
<xs:simpleType name="RequestorType">
  <xs:restriction base="xs:string">
    <xs:minLength value="0"/>
    <xs:maxLength value="128"/>
  </xs:restriction>
</xs:simpleType>
<xs:simpleType name="CostCenterType">
  <xs:restriction base="xs:string">
    <xs:minLength value="1"/>
    <xs:maxLength value="4"/>
  </xs:restriction>
</xs:simpleType>
<xs:simpleType name="VendorType">
  <xs:restriction base="xs:string">
    <xs:minLength value="0"/>
    <xs:maxLength value="20"/>
  </xs:restriction>
</xs:simpleType>
<xs:simpleType name="PurchaseOrderNumberType">
  <xs:restriction base="xs:integer"/>
</xs:simpleType>
<xs:simpleType name="SpecialInstructionsType">
  <xs:restriction base="xs:string">
    <xs:minLength value="0"/>
    <xs:maxLength value="2048"/>
  </xs:restriction>
</xs:simpleType>
<xs:simpleType name="NameType">
  <xs:restriction base="xs:string">
    <xs:minLength value="1"/>
    <xs:maxLength value="20"/>
  </xs:restriction>
</xs:simpleType>
<xs:simpleType name="AddressType">
  <xs:restriction base="xs:string">
    <xs:minLength value="1"/>

```

```

        <xs:maxLength value="256" />
    </xs:restriction>
</xs:simpleType>
<xs:simpleType name="TelephoneType">
    <xs:restriction base="xs:string">
        <xs:minLength value="1" />
        <xs:maxLength value="24" />
    </xs:restriction>
</xs:simpleType>
<xs:simpleType name="DateType">
    <xs:restriction base="xs:date" />
</xs:simpleType>
<xs:simpleType name="CommentsType">
    <xs:restriction base="xs:string">
        <xs:minLength value="1" />
        <xs:maxLength value="2048" />
    </xs:restriction>
</xs:simpleType>
<xs:simpleType name="DescriptionType">
    <xs:restriction base="xs:string">
        <xs:minLength value="1" />
        <xs:maxLength value="256" />
    </xs:restriction>
</xs:simpleType>
</xs:schema>

```

[Example A-3](#) (page A-36) is the complete listing of the revised annotated XML schema presented in [Example 20-1](#) (page 20-2). Text that is in **bold face** is additional or significantly different from that in the schema of [Example A-2](#) (page A-34).

Example A-3 Revised Annotated Purchase-Order XML Schema

```

<xs:schema xmlns:xs="http://www.w3.org/2001/XMLSchema"
           xmlns:xdb="http://xmlns.oracle.com/xdb"
           version="1.0">
  <xs:element
    name="PurchaseOrder" type="PurchaseOrderType"
    xdb:defaultTable="PURCHASEORDER"
    xdb:columnProps=
      "CONSTRAINT purchaseorder_pkey PRIMARY KEY (XMLDATA.reference),
      CONSTRAINT valid_email_address FOREIGN KEY (XMLDATA.userid)
      REFERENCES hr.employees (EMAIL)"
    xdb:tableProps=
      "VARRAY XMLDATA.ACTIONS.ACTION STORE AS TABLE ACTION_TABLE
      ((CONSTRAINT action_pkey PRIMARY KEY (NESTED_TABLE_ID, SYS_NC_ARRAY_INDEX$)))
      VARRAY XMLDATA.LINEITEMS.LINEITEM STORE AS TABLE LINEITEM_TABLE
      ((constraint LINEITEM_PKEY primary key (NESTED_TABLE_ID, SYS_NC_ARRAY_INDEX$)))
      lob (XMLDATA.NOTES) STORE AS (ENABLE STORAGE IN ROW STORAGE(INITIAL 4K NEXT 32K))"/>
  <xs:complexType name="PurchaseOrderType" xdb:SQLType="PURCHASEORDER_T">
    <xs:sequence>
      <xs:element name="Actions" type="ActionsType" xdb:SQLName="ACTIONS"/>
      <xs:element name="Reject" type="RejectionType" minOccurs="0" xdb:SQLName="REJECTION"/>
      <xs:element name="Requestor" type="RequestorType" xdb:SQLName="REQUESTOR"/>
      <xs:element name="User" type="UserType" xdb:SQLName="USERID"/>
      <xs:element name="CostCenter" type="CostCenterType" xdb:SQLName="COST_CENTER"/>
      <xs:element name="BillingAddress" type="AddressType" minOccurs="0"
        xdb:SQLName="BILLING_ADDRESS"/>
      <xs:element name="ShippingInstructions" type="ShippingInstructionsType"
        xdb:SQLName="SHIPPING_INSTRUCTIONS"/>
      <xs:element name="SpecialInstructions" type="SpecialInstructionsType"
        xdb:SQLName="SPECIAL_INSTRUCTIONS"/>
      <xs:element name="LineItems" type="LineItemsType" xdb:SQLName="LINEITEMS"/>
      <xs:element name="Notes" type="NotesType" minOccurs="0" xdb:SQLType="CLOB"
        xdb:SQLName="NOTES"/>
    </xs:sequence>
    <xs:attribute name="Reference" type="ReferenceType" use="required" xdb:SQLName="REFERENCE"/>
    <xs:attribute name="DateCreated" type="xs:dateTime" use="required"
      xdb:SQLType="TIMESTAMP WITH TIME ZONE"/>
  </xs:complexType>

```



```

<xs:complexType name="LineItemsType" xdb:SQLType="LINEITEMS_T">
  <xs:sequence>
    <xs:element name="LineItem" type="LineItemType" maxOccurs="unbounded" xdb:SQLName="LINEITEM"
      xdb:SQLCollType="LINEITEM_V"/>
  </xs:sequence>
</xs:complexType>
<xs:complexType name="LineItemType" xdb:SQLType="LINEITEM_T">
  <xs:sequence>
    <xs:element name="Part" type="PartType" xdb:SQLName="PART"/>
    <xs:element name="Quantity" type="quantityType"/>
  </xs:sequence>
  <xs:attribute name="ItemNumber" type="xs:integer" xdb:SQLName="ITEMNUMBER"
    xdb:SQLType="NUMBER"/>
</xs:complexType>
<xs:complexType name="PartType" xdb:SQLType="PART_T">
  <xs:simpleContent>
    <xs:extension base="UPCCodeType">
      <xs:attribute name="Description" type="DescriptionType" use="required"
        xdb:SQLName="DESCRIPTION"/>
      <xs:attribute name="UnitCost" type="moneyType" use="required"/>
    </xs:extension>
  </xs:simpleContent>
</xs:complexType>
<xs:simpleType name="ReferenceType">
  <xs:restriction base="xs:string">
    <xs:minLength value="18"/>
    <xs:maxLength value="30"/>
  </xs:restriction>
</xs:simpleType>
<xs:complexType name="ActionsType" xdb:SQLType="ACTIONS_T">
  <xs:sequence>
    <xs:element name="Action" maxOccurs="4" xdb:SQLName="ACTION" xdb:SQLCollType="ACTION_V">
      <xs:complexType xdb:SQLType="ACTION_T">
        <xs:sequence>
          <xs:element name="User" type="UserType" xdb:SQLName="ACTIONED_BY"/>
          <xs:element name="Date" type="DateType" minOccurs="0" xdb:SQLName="DATE_ACTIONED"/>
        </xs:sequence>
      </xs:complexType>
    </xs:element>
  </xs:sequence>
</xs:complexType>
<xs:complexType name="RejectionType" xdb:SQLType="REJECTION_T">
  <xs:all>
    <xs:element name="User" type="UserType" minOccurs="0" xdb:SQLName="REJECTED_BY"/>
    <xs:element name="Date" type="DateType" minOccurs="0" xdb:SQLName="DATE_REJECTED"/>
    <xs:element name="Comments" type="CommentsType" minOccurs="0" xdb:SQLName="REASON_REJECTED"/>
  </xs:all>
</xs:complexType>
<xs:complexType name="ShippingInstructionsType" xdb:SQLType="SHIPPING_INSTRUCTIONS_T">
  <xs:sequence>
    <xs:element name="name" type="NameType" minOccurs="0" xdb:SQLName="SHIP_TO_NAME"/>
    <xs:choice>
      <xs:element name="address" type="AddressType" minOccurs="0"/>
      <xs:element name="fullAddress" type="FullAddressType" minOccurs="0"
        xdb:SQLName="SHIP_TO_ADDRESS"/>
    </xs:choice>
    <xs:element name="telephone" type="TelephoneType" minOccurs="0" xdb:SQLName="SHIP_TO_PHONE"/>
  </xs:sequence>
</xs:complexType>
<xs:simpleType name="moneyType">
  <xs:restriction base="xs:decimal">
    <xs:fractionDigits value="2"/>
    <xs:totalDigits value="12"/>
  </xs:restriction>
</xs:simpleType>
<xs:simpleType name="quantityType">
  <xs:restriction base="xs:decimal">
    <xs:fractionDigits value="4"/>
    <xs:totalDigits value="8"/>
  </xs:restriction>
</xs:simpleType>

```

```
</xs:restriction>
</xs:simpleType>
<xs:simpleType name="UserType">
  <xs:restriction base="xs:string">
    <xs:minLength value="0" />
    <xs:maxLength value="10" />
  </xs:restriction>
</xs:simpleType>
<xs:simpleType name="RequestorType">
  <xs:restriction base="xs:string">
    <xs:minLength value="0" />
    <xs:maxLength value="128" />
  </xs:restriction>
</xs:simpleType>
<xs:simpleType name="CostCenterType">
  <xs:restriction base="xs:string">
    <xs:minLength value="1" />
    <xs:maxLength value="4" />
  </xs:restriction>
</xs:simpleType>
<xs:simpleType name="VendorType">
  <xs:restriction base="xs:string">
    <xs:minLength value="0" />
    <xs:maxLength value="20" />
  </xs:restriction>
</xs:simpleType>
<xs:simpleType name="PurchaseOrderNumberType">
  <xs:restriction base="xs:integer" />
</xs:simpleType>
<xs:simpleType name="SpecialInstructionsType">
  <xs:restriction base="xs:string">
    <xs:minLength value="0" />
    <xs:maxLength value="2048" />
  </xs:restriction>
</xs:simpleType>
<xs:simpleType name="NameType">
  <xs:restriction base="xs:string">
    <xs:minLength value="1" />
    <xs:maxLength value="20" />
  </xs:restriction>
</xs:simpleType>
<xs:simpleType name="FullAddressType">
  <xs:restriction base="xs:string">
    <xs:minLength value="1" />
    <xs:maxLength value="256" />
  </xs:restriction>
</xs:simpleType>
<xs:simpleType name="TelephoneType">
  <xs:restriction base="xs:string">
    <xs:minLength value="1" />
    <xs:maxLength value="24" />
  </xs:restriction>
</xs:simpleType>
<xs:simpleType name="DateType">
  <xs:restriction base="xs:date" />
</xs:simpleType>
<xs:simpleType name="CommentsType">
  <xs:restriction base="xs:string">
    <xs:minLength value="1" />
    <xs:maxLength value="2048" />
  </xs:restriction>
</xs:simpleType>
<xs:simpleType name="DescriptionType">
  <xs:restriction base="xs:string">
    <xs:minLength value="1" />
    <xs:maxLength value="256" />
  </xs:restriction>
</xs:simpleType>
<xs:complexType name="AddressType" xdb:SQLType="ADDRESS_T">
```

```

<xs:sequence>
  <xs:element name="StreetLine1" type="StreetType"/>
  <xs:element name="StreetLine2" type="StreetType" minOccurs="0"/>
  <xs:element name="City" type="CityType"/>
  <xs:choice>
    <xs:sequence>
      <xs:element name="State" type="StateType"/>
      <xs:element name="ZipCode" type="ZipCodeType"/>
    </xs:sequence>
    <xs:sequence>
      <xs:element name="Province" type="ProvinceType"/>
      <xs:element name="PostCode" type="PostCodeType"/>
    </xs:sequence>
    <xs:sequence>
      <xs:element name="County" type="CountyType"/>
      <xs:element name="Postcode" type="PostCodeType"/>
    </xs:sequence>
  </xs:choice>
  <xs:element name="Country" type="CountryType"/>
</xs:sequence>
</xs:complexType>
<xs:simpleType name="StreetType">
  <xs:restriction base="xs:string">
    <xs:minLength value="1"/>
    <xs:maxLength value="128"/>
  </xs:restriction>
</xs:simpleType>
<xs:simpleType name="CityType">
  <xs:restriction base="xs:string">
    <xs:minLength value="1"/>
    <xs:maxLength value="64"/>
  </xs:restriction>
</xs:simpleType>
<xs:simpleType name="StateType">
  <xs:restriction base="xs:string">
    <xs:minLength value="2"/>
    <xs:maxLength value="2"/>
    <xs:enumeration value="AK"/>
    <xs:enumeration value="AL"/>
    <xs:enumeration value="AR"/>
    <xs:enumeration value="AS"/>
    <xs:enumeration value="AZ"/>
    <xs:enumeration value="CA"/>
    <xs:enumeration value="CO"/>
    <xs:enumeration value="CT"/>
    <xs:enumeration value="DC"/>
    <xs:enumeration value="DE"/>
    <xs:enumeration value="FL"/>
    <xs:enumeration value="FM"/>
    <xs:enumeration value="GA"/>
    <xs:enumeration value="GU"/>
    <xs:enumeration value="HI"/>
    <xs:enumeration value="IA"/>
    <xs:enumeration value="ID"/>
    <xs:enumeration value="IL"/>
    <xs:enumeration value="IN"/>
    <xs:enumeration value="KS"/>
    <xs:enumeration value="KY"/>
    <xs:enumeration value="LA"/>
    <xs:enumeration value="MA"/>
    <xs:enumeration value="MD"/>
    <xs:enumeration value="ME"/>
    <xs:enumeration value="MH"/>
    <xs:enumeration value="MI"/>
    <xs:enumeration value="MN"/>
    <xs:enumeration value="MO"/>
    <xs:enumeration value="MP"/>
    <xs:enumeration value="MQ"/>
    <xs:enumeration value="MS"/>
  </xs:restriction>
</xs:simpleType>

```

```
<xs:enumeration value="MT" />
<xs:enumeration value="NC" />
<xs:enumeration value="ND" />
<xs:enumeration value="NE" />
<xs:enumeration value="NH" />
<xs:enumeration value="NJ" />
<xs:enumeration value="NM" />
<xs:enumeration value="NV" />
<xs:enumeration value="NY" />
<xs:enumeration value="OH" />
<xs:enumeration value="OK" />
<xs:enumeration value="OR" />
<xs:enumeration value="PA" />
<xs:enumeration value="PR" />
<xs:enumeration value="PW" />
<xs:enumeration value="RI" />
<xs:enumeration value="SC" />
<xs:enumeration value="SD" />
<xs:enumeration value="TN" />
<xs:enumeration value="TX" />
<xs:enumeration value="UM" />
<xs:enumeration value="UT" />
<xs:enumeration value="VA" />
<xs:enumeration value="VI" />
<xs:enumeration value="VT" />
<xs:enumeration value="WA" />
<xs:enumeration value="WI" />
<xs:enumeration value="WV" />
<xs:enumeration value="WY" />
</xs:restriction>
</xs:simpleType>
<xs:simpleType name="ZipCodeType">
  <xs:restriction base="xs:string">
    <xs:pattern value="\d{5}" />
    <xs:pattern value="\d{5}-\d{4}" />
  </xs:restriction>
</xs:simpleType>
<xs:simpleType name="CountryType">
  <xs:restriction base="xs:string">
    <xs:minLength value="1" />
    <xs:maxLength value="64" />
  </xs:restriction>
</xs:simpleType>
<xs:simpleType name="CountyType">
  <xs:restriction base="xs:string">
    <xs:minLength value="1" />
    <xs:maxLength value="32" />
  </xs:restriction>
</xs:simpleType>
<xs:simpleType name="PostCodeType">
  <xs:restriction base="xs:string">
    <xs:minLength value="1" />
    <xs:maxLength value="12" />
  </xs:restriction>
</xs:simpleType>
<xs:simpleType name="ProvinceType">
  <xs:restriction base="xs:string">
    <xs:minLength value="2" />
    <xs:maxLength value="2" />
  </xs:restriction>
</xs:simpleType>
<xs:simpleType name="NotesType">
  <xs:restriction base="xs:string">
    <xs:maxLength value="32767" />
  </xs:restriction>
</xs:simpleType>
<xs:simpleType name="UPCCodeType">
  <xs:restriction base="xs:string">
    <xs:minLength value="11" />
  </xs:restriction>
</xs:simpleType>
```

```

<xs:maxLength value="14"/>
<xs:pattern value="\d{11}"/>
<xs:pattern value="\d{12}"/>
<xs:pattern value="\d{13}"/>
<xs:pattern value="\d{14}"/>
</xs:restriction>
</xs:simpleType>
</xs:schema>

```

A.7 XSLT Stylesheet Example, PurchaseOrder.xsl

The full listing is presented of XSLT stylesheet `PurchaseOrder.xsl`, which is used in various examples.

Example A-4 *PurchaseOrder.xsl XSLT Stylesheet*

```

<?xml version="1.0" encoding="UTF-8"?>
<xsl:stylesheet version="1.0"
  xmlns:xsl="http://www.w3.org/1999/XSL/Transform"
  xmlns:xdb="http://xmlns.oracle.com/xdb"
  xmlns:xsi="http://www.w3.org/2001/XMLSchema-instance">
  <xsl:template match="/">
    <html>
      <head/>
      <body bgcolor="#003333" text="#FFFFFF" link="#FFCC00"
        vlink="#66CC99" alink="#669999">
        <FONT FACE="Arial, Helvetica, sans-serif">
          <xsl:for-each select="PurchaseOrder"/>
          <xsl:for-each select="PurchaseOrder">
            <center>
              <span style="font-family:Arial; font-weight:bold">
                <FONT COLOR="#FF0000">
                  <B>Purchase Order </B>
                </FONT>
              </span>
            </center>
            <br/>
            <center>
              <xsl:for-each select="Reference">
                <span style="font-family:Arial; font-weight:bold">
                  <xsl:apply-templates/>
                </span>
              </xsl:for-each>
            </center>
          </xsl:for-each>
          <P>
            <xsl:for-each select="PurchaseOrder">
              <br/>
            </xsl:for-each>
          </P>
          <P>
            <xsl:for-each select="PurchaseOrder">
              <br/>
            </xsl:for-each>
          </P>
          </P>
          <xsl:for-each select="PurchaseOrder"/>
          <xsl:for-each select="PurchaseOrder">
            <table border="0" width="100%" BGCOLOR="#000000">
              <tbody>
                <tr>
                  <td WIDTH="296">

```

```

<P>
  <B>
    <FONT SIZE="+1" COLOR="#FF0000"
      FACE="Arial, Helvetica, sans-serif">Internal
    </FONT>
  </B>
</P>
<table border="0" width="98%" BGCOLOR="#000099">
  <tbody>
    <tr>
      <td WIDTH="49%">
        <B>
          <FONT COLOR="#FFFF00">Actions</FONT>
        </B>
      </td>
      <td WIDTH="51%">
        <xsl:for-each select="Actions">
          <xsl:for-each select="Action">
            <table border="1" WIDTH="143">
              <xsl:if test="position()=1">
                <thead>
                  <tr>
                    <td HEIGHT="21">
                      <FONT
                        COLOR="#FFFF00">User</FONT>
                    </td>
                    <td HEIGHT="21">
                      <FONT
                        COLOR="#FFFF00">Date</FONT>
                    </td>
                  </tr>
                </thead>
                <tbody>
                  <tr>
                    <td>
                      <xsl:for-each select="User">
                        <xsl:apply-templates/>
                      </xsl:for-each>
                    </td>
                    <td>
                      <xsl:for-each select="Date">
                        <xsl:apply-templates/>
                      </xsl:for-each>
                    </td>
                  </tr>
                </tbody>
              </table>
            </xsl:for-each>
          </xsl:for-each>
        </td>
      </tr>
      <tr>
        <td WIDTH="49%">
          <B>
            <FONT COLOR="#FFFF00">Requestor</FONT>
          </B>
        </td>
        <td WIDTH="51%">
          <xsl:for-each select="Requestor">
            <xsl:apply-templates/>
          </td>
        </tr>
      </tbody>
    </table>

```

```

        </xsl:for-each>
    </td>
</tr>
<tr>
    <td WIDTH="49%">
        <B>
            <FONT COLOR="#FFFF00">User</FONT>
        </B>
    </td>
    <td WIDTH="51%">
        <xsl:for-each select="User">
            <xsl:apply-templates/>
        </xsl:for-each>
    </td>
</tr>
<tr>
    <td WIDTH="49%">
        <B>
            <FONT COLOR="#FFFF00">Cost Center</FONT>
        </B>
    </td>
    <td WIDTH="51%">
        <xsl:for-each select="CostCenter">
            <xsl:apply-templates/>
        </xsl:for-each>
    </td>
</tr>
</tbody>
</table>
</td>
<td width="93"/>
<td valign="top" WIDTH="340">
    <B>
        <FONT COLOR="#FF0000">
            <FONT SIZE="+1">Ship To</FONT>
        </FONT>
    </B>
    <xsl:for-each select="ShippingInstructions">
        <xsl:if test="position()=1"/>
    </xsl:for-each>
    <xsl:for-each select="ShippingInstructions">
        <xsl:if test="position()=1">
            <table border="0" BGCOLOR="#999900">
                <tbody>
                    <tr>
                        <td WIDTH="126" HEIGHT="24">
                            <B>Name</B>
                        </td>
                        <xsl:for-each
                            select="../ShippingInstructions">
                            <td WIDTH="218" HEIGHT="24">
                                <xsl:for-each select="name">
                                    <xsl:apply-templates/>
                                </xsl:for-each>
                            </td>
                        </xsl:for-each>
                    </tr>
                    <tr>
                        <td WIDTH="126" HEIGHT="34">
                            <B>Address</B>
                        </td>

```

```

        <xsl:for-each
            select="../ShippingInstructions">
            <td WIDTH="218" HEIGHT="34">
                <xsl:for-each select="address">
                    <span style="white-space:pre">
                        <xsl:apply-templates/>
                    </span>
                </xsl:for-each>
            </td>
        </xsl:for-each>
    </tr>
    <tr>
        <td WIDTH="126" HEIGHT="32">
            <B>Telephone</B>
        </td>
        <xsl:for-each
            select="../ShippingInstructions">
            <td WIDTH="218" HEIGHT="32">
                <xsl:for-each select="telephone">
                    <xsl:apply-templates/>
                </xsl:for-each>
            </td>
        </xsl:for-each>
    </tr>
</tbody>
</table>
</xsl:if>
</xsl:for-each>
</td>
</tr>
</tbody>
</table>
<br/>
<B>
    <FONT COLOR="#FF0000" SIZE="+1">Items:</FONT>
</B>
<br/>
<br/>
<table border="0">
    <xsl:for-each select="LineItems">
        <xsl:for-each select="LineItem">
            <xsl:if test="position()=1">
                <thead>
                    <tr bgcolor="#C0C0C0">
                        <td>
                            <FONT COLOR="#FF0000">
                                <B>ItemNumber</B>
                            </FONT>
                        </td>
                        <td>
                            <FONT COLOR="#FF0000">
                                <B>Description</B>
                            </FONT>
                        </td>
                        <td>
                            <FONT COLOR="#FF0000">
                                <B>PartId</B>
                            </FONT>
                        </td>
                        <td>
                            <FONT COLOR="#FF0000">

```



```

        <B>Quantity</B>
    </FONT>
</td>
<td>
    <FONT COLOR="#FF0000">
        <B>Unit Price</B>
    </FONT>
</td>
<td>
    <FONT COLOR="#FF0000">
        <B>Total Price</B>
    </FONT>
</td>
</tr>
</thead>
</xsl:if>
<tbody>
<tr bgcolor="#DADADA">
<td>
    <FONT COLOR="#000000">
        <xsl:for-each select="@ItemNumber">
            <xsl:value-of select="."/>
        </xsl:for-each>
    </FONT>
</td>
<td>
    <FONT COLOR="#000000">
        <xsl:for-each select="Description">
            <xsl:apply-templates/>
        </xsl:for-each>
    </FONT>
</td>
<td>
    <FONT COLOR="#000000">
        <xsl:for-each select="Part">
            <xsl:for-each select="@Id">
                <xsl:value-of select="."/>
            </xsl:for-each>
        </xsl:for-each>
    </FONT>
</td>
<td>
    <FONT COLOR="#000000">
        <xsl:for-each select="Part">
            <xsl:for-each select="@Quantity">
                <xsl:value-of select="."/>
            </xsl:for-each>
        </xsl:for-each>
    </FONT>
</td>
<td>
    <FONT COLOR="#000000">
        <xsl:for-each select="Part">
            <xsl:for-each select="@UnitPrice">
                <xsl:value-of select="."/>
            </xsl:for-each>
        </xsl:for-each>
    </FONT>
</td>
<td>
    <FONT FACE="Arial, Helvetica, sans-serif"

```

```

                                COLOR="#000000">
                                <xsl:for-each select="Part">
                                  <xsl:value-of select="@Quantity*@UnitPrice"/>
                                </xsl:for-each>
                                </FONT>
                                </td>
                                </tr>
                                </tbody>
                                </xsl:for-each>
                                </xsl:for-each>
                                </table>
                                </xsl:for-each>
                                </FONT>
                                </body>
                                </html>
                                </xsl:template>
                                </xsl:stylesheet>

```

A.8 Loading XML Data Using C (OCI)

A full listing of a C program that inserts XML data into an XMLType table is presented.

The same program is partly listed in [Loading XML Content Using C](#) (page 3-11).

Example A-5 Inserting XML Data into an XMLType Table Using C

```

#include "stdio.h"
#include <xml.h>
#include <stdlib.h>
#include <string.h>
#include <ocixmlldb.h>
OCIEnv *envhp;
OCIError *errhp;
OCISvcCtx *svchp;
OCIStmt *stmthp;
OCIServer *srvhp;
OCIDuration dur;
OCISession *sesshp;
oratest *username = "QUINE";
oratest *password = "*****"; /* Replace with real password */
oratest *filename = "AMCEWEN-20021009123336171PDT.xml";
oratest *schemaloc = "http://localhost:8080/source/schemas/poSource/xsd/purchaseOrder.xsd";

/* Execute a SQL statement that binds XML data */
sword exec_bind_xml(OCISvcCtx *svchp, OCIError *errhp, OCIStmt *stmthp,
                    void *xml, OCIType *xmltdo, OraText *sqlstmt)
{
    OCIBind *bndhpl = (OCIBind *) 0;
    sword status = 0;
    OCIInd ind = OCI_IND_NOTNULL;
    OCIInd *indp = &ind;
    if(status = OCIStmtPrepare(stmthp, errhp, (OraText *)sqlstmt,
                              (ub4)strlen((const char *)sqlstmt),
                              (ub4) OCI_NTV_SYNTAX, (ub4) OCI_DEFAULT))
        return OCI_ERROR;
    if(status = OCIBindByPos(stmthp, &bndhpl, errhp, (ub4) 1, (dvoid *) 0,
                              (sb4) 0, SQLT_NTY, (dvoid *) 0, (ub2 *) 0,
                              (ub2 *) 0, (ub4) 0, (ub4 *) 0, (ub4) OCI_DEFAULT))
        return OCI_ERROR;
    if(status = OCIBindObject(bndhpl, errhp, (CONST OCIType *) xmltdo,
                              (dvoid **) &xml, (ub4 *) 0,
                              (dvoid **) &indp, (ub4 *) 0))
        return OCI_ERROR;
    if(status = OCIStmtExecute(svchp, stmthp, errhp, (ub4) 1, (ub4) 0,
                              (CONST OCISnapshot*) 0, (OCISnapshot*) 0,
                              (ub4) OCI_DEFAULT))

```

```

    return OCI_ERROR;
return OCI_SUCCESS;
}

/* Initialize OCI handles, and connect */
sword init_oci_connect()
{
    sword status;
    if (OCIEnvCreate((OCIEnv **) &(envhp), (ub4) OCI_OBJECT,
                    (dvoid *) 0, (dvoid * (*)(dvoid *, size_t)) 0,
                    (dvoid * (*)(dvoid *, dvoid *, size_t)) 0,
                    (void (*)(dvoid *, dvoid *)) 0, (size_t) 0, (dvoid **) 0))
    {
        printf("FAILED: OCIEnvCreate()\n");
        return OCI_ERROR;
    }
    /* Allocate error handle */
    if (OCIHandleAlloc((dvoid *) envhp, (dvoid **) &(errhp),
                      (ub4) OCI_HTYPE_ERROR, (size_t) 0, (dvoid **) 0))
    {
        printf("FAILED: OCIHandleAlloc() on errhp\n");
        return OCI_ERROR;
    }
    /* Allocate server handle */
    if (status = OCIHandleAlloc((dvoid *) envhp, (dvoid **) &srvhp,
                               (ub4) OCI_HTYPE_SERVER, (size_t) 0, (dvoid **) 0))
    {
        printf("FAILED: OCIHandleAlloc() on srvhp\n");
        return OCI_ERROR;
    }
    /* Allocate service context handle */
    if (status = OCIHandleAlloc((dvoid *) envhp,
                               (dvoid **) &(svchp), (ub4) OCI_HTYPE_SVCCTX,
                               (size_t) 0, (dvoid **) 0))
    {
        printf("FAILED: OCIHandleAlloc() on svchp\n");
        return OCI_ERROR;
    }
    /* Allocate session handle */
    if (status = OCIHandleAlloc((dvoid *) envhp, (dvoid **) &sesshp,
                               (ub4) OCI_HTYPE_SESSION, (size_t) 0, (dvoid **) 0))
    {
        printf("FAILED: OCIHandleAlloc() on sesshp\n");
        return OCI_ERROR;
    }
    /* Allocate statement handle */
    if (OCIHandleAlloc((dvoid *) envhp, (dvoid **) &stmthp,
                      (ub4) OCI_HTYPE_STMT, (CONST size_t) 0, (dvoid **) 0))
    {
        printf("FAILED: OCIHandleAlloc() on stmthp\n");
        return status;
    }
    if (status = OCIServerAttach((OCIServer *) srvhp, (OCIError *) errhp,
                               (CONST oratext *) "", 0, (ub4) OCI_DEFAULT))
    {
        printf("FAILED: OCIServerAttach() on srvhp\n");
        return OCI_ERROR;
    }
    /* Set server attribute to service context */
    if (status = OCIAttrSet((dvoid *) svchp, (ub4) OCI_HTYPE_SVCCTX,
                          (dvoid *) srvhp, (ub4) 0, (ub4) OCI_ATTR_SERVER,
                          (OCIError *) errhp))
    {
        printf("FAILED: OCIAttrSet() on svchp\n");
        return OCI_ERROR;
    }
    /* Set user attribute to session */
    if (status = OCIAttrSet((dvoid *) sesshp, (ub4) OCI_HTYPE_SESSION,
                          (dvoid *) username,

```

```

                (ub4) strlen((const char *)username),
                (ub4) OCI_ATTR_USERNAME, (OCIError *) errhp))
    {
        printf("FAILED: OCIAttrSet() on authp for user\n");
        return OCI_ERROR;
    }
/* Set password attribute to session */
if (status = OCIAttrSet((dvoid *) sesshp, (ub4) OCI_HTYPE_SESSION,
                        (dvoid *)password,
                        (ub4) strlen((const char *)password),
                        (ub4) OCI_ATTR_PASSWORD, (OCIError *) errhp))
    {
        printf("FAILED: OCIAttrSet() on authp for password\n");
        return OCI_ERROR;
    }
/* Begin a session */
if (status = OCISessionBegin((OCISvcCtx *) svchp,
                             (OCIError *) errhp,
                             (OCISession *) sesshp, (ub4) OCI_CRED_RDBMS,
                             (ub4) OCI_STMT_CACHE))
    {
        printf("FAILED: OCISessionBegin(). Make sure database is up and the username/password is valid. \n");
        return OCI_ERROR;
    }
/* Set session attribute to service context */
if (status = OCIAttrSet((dvoid *) svchp, (ub4) OCI_HTYPE_SVCCTX,
                        (dvoid *)sesshp, (ub4) 0, (ub4) OCI_ATTR_SESSION,
                        (OCIError *) errhp))
    {
        printf("FAILED: OCIAttrSet() on svchp\n");
        return OCI_ERROR;
    }
}

/* Free OCI handles, and disconnect */
void free_oci()
{
    sword status = 0;

/* End the session */
if (status = OCISessionEnd((OCISvcCtx *)svchp, (OCIError *)errhp,
                          (OCISession *)sesshp, (ub4) OCI_DEFAULT))
    {
        if (envhp)
            OCIHandleFree((dvoid *)envhp, OCI_HTYPE_ENV);
        return;
    }
/* Detach from the server */
if (status = OCIServerDetach((OCIServer *)srvhp, (OCIError *)errhp,
                             (ub4)OCI_DEFAULT))
    {
        if (envhp)
            OCIHandleFree((dvoid *)envhp, OCI_HTYPE_ENV);
        return;
    }
/* Free the handles */
if (stmthp) OCIHandleFree((dvoid *)stmthp, (ub4) OCI_HTYPE_STMT);
if (sesshp) OCIHandleFree((dvoid *)sesshp, (ub4) OCI_HTYPE_SESSION);
if (svchp) OCIHandleFree((dvoid *)svchp, (ub4) OCI_HTYPE_SVCCTX);
if (srvhp) OCIHandleFree((dvoid *)srvhp, (ub4) OCI_HTYPE_SERVER);
if (errhp) OCIHandleFree((dvoid *)errhp, (ub4) OCI_HTYPE_ERROR);
if (envhp) OCIHandleFree((dvoid *)envhp, (ub4) OCI_HTYPE_ENV);
return;
}

void main()
{
    OCIType *xmltdo;
    xmldocnode *doc;

```

```

ocixmlbparam params[1];
xmlerr      err;
xmlctx     *xctx;
oralextext *ins_stmt;
sword      status;
xmlnode    *root;
oralextext buf[10000];

/* Initialize envhp, svchp, errhp, dur, stmthp */
init_oci_connect();

/* Get an XML context */
params[0].name_ocixmlbparam = XCTXINIT_OCIDUR;
params[0].value_ocixmlbparam = &dur;
xctx = OCIXmlDbInitXmlCtx(envhp, svchp, errhp, params, 1);
if (!(doc = XmlLoadDom(xctx, &err, "file", filename,
                      "schema_location", schemaloc, NULL)))
{
    printf("Parse failed.\n");
    return;
}
else
    printf("Parse succeeded.\n");
root = XmlDomGetDocElem(xctx, doc);
printf("The xml document is :\n");
XmlSaveDom(xctx, &err, (xmlnode *)doc, "buffer", buf, "buffer_length", 10000, NULL);
printf("%s\n", buf);

/* Insert the document into my_table */
ins_stmt = (oralextext *)"insert into purchaseorder values (:1)";
status = OCITypeByName(envhp, errhp, svchp, (const text *) "SYS",
                      (ub4) strlen((const char *)"SYS"), (const text *) "XMLTYPE",
                      (ub4) strlen((const char *)"XMLTYPE"), (CONST text *) 0,
                      (ub4) 0, OCI_DURATION_SESSION, OCI_TYPEGET_HEADER,
                      (OCIType **) &xmldto);
if (status == OCI_SUCCESS)
{
    status = exec_bind_xml(svchp, errhp, stmthp, (void *)doc,
                          xmldto, ins_stmt);
}
if (status == OCI_SUCCESS)
    printf ("Insert successful\n");
else
    printf ("Insert failed\n");

/* Free XML instances */
if (doc) XmlFreeDocument((xmlctx *)xctx, (xmldocnode *)doc);

/* Free XML CTX */
OCIXmlDbFreeXmlCtx(xctx);
free_oci();
}

```

A.9 Initializing and Terminating an XML Context (OCI)

An example shows how to use OCI functions `OCIXmlDbInitXmlCtx()` and `OCIXmlDbFreeXmlCtx()` to initialize and terminate an XML context. It constructs an XML document using the C DOM API and saves it to the database.

[Example A-6](#) (page A-50) is partially listed in [C DOM API for XMLType](#) (page 14-1), [Initializing and Terminating an XML Context](#) (page 14-3). It assumes that the following SQL code has first been executed to create table `my_table` in database schema `CAPIUSER`:

```

CONNECT CAPIUSER
Enter password: <password>

```

Connected.

```
CREATE TABLE my_table OF XMLType;
```

Example A-6 Using OCIXmlDbInitXmlCtx() and OCIXmlDbFreeXmlCtx()

```
#ifndef S_ORACLE
#endif
#ifndef ORATYPES_ORACLE
#include <oratypes.h>
#endif
#ifndef XML_ORACLE
#include <xml.h>
#endif
#ifndef OCIXML_ORACLE
#include <ocixml.h>
#endif
#ifndef OCI_ORACLE
#include <oci.h>
#endif
#include <string.h>

typedef struct test_ctx {
    OCIEnv *envhp;
    OCIError *errhp;
    OCISvcCtx *svchp;
    OCISmt *stmthp;
    OCIserver *srvhp;
    OCIDuration dur;
    OCISession *sesshp;
    oratext *username;
    oratext *password;
} test_ctx;

/* Helper function 1: execute a sql statement which binds xml data */
static sword exec_bind_xml(OCISvcCtx *svchp,
                            OCIError *errhp,
                            OCISmt *stmthp,
                            void *xml,
                            OCIType *xmltdo,
                            OraText *sqlstmt);

/* Helper function 2: Initialize OCI handles and connect */
static sword init_oci_handles(test_ctx *ctx);

/* Helper function 3: Free OCI handles and disconnect */
static sword free_oci_handles(test_ctx *ctx);

void main()
{
    test_ctx temp_ctx;
    test_ctx *ctx = &temp_ctx;
    OCIType *xmltdo = (OCIType *) 0;
    xmldocnode *doc = (xmldocnode *)0;
    ocixmlbparam params[1];
    xmlnode *quux, *foo, *foo_data, *top;
    xmlerr err;
    sword status = 0;
    xmlctx *xctx;

    oratext ins_stmt[] = "insert into my_table values (:1)";
```

```

oratext tlpxml_test_sch[] = "<TOP/>";
ctx->username = (oratext *)"CAPIUSER";
ctx->password = (oratext *)"*****"; /* Replace with real password */

/* Initialize envhp, svchp, errhp, dur, stmthp */
init_oci_handles(ctx);

/* Get an xml context */
params[0].name_ocixmlbparam = XCTXINIT_OCIDUR;
params[0].value_ocixmlbparam = &ctx->dur;
xctx = OCIXmlDbInitXmlCtx(ctx->envhp, ctx->svchp, ctx->errhp, params, 1);

/* Start processing - first, check that this DOM supports XML 1.0 */
printf("\n\nSupports XML 1.0? : %s\n",
       XmlHasFeature(xctx, (oratext *) "xml", (oratext *) "1.0") ?
       "YES" : "NO");

/* Parse a document */
if (!(doc = XmlLoadDom(xctx, &err, "buffer", tlpxml_test_sch,
                      "buffer_length", sizeof(tlpxml_test_sch)-1,
                      "validate", TRUE, NULL)))
{
    printf("Parse failed, code %d\n", err);
}
else
{
    /* Get the document element */
    top = (xmlnode *)XmlDomGetDocElem(xctx, doc);

    /* Print out the top element */
    printf("\n\nOriginal top element is :\n");
    XmlSaveDom(xctx, &err, top, "stdio", stdout, NULL);

    /* Print out the document. The changes are reflected here */
    printf("\n\nOriginal document is :\n");
    XmlSaveDom(xctx, &err, (xmlnode *)doc, "stdio", stdout, NULL);

    /* Create some elements and add them to the document */
    quux = (xmlnode *) XmlDomCreateElem(xctx, doc, (oratext *) "QUUX");
    foo = (xmlnode *) XmlDomCreateElem(xctx, doc, (oratext *) "FOO");
    foo_data = (xmlnode *) XmlDomCreateText(xctx, doc, (oratext *) "data");
    foo_data = XmlDomAppendChild(xctx, (xmlnode *) foo, (xmlnode *) foo_data);
    foo = XmlDomAppendChild(xctx, quux, foo);
    quux = XmlDomAppendChild(xctx, top, quux);

    /* Print out the top element */
    printf("\n\nNow the top element is :\n");
    XmlSaveDom(xctx, &err, top, "stdio", stdout, NULL);

    /* Print out the document. The changes are reflected here */
    printf("\n\nNow the document is :\n");
    XmlSaveDom(xctx, &err, (xmlnode *)doc, "stdio", stdout, NULL);

    /* Insert the document into my_table */
    status = OCITypeByName(ctx->envhp, ctx->errhp, ctx->svchp,
                          (const text *) "SYS", (ub4) strlen((char *)"SYS"),
                          (const text *) "XMLTYPE",
                          (ub4) strlen((char *)"XMLTYPE"), (CONST text *) 0,
                          (ub4) 0, OCI_DURATION_SESSION, OCI_TYPEGET_HEADER,
                          (OCIType **) &xmltdo);
    if (status == OCI_SUCCESS)

```

```

        {
            exec_bind_xml(ctx->svchp, ctx->errhp, ctx->stmthp, (void *)doc, xmltdo,
                ins_stmt);
        }
    }
    /* Free xml ctx */
    OCIXmlDbFreeXmlCtx(xctx);

    /* Free envhp, svchp, errhp, stmthp */
    free_oci_handles(ctx);
}

/* Helper function 1: execute a SQL statement that binds xml data */
static sword exec_bind_xml(OCISvcCtx *svchp,
                            OCIError *errhp,
                            OCISmt *stmthp,
                            void *xml,
                            OCIType *xmltdo,
                            OraText *sqlstmt)
{
    OCIBind *bndhpl = (OCIBind *) 0;
    sword status = 0;
    OCIInd ind = OCI_IND_NOTNULL;
    OCIInd *indp = &ind;
    if(status = OCISmtPrepare(stmthp, errhp, (OraText *)sqlstmt,
                            (ub4)strlen((char *)sqlstmt),
                            (ub4) OCI_NTV_SYNTAX, (ub4) OCI_DEFAULT)) {
        printf("Failed OCISmtPrepare\n");
        return OCI_ERROR;
    }
    if(status = OCIBindByPos(stmthp, &bndhpl, errhp, (ub4) 1, (dvoid *) 0,
                            (sb4) 0, SQLT_NTY, (dvoid *) 0, (ub2 *)0,
                            (ub2 *)0, (ub4) 0, (ub4 *) 0, (ub4) OCI_DEFAULT)) {
        printf("Failed OCIBindByPos\n");
        return OCI_ERROR;
    }
    if(status = OCIBindObject(bndhpl, errhp, (CONST OCIType *) xmltdo, (dvoid **)
                            &xml,
                            (ub4 *) 0, (dvoid **) &indp, (ub4 *) 0)) {
        printf("Failed OCIBindObject\n");
        return OCI_ERROR;
    }
    if(status = OCISmtExecute(svchp, stmthp, errhp, (ub4) 1, (ub4) 0,
                            (CONST OCISnapshot*) 0, (OCISnapshot*) 0,
                            (ub4) OCI_DEFAULT)) {
        printf("Failed OCISmtExecute\n");
        return OCI_ERROR;
    }
    return OCI_SUCCESS;
}

/* Helper function 2: Initialize OCI handles and connect */
static sword init_oci_handles(test_ctx *ctx)
{
    sword status;
    ctx->dur = OCI_DURATION_SESSION;
    if (OCIEnvCreate((OCIEnv **) &(ctx->envhp), (ub4) OCI_OBJECT,
                    (dvoid *) 0, (dvoid * (*)(dvoid *,size_t)) 0,
                    (dvoid * (*)(dvoid *, dvoid *, size_t)) 0,
                    (void (*)(dvoid *, dvoid *)) 0, (size_t) 0, (dvoid **) 0))
    {

```



```

        printf("FAILED: OCIEnvCreate()\n");
        return OCI_ERROR;
    }
    /* Allocate error handle */
    if (OCIHandleAlloc((dvoid *) ctx->envhp, (dvoid **) &(ctx->errhp),
                      (ub4) OCI_HTYPE_ERROR, (size_t) 0, (dvoid **) 0))
    {
        printf("FAILED: OCIHandleAlloc() on errhp\n");
        return OCI_ERROR;
    }
    /* Allocate server handle */
    if (status = OCIHandleAlloc((dvoid *) ctx->envhp, (dvoid **) &ctx->srvhp,
                              (ub4) OCI_HTYPE_SERVER, (size_t) 0, (dvoid **) 0))
    {
        printf("FAILED: OCIHandleAlloc() on srvhp\n");
        return OCI_ERROR;
    }
    /* Allocate service context handle */
    if (status = OCIHandleAlloc((dvoid *) ctx->envhp,
                              (dvoid **) &(ctx->svchp), (ub4) OCI_HTYPE_SVCCTX,
                              (size_t) 0, (dvoid **) 0))
    {
        printf("FAILED: OCIHandleAlloc() on svchp\n");
        return OCI_ERROR;
    }
    /* Allocate session handle */
    if (status = OCIHandleAlloc((dvoid *) ctx->envhp, (dvoid **) &ctx->sesshp ,
                              (ub4) OCI_HTYPE_SESSION, (size_t) 0, (dvoid **) 0))
    {
        printf("FAILED: OCIHandleAlloc() on sesshp\n");
        return OCI_ERROR;
    }
    /* Allocate statement handle */
    if (OCIHandleAlloc((dvoid *)ctx->envhp, (dvoid **) &ctx->stmthp,
                      (ub4)OCI_HTYPE_STMT, (CONST size_t) 0, (dvoid **) 0))
    {
        printf("FAILED: OCIHandleAlloc() on stmthp\n");
        return status;
    }
    if (status = OCIServerAttach((OCIServer *) ctx->srvhp, (OCIError *) ctx->errhp,
                              (CONST oratext *)"", 0, (ub4) OCI_DEFAULT))
    {
        printf("FAILED: OCIServerAttach() on srvhp\n");
        return OCI_ERROR;
    }
    /* Set server attribute to service context */
    if (status = OCIAttrSet((dvoid *) ctx->svchp, (ub4) OCI_HTYPE_SVCCTX,
                          (dvoid *) ctx->srvhp, (ub4) 0, (ub4) OCI_ATTR_SERVER,
                          (OCIError *) ctx->errhp))
    {
        printf("FAILED: OCIAttrSet() on svchp\n");
        return OCI_ERROR;
    }
    /* Set user attribute to session */
    if (status = OCIAttrSet((dvoid *)ctx->sesshp, (ub4) OCI_HTYPE_SESSION,
                          (dvoid *)ctx->username,
                          (ub4) strlen((char *)ctx->username),
                          (ub4) OCI_ATTR_USERNAME, (OCIError *) ctx->errhp))
    {
        printf("FAILED: OCIAttrSet() on authp for user\n");
        return OCI_ERROR;
    }

```

```

    }
    /* Set password attribute to session */
    if (status = OCIAttrSet((dvoid *) ctx->sesshp, (ub4) OCI_HTYPE_SESSION,
                           (dvoid *) ctx->password,
                           (ub4) strlen((char *) ctx->password),
                           (ub4) OCI_ATTR_PASSWORD, (OCIError *) ctx->errhp))
    {
        printf("FAILED: OCIAttrSet() on authp for password\n");
        return OCI_ERROR;
    }
    /* Begin a session */
    if (status = OCISessionBegin((OCISvcCtx *) ctx->svchp,
                                (OCIError *) ctx->errhp,
                                (OCISession *) ctx->sesshp, (ub4) OCI_CRED_RDBMS,
                                (ub4) OCI_STMT_CACHE))
    {
        printf("FAILED: OCISessionBegin(). Make sure database is up and the \
              username/password is valid. \n");
        return OCI_ERROR;
    }
    /* Set session attribute to service context */
    if (status = OCIAttrSet((dvoid *) ctx->svchp, (ub4) OCI_HTYPE_SVCCTX,
                           (dvoid *) ctx->sesshp, (ub4) 0, (ub4) OCI_ATTR_SESSION,
                           (OCIError *) ctx->errhp))
    {
        printf("FAILED: OCIAttrSet() on svchp\n");
        return OCI_ERROR;
    }
    return status;
}

/* Helper function 3: Free OCI handles and disconnect */
static sword free_oci_handles(test_ctx *ctx)
{
    sword status = 0;
    /* End the session */
    if (status = OCISessionEnd((OCISvcCtx *) ctx->svchp, (OCIError *) ctx->errhp,
                              (OCISession *) ctx->sesshp, (ub4) OCI_DEFAULT))
    {
        if (ctx->envhp)
            OCIHandleFree((dvoid *) ctx->envhp, OCI_HTYPE_ENV);
        return status;
    }
    /* Detach from the server */
    if (status = OCIServerDetach((OCIServer *) ctx->srvhp, (OCIError *) ctx->errhp,
                                (ub4) OCI_DEFAULT))
    {
        if (ctx->envhp)
            OCIHandleFree((dvoid *) ctx->envhp, OCI_HTYPE_ENV);
        return status;
    }
    /* Free the handles */
    if (ctx->stmthp) OCIHandleFree((dvoid *) ctx->stmthp, (ub4) OCI_HTYPE_STMT);
    if (ctx->sesshp) OCIHandleFree((dvoid *) ctx->sesshp, (ub4) OCI_HTYPE_SESSION);
    if (ctx->svchp) OCIHandleFree((dvoid *) ctx->svchp, (ub4) OCI_HTYPE_SVCCTX);
    if (ctx->srvhp) OCIHandleFree((dvoid *) ctx->srvhp, (ub4) OCI_HTYPE_SERVER);
    if (ctx->errhp) OCIHandleFree((dvoid *) ctx->errhp, (ub4) OCI_HTYPE_ERROR);
    if (ctx->envhp) OCIHandleFree((dvoid *) ctx->envhp, (ub4) OCI_HTYPE_ENV);
    return status;
}

```

Oracle XML DB Restrictions

The restrictions associated with Oracle XML DB are listed here.

- *Thin JDBC Driver Not Supported by Some XMLType Functions* – XMLType method `transform()` works only with the OCI driver. Not all `oracle.xml.XMLType` functions are supported by the thin JDBC driver. If you do not use `oracle.xml.XMLType` classes and the OCI driver, you can lose performance benefits.
- *NCHAR, NVARCHAR2, and NCLOB Not Supported* – Oracle XML DB does not support the use of SQL data types NCHAR, NVARCHAR2, and NCLOB for any of the following:
 - Mapping XML elements or attributes to these data types using the `SQLType` annotation in an XML schema
 - Generating XML data from these data types using SQL/XML functions `XMLElement`, `XMLAttributes`, and `XMLForest`
 - Within SQL/XML functions `XMLQuery` and `XMLTable`, using XQuery functions `ora:view (desupported)`, `fn:doc`, and `fn:collection` on tables that contain columns with these data types

To handle, store, or generate XML data that contains multibyte characters, Oracle strongly recommends that you use AL32UTF8 as the database character set.

- *XML Identifier Length Limit* – Oracle XML DB supports only XML identifiers that are a maximum of 32767 bytes or 4000 bytes, depending on the value of initialization parameter `MAX_STRING_SIZE`. See *Oracle Database SQL Language Reference*.
- *Repository File Size Limit* – The maximum size of a file in Oracle XML DB Repository is 4 gigabytes. This implies the following limits for different kinds of file data:
 - 4 gigabytes for any LOB, which means 2 gigacharacters for a CLOB stored in the database character set AL32UTF8.
 - 4 gigabytes for binary XML encoded data, which typically means more than 4 gigabytes of external XML data before encoding.
 - Indeterminate for XML data stored object-relationally.
- *Repository-Wide Resource Configuration File Limit* – You cannot create more than 125 resource configuration files for repository-wide configuration.
- *Recursive Folder Deletion* – You cannot delete more than 50 levels of nested folders using the option for recursive deletion.

-
- *No Column-Level Encryption for XMLType* – Column-level encryption is not supported for XMLType. Tablespace-level encryption is supported for all XMLType storage models.
 - *No Composite Partitioning for XMLType* – Composite partitioning is not supported for XMLType tables or columns (regardless of the XMLType storage model).
 - *No Partitioning for Hierarchically Enabled Tables* – You cannot partition a hierarchy-enabled table. (See [Repository Resources and Database Table Security](#) (page 27-18) for information about hierarchy-enabled tables.
 - *No Oracle Real Application Testing (RAT) for XMLType*– Oracle Real Application Testing (RAT) is not supported for XMLType.
 - *No XMLType Access over Database Links* – Access to remote XMLType tables or columns is not supported.
 - *Oracle JVM Needed for Some Features* – In general, the behavior of Oracle XML DB does not depend on whether or not you have Oracle JVM (Java Virtual Machine) installed. However, if you use Java servlets or PL/SQL package DBMS_XMLSAVE or DBMS_XMLQUERY then you must install Oracle JVM.
 - *Editioning Views Not Compatible with XMLType* – Editioning views are not compatible with XMLType data that is stored object-relationally. They cannot be enabled in database schemas that contain persisted object types.
 - *Transportable tablespaces and database consolidation* – If your Oracle XML DB Repository in Oracle Database 11g Release 2 (11.2) has existing data then you cannot use transportable tablespaces to plug that database directly into a container database (CDB). Instead, upgrade the 11.2 database to 12.1, unplug it, and then plug it in.
 - *No XMLType virtual columns for object-relational storage of XMLType* – You cannot add a virtual XMLType column to an object-relational XMLType table or to a table that has an object-relational XMLType column.
 - *No sharding for XMLType or repository* – Sharding is not supported for XMLType data or for Oracle XML DB Repository.
 - *Use heap tables, not index-organized tables (IOTs)* – For best results, Oracle recommends that you use heap tables, not IOTs, with Oracle XML DB.
 - *XML schema URL uniqueness ignores protocol part* – Attribute `schemaur1` for a registered XML schema must be unique apart from the protocol part. The protocol part (for example, `http` or `https`) is ignored in the test for uniqueness.

See Also:

[Oracle XML DB Support for XQuery](#) (page 4-26) for information about Oracle XML DB support for XQuery

Deprecated Functions for Updating XML Data

Oracle SQL functions for updating XML data that are *deprecated* starting with Oracle Database 12c Release 1 (12.1.0.1) are described. Use XQuery Update instead to update XML data (see [XQuery and Oracle XML DB](#) (page 4-1)).

- [Migration from Oracle Functions for Updating XML Data to XQuery Update](#) (page C-1)
- [Deprecated Oracle SQL Functions for Updating XML Data](#) (page C-5)
- [UPDATEXML Deprecated Oracle SQL Function](#) (page C-7)
- [Optimization of Deprecated Oracle SQL Functions that Modify XML Data](#) (page C-14)
- [Creating XML Views Using Deprecated Oracle SQL Functions that Modify XML Data](#) (page C-16)
- [INSERTCHILDXML Deprecated Oracle SQL Function](#) (page C-16)
- [INSERTCHILDXMLBEFORE Deprecated Oracle SQL Function](#) (page C-19)
- [INSERTCHILDXMLAFTER Deprecated Oracle SQL Function](#) (page C-20)
- [INSERTXMLBEFORE Deprecated Oracle SQL Function](#) (page C-21)
- [INSERTXMLAFTER Deprecated Oracle SQL Function](#) (page C-23)
- [APPENDCHILDXML Deprecated Oracle SQL Function](#) (page C-24)
- [DELETXML Deprecated Oracle SQL Function](#) (page C-25)

C.1 Migration from Oracle Functions for Updating XML Data to XQuery Update

The XQuery Update Facility 1.0 Recommendation is supported by Oracle XML DB starting with Oracle Database 12c Release 1 (12.1.0.1). Prior to this release, to update XML data your queries necessarily used Oracle-specific SQL functions: `appendChildXML`, `deleteXML`, `insertChildXML`, `insertChildXMLafter`, `insertChildXMLbefore`, `insertXMLafter`, `insertXMLbefore`, and `updateXML`.

These functions are covered in detail in the other sections of this appendix.

If you have legacy code that uses these functions, Oracle recommends that you migrate that code to use XQuery Update. This section provides information about

which XQuery Update constructs you can use to replace the use of the Oracle-specific XML updating functions in queries.

[Table C-1](#) (page C-2) provides a mapping from typical queries that use Oracle-specific updating SQL functions to queries that use XQuery Update.

There is no Oracle-specific equivalent for the XQuery Update constructs `rename` and `insert as first into`.

Note too that if the target XPath expression matches more than one node then the Oracle updating functions act on *all* such nodes, whereas the XQuery Update functions raise an error in this case. To act on multiple nodes using XQuery Update you need to use explicit iteration (that is, a `for` expression).

Table C-1 Migrating Oracle-Specific XML Updating Queries to XQuery Update

Original Expression	Replacement Expression
<pre>-- Insert a node as the last child of a node. UPDATE warehouses SET warehouse_spec = appendChildXML(warehouse_spec, '/Warehouse/Parking', XMLType('<Spaces>250</Spaces>'));</pre>	<pre>-- Insert a node as the last child of a node. UPDATE warehouses SET warehouse_spec = XMLQuery('copy \$tmp := . modify insert node <Spaces>250</Spaces> as last into \$tmp/Warehouse/Parking return \$tmp' PASSING warehouse_spec RETURNING CONTENT) WHERE warehouse_spec IS NOT NULL;</pre>
<pre>-- Delete a node. UPDATE warehouses SET warehouse_spec = deleteXML(value(po), '/Warehouse/VClearance');</pre>	<pre>-- Delete a node. UPDATE warehouses SET warehouse_spec = XMLQuery('copy \$tmp := . modify delete node \$tmp/Warehouse/VClearance return \$tmp' PASSING warehouse_spec RETURNING CONTENT) WHERE warehouse_spec IS NOT NULL;</pre>
<pre>-- Insert a node as a child of a node. UPDATE warehouses SET warehouse_spec = insertChildXML(warehouse_spec, '/Warehouse/Parking', 'Spaces', XMLType('<Spaces>300</Spaces>'));</pre>	<pre>-- Insert a node as a child of a node. UPDATE warehouses SET warehouse_spec = XMLQuery('copy \$tmp := . modify insert node <Spaces>300</Spaces> into \$tmp/Warehouse/Parking return \$tmp' PASSING warehouse_spec RETURNING CONTENT) WHERE warehouse_spec IS NOT NULL;</pre>

Table C-1 (Cont.) Migrating Oracle-Specific XML Updating Queries to XQuery Update

Original Expression	Replacement Expression
<pre>-- Insert a node before a node. UPDATE warehouses SET warehouse_spec = insertXMLbefore(warehouse_spec, '/Warehouse/RailAccess', XMLType('<SkyAccess>N</SkyAccess>'));</pre>	<pre>-- Insert a node before a node. UPDATE warehouses SET warehouse_spec = XMLQuery('copy \$tmp := . modify insert node <SkyAccess>N</SkyAccess> before \$tmp/Warehouse/RailAccess return \$tmp' PASSING warehouse_spec RETURNING CONTENT) WHERE warehouse_spec IS NOT NULL;</pre>
<pre>-- Insert a node after a node. UPDATE warehouses SET warehouse_spec = insertXMLafter(warehouse_spec, '/Warehouse/RailAccess', XMLType('<SkyAccess>N</SkyAccess>'));</pre>	<pre>-- Insert a node after a node. UPDATE warehouses SET warehouse_spec = XMLQuery('copy \$tmp := . modify insert node <SkyAccess>N</SkyAccess> after \$tmp/Warehouse/RailAccess return \$tmp' PASSING warehouse_spec RETURNING CONTENT) WHERE warehouse_spec IS NOT NULL;</pre>
<pre>-- Replace the text value of a set of nodes. -- (Assumes a collection of <Building> nodes.) UPDATE warehouses SET warehouse_spec = updateXML(warehouse_spec, '/Warehouse/Building/text()', 'Owned');</pre>	<pre>-- Replace the text value of a set of nodes. -- (Assumes a collection of <Building> nodes.) UPDATE warehouses SET warehouse_spec = XMLQuery('copy \$tmp := . modify (for \$i in \$tmp/Warehouse/Building/ text() return replace value of node \$i with 'Owned') return \$tmp' PASSING warehouse_spec RETURNING CONTENT) WHERE warehouse_spec IS NOT NULL;</pre>
<pre>-- Insert a child under each node in a collection. -- (Assumes a collection of <Building> nodes.) UPDATE warehouses SET warehouse_spec = insertChildXML(warehouse_spec, '/Warehouse/Building', 'Owner', XMLType('<Owner>LesserCo</Owner>'));</pre>	<pre>-- Insert a child under each node in a collection. -- (Assumes a collection of <Building> nodes.) UPDATE warehouses SET warehouse_spec = XMLQuery('copy \$tmp := . modify (for \$i in \$tmp/Warehouse/Building return insert node <Owner>LesserCo</Owner> into \$i) return \$tmp' PASSING warehouse_spec RETURNING CONTENT) WHERE warehouse_spec IS NOT NULL;</pre>

Table C-1 (Cont.) Migrating Oracle-Specific XML Updating Queries to XQuery Update

Original Expression	Replacement Expression
<pre>-- Insert as child before the other children. -- (Assumes a collection of <Owner> nodes.) UPDATE warehouses SET warehouse_spec = insertChildXMLbefore(warehouse_spec, '/Warehouse/Building[1]', 'Owner', XMLType('<Owner>LesserCo</Owner>'));</pre>	<pre>-- Insert as child before the other children. -- (Assumes a collection of <Owner> nodes.) UPDATE warehouses SET warehouse_spec = XMLQuery('copy \$tmp := . modify (for \$i in \$tmp/Warehouse/Building[1]/Owner return insert node <Owner>LesserCo</Owner> before \$i) return \$tmp' PASSING warehouse_spec RETURNING CONTENT) WHERE warehouse_spec IS NOT NULL;</pre>
<pre>-- Insert as child after the other children. -- (Assumes a collection of <Owner> nodes.) UPDATE warehouses SET warehouse_spec = insertChildXMLafter(warehouse_spec, '/Warehouse/Building[1]', 'Owner', XMLType('<Owner>LesserCo</Owner>'));</pre>	<pre>-- Insert as child after the other children. -- (Assumes a collection of <Owner> nodes.) UPDATE warehouses SET warehouse_spec = XMLQuery('copy \$tmp := . modify (for \$i in \$tmp/Warehouse/Building[1]/Owner return insert node <Owner>LesserCo</Owner> after \$i) return \$tmp' PASSING warehouse_spec RETURNING CONTENT) WHERE warehouse_spec IS NOT NULL;</pre>
<pre>-- Delete a node. UPDATE warehouses SET warehouse_spec = updateXML(warehouse_spec, '/Warehouse/Docks', NULL);</pre>	<pre>-- Delete a node. UPDATE warehouses SET warehouse_spec = XMLQuery('copy \$tmp := . modify delete node \$tmp/Warehouse/Docks return \$tmp' PASSING warehouse_spec RETURNING CONTENT) WHERE warehouse_spec IS NOT NULL;</pre>
<pre>-- Replace with an empty node. UPDATE warehouses SET warehouse_spec = updateXML(warehouse_spec, '/Warehouse/Docks', '');</pre>	<pre>-- Replace with an empty node. UPDATE warehouses SET warehouse_spec = XMLQuery('copy \$tmp := \$p1 modify (for \$j in \$tmp/Warehouse/Docks return replace node \$j with \$p2) return \$tmp' PASSING warehouse_spec "p1", '' AS "p2" RETURNING CONTENT) WHERE warehouse_spec IS NOT NULL;</pre>

Table C-1 (Cont.) Migrating Oracle-Specific XML Updating Queries to XQuery Update

Original Expression	Replacement Expression
<pre>-- Update multiple paths. UPDATE warehouses SET warehouse_spec = updateXML(warehouse_spec, '/Warehouse/Docks/text()', '4', '/Warehouse/Area/text()', '3500');</pre>	<pre>-- Update multiple paths. UPDATE warehouses SET warehouse_spec = XMLQuery('copy \$tmp := . modify ((for \$i in \$tmp/Warehouse/Docks/text() return replace value of node \$i with 4), (for \$i in \$tmp/Warehouse/Area/text() return replace value of node \$i with 3500)) return \$tmp' PASSING warehouse_spec RETURNING CONTENT) WHERE warehouse_spec IS NOT NULL;</pre>

C.2 Deprecated Oracle SQL Functions for Updating XML Data

Prior to their deprecation, you used the following Oracle SQL functions to update XML data incrementally — that is, to replace, insert, or delete XML data without replacing the entire surrounding XML document. This is also called **partial updating**.

- `updateXML` – Replace XML nodes of any kind. See [UPDATEXML Deprecated Oracle SQL Function](#) (page C-7).
- `insertChildXML` – Insert XML element or attribute nodes as children of a given element node. See [INSERTCHILDXML Deprecated Oracle SQL Function](#) (page C-16).
- `insertChildXMLbefore` – Insert new collection elements immediately before a given collection element of the same type. See [INSERTCHILDXMLBEFORE Deprecated Oracle SQL Function](#) (page C-19).
- `insertChildXMLafter` – Insert new collection elements immediately after a given collection element of the same type. See [INSERTCHILDXMLAFTER Deprecated Oracle SQL Function](#) (page C-20).
- `insertXMLbefore` – Insert XML nodes of any kind immediately before a given node (other than an attribute node). See [INSERTXMLBEFORE Deprecated Oracle SQL Function](#) (page C-21).
- `insertXMLafter` – Insert XML nodes of any kind immediately after a given node (other than an attribute node). See [INSERTXMLAFTER Deprecated Oracle SQL Function](#) (page C-23).
- `appendChildXML` – Insert XML nodes of any kind as the last child nodes of a given element node. See [APPENDCHILDXML Deprecated Oracle SQL Function](#) (page C-24).
- `deleteXML` – Delete XML nodes of any kind. See [DELETXML Deprecated Oracle SQL Function](#) (page C-25).

Functions `insertChildXML`, `insertChildXMLbefore`, `insertChildXMLafter`, `insertXMLbefore`, `insertXMLafter`, and `appendChildXML` are for inserting

XML data. Function `deleteXML` deletes XML data. Function `updateXML` replaces XML data.

In particular, do *not* use function `updateXML` to insert or delete XML data by replacing a parent node in its entirety. That works, but it is less efficient than using one of the other functions, which perform more localized updates.

These Oracle SQL functions do *not*, by themselves, change database data – they are all pure functions, without side effect. Each applies an XPath-expression argument to input XML data and returns a modified *copy* of the input XML data. You can then use that result with SQL DML operator `UPDATE` to modify database data. This is no different from the way you use SQL function `upper` to convert database data to uppercase: you must use a SQL DML operator such as `UPDATE` to change the stored data.

Each of these functions can be used on XML documents that are either schema-based or non-schema-based. For XML schema-based data, these Oracle SQL functions perform partial validation on the result, and, where appropriate, argument values are also checked for compatibility with the XML schema.

Note:

Oracle SQL functions and `XMLType` methods respect the W3C XPath recommendation, which states that if an XPath expression targets *no nodes* when applied to XML data, then an empty sequence must be returned. An error must *not* be raised in this case.

The specific semantics of an Oracle SQL function or `XMLType` method that applies an XPath expression to XML data determines what is returned. For example, SQL/XML function `XMLQuery` returns `NULL` if its XPath-expression argument targets no nodes, and the deprecated updating Oracle SQL functions, such as `deleteXML`, return the input XML data unchanged. An error is never raised if no nodes are targeted, but the deprecated updating Oracle SQL functions can raise an error if an XPath-expression argument targets inappropriate nodes, such as attribute nodes or text nodes.

See Also:

[Partial and Full XML Schema Validation](#) (page 7-12) for more information about partial validation against an XML schema

C.2.1 Insertion of XML Elements Using Deprecated Oracle SQL Functions

There are several deprecated Oracle SQL functions for inserting XML nodes into (a copy of) existing XML data. Each can insert nodes at multiple locations that are referenced by an XPath expression. They differ in the placement of the new nodes and how the target XML data is referenced.

- Function `appendChildXML` appends nodes to the target elements. That is, for each target element, it inserts one or more nodes of any kind as the element's last children.
- Function `insertChildXML` inserts new children (one or more elements of the same type or a single attribute) under target elements. The position of a new child element under its parent is not specified. If the target data is XML schema-based,

then the schema can sometimes be used to determine the position. Otherwise, the position is arbitrary.

- Function `insertXMLbefore` inserts one or more nodes of *any kind* immediately before a target node (which is not an attribute node).

Function `insertXMLafter` inserts a node similarly, but after the target, not before.

- Function `insertChildXMLbefore` is similar to `insertChildXML`, except that the inserted node must be an element (not an attribute), and you specify the position of the new element among its siblings. It is similar to `insertXMLbefore`, except that it inserts only *collection* elements, not arbitrary elements. The insertion position specifies a successor collection member. The actual element to be inserted must correspond to the element type for the collection.

Function `insertChildXMLafter` inserts a node similarly, but after the target, not before.

Though the effect of `insertChildXMLbefore` (-after) is similar to that of `insertXMLbefore` (-after), the target location is expressed differently. For the former, the target is the parent of the new child. For the latter, the target is the succeeding (or preceding) sibling. This difference is reflected in the function names (Child).

For example, to insert a new `LineItem` element before the third `LineItem` element under element `/PurchaseOrder/LineItems`, you can use `insertChildXMLbefore`, specifying the target parent as `/PurchaseOrder/LineItems` and the succeeding sibling as `LineItem[3]`. Or you can use `insertXMLbefore`, specifying the target succeeding sibling as `/PurchaseOrder/LineItems/LineItem[3]`. If you use `insertChildXML` for the insertion, then you cannot specify the position of the new element in the collection — the resulting position is indeterminate.

Another difference among these functions is that all of them *except* `insertXMLbefore`, `insertXMLafter`, and `appendChildXML` —are optimized for SQL UPDATE operations on `XMLType` tables and columns that are stored object-relationally or as binary XML.

See Also:

[Optimization of Deprecated Oracle SQL Functions that Modify XML Data](#)
(page C-14)

C.3 UPDATEXML Deprecated Oracle SQL Function

Deprecated Oracle SQL function `updateXML` replaces XML nodes of any kind. The XML document that is the target of the update can be schema-based or non-schema-based.

A *copy* of the input `XMLType` instance is modified and returned. The original data is unaffected. You can then use the returned data with SQL operation UPDATE to modify database data.

Function `updateXML` has the following parameters (in order):

- **target-data** (`XMLType`) – The XML data containing the target node to replace.

- One or more *pairs* of *xpath* and *replacement* parameters:
 - ***xpath*** (VARCHAR2) – An XPath 1.0 expression that locates the nodes within *target-data* to replace. *Each* targeted node is replaced by *replacement*. These can be nodes of any kind. If *xpath* matches an empty sequence of nodes then no replacement is done, and *target-data* is returned unchanged (and no error is raised).
 - ***replacement*** (XMLType or VARCHAR2) – The XML data that replaces the data targeted by *xpath*. The data type of *replacement* must correspond to the data to be replaced. If *xpath* targets an element node for replacement, then the data type must be XMLType. If *xpath* targets an attribute node or a text node, then it must be VARCHAR2. For an attribute node, *replacement* is only the replacement *value* of the attribute (for example, 23), not the complete attribute node including the name (for example, my_attribute=" 23 ").
- ***namespace*** (VARCHAR2, optional) – The XML namespace for parameter *xpath*.

Deprecated Oracle SQL function `updateXML` can be used to *replace* existing elements, attributes, and other nodes with new values. It is *not* an efficient way to insert new nodes or delete existing ones. You can perform insertions and deletions with `updateXML` only by using it to replace the entire node that is the parent of the node to be inserted or deleted.

Function `updateXML` updates only the transient XML instance in memory. Use a SQL UPDATE statement to update data stored in tables.

Figure C-1 (page C-8) illustrates the syntax.

Figure C-1 UPDATEXML Syntax

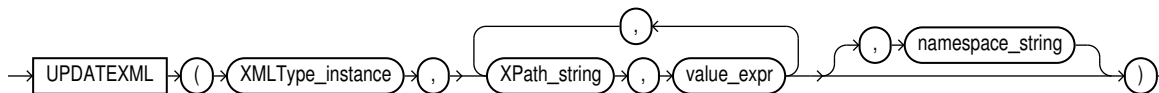

Example C-1 (page C-8) uses `updateXML` on the right side of an UPDATE statement to update the XML document in a table instead of creating a new document. The entire document is updated, not just the part that is selected.

Example C-2 (page C-9) updates multiple nodes using Oracle SQL function `updateXML`.

Example C-3 (page C-10) uses SQL function `updateXML` to update selected nodes within a collection.

Example C-1 Updating XMLTYPE Using UPDATE and UPDATEXML (Deprecated)

```
SELECT XMLQuery('$p/PurchaseOrder/Actions/Action[1]' PASSING po.OBJECT_VALUE AS "p"
              RETURNING CONTENT) action
FROM purchaseorder po
WHERE XMLEExists('$p/PurchaseOrder[Reference="SBELL-2002100912333601PDT]')
      PASSING po.OBJECT_VALUE AS "p");

ACTION
-----
<Action>
  <User>SVOLLMAN</User>
</Action>

UPDATE purchaseorder po
SET po.OBJECT_VALUE = updateXML(po.OBJECT_VALUE,
                               '/PurchaseOrder/Actions/Action[1]/User/text()',
```

```

        'SKING' )
WHERE XMLExists('$p/PurchaseOrder[Reference="SBELL-2002100912333601PDT"]'
    PASSING po.OBJECT_VALUE AS "p");

SELECT XMLQuery('$p/PurchaseOrder/Actions/Action[1]' PASSING po.OBJECT_VALUE AS "p"
    RETURNING CONTENT) action

FROM purchaseorder po
WHERE XMLExists('$p/PurchaseOrder[Reference="SBELL-2002100912333601PDT"]'
    PASSING po.OBJECT_VALUE AS "p");

ACTION
-----
<Action>
  <User>SKING</User>
</Action>

```

Example C-2 Updating Multiple Text Nodes and Attribute Values Using UPDATEXML (Deprecated)

```

SELECT XMLCast(XMLQuery('$p/PurchaseOrder/Requestor'
    PASSING po.OBJECT_VALUE AS "p" RETURNING CONTENT)
    AS VARCHAR2(30)) name,
XMLQuery('$p/PurchaseOrder/LineItems'
    PASSING po.OBJECT_VALUE AS "p" RETURNING CONTENT) lineitems
FROM purchaseorder po
WHERE XMLExists('$p/PurchaseOrder[Reference="SBELL-2002100912333601PDT"]'
    PASSING po.OBJECT_VALUE AS "p");

NAME                LINEITEMS
-----
Sarah J. Bell      <LineItems>
                  <LineItem ItemNumber="1">
                    <Description>A Night to Remember</Description>
                    <Part Id="715515009058" UnitPrice="39.95" Quantity="2"/>
                  </LineItem>
                  <LineItem ItemNumber="2">
                    <Description>The Unbearable Lightness Of Being</Description>
                    <Part Id="37429140222" UnitPrice="29.95" Quantity="2"/>
                  </LineItem>
                  <LineItem ItemNumber="3">
                    <Description>Sisters</Description>
                    <Part Id="715515011020" UnitPrice="29.95" Quantity="4"/>
                  </LineItem>
                  </LineItems>

UPDATE purchaseorder
  SET OBJECT_VALUE = updateXML(OBJECT_VALUE,
    '/PurchaseOrder/Requestor/text()', 'Stephen G. King',
    '/PurchaseOrder/LineItems/LineItem[1]/Part/@Id', '786936150421',
    '/PurchaseOrder/LineItems/LineItem[1]/Description/text()', 'The Rock',
    '/PurchaseOrder/LineItems/LineItem[3]',
    XMLType('<LineItem ItemNumber="99">
      <Description>Dead Ringers</Description>
      <Part Id="715515009249" UnitPrice="39.95" Quantity="2"/>
    </LineItem>'))
WHERE XMLExists('$p/PurchaseOrder[Reference="SBELL-2002100912333601PDT"]'
    PASSING OBJECT_VALUE AS "p");

SELECT XMLCast(XMLQuery('$p/PurchaseOrder/Requestor'
    PASSING po.OBJECT_VALUE AS "p" RETURNING CONTENT)
    AS VARCHAR2(30)) name,
XMLQuery('$p/PurchaseOrder/LineItems'
    PASSING po.OBJECT_VALUE AS "p" RETURNING CONTENT) lineitems
FROM purchaseorder po
WHERE XMLExists('$p/PurchaseOrder[Reference="SBELL-2002100912333601PDT"]'
    PASSING po.OBJECT_VALUE AS "p");

NAME                LINEITEMS
-----

```

```
-----
Stephen G. King <LineItems>
  <LineItem ItemNumber="1">
    <Description>The Rock</Description>
    <Part Id="786936150421" UnitPrice="39.95" Quantity="2"/>
  </LineItem>
  <LineItem ItemNumber="2">
    <Description>The Unbearable Lightness Of Being</Description>
    <Part Id="37429140222" UnitPrice="29.95" Quantity="2"/>
  </LineItem>
  <LineItem ItemNumber="99">
    <Description>Dead Ringers</Description>
    <Part Id="715515009249" UnitPrice="39.95" Quantity="2"/>
  </LineItem>
</LineItems>
```

Example C-3 Updating Selected Nodes within a Collection Using UPDATEXML (Deprecated)

```
SELECT XMLCast(XMLQuery('$p/PurchaseOrder/Requestor'
  PASSING po.OBJECT_VALUE AS "p" RETURNING CONTENT)
  AS VARCHAR2(30)) name,
  XMLQuery('$p/PurchaseOrder/LineItems'
  PASSING po.OBJECT_VALUE AS "p" RETURNING CONTENT) lineitems
FROM purchaseorder po
WHERE XMLEExists('$p/PurchaseOrder[Reference="SBELL-2002100912333601PDT]')
  PASSING po.OBJECT_VALUE AS "p");
```

NAME	LINEITEMS
------	-----------

```
-----
Sarah J. Bell <LineItems>
  <LineItem ItemNumber="1">
    <Description>A Night to Remember</Description>
    <Part Id="715515009058" UnitPrice="39.95" Quantity="2"/>
  </LineItem>
  <LineItem ItemNumber="2">
    <Description>The Unbearable Lightness Of Being</Description>
    <Part Id="37429140222" UnitPrice="29.95" Quantity="2"/>
  </LineItem>
  <LineItem ItemNumber="3">
    <Description>Sisters</Description>
    <Part Id="715515011020" UnitPrice="29.95" Quantity="4"/>
  </LineItem>
</LineItems>
```

```
UPDATE purchaseorder
SET OBJECT_VALUE =
  updateXML(OBJECT_VALUE,
    '/PurchaseOrder/Requestor/text()', 'Stephen G. King',
    '/PurchaseOrder/LineItems/LineItem/Part[@Id="715515009058"]/@Quantity',
    25,
    '/PurchaseOrder/LineItems/LineItem[Description/text() =
      "The Unbearable Lightness Of Being"]',
    XMLType('<LineItem ItemNumber="99">
      <Part Id="786936150421" Quantity="5" UnitPrice="29.95"/>
      <Description>The Rock</Description>
      </LineItem>'))
WHERE XMLEExists('$p/PurchaseOrder[Reference="SBELL-2002100912333601PDT]')
  PASSING OBJECT_VALUE AS "p");
```

```
SELECT XMLCast(XMLQuery('$p/PurchaseOrder/Requestor'
  PASSING po.OBJECT_VALUE AS "p" RETURNING CONTENT)
  AS VARCHAR2(30)) name,
  XMLQuery('$p/PurchaseOrder/LineItems'
```

```

        PASSING po.OBJECT_VALUE AS "p" RETURNING CONTENT) lineitems
FROM purchaseorder po
WHERE XMLExists('$p/PurchaseOrder[Reference="SBELL-2002100912333601PDT"]'
        PASSING po.OBJECT_VALUE AS "p");

```

NAME	LINEITEMS
Stephen G. King	<pre> <LineItems> <LineItem ItemNumber="1"> <Description>A Night to Remember</Description> <Part Id="715515009058" UnitPrice="39.95" Quantity="25"/> </LineItem> <LineItem ItemNumber="99"> <Part Id="786936150421" Quantity="5" UnitPrice="29.95"/> <Description>The Rock</Description> </LineItem> <LineItem ItemNumber="3"> <Description>Sisters</Description> <Part Id="715515011020" UnitPrice="29.95" Quantity="4"/> </LineItem> </LineItems> </pre>

C.3.1 Deprecated Oracle SQL Function UPDATEXML and NULL Values

Several considerations apply to using deprecated Oracle SQL function `updateXML` with `NULL` values.

- If you update an XML *element* to `NULL`, the attributes and children of the element are removed, and the element becomes empty. The type and namespace properties of the element are retained. See [Example C-4](#) (page C-12).
- If you update an *attribute* value to `NULL`, the value appears as the empty string. See [Example C-4](#) (page C-12).
- If you update the *text* node of an element to `NULL`, the content (text) of the element is removed. The element itself remains, but it is empty. See [Example C-5](#) (page C-13).

[Example C-4](#) (page C-12) updates all of the following to `NULL`:

- The `Description` element and the `Quantity` attribute of the `LineItem` element whose `Part` element has attribute `Id` value 715515009058.
- The `LineItem` element whose `Description` element has the content (text) "The Unbearable Lightness Of Being".

[Example C-5](#) (page C-13) updates the text node of a `Part` element whose `Description` attribute has value "A Night to Remember" to `NULL`. The XML data for this example corresponds to a different, revised purchase-order XML schema – see [Scenario for Copy-Based Evolution](#) (page 20-2). In that XML schema, `Description` is an attribute of the `Part` element, not a sibling element.

See Also:

[Example 3-26](#) (page 3-25)

Example C-4 NULL Updates with UPDATEXML (Deprecated) – Element and Attribute

```
SELECT XMLCast(XMLQuery('$p/PurchaseOrder/Requestor'
    PASSING po.OBJECT_VALUE AS "p" RETURNING CONTENT)
    AS VARCHAR2(30)) name,
    XMLQuery('$p/PurchaseOrder/LineItems'
    PASSING po.OBJECT_VALUE AS "p" RETURNING CONTENT) lineitems
FROM purchaseorder po
WHERE XMLExists('$p/PurchaseOrder[Reference="SBELL-2002100912333601PDT"]'
    PASSING po.OBJECT_VALUE AS "p");
```

NAME	LINEITEMS
Sarah J. Bell	<pre><LineItems> <LineItem ItemNumber="1"> <Description>A Night to Remember</Description> <Part Id="715515009058" UnitPrice="39.95" Quantity="2"/> </LineItem> <LineItem ItemNumber="2"> <Description>The Unbearable Lightness Of Being</Description> <Part Id="37429140222" UnitPrice="29.95" Quantity="2"/> </LineItem> <LineItem ItemNumber="3"> <Description>Sisters</Description> <Part Id="715515011020" UnitPrice="29.95" Quantity="4"/> </LineItem> </LineItems></pre>

```
UPDATE purchaseorder
SET OBJECT_VALUE =
  updateXML(
    OBJECT_VALUE,
    '/PurchaseOrder/LineItems/LineItem[Part/@Id="715515009058"]/Description', NULL,
    '/PurchaseOrder/LineItems/LineItem/Part[@Id="715515009058"]/@Quantity', NULL,
    '/PurchaseOrder/LineItems/LineItem[Description/text()=
      "The Unbearable Lightness Of Being"]', NULL)
WHERE XMLExists('$p/PurchaseOrder[Reference="SBELL-2002100912333601PDT"]'
    PASSING OBJECT_VALUE AS "p");
```

```
SELECT XMLCast(XMLQuery('$p/PurchaseOrder/Requestor'
    PASSING po.OBJECT_VALUE AS "p" RETURNING CONTENT)
    AS VARCHAR2(30)) name,
    XMLQuery('$p/PurchaseOrder/LineItems'
    PASSING po.OBJECT_VALUE AS "p" RETURNING CONTENT) lineitems
FROM purchaseorder po
WHERE XMLExists('$p/PurchaseOrder[Reference="SBELL-2002100912333601PDT"]'
    PASSING po.OBJECT_VALUE AS "p");
```

NAME	LINEITEMS
Sarah J. Bell	<pre><LineItems> <LineItem ItemNumber="1"> <Description/> <Part Id="715515009058" UnitPrice="39.95" Quantity=""/> </LineItem> <LineItem/> <LineItem ItemNumber="3"> <Description>Sisters</Description> <Part Id="715515011020" UnitPrice="29.95" Quantity="4"/> </LineItem> </LineItems></pre>

Example C-5 NULL Updates with UPDATEXML (Deprecated) – Text Node

```

SELECT XMLCast(XMLQuery('$p/PurchaseOrder/LineItems/LineItem/Part[@Description="A Night to Remember"]'
    PASSING po.OBJECT_VALUE AS "p" RETURNING CONTENT)
    AS VARCHAR2(128)) part
FROM purchaseorder po
WHERE XMLEExists('$p/PurchaseOrder[@Reference="SBELL-2003030912333601PDT"]'
    PASSING po.OBJECT_VALUE AS "p");

PART
----
<Part Description="A Night to Remember" UnitCost="39.95">715515009058</Part>

UPDATE purchaseorder
SET OBJECT_VALUE =
    updateXML(OBJECT_VALUE,
        '/PurchaseOrder/LineItems/LineItem/Part[@Description="A Night to Remember"]/text()', NULL)
WHERE XMLEExists('$p/PurchaseOrder[@Reference="SBELL-2003030912333601PDT"]'
    PASSING OBJECT_VALUE AS "p");

SELECT XMLCast(XMLQuery('$p/PurchaseOrder/LineItems/LineItem/Part[@Description="A Night to Remember"]'
    PASSING po.OBJECT_VALUE AS "p" RETURNING CONTENT)
    AS VARCHAR2(128)) part
FROM purchaseorder po
WHERE XMLEExists('$p/PurchaseOrder[@Reference="SBELL-2003030912333601PDT"]'
    PASSING po.OBJECT_VALUE AS "p");

PART
----
<Part Description="A Night to Remember" UnitCost="39.95"/>

```

C.3.2 Update of the Same XML Node More Than Once Using UPDATEXML (Deprecated)

You can update the same XML node more than once in an `updateXML` expression. The order of updates is determined by the order of the XPath expressions, in left-to-right order. Each successive update works on the result of the previous one.

For example, you can update both `/EMP [EMPNO=217]` and `/EMP [EMPNAME="Jane "] /EMPNO`, where the first XPath identifies the EMPNO node containing it as well.

C.3.3 Guidelines for DOM Fidelity When Using UPDATEXML (Deprecated)

Guidelines are presented for DOM fidelity when using Oracle SQL function `updateXML`.

- When DOM fidelity is preserved —

When you update an element to `NULL`, you make that element appear *empty* in its parent. When you update a text node inside an element to `NULL`, you *remove* the text node. When you update an attribute node to `NULL`, you make the attribute value the *empty* string.

An example of an empty element is `<myElem/>`. An example of an attribute with an empty-string value is `myAttr=" "`.
- When DOM fidelity is not preserved —

When you update a `complexType` element to `NULL`, you make it appear *empty* in its parent. When you update a SQL-inlined `simpleType` element to `NULL`, you make it *disappear* from its parent. Updating a text node to `NULL` is the same as setting the parent `simpleType` element to `NULL`.

Furthermore, text nodes can only appear inside `simpleType` elements when DOM fidelity is not preserved, since there is no positional descriptor with which to store mixed content. When you update an attribute node to `NULL`, you *remove* the attribute from the element.

- How to tell whether DOM fidelity is preserved —

You can determine whether or not DOM fidelity is preserved for particular parts of a given `XMLType` instance in a given XML schema by querying the XML schema metadata for attribute `maintainDOM`.

See Also:

- [Querying a Registered XML Schema to Obtain Annotations](#) (page 18-19) for an example of querying a schema to retrieve DOM fidelity values
 - [DOM Fidelity](#) (page 17-6)
-
-

C.4 Optimization of Deprecated Oracle SQL Functions that Modify XML Data

In most cases, the deprecated Oracle SQL functions that modify XML data materialize a copy of the entire input XML document in memory, then update the copy. However, functions `updateXML`, `insertChildXML`, `insertChildXMLbefore`, `insertChildXMLafter`, and `deleteXML` — that is, all *except* `insertXMLbefore`, `insertXMLafter`, and `appendChildXML` — are optimized for `XMLType UPDATE` operations.

For object-relational storage, if particular conditions are met, then the function call can be rewritten to update the object-relational columns directly with the values. For binary XML storage, data preceding the targeted update is not modified, and, if SecureFiles LOBs are used (the default behavior), then sliding inserts are used to update only the portions of the data that need changing.

See Also:

- [Overview of How To Use Oracle XML DB](#) (page 3-1) and [XPath Rewrite for Object-Relational Storage](#) (page 19-1) for information about the conditions for XPath rewrite
 - [Performance Tuning for XQuery](#) (page 5-40)
-
-

As an example with object-relational storage, the XPath argument to `updateXML` in [Example C-6](#) (page C-15) is processed by Oracle XML DB and rewritten into equivalent object-relational SQL code, as illustrated in [Example C-7](#) (page C-15).

Note:

The use of XMLDATA for DML is shown here only as an illustration of internal Oracle XML DB behavior. Do *not* use XMLDATA yourself for DML operations. You can use XMLDATA directly only for DDL operations, never for DML operations.

More generally, in your code, do not rely on the current mapping between the XML Schema object model and the SQL object model. This Oracle XML DB implementation mapping might change in the future.

Example C-6 XPath Expressions in UPDATEXML Expression

```
SET LONG 2000

--

SELECT XMLCast(XMLQuery('$p/PurchaseOrder/User'
PASSING po.OBJECT_VALUE AS "p" RETURNING CONTENT)
AS VARCHAR2(30))
FROM purchaseorder po
WHERE XMLEExists('$p/PurchaseOrder[Reference="SBELL-2002100912333601PDT"]'
PASSING po.OBJECT_VALUE AS "p");

XMLCAST(XMLQUERY('$P/PURCHASEO
-----
SBELL

UPDATE purchaseorder
SET OBJECT_VALUE = updateXML(OBJECT_VALUE, '/PurchaseOrder/User/text()', 'SVOLLMAN')
WHERE XMLEExists('$p/PurchaseOrder[Reference="SBELL-2002100912333601PDT"]'
PASSING OBJECT_VALUE AS "p");

SELECT XMLCast(XMLQuery('$p/PurchaseOrder/User'
PASSING po.OBJECT_VALUE AS "p" RETURNING CONTENT)
AS VARCHAR2(30))
FROM purchaseorder po
WHERE XMLEExists('$p/PurchaseOrder[Reference="SBELL-2002100912333601PDT"]'
PASSING po.OBJECT_VALUE AS "p");

XMLCAST(XMLQUERY('$P/PURCHASEO
-----
SVOLLMAN
```

Example C-7 Object Relational Equivalent of UPDATEXML Expression

```
SELECT XMLCast(XMLQuery('$p/PurchaseOrder/User'
PASSING po.OBJECT_VALUE AS "p" RETURNING CONTENT)
AS VARCHAR2(30))
FROM purchaseorder po
WHERE XMLEExists('$p/PurchaseOrder[Reference="SBELL-2002100912333601PDT"]'
PASSING po.OBJECT_VALUE AS "p");

XMLCAST(XMLQUERY('$P/PURCHASEO
-----
SBELL

UPDATE purchaseorder p
SET p."XMLDATA"."USERID" = 'SVOLLMAN'
WHERE p."XMLDATA"."REFERENCE" = 'SBELL-2002100912333601PDT';
```

```
SELECT XMLCast(XMLQuery('$p/PurchaseOrder/User'
                        PASSING po.OBJECT_VALUE AS "p" RETURNING CONTENT)
              AS VARCHAR2(30))
FROM purchaseorder po
WHERE XMLElementExists('$p/PurchaseOrder[Reference="SBELL-2002100912333601PDT"]'
                      PASSING po.OBJECT_VALUE AS "p");
```

```
XMLCAST(XMLQUERY('$P/PURCHASEO
-----
SVOLLMAN
```

C.5 Creating XML Views Using Deprecated Oracle SQL Functions that Modify XML Data

You can use the deprecated Oracle SQL functions that modify XML data (`updateXML`, `insertChildXML`, `insertChildXMLbefore`, `insertChildXMLafter`, `insertXMLbefore`, `insertXMLafter`, `appendChildXML`, and `deleteXML`) to create new views of XML data.

[Example C-8](#) (page C-16) creates a view of table `purchaseorder` using deprecated Oracle SQL function `updateXML`.

Example C-8 *Creating a View Using UPDATEXML (Deprecated)*

```
CREATE OR REPLACE VIEW purchaseorder_summary OF XMLType AS
SELECT updateXML(OBJECT_VALUE,
                '/PurchaseOrder/Actions', NULL,
                '/PurchaseOrder/ShippingInstructions', NULL,
                '/PurchaseOrder/LineItems', NULL) AS XML
FROM purchaseorder p;

SELECT OBJECT_VALUE FROM purchaseorder_summary
WHERE XMLElementExists('$p/PurchaseOrder[Reference="DAUSTIN-20021009123335811PDT"]'
                      PASSING OBJECT_VALUE AS "p");
```

```
OBJECT_VALUE
-----
<PurchaseOrder
  xmlns:xsi="http://www.w3.org/2001/XMLSchema-instance"
  xsi:noNamespaceSchemaLocation=
    "http://localhost:8080/source/schemas/poSource/xsd/purchaseOrder.xsd">
  <Reference>DAUSTIN-20021009123335811PDT</Reference>
  <Actions/>
  <Reject/>
  <Requestor>David L. Austin</Requestor>
  <User>DAUSTIN</User>
  <CostCenter>S30</CostCenter>
  <ShippingInstructions/>
  <SpecialInstructions>Courier</SpecialInstructions>
  <LineItems/>
</PurchaseOrder>
```

C.6 INSERTCHILDXML Deprecated Oracle SQL Function

Deprecated Oracle SQL function `insertChildXML` inserts new children (one or more elements of the same type or a single attribute) under parent XML elements. The XML document that is the target of the insertion can be XML Schema-based or non-schema-based.

A *copy* of the input XMLType instance is modified and returned. The original data is unaffected. You can then use the returned data with SQL operation UPDATE to modify database data.

Function insertChildXML has the following parameters (in order):

- **target-data** (XMLType) – The XML data containing the target parent element.
- **parent-xpath** (VARCHAR2) – An XPath 1.0 expression that locates the parent elements within *target-data*. The *child-data* is inserted under *each* parent element.
 If *parent-xpath* matches an empty sequence of element nodes, then no insertion is done, and *target-data* is returned unchanged (no error is raised). If *parent-xpath* does not match a sequence of element nodes (in particular, if *parent-xpath* matches one or more *attribute* or *text* nodes), then an error is raised.
- **child-name** (VARCHAR2) – The name of the child elements or attribute to insert. An attribute name is distinguished from an element name by having an at-sign (@) prefix as part of *child-name*, for example, @my_attribute versus my_element. (The at-sign is not part of the attribute name, but serves in the argument to indicate that *child-name* refers to an attribute.)
- **child-data** (XMLType or VARCHAR2) – The child XML data to insert:
 - If one or more *elements* are being inserted, then this is of data type XMLType, and it contains element nodes. *Each* of the top-level element nodes in *child-data* must have the same name (tag) as *child-name* (or else an error is raised).
 - If an *attribute* is being inserted, then this is of data type VARCHAR2, and it represents the (scalar) attribute value. If an attribute of the same name already exists at the insertion location, then an error is raised.
- **namespace** (VARCHAR2, optional) – The XML namespace for parameters *parent-xpath* and *child-data*.

XML data *child-data* is inserted as one or more child elements, or a single child attribute, under *each* of the parent elements located at *parent-xpath*.

In order of decreasing precedence, function insertChildXML has the following behavior for NULL arguments:

- If *child-name* is NULL, then an error is raised.
- If *target-data* or *parent-xpath* is NULL, then NULL is returned.
- If *child-data* is NULL, then:
 - If *child-name* names an element, then no insertion is done, and *target-data* is returned unchanged.
 - If *child-name* names an attribute, then an empty attribute value is inserted, for example, my_attribute = "".

Figure C-2 (page C-18) shows the syntax.

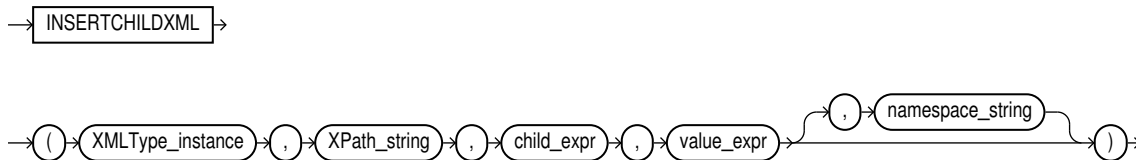
Figure C-2 INSERTCHILDXML Syntax

If *target-data* is XML *schema-based*, then the schema is consulted to determine the insertion positions. For example, if the schema constrains child elements named *child-name* to be the first child elements of a *parent-xpath*, then the insertion takes this into account. Similarly, if the *child-name* or *child-data* argument is inappropriate for an associated schema, then an error is raised.

If the parent element does *not* yet have a child corresponding in name and kind to *child-name* (and if such a child is permitted by the associated XML schema, if any), then *child-data* is inserted as new child elements, or a new attribute value, named *child-name*.

If the parent element already has a child *attribute* named *child-name* (without the at-sign), then an error is raised. If the parent element already has a child *element* named *child-name* (and if more than one child element is permitted by the associated XML schema, if any), then *child-data* is inserted so that its elements become child elements named *child-name*, but their positions in the sequence of children are unpredictable.

If you need to insert elements into an existing, non-empty collection of child elements, and the order is important to you, then use SQL/XML function `appendChildXML` or `insertXMLbefore`.

[Example C-9](#) (page C-18) shows how to use a SQL UPDATE statement and Oracle SQL function `insertChildXML` to insert a new `LineItem` element as a child of element `LineItems`.

If the XML data to be updated is XML schema-based and it refers to a namespace, then the data to be inserted must also refer to the same namespace. Otherwise, an error is raised because the inserted data does not conform to the XML schema.

[Example C-10](#) (page C-19) is the same as [Example C-9](#) (page C-18), except that the `LineItem` element to be inserted refers to a namespace. This assumes that the relevant XML schema requires a namespace for this element.

This use of namespaces is different from the use of a namespace *argument* to function `insertChildXML`. Namespaces supplied in that optional argument apply only to the XPath argument, not to the content to be inserted.

Example C-9 Insertion into a Collection Using INSERTCHILDXML (Deprecated)

```
SELECT XMLQuery('$p/PurchaseOrder/LineItems/LineItem[@ItemNumber=222]'
               PASSING po.OBJECT_VALUE AS "p" RETURNING CONTENT)
   FROM purchaseorder po
   WHERE XMLExists('$p/PurchaseOrder[Reference="AMCEWEN-20021009123336171PDT"]'
                  PASSING po.OBJECT_VALUE AS "p");

XMLQUERY('$P/PURCHASEORDER/LINEITEMS/LINEITEM[@ITEMNUMBER=222]')
-----
1 row selected.

UPDATE purchaseorder
   SET OBJECT_VALUE =
       insertChildXML(OBJECT_VALUE,
```

```

        '/PurchaseOrder/LineItems',
        'LineItem',
        XMLType('<LineItem ItemNumber="222">
                <Description>The Harder They Come</Description>
                <Part Id="953562951413"
                    UnitPrice="22.95"
                    Quantity="1"/>
                </LineItem>'))
WHERE XMLExists('$p/PurchaseOrder[Reference="AMCEWEN-20021009123336171PDT"]'
                PASSING OBJECT_VALUE AS "p");

SELECT XMLQuery('$p/PurchaseOrder/LineItems/LineItem[@ItemNumber=222]'
                PASSING po.OBJECT_VALUE AS "p" RETURNING CONTENT)
FROM purchaseorder po
WHERE XMLExists('$p/PurchaseOrder[Reference="AMCEWEN-20021009123336171PDT"]'
                PASSING po.OBJECT_VALUE AS "p");

XMLQUERY('$P/PURCHASEORDER/LINEITEMS/LINEITEM[@ITEMNUMBER=222]')
-----
<LineItem ItemNumber="222">
  <Description>The Harder They Come</Description>
  <Part Id="953562951413" UnitPrice="22.95" Quantity="1"/>
</LineItem>

1 row selected.

```

Example C-10 Inserting an Element that Uses a Namespace

```

UPDATE purchaseorder
SET OBJECT_VALUE =
    insertChildXML(OBJECT_VALUE,
        '/PurchaseOrder/LineItems',
        'LineItem',
        XMLType('<LineItem xmlns="films.xsd" ItemNumber="222">
                <Description>The Harder They Come</Description>
                <Part Id="953562951413"
                    UnitPrice="22.95"
                    Quantity="1"/>
                </LineItem>'))
WHERE XMLExists('$p/PurchaseOrder[Reference="AMCEWEN-20021009123336171PDT"]'
                PASSING OBJECT_VALUE AS "p");

```

C.7 INSERTCHILDXMLBEFORE Deprecated Oracle SQL Function

Deprecated Oracle SQL function `insertChildXMLbefore` inserts one or more collection elements as children of target parent elements. The insertion for each target occurs immediately before a specified existing collection element. The existing XML document that is the target of the insertion can be XML Schema-based or non-schema-based.

A *copy* of the input XMLType instance is modified and returned. The original data is unaffected. You can then use the returned data with SQL operation UPDATE to modify database data.

Function `insertChildXMLbefore` has the following parameters (in order):

- **target-data** (XMLType) – The XML data that is the target of the insertion.
- **parent-xpath** (VARCHAR2) – An XPath 1.0 expression that locates the parent elements within *target-data*. The *child-data* is inserted under *each* parent element.

If *parent-xpath* matches an empty sequence of element nodes, then no insertion is done, and *target-data* is returned unchanged (no error is raised). If *parent-xpath* does not match a sequence of element nodes (in particular, if *parent-xpath* matches one or more *attribute* or *text* nodes), then an error is raised.

- **child-xpath** (VARCHAR2) – A relative XPath 1.0 expression that locates the existing child that will become the successor of the inserted *child-data*. It must name a child element of the element indicated by *parent-xpath*, and it can include a predicate.
- **child-data** (XMLType) – The child element XML data to insert. This is of data type XMLType, and it contains element nodes. Each of the top-level element nodes in *child-data* must have the same data type as the element indicated by *child-xpath* (or else an error is raised).
- **namespace** (optional, VARCHAR2) – The namespace for parameters *parent-xpath*, *child-xpath*, and *child-data*.

XML data *child-data* is inserted as one or more child elements under *each* of the parent elements located at *parent-xpath*.

In order of decreasing precedence, function insertChildXMLbefore has the following behavior for NULL arguments:

- If *child-xpath* is NULL, then an error is raised.
- If *target-data* or *parent-xpath* is NULL, then NULL is returned.
- If *child-data* is NULL, then no insertion is done, and *target-data* is returned unchanged.

Figure C-3 (page C-20) shows the syntax.

Figure C-3 INSERTCHILDXMLBEFORE Syntax

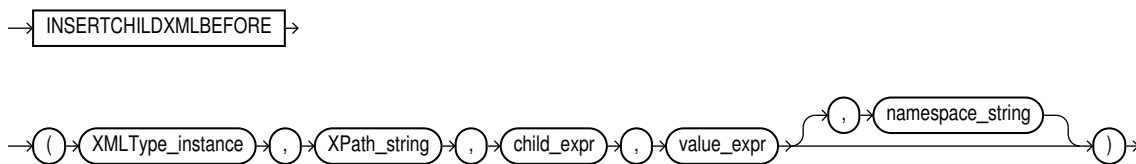

C.8 INSERTCHILDXMLAFTER Deprecated Oracle SQL Function

Deprecated Oracle SQL function insertChildXMLafter inserts one or more collection elements as children of target parent elements. The insertion for each target occurs immediately after a specified existing collection element. The existing XML document that is the target of the insertion can be XML Schema-based or non-schema-based.

A copy of the input XMLType instance is modified and returned. The original data is unaffected. You can then use the returned data with SQL operation UPDATE to modify database data.

Function insertChildXMLafter has the following parameters (in order):

- **target-data** (XMLType) – The XML data that is the target of the insertion.
- **parent-xpath** (VARCHAR2) – An XPath 1.0 expression that locates the parent elements within *target-data*. The *child-data* is inserted under *each* parent element.

If *parent-xpath* matches an empty sequence of element nodes, then no insertion is done, and *target-data* is returned unchanged (no error is raised). If *parent-xpath* does not match a sequence of element nodes (in particular, if *parent-xpath* matches one or more *attribute* or *text* nodes), then an error is raised.

- ***child-xpath*** (VARCHAR2) – A relative XPath 1.0 expression that locates the existing child that will become the predecessor of the inserted *child-data*. It must name a child element of the element indicated by *parent-xpath*, and it can include a predicate.
- ***child-data*** (XMLType) – The child element XML data to insert. This is of data type XMLType, and it contains element nodes. *Each* of the top-level element nodes in *child-data* must have the same data type as the element indicated by *child-xpath* (or else an error is raised).
- ***namespace*** (optional, VARCHAR2) – The namespace for parameters *parent-xpath*, *child-xpath*, and *child-data*.

XML data *child-data* is inserted as one or more child elements under *each* of the parent elements located at *parent-xpath*.

In order of decreasing precedence, function `insertChildXMLafter` has the following behavior for NULL arguments:

- If *child-xpath* is NULL, then an error is raised.
- If *target-data* or *parent-xpath* is NULL, then NULL is returned.
- If *child-data* is NULL, then no insertion is done, and *target-data* is returned unchanged.

Figure C-4 (page C-21) shows the syntax.

Figure C-4 INSERTCHILDXMLAFTER Syntax

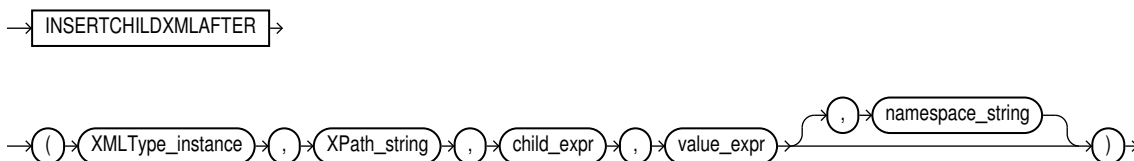

C.9 INSERTXMLBEFORE Deprecated Oracle SQL Function

Deprecated Oracle SQL function `insertXMLbefore` inserts one or more nodes of any kind immediately before a target node that is not an attribute node. The XML document that is the target of the insertion can be XML Schema-based or non-schema-based.

A *copy* of the input XMLType instance is modified and returned. The original data is unaffected. You can then use the returned data with SQL operation UPDATE to modify database data.

Function `insertXMLbefore` has the following parameters (in order):

- ***target-data*** (XMLType) – The XML data that is the target of the insertion.
- ***successor-xpath*** (VARCHAR2) – An XPath 1.0 expression that locates zero or more nodes in *target-data* of any kind *except* attribute nodes. *XML-data* is inserted immediately before *each* of these nodes. Thus, the nodes in *XML-data* become preceding siblings of each of the *successor-xpath* nodes.

If *successor-xpath* matches an empty sequence of nodes, then no insertion is done, and *target-data* is returned unchanged (no error is raised). If *successor-xpath* does not match a sequence of nodes that are not attribute nodes, then an error is raised.

- **XML-data** (XMLType) – The XML data to be inserted: one or more nodes of *any kind*. The order of the nodes is preserved after the insertion.
- **namespace** (optional, VARCHAR2) – The namespace for parameter *successor-xpath*.

The *XML-data* nodes are inserted immediately before *each* of the non-attribute nodes located at *successor-xpath*.

Function `insertXMLbefore` has the following behavior for NULL arguments:

- If *target-data* or *parent-xpath* is NULL, then NULL is returned.
- Otherwise, if *child-data* is NULL, then no insertion is done, and *target-data* is returned unchanged.

Figure C-5 (page C-22) shows the syntax.

Figure C-5 INSERTXMLBEFORE Syntax

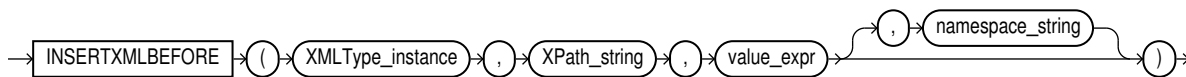

Example C-11 (page C-22) uses deprecated Oracle SQL function `insertXMLbefore` to insert a `LineItem` element before the first `LineItem` element.

Note:

Queries that use Oracle SQL function `insertXMLbefore` are *not* optimized. For this reason, Oracle recommends that you use function `insertChildXML`, `insertChildXMLbefore`, or `insertChildXMLafter` instead. See "[Performance Tuning for XQuery](#) (page 5-40)".

Example C-11 Insertion Before an Element Using INSERTXMLBEFORE (Deprecated)

```
SELECT XMLQuery('$p/PurchaseOrder/LineItems/LineItem[1]'
                PASSING po.OBJECT_VALUE AS "p" RETURNING CONTENT)
FROM purchaseorder po
WHERE XMLExists('$p/PurchaseOrder[Reference="AMCEWEN-20021009123336171PDT"]'
                PASSING po.OBJECT_VALUE AS "p");

XMLQUERY('$P/PURCHASEORDER/LINEITEMS/LINEITEM[1]' PASSINGPO.OBJECT_
-----
<LineItem ItemNumber="1">
  <Description>Salesman</Description>
  <Part Id="37429158920" UnitPrice="39.95" Quantity="2"/>
</LineItem>

UPDATE purchaseorder
SET OBJECT_VALUE =
  insertXMLbefore(OBJECT_VALUE,
                  '/PurchaseOrder/LineItems/LineItem[1]',
                  XMLType('<LineItem ItemNumber="314">
```

```

        <Description>Brazil</Description>
        <Part Id="314159265359"
          UnitPrice="69.95"
          Quantity="2"/>
      </LineItem>' )
WHERE XMLExists('$p/PurchaseOrder[Reference="AMCEWEN-20021009123336171PDT"]'
  PASSING OBJECT_VALUE AS "p");

SELECT XMLQuery('$p/PurchaseOrder/LineItems/LineItem[position() <= 2]'
  PASSING po.OBJECT_VALUE AS "p" RETURNING CONTENT)
FROM purchaseorder po
WHERE XMLExists('$p/PurchaseOrder[Reference="AMCEWEN-20021009123336171PDT"]'
  PASSING po.OBJECT_VALUE AS "p");

XMLQUERY('$P/PURCHASEORDER/LINEITEMS/LINEITEM[POSITION()<=2]' PASSINGPO.OBJECT_
-----
<LineItem ItemNumber="314">
  <Description>Brazil</Description>
  <Part Id="314159265359" UnitPrice="69.95" Quantity="2"/>
</LineItem>
<LineItem ItemNumber="1">
  <Description>Salesman</Description>
  <Part Id="37429158920" UnitPrice="39.95" Quantity="2"/>
</LineItem>

```

C.10 INSERTXMLAFTER Deprecated Oracle SQL Function

Deprecated Oracle SQL function `insertXMLafter` inserts one or more nodes of any kind immediately after a target node that is not an attribute node. The XML document that is the target of the insertion can be XML Schema-based or non-schema-based.

Function `insertXMLafter` is thus similar to `insertXMLbefore`, but it inserts after, not before, the target node.

A *copy* of the input `XMLType` instance is modified and returned. The original data is unaffected. You can then use the returned data with SQL operation `UPDATE` to modify database data.

Function `insertXMLafter` has the following parameters (in order):

- **target-data** (`XMLType`) – The XML data that is the target of the insertion.
- **successor-xpath** (`VARCHAR2`) – An XPath 1.0 expression that locates zero or more nodes in *target-data* of any kind *except* attribute nodes. *XML-data* is inserted immediately after *each* of these nodes. Thus, the nodes in *XML-data* become succeeding siblings of each of the *successor-xpath* nodes.
If *successor-xpath* matches an empty sequence of nodes, then no insertion is done, and *target-data* is returned unchanged (no error is raised). If *successor-xpath* does not match a sequence of nodes that are not attribute nodes, then an error is raised.
- **XML-data** (`XMLType`) – The XML data to be inserted: one or more nodes of *any kind*. The order of the nodes is preserved after the insertion.
- **namespace** (*optional*, `VARCHAR2`) – The namespace for parameter *successor-xpath*.

The *XML-data* nodes are inserted immediately after *each* of the non-attribute nodes located at *successor-xpath*.

Function `insertXMLafter` has the following behavior for `NULL` arguments:

- If *target-data* or *parent-xpath* is NULL, then NULL is returned.
- Otherwise, if *child-data* is NULL, then no insertion is done, and *target-data* is returned unchanged.

Figure C-6 (page C-24) shows the syntax.

Figure C-6 INSERTXMLAFTER Syntax

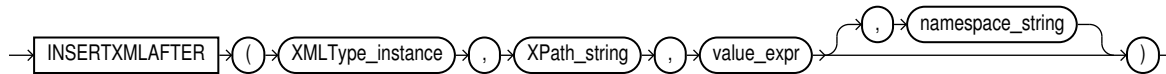

Note:

Queries that use Oracle SQL function `insertXMLafter` are *not* optimized. For this reason, Oracle recommends that you use function `insertChildXML`, `insertChildXMLbefore`, or `insertChildXMLafter` instead. See [Performance Tuning for XQuery](#) (page 5-40).

C.11 APPENDCHILDXML Deprecated Oracle SQL Function

Deprecated Oracle SQL function `appendChildXML` inserts one or more nodes of any kind as the last children of a given element node. The XML document that is the target of the insertion can be XML Schema-based or non-schema-based.

A *copy* of the input XMLType instance is modified and returned. The original data is unaffected. You can then use the returned data with SQL operation UPDATE to modify database data.

Function `appendChildXML` has the following parameters (in order):

- **target-data** (XMLType) – The XML data containing the target parent element.
- **parent-xpath** (VARCHAR2) – An XPath 1.0 expression that locates zero or more *element* nodes in *target-data* that are the targets of the insertion operation. The *child-data* is inserted as the last child or children of *each* of these parent elements.
If *parent-xpath* matches an empty sequence of element nodes, then no insertion is done, and *target-data* is returned unchanged (no error is raised). If *parent-xpath* does not match a sequence of element nodes (in particular, if *parent-xpath* matches one or more *attribute* or *text* nodes), then an error is raised.
- **child-data** (XMLType) – Child data to be inserted: one or more nodes of *any kind*. The order of the nodes is preserved after the insertion.
- **namespace** (optional, VARCHAR2) – The namespace for parameter *parent-xpath*.

XML data *child-data* is inserted as the last child or children of *each* of the element nodes indicated by *parent-xpath*.

Function `appendChildXML` has the following behavior for NULL arguments:

- If *target-data* or *parent-xpath* is NULL, then NULL is returned.
- Otherwise, if *child-data* is NULL, then no insertion is done, and *target-data* is returned unchanged.

Figure C-7 (page C-25) shows the syntax.

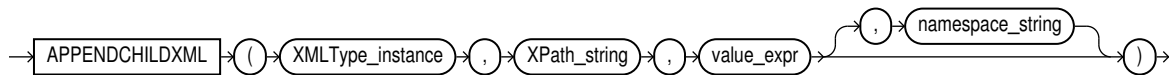
Figure C-7 APPENDCHILDXML Syntax

Example C-12 (page C-25) uses deprecated Oracle SQL function `appendChildXML` to insert a `Date` element as the last child of an `Action` element.

Note:

Queries that use Oracle SQL function `appendChildXML` are *not* optimized. For this reason, Oracle recommends that you use function `insertChildXML`, `insertChildXMLbefore`, or `insertChildXMLafter` instead. See [Performance Tuning for XQuery](#) (page 5-40).

Example C-12 Insertion as the Last Child Using APPENDCHILDXML (Deprecated)

```

SELECT XMLQuery('$p/PurchaseOrder/Actions/Action[1]'
                PASSING po.OBJECT_VALUE AS "p" RETURNING CONTENT)
FROM purchaseorder po
WHERE XMLEExists('$p/PurchaseOrder[Reference="AMCEWEN-20021009123336171PDT]"
                PASSING po.OBJECT_VALUE AS "p");

XMLQUERY('$P/PURCHASEORDER/ACTIONS/ACTION[1]' PASSING PO.OBJECT_VALUE
-----)
<Action>
  <User>KPARTNER</User>
</Action>

UPDATE purchaseorder
SET OBJECT_VALUE =
  appendChildXML(OBJECT_VALUE,
                 'PurchaseOrder/Actions/Action[1]',
                 XMLType('<Date>2002-11-04</Date>'))
WHERE XMLEExists('$p/PurchaseOrder[Reference="AMCEWEN-20021009123336171PDT]"
                PASSING OBJECT_VALUE AS "p");

SELECT XMLQuery('$p/PurchaseOrder/Actions/Action[1]'
                PASSING po.OBJECT_VALUE AS "p" RETURNING CONTENT)
FROM purchaseorder po
WHERE XMLEExists('$p/PurchaseOrder[Reference="AMCEWEN-20021009123336171PDT]"
                PASSING po.OBJECT_VALUE AS "p");

XMLQUERY('$P/PURCHASEORDER/ACTIONS/ACTION[1]' PASSING PO.OBJECT_VALUE
-----)
<Action>
  <User>KPARTNER</User>
  <Date>2002-11-04</Date>
</Action>

```

C.12 DELETXML Deprecated Oracle SQL Function

Deprecated Oracle SQL function `deleteXML` deletes XML nodes of any kind. The XML document that is the target of the deletion can be XML Schema-based or non-schema-based.

A *copy* of the input `XMLType` instance is modified and returned. The original data is unaffected. You can then use the returned data with SQL operation `UPDATE` to modify database data.

Function `deleteXML` has the following parameters (in order):

- **target-data** (XMLType) – The XML data containing the target nodes (to be deleted).
- **xpath** (VARCHAR2) – An XPath 1.0 expression that locates zero or more nodes in *target-data* that are the targets of the deletion operation. *Each* of these nodes is deleted.

If *xpath* matches an empty sequence of nodes, then no deletion is done, and *target-data* is returned unchanged (no error is raised). If *xpath* matches the top-level element node, then an error is raised.

- **namespace** (optional, VARCHAR2) – The namespace for parameter *xpath*.

The XML nodes located at *xpath* are deleted from *target-data*. Function `deleteXML` returns NULL if *target-data* or *xpath* is NULL.

Figure C-8 (page C-26) shows the syntax.

Figure C-8 DELETXML Syntax



Example C-13 (page C-26) uses deprecated Oracle SQL function `deleteXML` to delete the `LineItem` element whose `ItemNumber` attribute has value 222.

Example C-13 Deletion of an Element Using DELETXML (Deprecated)

```

SELECT XMLQuery('$p/PurchaseOrder/LineItems/LineItem[@ItemNumber=222]'
  PASSING po.OBJECT_VALUE AS "p" RETURNING CONTENT)
  FROM purchaseorder po
  WHERE XMLExists('$p/PurchaseOrder[Reference="AMCEWEN-20021009123336171PDT"]'
    PASSING po.OBJECT_VALUE AS "p");
  
```

```

XMLQUERY('$P/PURCHASEORDER/LINEITEMS/LINEITEM[@ITEMNUMBER=222]' PASSINGPO
-----
<LineItem ItemNumber="222">
  <Description>The Harder They Come</Description>
  <Part Id="953562951413" UnitPrice="22.95" Quantity="1"/>
</LineItem>
  
```

```

UPDATE purchaseorder
  SET OBJECT_VALUE =
    deleteXML(OBJECT_VALUE,
      '/PurchaseOrder/LineItems/LineItem[@ItemNumber="222"]')
  WHERE XMLExists('$p/PurchaseOrder[Reference="AMCEWEN-20021009123336171PDT"]'
    PASSING OBJECT_VALUE AS "p");
  
```

```

SELECT XMLQuery('$p/PurchaseOrder/LineItems/LineItem[@ItemNumber=222]'
  PASSING po.OBJECT_VALUE AS "p" RETURNING CONTENT)
  FROM purchaseorder po
  WHERE XMLExists('$p/PurchaseOrder[Reference="AMCEWEN-20021009123336171PDT"]'
    PASSING po.OBJECT_VALUE AS "p");
  
```

```

XMLQUERY('$P/PURCHASEORDER/LINEITEMS/LINEITEM[@ITEMNUMBER=222]' PASSINGPO
-----
  
```

1 row selected.

Deprecated Constructs for XML Translation

Oracle constructs that support XML translation are described. They are *deprecated* starting with Oracle Database 12c Release 1 (12.1.0.1).

- [XML Translations \(Deprecated\)](#) (page D-1)
- [PL/SQL Package DBMS_XMLTRANSLATIONS \(Deprecated\)](#) (page D-12)

D.1 XML Translations (Deprecated)

You can use the deprecated Oracle support for XML translation to translate strings contained in `XMLType` documents in Oracle XML DB Repository into various (natural) languages.

You can store XML documents in Oracle XML DB Repository as `XMLType` instances. These documents sometimes contain strings that must be translated into various (natural) languages. To use the deprecated Oracle XML translation support, you store both the original strings and their translations in the repository. You can then retrieve and operate on these strings, depending on your language settings.

Note:

XML schemas stored object-rationally are not translatable.

D.1.1 Changes to an XML Schema and XML Instance Documents for Translation (Deprecated)

You must make certain changes to an XML schema and any associated XML instance documents, to make the documents translatable.

D.1.1.1 Indication of Translatable Elements in an XML Schema (Deprecated)

Attribute `xdb:translate` must be specified in an XML schema for each element that is to be translated. Some restrictions apply to attribute `xdb:translate`. During XML schema registration, PL/SQL procedure `DBMS_XMLSCHEMA.registerSchema` checks whether the XML schema satisfies these restrictions.

- Attribute `xdb:translate` can be specified only on `complexType` elements that have `simpleContent`. Here, `simpleContent` must be an extension or a restriction of type `string`. However, if a `complexType` element has the `xdb:translate` flag set, then none of its descendants can have this flag set.
- Attribute `xdb:translate` can be set only on a single-valued element, which has exactly one translation. For such an element, the value of `xdb:maxOccurs` must be 0 or 1. If you want to set this attribute on a multiple-valued element, the element must have an `ID` attribute, which uniquely identifies the element.

D.1.1.2 Indication of Translation Language Attributes in an XML Instance Document (Deprecated)

Support for translation language attributes `xml:lang` and `xdb:srcLang` is described.

- `xml:lang`: For an instance document associated with an XML schema that supports translations, you must specify the translation language. You can do this by annotating each translation with attribute `xml:lang`. The allowed values of the `xml:lang` attribute are the language identifiers identified by IETF RFC 3066.
- `xdb:srcLang`: For multiple-valued elements, that is, elements that can have multiple translations, only one translation can be used as the source language translation. That translation is specified by attribute `xdb:srcLang`. This is the default translation, which is returned when the session language is not specified.

D.1.2 Making XML Documents Translatable (Deprecated)

You can use deprecated translation-specifying XML Schema attributes to make elements in a sample document translatable.

[Example D-1](#) (page D-2) shows an XML schema that defines documents that contain a title string that needs to be translatable.

[Example D-2](#) (page D-4) shows a document that is associated with the XML schema of [Example D-1](#) (page D-2).

To make the top-level title translatable, set `xdb:translate` to `true`. This is a single-valued element (`xdb:maxOccurs` is 1). [Example D-3](#) (page D-4) shows the new XML schema, where attribute `xdb:translate` is `true`.

[Example D-4](#) (page D-6) shows an instance document after translation of the title text.

To make the title translatable in the case of a multi-valued element, you would set `xdb:maxOccurs` to `unbounded`. However, `xdb:translate` cannot be set to `true` for a multiple-valued element, unless there is an identifier attribute that uniquely identifies each element. [Example D-5](#) (page D-6) shows an XML schema that uses an identifier attribute `id` for the `title` element.

[Example D-6](#) (page D-8) shows a document associated with the XML schema in [Example D-5](#) (page D-6).

Example D-1 XML Schema Defining Documents with a Title To Be Translated

```
<schema xmlns="http://www.w3.org/2001/XMLSchema"
  xmlns:xdb="http://xmlns.oracle.com/xdb/security.xsd"
  xmlns:xdb="http://xmlns.oracle.com/xdb.xsd"
  targetNamespace="http://xmlns.oracle.com/xdb/security.xsd"
  elementFormDefault="qualified" version="1.0">
  <annotation>
    <documentation>
This XML schema describes the structure of Security Class documents.
    </documentation>
  </annotation>
  <element name="securityClass" xdb:defaultTable="">
    <complexType>
      <sequence>
        <element name="name" type="string"/>
        <element name="title" minOccurs="0" maxOccurs="unbounded"/>
        <element name="inherits-from" type="QName" minOccurs="0" maxOccurs="unbounded"/>
      </sequence>
    </complexType>
  </element>
</schema>
```



```

<element name="privlist" minOccurs="0" maxOccurs="unbounded">
  <complexType>
    <choice minOccurs="0" maxOccurs="unbounded">
      <element ref="xdbsc:privilege"/>
      <element ref="xdbsc:aggregatePrivilege"/>
    </choice>
  </complexType>
</element>
<!-- this "any" contains all application specific information
      for a security class in general e.g. reason for creation -->
<any namespace="##other" minOccurs="0" maxOccurs="unbounded"/>
</sequence>
<attribute name="targetNamespace" type="anyURI" use="required"/>
<!-- all privileges in this security class are under this target namespace -->
</complexType>
</element>
<element name="aggregatePrivilege">
  <complexType>
    <sequence>
      <element name="title" minOccurs="0" maxOccurs="unbounded"/>
      <sequence maxOccurs="unbounded">
        <element name="privilegeRef">
          <complexType>
            <attribute name="name" type="QName" use="required"/>
          </complexType>
        </element>
        <any namespace="##other" minOccurs="0" maxOccurs="unbounded"/>
      </sequence>
      <!-- this "any" contains all application specific information
            an aggregate privilege e.g. translations -->
      <any namespace="##other" minOccurs="0" maxOccurs="unbounded"/>
    </sequence>
    <attribute name="name" type="string" use="required"/>
  </complexType>
</element>
<element name="privilege">
  <complexType>
    <sequence minOccurs="0">
      <element name="title" minOccurs="0" maxOccurs="unbounded"/>
      <sequence minOccurs="0" maxOccurs="unbounded">
        <element name="columnRef">
          <complexType>
            <attribute name="schema" type="string" use="required"/>
            <attribute name="table" type="string" use="required"/>
            <attribute name="column" type="string" use="required"/>
          </complexType>
        </element>
        <any namespace="##other" minOccurs="0" maxOccurs="unbounded"/>
      </sequence>
      <!-- this "any" contains all application specific information
            for a privilege e.g. translations -->
      <any namespace="##other" minOccurs="0" maxOccurs="unbounded"/>
    </sequence>
    <attribute name="name" type="string" use="required"/>
  </complexType>
</element>
</schema>

```

Example D-2 Untranslated Instance Document

```

<securityClass xmlns="http://xmlns.oracle.com/xdb/security.xsd"
  xmlns:is="xmlns.oracle.com/iStore"
  xmlns:oa="xmlns.oracle.com/OracleApps"
  targetNamespace="xmlns.oracle.com/example">
  <name>
  securityClassExample
  </name>
  <title>
Security Class Example
  </title>
  <inherits-from>is:iStorePurchaseOrder</inherits-from>
  <privlist>
  <privilege name="privilege1"/>
  <aggregatePrivilege name="iStorePOApprover">
    <title>
  iStore Purchase Order Approver
  </title>
    <privilegeRef name="is:privilege1"/>
    <privilegeRef name="oa:submitPO"/>
    <privilegeRef name="oa:privilege3"/>
  </aggregatePrivilege>
  <privilege name="privilege2">
    <title>
  secondary privilege
  </title>
    <columnRef schema="APPS" table="PurchaseOrder" column="POId"/>
    <columnRef schema="APPS" table="PurchaseOrder" column="Amount"/>
  </privilege>
  </privlist>
</securityClass>

```

Example D-3 XML Schema with Attribute xdb:translate for a Single-Valued Element

```

<schema xmlns="http://www.w3.org/2001/XMLSchema"
  xmlns:xdbsc="http://xmlns.oracle.com/xdb/security.xsd"
  xmlns:xdb="http://xmlns.oracle.com/xdb.xsd"
  targetNamespace="http://xmlns.oracle.com/xdb/security.xsd"
  elementFormDefault="qualified" version="1.0">
<xs:import namespace="http://www.w3.org/XML/1998/namespace"
  schemaLocation="http://www.w3.org/2001/xml.xsd"/>
<xs:import namespace="http://xmlns.oracle.com/xdb"
  schemaLocation="http://xmlns.oracle.com/xdb/xmltr.xsd"/>
  <annotation>
  <documentation>
  This XML schema describes the structure of Security Class documents.
  </documentation>
  </annotation>
  <element name="securityClass" xdb:defaultTable="">
  <complexType>
  <sequence>
  <element name="name" type="string"/>
  <element ref="titleref" minOccurs="0" maxOccurs="unbounded"
  xdb:maxOccurs="1" xdb:translate="true"/>
  <element name="inherits-from" type="QName" minOccurs="0" maxOccurs="unbounded"/>
  <element name="privlist" minOccurs="0" maxOccurs="unbounded" xdb:maxOccurs="1">
  <complexType>
  <choice minOccurs="0" maxOccurs="unbounded">
  <element ref="xdbsc:privilege"/>
  <element ref="xdbsc:aggregatePrivilege"/>
  </choice>
  </complexType>
  </sequence>
  </complexType>
</element>

```

```

        </complexType>
    </element>
    <!-- this "any" contains all application specific information
         for a security class in general e.g. reason for creation -->
    <any namespace="##other" minOccurs="0" maxOccurs="unbounded"/>
</sequence>
<attribute name="targetNamespace" type="anyURI" use="required"/>
<!-- all privileges in this security class are under this target namespace -->
</complexType>
</element>
<element name="aggregatePrivilege">
    <complexType>
        <sequence>
            <element name="title" minOccurs="0" maxOccurs="unbounded"/>
            <sequence maxOccurs="unbounded">
                <element name="privilegeRef">
                    <complexType>
                        <attribute name="name" type="QName" use="required"/>
                    </complexType>
                </element>
                <any namespace="##other" minOccurs="0" maxOccurs="unbounded"/>
            </sequence>
            <!-- this "any" contains all application specific information
                 an aggregate privilege e.g. translations -->
            <any namespace="##other" minOccurs="0" maxOccurs="unbounded"/>
        </sequence>
        <attribute name="name" type="string" use="required"/>
    </complexType>
</element>
<element name="privilege">
    <complexType>
        <sequence minOccurs="0">
            <element name="title" minOccurs="0" maxOccurs="unbounded"/>
            <sequence minOccurs="0" maxOccurs="unbounded">
                <element name="columnRef">
                    <complexType>
                        <attribute name="schema" type="string" use="required"/>
                        <attribute name="table" type="string" use="required"/>
                        <attribute name="column" type="string" use="required"/>
                    </complexType>
                </element>
                <any namespace="##other" minOccurs="0" maxOccurs="unbounded"/>
            </sequence>
            <!-- this "any" contains all application specific information
                 for a privilege e.g. translations -->
            <any namespace="##other" minOccurs="0" maxOccurs="unbounded"/>
        </sequence>
        <attribute name="name" type="string" use="required"/>
    </complexType>
</element>
<element name="titleref">
    <complexType>
        <simpleContent>
            <extension base="xs:string">
                <attribute ref="xml:lang"/>
                <attribute ref="xdb:srclang"/>
            </extension>
        </simpleContent>
    </complexType>
</element>
</schema>

```

Example D-4 Translated Document

```

<securityClass xmlns="http://xmlns.oracle.com/xdb/security.xsd"
               xmlns:is="xmlns.oracle.com/iStore"
               xmlns:oa="xmlns.oracle.com/OracleApps">
  <name>
    securityClassExample
  </name>
  <title xml:lang="en" xdb:srcLang="true">
Security Class Example
  </title>
  <title xml:lang="es">
Security Class Example - Spanish
  </title>
  <title xml:lang="fr">
Security Class Example - French
  </title>
  <inherits-from>is:iStorePurchaseOrder</inherits-from>
  <privlist>
    <privilege name="privilege1"/>
    <aggregatePrivilege name="iStorePOApprover">
      <title>
        iStore Purchase Order Approver
      </title>
      <privilegeRef name="is:privilege1"/>
      <privilegeRef name="oa:submitPO"/>
      <privilegeRef name="oa:privilege3"/>
    </aggregatePrivilege>
    <privilege name="privilege2">
      <title>
        secondary privilege
      </title>
      <columnRef schema="APPS" table="PurchaseOrder" column="POId"/>
      <columnRef schema="APPS" table="PurchaseOrder" column="Amount"/>
    </privilege>
  </privlist>
</securityClass>

```

Example D-5 XML Schema with Attribute xdb:translate for a Multi-Valued Element

```

<schema xmlns="http://www.w3.org/2001/XMLSchema"
         xmlns:xdbsc="http://xmlns.oracle.com/xdb/security.xsd"
         xmlns:xdb="http://xmlns.oracle.com/xdb.xsd"
         targetNamespace="http://xmlns.oracle.com/xdb/security.xsd"
         elementFormDefault="qualified" version="1.0">
  <xs:import namespace="http://www.w3.org/XML/1998/namespace"
             schemaLocation="http://www.w3.org/2001/xml.xsd"/>
  <xs:import namespace="http://xmlns.oracle.com/xdb"
             schemaLocation="http://xmlns.oracle.com/xdb/xmltr.xsd"/>
  <annotation>
    <documentation>
      This XML schema describes the structure of Security Class documents.
    </documentation>
  </annotation>
  <element name="securityClass" xdb:defaultTable="">
    <complexType>
      <sequence>
        <element name="name" type="string"/>
        <element name="title" minOccurs="0" maxOccurs="unbounded" xdb:maxOccurs="1"/>
        <element name="inherits-from" type="QName" minOccurs="0" maxOccurs="unbounded"/>
        <element name="privlist" minOccurs="0" maxOccurs="unbounded" xdb:maxOccurs="1">
          <complexType>

```

```

        <choice minOccurs="0" maxOccurs="unbounded">
            <element ref="xdbc:privilege"/>
            <element ref="xdbc:aggregatePrivilege"/>
        </choice>
    </complexType>
</element>
<!-- this "any" contains all application specific information
      for a security class in general e.g. reason for creation -->
    <any namespace="##other" minOccurs="0" maxOccurs="unbounded"/>
</sequence>
    <attribute name="targetNamespace" type="anyURI" use="required"/>
<!-- all privileges in this security class are under this target namespace -->
</complexType>
</element>
<element name="aggregatePrivilege">
    <complexType>
        <sequence>
            <element name="titleref" minOccurs="0" maxOccurs="unbounded"
                xdb:maxOccurs="unbounded" xdb:translate="true"/>
            <sequence maxOccurs="unbounded">
                <element name="privilegeRef">
                    <complexType>
                        <attribute name="name" type="QName" use="required"/>
                    </complexType>
                </element>
                <any namespace="##other" minOccurs="0" maxOccurs="unbounded"/>
            </sequence>
            <!-- this "any" contains all application specific information
                  an aggregate privilege e.g. translations -->
            <any namespace="##other" minOccurs="0" maxOccurs="unbounded"/>
        </sequence>
        <attribute name="name" type="string" use="required"/>
    </complexType>
</element>
<element name="privilege">
    <complexType>
        <sequence minOccurs="0">
            <element name="titleref" minOccurs="0" maxOccurs="unbounded"
                xdb:maxOccurs="unbounded" xdb:translate="true"/>
            <sequence minOccurs="0" maxOccurs="unbounded">
                <element name="columnRef">
                    <complexType>
                        <attribute name="schema" type="string" use="required"/>
                        <attribute name="table" type="string" use="required"/>
                        <attribute name="column" type="string" use="required"/>
                    </complexType>
                </element>
                <any namespace="##other" minOccurs="0" maxOccurs="unbounded"/>
            </sequence>
            <!-- this "any" contains all application specific information
                  for a privilege e.g. translations -->
            <any namespace="##other" minOccurs="0" maxOccurs="unbounded"/>
        </sequence>
        <attribute name="name" type="string" use="required"/>
    </complexType>
</element>
<element name="titleref">
    <complexType>
        <simpleContent>
            <extension base="xs:string">
                <attribute ref="xml:lang"/>
            </extension>
        </simpleContent>
    </complexType>

```

```

    <attribute ref="xdb:srcLang"/>
    <attribute name="id" type="integer"/>
  </extension>
</simpleContent>
</complexType>
</element>
</schema>

```

Example D-6 Translated Document for an XML Schema with Multiple-Valued Elements

```

<securityClass xmlns="http://xmlns.oracle.com/xdb/security.xsd"
  xmlns:is="xmlns.oracle.com/iStore"
  xmlns:oa="xmlns.oracle.com/OracleApps">
  <name>
securityClassExample
  </name>
  <title>
Security Class Example
  </title>
  <inherits-from>is:iStorePurchaseOrder</inherits-from>
  <privlist>
    <privilege name="privilege1"/>
    <aggregatePrivilege name="iStorePOApprover">
      <title>
iStore Purchase Order Approver
      </title>
      <privilegeRef name="is:privilege1"/>
      <privilegeRef name="oa:submitPO"/>
      <privilegeRef name="oa:privilege3"/>
    </aggregatePrivilege>
    <privilege name="privilege2">
      <title id="2" xml:lang="en" xdb:srcLang="true">
secondary privilege - english
      </title>
      <title id="1" xml:lang="fr">
primary privilege - french
      </title>
      <title id="1" xml:lang="en" xdb:srcLang="true">
primary privilege - english
      </title>
      <columnRef schema="APPS" table="PurchaseOrder" column="POId"/>
      <columnRef schema="APPS" table="PurchaseOrder" column="Amount"/>
    </privilege>
  </privlist>
</securityClass>

```

D.1.3 Operations on Translated Documents (Deprecated)

You can perform insert, query, and update operations on translated documents. Examples are shown of inserting a document with and without language information.

- **Insert:** You can insert a document into Oracle XML DB, if it conforms to an XML schema that supports translations. For the document that contains translations, you can either provide the language information or use the session language translation.
 - When the document does not contain the language information and the `xml:lang` attribute is not set, the session language is used for translation. [Example D-7](#) (page D-10) describes a document with a session language of

Japanese. Attribute `xml:lang` is set to `session language`, and attribute `xdb:srclang` is set to `true`.

[Example D-8](#) (page D-11) shows the document after it is inserted into Oracle XML DB Repository.

- When you provide the language information, you set attribute `xml:lang` by either explicitly marking a translation as `xdb:srclang=true` or using the session language translation in attribute `xdb:srclang`. If you do neither, then an arbitrary translation is picked, for which `xdb:srclang` is set to `true`.

[Example D-9](#) (page D-11) describes a document with a session language of Japanese.

[Example D-10](#) (page D-11) shows the document after it is inserted into Oracle XML DB Repository.

- Query: If you query nodes that involve translated elements, the query displays the translation's default behavior. In order to specify that the translation's default behavior should be applied to the query result, you need to use the Oracle XPath function `ora:translate`. This is the syntax of the function:

```
Nodeset ora:translate(Nodeset parent, String childname, String childnsp)
```

Parameter *parent* is the parent node under which you want to search for the translated nodes; *childname* is the name of the child node; and *childnsp* is the namespace URL of the child node.

Function `ora:translate` returns a positive integer when the name of the parent node matches the name of the specified child node, and the `xml:lang` value is same as the session language or the language for which `xdb:srclang` is `true`.

When SQL functions such as `XMLQuery` are applied to translated documents, they return the session language translation, if present, or the source language translation, otherwise. For example, this query returns the session language translation:

```
SELECT XMLQuery('$x/ora:translate(securityClass, "title")'
               PASSING x.OBJECT_VALUE AS "x" RETURNING CONTENT)
FROM some_table x;
```

This is the output of that query:

```
<title xml:lang="fr">
Security Class Example - FR
</title>
```

To obtain the result in a particular language, specify it in the XPath expression.

```
SELECT XMLQuery('$x/securityClass/title[@xml:lang="en"]'
               PASSING x.OBJECT_VALUE AS "x" RETURNING CONTENT)
FROM some_table x;
```

This is the output of that query:

```
<title xml:lang="en" xdb:srclang="true">
Security Class Example
</title>
```

Because you can store translated documents only as text (CLOB) or binary XML, only functional evaluation and queries with a function-based index, an `XMLIndex` index, or a `CONTEXT` index are possible. For `XMLIndex` index and `CONTEXT` index

queries, if the document has a session language translation, then that is returned, otherwise the source language translation is returned. However, for queries with a function-based index, you need to create an index with an explicit `xml:lang` predicate for every language for which you want to use the index.

When you retrieve the complete document using SQL function `XMLSerialize` and PL/SQL constructor `XDBURITYPE`, only the translations that match the session language translations are returned. For protocols, you can set your language preferences, and the document is returned in that language only.

The following PL/SQL procedures and functions support XML translations:

- `DBMS_XMLTRANSLATIONS.translateXML`: Translate a document to the specified language. If the specified language translation is present, it is returned, otherwise, the source language translation is returned.

For example, if you write `translateXML(doc, 'fr')` to specify French as the translation language for the [Example D-10](#) (page D-11), it returns the following code and ignores all other translations:

```
securityClass xmlns="http://xmlns.oracle.com/xdb/security.xsd"
              xmlns:is="xmlns.oracle.com/iStore"
              xmlns:oa="xmlns.oracle.com/OracleApps"
              targetNamespace="xmlns.oracle.com/example">
  <name>
    securityClassExample
  </name>
  <title xml:lang="fr">
    Security Class Example - FR
  </title>
  <inherits-from>is:iStorePurchaseOrder</inherits-from>
</securityClass>
```

- `DBMS_XMLTRANSLATIONS.enableTranslation`, `DBMS_XMLTRANSLATIONS.disableTranslation`: Enable or disable translations at the session level. Queries work on the base document if the translation is disabled and on the translated document if it is enabled.
- `DBMS_XMLTRANSLATIONS.getBaseDocument`: Returns the entire document, with all of the translations.
- **Update:** You can use Oracle SQL function `XMLQuery` together with `XQuery Update` to update the translated nodes. However, an error is raised if you try to update a translated node without specifying the translation language. The following PL/SQL procedures support update operations on translated documents:
 - `DBMS_XMLTRANSLATIONS.updateTranslation`: This function updates the translation at a specified `xpath` in a particular language. If the translation in a particular language is not present, then it is inserted.
 - `DBMS_XMLTRANSLATIONS.setSourceLang`: This procedure sets the source language at a specified `xpath` to the specified language.

Example D-7 Inserting a Document with No Language Information

```
<securityClass xmlns="http://xmlns.oracle.com/xdb/security.xsd"
              xmlns:is="xmlns.oracle.com/iStore"
              xmlns:oa="xmlns.oracle.com/OracleApps"
              targetNamespace="xmlns.oracle.com/example">
  <name>
    securityClassExample
```



```

    </name>
    <title>
Security Class Example
    </title>
    <inherits-from>is:iStorePurchaseOrder</inherits-from>
</securityClass>

```

Example D-8 Document After Insertion into the Repository

```

<securityClass xmlns="http://xmlns.oracle.com/xdb/security.xsd"
    xmlns:is="xmlns.oracle.com/iStore"
    xmlns:oa="xmlns.oracle.com/OracleApps"
    targetNamespace="xmlns.oracle.com/example">

    <name>
securityClassExample
    </name>
    <title xml:lang="jp" xdb:srclang="true">
Security Class Example
    </title>
    <inherits-from>is:iStorePurchaseOrder</inherits-from>
</securityClass>

```

Example D-9 Inserting a Document with Language Information

```

<securityClass xmlns="http://xmlns.oracle.com/xdb/security.xsd"
    xmlns:is="xmlns.oracle.com/iStore"
    xmlns:oa="xmlns.oracle.com/OracleApps"
    targetNamespace="xmlns.oracle.com/example">

    <name>
securityClassExample
    </name>
    <title xml:lang="en">
Security Class Example
    </title>
    <title xml:lang="fr">
Security Class Example - FR
    </title>
    <inherits-from>is:iStorePurchaseOrder</inherits-from>
</securityClass>

```

Example D-10 Document After Insertion

```

<securityClass xmlns="http://xmlns.oracle.com/xdb/security.xsd"
    xmlns:is="xmlns.oracle.com/iStore"
    xmlns:oa="xmlns.oracle.com/OracleApps"
    targetNamespace="xmlns.oracle.com/example">

    <name>
securityClassExample
    </name>
    <title xml:lang="en" xdb:srclang="true">
Security Class Example
    </title>
    <title xml:lang="fr">
Security Class Example - FR
    </title>
    <inherits-from>is:iStorePurchaseOrder</inherits-from>
</securityClass>

```

D.2 PL/SQL Package DBMS_XMLTRANSLATIONS (Deprecated)

Oracle XML DB provides translation support through the DBMS_XMLTRANSLATIONS package, which provides an interface to perform translations so that strings can be searched or displayed in various languages. This feature is deprecated.

See Also:

[XML Schema Storage and Query: Basic](#) (page 17-1) for an overview of XML translations

D.2.1 DBMS_XMLTRANSLATIONS Methods (Deprecated)

Deprecated PL/SQL package DBMS_XMLTRANSLATIONS provides the following methods: `updateTranslation`, `setSourceLang`, `translateXML`, `getBaseDocument`, `extractXLiff`, `mergeXLiff`, `disableTranslation`, and `enableTranslation`.

- `updateTranslation()`: Updates the translation in a particular language at the specified XPATH. If the translation in that language is not present, then it is inserted.
- `setSourceLang()`: Sets the source language to a particular language at the specified XPATH.
- `translateXML()`: Returns the document in the specified language.
- `getBaseDocument()`: Returns the base document with all the translations.
- `extractXLiff()`: Extracts the translations in XLIFF format from either an XMLTYPE instance or a resource in Oracle XML DB Repository.
- `mergeXLiff`: Merges the translations in XLIFF format into either an XMLTYPE or a resource in Oracle XML DB Repository.
- `disableTranslation`: Disables translations in the current session so that query or retrieval takes place on the base document, ignoring session language values.
- `enableTranslation`: Enables translations in the current session.

See Also:

Oracle Database PL/SQL Packages and Types Reference for a description of the individual DBMS_XMLTRANSLATIONS methods.

Deprecated Content Repository API for Java

Oracle XML DB Content Connector implements Content Repository API for Java (also known as JCR), a Java API standard developed by the Java community as JSR-170. You can access Oracle XML DB Repository using Oracle XML DB Content Connector.

Note:

Oracle XML DB Content Connector is *deprecated*, starting with Oracle Database 12c Release 2 (12.2.0.1). Java standard JSR-170 has been replaced by JSR-283 Content Repository for Java Technology Version 2.0.

- [About the Content Repository API for Java \(JCR\)](#) (page E-1)
- [About Oracle XML DB Content Connector](#) (page E-2)
- [How Oracle XML DB Repository Is Exposed in JCR](#) (page E-2)
- [CLASSPATH for Oracle XML DB Content Connector](#) (page E-3)
- [Obtaining the JCR Repository Object](#) (page E-3)
- [Java Code to Upload a File to the Repository using Oracle XML DB Content Connector](#) (page E-4)
- [Additional JCR Code Examples](#) (page E-5)
- [Oracle XML DB Content Connector Uses the Standard Java Logging API](#) (page E-5)
- [Supported JCR Compliance Levels](#) (page E-6)
- [Oracle XML DB Content Connector Restrictions](#) (page E-6)
- [XML Schemas and JCR](#) (page E-6)

E.1 About the Content Repository API for Java (JCR)

JCR 1.0 defines a standard Java API for applications to interact with content repositories. A content repository is a tree of nodes, each of which can have one or more child nodes. Each node has exactly one parent node, except for the root node, which has no parent.

In addition to child nodes, a node may also have one or more properties. A property is a simple name/value pair. For example, a node representing a particular file in the content repository has a property named `jcr:created` whose value is the date the file was created.

Each property has a property type. For example, the `jcr:created` property has the `DATE` property type, requiring its value to be a valid date/time.

Similarly, each node has a node type. For example, a node representing a file has node type `nt:file`. The node type controls what child nodes and properties the node may have or must have. For example, all nodes of type `nt:file` must have a `jcr:created` property.

Because nodes and properties are named, they can be addressed by path. JCR supports both absolute and relative paths. For example, the absolute path

```
/My Documents/pictures/puppy.jpg/jcr:created
```

resolves to the `jcr:created` property of file `puppy.jpg`. This property can also be addressed relative to the `My Documents` folder by the following relative path:

```
pictures/puppy.jpg/jcr:created
```

Node and property names can be namespace qualified. Like XML, JCR uses colon-delimited namespace prefixes to express namespace-qualified names, for example, `jcr:created`. Unlike XML, JCR records the namespace prefix-to-URI mappings in a repository-wide namespace registry, which, for example, maps the `jcr` prefix to the URI `http://www.jcp.org/jcr/1.0`.

See Also:

Java Community Process, "Content Repository for Java technology API", <http://jcp.org/en/jsr/detail?id=170>. Chapter 4 of the JSR-170 specification provides a concise introduction to JCR 1.0

E.2 About Oracle XML DB Content Connector

Oracle XML DB Content Connector lets you access Oracle XML DB Repository using JCR 1.0 Java. Your applications can run either in a standalone Java Virtual Machine (JVM) or a J2EE container. Files and folders in the repository are represented as JCR nodes (and properties of those nodes).

You can create, retrieve, and update repository files and folders using the JCR APIs.

Note:

Using Oracle XML DB Content Connector in the database Oracle JVM (the Java Virtual Machine available within a database process) is not supported. To use the content connector in the database tier, you must use either a standalone Java Virtual Machine or a J2EE container.

E.3 How Oracle XML DB Repository Is Exposed in JCR

Oracle XML DB Content Connector represents data in Oracle XML DB Repository as JCR nodes and properties. Files and folders are represented as nodes of type `nt:file` and `nt:folder`, respectively. Their content and metadata is exposed as nodes of node type `nt:resource`.

E.4 CLASSPATH for Oracle XML DB Content Connector

Oracle XML DB Content Connector requires certain entries in environment variable CLASSPATH.

- \$ORACLE_HOME/lib/jcr-1.0.jar
- \$ORACLE_HOME/lib/ojcr.jar
- \$ORACLE_HOME/lib/xmlparserv2.jar
- \$ORACLE_HOME/jlib/xquery.jar

E.5 Obtaining the JCR Repository Object

In Oracle XML DB Content Connector, `oracle.jcr.OracleRepository` implements JCR interface `javax.jcr.Repository`, which provides the entry point for a JCR repository. You can use it to obtain a `Repository` object for Oracle XML DB Repository.

The code fragment in [Example E-1](#) (page E-3) illustrates this.

`OracleRepository` implements both `java.io.Serializable` and `javax.naming.Referenceable`. This lets you create and configure an `OracleRepository` object upon application deployment, and store the ready-to-use `OracleRepository` object in a JNDI directory. At run-time, your application can retrieve the preconfigured `OracleRepository` object from the JNDI directory. This approach, recommended by the JCR specification, separates deployment and run-time concerns.

In Oracle XML DB Content Connector, the set of prefix-to-URI mappings forming the JCR namespace registry is stored as part of the `OracleRepository` configuration.

See Also:

Oracle Database XML Java API Reference, package `oracle.jcr`

Example E-1 Code Fragment Showing How to Get a Repository Object

```
import oracle.jcr.OracleRepository;
import oracle.jcr.OracleRepositoryFactory;
import oracle.jcr.xdb.XDBRepositoryConfiguration;
import oracle.jdbc.pool.OracleDataSource;
...
XDBRepositoryConfiguration configuration =
    new XDBRepositoryConfiguration();
OracleDataSource ods =
    (OracleDataSource)configuration.getDataSource();
// databaseURL is a JDBC database URL.
ods.setURL(databaseURL);
// OracleRepository implements javax.jcr.Repository.
OracleRepository repository =
    OracleRepositoryFactory.createOracleRepository(configuration);
```

E.6 Java Code to Upload a File to the Repository using Oracle XML DB Content Connector

You can use Oracle XML DB Content Connector to upload a file from the local file system to Oracle XML DB Repository.

[Example E-2](#) (page E-4) is a Java program that illustrates this. You can compile and run it from the command line. The program requires the following command-line arguments:

- JDBC database URL
- User ID
- User password
- Folder in Oracle XML DB Repository into which to upload the file
- File to be uploaded
- MIME type

[Example E-3](#) (page E-5) illustrates this.

Example E-2 Uploading a File Using Oracle XML DB Content Connector

```
import java.io.FileInputStream;

import javax.jcr.Node;
import javax.jcr.Session;
import javax.jcr.SimpleCredentials;

import oracle.jcr.OracleRepository;
import oracle.jcr.OracleRepositoryFactory;

import oracle.jcr.xdb.XDBRepositoryConfiguration;

import oracle.jdbc.pool.OracleDataSource;

public class UploadFile
{
    public static void main(String[] args)
        throws Exception
    {
        String databaseURL = args[0];
        String userName = args[1];
        String password = args[2];
        String parentPath = args[3];
        String fileName = args[4];
        String mimeType = args[5];

        // Get the JCR Repository object.
        XDBRepositoryConfiguration configuration =
            new XDBRepositoryConfiguration();

        OracleDataSource ods =
            (OracleDataSource)configuration.getDataSource();

        ods.setURL(databaseURL);

        OracleRepository repository =
```

```

        OracleRepositoryFactory.createOracleRepository(configuration);

        // Create a JCR Session.
        SimpleCredentials sc =
            new SimpleCredentials(userName, password.toCharArray());

        Session session = repository.login(sc);

        // Get the parent node.
        Node parentNode = (Node)session.getItem(parentPath);

        // Get the child contents.
        FileInputStream inputStream = new FileInputStream(fileName);

        // Create child node.
        Node node = parentNode.addNode(fileName, "nt:file");
        Node contentNode = node.getNode("jcr:content");
        contentNode.setProperty("jcr:mimeType", mimeType);
        contentNode.setProperty("jcr:data", inputStream);

        // Save changes and logout.
        session.save();
        session.logout();
    }
}

// EOF

```

Example E-3 *Uploading a File Using the Command Line*

```

export CLASSPATH=.:$ORACLE_HOME/lib/jcr-1.0.jar:$ORACLE_HOME/lib/ojcr.jar:11
$ORACLE_HOME/lib/xmlparserv2.jar:$ORACLE_HOME/jlib/xquery.jar

```

```

javac UploadFile.java
java UploadFile jdbc:oracle:oci:@ quine password /public MyFile.txt text/plain

```

E.7 Additional JCR Code Examples

You can find additional sample JCR code at `$ORACLE_HOME/xdk/demo/java/jcr`. For each code sample, a README file describes its purpose and use.

E.8 Oracle XML DB Content Connector Uses the Standard Java Logging API

Oracle XML DB Content Connector uses the standard `java.util.logging` framework. You can use the logging API provided by that framework to control logging behavior.

For example, the following Java code fragment disables all logging.

```

import java.util.logging.LogManager;
...
LogManager.getLogManager().reset();

```

¹¹ This statement is split across two lines for the purpose of documentation.

E.9 Supported JCR Compliance Levels

The JSR-170 standard, which defines JCR version 1.0, defines two compliance levels and a set of optional features. Oracle XML DB Content Connector supports Level 1 (read functions) and Level 2 (write functions).

E.10 Oracle XML DB Content Connector Restrictions

Certain restrictions apply to Oracle XML DB Content Connector.

E.11 XML Schemas and JCR

Oracle XML DB Content Connector can create JCR node types from XML schemas.

A

access control entry (ACE)
 definition, [27-4](#)

access control list (ACL)
 definition, [27-4](#)
 overview, [1-16](#)
 system, [27-8](#)

account XDB, [2-1](#)

ACE
 See access control entry

ACL
 See access control list

administering Oracle XML DB, [34-1](#)

Advanced Queuing (AQ)
 IDAP, [37-4](#)
 messaging scenarios, [37-1](#)
 point-to-point support, [37-1](#)
 publish/subscribe support, [37-1](#)
 XMLType queue payloads, [37-5](#)

aggregate privilege
 definition, [27-3](#)

annotations
 XML schema
 querying to obtain, [18-19](#)

appendChildXML SQL function (deprecated), [C-24](#)

atomic privilege
 definition, [27-3](#)

attribute XML Schema data types
 mapping to SQL, [18-22](#)

attributes
 xdb:columnProps, [18-13](#)
 xdb:defaultTable, [18-13](#)
 xdb:defaultTableSchema (deprecated), [18-13](#)
 xdb:maintainDOM, [18-13](#)
 xdb:maintainOrder (deprecated), [xlviii](#), [18-13](#)
 xdb:mapUnboundedStringToLob (deprecated), [xlviii](#), [18-13](#)
 xdb:maxOccurs (deprecated), [xlviii](#)
 xdb:SQLCollSchema (deprecated), [xlviii](#), [18-13](#)
 xdb:SQLCollType, [18-13](#)
 xdb:SQLInline, [18-13](#)
 xdb:SQLName, [18-13](#)
 xdb:SQLSchema (deprecated), [18-13](#)

attributes (*continued*)
 xdb:SQLType, [18-13](#)
 xdb:srclang (deprecated), [xlviii](#)
 xdb:storeVarrayAsTable (deprecated), [xlviii](#), [18-13](#)
 xdb:tableProps, [18-13](#)
 xdb:translate (deprecated), [xlviii](#)

authentication
 definition, [27-2](#)

authorization
 definition, [27-2](#)

B

backward-compatible XML schema evolution
 definition, [20-16](#)

binary XML
 definition, [1-11](#)

bootstrap ACL
 definition, [27-8](#)

C

C API for XML, [14-1](#)

Cascading Style Sheets (CSS), [11-5](#)

chaining XMLTable calls, [4-13](#)

circular dependencies
 XML schemas, [18-45](#)

CLASSPATH environment variable
 for JCR, [E-3](#)

collection
 in out-of-line tables, [18-43](#)
 loading and retrieving large documents, [18-57](#)
 XML
 definition, [17-22](#)

collection attribute (SQL), [18-27](#)

column pattern, XMLTable SQL function
 definition, [4-11](#)

columnProps attribute, [18-13](#)

complex XLink link
 definition, [23-3](#)
 See also extended XLink link

complexType

- complexType (*continued*)
 - handling cycles, [18-46](#)
 - handling inheritance, [18-29](#)
 - mapping
 - fragments to LOBs, [18-55](#)
 - XML Schema data types to SQL, [18-27](#)
 - Oracle XML DB restrictions and extensions, [18-29](#)
- component of a resource path name
 - definition, [21-5](#)
- compound XML document
 - definition, [23-1](#)
- compression
 - for online transaction processing (OLTP)
 - using CREATE TABLE, [17-22](#)
 - XMLType support, [B-1](#)
- configuring Oracle XML DB
 - protocol server, [28-3](#)
 - repository, [22-1](#)
 - servlets, [31-3](#)
 - using DBMS_XDB API, [34-10](#)
 - using Oracle Enterprise Manager, [34-4](#)
 - xdbconfig.xml configuration file, [34-5](#)
- constraints on XMLType data
 - repetitive XML elements, [18-38](#)
- content of a resource
 - definition, [21-5](#)
- Content Repository API for Java, [E-1](#)
 - See also* JCR
- content-management application
 - definition, [23-1](#)
- copy-based XML schema evolution, [20-2](#)
- copy-namespace mode, XQuery, [4-27](#)
- copyEvolve PL/SQL procedure, [20-1](#)
- COST_XML_QUERY_REWRITE optimizer hint, [5-41](#)
- cost-based XML query rewrite
 - definition, [5-41](#)
- CREATE TABLE statement
 - encoding options for binary XML, [17-20](#)
 - storage options, [17-20](#)
- creating an XMLType table
 - for nested collections, [18-32](#)
 - storage options, [17-20](#)
 - XML schema-based, [17-17](#), [18-32](#)
- CTXAPP role, [6-56](#)
- cyclical dependencies
 - XML schemas, [18-45](#)

D

- database role
 - definition, [27-2](#)
- database user
 - definition, [27-2](#)
- date and time XML Schema data types
 - mapping to SQL, [18-23](#)
- DBMS_XDB_CONFIG PL/SQL package, [xlviii](#), [26-7](#)
- DBMS_XDB_REPOS PL/SQL package, [26-1](#)

- DBMS_XMLDOM PL/SQL package
 - examples, [11-14](#)
- DBMS_XMLGEN PL/SQL package, [8-21](#)
- DBMS_XMLINDEX PL/SQL package
 - modifyParameter procedure, [6-47](#)
 - registerParameter procedure, [6-47](#)
 - syncIndex procedure, [6-42](#)
- DBMS_XMLPARSER PL/SQL package, [11-22](#)
- DBMS_XMLSCHEMA PL/SQL package
 - copyEvolve procedure, [20-1](#)
 - inPlaceEvolve procedure, [20-1](#)
 - registerSchema procedure, [17-8](#)
- DBMS_XMLSCHEMA_ANNOTATE PL/SQL package, [18-12](#)
- DBMS_XMLSTORAGE_MANAGE PL/SQL package
 - disableIndexesAndConstraints procedure, [35-4](#)
 - enableIndexesAndConstraints procedure, [35-4](#)
 - exchangePostProc procedure, [6-13](#)
 - exchangePreProc procedure, [6-13](#)
 - refPartitionExchangeIn procedure, [6-13](#)
 - refPartitionExchangeOut procedure, [6-13](#)
 - renameCollectionTable procedure, [19-6](#)
 - XPath2TabColMapping procedure, [19-4](#), [19-6](#)
- DBMS_XMLSTORE PL/SQL package, [12-1](#)
- DBMS_XSLPROCESSOR PL/SQL package, [11-24](#)
- DBUri
 - definition, [32-2](#)
 - generating using sys_DburiGen SQL function, [32-23](#)
 - identifying a row, [32-18](#)
 - identifying a target column, [32-19](#)
 - retrieving column text value, [32-20](#)
 - retrieving the whole table, [32-17](#)
 - security, [32-30](#)
 - servlet, installation, [32-29](#)
- DBUri-refs
 - HTTP access, [32-27](#)
- DBUriServlet
 - definition, [32-27](#)
- debugging
 - XML schema registration, [18-59](#)
- default tables
 - creating during XML schema registration, [18-5](#)
- defaultTable attribute, [18-13](#)
- defaultTableSchema attribute (deprecated), [18-13](#)
- deleteXML SQL function (deprecated), [C-25](#)
- deleting
 - resource, [24-14](#)
 - XML schema using DBMS_XMLSCHEMA, [17-15](#)
- depth SQL function, [24-8](#)
- derived XML Schema data types
 - mapping to SQL, [18-23](#)
- digest access authentication, [28-10](#)
- digest access authentication, configuring, [28-10](#)
- digest authentication, [28-10](#)
- digest authentication, configuring, [28-10](#)
- directory

- See folder
- document (DOM)
 - definition, [11-10](#)
- document link
 - definition, [21-11](#), [23-2](#)
- document location hint
 - definition, [17-7](#)
- Document Object Model
 - See DOM
- Document Type Definition
 - See DTD
- document-correlated recursive query
 - definition, [18-51](#)
- DOM
 - definition, [11-1](#)
 - difference from SAX, [11-6](#)
 - document
 - definition, [11-10](#)
 - fidelity
 - for XML schema mapping, [11-9](#)
 - using SQL function updateXML, [C-13](#)
 - Java API for XMLType, [13-1](#)
 - NamedNodeMap object, [11-12](#)
 - NodeList object, [11-12](#)
 - overview, [11-5](#)
 - PL/SQL API for XMLType, [11-4](#)
- DOM fidelity
 - definition, [17-6](#)
- DTD
 - definition, [1-13](#)
 - support in Oracle XML DB, [1-13](#)
 - use with Oracle XML DB, [1-13](#)
- dynamic type-checking
 - XQuery language, [4-25](#)

E

- effective text value of a node
 - definition, [6-18](#)
- element XML Schema data types
 - mapping to SQL, [18-22](#)
- Enterprise Manager
 - administering Oracle XML DB, [34-4](#)
- entities, XML
 - using a DTD with binary XML storage, [1-13](#)
- equipartitioning of XMLType tables
 - definition, [18-34](#)
- error
 - ORA-08181, [6-44](#)
 - ORA-18177, [6-58](#)
- event
 - repository
 - configuring, [30-9](#)
 - predefined, [30-3](#)
- event handler, repository
 - definition, [30-2](#)
- event listener, repository
 - definition, [30-2](#)

- evolution, XML schema, [20-1](#)
- extended XLink link
 - definition, [23-3](#)
- extracting data from XML, [5-18](#)

F

- fidelity
 - DOM
 - for XML schema mapping, [11-9](#)
 - using SQL function updateXML, [C-13](#)
- FLWOR XQuery expression, [4-7](#)
- fn:available XQuery function
 - support, [4-28](#)
- fn:collection XQuery function
 - support, [4-28](#)
- fn:doc XQuery function
 - support, [4-28](#)
- fn:id XQuery function
 - support, [4-28](#)
- fn:idref XQuery function
 - support, [4-28](#)
- fn:replace XQuery function, [4-20](#)
- folder
 - definition, [21-5](#)
- folder link
 - definition, [21-11](#)
- folder-restricted query
 - definition, [21-34](#)
- foldering, [21-1](#)
- fragment, XML
 - definition, [3-22](#)
 - SQL operations on, [3-22](#)
- fragments, XML
 - mapping to LOBs, [18-55](#)
- FROM list order
 - XMLTable PASSING clause, [5-9](#)
- FTP
 - configuration parameters, [28-3](#)
 - creating default tables, [18-5](#)
 - protocol server, features, [28-12](#)
- full-text indexing, [6-56](#)
- full-text search
 - XML data, [4-4](#), [4-28](#)
- fully qualified XML schema URLs, [17-14](#)
- functional evaluation
 - definition, [19-5](#)
- functions
 - SQL
 - appendChildXML (deprecated), [C-24](#)
 - deleteXML (deprecated), [C-25](#)
 - depth, [24-8](#)
 - insertChildXML (deprecated), [C-16](#)
 - insertChildXMLafter (deprecated), [C-20](#)
 - insertChildXMLbefore (deprecated), [C-19](#)
 - insertXMLafter (deprecated), [C-23](#)
 - insertXMLbefore (deprecated), [C-21](#)

functions (*continued*)
SQL (*continued*)
sys_DbUriGen, [32-23](#)
sys_XMLAgg, [8-46](#)
under_path, [24-5](#), [24-8](#)
updateXML (deprecated), [C-7](#)
updating XML data, [5-27](#)
XMLAgg, [8-12](#)
XMLAttributes, [8-3](#)
XMLCast, [4-16](#)
XMLCDATA, [8-20](#)
XMLColAttVal, [8-19](#)
XMLComment, [8-16](#)
XMLConcat, [8-11](#)
XMLElement, [8-3](#)
XMLExists, [4-15](#)
XMLForest, [8-9](#)
XMLIsValid, [7-13](#)
XMLParse, [8-18](#)
XMLPI, [8-15](#)
XMLQuery, [4-9](#), [4-10](#)
XMLSerialize, [8-17](#)
XMLTable, [4-9](#), [4-11](#)
XMLtransform, [7-3](#)

G

generating XML
DBMS_XMLGEN PL/SQL package, [8-21](#)
SQL functions, [8-1](#)
sys_XMLAgg SQL function, [8-46](#)
XMLAgg SQL function, [8-12](#)
XMLAttributes SQL function, [8-3](#)
XMLCDATA SQL function, [8-20](#)
XMLColAttVal SQL function, [8-19](#)
XMLComment SQL function, [8-16](#)
XMLConcat SQL function, [8-11](#)
XMLElement SQL function, [8-3](#)
XMLForest SQL function, [8-9](#)
XMLParse SQL function, [8-18](#)
XMLPI SQL function, [8-15](#)
XMLSerialize SQL function, [8-17](#)
getCLOB() XMLType method, [13-8](#)
getSchemaURL() XMLType method, [17-7](#)
getting JCR repository objects, [E-3](#)
global XML schema
using fully qualified URL to override, [17-14](#)
group in an XMLIndex structured component
definition, [6-26](#)

H

hard link
definition, [21-11](#)
hierarchical repository index, [21-37](#)
hierarchy-enabled table

hierarchy-enabled table (*continued*)
definition, [27-18](#)
HTTP
access for DBUri-refs, [32-27](#)
accessing Java servlet or XMLType, [31-2](#)
accessing repository resources, [21-16](#)
configuration parameters, WebDAV, [28-3](#)
creating default tables, [18-5](#)
improved performance, [28-2](#)
Oracle XML DB servlets, [31-7](#)
protocol server, features, [28-20](#)
requests, [31-7](#)
servlets, [31-2](#)
URIFACTORY, [32-31](#)
using UriRefs to store pointers, [32-2](#)
httpconfig element, xdbconfig.xml, [34-6](#)
HTTPUri
definition, [32-2](#)
hybrid columnar compression, [B-1](#)

I

IDAP
architecture, [37-4](#)
transmitted over Internet, [37-4](#)
in-place XML schema evolution, [20-15](#)
index
hierarchical repository, [21-37](#)
index-organized tables, [18-2](#)
indexing
full-text, [6-56](#)
XMLType
choosing, [16-1](#)
inheritance
XML schema, restrictions in complexTypes, [18-29](#)
inPlaceEvolve PL/SQL procedure, [20-1](#)
insertChildXML SQL function (deprecated), [C-16](#)
insertChildXMLafter SQL function (deprecated), [C-20](#)
insertChildXMLbefore SQL function (deprecated),
[C-19](#)
insertXMLafter SQL function (deprecated), [C-23](#)
insertXMLbefore SQL function (deprecated), [C-21](#)
instance document
definition, [1-12](#), [17-2](#)
specifying root element namespace, [17-2](#)
Internet Data Access Presentation (IDAP)
SOAP specification for AQ, [37-4](#)
Internet Protocol Version 6
FTP, [28-19](#)
HTTP(S), [28-22](#)
IPv6
FTP, [28-19](#)
HTTP(S), [28-22](#)
isSchemaBased() XMLType method, [17-7](#)
isSchemaValidated() XMLType method, [17-7](#)

J

Java

- DOM API for XMLType, [13-1](#)
- Oracle XML DB applications, [31-1](#)

Java Content Repository API

See JCR

Java Specification Request

- 170, [E-1](#)
- 225, [5-23](#)

JCR

- compliance levels supported, [E-6](#)
- logging, [E-5](#)
- Oracle XML DB Repository access, [E-2](#)
- overview, [E-1](#)
- restrictions for Oracle XML DB Content Connector, [E-6](#)
- XML schema, [E-6](#)

JCR node types

- nt:file, [E-2](#)
- nt:folder, [E-2](#)

JDBC

- accessing XML documents, [13-2](#)
- drivers, OCI and thin, [13-4](#)
- loading large XML documents, [13-8](#)
- manipulating XML documents, [13-4](#)

JSR-170, [E-1](#)

See also JCR

JSR-225, [5-23](#)

L

large node handling, [11-15](#)

lazy XML loading (lazy manifestation), [11-2](#)

LDAP principal

definition, [27-2](#)

link

- document
 - definition, [21-11](#)
- folder
 - definition, [21-11](#)
- hard
 - definition, [21-11](#)
- repository
 - definition, [21-11](#)
- weak
 - definition, [21-11](#)

link name

definition, [21-5](#)

link-properties document

definition, [21-19](#)

linking, repository

definition, [21-19](#)

loading

large documents with collections, [18-57](#)

loading large XML documents using JDBC, [13-8](#)

loading of XML data, lazy, [11-2](#)

LOB locator, [25-6](#)

LOBs

- mapping XML fragments to, [18-55](#)
- local XML schema
 - definition, [17-12](#)
 - using fully qualified URL to specify, [17-14](#)

M

maintainDOM attribute, [18-13](#)

maintainOrder attribute (deprecated), [xlvi](#), [18-13](#)

manifestation, lazy, [11-2](#)

mapping

- complexType to SQL
 - out-of-line storage, [18-40](#), [19-3](#)
- overriding using SQLType attribute, [18-23](#)
- simpleContent to object types, [18-31](#)

mapping XML Schema complexType data types to SQL, [18-27](#)

mapping XML Schema data types to SQL data types, [18-20](#)

mapUnboundedStringToLob attribute (deprecated), [xlvi](#), [18-13](#)

maxOccurs attribute in xdb namespace (deprecated), [xlvi](#)

metadata

- definition, [29-1](#)
- system-defined
 - definition, [1-16](#)
- user-defined
 - definition, [1-16](#)

methods

- XMLType
 - getCLOB(), [13-8](#)
 - getSchemaURL(), [17-7](#)
 - isSchemaBased(), [17-7](#)
 - isSchemaValid(), [17-7](#)
 - isSchemaValidated(), [17-7](#)
 - schemaValidate(), [17-7](#)
 - setSchemaValidated(), [17-7](#)
 - XML schema, [17-7](#)

MIME

overriding with DBUri servlet, [32-29](#)

model, XML Schema

definition, [20-17](#)

modifyParameter PL/SQL procedure, [6-47](#)

N

NamedNodeMap object (DOM), [11-12](#)

namespace

XQuery, [4-9](#), [5-16](#)

naming SQL objects, [18-7](#)

navigational access to repository resources, [21-14](#)

nested XML

- generating using DBMS_XMLGEN, [8-28](#)
- generating with XMLElement, [8-6](#)

NESTED_TABLE_ID pseudocolumn, [18-32](#)

NodeList object (DOM), [11-12](#)
nodes, large (DBMS_XMLDOM), [11-15](#)
non-schema-based view
 definition, [10-1](#)
nonce
 definition, [28-11](#)
nonce key
 definition, [28-11](#)
nt:file JCR node type, [E-2](#)
nt:folder, [E-2](#)
nt:folder JCR node type, [E-2](#)
numeric XML Schema data types
 mapping to SQL, [18-23](#)

O

object attributes
 for collection (SQL), [18-27](#)
 sys_DburiGen SQL function
 passing to, [32-24](#)
 XMLType, in AQ, [37-5](#)
object identifier
 definition, [27-7](#)
object-based persistence of XML data
 definition, [1-11](#)
object-relational storage of XML data
 definition, [1-11](#)
occurrence indicator
 definition, [4-5](#)
OCI API for XML, [14-1](#)
OCT
 definition, [18-2](#)
ODP.NET, [15-1](#)
OID
 See object identifier
optimizer hints
 COST_XML_QUERY_REWRITE, [5-41](#)
ORA-08181 error, [6-44](#)
ORA-18177 error, [6-58](#)
ora:defaultTable Oracle XQuery pragma, [5-47](#)
ora:matches Oracle XQuery function (deprecated),
 xlvi, [4-21](#)
ora:no_schema Oracle XQuery pragma, [6-58](#)
ora:no_xmlquery_rewrite Oracle XQuery pragma,
 [6-36](#)
ora:replace Oracle XQuery function (deprecated), [4-21](#)
ora:sqrt Oracle XQuery function, [4-20](#)
ora:tokenize Oracle XQuery function, [4-20](#)
ora:use_xmltext_idx Oracle XQuery pragma, [6-59](#)
Oracle ASM files
 accessing
 using FTP, [28-16](#)
Oracle ASM virtual folder, [21-8](#)
Oracle Data Provider for .NET, [15-1](#)
Oracle Enterprise Manager
 administering Oracle XML DB, [34-4](#)
Oracle Internet Directory, [27-20](#)

Oracle Net Services, [1-8](#)
Oracle Text
 searching for resources, [24-21](#)
Oracle XML DB
 access models, [2-5](#)
 architecture, [1-8](#)
 features, [1-10](#)
 Java applications, [31-1](#)
 overview, [1-1](#)
 Repository
 See repository, [21-5](#)
 upgrading, [34-1](#)
 versioning, [25-1](#)
 when to use, [2-1](#)
Oracle XML DB Content Connector
 logging API, [E-5](#)
 overview, [E-2](#)
 restrictions, [E-6](#)
 sample code to upload file, [E-4](#)
 See also JCR
OracleRepository, [E-3](#)
order index of XMLIndex
 definition, [6-15](#)
ordered collection
 definition, [18-2](#)
ordered collection table (OCT)
 definition, [18-2](#)
ordered collections in tables (OCTs)
 default storage of varray, [18-27](#)
out-of-line storage
 collections, [18-43](#)
 XPath rewrite, [19-3](#)

P

partial update of XML data
 definition, [C-5](#)
partial validation of XML data
 definition, [7-12](#)
partitioning XMLType tables
 binary XML storage
 exchange partitioning, [6-13](#)
 object-relational storage
 examples, [18-35](#)
 with an XMLIndex index, [6-41](#)
PASSING clause of XMLTable
 FROM list order, [5-9](#)
path component of a resource path name
 definition, [21-5](#)
path index of XMLIndex
 definition, [6-15](#)
path name
 definition, [21-5](#)
 resolution, [21-10](#)
path table of XMLIndex, [6-15](#)
PATH_VIEW, [24-1](#)
path-based access to repository resources, [21-14](#)

- path-index trigger
 - definition, [27-18](#)
- PD (positional descriptor), [18-6](#)
- persistence models for XML data, [1-11](#)
- PL/SQL functions
 - See functions, PL/SQL
- PL/SQL packages
 - DBMS_XDB_CONFIG, [xlviii, 26-7](#)
 - DBMS_XDB_REPOS, [26-1](#)
 - DBMS_XMLDOM, [11-4](#)
 - DBMS_XMLGEN, [8-21](#)
 - DBMS_XMLPARSER, [11-22](#)
 - DBMS_XMLSCHEMA_ANNOTATE, [18-12](#)
 - DBMS_XMLSTORE, [12-1](#)
 - DBMS_XSLPROCESSOR, [11-24](#)
 - for XMLType, [11-1](#)
- PL/SQL procedures
 - See procedures, PL/SQL
- point-to-point
 - support in AQ, [37-1](#)
- port, FTP, [28-3](#)
- port, HTTP, [28-3](#)
- ports
 - configuring
 - FTP, [28-3](#)
 - HTTP, [28-3](#)
 - HTTPS, [28-7](#)
- positional descriptor (PD), [18-6](#)
- post-parse persistence of XML data
 - definition, [1-11](#)
- pragmas, XQuery
 - See XQuery pragmas, Oracle
- predefined ACLs, [27-8](#)
- pretty-printing
 - in book examples, [xxxviii](#)
 - not done by SQL/XML functions, [3-28](#)
 - Web service output, [33-4](#)
- primitive XML Schema data types
 - mapping to SQL, [18-23](#)
- principal
 - definition, [27-2](#)
 - LDAP
 - definition, [27-2](#)
- private (local) XML schema, definition, [17-12](#)
- privilege
 - definition, [27-3](#)
- procedures
 - PL/SQL
 - copyEvolve, [20-1](#)
 - disableIndexesAndConstraints, [35-4](#)
 - enableIndexesAndConstraints, [35-4](#)
 - exchangePostProc, [6-13](#)
 - exchangePreProc, [6-13](#)
 - inPlaceEvolve, [20-1](#)
 - modifyParameter, [6-47](#)
 - refPartitionExchangeIn, [6-13](#)
 - refPartitionExchangeOut, [6-13](#)

- procedures (*continued*)
 - PL/SQL (*continued*)
 - registerParameter, [6-47](#)
 - registerSchema, [17-8](#)
 - renameCollectionTable, [19-6](#)
 - syncIndex, [6-42](#)
 - XPath2TabColMapping, [19-4, 19-6](#)
- protocol server
 - architecture, [28-2](#)
 - configuration parameters, [28-3](#)
 - event-based logging, [28-12](#)
 - FTP
 - configuration parameters, [28-3](#)
 - HTTP
 - configuration parameters, [28-3](#)
 - WebDAV
 - configuration parameters, [28-3](#)
- protocolconfig element, xdbconfig.xml, [34-6](#)
- protocols, access to repository resources, [21-15](#)
- public (global) XML schema, definition, [17-12](#)
- publish/subscribe
 - support in AQ, [37-1](#)
- purchase-order XML schema
 - annotated, [A-31](#)
 - revised, [20-2, A-31](#)

Q

- qualified XML schema URLs, [17-14](#)
- query-based access to resources
 - using RESOURCE_VIEW and PATH_VIEW, [24-1](#)
 - using SQL, [21-19](#)
- querying XMLType data
 - choices, [5-18](#)
 - transient data, [5-18](#)

R

- recursive schema support, [18-51](#)
- registered XML schemas, list of, [17-16](#)
- registering an XML schema
 - debugging, [18-59](#)
 - default tables, creating, [18-5](#)
 - SQL object types, creating, [18-3](#)
- registerParameter PL/SQL procedure, [6-47](#)
- registerSchema PL/SQL procedure, [17-8](#)
- renaming an XMLIndex index, [6-20](#)
- replace XQuery function, [4-20](#)
- repository
 - access using JCR, [E-2](#)
 - data storage, [21-8](#)
 - event
 - configuring, [30-9](#)
 - predefined, [30-3](#)
 - event handler
 - definition, [30-2](#)
 - event listener

- repository (*continued*)
 - event listener (*continued*)
 - definition, [30-2](#)
 - hierarchical index, [21-37](#)
 - use with XQuery, [5-3](#)
- repository link
 - definition, [21-11](#)
- repository objects, [E-3](#)
- RESID
 - definition, [25-4](#)
- resource
 - access
 - using protocols, [28-11](#)
 - definition, [1-16](#), [29-1](#)
 - deleting
 - nonempty container, [24-15](#)
 - using DELETE, [24-14](#)
 - management using DBMS_XDB_REPOS, [26-1](#)
 - managing with DBMS_XDB, [34-14](#)
 - required privileges for operations, [27-5](#)
 - searching for, using Oracle Text, [24-21](#)
 - setting property in ACLs, [27-10](#)
 - simultaneous operations, [24-18](#)
 - updating, [24-16](#)
- resource configuration file
 - definition, [22-1](#)
- resource configuration list
 - definition, [22-1](#)
- resource content
 - definition, [21-5](#)
- resource document
 - definition, [21-4](#)
- resource ID
 - definition, [25-4](#)
- resource name
 - definition, [21-5](#)
- resource version
 - definition, [25-1](#)
- RESOURCE_VIEW
 - explained, [24-1](#)
- resource-view-cache-size configuration parameter, [24-20](#)
- retrieving large documents with collections, [18-57](#)
- RETURNING SEQUENCE BY REF clause of XMLTable, [5-9](#)
- revalidation mode, XQuery Update, [4-26](#)
- rewrite
 - XPath (XPath), [19-1](#)
 - XQuery, [5-40](#)
- role
 - CTXAPP, [6-56](#)
 - database
 - definition, [27-2](#)
- root configuration, [34-13](#)
- root folder, repository, [21-1](#)
- root XML Schema
 - definition, [17-3](#)

- row pattern, XMLTable SQL function
 - definition, [4-11](#)
- rule-based XML query rewrite
 - definition, [5-41](#)

S

- schema evolution
 - See XML schema evolution
- schema for schemas (XML Schema)
 - definition, [1-12](#)
- schema location hint
 - definition, [17-7](#)
- schemaValidate() XMLType method, [17-7](#)
- security
 - DBUri, [32-30](#)
- servlet element, xdbconfig.xml, [34-7](#)
- servlets
 - accessing repository data, [21-20](#)
 - APIs, [31-8](#)
 - configuring, [31-3](#)
 - session pooling, [31-7](#)
 - writing
 - in Java, [31-2](#)
 - XML manipulation, [31-2](#)
- session pooling
 - protocol server, [28-2](#)
- simple XLink link
 - definition, [23-3](#)
- simpleContent
 - mapping to object types, [18-31](#)
- SOAP
 - IDAP, [37-4](#)
- SQL functions
 - See functions, SQL
- SQL object types
 - creating during XML schema registration, [18-3](#)
- SQL*Loader, [35-2](#)
- SQL*Plus
 - XQUERY command, [5-22](#)
- SQL/XML generation functions
 - definition, [1-15](#), [8-2](#)
- SQL/XML publishing functions
 - definition, [1-15](#), [8-2](#)
- SQL/XML query and update functions
 - definition, [1-15](#)
- SQL/XML standard
 - generating XML data, [8-2](#)
 - querying XML data
 - XMLQuery and XMLTable, [4-9](#)
- SQLCollSchema attribute (deprecated), [xlviii](#), [18-13](#)
- SQLCollType attribute, [18-13](#)
- SQLInline attribute, [18-13](#)
- SQLJ, [13-11](#)
- SQLName attribute, [18-13](#)
- SQLSchema attribute (deprecated), [18-13](#)
- SQLType attribute, [18-13](#)
- sqrt XQuery function (Oracle), [4-20](#)

- srclang attribute (deprecated), [xlvi](#)
- static type-checking
 - XQuery language, [4-25](#)
- storage
 - out of line
 - collections, [18-43](#)
- storage models for XMLType
 - choosing, [16-1](#)
- storeVarrayAsTable attribute (deprecated), [xlvi](#), [18-13](#)
- string XML Schema data types
 - mapping to SQL, [18-23](#)
 - mapping to VARCHAR2 vs CLOB, [18-26](#)
- structured storage of XMLType data
 - definition, [1-11](#), [16-2](#)
- structured XMLIndex component
 - definition, [6-8](#)
- style sheet, CSS, [11-5](#)
- stylesheet for updating XML instance documents, [20-10](#)
- syncIndex PL/SQL procedure, [6-42](#)
- sys_DburiGen SQL function
 - inserting database references, [32-25](#)
- SYS_NC_ARRAY_INDEX\$ column, [18-32](#)
- sys_XMLAgg SQL function, [8-46](#)
- sysconfig element, xdbconfig.xml, [34-5](#)
- system ACL
 - definition, [27-8](#)
- system ACLs, [27-8](#)
- system-defined metadata
 - definition, [1-16](#)

T

- tableProps attribute, [18-13](#)
- tables
 - index-organized, [18-2](#)
- text value of a node, effective
 - definition, [6-18](#)
- third-party XLink link
 - definition, [23-3](#)
- time zone support, implicit, [4-26](#)
- translate attribute (deprecated), [xlvi](#)
- trigger, path-index
 - definition, [27-18](#)
- type-checking, static and dynamic
 - XQuery language, [4-25](#)

U

- UDT
 - generating an element from, [8-6](#)
- under_path SQL function
 - different correlations for different folders, [24-8](#)
- uniform access control mechanism
 - definition, [27-18](#)

- unique constraint on parent element of an attribute, [18-38](#)
- unresolved XLink and XInclude links, [23-11](#)
- unstructured XMLIndex component
 - definition, [6-8](#)
- updateXML SQL function (deprecated), [C-7](#)
- updating repository resource, [24-16](#)
- updating XML data
 - partial update
 - definition, [C-5](#)
 - updating same node more than once, [C-13](#)
 - using SQL functions
 - optimization, [C-14](#)
- upgrading Oracle XML DB, [34-1](#)
- Uri-reference
 - database and session, [32-16](#)
 - DBUri-ref, [32-13](#)
 - HTTP access for DBUri-ref, [32-27](#)
 - URIFACTORY PL/SQL package, [32-21](#)
 - URIType examples, [32-7](#)
- URIFACTORY PL/SQL package
 - configuring to handle DBURI-ref, [32-31](#)
 - creating subtypes of URIType, [32-21](#)
- URIType
 - examples, [32-7](#)
- user
 - definition, [27-2](#)
- user XDB, [2-1](#)
- user-defined metadata
 - definition, [1-16](#)
- userconfig element, xdbconfig.xml, [34-6](#)

V

- validating
 - examples, [7-14](#)
 - XMLIsValid SQL function
 - use as CHECK constraint, [7-13](#)
- validation of XML data, partial
 - definition, [7-12](#)
- value index of XMLIndex
 - definition, [6-15](#)
- varray in a LOB
 - definition, [18-2](#)
- varray in a table
 - definition, [18-2](#)
- VCR
 - See* version-controlled resource
- version resource
 - definition, [25-1](#)
- version series of a resource
 - definition, [25-4](#)
- version-controlled resource
 - definition, [25-1](#)
- versionable resource
 - definition, [25-1](#)
- versioning, [1-16](#), [25-1](#)
- views

views (*continued*)
RESOURCE and PATH, [24-1](#)

W

weak link
definition, [21-11](#)
deletion, [23-11](#)

Web service
pretty-printing output, [33-4](#)

WebDAV
definition, [21-1](#)

WebFolder
creating in Windows 2000, [28-28](#)

well-formed XML document
definition, [3-5](#)

WSDL
Web service for accessing stored PL/SQL, [33-6](#)
Web service for database queries, [33-4](#)

X

XDB database schema (user account), [2-1](#), [21-4](#)

xdb namespace, [27-5](#)

xdb:columnProps attribute, [18-13](#)

xdb:defaultTable attribute, [18-13](#)

xdb:defaultTableSchema attribute (deprecated), [18-13](#)

xdb:maintainDOM attribute, [18-13](#)

xdb:maintainOrder attribute (deprecated), [xlvi](#),
[18-13](#)

xdb:mapUnboundedStringToLob attribute
(deprecated), [xlvi](#), [18-13](#)

xdb:maxOccurs attribute (deprecated), [xlvi](#)

xdb:SQLCollSchema attribute (deprecated), [xlvi](#),
[18-13](#)

xdb:SQLCollType attribute, [18-13](#)

xdb:SQLInline attribute, [18-13](#)

xdb:SQLName attribute, [18-13](#)

xdb:SQLSchema attribute (deprecated), [18-13](#)

xdb:SQLType attribute, [18-13](#)

xdb:srclang attribute (deprecated), [xlvi](#)

xdb:storeVarrayAsTable attribute (deprecated), [xlvi](#),
[18-13](#)

xdb:tableProps attribute, [18-13](#)

xdb:translate attribute (deprecated), [xlvi](#)

XDBBinary element
definition, [21-5](#)

xdbconfig element, xdbconfig.xml, [34-5](#)

xdbconfig.xml configuration file, [34-5](#)

xdbcore-loadableunit-size configuration parameter,
[18-57](#), [18-58](#)

xdbcore-xobmem-bound configuration parameter,
[18-58](#)

XDBSchema.xsd
definition, [17-3](#)

XDBUri
definition, [32-2](#), [32-10](#)

XInclude
definition, [23-1](#)
unresolved link, [23-11](#)

XLink
complex link
definition, [23-3](#)
definition, [23-1](#)
third-party link
definition, [23-3](#)

XLink (deprecated)
extended link
definition, [23-3](#)
link types, [23-3](#)
simple link
definition, [23-3](#)
unresolved link, [23-11](#)

XML attributes
See attributes

XML diagnosability mode, [5-46](#)

XML entities
using a DTD with binary XML storage, [1-13](#)

XML fragment
definition, [3-22](#)
mapping to LOBs, [18-55](#)
SQL operations on, [3-22](#)

XML instance document
definition, [1-12](#), [17-2](#)

XML query rewrite
definition
cost-based, [5-41](#)
rule-based, [5-41](#)

XML schema
annotations
querying to obtain, [18-19](#)
circular dependencies, [18-45](#)
complexType declarations, [18-29](#), [18-46](#)
cyclical dependencies, [18-45](#)
definition, [1-12](#), [17-1](#)
deletion, [17-15](#)
evolution
backward-compatible, definition, [20-16](#)
for XML schemas that can be registered, [17-3](#)
inheritance in, complexType restrictions, [18-29](#)
local and global, [17-12](#)
mapping to SQL object types, [11-9](#)
updating after registering, [20-1](#)
URLs, [17-14](#)
use with JCR, [E-6](#)
W3C Recommendation, [17-1](#)
XMLType methods, [17-7](#)

XML Schema
definition, [xxxvi](#)

XML Schema data types
mapping to SQL data types, [18-20](#)

XML schema definition
definition, [1-12](#)

XML schema evolution

- XML schema evolution (*continued*)
 - copy-based, [20-2](#)
 - in-place, [20-15](#)
- XML schema-based tables and columns, creating, [17-17](#)
- XML schema-based view
 - definition, [10-1](#)
- XML search index
 - definition, [6-56](#)
- XML_ENABLE path section group attribute, [6-56](#)
- XMLAgg SQL function, [8-12](#)
- XMLAttributes SQL function, [8-3](#)
- XMLCast SQL function, [4-16](#)
- XMLCDATA SQL function, [8-20](#)
- XMLColAttVal SQL function, [8-19](#)
- XMLComment SQL function, [8-16](#)
- XMLConcat SQL function, [8-11](#)
- XMLElement SQL function, [8-3](#)
- XMLExists SQL function, [4-15](#)
- XMLForest SQL function, [8-9](#)
- XMLIndex
 - creating index, [6-20](#)
 - dropping index, [6-20](#)
 - order index
 - definition, [6-15](#)
 - partitioning and parallelism, [6-41](#)
 - path index
 - definition, [6-15](#)
 - path table, [6-15](#)
 - renaming index, [6-20](#)
 - structured component
 - definition, [6-8](#)
 - synchronizing if ORA-08181, [6-44](#)
 - unstructured component
 - definition, [6-8](#)
 - value index
 - definition, [6-15](#)
- XMLIsValid SQL function, [7-13](#)
- XMLNAMESPACES clause, [4-11](#)
- XMLParse SQL function, [8-18](#)
- XMLPI SQL function, [8-15](#)
- XMLQuery SQL function, [4-9](#), [4-10](#)
- XMLSerialize SQL function, [8-17](#)
- XMLTable SQL function
 - breaking up an XML fragment, [3-22](#)
 - column pattern
 - definition, [4-11](#)
 - PASSING clause and FROM list order, [5-9](#)
 - RETURNING SEQUENCE BY REF clause, [5-9](#)
 - reverse node references in COLUMNS clause, [5-9](#)
 - row pattern
 - definition, [4-11](#)
- XMLtransform SQL function, [7-3](#)
- XMLType
 - as abstract data type, [1-11](#)
 - constructors, [3-10](#)
 - DBMS_XMLDOM PL/SQL API, [11-4](#)
- XMLType (*continued*)
 - DBMS_XMLPARSER PL/SQL API, [11-22](#)
 - DBMS_XSLPROCESSOR PL/SQL API, [11-24](#)
 - extracting data, [5-18](#)
 - indexing columns, [6-4](#)
 - instances, PL/SQL APIs, [11-1](#)
 - loading data, [35-1](#)
 - loading with SQL*Loader, [35-2](#)
 - methods
 - getCLOB(), [13-8](#)
 - getSchemaURL(), [17-7](#)
 - isSchemaBased(), [17-7](#)
 - isSchemaValid(), [17-7](#)
 - setSchemaValidated(), [17-7](#)
 - XML schema, [17-7](#)
 - PL/SQL packages, [11-1](#)
 - querying, [5-18](#)
 - querying transient data, [5-18](#)
 - querying XMLType columns, [5-18](#)
 - queue payloads, [37-5](#)
 - storage models, [1-11](#)
 - tables, views, columns, [17-17](#)
 - views, access with PL/SQL DOM APIs, [11-10](#)
- XPath language
 - functions
 - ora:contains (Oracle), [4-20](#)
 - syntax, [4-1](#)
 - See also* XQuery language
- XPath rewrite
 - definition, [5-40](#)
 - indexes on singleton elements and attributes, [6-62](#)
 - out-of-line storage, [19-3](#)
- XQJ, [5-23](#)
- XQuery
 - copy-namespace mode, [4-27](#)
 - extension expressions
 - See* XQuery pragmas, Oracle, [xlv](#), [4-22](#)
 - pending update list, [4-3](#)
 - pragmas, Oracle
 - ora:defaultTable, [5-47](#)
 - ora:no_schema, [6-58](#)
 - ora:no_xmlquery_rewrite, [6-36](#)
 - ora:use_xmltext_idx, [6-59](#)
 - revalidation mode, [4-26](#)
 - simple expression, [4-5](#)
 - static typing feature, [4-27](#)
 - time zone support, implicit, [4-26](#)
 - XDM instance, [4-2](#)
- XQuery API for Java (XQJ), [5-23](#)
- XQUERY command, SQL*Plus, [5-22](#)
- XQuery Data Model (XDM), [4-2](#)
- XQuery functions and operators
 - support, [4-28](#)
- XQuery language
 - expressions
 - FLWOR, [4-7](#)
 - rewrite, [5-40](#)

XQuery language (*continued*)

functions

- fn:replace, [4-20](#)
- ora:matches (deprecated, Oracle), [xlviii](#)
- ora:contains (Oracle), [4-20](#)
- ora:matches (deprecated, Oracle), [4-21](#)
- ora:replace (deprecated, Oracle), [4-21](#)
- ora:sqrt (Oracle), [4-20](#)
- ora:tokenize (Oracle), [4-20](#)

item

- definition, [4-3](#)

namespaces, [4-9](#), [5-16](#)

optimization, [5-40](#)

optimization over relational data, [5-42](#)

Oracle extension functions, [4-20](#)

Oracle XML DB support, [4-26](#)

performance, [5-40](#)

predefined namespaces and prefixes, [4-9](#)

referential transparency

- definition, [4-3](#)

sequence

- definition, [4-3](#)

SQL*Plus XQUERY command, [5-22](#)

XQuery language (*continued*)

tuning, [5-40](#)

type-checking, static and dynamic, [4-25](#)

unordered mode

- definition, [4-3](#)

update snapshot, [4-4](#)

use with Oracle XML DB Repository, [5-3](#)

use with XMLType relational data

- optimization, [5-43](#)

XMLQuery and XMLTable SQL functions

- examples, [5-1](#)

XQuery Update Facility, [4-1](#)

XSD

- definition, [1-12](#)

XSL stylesheet

- definition, [11-24](#)

XSLT

stylesheets

- for updating XML instance documents, [20-10](#)

- use with DBUri servlet, [7-9](#), [32-32](#)

- use with Oracle XML DB, [7-1](#)

- use with package DBMS_XSLPROCESSOR, [11-25](#)