

Oracle® XML Developer's Kit

Programmer's Guide

12c Release 2 (12.2)

E49690-13

January 2017

Oracle XML Developer's Kit Programmer's Guide, 12c Release 2 (12.2)

E49690-13

Copyright © 2001, 2017, Oracle and/or its affiliates. All rights reserved.

Primary Authors: Drew Adams, Lance Ashdown, Janis Greenberg, Sheila Moore, Sue Pelski

Contributors: Nipun Agarwal, Geeta Arora, Vikas Arora, Thomas Baby, Janet Blowney, Dan Chiba, Steve Ding, Mark Drake, Beda Hammerschmidt, Bill Han, Roza Leyderman, Dmitry Lychagin, Valarie Moore, Steve Muench, Ravi Murthy, Maxim Orgiyan, Mark Scardina, Helen Slattery, Joshua Spiegel, Asha Tarachandani, Jinyu Wang, Simon Wong, Tim Yu, Kongyi Zhou

This software and related documentation are provided under a license agreement containing restrictions on use and disclosure and are protected by intellectual property laws. Except as expressly permitted in your license agreement or allowed by law, you may not use, copy, reproduce, translate, broadcast, modify, license, transmit, distribute, exhibit, perform, publish, or display any part, in any form, or by any means. Reverse engineering, disassembly, or decompilation of this software, unless required by law for interoperability, is prohibited.

The information contained herein is subject to change without notice and is not warranted to be error-free. If you find any errors, please report them to us in writing.

If this is software or related documentation that is delivered to the U.S. Government or anyone licensing it on behalf of the U.S. Government, then the following notice is applicable:

U.S. GOVERNMENT END USERS: Oracle programs, including any operating system, integrated software, any programs installed on the hardware, and/or documentation, delivered to U.S. Government end users are "commercial computer software" pursuant to the applicable Federal Acquisition Regulation and agency-specific supplemental regulations. As such, use, duplication, disclosure, modification, and adaptation of the programs, including any operating system, integrated software, any programs installed on the hardware, and/or documentation, shall be subject to license terms and license restrictions applicable to the programs. No other rights are granted to the U.S. Government.

This software or hardware is developed for general use in a variety of information management applications. It is not developed or intended for use in any inherently dangerous applications, including applications that may create a risk of personal injury. If you use this software or hardware in dangerous applications, then you shall be responsible to take all appropriate fail-safe, backup, redundancy, and other measures to ensure its safe use. Oracle Corporation and its affiliates disclaim any liability for any damages caused by use of this software or hardware in dangerous applications.

Oracle and Java are registered trademarks of Oracle and/or its affiliates. Other names may be trademarks of their respective owners.

Intel and Intel Xeon are trademarks or registered trademarks of Intel Corporation. All SPARC trademarks are used under license and are trademarks or registered trademarks of SPARC International, Inc. AMD, Opteron, the AMD logo, and the AMD Opteron logo are trademarks or registered trademarks of Advanced Micro Devices. UNIX is a registered trademark of The Open Group.

This software or hardware and documentation may provide access to or information about content, products, and services from third parties. Oracle Corporation and its affiliates are not responsible for and expressly disclaim all warranties of any kind with respect to third-party content, products, and services unless otherwise set forth in an applicable agreement between you and Oracle. Oracle Corporation and its affiliates will not be responsible for any loss, costs, or damages incurred due to your access to or use of third-party content, products, or services, except as set forth in an applicable agreement between you and Oracle.

Contents

Preface	xxix
Audience	xxix
Documentation Accessibility	xxix
Related Documents.....	xxix
Examples	xxx
Conventions.....	xxx
Changes in This Release for Oracle XML Developer's Kit Programmer's Guide.....	xxxiii
Changes in Oracle XML Developer's Kit 12c Release 2 (12.2.0.1).....	xxxiii
New Features	xxxiii
Changes in Oracle XML Developer's Kit 12c Release 1 (12.1.0.1)	xxxiii
New Features	xxxiii
Deprecated Features.....	xxxiv
1 Introduction to Oracle XML Developer's Kit	
1.1 Overview of XDK.....	1-1
1.2 XDK Components	1-3
1.2.1 XML Parsers.....	1-4
1.2.2 XSLT Processors	1-5
1.2.3 XML Schema Processors	1-6
1.2.4 XML Class Generators	1-6
1.2.5 XML Pipeline Processor	1-7
1.2.6 Oracle XML SQL Utility.....	1-7
1.2.7 TransX Utility Overview.....	1-9
1.2.8 XSQL Pages Publishing Framework.....	1-9
1.2.9 SOAP Services	1-10
1.2.10 XSLT Virtual Machine.....	1-10
1.3 Generating XML Documents Using XDK.....	1-11
1.3.1 XML Document Generation with Java	1-11
1.3.2 XML Document Generation with C	1-12
1.3.3 XML Document Generation with C++	1-13
1.4 Development Tools and Frameworks for XDK	1-14

1.4.1 Oracle JDeveloper	1-15
1.4.2 Oracle Data Provider for .NET	1-17
1.5 About Installing XDK	1-17

Part I Oracle XML Developer's Kit for Java

2 Unified Java API for XML

2.1 Overview of Unified Java API for XML	2-1
2.2 Component Unification	2-1
2.3 About Moving to the Unified Java API	2-2
2.3.1 Java DOM APIs for XMLType Classes	2-2
2.3.2 Extension APIs	2-3
2.3.3 Document Creation Java APIs	2-4

3 Getting Started with Oracle XML Developer's Kit for Java

3.1 Installing XDK for Java Components	3-1
3.2 XDK for Java Component Dependencies	3-2
3.3 Setting Up the XDK for Java Environment	3-5
3.3.1 Setting Up XDK for Java Environment Variables for UNIX	3-5
3.3.2 Testing the XDK for Java Environment on UNIX	3-7
3.3.3 Setting Up XDK for Java Environment Variables for Windows	3-7
3.3.4 Testing the XDK for Java Environment on Windows	3-9
3.4 Verifying the XDK (Java) Version	3-9

4 XML Parsing for Java

4.1 Introduction to XML Parsing for Java	4-1
4.1.1 Prerequisites for Parsing with Java	4-1
4.1.2 Standards and Specifications for XML Parsing for Java	4-2
4.1.3 Large Node Handling	4-3
4.1.4 XML Parsing in Java: Overview	4-3
4.1.5 DOM in XML Parsing	4-5
4.1.6 SDOM	4-5
4.1.7 SAX in the XML Parser	4-7
4.1.8 JAXP in the XML Parser	4-8
4.1.9 Namespace Support in the XML Parser	4-8
4.1.10 Validation in the XML Parser	4-9
4.1.11 Compression in the XML Parser	4-11
4.2 Using XML Parsing for Java: Overview	4-12
4.2.1 Using the XML Parser for Java: Basic Process	4-12
4.2.2 Running the XML Parser for Java Demo Programs	4-13
4.2.3 Using the Java XML Parser Command-Line Utility (oraxml)	4-15
4.3 Parsing XML with DOM	4-16
4.3.1 Using the DOM API for Java	4-17

4.3.2	DOM Parser Architecture.....	4-17
4.3.3	Performing Basic DOM Parsing	4-18
4.3.4	Creating SDOM	4-22
4.3.5	Performing DOM Operations with Namespaces.....	4-29
4.3.6	Performing DOM Operations with Events.....	4-31
4.3.7	Performing DOM Operations with Ranges.....	4-32
4.3.8	Performing DOM Operations with TreeWalker	4-34
4.4	Parsing XML with SAX.....	4-36
4.4.1	Using the SAX API for Java	4-36
4.4.2	Performing Basic SAX Parsing	4-39
4.4.3	Performing Basic SAX Parsing with Namespaces.....	4-41
4.4.4	Performing SAX Parsing with XMLTokenizer.....	4-42
4.5	Parsing XML with JAXP	4-44
4.5.1	JAXP Structure	4-44
4.5.2	Using the SAX API Through JAXP	4-44
4.5.3	Using the DOM API Through JAXP	4-45
4.5.4	Transforming XML Through JAXP.....	4-46
4.5.5	Parsing with JAXP.....	4-46
4.5.6	Performing Basic Transformations with JAXP.....	4-48
4.6	Compressing and Decompressing XML.....	4-49
4.6.1	Compressing a DOM Object.....	4-49
4.6.2	Decompressing a DOM Object.....	4-50
4.6.3	Compressing a SAX Object.....	4-50
4.6.4	Decompressing a SAX Object	4-51
4.7	Tips and Techniques for Parsing XML	4-52
4.7.1	Extracting Node Values from a DOM Tree	4-52
4.7.2	Merging Documents with appendChild()	4-53
4.7.3	Parsing DTDs	4-54
4.7.4	Handling Character Sets with the XML Parser.....	4-57

5 Using Binary XML with Java

5.1	Introduction to Binary XML for Java.....	5-1
5.1.1	Binary XML Storage Format – Java.....	5-1
5.1.2	Binary XML Processors.....	5-2
5.2	Models for Using Binary XML.....	5-2
5.2.1	Usage Terminology for Binary XML	5-2
5.2.2	Standalone Model.....	5-2
5.2.3	Client/Server Model.....	5-3
5.2.4	Web Services Model With Repository.....	5-3
5.2.5	Web Services Model Without Repository.....	5-3
5.3	Components of Binary XML for Java.....	5-4
5.3.1	Binary XML Encoding	5-4
5.3.2	Binary XML Decoding	5-5

5.4	Binary XML Vocabulary Management	5-5
5.4.1	Schema Management	5-5
5.4.2	Token Management	5-6
5.5	Using the Java Binary XML Package	5-6
5.5.1	Binary XML Encoder.....	5-7
5.5.2	Binary XML Decoder	5-8
5.5.3	Schema Registration Overview	5-9
5.5.4	Resolving xsi:schemaLocation.....	5-9
5.5.5	Binary XML	5-9
5.5.6	Persistent Storage of Metadata	5-10

6 Using the XSLT Processor for Java

6.1	Introduction to the XSLT Processor	6-1
6.1.1	Prerequisites for Using the XSLT Processor for Java	6-1
6.1.2	Standards and Specifications for the XSLT Processor for Java.....	6-2
6.1.3	XML Transformation with XSLT 1.0 and 2.0.....	6-2
6.2	Using the XSLT Processor for Java: Overview	6-3
6.2.1	Using the XSLT Processor for Java: Basic Process	6-3
6.2.2	Running the XSLT Processor Demo Programs	6-4
6.2.3	Using the XSLT Processor Command-Line Utility.....	6-6
6.3	Transforming XML	6-8
6.3.1	Performing Basic XSL Transformation.....	6-8
6.3.2	Getting DOM Results from an XSL Transformation.....	6-10
6.4	Programming with Oracle XSLT Extensions	6-11
6.4.1	Overview of Oracle XSLT Extensions	6-11
6.4.2	Specifying Namespaces for XSLT Extension Functions	6-12
6.4.3	Using Static and Nonstatic Java Methods in XSLT	6-12
6.4.4	Using Constructor Extension Functions	6-13
6.4.5	Using Return Value Extension Functions.....	6-13
6.5	Tips and Techniques for Transforming XML	6-15
6.5.1	Merging XML Documents with XSLT.....	6-15
6.5.2	Creating an HTML Input Form Based on the Columns in a Table.....	6-16

7 Using the XQuery Processor for Java

7.1	Introduction to the XQuery Processor for Java	7-1
7.2	XQJ Entity Resolution	7-2
7.2.1	Resolution of Documents for fn:doc	7-3
7.2.2	Resolution of External XQuery Functions	7-5
7.2.3	Resolution of Imported XQuery Modules	7-8
7.2.4	Resolution of XML Schemas Imported by an XQuery Query	7-9
7.2.5	Prefabricated Entity Resolvers for XQuery	7-11
7.2.6	Resolution of Other Types of Entity	7-13
7.3	XQuery Output Declarations	7-13

7.4	Improving Application Performance and Scalability with XQuery.....	7-15
7.4.1	Streaming Query Evaluation	7-15
7.4.2	External Storage.....	7-17
7.4.3	Thread Safety for XQJ	7-18
7.5	Performing Updates	7-19
7.6	Oracle XQuery Functions and Operators.....	7-21
7.6.1	Oracle XQuery Functions for Duration, Date, and Time.....	7-22
7.6.2	Oracle XQuery Functions for Strings	7-26
7.7	Standards and Specifications for the XQuery Processor for Java	7-29
7.7.1	Optional XQuery Features	7-30
7.7.2	Implementation-Defined Items	7-30
8	Using XQuery API for Java to Access Oracle XML DB	
8.1	Introduction to Oracle XML DB Support for XQJ.....	8-1
8.1.1	Prerequisites for Using XQJ to Access Oracle XML DB.....	8-2
8.2	Examples: Using XQJ to Query Oracle XML DB.....	8-2
8.3	XQJ Support for Oracle XML DB.....	8-5
8.3.1	Other Oracle XML DB XQJ Support Limitations.....	8-7
8.4	XQJ Performance Considerations for Use with Oracle XML DB.....	8-8
9	Using the XML Schema Processor for Java	
9.1	Introduction to XML Validation.....	9-1
9.1.1	Prerequisites for Using the XML Schema Processor for Java	9-1
9.1.2	Standards and Specifications for the XML Schema Processor for Java	9-2
9.1.3	XML Validation with DTDs.....	9-2
9.1.4	XML Validation with XML Schemas.....	9-3
9.1.5	Differences Between XML Schemas and DTDs	9-6
9.2	Using the XML Schema Processor: Overview	9-7
9.2.1	Using the XML Schema Processor for Java: Basic Process	9-7
9.2.2	Running the XML Schema Processor Demo Programs	9-10
9.2.3	Using the XML Schema Processor Command-Line Utility.....	9-13
9.3	Validating XML with XML Schemas	9-13
9.3.1	Validating Against Internally Referenced XML Schemas	9-14
9.3.2	Validating Against Externally Referenced XML Schemas	9-15
9.3.3	Validating a Subsection of an XML Document.....	9-16
9.3.4	Validating XML from a SAX Stream	9-17
9.3.5	Validating XML from a DOM.....	9-18
9.3.6	Validating XML from Designed Types and Elements	9-19
9.4	Tips and Techniques for Programming with XML Schemas	9-21
9.4.1	Overriding the Schema Location with an Entity Resolver.....	9-21
9.4.2	Converting DTDs to XML Schemas.....	9-23

10 Using the JAXB Class Generator

10.1	Introduction to the JAXB Class Generator	10-1
10.1.1	Prerequisites for Using the JAXB Class Generator	10-1
10.1.2	Standards and Specifications for the JAXB Class Generator	10-2
10.1.3	JAXB Class Generator Features	10-2
10.1.4	Marshalling and Unmarshalling with JAXB	10-3
10.1.5	Validation with JAXB.....	10-3
10.1.6	JAXB Customization	10-4
10.2	Using the JAXB Class Generator: Overview	10-4
10.2.1	Using the JAXB Processor: Basic Process.....	10-5
10.2.2	Running the XML Schema Processor Demo Programs	10-7
10.2.3	Using the JAXB Class Generator Command-Line Utility.....	10-9
10.2.4	JAXB Features Not Supported in XDK.....	10-11
10.3	Processing XML with the JAXB Class Generator	10-11
10.3.1	Binding Complex Types	10-11
10.3.2	Customizing a Class Name in a Top-Level Element.....	10-15

11 Using the XML Pipeline Processor for Java

11.1	Introduction to the XML Pipeline Processor.....	11-1
11.1.1	Prerequisites for Using the XML Pipeline Processor for Java.....	11-1
11.1.2	Standards and Specifications for the XML Pipeline Processor for Java	11-2
11.1.3	Multistage XML Processing	11-2
11.1.4	Customized Pipeline Processes	11-3
11.2	Using the XML Pipeline Processor for Java: Overview.....	11-4
11.2.1	Using the XML Pipeline Processor for Java: Basic Process	11-4
11.2.2	Running the XML Pipeline Processor Demo Programs.....	11-8
11.2.3	Using the XML Pipeline Processor Command-Line Utility	11-10
11.3	Processing XML in a Pipeline	11-10
11.3.1	Creating a Pipeline Document.....	11-11
11.3.2	Writing a Pipeline Processor Application.....	11-12
11.3.3	Writing a Pipeline Error Handler.....	11-14

12 Determining XML Differences Using Java

12.1	Overview of XML Diffing Utilities for Java	12-1
12.2	User Options for the Java XML Diffing Library	12-2
12.3	Using Java XML Diffing Methods to Find Differences	12-3
12.3.1	About the append-node Operation	12-4
12.3.2	About the insert-node-before Operation	12-5
12.3.3	About the delete-node Operation	12-6
12.4	Invoking diff and difftoDoc Methods in a Java Application.....	12-7
12.5	Using Java XML hash and equal Methods to Identify and Compare Inputs.....	12-10
12.6	Diff Output Schema.....	12-10

13 Using the XML SQL Utility

13.1	Introduction to the XML SQL Utility (XSU)	13-1
13.1.1	Prerequisites for Using the XML SQL Utility (XSU)	13-1
13.1.2	XSU Features	13-2
13.1.3	XSU Restrictions	13-2
13.2	Using the XML SQL Utility: Overview	13-3
13.2.1	Using XSU: Basic Process	13-3
13.2.2	Installing XSU	13-8
13.2.3	Running the XSU Demo Programs	13-11
13.2.4	Using the XSU Command-Line Utility	13-15
13.3	Programming with the XSU Java API.....	13-19
13.3.1	Generating a String with OracleXMLQuery.....	13-20
13.3.2	Generating a DOM Tree with OracleXMLQuery	13-21
13.3.3	Paginating Results with OracleXMLQuery	13-21
13.3.4	Generating Scrollable Result Sets.....	13-23
13.3.5	Generating XML from Cursor Objects	13-24
13.3.6	Inserting Rows with OracleXMLSave	13-25
13.3.7	Updating Rows Using OracleXMLSave.....	13-27
13.3.8	Deleting Rows using XSU	13-30
13.3.9	Handling XSU Java Exceptions	13-32
13.4	Programming with the XSU PL/SQL API.....	13-33
13.4.1	Generating XML from Simple Queries with DBMS_XMLQuery.....	13-34
13.4.2	Specifying Element Names with DBMS_XMLQuery	13-34
13.4.3	Paginating Results with DBMS_XMLQUERY	13-34
13.4.4	Setting Stylesheets in XSU.....	13-35
13.4.5	Binding Values in XSU	13-35
13.4.6	Inserting XML using XSU	13-35
13.4.7	Updating using XSU	13-37
13.4.8	Deleting with XSU.....	13-39
13.4.9	Handling Exceptions with XSU.....	13-40
13.4.10	Reusing the Context Handle with XSU.....	13-40
13.5	Tips and Techniques for Programming with XSU.....	13-41
13.5.1	How XSU Maps Between SQL and XML.....	13-41
13.5.2	How XSU Processes SQL Statements	13-46

14 Using the TransX Utility

14.1	Introduction to the TransX Utility.....	14-1
14.1.1	Prerequisites for Using the TransX Utility.....	14-2
14.1.2	TransX Utility Features.....	14-2
14.2	Using the TransX Utility: Overview	14-3
14.2.1	Using the TransX Utility: Basic Process	14-3
14.2.2	Running the TransX Utility Demo Programs.....	14-6

14.2.3	Using the TransX Command-Line Utility.....	14-7
14.3	Loading Data with the TransX Utility	14-10
14.3.1	Storing Messages in the Database	14-10
14.3.2	Creation of a Data Set in a Predefined Format.....	14-11
14.3.3	Loading the Data	14-16
14.3.4	Querying the Data.....	14-17

15 Data Loading Format (DLF) Specification

15.1	Introduction to DLF.....	15-1
15.1.1	Naming Conventions for DLF.....	15-2
15.2	General Structure of DLF.....	15-2
15.2.1	Tree Structure of DLF	15-3
15.3	DLF Specifications	15-5
15.3.1	XML Declaration in DLF	15-5
15.3.2	Entity References in DLF.....	15-5
15.3.3	Elements in DLF	15-6
15.3.4	Attributes in DLF.....	15-9
15.4	DLF Examples	15-13
15.4.1	Minimal DLF Document	15-14
15.4.2	Typical DLF Document	15-14
15.4.3	Localized DLF Document	15-16

16 Using the XSQL Pages Publishing Framework

16.1	Introduction to the XSQL Pages Publishing Framework.....	16-1
16.1.1	Prerequisites for Using the XSQL Pages Publishing Framework	16-2
16.2	Using the XSQL Pages Publishing Framework: Overview	16-2
16.2.1	Using the XSQL Pages Framework: Basic Process	16-3
16.2.2	Setting Up the XSQL Pages Framework	16-5
16.2.3	Running the XSQL Pages Demo Programs	16-8
16.2.4	Using the XSQL Pages Command-Line Utility.....	16-12
16.3	Generating and Transforming XML with XSQL Servlet.....	16-13
16.3.1	Composing XSQL Pages.....	16-13
16.3.2	Producing Datagrams from SQL Queries.....	16-19
16.3.3	Transforming XML Datagrams into an Alternative XML Format	16-20
16.3.4	Transforming XML Datagrams into HTML for Display	16-23
16.4	Using XSQL in Java Programs	16-24
16.5	XSQL Pages Tips and Techniques	16-25
16.5.1	XSQL Pages Limitations	16-26
16.5.2	Hints for Using the XSQL Servlet	16-26
16.5.3	Resolving Common XSQL Connection Errors.....	16-30
16.5.4	Security Considerations for XSQL Pages.....	16-31

17 Using the XSQL Pages Publishing Framework: Advanced Topics

17.1	Customizing the XSQL Configuration File Name	17-1
17.2	Controlling How Stylesheets Are Processed	17-2
17.2.1	Overriding Client Stylesheets.....	17-2
17.2.2	Controlling the Content Type of the Returned Document.....	17-3
17.2.3	Assigning the Stylesheet Dynamically	17-3
17.2.4	Processing XSLT Stylesheets in the Client	17-4
17.2.5	Providing Multiple Stylesheets	17-5
17.3	Working with Array-Valued Parameters	17-6
17.3.1	Supplying Values for Array-Valued Parameters.....	17-6
17.3.2	Setting Array-Valued Page or Session Parameters from Strings.....	17-7
17.3.3	Binding Array-Valued Parameters in SQL and PL/SQL Statements.....	17-8
17.4	Setting Error Parameters on Built-In Actions	17-10
17.4.1	Using Conditional Logic with Error Parameters	17-11
17.4.2	Formatting XSQL Action Handler Errors	17-12
17.5	Including XMLType Query Results in XSQL Pages	17-12
17.6	Handling Posted XML Content	17-14
17.6.1	Understanding XML Posting Options.....	17-15
17.7	Producing PDF Output with the FOP Serializer	17-17
17.8	Performing XSQL Customizations	17-18
17.8.1	Writing Custom XSQL Action Handlers	17-18
17.8.2	Implementing Custom XSQL Serializers	17-22
17.8.3	Using a Custom XSQL Connection Manager for JDBC Data Sources	17-25
17.8.4	Writing Custom XSQL Connection Managers.....	17-26
17.8.5	Implementing a Custom XSQLErrorHandler	17-27
17.8.6	Providing a Custom XSQL Logger Implementation.....	17-28

Part II Oracle XML Developer's Kit for C

18 Getting Started with Oracle XML Developer's Kit for C

18.1	Installing XDK for C Components	18-1
18.2	Configuring the UNIX Environment for XDK for C Components.....	18-2
18.2.1	XDK for C Component Dependencies on UNIX	18-3
18.2.2	Setting Up XDK for C Environment Variables on UNIX	18-4
18.2.3	Testing the XDK for C Runtime Environment on UNIX.....	18-4
18.2.4	Setting Up and Testing the XDK C Compile-Time Environment on UNIX	18-5
18.2.5	Verifying the XDK for C Component Version on UNIX	18-6
18.3	Configuring the Windows Environment for XDK C Components	18-6
18.3.1	XDK for C Component Dependencies on Windows.....	18-6
18.3.2	Setting Up XDK for C Environment Variables on Windows.....	18-7
18.3.3	Testing the XDK for C Runtime Environment on Windows	18-7
18.3.4	Setting Up and Testing the XDK for C Compile-Time Environment on Windows	18-8

18.3.5	Using the XDK for C Components and Visual C++ in Microsoft Visual Studio	18-9
18.4	Overview of the Unified C API	18-12
18.5	Globalization Support for the XDK for C Components	18-13

19 Using the XSLT and XVM Processors for C

19.1	XSLT XVM Processor	19-1
19.1.1	XVM Usage Example	19-2
19.1.2	Using the XVM Processor Command-Line Utility	19-3
19.1.3	Accessing the XVM Processor for C	19-3
19.2	XSLT Processor for XDK for C	19-3
19.2.1	XSLT Processor Usage Example	19-4
19.2.2	XPath Processor Usage Example	19-4
19.2.3	Using the C XSLT Processor Command-Line Utility	19-5
19.2.4	Accessing Oracle XSLT processor for C	19-6
19.3	Using the Demo Files Included with the Software	19-6
19.3.1	Building the C Demo Programs for XSLT	19-7

20 Using the XML Parser for C

20.1	Introduction to the XML Parser for C	20-1
20.1.1	Prerequisites for Using the XML Parser for C	20-1
20.1.2	Standards and Specifications for the XML Parser for C	20-2
20.2	Using the XML Parser API for C	20-2
20.2.1	Overview of the Parser API for C	20-2
20.2.2	XML Parser for C Calling Sequence	20-4
20.2.3	Using the XML Parser for C: Basic Process	20-6
20.2.4	Running the XML Parser for C Demo Programs	20-7
20.2.5	Using the C XML Parser Command-Line Utility	20-9
20.3	Using the DOM API for C	20-11
20.3.1	Controlling the Data Encoding of XML Documents for the C API	20-11
20.3.2	Using NULL-Terminated and Length-Encoded C API Functions	20-12
20.3.3	Handling Errors with the C API	20-13
20.4	Using orastream Functions	20-13
20.5	Using the SAX API for C	20-16
20.6	Using the XML Pull Parser for C	20-16
20.6.1	Using Basic XML Pull Parsing Capabilities	20-17
20.6.2	Parsing Multiple XML Documents	20-18
20.6.3	ID Callback	20-18
20.6.4	Error Handling for the XML Pull Parser	20-19
20.6.5	Sample Pull Parser Application	20-19
20.7	Using OCI and the XDK for C API	20-21
20.7.1	Using XMLType Functions and Descriptions	20-21
20.7.2	Initializing an XML Context for Oracle XML DB	20-22
20.7.3	Creating XMLType Instances on the Client	20-23

20.7.4	Operating on XML Data in the Database Server	20-23
20.7.5	Using OCI and the XDK for C API: Examples	20-23
21	Using Binary XML with C	
21.1	Introduction to Binary XML for C	21-1
21.2	Prerequisites for Using Binary XML with C	21-1
21.3	Binary XML Storage Format – C.....	21-1
22	Using the XML Schema Processor for C	
22.1	Oracle XML Schema Processor for C	22-1
22.1.1	Oracle XML Schema for C Features.....	22-2
22.1.2	Standards Conformance for Oracle XML Schema Processor for C.....	22-2
22.1.3	XML Schema Processor for C: Supplied Software.....	22-2
22.2	Using the C XML Schema Processor Command-Line Utility	22-3
22.3	XML Schema Processor for C Usage Diagram	22-3
22.4	How to Run XML Schema for C Sample Programs.....	22-4
22.5	What Is the Streaming Validator?	22-5
22.5.1	Using Transparent Mode	22-5
22.5.2	Using Opaque Mode	22-7
22.5.3	Using Function XmlSchemaLoad() With an Existing DOM	22-8
22.5.4	Validation Options	22-8
23	Determining XML Differences Using C	
23.1	Overview of XMLDiff in C	23-1
23.1.1	Process Flow for XMLDiff.....	23-1
23.2	Using XmlDiff	23-2
23.2.1	User Options for Comparison Optimization.....	23-2
23.2.2	User Option for Hashing.....	23-2
23.2.3	How XmlDiff Looks at Input Documents.....	23-2
23.2.4	Using the XmlDiff Command-Line Utility	23-3
23.2.5	Sample Input Document	23-3
23.2.6	Sample Xdiff Instance Document.....	23-4
23.2.7	Output Model and XML Processing Instructions.....	23-5
23.2.8	Xdiff Operations	23-5
23.2.9	Format of Xdiff Instance Document	23-6
23.2.10	Xdiff Schema	23-7
23.2.11	Using XMLDiff in an Application.....	23-9
23.2.12	Customized Output	23-10
23.3	Using XmlPatch.....	23-11
23.3.1	Using the XmlPatch Command-Line Utility	23-11
23.3.2	Using XmlPatch in an Application	23-12
23.4	Using XmlHash	23-13
23.4.1	Invoking XmlDiff and XmlPatch.....	23-14

24	Using SOAP with the Oracle XML Developer's Kit for C	
24.1	Introduction to SOAP for C.....	24-1
24.1.1	SOAP Messaging Overview.....	24-2
24.1.2	Using SOAP Clients.....	24-4
24.1.3	Using SOAP Servers.....	24-5
24.2	SOAP C Functions.....	24-5
24.3	SOAP Example 1: Sending an XML Document.....	24-7
24.4	SOAP Example 2: A Response Asking for Clarification.....	24-12
24.5	SOAP Example 3: Using POST.....	24-14

Part III Oracle XML Developer's Kit for C++

25	Getting Started with Oracle XML Developer's Kit for C++	
25.1	Installing the XDK for C++ Components.....	25-1
25.2	Configuring the UNIX Environment for XDK for C++ Components.....	25-1
25.2.1	XDK for C++ Component Dependencies on UNIX.....	25-1
25.2.2	Setting Up XDK for C++ Environment Variables on UNIX.....	25-2
25.2.3	Testing the XDK for C++ Runtime Environment on UNIX.....	25-2
25.2.4	Setting Up and Testing the XDK for C++ Compile-Time Environment on UNIX..	25-2
25.2.5	Verifying the XDK for C++ Component Version on UNIX.....	25-3
25.3	Configuring the Windows Environment for XDK for C++ Components.....	25-3
25.3.1	XDK for C++ Component Dependencies on Windows.....	25-3
25.3.2	Setting Up XDK for C++ Environment Variables on Windows.....	25-4
25.3.3	Testing the XDK for C++ Runtime Environment on Windows.....	25-4
25.3.4	Setting Up and Testing the XDK for C++ Compile-Time Environment on Windows.....	25-4
25.3.5	Using the XDK for C++ Components with Visual C/C++.....	25-4

26	Overview of the Unified C++ Interfaces	
26.1	What Is the Unified C++ API?.....	26-1
26.2	Accessing the C++ Interface.....	26-2
26.3	OracleXML Namespace.....	26-2
26.3.1	OracleXML Interfaces.....	26-2
26.4	Ctx Namespace.....	26-2
26.4.1	OracleXML Data Types.....	26-2
26.4.2	Ctx Interfaces.....	26-3
26.5	IO Namespace.....	26-3
26.5.1	IO Data Types.....	26-3
26.5.2	IO Interfaces.....	26-3
26.6	Tools Package.....	26-4
26.6.1	Tools Interfaces.....	26-4
26.7	Error Message Files.....	26-4

27	Using the XML Parser for C++	
27.1	Introduction to Oracle XML Parser for C++	27-1
27.2	DOM Namespace.....	27-2
27.2.1	DOM Data Types.....	27-2
27.2.2	DOM Interfaces.....	27-2
27.2.3	DOM Traversal and Range Data Types	27-3
27.2.4	DOM Traversal and Range Interfaces	27-3
27.3	Parser Namespace.....	27-3
27.3.1	GParser Interface	27-4
27.3.2	DOMParser Interface	27-4
27.3.3	SAXParser Interface	27-4
27.4	Thread Safety for the XML Parser for C++	27-4
27.5	XML Parser for C++ Usage	27-4
27.6	XML Parser for C++ Default Behavior	27-4
27.7	C++ Sample Files	27-5
28	Using the XSLT Processor for C++	
28.1	Accessing XSLT for C++	28-1
28.2	XSL Namespace.....	28-1
28.2.1	XSL Interfaces	28-1
28.3	XSLT for C++ DOM Interface Usage	28-2
28.4	Invoking XSLT for C++.....	28-2
28.4.1	Command-Line Usage.....	28-2
28.4.2	Writing C++ Code to Use Supplied APIs	28-2
28.5	Using the Sample Files Included with the Software.....	28-3
29	Using the XML Schema Processor for C++	
29.1	Oracle XML Schema Processor for C++	29-1
29.1.1	Oracle XML Schema for C++ Features.....	29-1
29.1.2	Standards Conformance for Oracle XML Schema Processor for C++	29-2
29.2	XML Schema Processor API.....	29-2
29.2.1	Invoking XML Schema Processor for C++	29-2
29.3	Running the Provided XML Schema for C++ Sample Programs	29-3
30	Using the XPath Processor for C++	
30.1	XPath Interfaces	30-1
30.2	Sample Programs	30-1
31	Using the XML Class Generator for C++	
31.1	Accessing the XML C++ Class Generator	31-1
31.2	Using the XML C++ Class Generator	31-1
31.2.1	External DTD Parsing.....	31-1

31.3	Using the XML C++ Class Generator Command-Line Utility	31-1
31.3.1	Input to the XML C++ Class Generator	31-2
31.4	Using the XML C++ Class Generator Examples	31-2
31.4.1	XML C++ Class Generator Example 1: XML — Input File to Class Generator, CG.xml.....	31-3
31.4.2	XML C++ Class Generator Example 2: DTD — Input File to Class Generator, CG.dtd	31-3
31.4.3	XML C++ Class Generator Example 3: CG Sample Program	31-3

Part IV Oracle XML Developer's Kit Reference

32 XSQL Pages Reference

32.1	XSQL Configuration File Parameters	32-3
32.2.1	<xsql:action>.....	32-7
32.2.2	<xsql:delete-request>	32-8
32.2.3	<xsql:dml>	32-10
32.2.4	<xsql:if-param>	32-11
32.2.5	<xsql:include-owa>	32-13
32.2.6	<xsql:include-param>	32-14
32.2.7	<xsql:include-posted-include-posted>	32-15
32.2.8	<xsql:include-request-params>	32-16
32.2.9	<xsql:include-xml>	32-17
32.2.10	<xsql:include-xsql>.....	32-18
32.2.11	<xsql:insert-param>	32-20
32.2.12	<xsql:insert-request>	32-21
32.2.13	<xsql:query>	32-23
32.2.14	<xsql:ref-cursor-function>.....	32-26
32.2.15	<xsql:set-cookie>.....	32-28
32.2.16	<xsql:set-page-param>.....	32-30
32.2.17	<xsql:set-session-param>.....	32-32
32.2.18	<xsql:set-stylesheet-param>.....	32-34
32.2.19	<xsql:update-request>	32-36

33 Oracle XML Developer's Kit Standards

33.1	XML Standards Supported by XDK.....	33-1
33.1.1	Summary of XML Standards Supported by XDK	33-1
33.1.2	XML Standards for XDK for Java.....	33-3
33.2	Character Sets Supported by XDK	33-5
33.2.1	Character Sets Supported by XDK for Java	33-5
33.2.2	Character Sets Supported by XDK for C.....	33-6

A XDK for Java XML Error Messages

A.1	XML Parser Error Messages	A-1
-----	---------------------------------	-----

A.2	DOM Error Messages	A-12
A.3	XSLT Error Messages.....	A-16
A.4	XPath Error Messages.....	A-20
A.5	XML Schema Validation Error Messages	A-25
A.6	Schema Representation Constraint Error Messages	A-35
A.7	Schema Component Constraint Error Messages.....	A-41
A.8	XSQL Server Pages Error Messages	A-50
A.9	XML Pipeline Error Messages	A-51
A.10	JAXB Error Messages.....	A-53

B XDK for Java TXU Error Messages

B.1	DLF Error Messages	B-1
B.2	TransX Informational Messages	B-3
B.3	TransX Error Messages	B-3
B.4	Assertion Error Messages	B-4

C XDK for Java XSU Error Messages

C.1	Generic Error Messages.....	C-1
C.2	Query Error Messages	C-2
C.3	DML Error Messages	C-3

D Oracle XML Developer's Kit JavaBeans (Deprecated)

D.1	Introduction to XDK JavaBeans	D-1
	D.1.1 Prerequisites for Using XDK JavaBeans.....	D-1
	D.1.2 Standards and Specifications for XDK JavaBeans	D-2
	D.1.3 XDK JavaBeans Features.....	D-2
D.2	Using XDK JavaBeans: Overview	D-5
	D.2.1 Using XDK JavaBeans: Basic Process.....	D-6
	D.2.2 Running XDK JavaBean Demo Programs.....	D-12
D.3	Processing XML with XDK JavaBeans	D-21
	D.3.1 Processing XML Asynchronously with the DOMBuilder and XSLTransformer Beans..	D-21
	D.3.2 Comparing XML Documents with the XMLDiff JavaBean	D-26

Glossary

Index

List of Examples

1-1	Oracle XML Developer's Kit Components.....	1-18
3-1	Oracle XML Developer's Kit for Java Libraries, Utilities, and Demos.....	3-2
3-2	Testing the Oracle XML Developer's Kit for Java Environment on UNIX.....	3-7
3-3	Testing the Oracle XML Developer's Kit for Java Environment on Windows.....	3-9
3-4	XDKVersion.java.....	3-9
4-1	Sample XML Document.....	4-4
4-2	Sample XML Document Without Namespaces.....	4-9
4-3	Sample XML Document with Namespaces.....	4-9
4-4	Extracting Contents of a DOM Tree with selectNodes().....	4-52
4-5	Incorrect Use of appendChild().....	4-54
4-6	Merging Documents with appendChild.....	4-54
4-7	DTDSample.java.....	4-55
4-8	Converting XML in a String.....	4-59
4-9	Parsing a Document with Accented Characters.....	4-60
6-1	math.xml.....	6-8
6-2	math.xsl.....	6-8
6-3	math.htm.....	6-8
6-4	Using a Static Function in an XSLT Stylesheet.....	6-13
6-5	Using a Constructor in an XSLT Stylesheet.....	6-13
6-6	gettext.xsl.....	6-14
6-7	msg_w_num.xml.....	6-15
6-8	msg_w_text.xml.....	6-15
6-9	msgmerge.xsl.....	6-16
6-10	msgmerge.xml.....	6-16
7-1	Simple Query Using XQJ.....	7-2
7-2	books.xml.....	7-3
7-3	books.xq.....	7-3
7-4	Executing a Query with a Custom Entity Resolver.....	7-3
7-5	trim.xq.....	7-5
7-6	Defining the Implementation of an External XQuery Function.....	7-5
7-7	Binding an External Function to a Java Static Method.....	7-6
7-8	math.xq.....	7-8
7-9	main.xq.....	7-8
7-10	Executing a Query that Imports a Library Module.....	7-8
7-11	size.xsd.....	7-10
7-12	size.xq.....	7-10
7-13	Executing an XQuery Query that Imports an XML Schema.....	7-10
7-14	Executing a Query with a Prefabricated File Resolver.....	7-12
7-15	Accessing the Values of Option Declarations.....	7-14
7-16	Using Option Declarations When Serializing a Query Result.....	7-14
7-17	books2.xq.....	7-16
7-18	Facilitating Streaming Evaluation.....	7-16
7-19	Configuring the XQuery Processor to Use External Storage.....	7-18
7-20	configuration.xml.....	7-20
7-21	update.xq.....	7-20
7-22	Updated File configuration.xml	7-20
7-23	Executing the Updating Query update.xq.....	7-21
8-1	Using XQJ to Query an XML DB Table with XQuery.....	8-4
8-2	Using XQJ to Query the XML DB Repository with XQuery.....	8-4
9-1	family.dtd.....	9-3
9-2	family.xml.....	9-3

9-3	report.xml.....	9-4
9-4	report.xsd.....	9-5
9-5	Using oraxml to Validate Against a Schema.....	9-13
9-6	Using oraxml to Validate Against a DTD.....	9-13
10-1	sample3.xml.....	10-12
10-2	sample3.xsd.....	10-12
10-3	Address.java.....	10-13
10-4	sample10.xml.....	10-15
10-5	sample10.xsd.....	10-15
10-6	BusinessType.java.....	10-17
11-1	pipedoc.xml.....	11-11
12-1	Appending a Node.....	12-5
12-2	Inserting a Node.....	12-6
12-3	Deleting a Node.....	12-6
12-4	Getting a diff as a Document from a Java Application.....	12-8
12-5	Getting a diff Using DiffOpReceiver from a Java Application.....	12-8
12-6	Diff Output Schema: xdiff.xsd.....	12-10
13-1	Specifying skipRows and maxRows on the Command Line.....	13-22
13-2	upd_emp.xml.....	13-28
13-3	insertClob.sql.....	13-36
13-4	insertEmployee.sql.....	13-36
13-5	Form of the INSERT Statement.....	13-36
13-6	insertClob2.sql.....	13-37
13-7	insertEmployee2.sql.....	13-37
13-8	insertClob3.sql.....	13-38
13-9	updateEmployee.sql.....	13-38
13-10	updateEmployee2.sql.....	13-39
13-11	Deleting by Row.....	13-39
13-12	Deleting by Key.....	13-40
13-13	XSU-Generated Sample Document.....	13-42
13-14	customer.xml.....	13-45
13-15	createRelSchema.sql.....	13-46
14-1	Structure of Table translated_messages.....	14-10
14-2	Query of translated_messages.....	14-11
14-3	example.xml.....	14-11
14-4	example.xml with a Language Attribute.....	14-13
14-5	dateTime Row.....	14-14
14-6	example_es.xml.....	14-15
14-7	example_es.xml with a Language Attribute.....	14-15
14-8	txdemo1.java.....	14-17
15-1	DLF Tree Structure.....	15-3
15-2	Minimal DLF Document.....	15-14
15-3	Sample DLF Document.....	15-14
15-4	DLF with Localization.....	15-16
16-1	Sample XSQL Page.....	16-2
16-2	Connection Definitions Section of XSQLConfig.xml.....	16-8
16-3	Sample XSQL Page in AvailableFlightsToday.xsql.....	16-14
16-4	Wrapping the <xsql:query> Element.....	16-14
16-5	Bind Variables in CustomerPortfolio.xsql.....	16-15
16-6	Bind Variables with Action Elements in CustomerPortfolio.xsql.....	16-15
16-7	Lexical Substitution Parameters for Rows and Columns in DevOpenBugs.xsql.....	16-16
16-8	Lexical Substitution Parameters for Connections and Stylesheets in DevOpenBugs.xsql.....	16-16
16-9	Setting a Default Value.....	16-18

16-10	Setting Multiple Default Values.....	16-18
16-11	Defaults for Bind Variables.....	16-18
16-12	Bind Variables with No Defaults.....	16-18
16-13	Industry Standard Formats in flight-list.xml.....	16-22
16-14	Stylesheet Association in flight-list.xml.....	16-22
16-15	Query Results in flight-display.xml.....	16-24
16-16	XSQLRequestSample Class.....	16-25
16-17	Conditional Statements in XSQL Pages.....	16-27
16-18	Passing Values Among SQL Queries.....	16-27
16-19	Handling Multivalued Parameters.....	16-28
16-20	Using Multivalued Page Parameters in a SQL Statement.....	16-28
16-21	addmult PL/SQL Procedure.....	16-29
16-22	addmultwrapper PL/SQL Procedure.....	16-29
16-23	addmult.xml.....	16-29
16-24	Getting the Name of the Current XSQL Page.....	16-30
17-1	empToExcel.xml.....	17-3
17-2	emp_test.xml.....	17-4
17-3	emp_test_dynamic.xml.....	17-4
17-4	Multiple <?xml-stylesheet ?> Processing Instructions.....	17-6
17-5	Using an Array-Valued Parameter in an XSQL Page.....	17-7
17-6	testTableFunction.....	17-10
17-7	XSQL Page with Array-Valued Parameters.....	17-10
17-8	Using an Array-Valued Parameter to Restrict Rows.....	17-10
17-9	Setting an Error Parameter.....	17-11
17-10	Achieving Conditional Behavior with an Error Parameter.....	17-11
17-11	XSLT Stylesheet.....	17-12
17-12	Aggregating a Dynamically-Constructed XML Document.....	17-13
17-13	Movie XML Document.....	17-14
17-14	Using XPath to Extract an Aggregate List.....	17-14
17-15	Including an XMLType Query Result.....	17-14
17-16	Using XSQL Bind Variables in an XPath Expression.....	17-14
17-17	XML Document Generated from HTML Form.....	17-17
17-18	Source Code for FOP Serializer.....	17-17
17-19	MyIncludeXSQLHandler.java.....	17-21
17-20	Testing for the Servlet Request.....	17-22
17-21	Custom Serializer.....	17-23
17-22	Assigning Short Names to Custom Serializers.....	17-24
17-23	Writing a Dynamic GIF Image.....	17-24
17-24	myErrorHandler class.....	17-28
17-25	SampleCustomLogger Class.....	17-28
17-26	SampleCustomLoggerFactory Class.....	17-29
17-27	Registering a Custom Logger Factory.....	17-29
18-1	Oracle XML Developer's Kit for C Libraries, Header Files, Utilities, and Demos.....	18-2
18-2	Editing an Oracle XML Developer's Kit for C Make.bat File on Windows.....	18-8
20-1	NSExample.xml.....	20-10
20-2	xml.out.....	20-11
20-3	Using orastream Functions.....	20-14
20-4	XML Event Context.....	20-17
20-5	Sample Pull Parser Application Example.....	20-19
20-6	Sample Document to Parse.....	20-20
20-7	Events Generated by Parsing a Sample Document.....	20-20
20-8	Constructing a Schema-Based Document with the DOM API.....	20-23
20-9	Modifying a Database Document with the DOM API.....	20-25
22-1	Streaming Validator in Transparent Mode.....	22-6

22-2	Example of Streaming Validator in Opaque Mode.....	22-7
22-3	XmlSchemaLoad() Example.....	22-8
22-4	Example of Streaming Validator Using New Options.....	22-9
23-1	book1.xml.....	23-3
23-2	Sample Xdiff Instance Document.....	23-4
23-3	Xdiff Schema: xdiff.xsd.....	23-7
23-4	XMLDiff Application.....	23-9
23-5	Customized XMLDiff Output.....	23-11
23-6	Sample Application for XmlPatch.....	23-12
23-7	XmlHash Program.....	23-13
24-1	SOAP Request Message.....	24-3
24-2	SOAP Response Message.....	24-4
24-3	SOAP C Functions Defined in xmlsoap.h.....	24-5
24-4	Example 1 SOAP Message.....	24-8
24-5	Example 1 SOAP C Client.....	24-8
24-6	Example 2 SOAP Message.....	24-12
24-7	Example 2 SOAP C Client.....	24-13
24-8	Example 3 SOAP Message.....	24-14
24-9	Example 3 SOAP C Client.....	24-14

List of Figures

1-1	Sample XML Processor.....	1-4
1-2	XML Parsers for Java, C, and C+.....	1-5
1-3	Oracle JAXB Class Generator.....	1-7
1-4	XSU Processes SQL Queries and Returns the Result as XML.....	1-8
1-5	XSQL Pages Publishing Framework.....	1-9
1-6	XSLT Virtual Machine.....	1-10
1-7	Sample XML Processor Built with Java Oracle XML Developer's Kit Components.....	1-12
1-8	Generating XML Documents Using Oracle XML Developer's Kit C Components.....	1-13
1-9	Generating XML Documents Using Oracle XML Developer's Kit C++ Components....	1-14
1-10	Oracle XML Developer's Kit Tools and Frameworks.....	1-15
3-1	Oracle XML Developer's Kit for Java Component Dependencies for JDK 5.....	3-3
4-1	XML Parser Process.....	4-4
4-2	Comparing DOM (Tree-Based) and SAX (Event-Based) APIs.....	4-8
4-3	XML Parser for Java.....	4-12
4-4	Basic Architecture of the DOM Parser.....	4-18
4-5	Using the SAXParser Class.....	4-38
4-6	SAX Parsing with JAXP.....	4-45
4-7	DOM Parsing with JAXP.....	4-45
5-1	Binary XML Encoding.....	5-8
5-2	Binary XML Decoder.....	5-8
6-1	Using the XSLT Processor for Java.....	6-4
9-1	XML Schema Processor for Java.....	9-9
10-1	JAXB Class Generator for Java.....	10-6
11-1	Pipeline Processing.....	11-2
11-2	Using the Pipeline Processor for Java.....	11-6
13-1	Generating XML with XSU.....	13-3
13-2	Storing XML in the Database Using XSU.....	13-5
13-3	Running XSU in the Database.....	13-9
13-4	Running XSU in the Middle Tier.....	13-10
13-5	Running XSU in a Web Server.....	13-11
14-1	Basic Process of a TransX Application.....	14-4
16-1	XSQL Pages Framework Architecture.....	16-3
16-2	Web Access to XSQL Pages.....	16-4
16-3	XSQL Home Page.....	16-12
16-4	XML Result from XSQL Page (AvailableFlightsToday.xsql) Query.....	16-20
16-5	Exploring flight-list.dtd with XML Authority.....	16-21
16-6	XSQL Page Results in XML Format.....	16-22
16-7	Using an XSLT Stylesheet to Render HTML.....	16-23
18-1	The Property Pages.....	18-10
18-2	Setting the Include Path in Visual C+.....	18-10
18-3	Setting the Static Library Path in Visual C+.....	18-11
18-4	Setting the Names of the Libraries in Visual C++ Project.....	18-11
20-1	XML Parser for C Calling Sequence.....	20-5
22-1	XML Schema Processor for C Usage Diagram.....	22-4
D-1	DOMBuilder JavaBean Usage.....	D-7
D-2	XSLTransformer JavaBean Usage.....	D-9
D-3	XMLDBAccess JavaBean Usage.....	D-10
D-4	XMLDiff JavaBean Usage.....	D-12

List of Tables

1-1	Overview of Oracle XML Developer's Kit Components	1-2
1-2	XDK for Java Components for Generating XML.....	1-11
2-1	Deprecated XDB Package Classes and Their Unified Java API Equivalents.....	2-2
2-2	Deprecated XMLType Methods and Their Unified Java API Equivalents.....	2-3
2-3	XMLDocument Output Based on KIND and CONNECTION.....	2-4
3-1	Java Libraries for Oracle XML Developer's Kit for Java Components	3-3
3-2	UNIX Environment Variables for Oracle XML Developer's Kit for Java Components ...	3-6
3-3	Oracle XML Developer's Kit for Java UNIX Utilities	3-6
3-4	Windows Environment Variables for Oracle XML Developer's Kit for Java Components	3-7
3-5	Oracle XML Developer's Kit for Java Windows Utilities	3-8
4-1	XML Parser for Java Validation Modes	4-10
4-2	XML Compression with DOM and SAX.....	4-11
4-3	Java Parser Demos.....	4-13
4-4	oraxml Command-Line Options	4-16
4-5	DOMParser Configuration Methods.....	4-21
4-6	Some Interfaces Implemented by XMLDocument.....	4-21
4-7	Methods for Getting and Manipulating DOM Tree Nodes.....	4-21
4-8	ACCESS_MODE Attribute Values.....	4-27
4-9	Range Class Methods.....	4-32
4-10	Static Fields in the NodeFilter Interface.....	4-34
4-11	TreeWalker Interface Methods.....	4-34
4-12	SAX 2.0 Handler Interfaces.....	4-37
4-13	SAX 2.0 Helper Classes.....	4-37
4-14	SAXParser Methods for Registering Event Handlers.....	4-39
4-15	XMLTokenizer Methods.....	4-43
4-16	JAXP Packages.....	4-44
6-1	XSLT Processor Sample Files	6-4
6-2	Command-Line Options for oraxsl.....	6-6
6-3	XSLProcessor Methods.....	6-9
6-4	XMLDocumentFragment Methods.....	6-11
7-1	Descriptions of Various Types of Entity.....	7-13
7-2	XQuery Optional Features Supported by XDK.....	7-30
7-3	XQJ Implementation-Defined Items.....	7-30
7-4	XQuery Implementation-Defined Items.....	7-31
7-5	XQuery Update Facility Implementation-Defined Items.....	7-34
7-6	Default Initial Values for the Static Context.....	7-35
8-1	OXQDDataSource Properties.....	8-5
8-2	Oracle XML DB Support for Optional XQJ Features.....	8-6
9-1	Feature Comparison Between XML Schema and DTD.....	9-6
9-2	oracle.xml.parser.schema Classes.....	9-8
9-3	XML Schema Sample Files	9-10
10-1	javax.xml.bind Classes and Interfaces.....	10-5
10-2	JAXB Class Generator Demos.....	10-7
10-3	orajaxb Command-Line Options	10-9
11-1	Methods in Class oracle.xml.pipeline.controller.Process.....	11-3
11-2	Classes in oracle.xml.pipeline.processes.....	11-4
11-3	PipelineProcessor Methods.....	11-6
11-4	Pipeline Processor Sample Files	11-8
11-5	orapipeline Command-Line Options.....	11-10
11-6	PipelineErrorHandler Methods.....	11-14

13-1	XSU Sample Files	13-11
13-2	getXML Options.....	13-16
13-3	putXML Options	13-17
14-1	TransX Utility Features.....	14-3
14-2	TransX Configuration Methods.....	14-5
14-3	TransX Utility Sample Files	14-6
14-4	TransX Utility Command-Line Options	14-8
14-5	TransX Utility Command-Line Parameters	14-9
14-6	<column> Attributes.....	14-12
14-7	date and dateTime Formats.....	14-13
15-1	Notation for Occurrence of Attributes and Elements.....	15-3
15-2	Entity References.....	15-6
15-3	DLF Elements.....	15-6
15-4	Top-Level Table Element.....	15-7
15-5	Translation Elements.....	15-7
15-6	Lookup Key Elements.....	15-7
15-7	Metadata Elements.....	15-8
15-8	Data Elements.....	15-8
15-9	Attributes.....	15-9
15-10	DLF Attributes.....	15-9
15-11	XML Namespace Attributes.....	15-13
16-1	XSQL Servlet Demos	16-8
17-1	Pseudo-Attributes for <?xml-stylesheet ?>	17-5
17-2	Helpful Methods in the XSQLActionHandlerImpl Class.....	17-19
18-1	Dependent Libraries of Oracle XML Developer's Kit for C Components on UNIX	18-3
18-2	UNIX Environment Settings for Oracle XML Developer's Kit for C Components	18-4
18-3	Oracle XML Developer's Kit for C/C++ Utilities on UNIX.....	18-4
18-4	Header Files in the Oracle XML Developer's Kit for C Compile-Time Environment....	18-5
18-5	Dependent Libraries of Oracle XML Developer's Kit for C Components on Windows	18-7
18-6	Windows Environment Settings for Oracle XML Developer's Kit for C Components ..	18-7
18-7	Oracle XML Developer's Kit for C/C++ Utilities on Windows.....	18-8
18-8	Summary of Oracle XML Developer's Kit for C APIs.....	18-12
19-1	XSLT Processor for C: Command Line Options	19-5
19-2	XSLT for C Demo Files	19-6
20-1	Interfaces for XML, DOM, and SAX APIs.....	20-3
20-2	Data Types Used in the XML Parser for C	20-3
20-3	C Parser Demos.....	20-8
20-4	C XML Parser Command-Line Options	20-9
20-5	NULL-Terminated and Length-Encoded C API Functions	20-12
20-6	XMLType Functions	20-21
22-1	XML Schema Processor for C: Supplied Files in \$ORACLE_HOME.....	22-2
22-2	XML Schema Processor for C: Supplied Libraries	22-3
22-3	XML Schema for C Samples Provided	22-4
23-1	XmlDiff Command-Line Options for the C Language.....	23-3
23-2	Xdiff Operation Attributes.....	23-6
23-3	XmlPatch for C Command-Line Options.....	23-11
25-1	Header Files in the XDK for C++ Compile-Time Environment.....	25-2
27-1	XML Parser for C++ Sample Files	27-5
28-1	XSLT for C++ Sample Files	28-3
29-1	XML Schema Processor for C++ Command-Line Options	29-2
29-2	XML Schema Processor for C++ Samples Provided	29-3
31-1	C++ Class Generator Options	31-2
31-2	XML C++ Class Generator Files	31-3
32-1	Built-In XSQL Elements and Action Handler Classes	32-1

32-2	XSQL Configuration File Settings	32-3
32-3	Attributes for <xsql:delete-request>	32-9
32-4	Attributes for <xsql:dml>	32-10
32-5	Attributes for <xsql:if-param>	32-12
32-6	Attributes for <xsql:include-owa>	32-13
32-7	Attributes for <xsql:include-xml>	32-18
32-8	Attributes for <xsql:include-xsql>	32-19
32-9	Attributes for <xsql:insert-param>	32-21
32-10	Attributes for <xsql:insert-request>	32-22
32-11	Attributes for <xsql:query>	32-24
32-12	Attributes for <xsql:set-cookie>	32-28
32-13	Attributes for <xsql:set-page-param>	32-31
32-14	Attributes for <xsql:set-session-param>	32-33
32-15	Attributes for <xsql:set-stylesheet-param>	32-35
32-16	Attributes for <xsql:update-request>	32-37
33-1	Summary of XML Standards Supported by Oracle XML Developer's Kit.....	33-1
D-1	javax.xml.async DOM-Related Classes and Interfaces.....	D-6
D-2	javax.xml.async XSL-Related Classes and Interfaces.....	D-8
D-3	XMLDBAccess Methods.....	D-10
D-4	XMLDiff Methods.....	D-11
D-5	JavaBean Sample Java Source Files	D-13
D-6	JavaBean Sample Files	D-16

Preface

This document describes the Oracle XML Developer's Kit (XDK). It provides detailed information about various language components, including Extensible Markup Language (XML), Java, C, and C++.

Topics:

- [Audience](#) (page xxix)
- [Documentation Accessibility](#) (page xxix)
- [Related Documents](#) (page xxix)
- [Examples](#) (page xxx)
- [Conventions](#) (page xxxi)

Audience

This document is for application developers who use the language components of the XDK to generate and store XML data in either a database or a document outside the database. Examples and sample applications are provided where possible. This document assumes familiarity with XML and either Java, C, or C++.

Documentation Accessibility

For information about Oracle's commitment to accessibility, visit the Oracle Accessibility Program website at <http://www.oracle.com/pls/topic/lookup?ctx=acc&id=docacc>.

Access to Oracle Support

Oracle customers that have purchased support have access to electronic support through My Oracle Support. For information, visit <http://www.oracle.com/pls/topic/lookup?ctx=acc&id=info> or visit <http://www.oracle.com/pls/topic/lookup?ctx=acc&id=trs> if you are hearing impaired.

Related Documents

Oracle resources that are related to this document are listed.

For more information, see these resources:

- *Oracle XML DB Developer's Guide*

- *Oracle Database XML C API Reference*
- *Oracle Database XML C++ API Reference*
- *Oracle Database XML Java API Reference*
- *Oracle Database Advanced Queuing User's Guide*
- The XDK home page on Oracle Technology Network
<http://www.oracle.com/technetwork/database-features/xdk/overview/index.html>

For additional information about XML, see:

- WROX publications, especially *XML Design and Implementation* by Paul Spencer, which covers XML, XSL, and development.
- *Building Oracle XML Applications* by Steve Muench, O'Reilly, <http://www.oreilly.com/catalog/orxmlapp/>
- *The XML Bible*, <http://www.ibiblio.org/xml/books/biblegold/>
- *XML, Java, and the Future of the Web* by Jon Bosak, Sun Microsystems, <http://www.ibiblio.org/bosak/xml/why/xmlapps.htm>
- *XML for the Absolute Beginner* by Mark Johnson, JavaWorld, http://www.javaworld.com/jw-04-1999/jw-04-xml_p.html
- *XML And Databases* by Ronald Bourret, <http://www.rpbouret.com/xml/XMLAndDatabases.htm>
- XML Specifications by the World Wide Web Consortium (W3C), <http://www.w3.org/XML/>
- XML.com, a broad collection of XML resources and commentary, <http://www.xml.com/>
- *Annotated XML Specification* by Tim Bray, XML.com, <http://www.xml.com/axml/testaxml.htm>
- XML.org, hosted by OASIS as a resource to developers of purpose-built XML languages, <http://xml.org/>

Examples

Many examples in this document use the Oracle Database sample database schemas or are otherwise provided with your software.

For information about how the sample schemas, see *Oracle Database Sample Schemas*.

Examples that are provided with the software can be found in these directories:

- `$ORACLE_HOME/xdk/demo/java/`
- `$ORACLE_HOME/xdk/demo/c/`
- `$ORACLE_HOME/xdk/java/sample/`
- `$ORACLE_HOME/rdbms/demo`

Conventions

The text conventions that are used in this document are described.

Convention	Meaning
boldface	Boldface type indicates graphical user interface elements associated with an action, or terms defined in text or the glossary.
<i>italic</i>	Italic type indicates book titles, emphasis, or placeholder variables for which you supply values.
monospace	Monospace type indicates commands within a paragraph, URLs, code in examples, text that appears on the screen, or text that you enter.

Changes in This Release for Oracle XML Developer's Kit Programmer's Guide

This preface lists changes in *Oracle XML Developer's Kit Programmer's Guide*.

Topics:

- [Changes in Oracle XML Developer's Kit 12c Release 2 \(12.2.0.1\)](#) (page xxxiii)
- [Changes in Oracle XML Developer's Kit 12c Release 1 \(12.1.0.1\)](#) (page xxxiii)

Changes in Oracle XML Developer's Kit 12c Release 2 (12.2.0.1)

Topics:

- [New Features](#) (page xxxiii)

New Features

The following features are new in this release.

XSL 2.0 Support

XDK now provides complete support for the W3C XSL 2.0 standard.

XQuery 3.0 Support

XDK now provides limited support for the forthcoming XQuery 3.0 recommendation.

Changes in Oracle XML Developer's Kit 12c Release 1 (12.1.0.1)

Topics:

- [New Features](#) (page xxxiii)
- [Deprecated Features](#) (page xxxiv)

New Features

For Oracle Database 12c Release 1 (12.1.0.1), *Oracle XML Developer's Kit Programmer's Guide* documents these new features of XDK:

- [Oracle XQuery Processor for Java](#) (page xxxiv)

- [XDK/J Support for Fast Infoset](#) (page xxxiv)
- [XDK/J DOM Improvements](#) (page xxxiv)
- [XMLDiff Support for XDK Java](#) (page xxxiv)

Oracle XQuery Processor for Java

XDK includes an XQuery 1.0 processor for Java, which lets Java applications query, transform, and update Extensible Markup Language (XML) directly in the Java Virtual Machine (JVM).

For more information, see [Using the XQuery Processor for Java](#) (page 7-1).

XDK/J Support for Fast Infoset

XDK adds support for the Fast Infoset to XDK/J model. This support enables developers to use Fast Infoset techniques while working with XML content in Java. The Fast Infoset model is a popular technique for working with XML content in Java.

For more information, see [DOM Support for Fast Infoset](#) (page 4-7).

XDK/J DOM Improvements

XDK adds support for World Wide Web Consortium (W3C) document object model (DOM) Level 3 Core application programming interfaces (APIs). This support lets developers maximize the benefits of the latest W3C APIs for XML processing, including the APIs that are defined as part of the DOM Level 3.0 Core specification.

For more information, see [XDK Java DOM Improvements](#) (page 4-29).

XMLDiff Support for XDK Java

XDK supports a Java-based XMLDiff that is format-compatible with C and PL/SQL XMLDiff, which were introduced in Oracle Database 11g Release 1 (11.1). This support lets pure Java programs in the middle tier exchange XMLDiff output with C programs or with programs that use Oracle Database to perform XMLDiff operations.

For more information, see [Determining XML Differences Using Java](#) (page 12-1).

Deprecated Features

For Oracle Database 12c Release 1 (12.1.0.1), these features are deprecated, and may be desupported in a future release:

- [XML Developer's Kit JavaBeans](#) (page xxxiv)
- [XML Developer's Kit for Java APIs](#) (page xxxv)

XML Developer's Kit JavaBeans

For Oracle Database 12c Release 1 (12.1.0.1), these XDK JavaBeans are deprecated:

- DOMBuilder
- XSLTransformer
- DBAccess
- XMLDBAccess
- XMLDiff

- XMLCompress
- XSDValidator

For alternatives, see [Oracle XML Developer's Kit JavaBeans \(Deprecated\)](#) (page D-1).

XML Developer's Kit for Java APIs

The XDK Java API packages and classes that correspond to deprecated XDK JavaBeans, are also deprecated, starting with Oracle Database 12c Release 1 (12.1.0.1).

These are the deprecated packages and classes:

- `oracle.xml.async`
- `oracle.xml.dbaccess`
- `oracle.xml.XMLDiff.BeanInfo`
- `oracle.xml.xmlcompl`
- `oracle.xml.xmldbaccess`
- `oracle.xml.schemavalidator`

For alternatives, see *Oracle Database XML Java API Reference*.

Introduction to Oracle XML Developer's Kit

Oracle XML Developer's Kit (XDK) is introduced.

Topics:

- [Overview of XDK](#) (page 1-1)
- [XDK Components](#) (page 1-3)
- [Generating XML Documents Using XDK](#) (page 1-11)
- [Development Tools and Frameworks for XDK](#) (page 1-14)
- [About Installing XDK](#) (page 1-17)

1.1 Overview of XDK

Oracle XML Developer's Kit (XDK) is a versatile set of components that enables you to build and deploy C, C++, and Java software programs that process Extensible Markup Language (XML). You can assemble these components into an XML application that serves your business needs.

Note:

If you are using XDK with PL/SQL and migrating from Oracle Database Release 8.1 or 9.2, Oracle strongly recommends that you use database character set AL32UTF8. Otherwise, problems can arise when PL/SQL processes XML data that contains escaped entities.

[Oracle XML Developer's Kit \(XDK\)](#) supports [Oracle XML DB](#), which is a set of technologies used for storing and processing XML in Oracle Database. You can use XDK with Oracle XML DB to build applications that run in Oracle Database. You can also use XDK independently of Oracle XML DB.

Dates and timestamps in generated XML are in the formats specified by XML Schema. See *Oracle XML DB Developer's Guide*.

XDK is fully supported by Oracle and comes with a commercial redistribution license. The standard installation of Oracle Database includes XDK.

[Table 1-1](#) (page 1-2) briefly describes the XDK components, tells which programming languages they support, and directs you to the sections of this document that explain how to use them.

Table 1-1 Overview of Oracle XML Developer's Kit Components

Component	Description	Languages	See
XML parser	Creates and parses XML with industry standard Simple API for XML (SAX) and Document Object Model (DOM) interfaces.	Java, C, C++	<ul style="list-style-type: none"> • XML Parsing for Java (page 4-1) • Using the XML Parser for C (page 20-1) • Using the XML Parser for C++ (page 27-1)
XML Compressor	Enables binary compression and decompression of XML documents. The XML compressor is built into the XML parser for Java.	Java	Compressing and Decompressing XML (page 4-49)
Java API for XML Processing (JAXP)	Enables Java applications to use SAX, DOM, XML Schema processor, Extensible Stylesheet Language Transformations (XSLT) processors, or alternative processors.	Java	Parsing XML with JAXP (page 4-44)
XSLT Processor	Transforms XML into other text-based formats such as Hypertext Markup Language (HTML).	Java, C, C++	<ul style="list-style-type: none"> • Using the XSLT Processor for Java (page 6-1) • Using the XSLT and XVM Processors for C (page 19-1) • Using the XSLT Processor for C++ (page 28-1)
XQuery Processor for Java	Enables Java applications to query, transform, and update XML directly in the Java Virtual Machine (JVM).	Java	Using the XQuery Processor for Java (page 7-1)
XML Schema Processor	Validates schemas, allowing use of simple and complex XML data types.	Java, C, C++	<ul style="list-style-type: none"> • Using the XML Schema Processor for Java (page 9-1) • Using the XML Schema Processor for C (page 22-1) • Using the XML Schema Processor for C++ (page 29-1)
XML class generator	Generates Java or C++ classes from document type definitions (DTDs) or XML schemas so that you can send XML data from web forms or applications. The Java implementation supports Java Architecture for XML Binding (JAXB) .	Java, C++	<ul style="list-style-type: none"> • Using the JAXB Class Generator (page 10-1) • Using the XML Class Generator for C++ (page 31-1)
XML Pipeline Processor	Applies XML processes specified in a declarative XML Pipeline document.	Java	Using the XML Pipeline Processor for Java (page 11-1)
XML JavaBeans	Provides bean encapsulations of XDK components for easy use of Integrated Development Environment (IDE), Java Server Pages (JSP), and applets.	Java	Oracle XML Developer's Kit JavaBeans (Deprecated) (page D-1)

Table 1-1 (Cont.) Overview of Oracle XML Developer's Kit Components

Component	Description	Languages	See
XML Diffing Library for Java	Enables pure Java programs in the middle tier to exchange XMLDiff output with C programs or programs that use Oracle Database to perform XMLDiff operations.	Java	Determining XML Differences Using Java (page 12-1)
XML SQL Utility (XSU)	Generates XML documents, DTDs, and Schemas from structured query language (SQL) queries. Maps any SQL query result to XML or the reverse. XSU Java classes are mirrored by PL/SQL packages.	Java, PL/SQL	Using the XML SQL Utility (page 13-1)
TransX Utility	Loads translated seed data and messages into the database using XML.	Java	Using the TransX Utility (page 14-1)
XSQL servlet	Combines XML, SQL, and XSLT in the server to deliver dynamic web content.	Java	Using the XSQL Pages Publishing Framework (page 16-1)
Oracle SOAP Server	Provides a lightweight Simple Object Access Protocol (SOAP) messaging protocol for sending and receiving requests and responses across the Internet.	C	Using SOAP with the Oracle XML Developer's Kit for C (page 24-1)
XSLT XVM Processor (page 19-1)	Provides a high-performance XSLT transformation engine that supports compiled XSL stylesheets.	C, C++	XSLT XVM Processor (page 19-1)

See Also:

- [XDK Components](#) (page 1-3) for fuller descriptions of many components in [Table 1-1](#) (page 1-2)
- [Oracle XML Developer's Kit Standards](#) (page 33-1) to learn about XDK support for XML-related standards

1.2 XDK Components

You can use XDK components in your programs to perform various types of XML processing.

[Figure 1-1](#) (page 1-4) shows a hypothetical XML processor that performs these tasks:

- Parse XML
- Validate XML against a DTD or XML schema
- Transform an XML document into another XML document by applying an XSLT stylesheet
- Generate Java and C++ classes from input XML schemas and DTDs

Figure 1-1 Sample XML Processor

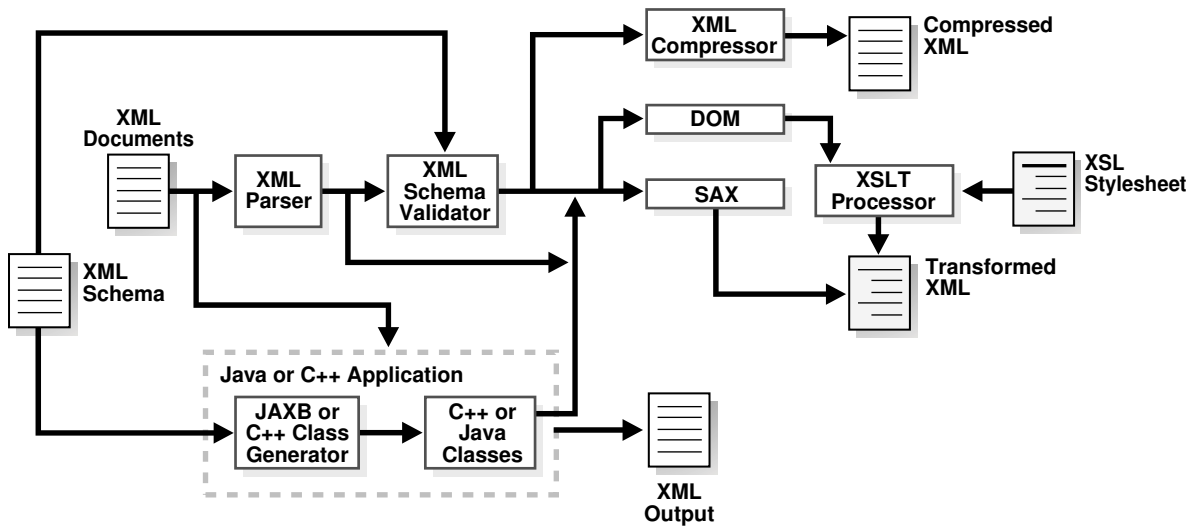
**Topics:**

- [XML Parsers](#) (page 1-4)
- [XSLT Processors](#) (page 1-5)
- [XML Schema Processors](#) (page 1-6)
- [XML Class Generators](#) (page 1-6)
- [XSQL Pages Publishing Framework](#) (page 1-9)
- [XML Pipeline Processor](#) (page 1-7)
- [Oracle XML SQL Utility](#) (page 1-7)
- [TransX Utility Overview](#) (page 1-9)
- [SOAP Services](#) (page 1-10)
- [XSLT Virtual Machine](#) (page 1-10)

1.2.1 XML Parsers

An XML parser reads an XML document and determines the structure and properties of the data. It breaks the data into parts and provides them to other XDK components.

An XML parser can programmatically access the parsed XML data with these APIs:

- SAX
 - Use a SAX API to serially access the data element by element. You can register event handlers with a SAX parser and invoke callback methods when certain events are encountered.
- DOM
 - Use a DOM API to represent the XML document as an in-memory tree and manipulate or navigate it.

XDK includes XML parsers for Java, C, and C++. Each parser includes support for both DOM and SAX APIs.

The XML parser for Java supports version 1.2 of Java API for XML Processing (JAXP), which is a standard API that enables use of DOM, SAX, XML Schema, and XSLT independently of a processor implementation. Thus, you can change the implementation of XML processors without impacting your programs.

The XML compressor is integrated into the XML parser for Java. It provides element-level XML compression and decompression with DOM and SAX interfaces. The XML compressor compresses XML documents without losing the structural and hierarchical information of the DOM tree. After parsing an XML document, you can serialize it with either DOM or SAX to a binary stream and then reconstruct it later.

You can use the XML compressor to reduce the size of XML message payloads, thereby increasing throughput. When used within applications as the internal XML document access, it significantly reduces memory usage while maintaining fast access.

Figure 1-2 (page 1-5) shows the functionality of the XDK parsers for Java, C, and C++.

Figure 1-2 XML Parsers for Java, C, and C++

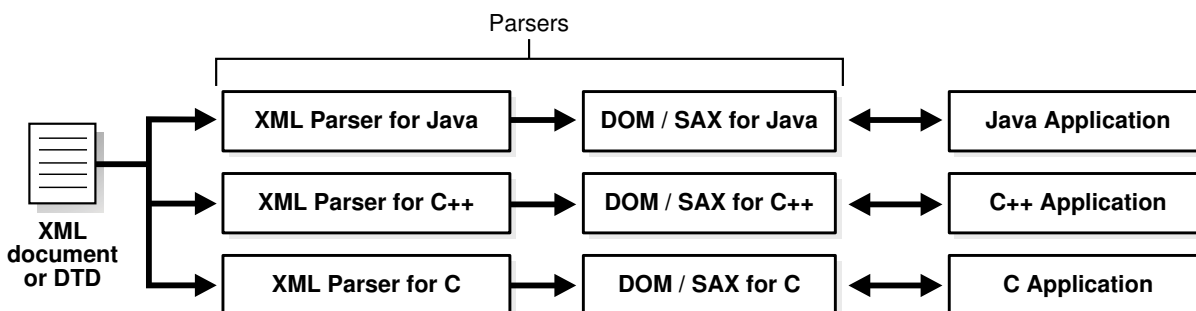

See Also:

- [XML Parsing for Java](#) (page 4-1)
 - [Using the XML Parser for C](#) (page 20-1)
 - [Using the XML Parser for C++](#) (page 27-1)
-

1.2.2 XSLT Processors

XSLT is a stylesheet language that enables processors to transform one XML document into another. An XSLT document is a stylesheet that contains template rules that govern such a transformation. XDK enables XSLT transformation of XML data inside and outside the database on any operating system.

Each Oracle XML parser includes an integrated XSLT processor for transforming XML data using XSLT stylesheets. Using the XSLT processor, you can transform XML documents to XML, to Extensible Hypertext Markup Language (XHTML), or to almost any other text format.

See Also:

- [Using the XSLT Processor for Java](#) (page 6-1)
 - [Using the XSLT and XVM Processors for C](#) (page 19-1)
 - [Using the XSLT Processor for C++](#) (page 28-1)
 - Specifications and other information are found on the W3C site at <http://www.w3.org/Style/XSL>
-

1.2.3 XML Schema Processors

The XML Schema language, created by the W3C, describes the content and structure of XML documents in XML itself.

An [XML schema](#) contains rules that define validity for an XML application—this is its principal advantage over a DTD.

An XML schema specifies a set of built-in data types (such as string, float, and date). Users can derive their own data types from the built-in data types. For example, the schema can restrict dates to those after the year 2000 or specify a list of legal values.

XDK includes XML Schema processors for Java, C, and C++.

See Also:

- [Using the XML Schema Processor for Java](#) (page 9-1)
 - [Using the XML Schema Processor for C](#) (page 22-1)
 - [Using the XML Schema Processor for C++](#) (page 29-1)
-

1.2.4 XML Class Generators

An XML class generator takes a parsed XML schema or DTD as input and generates Java or C++ source class files as output. XDK includes both the Java Architecture for XML Binding (JAXB) class generator and the C++ class generator.

JAXB is a Java API and set of tools that maps XML data to Java objects, and the reverse. Because JAXB presents an XML document to a Java program in a Java format, you can write Java programs that process XML data without using a SAX parser or writing callback methods. Each Java object derives from an instance of the schema component in the input XML document. JAXB does not directly support DTDs, but you can convert a DTD to an XML schema that JAXB can use. The XML class generator for C++ directly supports both DTDs and XML Schemas.

As an example of how to use JAXB, you can write a Java program that uses generated Java classes to build XML documents gradually. Suppose that you write an XML schema for use by a human resources department and a Java program that responds to users who change their personal data. The program can use JAXB to construct an XML confirmation document in a piecemeal fashion, which an XSLT processor can transform into XHTML and deliver to a browser.

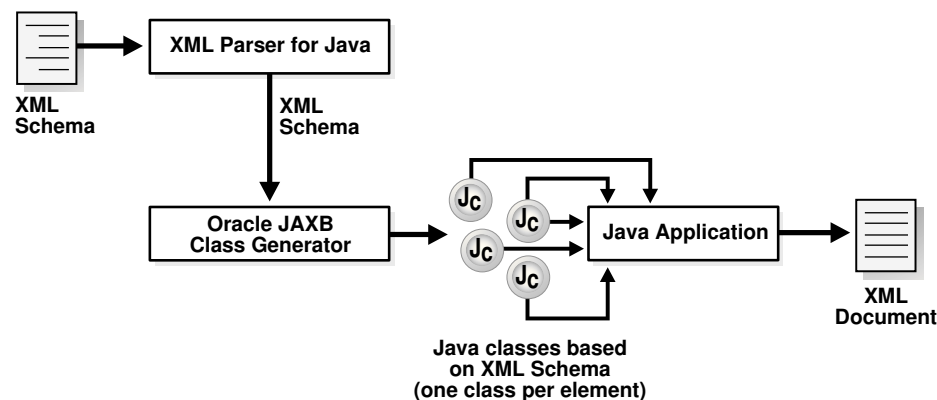
Figure 1-3 Oracle JAXB Class Generator**See Also:**

- [Using the JAXB Class Generator](#) (page 10-1)
- [Using the XML Class Generator for C++](#) (page 31-1)

1.2.5 XML Pipeline Processor

The XML Pipeline Definition Language is an XML vocabulary for describing the processing relationships between XML resources. Oracle XML Pipeline processor conforms to the XML Pipeline Definition Language 1.0 standard.

The XML Pipeline processor takes as input an XML pipeline document (which defines the relationship between processes) and executes the pipeline processes according to the derived dependencies. For example, the input document can specify that the program must first validate an input XML document and then, if it is valid, transform it.

The XML pipeline processor helps Java developers by replacing custom Java code with a simple declarative XML syntax for building XML processing applications.

See Also:

[Using the XML Pipeline Processor for Java](#) (page 11-1)

1.2.6 Oracle XML SQL Utility

Oracle XML SQL Utility (XSU) is a set of Java class libraries that you can use to render the results of SQL queries into canonical XML or to load data from an XML document into an existing database schema or view.

You can use XSU for these tasks:

- Automatically and dynamically render the results of arbitrary SQL queries into canonical XML.

XSU supports queries over richly structured, user-defined object types and object views, including `XMLType`. XSU transforms relational data into XML like this:

- Columns become top-level elements.

- Scalar values become elements with text-only content.
- Object types become elements with attributes appearing as subelements.
- Collections are mapped to lists of elements.
- Load data from an XML document into an existing database schema or view.

Note:

XSU also has a PL/SQL implementation. The PL/SQL packages `DBMS_XMLQuery` and `DBMS_XMLSave` reflect the functions in the Java classes `OracleXMLQuery` and `OracleXMLSave`.

Figure 1-4 (page 1-8) shows how XSU processes SQL queries and returns the results as an XML document.

Figure 1-4 XSU Processes SQL Queries and Returns the Result as XML

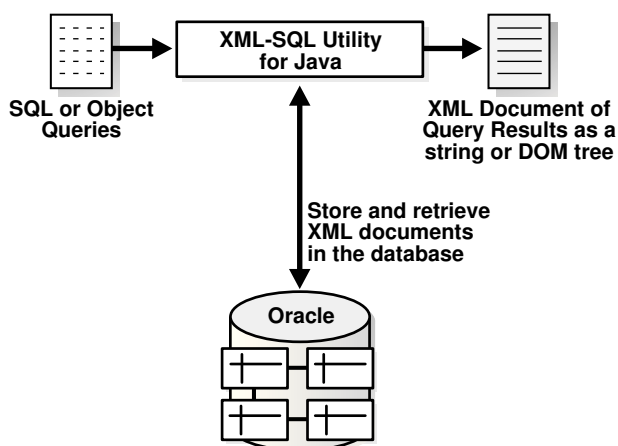

1.2.6.1 XML Document Representations

XSU representations in which you can generate an XML document are described, along with their typical use cases.

XML Document Representation	When to Use This Representation
String	When returning the XML document to a requester
In-memory DOM tree	When operating on the XML programmatically (for example, when transforming it with the XSLT processor by using DOM methods to search or modify the XML)
Series of SAX events	When retrieving XML, especially large documents or result sets

1.2.6.2 Using XSU with an XML Class Generator

You can use XSU to generate an XML schema that is based on the relational schema of an underlying table or view that you are querying. You can use the generated XML schema as input to the JAXB class generator or the C++ class generator.

You can then write code that uses the generated classes to create the infrastructure behind a web-based form. Based on this infrastructure, the form can capture user data and create an XML document compatible with the database schema. A program can write the XML directly to the corresponding table or object view without further processing.

See Also:

[Using the XML SQL Utility](#) (page 13-1)

1.2.7 TransX Utility Overview

The Oracle TransX utility enables you to populate a database with multilingual XML data. The utility uses a data format that is intuitive for both developers and translators and uses a validation capability that is less error-prone than previous techniques.

The TransX utility is an application of XSU that loads translated seed data and messages into a database schema. For populating a database with data in multiple languages, the TransX utility provides functionality that you would otherwise have to develop with XSU.

See Also:

[Using the TransX Utility](#) (page 14-1)

1.2.8 XSQL Pages Publishing Framework

The XSQL pages publishing framework (XSQL servlet) is a server component that takes an XSQL file (an XML file with a specific structure and grammar) and produces dynamic XML documents from one or more SQL queries of data objects.

[Figure 1-5](#) (page 1-9) shows how you can invoke the XSQL servlet.

Figure 1-5 XSQL Pages Publishing Framework

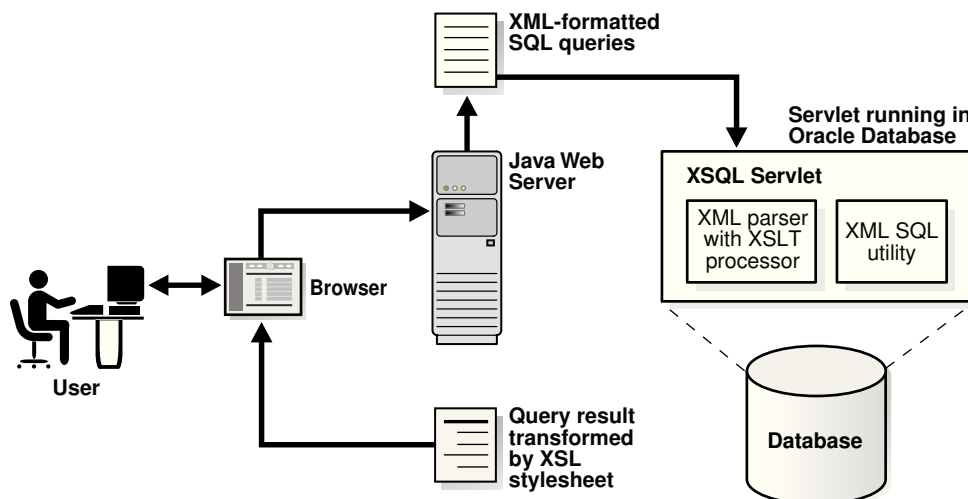

The XSQL servlet uses the Oracle XML parser to process the XSQL file, passing XSLT processing statements to its internal processor while passing parameters and SQL queries between the tags to XSU. Results from those queries are received as XML-

formatted text or a Java Database Connectivity (JDBC) `ResultSet` object. If necessary, you can further transform the query results by using the built-in XSLT processor.

One example of an XSQL servlet is a page that contains a query of flight schedules for an airline with a bind variable for the airport name. The user can pass an airport name as a parameter in a web form. The servlet binds the parameter value in its database query and transforms the output XML into HTML for display in a browser.

See Also:

[Using the XSQL Pages Publishing Framework](#) (page 16-1)

1.2.9 SOAP Services

Simple Object Access Protocol (SOAP) is a platform-independent messaging protocol that lets programs access services, objects, and servers. Oracle SOAP Services is published and executed through the web. It provides the standard XML message format for all programs.

SOAP Services lets you use XDK to develop messaging, remote procedure calls (RPC), and web service programs using XML standards.

See Also:

[Using SOAP with the Oracle XML Developer's Kit for C](#) (page 24-1)

1.2.10 XSLT Virtual Machine

The XSLT Virtual Machine (XVM) for C/C++ is the software implementation of a CPU designed to run compiled XSLT code. To run this code, you must compile XSLT stylesheets into byte code that the XVM engine understands.

[Figure 1-6](#) (page 1-10) shows how the XVM processes XML and XSL.

Figure 1-6 XSLT Virtual Machine

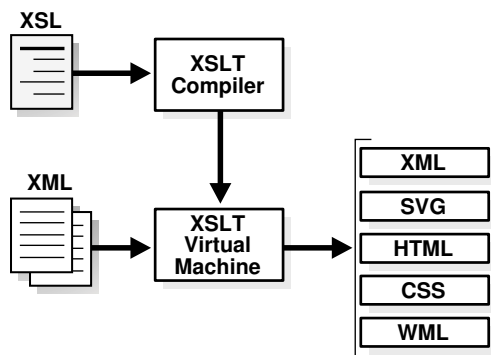

XDK includes an XSLT compiler that is compliant with the XSLT 1.0 standard. The compilation can occur at runtime or be stored for runtime retrieval. Applications perform transformations faster, and with higher throughput, because the stylesheet does not need parsing and the templates are applied using an index lookup instead of an XML operation.

See Also:[XSLT XVM Processor](#) (page 19-1)

1.3 Generating XML Documents Using XDK

XDK lets you map the structure of an XML document to a relational schema. You can use XDK to create XML documents from database tables and insert XML-tagged data into tables. Each XDK programming language supports the development of programs that generate XML documents from relational data.

Topics:

- [XML Document Generation with Java](#) (page 1-11)
- [XML Document Generation with C](#) (page 1-12)
- [XML Document Generation with C++](#) (page 1-13)

1.3.1 XML Document Generation with Java

The XDK components for generating XML documents with Java are XSL, XSU, JDBC, JAXB, JavaBeans, and XSLT.

[Figure 1-7](#) (page 1-12) shows how to use XDK for Java components to generate XML documents from relational data. For generating an XML document from a SQL query, you have a choice of three components, which are labeled A, B, and C. The components that your program can use to further process the XML document are labeled D, E, and F.

[Table 1-2](#) (page 1-11) describes the XDK for Java components.

Table 1-2 XDK for Java Components for Generating XML

Component	Label in Figure 1-7 (page 1-12)	Description
XSQL Servlet	A	Includes XSU and the XML parser
XSU	B	Includes XML parser
JDBC	C	Sends output data to the XML parser
JAXB	D	Generates Java class files that correspond to an input XML Schema
JavaBeans	E	Can compare an XML document with another XML document
XSLT	F	Transforms the XML document into XHTML with an XSLT stylesheet

Figure 1-7 Sample XML Processor Built with Java Oracle XML Developer's Kit Components

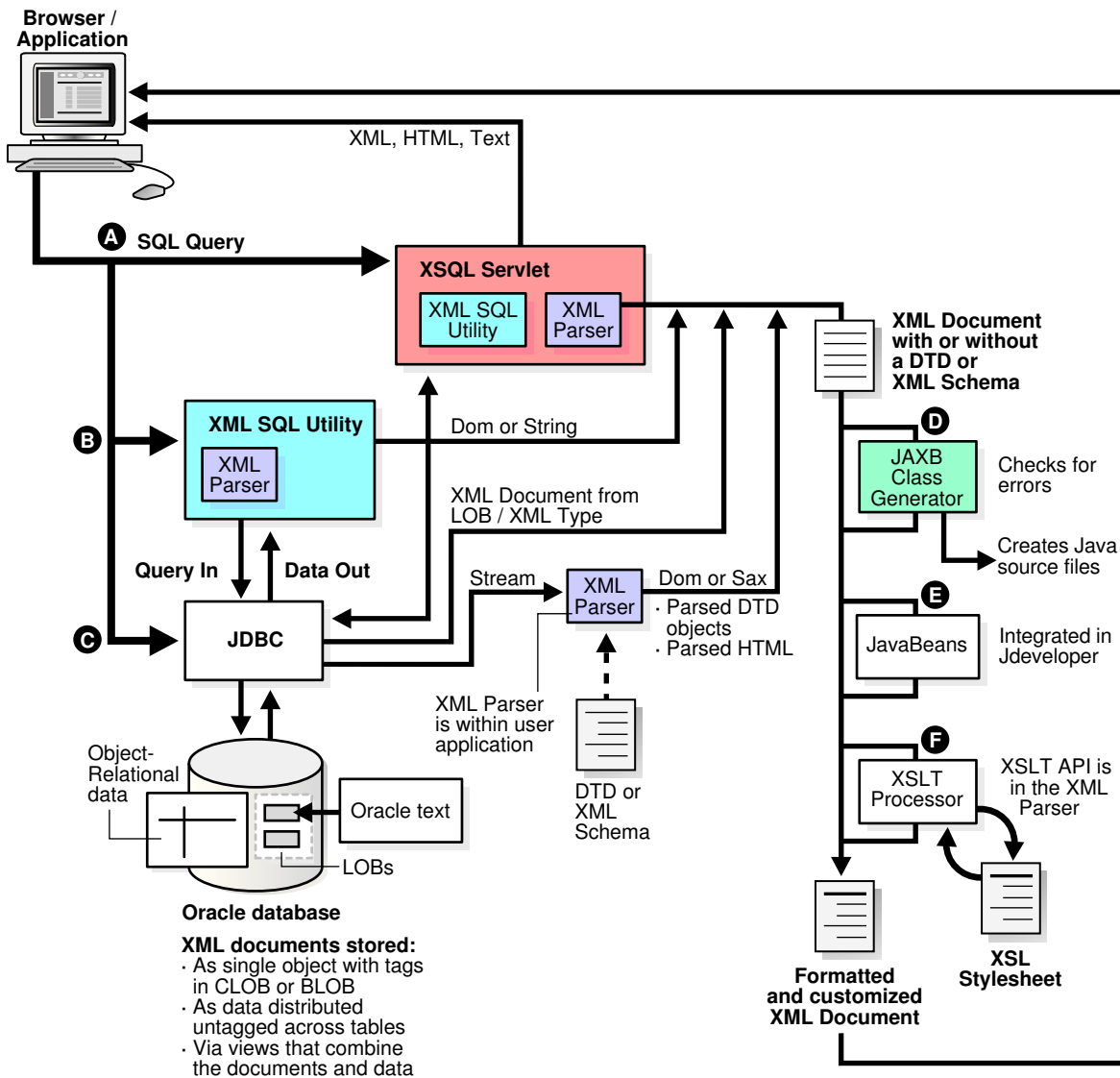

1.3.2 XML Document Generation with C

An overview is presented of generating XML documents using XDK for C components.

Figure 1-8 (page 1-13) shows how to use XDK for C components to generate XML documents from relational data. For component descriptions, see Table 1-1 (page 1-2).

Figure 1-8 Generating XML Documents Using Oracle XML Developer's Kit C Components

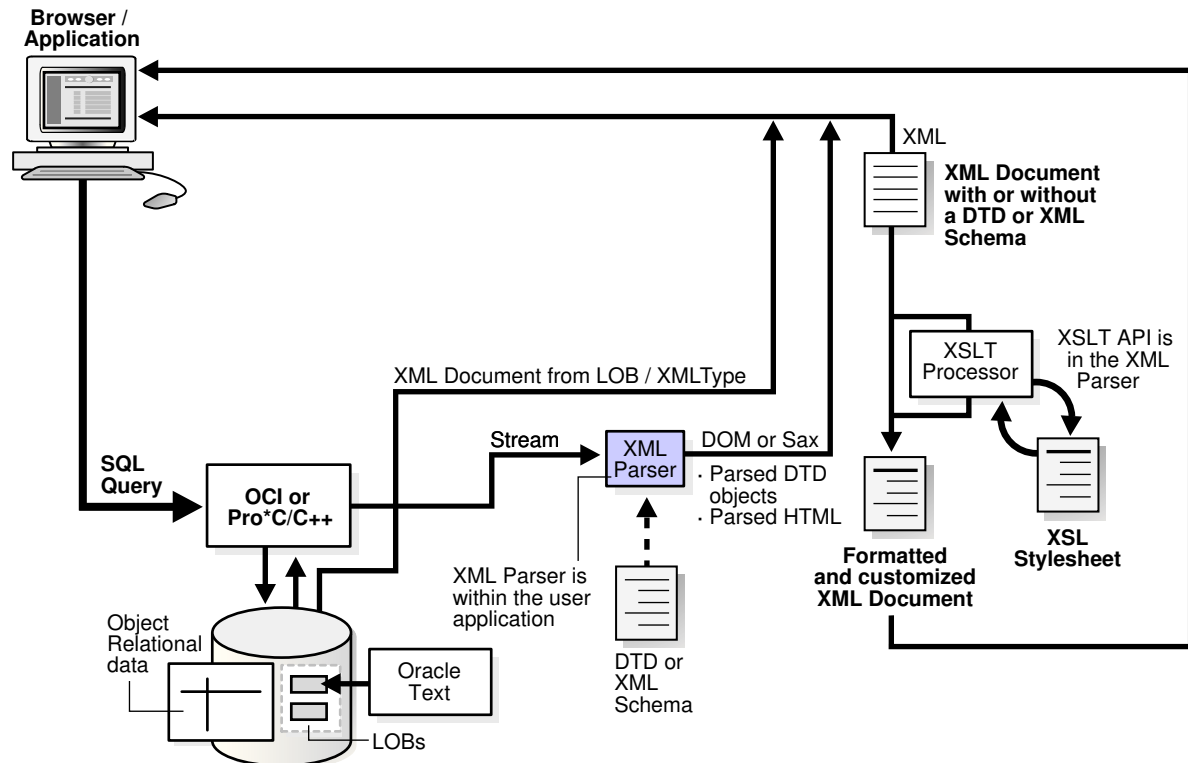

Oracle database

XML documents stored:

- As single object with tags in CLOB or BLOB
- As data distributed untagged across tables
- Via views that combine the documents and data

To develop a C program that processes an XML document:

1. Send SQL queries to the database by using either the Oracle Call Interface (OCI) or Pro*C/C++ Precompiler. Your program must leverage the Oracle XML DB XML view functionality.
2. Process the resulting XML data with the XML parser or from the CLOB as an XML document.
3. Either transform the XML document with the XSLT processor, send it to an XML-enabled browser, or send it to a software program for further processing.

1.3.3 XML Document Generation with C++

An overview is presented of generating XML documents using XDK for C++ components.

Figure 1-9 (page 1-14) shows how to use XDK for C++ components to generate XML documents from relational data. For component descriptions, see Table 1-1 (page 1-2).

Figure 1-9 Generating XML Documents Using Oracle XML Developer's Kit C++ Components

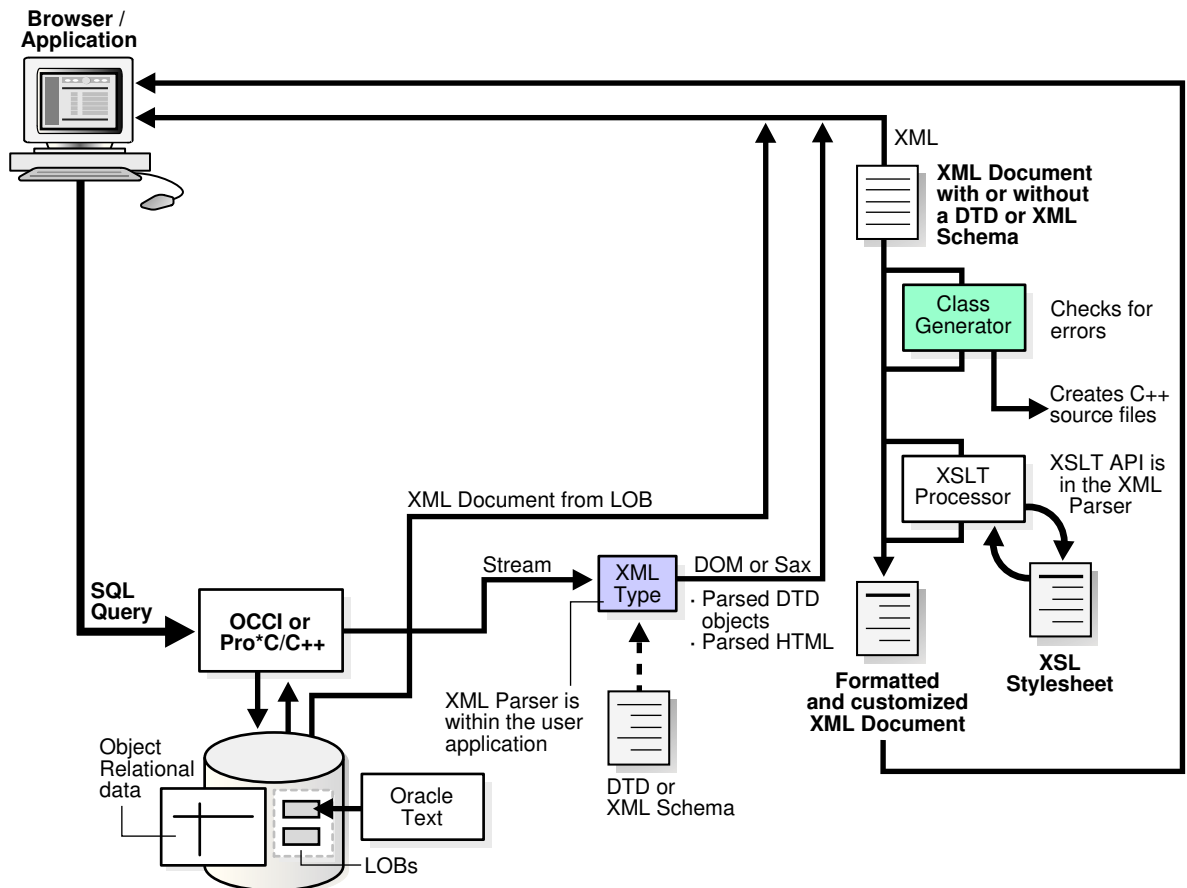

Oracle database
XML documents stored:
 · As single object with tags in CLOB or BLOB
 · As data distributed untagged across tables
 · Via views that combine the documents and data

To develop a C++ program that processes an XML document:

1. Send SQL queries to the database by using either the Oracle C++ Call Interface (OCI) or the Pro*C/C++ Precompiler.
2. Process the resulting XML data with the XML parser or from the CLOB as an XML document.
3. Either transform the XML document with the XSLT processor, send it to an XML-enabled browser, or send it to a software program for further processing.

1.4 Development Tools and Frameworks for XDK

Some tools and frameworks that you can use to develop software programs that use XDK components are presented.

Figure 1-10 (page 1-15) illustrates this.

Figure 1-10 Oracle XML Developer's Kit Tools and Frameworks

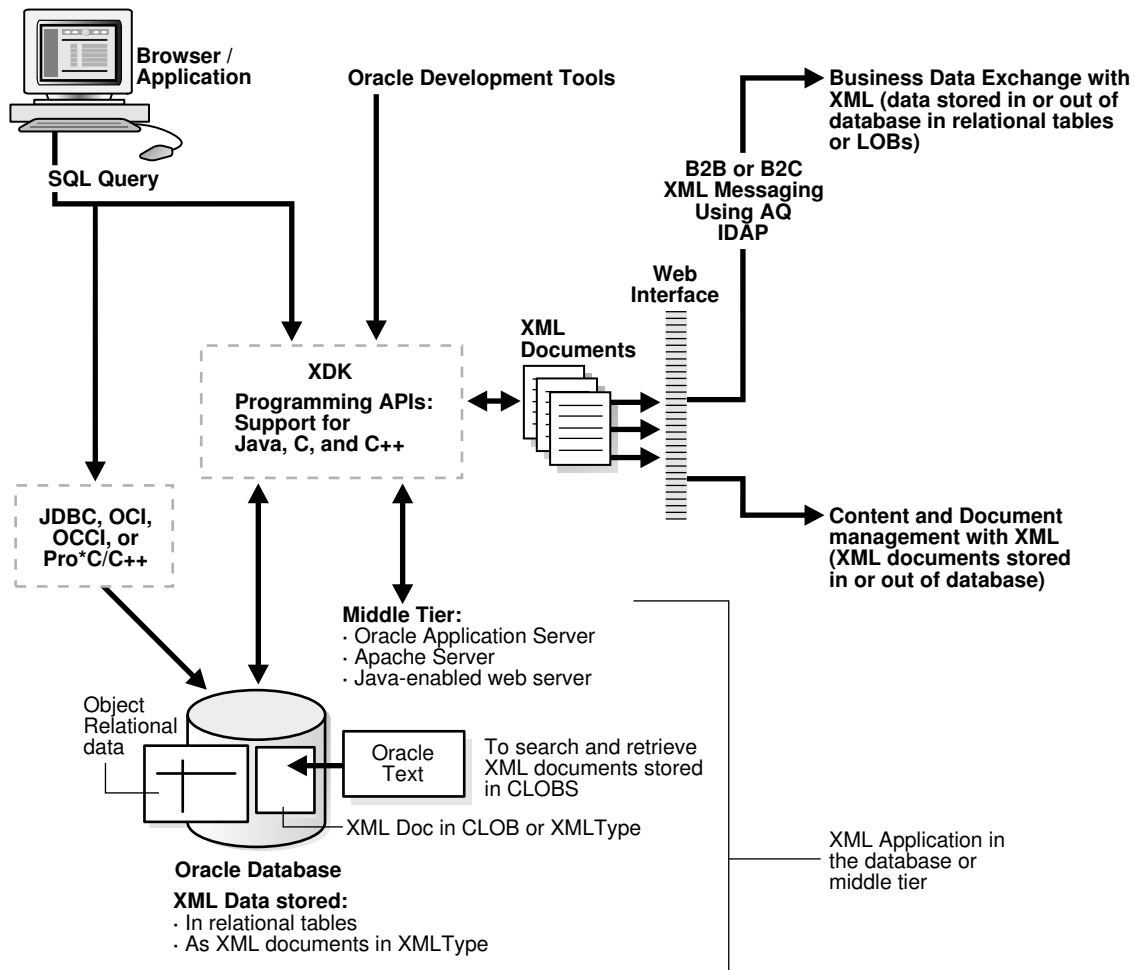

For example, you can use Oracle JDeveloper to write a Java client that can query the database, generate XML, and perform additional processing. An employee can then use this program to send a query to Oracle Database. The program can transfer XML documents to XML-based business solutions for data exchange with other users, content and data management, and so forth.

Topics:

- [Oracle JDeveloper](#) (page 1-15)
- [Oracle Data Provider for .NET](#) (page 1-17)

1.4.1 Oracle JDeveloper

Oracle JDeveloper is a Java Platform, Enterprise Edition (Java EE) development environment with end-to-end support for developing, debugging, and deploying e-business applications. It provides a comprehensive set of integrated tools that support the complete development life cycle, from source code control, modeling, and coding through debugging, testing, profiling, and deployment.

Oracle JDeveloper simplifies development by providing deployment tools to create Java EE components such as:

- Applets

- JavaBeans
- Java Server Pages (JSP)
- Servlets
- Enterprise JavaBeans (EJB)

Oracle JDeveloper also provides a public API to extend and customize the development environment and integrate it with external products.

XDK is integrated into Oracle JDeveloper, offering many ways to manage XML. For example, you can use the XSQL Servlet to perform these tasks:

- Query and manipulate database information
- Generate XML documents
- Transform XML with XSLT stylesheets
- Deliver XML on the web

Oracle JDeveloper has an integrated XML schema-driven code editor for working on XML Schema-based documents such as XML schemas and XSLT stylesheets. By specifying the schema for a certain language, the editor can help you create a document in that markup language. The Code Insight feature can list valid alternatives for XML elements or attributes in the document.

Oracle JDeveloper simplifies the task of working simultaneously with Java application code and XML data and documents. It features drag-and-drop XML development modules such as:

- Color-coded syntax highlighting for XML
- Built-in syntax checking for XML and XSL
- Editing support for XML schema documents
- XSQL Pages and Servlet support
- Oracle XML parser for Java
- XSLT processor
- XDK for JavaBeans components
- XSQL Page Wizard
- XSQL Action Handlers
- Schema-driven XML editor

See Also:

<http://www.oracle.com/technetwork/developer-tools/jdev/overview/index.html> for links to Oracle JDeveloper documentation and tutorials

1.4.2 Oracle Data Provider for .NET

Oracle Data Provider for .NET (ODP.NET) is an implementation of a .NET data provider for Oracle Database. It uses Oracle native APIs to provide fast, reliable access to Oracle data and features from any .NET application. It uses and inherits classes and interfaces from the Microsoft .NET Framework Class Library.

You can use ODP.NET and XDK to extract data from relational and object-relational tables and views as XML documents. You can also use XML documents for insert, update, and delete operations on the database server. ODP.NET supports XML natively in the database through Oracle XML DB.

ODP.NET supports XML with features that:

- Store XML data natively in the database server as the Oracle native type `XMLType`.
- Access relational and object-relational data as XML data from database instances into a Microsoft .NET environment and process the XML with the Microsoft .NET framework.
- Save changes to the database server with XML data.

For the ODP.NET application developer, features include:

- Enhancements to the `OracleCommand`, `OracleConnection`, and `OracleDataReader` classes
- XML-specific classes:
 - `OracleXmlType`
 - `OracleXmlStream`
 - `OracleXmlQueryProperties`
 - `OracleXmlSaveProperties`

See Also:

Oracle Data Provider for .NET Developer's Guide for Microsoft Windows

1.5 About Installing XDK

The standard installation of Oracle Database includes XDK (all of its components).

This section assumes that:

- You installed Oracle Database from either a CD-ROM or an archive that you downloaded from the Oracle Technology Network (OTN).

The Oracle Database CD-ROM installs XDK by default.

- You installed the XDK demo programs from the Oracle Database Examples media.

[Example 1-1](#) (page 1-18) shows how your Oracle Database home directory looks after you have installed Oracle Database and the XDK demo programs.

The directory that contains XDK is called **XDK home**. Set the value of environment variable `$XDK_HOME` (UNIX) or `%XDK_HOME%` (Windows) to the `xdk` directory in your

Oracle home directory. For example, you can use `csh` on UNIX to set the XDK home directory with this command:

```
setenv XDK_HOME $ORACLE_HOME/xdk
```

See Also:

- [Installing XDK for Java Components](#) (page 3-1)
 - [Installing XDK for C Components](#) (page 18-1)
 - [Installing the XDK for C++ Components](#) (page 25-1)
-
-

Example 1-1 Oracle XML Developer's Kit Components

```
- $ORACLE_HOME: Oracle home directory
  | - bin: includes XDK executables
  | - lib: includes XDK libraries
  | - jlib: includes Globalization Support libraries for the XDK
  | - nls: includes binary files used as part of globalization support
  | - xdk: XDK scripts, message files, documentation, and demos
      readme.html
      | - admin: SQL scripts and XSL Servlet Configuration
          file (XSQLConfig.xml)
      | - demo: sample programs (installed from Oracle Database Examples media)
          | - c
          | - cpp
          | - java
          | - jsp
      | - doc: release notes and readme
          content.html
          index.html
          license.html
          title.html
          | - cpp
          | - images
          | - java
      | - include: header files
      | - msg: error message files
```

Part I

Oracle XML Developer's Kit for Java

This part explains how to use Oracle XML Developer's Kit (XDK) to develop Java applications.

Topics:

- [Unified Java API for XML](#) (page 2-1)
- [Getting Started with Oracle XML Developer's Kit for Java](#) (page 3-1)
- [XML Parsing for Java](#) (page 4-1)
- [Using Binary XML with Java](#) (page 5-1)
- [Using the XSLT Processor for Java](#) (page 6-1)
- [Using the XQuery Processor for Java](#) (page 7-1)
- [Using the XML Schema Processor for Java](#) (page 9-1)
- [Using the JAXB Class Generator](#) (page 10-1)
- [Using the XML Pipeline Processor for Java](#) (page 11-1)
- [Determining XML Differences Using Java](#) (page 12-1)
- [Using the XML SQL Utility](#) (page 13-1)
- [Using the TransX Utility](#) (page 14-1)
- [Data Loading Format \(DLF\) Specification](#) (page 15-1)
- [Using the XSQL Pages Publishing Framework](#) (page 16-1)
- [Using the XSQL Pages Publishing Framework: Advanced Topics](#) (page 17-1)

Unified Java API for XML

The Unified Java application program interface (API) for Extensible Markup Language (XML) is presented. The APIs that are unified for Oracle XML DB and Oracle XML Developer's Kit (XDK) are described.

Topics:

- [Overview of Unified Java API for XML](#) (page 2-1)
- [Component Unification](#) (page 2-1)
- [About Moving to the Unified Java API](#) (page 2-2)

2.1 Overview of Unified Java API for XML

With the Unified Java API for XML, you can use the core Java DOM APIs required by both Oracle XML DB and XDK. You can also use the new Java classes that provide extra functionality that is built on top of the Java DOM API.

Unified Java API for XML combines the functionality required by both Oracle XML DB and XDK. Oracle XML DB implements the Java Document Object Model (DOM) API using the Java package `oracle.xml.db.dom` and XDK implements it using the `oracle.xml.parser.v2` package.

You can use Unified Java API regardless of where your XML data resides (within the database or outside it), because Unified Java API uses a session pool model of connection management. If you do not specify the connection type as thick (which uses OCI APIs and is C-based) or thin (which uses Java Database Connectivity (JDBC) APIs and is purely Java-based), then a Java DOM API is used to connect to a local document object that resides outside the database.

See Also:

Oracle Database XML Java API Reference for information about the `oracle.xml.parser.v2` package

2.2 Component Unification

Some components that were supported only by the thick connection or only by the thin connection have been unified in Unified Java API for XML.

Those that were supported only by the thin connection and have been unified include the following:

- DOM Parser
- Java API for XML Processing (JAXP) Transformer

- XML SQL Utility (XSU)
- Extensible Stylesheet Language Transformation (XSLT)

2.3 About Moving to the Unified Java API

Unified Java API provides new Java classes that replace the old `oracle.xdb.dom` Java classes. All classes in the `oracle.xdb.dom` package are deprecated. If you are using deprecated classes, you must migrate to Unified Java API and use `oracle.xml.parser.v2` classes instead.

Topics:

- [Java DOM APIs for XMLType Classes](#) (page 2-2)
- [Extension APIs](#) (page 2-3)
- [Document Creation Java APIs](#) (page 2-4)

2.3.1 Java DOM APIs for XMLType Classes

The Java DOM APIs for XMLType classes are listed, together with their deprecated equivalents.

[Table 2-1](#) (page 2-2) lists the `oracle.xdb.dom` package classes that were deprecated in Oracle Database 11g Release 1 (11.1) and their Unified Java API for XML equivalents.

Table 2-1 Depreciated XDB Package Classes and Their Unified Java API Equivalents

Deprecated <code>oracle.xdb.dom.*</code> Class	Equivalent <code>oracle.xml.parser.v2</code> (Unified Java API) Class
XDBAttribute	XMLAttr
XDBBinaryDocument	None
XDBCDATA	XMLCDATA
XDBCharData	CharData
XDBComment	XMLComment
XDBDocFragment	XMLDocumentFragment
XDBDocument	XMLDocument
XDBDocumentType	DTD
XDBDOMException	XMLDomException
XDBDomImplementation	XMLDomImplementation
XBDDOMNotFoundErrException	None
XDBElement	XMLElement
XDBEntity	XMLEntity

Table 2-1 (Cont.) Deprecated XDB Package Classes and Their Unified Java API Equivalents

Deprecated oracle.xdb.dom.* Class	Equivalent oracle.xml.parser.v2 (Unified Java API) Class
XDBEntityReference	XMLEntityReference
XDBNamedNodeMap	XMLAttrList
XDBNode	XMLNode
XDBNotation	XMLNotation
XDBNotImplementedException	None
XDBProcInst	XMLPI
XDBText	XMLText

When you use the Java DOM API to retrieve XML data, you get either an `XMLDocument` instance (if the connection is thin) or an `XDBDocument` instance with method `getDOM()` and an `XMLDocument` instance with method `getDocument()`. Both `XMLDocument` and `XDBDocument` are instances of the World Wide Web Consortium (W3C) DOM interface. The `getDOM()` method and `XDBDocument` class have been deprecated in the Unified Java API for XML.

[Table 2-2](#) (page 2-3) lists the deprecated XMLType methods and their Unified Java API equivalents.

Table 2-2 Deprecated XMLType Methods and Their Unified Java API Equivalents

Deprecated oracle.xdb.XMLType API	Equivalent oracle.xdb.XMLType (Unified Java) API
<code>getDOM()</code>	<code>getDocument()</code>
<code>public XMLType createXML(...)</code>	<code>public XMLType createXML(..., int kind)</code> where <code>kind</code> is either <code>XMLDocument.THICK</code> or <code>XMLDocument.THIN</code>

2.3.2 Extension APIs

In addition to the W3C Recommendation, the Unified Java API for XML implementation provides extension APIs that extend the W3C DOM APIs. You can use the Oracle-specific extension APIs for performing basic functions (like connecting to a database) and performance enhancement.

`XMLDocument` is a class that represents the DOM for the instantiated XML document. Retrieve the `XMLType` value from the XML document using the `XMLType` constructor that takes a `Document` argument. For example:

```
XMLType createXML(Connection conn, Document domdoc)
```

To dereference a node manually—that is, to explicitly dereference a document fragment from the DOM tree—use the `freeNode()` extension API in the `oracle.xml.parser.v2` package (`XMLNode` class).

2.3.3 Document Creation Java APIs

A Java API that creates an `XMLDocument` must create either a thin document or a thick document. Because a thick document needs a `Connection` object to establish communication with the database, each document creation API is extended to accept a `Connection` object.

For an `XMLType.createXML` API, you must specify a `Connection` type, which determines the type of object. Old document creation APIs (provided only for backward compatibility), create thin (pure Java) objects unless you specify otherwise.

[Table 2-3](#) (page 2-4) lists the `XMLDocument` output, based on `KIND` and `CONNECTION`.

Table 2-3 XMLDocument Output Based on KIND and CONNECTION

<code>XMLDocument.KIND</code>	<code>XMLDocument.CONNECTION</code>	<code>XMLDocument</code>
<code>XMLDocument.THICK</code>	Thick or KPRB connection	Thick DOM
<code>XMLDocument.THICK</code>	Thin or no connection	Exception
<code>XMLDocument.THIN</code>	Any connection type	Thin DOM
Not specified	Any connection type	Non- <code>XMLType</code> APIs: Thin DOM <code>XMLType.createXML</code> APIs: Determined by connection type —Thick DOM for OCI or KPRB connection, and Thin DOM for Thin connection.

These objects, methods, and classes are available for document creation in the unified Java API:

- `DOMParser` object and `parse()` method

Use the `DOMParser` object and `parse()` method to parse XML documents. You must specify object type—thick or thin. For a thick object, you must also provide the `Connection` type, using the `DOMParser.setAttribute()` API. For example:

```
DOMParser parser = new oracle.xml.parser.v2.DOMParser();
parser.setAttribute(XMLDocument.KIND, XMLDocument.THICK);
parser.setAttribute(XMLDocument.CONNECTION, conn);
```

- `DocumentBuilder` object and `DocumentBuilderFactory` class

Use the `DocumentBuilder` object to parse XML documents using the Java-specific API, JAXP.

You must create a DOM parser factory with the `DocumentBuilderFactory` class. `DocumentBuilder` builds DOM from input SAX events, taking the `Connection` from a property set on the `DocumentBuilderFactory`. For example:

```
DocumentBuilderFactory.setAttribute(XMLDocument.CONNECTION, conn);
DocumentBuilderFactory.setAttribute(XMLDocument.KIND, XMLDocument.THICK);
```

`DocumentBuilderFactory` passes the connection to the `DOMParser` object that creates the document from these APIs:

```
DocumentBuilder.newDocument()  
DocumentBuilder parse(InputStream)  
DocumentBuilder parse(InputStream, int)  
DocumentBuilder.parse(InputSource)
```

- XSU methods

Each XSU method returns an `XMLDocument` to the user. You can specify whether the user wants a thick or thin object. For example:

```
OracleXMLUtil util = new OracleXMLUtil(...);  
util.setAttribute(XMLDocument.KIND, XMLDocument.THICK);  
util.setAttribute(XMLDocument.CONNECTION, conn);  
Document doc = util.getXMLDOMFromStruct(struct, enc);
```

```
OracleXMLQuery query = new OracleXMLQuery(...);  
query.setAttribute(XMLDocument.KIND, XMLDocument.THICK);  
query.setAttribute(XMLDocument.CONNECTION, conn);  
Document doc = query.getXMLDOM (root, meta);
```

```
OracleXMLDocGenDOM dgd = new OracleXMLDocGenDOM(...);  
dgd.setAttribute(XMLDocument.KIND, XMLDocument.THICK);  
dgd.setAttribute(XMLDocument.CONNECTION, conn);  
Document doc = dgd.getXMLDocumentDOM(struct, enc);
```

- XMLType methods

You can use the `XMLType.createXML` method to specify the type of the document (thin or thick) that you want the `getDocument()` method to get. In this example, the connection is inferred from `OPAQUE`:

```
XMLType xt = XMLType.createXML(orsset.getOPAQUE(1), XMLDocument.THICK);  
Document doc = xt.getDocument();
```

Note:

You cannot specify the type of an `XMLType` object returned by `ResultSet.getObject()`. The object type is determined by the `Connection` used in the JDBC call that fetches the `ResultSet` from the `XMLType` column.

Getting Started with Oracle XML Developer's Kit for Java

How to get started with XDK for Java is described.

Topics:

- [Installing XDK for Java Components](#) (page 3-1)
- [XDK for Java Component Dependencies](#) (page 3-2)
- [Setting Up the XDK for Java Environment](#) (page 3-5)
- [Verifying the XDK \(Java\) Version](#) (page 3-9)

3.1 Installing XDK for Java Components

XDK for Java components are included with Oracle Database. This chapter assumes that you installed XDK with Oracle Database and installed the demo programs from the Oracle Database Examples media.

For a description of the XDK directory structure, see [About Installing XDK](#) (page 1-17).

[Example 3-1](#) (page 3-2) lists the main directories under the Oracle home directory for Java (This is the UNIX directory structure.) The contents of the subdirectories are listed individually, after the example.

The `bin` directory contains these components:

```
orajaxb
orapipe
oraxml
oraxsl
transx
```

The `lib` directory contains these JAR and ZIP files:

```
classgen.jar
jdev-rt.zip
oraclexsql.jar
transx.zip
xml.jar
xml2.jar
xmldemo.jar
xmlmsg.jar
xmlparserv2.jar
xschema.jar
xsqlserializers.jar
xsul2.jar
```

The `jlib` directory contains these JAR files:

```
orail8n.jar
orail8n-collation.jar
orail8n-mapping.jar
orail8n-utility.jar
```

The `jdbc` directory contains this `lib` subdirectory:

```
| - lib/
    ojdbc6.jar
```

The `rdbms` directory contains this `jlib` subdirectory:

```
| - jlib/
    xdb.jar
```

And, the `xdk` directory contains this `demo` subdirectory:

```
| demo/
  | - java/
  |   | - classgen/
  |   | - jaxb/
  |   | - parser/
  |   | - pipeline/
  |   | - schema/
  |   | - transviewer/
  |   | - tranxs/
  |   | - xsql/
  |   | - xsu/
```

The `/xdk/demo/java` subdirectories contain sample programs and data files for XDK for Java components. The chapters in [Oracle XML Developer's Kit for Java](#) (page 1) explain how to use these programs to learn about the most important Java features.

See Also:

[Table 1-1](#) (page 1-2) for descriptions of individual XDK for Java components

Example 3-1 Oracle XML Developer's Kit for Java Libraries, Utilities, and Demos

```
- $ORACLE_HOME
  | - bin/
  | - lib/
  | - jlib/
  | - jdbc/
  | - rdbms/
  | - xdk/
```

3.2 XDK for Java Component Dependencies

The dependencies of XDK for Java components when using Java Development Kit (JDK) are described.

XDK for Java components are certified and supported with JDK versions 5 and 6. Earlier versions of Java are no longer supported. [Figure 3-1](#) (page 3-3) shows the dependencies of XDK for Java components when using JDK 5.

Figure 3-1 Oracle XML Developer's Kit for Java Component Dependencies for JDK 5

	TransX Utility (xml.jar)	JavaBeans (xmldemo.jar, xml.jar)	XSQL Servlet (xml.jar)
	XML SQL Utility (xsul2.jar, xdb.jar)		Web Server with Java Servlet Support
Class Generator (xml.jar)	JDBC Driver (ojdbc5.jar)		
XML Parser / XSL Processor / XML Pipeline / JAXP / XML Schema Processor / XML Compressor / JAXB (xmlparserv2.jar, xmlmsg.jar, xml.jar)		Globalization Support (orai18n.jar, orai18n-collation.jar, orai18n-mapping.jar, orai18n-utility.jar)	
JDK			

XDK for Java components need the libraries in [Table 3-1](#) (page 3-3). Some of the libraries are not specific to XDK, but are shared among other Oracle Database components.

Table 3-1 Java Libraries for Oracle XML Developer's Kit for Java Components

Library	Directory	Includes . . .
classgen.jar	\$ORACLE_HOME/lib	Extensible Markup Language (XML) class generator for Java runtime classes. Note: This library is maintained only for backward compatibility. Use the Java Architecture for XML Binding (JAXB) class generator in xml.jar instead.
jdev-rt.zip	\$ORACLE_HOME/lib	Java graphical user interface (GUI) libraries for use when working with the demos with the Java Development Environment (JDE).
ojdbc6.jar	\$ORACLE_HOME/jdbc/lib	Oracle Java Database Connectivity (JDBC) drivers for Java 6. This Java Archive (JAR) depends on orai18n.jar for character set support if you use a multibyte character set other than 8-bit encoding of Unicode (UTF-8), ISO8859-1, or JA16SJIS.
oraclexsql.jar	\$ORACLE_HOME/lib	Most of the XSQL Servlet classes needed to construct XSQL pages. Note: This JAR is superseded by xml.jar and is retained only for backward compatibility.
orai18n.jar	\$ORACLE_HOME/jlib	Globalization support for JDK 1.2 or above. It is a wrapper of all other Globalization JARs and includes character set converters. If you use a multibyte character set other than UTF-8, ISO8859-1, or JA16SJIS, then put this archive in your CLASSPATH so that JDBC can convert the character set of the input file to the database character set when loading XML files with XML SQL Utility (XSU), TransX Utility, or XSQL Servlet.

Table 3-1 (Cont.) Java Libraries for Oracle XML Developer's Kit for Java Components

Library	Directory	Includes . . .
ora18n-collation.jar	\$ORACLE_HOME/jlib	Globalization collation features: the OraCollator class and the 1x3*.g1b and 1x4001[0-9].g1b files.
ora18n-mapping.jar	\$ORACLE_HOME/jlib	Globalization locale and character set name mappings: the OraResourceBundle class and 1x4000[0-9].g1b files. This archive is used mainly by products that need only locale name mapping tables.
ora18n-utility.jar	\$ORACLE_HOME/jlib	Globalization locale objects: the OraLocaleInfo class, the OraNumberFormat and OraDateFormat classes, and the 1x[01]*.g1b files.
transx.zip	\$ORACLE_HOME/lib	TransX Utility classes. Note: This archive is superseded by xml.jar and is retained only for backward compatibility.
xdb.jar	\$ORACLE_HOME/rdbms/jlib	Classes needed by xml.jar to access XMLType, classes needed to access Oracle XML DB Repository, and XMLType Document Object Model (DOM) classes for manipulation of the DOM tree.
xml.jar	\$ORACLE_HOME/lib	JAXB and Pipeline Processor classes and classes from these libraries: <ul style="list-style-type: none"> • oraclexsql.jar • xsqlserializers.jar • transx.jar
xmldemo.jar	\$ORACLE_HOME/lib	The visual JavaBeans: XMLTreeView, XMLTransformPanel, XMLSourceView, and DBViewer.
xmlmsg.jar	\$ORACLE_HOME/lib	Support for using XML parser with a language other than English.
xmlparserv2.jar	\$ORACLE_HOME/lib	Application programming interfaces (APIs) for: <ul style="list-style-type: none"> • DOM and Simple API for XML (SAX) parsers • XML Schema processor • Extensible Stylesheet Language Transformation (XSLT) processor • XML compression • Java API for XML Processing (JAXP) • Utility functionality such as XMLSAXSerializer and asynchronous DOM Builder This library includes xschema.jar.
xschema.jar	\$ORACLE_HOME/lib	XML Schema classes contained in xmlparserv2.jar. Note: This JAR file is retained only for backward compatibility.

Table 3-1 (Cont.) Java Libraries for Oracle XML Developer's Kit for Java Components

Library	Directory	Includes . . .
xsqlserializers.jar	\$ORACLE_HOME/lib	Classes that XSQL Servlet needs for serialized output such as PDF. Note: This archive is superseded by xml.jar and is retained only for backward compatibility.
xsu12.jar	\$ORACLE_HOME/lib	Classes that implement XSU. These classes depend on xdb.jar for XMLType access.

See Also:

- *Oracle Database Globalization Support Guide* to learn about the Globalization Support libraries
- *Oracle Database JDBC Developer's Guide* to learn about the JDBC libraries
- *Oracle XML DB Developer's Guide* to learn about Oracle XML DB

3.3 Setting Up the XDK for Java Environment

You can set up the XDK for Java environment using either an environment variable or a command-line option.

To set up the XDK for Java environment, do either of the following:

- During Oracle Database installation of XDK, manually set the \$CLASSPATH (UNIX) or %CLASSPATH% (Windows) environment variables.
- When compiling and running Java programs at the command line, set the -classpath option.

Topics:

- [Setting Up XDK for Java Environment Variables for UNIX](#) (page 3-5)
- [Testing the XDK for Java Environment on UNIX](#) (page 3-7)
- [Setting Up XDK for Java Environment Variables for Windows](#) (page 3-7)
- [Testing the XDK for Java Environment on Windows](#) (page 3-9)

3.3.1 Setting Up XDK for Java Environment Variables for UNIX

The UNIX environment variables needed by XDK for Java components are described.

Table 3-2 UNIX Environment Variables for Oracle XML Developer's Kit for Java Components

Variable	Description
\$CLASSPATH	Includes: .:\${CLASSPATHJ}:\${ORACLE_HOME}/lib/xmlparserv2.jar: \${ORACLE_HOME}/lib/xsul2.jar:\${ORACLE_HOME}/lib/xml.jar Note: A period (.) to represent the current directory is optional.
\$CLASSPATHJ	For JDK 5, set: CLASSPATHJ=\${ORACLE_HOME}/jdbc/lib/ojdbc6.jar:\${ORACLE_HOME}/jlib/orai18n.jar Certain character sets need orai18n.jar.
\$JAVA_HOME	Installation directory for the Java JDK, Standard Edition. Modify the path that links to the Java SDK.
\$LD_LIBRARY_PATH	For OCI JDBC connections: \${ORACLE_HOME}/lib:\${LD_LIBRARY_PATH}
\$PATH	\${JAVA_HOME}/bin

After setting up the XDK for Java environment on UNIX, you can use the command-line utilities described in [Table 3-3](#) (page 3-6).

Table 3-3 Oracle XML Developer's Kit for Java UNIX Utilities

Executable/Class	Directory/JAR	Description
xsql	\${ORACLE_HOME}/bin	XSQL command-line utility. The script executes the <code>oracle.xml.xsql.XSQLCommandLine</code> class. Edit this shell script for your environment before use. See Also: Using the XSQL Pages Command-Line Utility (page 16-12)
OracleXML	\${ORACLE_HOME}/lib/xsul2.jar	XSU command-line utility See Also: Using the XSU Command-Line Utility (page 13-15)
orajaxb	\${ORACLE_HOME}/bin	JAXB command-line utility See Also: Using the JAXB Class Generator Command-Line Utility (page 10-9)
orapipe	\${ORACLE_HOME}/bin	Pipeline command-line utility See Also: Using the XML Pipeline Processor Command-Line Utility (page 11-10)
oraxml	\${ORACLE_HOME}/bin	XML parser command-line utility See Also: Using the Java XML Parser Command-Line Utility (oraxml) (page 4-15)

Table 3-3 (Cont.) Oracle XML Developer's Kit for Java UNIX Utilities

Executable/Class	Directory/JAR	Description
oraxsl	\$ORACLE_HOME/bin	XSLT processor command-line utility See Also: Using the XSLT Processor Command-Line Utility (page 6-6)
transx	\$ORACLE_HOME/bin	TransX command-line utility See Also: Using the TransX Command-Line Utility (page 14-7)

3.3.2 Testing the XDK for Java Environment on UNIX

A UNIX shell script is provided to test the XDK Java environment.

If your environment is set up correctly, then the UNIX shell script in [Example 3-2](#) (page 3-7) generates version and usage information for the utilities in [Table 3-3](#) (page 3-6).

Example 3-2 Testing the Oracle XML Developer's Kit for Java Environment on UNIX

```
#!/usr/bin/tcsh
echo;echo "BEGIN TESTING";echo
echo;echo "now testing the XSQL utility...";echo
xsql
echo; echo "now testing the XSU utility...";echo
java OracleXML
echo;echo "now testing the JAXB utility...";echo
orajaxb -version
echo;echo "now testing the Pipeline utility...";echo
orapipe -version
echo;echo "now testing the XSLT Processor utility...";echo
oraxsl
echo;echo "now testing the TransX utility...";echo
transx
echo;echo "END TESTING"
```

3.3.3 Setting Up XDK for Java Environment Variables for Windows

The Microsoft Windows environment variables needed by XDK for Java components are described.

[Table 3-4](#) (page 3-7) describes the Windows environment variables that the XDK for Java components need.

Table 3-4 Windows Environment Variables for Oracle XML Developer's Kit for Java Components

Variable	Notes
%CLASSPATH%	Includes: .;%CLASSPATH%;%ORACLE_HOME%\lib\xmlparserv2.jar; %ORACLE_HOME%\lib\xsu12.jar;%ORACLE_HOME%\lib\xml.jar; %ORACLE_HOME%\lib\xmlmsg.jar;%ORACLE_HOME%\lib\oraclexsql.jar

Note: A single period "." to represent the current directory is not required, but may be useful.

Table 3-4 (Cont.) Windows Environment Variables for Oracle XML Developer's Kit for Java Components

Variable	Notes
%CLASSPATHJ%	For JDK 5, set: CLASSPATHJ=%ORACLE_HOME%\jdbc\lib\ojdbc6.jar;%ORACLE_HOME%\lib\orai18n.jar The orai18n.jar is needed to support certain character sets.
%JAVA_HOME%	Installation directory for the Java software developer's kit (SDK), Standard Edition. Modify the path that links to the Java SDK.
%PATH%	%JAVA_HOME%\bin

After setting up the XDK for Java environment on Windows, you can use the command-line utilities described in [Table 3-5](#) (page 3-8).

Table 3-5 Oracle XML Developer's Kit for Java Windows Utilities

Batch File/Class	Directory/JAR	Description
xsql.bat	%ORACLE_HOME%\bin	XSQL command-line utility. The batch file executes the oracle.xml.xsql.XSQLCommandLine class. Edit the batch file for your environment before use. See also Using the XSQL Pages Command-Line Utility (page 16-12)
OracleXML	%ORACLE_HOME%\lib\xsu12.jar	XSU command-line utility See also Using the XSU Command-Line Utility (page 13-15)
orajaxb.bat	%ORACLE_HOME%\bin	JAXB command-line utility See also Using the JAXB Class Generator Command-Line Utility (page 10-9)
orapipeline.bat	%ORACLE_HOME%\bin	Pipeline command-line utility See also Using the XML Pipeline Processor Command-Line Utility (page 11-10)
oraxml.bat	%ORACLE_HOME%\bin	XML parser command-line utility See also Using the Java XML Parser Command-Line Utility (oraxml) (page 4-15)
oraxsl.bat	%ORACLE_HOME%\bin	XSLT processor command-line utility See also Using the XSLT Processor Command-Line Utility (page 6-6)
transx.bat	%ORACLE_HOME%\bin	TransX command-line utility See also Using the TransX Command-Line Utility (page 14-7)

3.3.4 Testing the XDK for Java Environment on Windows

An Microsoft Windows script is provided for testing the XDK for Java environment.

If your environment is set up correctly, then you can run the commands in [Example 3-3](#) (page 3-9) at the system prompt to generate version and usage information for the utilities in [Table 3-5](#) (page 3-8).

Example 3-3 Testing the Oracle XML Developer's Kit for Java Environment on Windows

```
xsql.bat
java OracleXML
orajaxb.bat -version
orapipe.bat -version
oraxsl.bat
transx.bat
```

3.4 Verifying the XDK (Java) Version

You can use `javac` to check your XDK version.

To see which version of XDK you have installed, use `javac` to compile the Java code shown in [Example 3-4](#) (page 3-9).

After compilation, run the program on the operating system command line:

```
java XDKVersion
```

The result is similar to:

```
You are using version:
Oracle XML Developers Kit 11.1.0.6.0 - Production
```

Example 3-4 XDKVersion.java

```
//
// XDKVersion.java
//
import java.net.URL;
import oracle.xml.parser.v2.XMLParser;
public class XDKVersion
{
    static public void main(String[] argv)
    {
        System.out.println("You are using version: ");
        System.out.println(XMLParser.getReleaseVersion());
    }
}
```

XML Parsing for Java

Extensible Markup Language (XML) parsing for Java is described.

Topics:

- [Introduction to XML Parsing for Java](#) (page 4-1)
- [Using XML Parsing for Java: Overview](#) (page 4-12)
- [Parsing XML with DOM](#) (page 4-16)
- [Parsing XML with SAX](#) (page 4-36)
- [Parsing XML with JAXP](#) (page 4-44)
- [Compressing and Decompressing XML](#) (page 4-49)
- [Tips and Techniques for Parsing XML](#) (page 4-52)

4.1 Introduction to XML Parsing for Java

XML parsing for Java is described.

Topics:

- [Prerequisites for Parsing with Java](#) (page 4-1)
- [Standards and Specifications for XML Parsing for Java](#) (page 4-2)
- [XML Parsing in Java: Overview](#) (page 4-3)
- [DOM in XML Parsing](#) (page 4-5)
- [SDOM](#) (page 4-5)
- [SAX in the XML Parser](#) (page 4-7)
- [JAXP in the XML Parser](#) (page 4-8)
- [Namespace Support in the XML Parser](#) (page 4-8)
- [Validation in the XML Parser](#) (page 4-9)
- [Compression in the XML Parser](#) (page 4-11)

4.1.1 Prerequisites for Parsing with Java

An Oracle XML parser reads an XML document and uses either a Document Object Model (DOM) application programming interface (API) or Simple API for XML (SAX)

to access to its content and structure. You can parse in either validating or nonvalidating mode.

This chapter assumes that you are familiar with these technologies:

- [Document Object Model \(DOM\)](#): An in-memory tree representation of the structure of an XML document.
- [Simple API for XML \(SAX\)](#): A standard for event-based XML parsing.
- [Java API for XML Processing \(JAXP\)](#): A standard interface for processing XML with Java applications that supports the DOM and SAX standards.
- [document type definition \(DTD\)](#): A set of rules that defines the valid structure of an XML document.
- [XML Schema](#): A World Wide Web Consortium (W3C) recommendation that defines the valid structure of data types in an XML document.
- [XML Namespaces](#): A mechanism for differentiating element and attribute names within an XML document.
- [binary XML](#): An XML representation that uses the compact schema-aware format, in which both scalable and nonscalable DOMs can save XML documents.

For more information, see the list of XML resources in the [Related Documents](#) (page xxix).

4.1.2 Standards and Specifications for XML Parsing for Java

The DOM Level 1, Level 2, and Level 3 specifications are W3C Recommendations.

For links to their specifications, see:

<http://www.w3.org/DOM/DOMTR>

SAX is available in version 1.0 (deprecated) and 2.0. SAX is not a W3C specification.

For SAX documentation, see:

<http://www.saxproject.org/>

XML Namespaces are a W3C Recommendation. For the specification, see:

<http://www.w3.org/TR/REC-xml-names>

JCR 1.0 (also known as JSR 170) defines a standard Java API for applications to interact with content repositories.

See Also:

Oracle XML DB Developer's Guide

JAXP is a standard API that enables use of DOM, SAX, XML Schema, and Extensible Stylesheet Language Transformation (XSLT), independent of processor implementation. For the JAXP specification and other information, see:

<http://www.oracle.com/technetwork/java/index.html>

See Also:

[Oracle XML Developer's Kit Standards](#) (page 33-1), for information about standards supported by Oracle XML Developer's Kit (XDK)

4.1.3 Large Node Handling

DOM Stream access to XML nodes is done by Procedural Language/Structured Query Language (PL/SQL) and Java APIs. Nodes in an XML document can now far exceed 64 KB. Thus Joint Photographic Experts Group (JPEG), Word, PDF, rich text format (RTF), and HTML documents can be more readily stored.

See Also:

Oracle XML DB Developer's Guide for complete details on the Java large node capabilities

4.1.4 XML Parsing in Java: Overview

`XMLParser` is the abstract base class for the XML parser for Java. An instantiated parser invokes the `parse()` method to read an XML document. `XMLDOMImplementation` factory methods provide another way to parse binary XML to create scalable DOM.

[Figure 4-1](#) (page 4-4) shows the basic parsing process, using `XMLParser`. The figure does not apply to `XMLDOMImplementation()`.

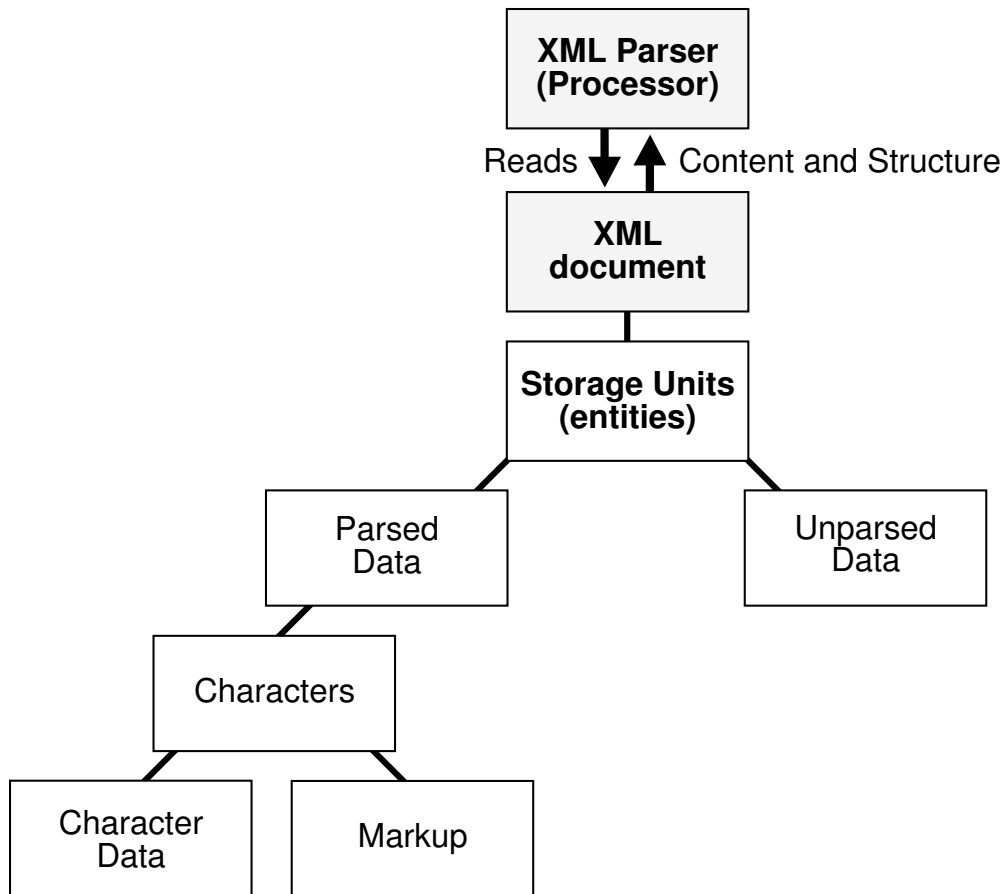
Figure 4-1 XML Parser Process

These APIs provide a Java application with access to a parsed XML document:

- **DOM API**
DOM API parses XML documents and builds a tree representation of the documents in memory. To parse with DOM API, use either a `DOMParser` object or the `XMLDOMImplementation` interface factory methods to create a pluggable, scalable DOM (SDOM).
- **SAX API**
SAX API processes an XML document as a stream of events, which means that a program cannot access random locations in a document. To parse with SAX API, use a `SAXParser` object.
- **JAXP**
JAXP is a Java-specific API that supports DOM, SAX, and Extensible Stylesheet Language (XSL). To parse with JAXP, use a `DocumentBuilder` or `SAXParser` object.

Subsequent topics use the sample XML document in [Example 4-1](#) (page 4-4) to show the differences among DOM, SAX, and JAXP.

Example 4-1 Sample XML Document

```

<?xml version="1.0"?>
  <EMPLIST>
    <EMP>

```

```

    <ENAME>MARY</ENAME>
  </EMP>
<EMP>
  <ENAME>SCOTT</ENAME>
</EMP>
</EMPLIST>

```

4.1.5 DOM in XML Parsing

DOM API builds an in-memory tree representation of the XML document. DOM API provides classes and methods to navigate and process the tree.

For example, given the document described in [Example 4-1](#) (page 4-4), the DOM API creates the in-memory tree shown in [Figure 4-2](#) (page 4-8).

The important aspects of DOM API are:

- DOM API provides a familiar tree structure of objects, making it easier to use than the SAX API.
- The tree can be manipulated. For example, elements can be reordered and renamed, and both elements and attributes can be added and deleted.
- Interactive applications can store the tree in memory, where users can access and manipulate it.
- XDK includes DOM API extensions that support XPath. (Although the DOM standard does not support XPath, most XPath implementations use DOM.)
- XDK supports SDOM. For details, see [SDOM](#) (page 4-5).

4.1.5.1 DOM Creation

In XDK for Java, there are three ways to create a DOM: parse a document using `DOMParser`, use an `XMLDOMImplementation` factory method (creates a scalable DOM), or use an `XMLDocument` constructor (uncommon).

4.1.6 SDOM

XDK supports pluggable, scalable DOM (SDOM). This support relieves problems of memory inefficiency, limited scalability, and lack of control over the DOM configuration. SDOM creation and configuration are mainly supported using the `XMLDOMImplementation` class.

Important aspects of SDOM are:

- SDOM can use plug-in external XML in its existing forms.

Plug-in XML data can be in different forms—binary XML, `XMLTYPE`, third-party DOM, and so on. SDOM need not replicate external XML in an internal representation. SDOM is created on top of plug-in XML data through the `Reader` and `InfoSetWriter` abstract interfaces.
- SDOM has transient nodes.

Nodes are created only if they are accessed and are freed if they are not used.
- SDOM can use binary XML as both input and output.

SDOM can interact with data in two ways:

 - Through the abstract `InfoSetReader` and `InfoSetWriter` interfaces.

To read and write BinXML data, users can use the BinXML implementation of `InfosetReader` and `InfosetWriter`. To read and write in other forms of XML infoset, users can use their own implementations.

- Through an implementation of the `InfosetReader` and `InfosetWriter` adaptor for `BinXMLStream`.

See Also:

[Using Binary XML with Java](#) (page 5-1)

XDK SDOM support consists of:

- [Pluggable DOM Support](#) (page 4-6)
- [Lazy Materialization](#) (page 4-6)
- [Configurable DOM Settings](#) (page 4-6)
- [DOM Support for Fast Infoset](#) (page 4-7)

4.1.6.1 Pluggable DOM Support

Pluggable DOM lets you split the DOM API from the data layer. The DOM API is separated from the data by the `InfosetReader` and `InfosetWriter` interfaces. Using pluggable DOM, you can easily move XML data from one processor to another.

The DOM API includes unified standard APIs on top of the data to support node access, navigation, update processes, and searching capability.

See Also:

[Using SDOM](#) (page 4-22)

4.1.6.2 Lazy Materialization

Using lazy materialization, XDK creates only nodes that are accessed and frees unused nodes from memory. Applications can process very large XML documents with improved scalability.

See Also:

[Using Lazy Materialization](#) (page 4-24)

4.1.6.3 Configurable DOM Settings

DOM configurations can be made to suit different applications. You can configure the DOM with different access patterns such as read-only, streaming, transient update, and shadow copy, achieving maximum memory use and performance in your applications.

See Also:

[Using Configurable DOM Settings](#) (page 4-26)

4.1.6.4 DOM Support for Fast Infoset

Fast Infoset, developed by Oracle, is a compact binary XML format that represents the XML Infoset. This format has become the international standard ITU-T SG 17 and ISO/IEC JTC1 SC6. The Fast Infoset representation of XML Infoset is popular within the Java XML and Web Service communities.

Fast Infoset provides these benefits in comparison with other formats:

- It is more compact, parses faster, and serializes better than XML text.
- It encodes and decodes faster than parsing of XML text, and Fast Infoset documents are generally 20 to 60 percent smaller than the corresponding XML text.
- It leads other binary XML formats in performance and compression ratio, and handles small to large documents in a more balanced manner.

SDOM is the XDK DOM configuration that supports scalability. It is built on top of serialized binary data to provide a DOM API to applications like XPath and XSLT. SDOM has an open plug-in architecture that reads binary data through an abstract API `InfosetReader`. The `InfosetReader` API allows SDOM to decode the binary data going forward, remember the start location of the nodes, and search a location to decode from there. This support enables SDOM to free nodes that are not in use and re-create those nodes from binary data when they are needed. When binary data is stored externally, such as in a file or a BLOB, SDOM is highly scalable.

See Also:

[Using Fast Infoset with SDOM](#) (page 4-28)

4.1.7 SAX in the XML Parser

Unlike DOM, SAX is event-based, so SAX API does not build in-memory tree representations of input documents. SAX API processes the input document element by element and can report events and significant data to callback methods in the application.

For example, given the document described in [Example 4-1](#) (page 4-4), the SAX API parses it as the series of linear events shown in [Figure 4-2](#) (page 4-8).

The important aspects of SAX API are:

- It is useful for search operations and other programs that need not manipulate an XML tree.
- It does not consume significant memory resources.
- It is faster than DOM when retrieving XML documents from a database.

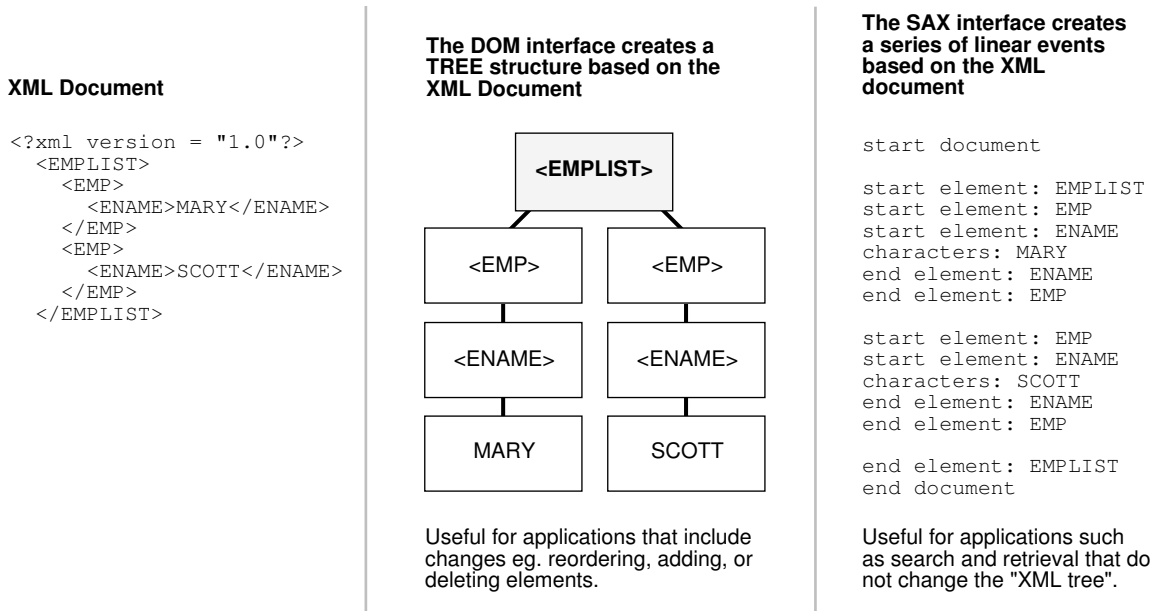
Figure 4-2 Comparing DOM (Tree-Based) and SAX (Event-Based) APIs

4.1.8 JAXP in the XML Parser

JAXP lets you plug in an implementation of the SAX or DOM parser. The SAX and DOM APIs provided by XDK are examples of vendor-specific implementations supported by JAXP. The main advantage of JAXP is that it lets you write interoperable applications.

An application that uses features available through JAXP can very easily switch the implementation.

The main disadvantage of JAXP is that it runs more slowly than vendor-specific APIs. Also, JAXP lacks several features that Oracle-specific APIs provide. Some Oracle-specific features are available through the JAXP extension mechanism, but an application that uses these extensions loses the flexibility of switching implementation.

4.1.9 Namespace Support in the XML Parser

Namespaces can help you avoid name collisions between elements or attributes in XML documents.

[Example 4-2](#) (page 4-9) is an XML document that uses the `<address>` tag for both a company address and an employee address. An XML processor cannot distinguish between a company address and an employee address.

[Example 4-3](#) (page 4-9) is an XML document that uses these namespaces to distinguish between company and employee `<address>` tags:

```
http://www.oracle.com/employee
http://www.oracle.com/company
```

[Example 4-3](#) (page 4-9) associates the `com` prefix with the first namespace and the `emp` prefix with the second namespace.

When parsing documents that use namespaces, it is helpful to remember these terms:

- **Namespace URI** is the URI assigned to `xmlns`. In [Example 4-3](#) (page 4-9), `http://www.oracle.com/employee` and `http://www.oracle.com/company` are namespace URIs.
- **Namespace prefix** is a namespace identifier declared with `xmlns`. In [Example 4-3](#) (page 4-9), `emp` and `com` are namespace prefixes.
- **Local name** is the name of an element or attribute without the namespace prefix. In [Example 4-3](#) (page 4-9), `employee` and `company` are local names.
- **Qualified name** is the local name plus the prefix. In [Example 4-3](#) (page 4-9), `emp:employee` and `com:company` are qualified names.
- **Expanded name** is the result of substituting the namespace URI for the namespace prefix. In [Example 4-3](#) (page 4-9), `http://www.oracle.com/employee:employee` and `http://www.oracle.com/company:company` are expanded element names.

Example 4-2 Sample XML Document Without Namespaces

```
<?xml version='1.0'?>
<addresslist>
  <company>
    <address>500 Oracle Parkway,
      Redwood Shores, CA 94065
    </address>
  </company>
  <!-- ... -->
  <employee>
    <lastname>King</lastname>
    <address>3290 W Big Beaver
      Troy, MI 48084
    </address>
  </employee>
  <!-- ... -->
</addresslist>
```

Example 4-3 Sample XML Document with Namespaces

```
<?xml version='1.0'?>
<addresslist>
  <!-- ... -->
  <com:company
    xmlns:com="http://www.oracle.com/company">
    <com:address>500 Oracle Parkway,
      Redwood Shores, CA 94065
    </com:address>
  </com:company>
  <!-- ... -->
  <emp:employee
    xmlns:emp="http://www.oracle.com/employee">
    <emp:lastname>King</emp:lastname>
    <emp:address>3290 W Big Beaver
      Troy, MI 48084
    </emp:address>
  </emp:employee>
```

4.1.10 Validation in the XML Parser

To parse an XML document, invoke the `parse()` method. Typically, you invoke initialization and termination methods in association with the `parse()` method.

The parser mode can be either validating or nonvalidating. In validating mode, the parser determines whether the document conforms to the specified DTD or XML schema. In nonvalidating mode, the parser checks only for well-formedness. To set the parser mode, invoke the `setValidationMode()` method defined in `oracle.xml.parser.v2.XMLParser`.

[Table 4-1](#) (page 4-10) shows the `setValidationMode()` flags that you can use in the XDK parser.

Table 4-1 XML Parser for Java Validation Modes

Name	Value	The XML Parser . . .
Nonvalidating mode	NONVALIDATING	Verifies that the XML is well-formed and parses the data.
DTD validating mode	DTD_VALIDATION	Verifies that the XML is well-formed and validates the XML data against the DTD. The DTD defined in the <code><!DOCTYPE></code> declaration must be relative to the location of the input XML document.
Schema validation mode	SCHEMA_VALIDATION	Validates the XML Document according to the XML schema specified for the document.
LAX validation mode	SCHEMA_LAX_VALIDATION	Tries to validate part or all of the instance document if it can find the schema definition. It does not raise an error if it cannot find the definition. See the sample program <code>XSDLax.java</code> in the <code>schema</code> directory.
Strict validation mode	SCHEMA_STRICT_VALIDATION	Tries to validate the whole instance document, raising errors if it cannot find the schema definition or if the instance does not conform to the definition.
Partial validation mode	PARTIAL_VALIDATION	Validates all or part of the input XML document according to the DTD, if present. If the DTD is not present, then the parser is set to nonvalidating mode.
Auto validation mode	AUTO_VALIDATION	Validates all or part of the input XML document according to the DTD or XML schema, if present. If neither is present, then the parser is set to nonvalidating mode.

In addition to setting the validation mode with `setValidationMode()`, you can use the `oracle.xml.parser.schema.XSDBuilder` class to build an XML schema and then configure the parser to use it by invoking the `XMLParser.setXMLSchema()` method. In this case, the XML parser automatically sets the validation mode to `SCHEMA_STRICT_VALIDATION` and ignores the `schemaLocation` and `noNamespaceSchemaLocation` attributes. You can also change the validation mode to `SCHEMA_LAX_VALIDATION`. The `XMLParser.setDoctype()` method is a parallel method for DTDs, but unlike `setXMLSchema()` it does not alter the validation mode.

See Also:

- [Using the XML Schema Processor for Java](#) (page 9-1) to learn about validation
 - *Oracle Database XML Java API Reference* to learn about the `XMLParser` and `XSDBuilder` classes
-
-

4.1.11 Compression in the XML Parser

You can use the XML compressor, which is implemented in the XML parser, to compress and decompress XML documents. The compression algorithm is based on tokenizing the XML tags.

The assumption is that any XML document repeats some tags, so tokenizing these tags gives considerable compression. The degree of compression depends on the type of document: the larger the tags and the lesser the text content, the better the compression.

The Oracle XML parser generates a binary compressed output from either an in-memory DOM tree or SAX events generated from an XML document. [Table 4-2](#) (page 4-11) describes the two types of compression.

Table 4-2 XML Compression with DOM and SAX

Type	Description	Compression APIs
DOM-based	The goal is to reduce the size of the XML document without losing the structural and hierarchical information of the DOM tree. The parser serializes an in-memory DOM tree, corresponding to a parsed XML document, and generates a compressed XML output stream. The serialized stream regenerates the DOM tree when read back.	Use the <code>writeExternal()</code> method to generate compressed XML and the <code>readExternal()</code> method to reconstruct it. The methods are in the <code>oracle.xml.parser.v2.XMLDocument</code> class.
SAX-based	The SAX parser generates a compressed stream when it parses an XML file. SAX events generated by the SAX parser are handled by the SAX compression utility, which generates a compressed binary stream. When the binary stream is read back, the SAX events are generated.	To generate compressed XML, instantiate <code>oracle.xml.comp.CXMLHandlerBase</code> by passing an output stream to the constructor. Pass the object to <code>SAXParser.setContentHandler()</code> and then execute the <code>parse()</code> method. Use the <code>oracle.xml.comp.CXMLParser</code> class to decompress the XML. Note: <code>CXMLHandlerBase</code> implements both SAX 1.0 and 2.0, but because 1.0 is deprecated, Oracle recommends that you use the 2.0 API.

The compressed streams generated from DOM and SAX are compatible; that is, you can use the compressed stream generated from SAX to generate the DOM tree and the reverse. As with XML documents in general, you can store the compressed XML data output in the database as a BLOB data item.

When a program parses a large XML document and creates a DOM tree in memory, it can affect performance. You can compress an XML document into a binary stream by serializing the DOM tree. You can regenerate the DOM tree without validating the XML data in the compressed stream. You can treat the compressed stream as a serialized stream, but the data in the stream is more controlled and managed than the compression implemented by Java default serialization.

Note:

Oracle Text cannot search a compressed XML document. Decompression reduces performance. If you are transferring files between client and server, then Hypertext Transfer Protocol (HTTP) compression can be easier.

4.2 Using XML Parsing for Java: Overview

The fundamental component of any XML development is XML parsing. XML parsing for Java is a standalone XML component that parses an XML document (and possibly also a standalone DTD or XML schema) so that your program can process it.

Topics:

- [Using the XML Parser for Java: Basic Process](#) (page 4-12)
- [Running the XML Parser for Java Demo Programs](#) (page 4-13)
- [Using the Java XML Parser Command-Line Utility \(oraxml\)](#) (page 4-15)

Note:

You can use the parser with any supported Java Virtual Machine (JVM). With Oracle9i or later, you can load the parser into the database and use the internal Oracle JVM. For other database versions, run the parser in an external JVM and connect to a database through JDBC.

4.2.1 Using the XML Parser for Java: Basic Process

The basic process of using the XML Parser for Java is described.

[Figure 4-3](#) (page 4-12) shows how to use the XML parser in a typical XML processing application.

Figure 4-3 XML Parser for Java

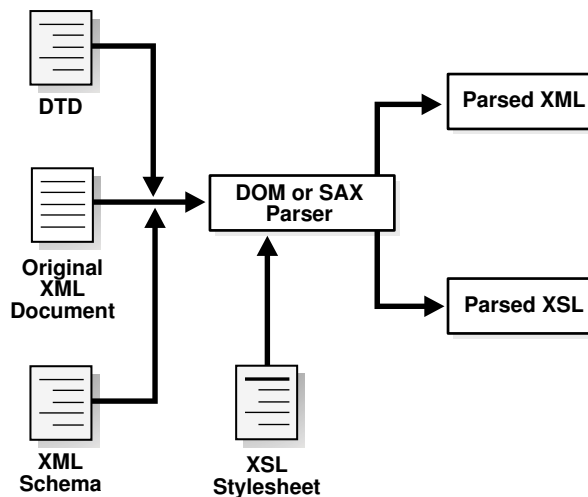

The basic process of the application shown in [Figure 4-3](#) (page 4-12) is:

1. The DOM or SAX parser parses input XML documents. For example, the program can parse XML data documents, DTDs, XML schemas, and XSL stylesheets.
2. If you implement a validating parser, then the processor attempts to validate the XML data document against any supplied DTDs or XML schemas.

See Also:

- [Using the XSLT Processor for Java](#) (page 6-1)
- [Using the XML Schema Processor for Java](#) (page 9-1) to learn about validation
- *Oracle Database XML Java API Reference* for XML parser classes and methods

4.2.2 Running the XML Parser for Java Demo Programs

Demo programs for the XML parser for Java are included in `$ORACLE_HOME/xdk/demo/java/parser`.

The demo programs are distributed among the subdirectories described in [Table 4-3](#) (page 4-13).

Table 4-3 Java Parser Demos

Directory	Contents	These programs ...
common	class.xml DemoUtil.java empl.xml family.dtd family.xml iden.xsl NSExample.xml traversal.xml	Provide XML files and Java programs for general use with the XML parser. For example, you can use the XSLT stylesheet <code>iden.xsl</code> to achieve an identity transformation of the XML files. <code>DemoUtil.java</code> implements a helper method to create a URL from a file name, and is used by many other demo programs.
comp	DOMCompression.java DOMDeCompression.java SAXCompression.java SAXDeCompression.java SampleSAXHandler.java sample.xml xml.ser	Show DOM and SAX compression: <ul style="list-style-type: none"> • <code>DOMCompression.java</code> compresses a DOM tree. • <code>DOMDeCompression.java</code> reads back a DOM from a compressed stream. • <code>SAXCompression.java</code> compresses the output from a SAX parser. • <code>SAXDeCompression.java</code> regenerates SAX events from the compressed stream. • <code>SampleSAXHandler.java</code> shows use of a handler to handle the events thrown by the SAX DeCompressor.

Table 4-3 (Cont.) Java Parser Demos

Directory	Contents	These programs ...
dom	AutoDetectEncoding.java DOM2Namespace.java DOMNamespace.java DOMRangeSample.java DOMSample.java EventSample.java I18nSafeXMLFileWritingSample.java NodeIteratorSample.java ParseXMLFromString.java TreeWalkerSample.java	Show uses of the DOM API: <ul style="list-style-type: none"> • <code>DOM2Namespace.java</code> shows how to use DOM Level 2.0 APIs. • <code>DOMNamespace.java</code> shows how to use Namespace extensions to DOM APIs. • <code>DOMRangeSample.java</code> shows how to use DOM Range APIs. • <code>DOMSample.java</code> shows basic use of the DOM APIs. • <code>EventSample.java</code> shows how to use DOM Event APIs. • <code>NodeIteratorSample.java</code> shows how to use DOM Iterator APIs. • <code>TreeWalkerSample.java</code> shows how to use DOM TreeWalker APIs.
jaxp	JAXPExamples.java age.xsl general.xml jaxpone.xml jaxpone.xsl jaxpthree.xsl jaxptwo.xsl oraContentHandler.java	Show various uses of the JAXP: <ul style="list-style-type: none"> • <code>JAXPExamples.java</code> provides a few examples of how to use the JAXP 1.1 API to run the Oracle engine. • <code>oraContentHandler.java</code> implements a SAX content handler. The program invokes methods such as <code>startDocument()</code>, <code>endDocument()</code>, <code>startElement()</code>, and <code>endElement()</code> when it recognizes an XML tag.
sax	SAX2Namespace.java SAXNamespace.java SAXSample.java Tokenizer.java	Show various uses of the SAX APIs: <ul style="list-style-type: none"> • <code>SAX2Namespace.java</code> shows how to use SAX 2.0. • <code>SAXNamespace.java</code> shows how to use namespace extensions to SAX APIs. • <code>SAXSample.java</code> shows basic use of the SAX APIs. • <code>Tokenizer.java</code> shows how to use the <code>XMLToken</code> interface APIs. The program implements the <code>XMLToken</code> interface, which must be registered with the <code>setTokenHandler()</code> method. A request for XML tokens is registered with the <code>setToken()</code> method. During tokenizing, the parser does not validate the document and does not include or read internal/external utilities.

Table 4-3 (Cont.) Java Parser Demos

Directory	Contents	These programs ...
xslt	XSLSample.java XSLSample2.java match.xml match.xsl math.xml math.xsl number.xml number.xsl position.xml position.xsl reverse.xml reverse.xsl string.xml string.xsl style.txt variable.xml variable.xsl	Show the transformation of documents with XSLT: <ul style="list-style-type: none"> XSLSample.java shows how to use the XSL processing capabilities of the Oracle XML parser. It transforms an input XML document with a given input stylesheet. This demo builds the result of XSL transformations as a DocumentFragment and so does not support xsl:output features. XSLSample2.java transforms an input XML document with a given input stylesheet. The demo streams the result of the XSL transformation and so supports xsl:output features. <p>See Also: Running the XSLT Processor Demo Programs (page 6-4)</p>

Documentation for how to compile and run the sample programs is located in the README file. The basic procedure is:

1. Change into the \$ORACLE_HOME/xdk/demo/java/parser directory (UNIX) or %ORACLE_HOME%\xdk\demo\java\parser directory (Windows).
2. Set up your environment as described in [Setting Up the XDK for Java Environment](#) (page 3-5).
3. Change into each of these subdirectories and run make (UNIX) or Make.bat (Windows) at the command line. For example:

```
cd comp;make;cd ..
cd jaxp;make;cd ..
cd sax;make;cd ..
cd dom;make;cd ..
cd xslt;make;cd ..
```

The make file compiles the source code in each directory, runs the programs, and writes the output for each program to a file with an *.out extension.

4. You can view the *.out files to view the output for the programs.

4.2.3 Using the Java XML Parser Command-Line Utility (oraxml)

The oraxml utility, which is located in \$ORACLE_HOME/bin (UNIX) or %ORACLE_HOME%\bin (Windows), is a command-line interface that parses XML documents. It checks for both well-formedness and validity.

To use oraxml, ensure that:

- Your CLASSPATH is set up as described in [Setting Up the XDK for Java Environment](#) (page 3-5), and your CLASSPATH environment variable references the xmlparserv2.jar file.

- Your `PATH` environment variable can find the Java interpreter that comes with your version of the Java Development Kit (JDK).

[Table 4-4](#) (page 4-16) lists the `oraxml` command-line options.

Table 4-4 *oraxml* Command-Line Options

Option	Purpose
<code>-help</code>	Prints the help message
<code>-version</code>	Prints the release version
<code>-novalidate <i>fileName</i></code>	Checks whether the input file is well-formed
<code>-dtd <i>fileName</i></code>	Validates the input file with DTD Validation
<code>-schema <i>fileName</i></code>	Validates the input file with Schema Validation
<code>-log <i>logfile</i></code>	Writes the errors to the output log file
<code>-comp <i>fileName</i></code>	Compresses the input XML file
<code>-decomp <i>fileName</i></code>	Decompresses the input compressed file
<code>-enc <i>fileName</i></code>	Prints the encoding of the input file
<code>-warning</code>	Shows warnings

For example, change into the `$ORACLE_HOME/xdk/demo/java/parser/common` directory. You can validate the document `family.xml` against `family.dtd` by executing this command on the command line:

```
oraxml -dtd -enc family.xml
```

The output is:

```
The encoding of the input file: UTF-8
```

```
The input XML file is parsed without errors using DTD validation mode.
```

4.3 Parsing XML with DOM

The W3C standard library `org.w3c.dom` defines the `Document` class and classes for the components of a DOM. The Oracle XML parser includes the standard DOM APIs and complies with the W3C DOM recommendation.

Along with `org.w3c.dom`, Oracle XML parsing includes classes that implement the DOM APIs and extends them to provide features such as printing document fragments and retrieving namespace information.

Topics:

- [Using the DOM API for Java](#) (page 4-17)
- [DOM Parser Architecture](#) (page 4-17)
- [Performing Basic DOM Parsing](#) (page 4-18)
- [Creating SDOM](#) (page 4-22)

- [Performing DOM Operations with Namespaces](#) (page 4-29)
- [Performing DOM Operations with Events](#) (page 4-31)
- [Performing DOM Operations with Ranges](#) (page 4-32)
- [Performing DOM Operations with TreeWalker](#) (page 4-34)

4.3.1 Using the DOM API for Java

Java classes that you can use to implement DOM-based components in your XML application are described.

Use these classes:

- `oracle.xml.parser.v2.DOMParser`

This class implements an XML 1.0 parser according to the W3C recommendation. Because `DOMParser` extends `XMLParser`, all methods of `XMLParser` are available to `DOMParser`.

See Also:

[DOM Parser Architecture](#) (page 4-17)

- `oracle.xml.parser.v2.XMLDOMImplementation`

This class contains factory methods used to create SDOM.

See Also:

[Creating SDOM](#) (page 4-22)

You can also use the `DOMNamespace` and `DOM2Namespace` classes, which are sample programs included in `$ORACLE_HOME/xdk/demo/java/parser/dom`.

4.3.2 DOM Parser Architecture

The architecture of the DOM Parser is described.

Figure 4-4 Basic Architecture of the DOM Parser

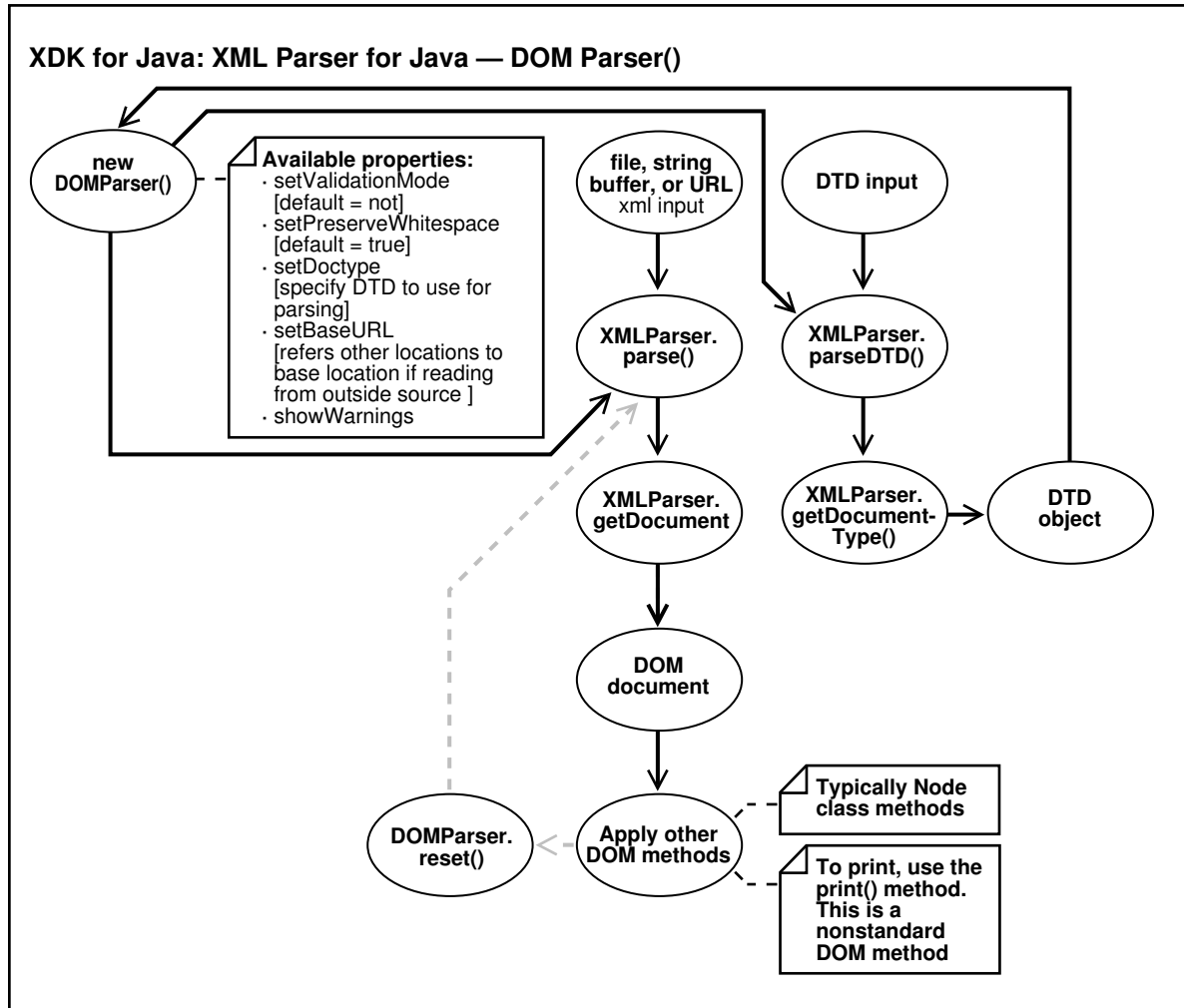

4.3.3 Performing Basic DOM Parsing

DOMSample.java shows the basic steps for parsing an input XML document and accessing it through a DOM. DOMSample.java receives an XML file as input, parses it, and prints the elements and attributes in the DOM tree.

The steps, which provide possible methods and interfaces that you can use, are:

1. Create a DOMParser object (a parser) by invoking the DOMParser() constructor.

The code in DOMSample.java is:

```
DOMParser parser = new DOMParser();
```

2. Configure the parser properties, using the methods in Table 4-5 (page 4-21).

This code fragment from DOMSample.java specifies the error output stream, sets the validation mode to DTD validation, and enables warning messages:

```
parser.setErrorStream(System.err);
parser.setValidationMode(DOMParser.DTD_VALIDATION);
parser.showWarnings(true);
```

3. Parse the input XML document by invoking the `parse()` method, which builds a tree of `Node` objects in memory.

This code fragment from `DOMSample.java` parses an instance of the `java.net.URL` class:

```
parser.parse(url);
```

The XML input can be a file, a string buffer, or a URL. As the following code fragment shows, `DOMSample.java` accepts a file name as a parameter and invokes the `createURL` helper method to construct a URL object that can be passed to the parser:

```
public class DOMSample
{
    static public void main(String[] argv)
    {
        try
        {
            if (argv.length != 1)
            {
                // Must pass in the name of the XML file.
                System.err.println("Usage: java DOMSample filename");
                System.exit(1);
            }
            ...
            // Generate a URL from the filename.
            URL url = DemoUtil.createURL(argv[0]);
            ...
        }
    }
}
```

4. Invoke `getDocument()` to get a handle to the root of the in-memory DOM tree, which is an `XMLDocument` object.

You can use this handle to access every part of the parsed XML document. The `XMLDocument` class implements the interfaces in [Table 4-6](#) (page 4-21).

The code fragment from `DOMSample.java` is:

```
XMLDocument doc = parser.getDocument();
```

5. Get and manipulate DOM nodes of the retrieved document by invoking `XMLDocument` methods in [Table 4-7](#) (page 4-21).

This code fragment from `DOMSample.java` uses the `DOMParser.print()` method to print the elements and attributes of the DOM tree:

```
System.out.print("The elements are: ");
printElements(doc);

System.out.println("The attributes of each element are: ");
printElementAttributes(doc);
```

The following code fragment from `DOMSample.java` implements the `printElements()` method, which invokes `getElementsByTagName()` to get a list of all the elements in the DOM tree. Then the code loops through the list, invoking `getNodeName()` to print the name of each element:

```
static void printElements(Document doc)
{
    NodeList nl = doc.getElementsByTagName("*");
    Node n;
```

```

    for (int i=0; i<nl.getLength(); i++)
    {
        n = nl.item(i);
        System.out.print(n.getNodeName() + " ");
    }

    System.out.println();
}

```

The following code fragment from `DOMSample.java` implements the `printElementAttributes()` method, which invokes `Document.getElementsByTagName()` to get a list of all the elements in the DOM tree. Then the code loops through the list, invoking `Element.getAttributes()` to get the list of attributes for the element and invoking `Node.getNodeName()` to get the attribute name and `Node.getNodeValue()` to get the attribute value:

```

static void printElementAttributes(Document doc)
{
    NodeList nl = doc.getElementsByTagName("*");
    Element e;
    Node n;
    NamedNodeMap nnm;

    String attrname;
    String attrval;
    int i, len;

    len = nl.getLength();

    for (int j=0; j < len; j++)
    {
        e = (Element)nl.item(j);
        System.out.println(e.getTagName() + ":");
        nnm = e.getAttributes();

        if (nnm != null)
        {
            for (i=0; i<nnm.getLength(); i++)
            {
                n = nnm.item(i);
                attrname = n.getNodeName();
                attrval = n.getNodeValue();
                System.out.print(" " + attrname + " = " + attrval);
            }
        }
        System.out.println();
    }
}

```

6. Reset the parser state by invoking the `reset()` method. The parser is now ready to parse a new document.

[Table 4-5](#) (page 4-21) summarizes the `DOMParser` configuration methods.

Table 4-5 DOMParser Configuration Methods

Method	Purpose
<code>setBaseURL()</code>	Sets the base URL for loading external entities and DTDs. Invoke this method if the XML document is an <code>InputStream</code> .
<code>setDoctype()</code>	Specifies the DTD to use when parsing.
<code>setErrorStream()</code>	Creates an output stream for the output of errors and warnings.
<code>setPreserveWhitespace()</code>	Instructs the parser to preserve the white space in the input XML document.
<code>setValidationMode()</code>	Sets the validation mode of the parser. Table 4-1 (page 4-10) describes the flags that you can use with this method.
<code>showWarnings()</code>	Specifies whether the parser prints warnings.

[Table 4-6](#) (page 4-21) summarizes the interfaces that the `XMLDocument` class implements.

Table 4-6 Some Interfaces Implemented by XMLDocument

Interface	What Interface Defines
<code>org.w3c.dom.Node</code>	A single node in the document tree and methods to access and process the node.
<code>org.w3c.dom.Document</code>	A <code>Node</code> that represents the entire XML document.
<code>org.w3c.dom.Element</code>	A <code>Node</code> that represents an XML element.

[Table 4-7](#) (page 4-21) summarizes the methods for getting and manipulating DOM tree nodes.

Table 4-7 Methods for Getting and Manipulating DOM Tree Nodes

Method	Purpose
<code>getAttributes()</code>	Generates a <code>NamedNodeMap</code> containing the attributes of this node (if it is an element) or <code>null</code> otherwise.
<code>getElementsbyTagName()</code>	Retrieves recursively all elements that match a given tag name under a certain level. This method supports the <code>*</code> tag, which matches any tag. Invoke <code>getElementsbyTagName(" * ")</code> through the handle to the root of the document to generate a list of all elements in the document.
<code>getExpandedName()</code>	Gets the expanded name of the element. This method is specified in the <code>NSName</code> interface.

Table 4-7 (Cont.) Methods for Getting and Manipulating DOM Tree Nodes

Method	Purpose
<code>getLocalName()</code>	Gets the local name for this element. If an element name is <code><E1:locn xmlns:E1="http://www.oracle.com/" /></code> , then <code>locn</code> is the local name.
<code>getNamespaceURI()</code>	Gets the namespace URI of this node, or null if it is unspecified. If an element name is <code><E1:locn xmlns:E1="http://www.oracle.com/" /></code> , then <code>http://www.oracle.com</code> is the namespace URI.
<code>getNodeName()</code>	Gets the name of a node in the DOM tree.
<code>getNodeValue()</code>	Gets the value of this node, depending on its type. This node is in the <code>Node</code> interface.
<code>getPrefix()</code>	Gets the namespace prefix for an element.
<code>getQualifiedName()</code>	Gets the qualified name for an element. If an element name is <code><E1:locn xmlns:E1="http://www.oracle.com/" /></code> , then <code>E1:locn</code> is the qualified name..
<code>getTagName()</code>	Gets the name of an element in the DOM tree.

4.3.4 Creating SDOM

How to create and use a pluggable, scalable DOM (SDOM) is explained.

Topics:

- [Using SDOM](#) (page 4-22)
- [Using Lazy Materialization](#) (page 4-24)
- [Using Configurable DOM Settings](#) (page 4-26)
- [Using Fast Infoset with SDOM](#) (page 4-28)
- [SDOM Applications](#) (page 4-29)
- [XDK Java DOM Improvements](#) (page 4-29)

4.3.4.1 Using SDOM

How to use SDOM is described.

SDOM has the DOM API split from the data. The underlying data can be either internal data or plug-in data, and both can be in binary XML.

Internal data is XML text that has not been parsed. To be plugged in, internal data must be saved as binary XML and then parsed by the `DOMParser`. The parsed binary XML can be then be plugged into the `InfoSetReader` of the DOM API layer. The `InfoSetReader` argument is the interface to the underlying XML data.

Plug-in data is XML text that has been parsed, and can therefore be transferred from one processor to another.

To create an SDOM, you plug in XML data through the `InfosetReader` API on an `XMLDOMImplementation` object. For example:

```
public Document createDocument(InfosetReader reader) throws DOMException
```

The `InfosetReader` API is implemented on top of `BinXMLStream`. Optional adaptors for other forms of XML data (such as dom4j, JDOM, or Java Database Connectivity (JDBC)) may also be supported. You can also plug in your own implementations.

`InfosetReader` serves as the interface between the scalable DOM API layer and the underlying data. It is a generic, stream-based pull API that accesses XML data. The `InfosetReader` retrieves sequential events from the XML stream and queries the state and data from these events. The following code scans the XML data and retrieves the QNames and attributes of all elements:

```
InfosetReader reader;
While (reader.hasNext())
{
    reader.next();
    if (reader.getEventType() == START_ELEMENT)
    {
        QName name = reader.getQName();
        TypedAttributeList attrList = reader.getAttributeList();
    }
}
```

4.3.4.1.1 InfosetReader Options

Options supported by the `InfosetReader` API are presented.

These are the supported operations:

- Copying (Optional, but `InfosetReader` from `BinXMLStream` always supports it)

To support shadow copying of DOM across documents, you can create a new copy of `InfosetReader` to ensure thread safety, using the `Clone` method. For more information, see [Using Shadow Copy](#) (page 4-26).

- Moving Focus (Optional)

To support lazy materialization, the `InfosetReader` may have the ability to move focus to any location specified by `offset`:

```
If (reader.hasSeekSupport())
    reader.seek(offset);
```

For more information, see [Using Lazy Materialization](#) (page 4-24)

4.3.4.1.2 InfosetWriter

`InfosetWriter` is an extension of the `InfosetReader` API that supports data writing. XDK implements `InfosetWriter` on top of binary XML. You cannot modify this implementation.

4.3.4.1.3 Saving XML Text as Binary XML

To create a scalable DOM from XML text, you must save the XML text as either binary XML or references to binary XML before you can run `DOMParser` on it. To save the XML text as binary XML, set the `doc.save` argument to `false`.

```
XMLDocument doc;
InfosetWriter writer;
```

```
doc.save(writer, false);
writer.close();
```

If you know that the data source is available for deserialization, then you can save the section reference of binary XML instead of the actual data by setting the `doc.save` argument to `true`.

See Also:

[Using Binary XML with Java](#) (page 5-1)

4.3.4.2 Using Lazy Materialization

Using lazy materialization, you can plug in an empty DOM, which can pull in data when needed and free (dereference) nodes when they are no longer needed. SDOM supports either manual or automatic node dereferencing.

Topics:

- [Pulling Data on Demand](#) (page 4-24)
- [Using Automatic Node Dereferencing](#) (page 4-25)
- [Using Manual Node Dereferencing](#) (page 4-25)
- [Using Shadow Copy](#) (page 4-26)
- [Incorporating DOM Updates](#) (page 4-26)
- [Using the PageManager Interface to Support Internal Data](#) (page 4-26)

4.3.4.2.1 Pulling Data on Demand

The plug-in DOM architecture creates an empty DOM, which contains a single `Document` node as the root of the tree. The rest of the DOM tree can be expanded later if it is accessed.

A node can have unexpanded child and sibling nodes, but its parent and ancestors are always expanded. Each node maintains the `InfoSetReader.Offset` property of the next node so that the DOM can pull additional data to create the next node.

Depending on access method type, DOM nodes can expand more than the set of nodes returned:

Access Method	Description
DOM Navigation	Allows access to neighboring nodes such as first child, last child, parent, previous sibling, or next sibling. If node creation is needed, it is done in document order.
Identifier (ID) Indexing	A DTD or XML schema can specify nodes with the type ID. If the DOM supports ID indexing, those nodes can be directly retrieved using the index. In scalable DOM, retrieval by index does not cause the expansion of all previous nodes, but their ancestor nodes are materialized.

Access Method	Description
XPath Expressions	XPath evaluation can cause materialization of all intermediate nodes in memory. For example, the descendent axis '/'/' expands the whole subtree, although some nodes might be released after evaluation.

4.3.4.2.2 Using Automatic Node Dereferencing

DOM navigation support requires additional links between nodes. In automatic dereferencing mode, weak links can be automatically dereferenced during garbage collection. To use automatic node dereferencing, set the `PARTIAL_DOM` attribute to `Boolean.TRUE`.

Node release depends on link importance. Links to parent nodes cannot be dropped, because ancestors provide context for in-scope namespaces and it is difficult to retrieve dropped parent nodes using streaming APIs such as `InfosetReader`.

In an SDOM tree, links to parent and previous sibling nodes are strong and links to child and following sibling nodes are weak. When the JVM frees the nodes, references to them are still available in the underlying data so they can be re-created if needed.

4.3.4.2.3 Using Manual Node Dereferencing

Manual node dereferencing is described.

In manual dereferencing mode, there are no weak references. The application must explicitly dereference document fragments from the DOM tree. If an application processes the data in a deterministic order, then Oracle recommends avoiding the extra overhead of repeatedly releasing and re-creating nodes.

To use manual node dereferencing, set the attribute `PARTIAL_DOM` to `Boolean.FALSE` and create the SDOM with plug-in XML data.

To manually dereference a node from all other nodes, invoke `freeNode()`. For example:

```
Element root = doc.getDocumentElement();
Node item = root.getFirstChild();
While (item != null)
{
    processItem(item);
    Node tmp = item;
    item = item.getNextSibling();
    ((XMLNode)tmp).freeNode();
}
```

Dereferencing a node does not remove it from the SDOM tree. The node can still be accessed and re-created from its parent, previous, and following siblings. However, after a node is dereferenced, a variable that holds the node throws an error when accessing the node.

Note:

The `freeNode` invocation has no effect on a non-scalable DOM.

4.3.4.2.4 Using Shadow Copy

Shadow copy avoids data replication by letting DOM nodes share their data.

Cloning, a common operation in XML processing, can be done lazily with SDOM. That is, the `copy` method creates only the root node of the fragment being copied, and the subtree is expanded only on demand.

DOM nodes themselves are not shared; their underlying data is shared. The DOM specification requires that the clone and its original have different node identities and different parent nodes.

4.3.4.2.5 Incorporating DOM Updates

The DOM API supports update operations such as adding and deleting nodes and setting, deleting, changing, and inserting values.

When a DOM is created by plugging in XML data, the underlying data is considered external to the DOM. DOM updates are visible from the DOM APIs but the data source remains the same. Normal update operations are available and do not interfere with each other.

To make a modified DOM persistent, you must explicitly save the DOM. Saving merges the changes with the original data and serializes the data in persistent storage. If you do not save a modified DOM explicitly, the changes are lost when the transaction ends.

4.3.4.2.6 Using the PageManager Interface to Support Internal Data

How to use the `PageManager` interface to let the SDOM use back-end storage for binary data.

When XML text is parsed with `DOMParser` and configured to create an SDOM, internal data is cached in the form of binary XML, and the DOM API layer is built on top of the internal data. This provides increased scalability, because the binary XML is more compact than DOM nodes.

For additional scalability, the SDOM can use back-end storage for binary data through the `PageManager` interface. Then, binary data can be swapped out of memory when not in use.

This code shows how to use the `PageManager` interface:

```
DOMParser parser = new DOMParser();
parser.setAttribute(PARTIAL_DOM, Boolean.TRUE); //enable SDOM
parser.setAttribute(PAGE_MANAGER, new FilePageManager("pageFile"));
...
// DOMParser other configuration
parser.parse(fileURL);
XMLDocument doc = parser.getDocument();
```

If you do not use the `PageManager` interface, then the parser caches the whole document as binary XML.

4.3.4.3 Using Configurable DOM Settings

When you create a DOM using class `XMLDOMImplementation`, you can configure the DOM for different applications and achieve maximum efficiency by using method `setAttribute`.

```
public void setAttribute(String name, Object value) throws
IllegalArgumentException
```

For SDOM, invoke `setAttribute` for the `PARTIAL_DOM` and `ACCESS_MODE` attributes.

Note:

New attribute values always affect the next DOM, not the current one. Therefore, you can use instances of `XMLDOMImplementation` to create DOMs with different configurations.

4.3.4.3.1 PARTIAL_DOM Attribute

Attribute `PARTIAL_DOM` determines whether the created DOM is partial, that is, scalable. When it has the value `TRUE`, the DOM is scalable (that is, nodes that are not in use are freed and re-created when needed). When it has the value `FALSE`, the created DOM is not scalable.

4.3.4.3.2 ACCESS_MODE Attribute

Attribute `ACCESS_MODE` (which applies to both SDOM and nonscalable DOM) controls access to the created DOM.

The attribute values, from least to most restrictive, are shown in [Table 4-8](#) (page 4-27).

Table 4-8 ACCESS_MODE Attribute Values

Value	DOM Access	Performance Advantage
UPDATEABLE	All update operations allowed. This is the default value, for backward compatibility with the XDK DOM implementation.	
READ_ONLY	No DOM update operations allowed. Node creation (for example, cloning) is allowed only if the new nodes are not added to the DOM tree.	Write buffer is not created.
FORWARD_READ	Forward navigation (for example, <code>getFirstChild().getNextSibling()</code> and <code>getLastChild()</code>) and access to parent and ancestor nodes is allowed; backward navigation (for example, <code>getPreviousSibling()</code>) is not allowed.	Previous-sibling links are not created.

Table 4-8 (Cont.) ACCESS_MODE Attribute Values

Value	DOM Access	Performance Advantage
STREAM_READ	<p>Limited to the stream of nodes in document order, similar to SAX event access.</p> <p>The current node is the last node that was accessed in document order. Applications can hold nodes in variables and revisit them, but using the DOM method to access any node before the current node (except a parent or ancestor) causes an error. For example:</p> <ul style="list-style-type: none"> This is allowed, although the parent is before the current node: <pre>Node parent = currentNode.getParentNode();</pre> This causes an error unless the current node is the first child of the parent: <pre>Node child = parent.getFirstChild();</pre> Accessing element attributes is always allowed: <pre>Attribute attr = parent.getFirstAttribute();</pre> 	<p>DOM maintains only parent links, not node locations; therefore, it need not re-create freed nodes.</p>

4.3.4.4 Using Fast Infoset with SDOM

The Fast Infoset to XDK/J model lets you use Fast Infoset techniques while working with XML content in Java.

Note:

Use Fast Infoset only for input. For output, use CSX or XTI.

This example uses a serializer to encode XML data into a FastInfoset BinaryStream:

```
public com.sun.xml.fastinfoset.sax.SAXDocumentSerializer getSAXDocumentSerializer();
public com.sun.xml.fastinfoset.stax.StAXDocumentSerializer getStAXDocumentSerializer();
```

The class `oracle.xml.scalable.BinaryStream` is the data management component that provides buffer management and an abstract paged I/O view to support decoding for different types of data storage.

The `InfosetReader` from `BinaryStream` is the implementation of `oracle.xml.scalable.InfosetReader` for the DOM to read data from binary. The implementation extends the basic decoder `sun.com.xml.fasterinfoset.Decoder` and adds support for seek and skip operations.

You can use Fast Infoset with Streaming API for XML (StAX) and SAX to create a DOM. To create an SDOM, you can use the routines from the preceding example and those in this example:

```
String xmlFile, fiFile;
FileInputStream xin = new FileInputStream(new File(xmlFile));
XML_SAX_FI figen = new XML_SAX_FI();
FileOutputStream outf = new FileOutputStream(new File(fiFile));
```

```

figen.parse(xin, outfi);
outfi.close();

import oracle.xml.scalable.BinaryStream;

BinaryStream stream = BinaryStream.newInstance(SUN_FI);
stream.setFile(new File(fiFile));
InfosetReader reader = stream.getInfoSetReader();
XMLDOMImplementation dimp = new XMLDOMImplementation();
dimp.setAttribute(XMLDocument.SCALABLE_DOM, Boolean.TRUE);
XMLDocument doc = (XMLDocument) dimp.createDocument(reader);

```

4.3.4.5 SDOM Applications

Applications that create and use an SDOM are presented.

This application creates and uses an SDOM:

```

XMLDOMImplementation domimpl = new XMLDOMImplementation();
domimpl.setAttribute(XMLDocument.SCALABLE_DOM, Boolean.TRUE);
domimpl.setAttribute(XMLDocument.ACCESS_MODE, XMLDocument.UPDATEABLE);
XMLDocument scalableDoc = (XMLDocument) domimpl.createDocument(reader);

```

The following application creates and uses an SDOM based on binary XML, which is described in [Using Binary XML with Java](#) (page 5-1):

```

BinXMLProcessor proc = BinXMLProcessorFactory.createProcessor();
BinXMLStream bstr = proc.createBinXMLStream();
BinXMLEncoder enc = bstr.getEncoder();
enc.setProperty(BinXMLEncoder.ENC_SCHEMA_AWARE, false);

SAXParser parser = new SAXParser();
parser.setContentHandler(enc.getContentHandler());
parser.setErrorHandler(enc.getErrorHandler());
parser.parse(BinXMLUtil.createURL(xmlfile));

BinXMLDecoder dec = bstr.getDecoder();
InfosetReader reader = dec.getReader();
XMLDOMImplementation domimpl = new XMLDOMImplementation();
domimpl.setAttribute(XMLDocument.SCALABLE_DOM, Boolean.TRUE);
XMLDocument currentDoc = (XMLDocument) domimpl.createDocument(reader);

```

4.3.4.6 XDK Java DOM Improvements

XDK supports the DOM Level 3 Core specification, a recommendation of the W3C.

See Also:

<http://www.w3.org/TR/DOM-Level-3-Core/> for more information about DOM Level 3

4.3.5 Performing DOM Operations with Namespaces

DOM2Namespace.java shows a simple use of the parser and namespace extensions to the DOM APIs. The program receives an XML document, parses it, and prints the elements and attributes in the document.

This section includes some code from the DOM2Namespace.java program. For more detail, see the program itself.

The first four steps of [Performing Basic DOM Parsing](#) (page 4-18), from parser creation to the `getDocument()` invocation, are basically the same for `DOM2Namespace.java`. The principal difference is in printing the DOM tree (Step 5 (page 4-19)). The `DOM2Namespace.java` program does this instead:

```
// Print document elements
printElements(doc);

// Print document element attributes
System.out.println("The attributes of each element are: ");
printElementAttributes(doc);
```

The `printElements()` method implemented by `DOM2Namespace.java` invokes `getElementsByTagName()` to get a list of all the elements in the DOM tree. It then loops through each item in the list and casts each `Element` to an `nsElement`. For each `nsElement` it invokes `nsElement.getPrefix()` to get the namespace prefix, `nsElement.getLocalName()` to get the local name, and `nsElement.getNamespaceURI()` to get the namespace URI:

```
static void printElements(Document doc)
{
    NodeList nl = doc.getElementsByTagName("*");
    Element nsElement;
    String prefix;
    String localName;
    String nsName;

    System.out.println("The elements are: ");
    for (int i=0; i < nl.getLength(); i++)
    {
        nsElement = (Element)nl.item(i);

        prefix = nsElement.getPrefix();
        System.out.println(" ELEMENT Prefix Name : " + prefix);

        localName = nsElement.getLocalName();
        System.out.println(" ELEMENT Local Name      : " + localName);

        nsName = nsElement.getNamespaceURI();
        System.out.println(" ELEMENT Namespace      : " + nsName);
    }
    System.out.println();
}
```

The `printElementAttributes()` method invokes `Document.getElementsByTagName()` to get a `NodeList` of the elements in the DOM tree. It then loops through each element and invokes `Element.getAttributes()` to get the list of attributes for the element as special list called a `NamedNodeMap`. For each item in the attribute list it invokes `nsAttr.getPrefix()` to get the namespace prefix, `nsAttr.getLocalName()` to get the local name, and `nsAttr.getValue()` to get the value:

```
static void printElementAttributes(Document doc)
{
    NodeList nl = doc.getElementsByTagName("*");
    Element e;
    Attr nsAttr;
    String attrpfx;
    String attrname;
    String attrval;
```

```

NamedNodeMap nnm;
int i, len;

len = nl.getLength();

for (int j=0; j < len; j++)
{
    e = (Element) nl.item(j);
    System.out.println(e.getTagName() + ":");

    nnm = e.getAttributes();

    if (nnm != null)
    {
        for (i=0; i < nnm.getLength(); i++)
        {
            nsAttr = (Attr) nnm.item(i);

            attrpfx = nsAttr.getPrefix();
            attrname = nsAttr.getLocalName();
            attrval = nsAttr.getNodeValue();

            System.out.println(" " + attrpfx + ":" + attrname + " = "
                               + attrval);
        }
    }
    System.out.println();
}
}

```

4.3.6 Performing DOM Operations with Events

`EventSample.java` shows how to register events with an event listener. For example, adding a node to a specified DOM element triggers an event, which causes the listener to print information about the event.

This section includes some code from the `EventSample.java` program. For more detail, see the program itself.

The `EventSample.java` program follows these steps:

1. Instantiate an event listener.

When a registered change triggers an event, the event is passed to the event listener, which handles it. This code fragment from `EventSample.java` shows the implementation of the listener:

```

eventlistener evtlist = new eventlistener();
...
class eventlistener implements EventListener
{
    public eventlistener(){}
    public void handleEvent(Event e)
    {
        String s = " Event "+e.getType()+" received " + "\n";
        s += " Event is cancelable :"+e.getCancelable()+"\n";
        s += " Event is bubbling event :"+e.getBubbles()+"\n";
        s += " The Target is " + ((Node)(e.getTarget())).getNodeName() + "\n\n";
        System.out.println(s);
    }
}

```

2. Instantiate a new `XMLDocument` and then invoke `getImplementation()` to retrieve a `DOMImplementation` object.

Invoke the `hasFeature()` method to determine which features this implementation supports, as this code fragment from `EventSample.java` does:

```
XMLDocument doc1 = new XMLDocument();
DOMImplementation impl = doc1.getImplementation();

System.out.println("The impl supports Events "+
    impl.hasFeature("Events", "2.0"));
System.out.println("The impl supports Mutation Events "+
    impl.hasFeature("MutationEvents", "2.0"));
```

3. Register desired events with the listener. This code fragment from `EventSample.java` registers three events on the document node:

```
doc1.addEventListener("DOMNodeRemoved", evtlist, false);
doc1.addEventListener("DOMNodeInserted", evtlist, false);
doc1.addEventListener("DOMCharacterDataModified", evtlist, false);
```

This code fragment from `EventSample.java` creates a node of type `XMLElement` and then registers three events on the node:

```
XMLElement el = (XMLElement)doc1.createElement("element");
...
el.addEventListener("DOMNodeRemoved", evtlist, false);
el.addEventListener("DOMNodeRemovedFromDocument", evtlist, false);
el.addEventListener("DOMCharacterDataModified", evtlist, false);
...
```

4. Perform actions that trigger events, which are then passed to the listener for handling, as this code fragment from `EventSample.java` does:

```
att.setNodeValue("abc");
el.appendChild(e1);
el.appendChild(text);
text.setNodeValue("xyz");
doc1.removeChild(el);
```

4.3.7 Performing DOM Operations with Ranges

According to the W3C DOM specification, a **range** identifies a range of content in a `Document`, `DocumentFragment`, or `Attr`. The range selects the content between a pair of boundary points that correspond to the start and end of the range.

[Table 4-9](#) (page 4-32) describes range methods accessible through `XMLDocument`.

Table 4-9 Range Class Methods

Method	Description
<code>cloneContents()</code>	Duplicates the contents of a range
<code>deleteContents()</code>	Deletes the contents of a range
<code>getCollapsed()</code>	Returns <code>TRUE</code> if the range is collapsed
<code>getEndContainer()</code>	Gets the node within which the range ends

Table 4-9 (Cont.) Range Class Methods

Method	Description
<code>getStartContainer()</code>	Gets the node within which the range starts
<code>selectNode()</code>	Selects a node and its contents
<code>selectNodeContents()</code>	Selects the contents of a node
<code>setEnd()</code>	Sets the attributes describing the end of a range
<code>setStart()</code>	Sets the attributes describing the start of a range

The `DOMRangeSample.java` program shows some operations that you can perform with ranges. This section includes some code from the `DOMRangeSample.java` program. For more detail, see the program itself.

The first four steps of the [Performing Basic DOM Parsing](#) (page 4-18), from parser creation to the `getDocument()` invocation, are the same for `DOMRangeSample.java`. Then, the `DOMRangeSample.java` program follows these steps:

1. After invoking `getDocument()` to create the `XMLDocument`, create a range object with `createRange()` and invoke `setStart()` and `setEnd()` to set its boundaries, as this code fragment from `DOMRangeSample.java` does:

```
XMLDocument doc = parser.getDocument();
...
Range r = (Range) doc.createRange();
XMLNode c = (XMLNode) doc.getDocumentElement();

// set the boundaries
r.setStart(c,0);
r.setEnd(c,1);
```

2. Invoke `XMLDocument` methods to get information about the range and manipulate its contents.

This code fragment from `DOMRangeSample.java` selects and prints the contents of the current node:

```
r.selectNodeContents(c);
System.out.println(r.toString());
```

This code fragment clones and prints the contents of a range:

```
XMLDocumentFragment df =(XMLDocumentFragment) r.cloneContents();
df.print(System.out);
```

This code fragment gets and prints the start and end containers for the range:

```
c = (XMLNode) r.getStartContainer();
System.out.println(c.getText());
c = (XMLNode) r.getEndContainer();
System.out.println(c.getText());
```

4.3.8 Performing DOM Operations with TreeWalker

XDK implements the `NodeFilter` and `TreeWalker` interfaces, which are defined by the W3C DOM Level 2 Traversal and Range specification.

A node filter is an object that can filter out certain types of `Node` objects. For example, it can filter out entity reference nodes but accept element and attribute nodes. You create a node filter by implementing the `NodeFilter` interface and then passing a `Node` object to the `acceptNode()` method. Typically, the `acceptNode()` method implementation invokes `getNodeType()` to get the type of the node and compares it to static variables such as `ELEMENT_TYPE`, `ATTRIBUTE_TYPE`, and so forth, and then returns one of the static fields listed in [Table 4-10](#) (page 4-34), based on what it finds.

Table 4-10 Static Fields in the NodeFilter Interface

Field	Description
<code>FILTER_ACCEPT</code>	Accepts the node. Navigation methods defined for <code>NodeIterator</code> or <code>TreeWalker</code> return this node.
<code>FILTER_REJECT</code>	Rejects the node. Navigation methods defined for <code>NodeIterator</code> or <code>TreeWalker</code> do not return this node. For <code>TreeWalker</code> , the children of this node are also rejected. <code>NodeIterator</code> treats <code>FILTER_REJECT</code> as a synonym for <code>FILTER_SKIP</code> .
<code>FILTER_SKIP</code>	Skips this single node. Navigation methods defined for <code>NodeIterator</code> or <code>TreeWalker</code> do not return this node. For both <code>NodeIterator</code> and <code>TreeWalker</code> , children of this node are considered.

You can use a `TreeWalker` object to traverse a document tree or subtree, using the view of the document defined by the `whatToShow` flag and filters of the `TreeWalker` object.

To create a `TreeWalker` object, use the `XMLDocument.createTreeWalker()` method, specifying:

- A root node for the tree or subtree
- A flag that governs the type of nodes to include in the logical view
- A node filter (optional)
- A flag that determines whether to include entity references and their descendents

[Table 4-11](#) (page 4-34) describes methods in the `org.w3c.dom.traversal.TreeWalker` interface.

Table 4-11 TreeWalker Interface Methods

Method	Description
<code>firstChild()</code>	Moves the tree walker to the first visible child of the current node and returns the new node. If the current node has no visible children, then the method returns <code>null</code> and retains the current node.
<code>getRoot()</code>	Gets the root node of the tree walker (specified when the <code>TreeWalker</code> object was created).

Table 4-11 (Cont.) TreeWalker Interface Methods

Method	Description
<code>lastChild()</code>	Moves the tree walker to the last visible child of the current node and returns the new node. If the current node has no visible children, then the method returns <code>null</code> and retains the current node.
<code>nextNode()</code>	Moves the tree walker to the next visible node in document order relative to the current node and returns the new node.

The `TreeWalkerSample.java` program shows some operations that you can perform with node filters and tree walkers. This section includes some code from the `TreeWalkerSample.java` program. For more detail, see the program itself.

The first four steps of the [Performing Basic DOM Parsing](#) (page 4-18), from parser creation to the `getDocument()` invocation, are the same for `TreeWalkerSample.java`. The, the `TreeWalkerSample.java` program follows these steps:

1. Create a node filter object.

The `acceptNode()` method in the `nf` class, which implements the `NodeFilter` interface, invokes `getNodeTypes()` to get the type of node, as this code fragment from `TreeWalkerSample.java` does:

```
NodeFilter n2 = new nf();
...
class nf implements NodeFilter
{
    public short acceptNode(Node node)
    {
        short type = node.getNodeType();

        if ((type == Node.ELEMENT_NODE) || (type == Node.ATTRIBUTE_NODE))
            return FILTER_ACCEPT;
        if ((type == Node.ENTITY_REFERENCE_NODE))
            return FILTER_REJECT;
        return FILTER_SKIP;
    }
}
```

2. Invoke the `XMLDocument.createTreeWalker()` method to create a tree walker.

This code fragment from `TreeWalkerSample.java` uses the root node of the `XMLDocument` as the root node of the tree walker and includes all nodes in the tree:

```
XMLDocument doc = parser.getDocument();
...
TreeWalker tw =
doc.createTreeWalker(doc.getDocumentElement(), NodeFilter.SHOW_ALL, n2, true);
```

3. Get the root element of the `TreeWalker` object, as this code fragment from `TreeWalkerSample.java` does:

```
XMLNode nn = (XMLNode)tw.getRoot();
```

4. Traverse the tree.

This code fragment from `TreeWalkerSample.java` walks the tree in document order by invoking the `TreeWalker.nextNode()` method:

```
while (nn != null)
{
    System.out.println(nn.getNodeName() + " " + nn.getNodeValue());
    nn = (XMLNode)tw.nextNode();
}
```

This code fragment from `TreeWalkerSample.java` walks the left depth of the tree by invoking the `firstChild()` method:

```
while (nn != null)
{
    System.out.println(nn.getNodeName() + " " + nn.getNodeValue());
    nn = (XMLNode)tw.firstChild();
}
```

You can walk the right depth of the tree by invoking the `lastChild()` method.

4.4 Parsing XML with SAX

Simple API for XML (SAX) is a standard interface for event-based XML parsing.

Topics:

- [Using the SAX API for Java](#) (page 4-36)
- [Performing Basic SAX Parsing](#) (page 4-39)
- [Performing Basic SAX Parsing with Namespaces](#) (page 4-41)
- [Performing SAX Parsing with XMLTokenizer](#) (page 4-42)

4.4.1 Using the SAX API for Java

The interfaces and classes of the SAX API, which is released in a Level 1 and Level 2 version, are described.

These are the interfaces and classes:

- Interfaces implemented by the Oracle XML parser
- Interfaces that your application must implement (see [Table 4-12](#) (page 4-37))
- Standard SAX classes
- SAX 2.0 helper classes in the `org.xml.sax.helper` package (see [Table 4-13](#) (page 4-37))
- Demonstration classes in the `nul` package

[Table 4-12](#) (page 4-37) lists and describes the SAX 2.0 interfaces that your application must implement.

Table 4-12 SAX 2.0 Handler Interfaces

Interface	Description
ContentHandler	Receives notifications from the XML parser. Implements the major event-handling methods <code>startDocument()</code> , <code>endDocument()</code> , <code>startElement()</code> , and <code>endElement()</code> , which are invoked when the XML parser identifies an XML tag. Implements the methods <code>characters()</code> and <code>processingInstruction()</code> , which are invoked when the XML parser encounters the text in an XML element or an inline processing instruction.
DeclHandler	Receives notifications about DTD declarations in the XML document.
DTDHandler	Processes notations and unparsed (binary) entities.
EntityResolver	Supports redirection of URIs in documents. Implements the method <code>resolveEntity()</code> , which is invoked when the XML parser must identify data identified by a URI.
ErrorHandler	Handles parser errors. Implements the methods <code>error()</code> , <code>fatalError()</code> , and <code>warning()</code> , which the program invokes in response to various parsing errors.
LexicalHandler	Receives notifications about lexical information, such as comments and character data (CDATA) section boundaries.

[Table 4-13](#) (page 4-37) lists and describes the SAX 2.0 helper classes.

Table 4-13 SAX 2.0 Helper Classes

Class	Description
AttributeImpl	Makes a persistent copy of an <code>AttributeList</code> .
DefaultHandler	Base class with default implementations of the interfaces in Table 4-12 (page 4-37).
LocatorImpl	Makes a persistent snapshot of the values of a <code>Locator</code> at a specified point in the parse.
NamespaceSupport	Supports XML namespaces.
XMLFilterImpl	Base class used by applications that modify the stream of events.
XMLReaderFactory	Supports loading SAX parsers dynamically.

[Figure 4-5](#) (page 4-38) shows how to create a SAX parser and use it to parse an input document.

Figure 4-5 Using the SAXParser Class

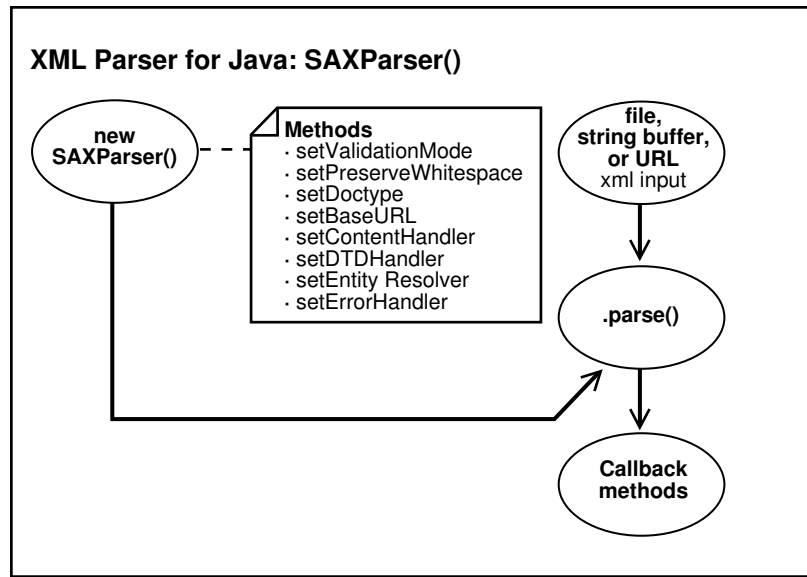

The basic steps for parsing an input XML document with SAX are:

1. Create a `SAXParser` object and configure its properties.
For example, set the validation mode. For configuration methods, see [Table 4-5](#) (page 4-21).
2. Instantiate an event handler.
Your application must implement the handler interfaces in [Table 4-12](#) (page 4-37).
3. Register your event handlers with the XML parser.
This step enables the parser to invoke the correct methods when a given event occurs. For information about `SAXParser` methods for registering event handlers, see [Table 4-14](#) (page 4-39).
4. Parse the input document with the `SAXParser.parse()` method.

All SAX interfaces are assumed to be synchronous: the parse method must not return until parsing is complete. Readers must wait for an event-handler callback to return before reporting the next event.

When the `SAXParser.parse()` method is invoked, the program invokes one of several callback methods implemented in the application. The methods are defined by the `ContentHandler`, `ErrorHandler`, `DTDHandler`, and `EntityResolver` interfaces implemented in the event handler. For example, the application can invoke the `startElement()` method when a start element is encountered.

[Table 4-14](#) (page 4-39) lists and describes the `SAXParser` methods for registering event handlers and explains when to use them. An application can register a new or different handler in the middle of a parse; the SAX parser must begin using the newly registered handler immediately.

Table 4-14 SAXParser Methods for Registering Event Handlers

Method	Description
<code>setContentHandler()</code>	Registers a content event handler with an application. The <code>org.xml.sax.DefaultHandler</code> class implements the <code>org.xml.sax.ContentHandler</code> interface.
<code>setDTDHandler()</code>	Registers a DTD event handler with an application. If the application does not register a DTD handler, DTD events reported by the SAX parser are silently ignored.
<code>setErrorHandler()</code>	Registers an error event handler with an application. If the application does not register an error handler, all error events reported by the SAX parser are silently ignored; however, normal processing may not continue. Oracle highly recommends that all SAX applications implement an error handler to avoid unexpected bugs.
<code>setEntityResolver()</code>	Registers an entity resolver with an application. If the application does not register an entity resolver, the <code>XMLReader</code> performs its own default resolution.

4.4.2 Performing Basic SAX Parsing

`SAXSample.java` shows the basic steps of SAX parsing. The `SAXSample` class extends `HandlerBase`. The program receives an XML file as input, parses it, and prints information about the contents of the file.

The `SAXSample.java` program follows these steps (which are illustrated with code fragments from the program):

1. Store the `Locator`:

```
Locator locator;
```

The `Locator` associates a SAX event with a document location. The SAX parser provides location information to the application by passing a `Locator` instance to the `setDocumentLocator()` method in the content handler. The application can use the object to get the location of any other content handler event in the XML source document.

2. Instantiate a new event handler.:

```
SAXSample sample = new SAXSample();
```

3. Instantiate the SAX parser and configure it:

```
Parser parser = new SAXParser();
((SAXParser)parser).setValidationMode(SAXParser.DTD_VALIDATION);
```

The preceding code sets the mode to DTD validation.

4. Register event handlers with the SAX parser:

```
parser.setDocumentHandler(sample);
parser.setEntityResolver(sample);
parser.setDTDHandler(sample);
parser.setErrorHandler(sample);
```

You can use the registration methods in the `SAXParser` class, but you must implement the event handler interfaces yourself.

Here is part of the `DocumentHandler` interface implementation:

```
public void setDocumentLocator (Locator locator)
{
    System.out.println("SetDocumentLocator:");
    this.locator = locator;
}
public void startDocument()
{
    System.out.println("StartDocument");
}
public void endDocument() throws SAXException
{
    System.out.println("EndDocument");
}
public void startElement(String name, AttributeList atts)
                                throws SAXException
{
    System.out.println("StartElement:"+name);
    for (int i=0;i<atts.getLength();i++)
    {
        String aname = atts.getName(i);
        String type = atts.getType(i);
        String value = atts.getValue(i);
        System.out.println("    "+aname+"("+type+")"+"="+value);
    }
}
...

```

The following code implements the `EntityResolver` interface:

```
public InputSource resolveEntity (String publicId, String systemId)
                                throws SAXException
{
    System.out.println("ResolveEntity:"+publicId+" "+systemId);
    System.out.println("Locator:"+locator.getPublicId()+" locator.getSystemId()+
        "+locator.getLineNumber()+" "+locator.getColumnNumber());
    return null;
}

```

The following code implements the `DTDHandler` interface:

```
public void notationDecl (String name, String publicId, String systemId)
{
    System.out.println("NotationDecl:"+name+" "+publicId+" "+systemId);
}
public void unparsedEntityDecl (String name, String publicId,
                                String systemId, String notationName)
{
    System.out.println("UnparsedEntityDecl:"+name + " "+publicId+" "+
        systemId+" "+notationName);
}

```

The following code implements the `ErrorHandler` interface:

```
public void warning (SAXParseException e)
                    throws SAXException
{
    System.out.println("Warning:"+e.getMessage());
}

```



```

    }
    public void error (SAXParseException e)
        throws SAXException
    {
        throw new SAXException(e.getMessage());
    }
    public void fatalError (SAXParseException e)
        throws SAXException
    {
        System.out.println("Fatal error");
        throw new SAXException(e.getMessage());
    }
}

```

5. Parse the input XML document:

```
parser.parse(DemoUtil.createURL(argv[0]).toString());
```

The preceding code converts the document to a URL and then parses it.

4.4.3 Performing Basic SAX Parsing with Namespaces

`SAX2Namespace.java` implements an event handler named `XMLDefaultHandler` as a subclass of the `org.xml.sax.helpers.DefaultHandler` class.

The easiest way to implement the `ContentHandler` interface is to extend the `org.xml.sax.helpers.DefaultHandler` class. The `DefaultHandler` class provides some default behavior for handling events, although the typical behavior is to do nothing.

`SAX2Namespace.java` overrides methods only for relevant events. Specifically, the `XMLDefaultHandler` class implements only two methods: `startElement()` and `endElement()`. Whenever `SAXParser` encounters a new element in the XML document, it triggers the `startElement` event, and the `startElement()` method prints the namespace information for the element.

The `SAX2Namespace.java` sample program follows these steps (which are illustrated with code fragments from the program):

1. Instantiate a new event handler of type `DefaultHandler`:

```
DefaultHandler defHandler = new XMLDefaultHandler();
```

2. Create a SAX parser and set its validation mode:

```
Parser parser = new SAXParser();
((SAXParser)parser).setValidationMode(SAXParser.DTD_VALIDATION);
```

The preceding code sets the mode to DTD validation.

3. Register event handlers with the SAX parser:

```
parser.setContentHandler(defHandler);
parser.setEntityResolver(defHandler);
parser.setDTDHandler(defHandler);
parser.setErrorHandler(defHandler);
```

The preceding code registers handlers for the input document, the DTD, entities, and errors.

The following code shows the `XMLDefaultHandler` implementation. The `startElement()` and `endElement()` methods print the qualified name, local

name, and namespace URI for each element (for an explanation of these terms, see [Table 4-7](#) (page 4-21)).

```
class XMLDefaultHandler extends DefaultHandler
{
    public void XMLDefaultHandler(){}
    public void startElement(String uri, String localName,
                             String qName, Attributes atts)
        throws SAXException
    {
        System.out.println("ELEMENT Qualified Name:" + qName);
        System.out.println("ELEMENT Local Name      :" + localName);
        System.out.println("ELEMENT Namespace       :" + uri);

        for (int i=0; i<atts.getLength(); i++)
        {
            qName = atts.getQName(i);
            localName = atts.getLocalName(i);
            uri = atts.getURI(i);

            System.out.println(" ATTRIBUTE Qualified Name    :" + qName);
            System.out.println(" ATTRIBUTE Local Name       :" + localName);
            System.out.println(" ATTRIBUTE Namespace        :" + uri);

            // You can get the type and value of the attributes either
            // by index or by the Qualified Name.

            String type = atts.getType(qName);
            String value = atts.getValue(qName);

            System.out.println(" ATTRIBUTE Type                :" + type);
            System.out.println(" ATTRIBUTE Value                :" + value);

            System.out.println();
        }
    }
    public void endElement(String uri, String localName,
                           String qName) throws SAXException
    {
        System.out.println("ELEMENT Qualified Name:" + qName);
        System.out.println("ELEMENT Local Name      :" + localName);
        System.out.println("ELEMENT Namespace       :" + uri);
    }
}
```

4. Parse the input XML document:

```
parser.parse(DemoUtil.createURL(argv[0]).toString());
```

The preceding code converts the document to a URL and then parses it.

4.4.4 Performing SAX Parsing with XMLTokenizer

You can create a simple SAX parser as a instance of the XMLTokenizer class and use the parser to tokenize the input XML.

[Table 4-15](#) (page 4-43) lists useful methods in the class.

Table 4-15 XMLTokenizer Methods

Method	Description
<code>setToken()</code>	Registers a new token for XML tokenizer.
<code>setErrorStream()</code>	Registers a output stream for errors
<code>tokenize()</code>	Tokenizes the input XML

SAX parsers with `Tokenizer` features must implement the `XMLToken` interface. The callback method for `XMLToken` is `token()`, which receives an XML token and its corresponding value and performs an action. For example, you can implement `token()` so that it prints the token name followed by the value of the token.

The `Tokenizer.java` sample program accepts an XML document as input, parses it, and prints a list of the XML tokens. The program implements a `doParse()` method that follows these steps (which are illustrated with code fragments from the program):

1. Create a URL from the input XML stream:

```
URL url = DemoUtil.createURL(arg);
```

2. Create an `XMLTokenizer` parser:

```
parser = new XMLTokenizer ((XMLToken)new Tokenizer());
```

3. Register an output error stream:

```
parser.setErrorStream (System.out);
```

4. Register tokens with the parser:

```
parser.setToken (STagName, true);
parser.setToken (EmptyElemTag, true);
parser.setToken (STag, true);
parser.setToken (ETag, true);
parser.setToken (ETagName, true);
...
```

5. Tokenize the XML document:

```
parser.tokenize (url);
```

The `token()` callback method determines the action to take upon encountering a particular token. The following code is part of the implementation of this method:

```
public void token (int token, String value)
{
    switch (token)
    {
        case XMLToken.STag:
            System.out.println ("STag: " + value);
            break;
        case XMLToken.ETag:
            System.out.println ("ETag: " + value);
            break;
        case XMLToken.EmptyElemTag:
            System.out.println ("EmptyElemTag: " + value);
            break;
    }
}
```

```

        case XMLToken.AttValue:
            System.out.println ("AttValue: " + value);
            break;
        ...
        default:
            break;
    }
}

```

4.5 Parsing XML with JAXP

JAXP lets your Java program use the SAX and DOM parsers and the XSLT processor.

Topics:

- [JAXP Structure](#) (page 4-44)
- [Using the SAX API Through JAXP](#) (page 4-44)
- [Using the DOM API Through JAXP](#) (page 4-45)
- [Transforming XML Through JAXP](#) (page 4-46)
- [Parsing with JAXP](#) (page 4-46)
- [Performing Basic Transformations with JAXP](#) (page 4-48)

4.5.1 JAXP Structure

JAXP consists of abstract classes that provide a thin layer for parser pluggability. Oracle implemented JAXP based on the Sun reference implementation.

[Table 4-16](#) (page 4-44) lists and describes the packages that comprise JAXP.

Table 4-16 JAXP Packages

Package	Description
<code>javax.xml.parsers</code>	Provides standard APIs for DOM 2.0 and SAX 1.0 parsers. Contains vendor-neutral factory classes, including <code>SAXParser</code> and a <code>DocumentBuilder</code> . <code>DocumentBuilder</code> creates a DOM-compliant <code>Document</code> object.
<code>javax.xml.transform</code>	Defines the generic APIs for processing XML transformation and performing a transformation from a source to a result.
<code>javax.xml.transform.dom</code>	Provides DOM-specific transformation APIs.
<code>javax.xml.transform.sax</code>	Provides SAX2-specific transformation APIs.
<code>javax.xml.transform.stream</code>	Provides stream- and URI-specific transformation APIs.

4.5.2 Using the SAX API Through JAXP

You can rely on the factory design pattern to create new SAX parser engines with JAXP.

[Figure 4-6](#) (page 4-45) shows the basic process.

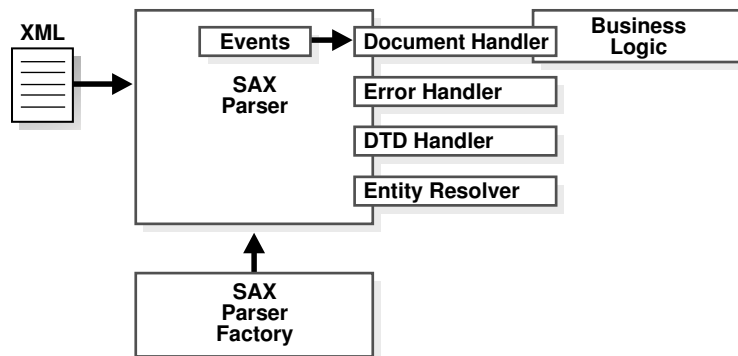
Figure 4-6 SAX Parsing with JAXP

The basic steps for parsing with SAX through JAXP are:

1. Create a new SAX parser factory with the `SAXParserFactory` class.
2. Configure the factory.
3. Create a new SAX parser (`SAXParser`) object from the factory.
4. Set the event handlers for the SAX parser.
5. Parse the input XML documents.

4.5.3 Using the DOM API Through JAXP

You can rely on the factory design pattern to create new DOM document builder engines with JAXP.

Figure 4-7 (page 4-45) shows the basic process.

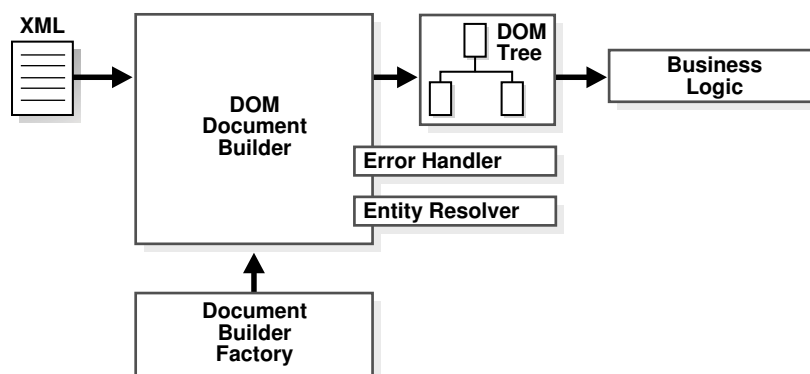
Figure 4-7 DOM Parsing with JAXP

The basic steps for parsing with DOM through JAXP are:

1. Create a new DOM parser factory with the `DocumentBuilderFactory` class.
2. Configure the factory.
3. Create a new DOM builder (`DocumentBuilder`) object from the factory.
4. Set the error handler and entity resolver for the DOM builder.
5. Parse the input XML documents.

4.5.4 Transforming XML Through JAXP

The basic steps for transforming XML through JAXP are described.

The steps are:

1. Create a new transformer factory with the `TransformerFactory` class.
2. Configure the factory.
3. Create a new transformer from the factory and specify an XSLT stylesheet.
4. Configure the transformer.
5. Transform the document.

4.5.5 Parsing with JAXP

The `JAXPEXamples.java` program shows the basic steps of parsing with JAXP.

The program implements these methods and uses them to parse and perform additional processing on XML files in the `/jaxp` directory:

- `basic()`
- `identity()`
- `namespaceURI()`
- `templatesHandler()`
- `contentHandler2contentHandler()`
- `contentHandler2DOM()`
- `reader()`
- `xmlFilter()`
- `xmlFilterChain()`

The program creates URLs for the sample XML files `jaxpone.xml` and `jaxpone.xsl` and then invokes the preceding methods in sequence. The basic design of the demo is as follows (to save space, only the `basic()` method is shown):

```
public class JAXPEXamples
{
    public static void main(String argv[])
        throws TransformerException, TransformerConfigurationException,
            IOException, SAXException,
ParserConfigurationException,
            FileNotFoundException
    {
        try {
            URL xmlURL = createURL("jaxpone.xml");
            String xmlID = xmlURL.toString();
            URL xslURL = createURL("jaxpone.xsl");
            String xslID = xslURL.toString();
            //
            System.out.println("--- basic ---");
            basic(xmlID, xslID);
            System.out.println();
        }
    }
}
```

```

        ...
    } catch(Exception err) {
        err.printStackTrace();
    }
}
//
public static void basic(String xmlID, String xslID)
    throws TransformerException, TransformerConfigurationException
{
    TransformerFactory tfactory = TransformerFactory.newInstance();
    Transformer transformer = tfactory.newTransformer(new StreamSource(xslID));
    StreamSource source = new StreamSource(xmlID);
    transformer.transform(source, new StreamResult(System.out));
}
...
}

```

The `reader()` method in the program `JAXPEXamples.java` shows a simple technique for parsing an XML document with SAX, using these steps (which are illustrated with code fragments from the program):

1. Create a new instance of a `TransformerFactory` and cast it to a `SAXTransformerFactory`:

```

TransformerFactory tfactory = TransformerFactory.newInstance();
SAXTransformerFactory stfactory = (SAXTransformerFactory)tfactory;

```

2. Create an XML reader by creating a `StreamSource` object from a stylesheet and passing it to the factory method `newXMLFilter()`:

```

URL xslURL = createURL("jaxpone.xsl");
String xslID = xslURL.toString();
...
StreamSource streamSource = new StreamSource(xslID);
XMLReader reader = stfactory.newXMLFilter(streamSource);

```

`newXMLFilter()` returns an `XMLFilter` object that uses the specified `Source` as the transformation instructions.

3. Create a content handler and register it with the XML reader:

```

ContentHandler contentHandler = new oraContentHandler();
reader.setContentHandler(contentHandler);

```

The preceding code creates an instance of the class `oraContentHandler` by compiling the `oraContentHandler.java` program in the demo directory.

The following code shows part of the implementation of the `oraContentHandler` class:

```

public class oraContentHandler implements ContentHandler
{
    private static final String TRADE_MARK = "Oracle 9i ";

    public void setDocumentLocator(Locator locator)
    {
        System.out.println(TRADE_MARK + "- setDocumentLocator");
    }

    public void startDocument()
        throws SAXException
    {

```

```
        System.out.println(TRADE_MARK + "- startDocument");
    }

    public void endDocument()
        throws SAXException
    {
        System.out.println(TRADE_MARK + "- endDocument");
    }
    ...
```

4. Parse the input XML document by passing the `InputStream` to the `XMLReader.parse()` method:

```
InputStream is = new InputStream(xmlID);
reader.parse(is);
```

4.5.6 Performing Basic Transformations with JAXP

You can use JAXP to perform basic transformations.

JAXP can transform these types of input:

- XML documents
- XSL stylesheets
- `ContentHandler` class defined in `oraContentHandler.java`

Here are some examples of using JAXP to perform basic transformations:

- You can use the `identity()` method to perform a transformation in which the output XML document and the input XML document are the same.
- You can use the `xmlFilterChain()` method to apply three stylesheets in a chain.
- You can transform any class of the interface `Source` into a class of the interface `Result` (`DOMSource` to `DOMResult`, `StreamSource` to `StreamResult`, `SAXSource` to `SAXResult`, and so on).

The `basic()` method in the program `JAXPEXamples.java` shows how to perform a basic XSLT transformation, using these steps (which are illustrated with code fragments from the program):

1. Create a new instance of a `TransformerFactory`:

```
TransformerFactory tfactory = TransformerFactory.newInstance();
```

2. Create a new XSL transformer from the factory and specify the stylesheet to use for the transformation:

```
URL xslURL = createURL("jaxpone.xsl");
String xslID = xslURL.toString();
...
Transformer transformer = tfactory.newTransformer(new StreamSource(xslID));
```

In the preceding code, the stylesheet is `jaxpone.xsl`.

3. Set the stream source to the input XML document:

```
URL xmlURL = createURL("jaxpone.xml");
String xmlID = xmlURL.toString();
```



```
...
StreamSource source = new StreamSource(xmlID);
```

In the preceding code, the stream source is `jaxpone.xml`.

4. Transform the document from a `StreamSource` to a `StreamResult`:

```
transformer.transform(source, new StreamResult(System.out));
```

4.6 Compressing and Decompressing XML

XDK lets you use SAX or DOM to parse XML and then write the parsed data to a compressed binary stream. XDK also lets you reverse the process, decompressing the binary stream to reconstruct the XML data.

Topics:

- [Compressing a DOM Object](#) (page 4-49)
- [Decompressing a DOM Object](#) (page 4-50)
- [Compressing a SAX Object](#) (page 4-50)
- [Decompressing a SAX Object](#) (page 4-51)

4.6.1 Compressing a DOM Object

`DOMCompression.java` shows the basic steps of DOM compression. The most important DOM compression method is `XMLDocument.writeExternal()`, which saves the state of the object by creating a binary compressed stream with information about the object.

The `DOMCompression.java` program uses these steps (which are illustrated with code fragments from the program):

1. Create a DOM parser, parse an input XML document, and get the DOM representation:

```
public class DOMCompression
{
    static OutputStream out = System.out;
    public static void main(String[] args)
    {
        XMLDocument doc = new XMLDocument();
        DOMParser parser = new DOMParser();
        try
        {
            parser.setValidationMode(XMLParser.SCHEMA_VALIDATION);
            parser.setPreserveWhitespace(false);
            parser.retainCDATASection(true);
            parser.parse(createURL(args[0]));
            doc = parser.getDocument();
            ...
        }
    }
}
```

For a description of this technique, see [Performing Basic DOM Parsing](#) (page 4-18).

2. Create a `FileOutputStream` and wrap it in an `ObjectOutputStream` for serialization:

```
OutputStream os = new FileOutputStream("xml.ser");
ObjectOutputStream oos = new ObjectOutputStream(os);
```

3. Serialize the object to the file by invoking `XMLDocument.writeExternal()`:

```
doc.writeExternal(oos);
```

This method saves the state of the object by creating a binary compressed stream with information about this object.

4.6.2 Decompressing a DOM Object

`DOMDecompression.java` shows the basic steps of DOM decompression. The most important DOM decompression method is `XMLDocument.readExternal()`, which reads the information that the `writeExternal()` method wrote (the compressed stream) and restores the object.

The `DOMDecompression.java` program uses these steps (which are illustrated with code fragments from the program):

1. Create a file input stream for the compressed file and wrap it in an `ObjectInputStream`:

```
InputStream is;  
ObjectInputStream ois;  
...  
is = new FileInputStream("xml.ser");  
ois = new ObjectInputStream(is);
```

The preceding code creates a `FileInputStream` from the compressed file created in [Compressing a DOM Object](#) (page 4-49).

2. Create a new XML document object to contain the decompressed data:

```
XMLDocument serializedDoc = null;  
serializedDoc = new XMLDocument();
```

3. Read the compressed file by invoking `XMLDocument.readExternal()`:

```
serializedDoc.readExternal(ois);  
serializedDoc.print(System.out);
```

The preceding code data and prints it to `System.out`.

4.6.3 Compressing a SAX Object

`SAXCompression.java` shows the basic steps of parsing a file with SAX and writing the compressed stream to a file. The important class is `CXMLHandlerBase`, which is a SAX Handler that compresses XML data based on SAX events.

To use SAX compression, implement this interface and register it with the SAX parser by invoking `Parser.setDocumentHandler()`.

The `SAXCompression.java` program uses these steps (which are illustrated with code fragments from the program):

1. Create a `FileOutputStream` and wrap it in an `ObjectOutputStream`:

```
String compFile = "xml.ser";  
FileOutputStream outputStream = new FileOutputStream(compFile);  
ObjectOutputStream out = new ObjectOutputStream(outputStream);
```

2. Create the SAX event handler:

```
CXMLHandlerBase cxml = new CXMLHandlerBase(out);
```

The `CXMLHandlerBase` class implements the `ContentHandler`, `DTDHandler`, `EntityResolver`, and `ErrorHandler` interfaces.

3. Create the SAX parser:

```
SAXParser parser = new SAXParser();
```

4. Configure the SAX parser:

```
parser.setContentHandler(cxml);
parser.setEntityResolver(cxml);
parser.setValidationMode(XMLConstants.NONVALIDATING);
```

The preceding code sets the content handler, entity resolver, and validation mode.

Note:

Although `oracle.xml.comp.CXMLHandlerBase` implements both `DocumentHandler` and `ContentHandler` interfaces, Oracle recommends using the SAX 2.0 `ContentHandler` interface.

5. Parse the XML:

```
parser.parse(url);
```

The `SAXCompression.java` program writes the serialized data to the `ObjectOutputStream`.

4.6.4 Decompressing a SAX Object

`SAXDeCompression.java` shows the basic steps of reading the serialized data from the file that `SAXCompression.java` wrote. The important class is `CXMLParser`, which is an XML parser that regenerates SAX events from a compressed stream.

The `SAXDeCompression.java` program follows these steps (which are illustrated with code fragments from the program):

1. Create a SAX event handler:

```
SampleSAXHandler xmlHandler = new SampleSAXHandler();
```

2. Create the SAX parser by instantiating the `CXMLParser` class:

```
CXMLParser parser = new CXMLParser();
```

The `CXMLParser` class implements the regeneration of XML documents from a compressed stream by generating SAX events from them.

3. Set the event handler for the SAX parser:

```
parser.setContentHandler(xmlHandler);
```

4. Parse the compressed stream and generate the SAX events:

```
parser.parse(args[0]);
```

The preceding code receives a file name from the command line and parses the XML.

4.7 Tips and Techniques for Parsing XML

A few parsing tips and techniques are listed.

Topics:

- [Extracting Node Values from a DOM Tree](#) (page 4-52)
- [Merging Documents with `appendChild\(\)`](#) (page 4-53)
- [Parsing DTDs](#) (page 4-54)
- [Handling Character Sets with the XML Parser](#) (page 4-57)

4.7.1 Extracting Node Values from a DOM Tree

You can use the `selectNodes()` method in the `XMLNode` class to extract content from a DOM tree or subtree based on the select patterns allowed by XSL.

You can use the optional second parameter of `selectNodes()` to resolve namespace prefixes; that is, to return the expanded namespace URL when given a prefix. The `XMLElement` class implements `NSResolver`, so a reference to an `XMLElement` object can be sent as the second parameter. `XMLElement` resolves the prefixes based on the input document. You can use the `NSResolver` interface to override the namespace definitions.

The sample code in [Example 4-4](#) (page 4-52) shows how to use `selectNodes()`.

To test the program, create a file with the code in [Example 4-4](#) (page 4-52), and then compile it in the `$ORACLE_HOME/xdk/demo/java/parser/common` directory. Pass the file name `family.xml` to the program as a parameter to traverse the `<family>` tree. The output is similar to this:

```
% java selectNodesTest family.xml
Sarah
Bob
Joanne
Jim
```

Now run the following code to determine the values of the `memberid` attributes of all `<member>` elements in the document:

```
% java selectNodesTest family.xml //member/@memberid
m1
m2
m3
m4
```

Example 4-4 *Extracting Contents of a DOM Tree with `selectNodes()`*

```
//
// selectNodesTest.java
//
import java.io.*;
import oracle.xml.parser.v2.*;
import org.w3c.dom.Node;
import org.w3c.dom.Element;
import org.w3c.dom.Document;
```

```

import org.w3c.dom.NodeList;

public class selectNodesTest
{
    public static void main(String[] args)
        throws Exception
    {
        // supply an xpath expression
        String pattern = "/family/member/text()";
        // accept a filename on the command line
        // run the program with $ORACLE_HOME/xdk/demo/java/parser/common/family.xml
        String file = args[0];

        if (args.length == 2)
            pattern = args[1];

        DOMParser dp = new DOMParser();

        dp.parse(DemoUtil.createURL(file)); // include createURL from DemoUtil
        XMLDocument xd = dp.getDocument();
        XMLElement element = (XMLElement) xd.getDocumentElement();
        NodeList nl = element.selectNodes(pattern, element);
        for (int i = 0; i < nl.getLength(); i++)
        {
            System.out.println(nl.item(i).getNodeValue());
        } // end for
    } // end main
} // end selectNodesTest

```

4.7.2 Merging Documents with appendChild()

How to merge XML documents using `XMLElement.appendChild()` is described.

To write a program that lets a user complete a client-side Java form and get an XML document, your Java program can contain these variables:

```

String firstname = "Gianfranco";
String lastname = "Pietraforte";

```

To insert this information into an XML document, you can use either of these techniques:

- Create an XML document in a string and then parse it. For example:

```

String xml = "<person><first>"+firstname+"</first>"+
            "<last>"+lastname+"</last></person>";
DOMParser d = new DOMParser();
d.parse(new StringReader(xml));
Document xmldoc = d.getDocument();

```

- Use DOM APIs to construct an XML document, creating elements and then appending them to one another. For example:

```

Document xmldoc = new XMLDocument();
Element e1 = xmldoc.createElement("person");
xmldoc.appendChild(e1);
Element e2 = xmldoc.createElement("firstname");
e1.appendChild(e2);
Text t = xmldoc.createTextNode("Larry");
e2.appendChild(t);

```

You can use the second technique only on a *single* DOM tree.

[Example 4-5](#) (page 4-54) uses two trees—the owner document of `e1` is `xmldoc1` and the owner document of `e2` is `xmldoc2`. The `appendChild()` method works only within a single tree. Therefore, invoking `XMLElement.appendChild()` raises a DOM exception of `WRONG_DOCUMENT_ERR`.

To copy and paste a DOM document fragment or a DOM node across different XML documents, use the `XMLDocument.importNode()` method (introduced in DOM 2) and the `XMLDocument.adoptNode()` method (introduced in DOM 3). The comments in [Example 4-6](#) (page 4-54) show this technique.

Example 4-5 Incorrect Use of `appendChild()`

```
XMLDocument xmldoc1 = new XMLDocument();
XMLElement e1 = xmldoc1.createElement("person");
XMLDocument xmldoc2 = new XMLDocument();
XMLElement e2 = xmldoc2.createElement("firstname");
e1.appendChild(e2);
```

Example 4-6 Merging Documents with `appendChild`

```
XMLDocument doc1 = new XMLDocument();
XMLElement element1 = doc1.createElement("person");
XMLDocument doc2 = new XMLDocument();
XMLElement element2 = doc2.createElement("firstname");
// element2 = doc1.importNode(element2);
// element2 = doc1.adoptNode(element2);
element1.appendChild(element2);
```

4.7.3 Parsing DTDs

You can use load and parse a DTD.

Topics:

- [Loading External DTDs](#) (page 4-54)
- [Caching DTDs with `setDoctype`](#) (page 4-55)

4.7.3.1 Loading External DTDs

The procedure for loading and parsing a DTD is presented.

If you invoke the `DOMParser.parse()` method to parse the XML document as an `InputStream`, then use the `DOMParser.setBaseURL()` method to recognize external DTDs within your Java program. `DOMParser.setBaseURL()` points to a location where the DTDs are exposed.

The procedure for loading and parsing a DTD is:

1. Load the DTD as an `InputStream`.

For example, this code validates documents against the `/mydir/my.dtd` external DTD:

```
InputStream is = MyClass.class.getResourceAsStream("/mydir/my.dtd");
```

The preceding code opens `/mydir/my.dtd` in the first relative location in the `CLASSPATH` where it can be found, including the JAR file if it is in the `CLASSPATH`.

2. Create a DOM parser and set the validation mode.

For example:

```
DOMParser d = new DOMParser();
d.setValidationMode(DTD_VALIDATION);
```

3. Parse the DTD.

For example, this code passes the `InputStream` object to the `DOMParser.parseDTD()` method:

```
d.parseDTD(is, "rootelementname");
```

4. Get the document type and then set it.

For example, in this code, the `getDoctype()` method gets the DTD object and the `setDoctype()` method sets the DTD to use for parsing:

```
d.setDoctype(d.getDoctype());
```

Alternatively, you can invoke the `parseDTD()` method to parse a DTD file separately and get a DTD object:

```
d.parseDTD(new FileReader("/mydir/my.dtd"));
DTD dtd = d.getDoctype();
parser.setDoctype(dtd);
```

5. Parse the input XML document:

```
d.parse("mydoc.xml");
```

4.7.3.2 Caching DTDs with setDoctype

The XML parser for Java provides for DTD caching in validation and nonvalidation modes through the `DOMParser.setDoctype()` method. After you set the DTD with this method, the parser caches it for further parsing.

Note:

DTD caching is optional, and is not enabled automatically.

Suppose that your program must parse several XML documents with the same DTD. After you parse the first XML document, you can get the DTD from the parser and set it. For example:

```
DOMParser parser = new DOMParser();
DTD dtd = parser.getDoctype();
parser.setDoctype(dtd);
```

[Example 4-7](#) (page 4-55) invokes `DOMParser.setDoctype()` to cache the DTD.

If the cached DTD object is used only for validation, then set the `DOMParser.USE_DTD_ONLY_FOR_VALIDATION` attribute:

```
parser.setAttribute(DOMParser.USE_DTD_ONLY_FOR_VALIDATION, Boolean.TRUE);
```

Otherwise, the XML parser copies the DTD object and adds it to the resulting DOM tree.

Example 4-7 DTDSample.java

```
/**
 * DESCRIPTION
 * This program illustrates DTD caching.
```

```
*/

import java.net.URL;
import java.io.*;
import org.xml.sax.InputSource;
import oracle.xml.parser.v2.*;

public class DTDSample
{
    static public void main(String[] args)
    {
        try
        {
            if (args.length != 3)
            {
                System.err.println("Usage: java DTDSample dtd rootelement xmldoc");
                System.exit(1);
            }

            // Create a DOM parser
            DOMParser parser = new DOMParser();

            // Configure the parser
            parser.setErrorStream(System.out);
            parser.showWarnings(true);

            // Create a FileReader for the DTD file specified on the command
            // line and wrap it in an InputSource
            FileReader r = new FileReader(args[0]);
            InputSource inSource = new InputSource(r);

            // Create a URL from the command-line argument and use it to set the
            // system identifier
            inSource.setSystemId(DemoUtil.createURL(args[0]).toString());

            // Parse the external DTD from the input source. The second argument is
            // the name of the root element.
            parser.parseDTD(inSource, args[1]);
            DTD dtd = parser.getDoctype();

            // Create a FileReader object from the XML document specified on the
            // command line
            r = new FileReader(args[2]);

            // Wrap the FileReader in an InputSource,
            // create a URL from the filename,
            // and set the system identifier
            inSource = new InputSource(r);
            inSource.setSystemId(DemoUtil.createURL(args[2]).toString());

            // *****
            parser.setDoctype(dtd);
            // *****

            parser.setValidationMode(DOMParser.DTD_VALIDATION);
            // parser.setAttribute
            // (DOMParser.USE_DTD_ONLY_FOR_VALIDATION, Boolean.TRUE);
            parser.parse(inSource);

            // Get the DOM tree and print
            XMLDocument doc = parser.getDocument();
        }
    }
}
```



```
        doc.print(new PrintWriter(System.out));
    }
    catch (Exception e)
    {
        System.out.println(e.toString());
    }
}
}
```

4.7.4 Handling Character Sets with the XML Parser

Topics for handling character sets with the parser are introduced.

Topics:

- [Detecting the Encoding of an XML File on the Operating System](#) (page 4-57)
- [Preventing Distortion of XML Stored in an NCLOB Column](#) (page 4-57)
- [Writing an XML File in a Nondefault Encoding](#) (page 4-58)
- [Parsing XML Stored in Strings](#) (page 4-59)
- [Parsing XML Documents with Accented Characters](#) (page 4-59)
- [Handling Special Characters in Tag Names](#) (page 4-60)

4.7.4.1 Detecting the Encoding of an XML File on the Operating System

Use the XML parser to detect the character encoding of an XML file stored on your file system.

When reading an XML file stored on the operating system, do not use the `FileReader` class. Instead, use the XML parser to detect the character encoding of the document automatically. Given a binary `FileInputStream` with no external encoding information, the parser automatically determines the character encoding based on the byte-order mark and encoding declaration of the XML document. You can parse any well-formed document in any supported encoding with the sample code in the `AutoDetectEncoding.java` demo, which is located in `$ORACLE_HOME/xdk/demo/java/parser/dom`.

Note:

Include the proper encoding declaration in your document, according to the specification. `setEncoding()` cannot set the encoding for your input document. `setEncoding()` is used with `oracle.xml.parser.v2.XMLDocument` to set the correct encoding for printing.

4.7.4.2 Preventing Distortion of XML Stored in an NCLOB Column

To avoid distortion of XML data that is stored in an NCLOB column, use methods `getUnicodeStream()` and `getBinaryStream()`, or print the data to ensure that its characters are not distorted before they are sent to the parser.

Suppose that you load XML into a national character large object (NCLOB) column of a database using 8-bit encoding of Unicode (UTF-8), and the XML contains two UTF-8 multibyte characters:

```
G(0xc2,0x82)otingen, Br(0xc3,0xbc)ck_W
```

You write a Java stored function that does this:

1. Uses the default connection object to connect to the database.
2. Runs a SELECT query.
3. Gets the `oracle.jdbc.OracleResultSet` object.
4. Invokes the `OracleResultSet.getCLOB()` method.
5. Invokes the `getAsciiStream()` method on the CLOB object.
6. Executes this code to get the XML into a DOM object:

```
DOMParser parser = new DOMParser();
parser.setPreserveWhitespace(true);
parser.parse(istr);
// istr getAsciiStream XMLDocument xmldoc = parser.getDocument();
```

The program throws an exception stating that the XML contains an invalid UTF-8 encoding even though the character (0xc2, 0x82) is valid UTF-8. The problem is that the character can be distorted when the program invokes the `OracleResultSet.getAsciiStream()` method. To solve this problem, invoke the `getUnicodeStream()` and `getBinaryStream()` methods instead of `getAsciiStream()`. If this technique does not work, then try to print the characters to ensure that they are not distorted before they are sent to the parser when you invoke `DOMParser.parse(istr)`.

4.7.4.3 Writing an XML File in a Nondefault Encoding

A technique is introduced to avoid problems that can be introduced when writing XML files that contain characters that are not available in the default character encoding.

UTF-8 encoding is popular for XML documents, but UTF-8 is not usually the default file encoding of Java. Using a Java class in your program that assumes the default file encoding can cause problems.

For example, the Java class `FileWriter` depends on the default character encoding of the runtime environment. If you use the `FileWriter` class when writing XML files that contain characters that are not available in the default character encoding, then the output file can suffer parsing errors or data loss.

To avoid such problems, use the technique shown in the `I18nSafeXMLFileWritingSample.java` program in `$ORACLE_HOME/xdk/demo/java/parser/dom`.

You cannot use `System.out.println()` to output special characters. You must use a binary output stream that is encoding-aware, such as `OutputStreamWriter`. Construct an `OutputStreamWriter` and use the `write(char[], int, int)` method to print, as in this example:

```
/* Java encoding string for ISO8859-1*/
OutputStreamWriter out = new OutputStreamWriter(System.out, "8859_1");
OutputStreamWriter.write(...);
```

4.7.4.4 Parsing XML Stored in Strings

To parse an XML document contained in a `String`, you must first convert the string to an `InputStream` or `InputStream` object.

[Example 4-8](#) (page 4-59) converts a string of XML (referenced by `xmlDoc`) to a byte array, converts the byte array to a `ByteArrayInputStream`, and then parses it.

You can convert the `XMLDocument` object created in the previous code back to a string by wrapping a `StringWriter` in a `PrintWriter`. This example shows this technique:

To convert the `XMLDocument` object created in [Example 4-8](#) (page 4-59) back to a string, you can wrap a `StringWriter` in a `PrintWriter`:

```
StringWriter sw = new StringWriter();
PrintWriter pw = new PrintWriter(sw);
doc.print(pw);
String YourDocInString = sw.toString();
```

`ParseXMLFromString.java`, which is located in `$ORACLE_HOME/xdk/demo/java/parser/dom`, is a complete program that creates an XML document as a string and parses it.

Example 4-8 Converting XML in a String

```
// create parser
DOMParser parser=new DOMParser();
// create XML document in a string
String xmlDoc =
    "<?xml version='1.0'?>"+
    "<hello>"+
    " <world/>"+
    "</hello>";
// convert string to bytes to stream
byte aByteArr [] = xmlDoc.getBytes();
ByteArrayInputStream bais = new ByteArrayInputStream(aByteArr,0,aByteArr.length);
// parse and get DOM tree
DOMParser.parse(bais);
XMLDocument doc = parser.getDocument();
```

4.7.4.5 Parsing XML Documents with Accented Characters

Tips for parsing XML documents that contain accented characters are presented.

[Example 4-9](#) (page 4-60) shows one way to parse an XML document with accented characters (such as é).

When you try to parse the XML file, the parser might throw an "Invalid UTF-8 encoding" exception. The encoding is a scheme used to write the Unicode character number representation to disk. If you explicitly set the encoding to UTF-8 or do not specify the encoding, then the parser interprets an accented character—which has an ASCII value greater than 127—as the first byte of a UTF-8 multibyte sequence. If the subsequent bytes do not form a valid UTF-8 sequence, then you get an error.

The error means that your XML editor did not save the file with UTF-8 encoding. The editor might have saved the file with ISO-8859-1 (Western European ASCII) encoding. Adding the following element to the top of an XML document does not cause your editor to write the bytes representing the file to disk with UTF-8 encoding:

```
<?xml version="1.0" encoding="UTF-8"?>
```

One solution is to read accented characters in their hexadecimal or decimal format within the XML document; for example, `Ù`. If you prefer not to use this technique, then you can set the encoding based on the character set that you were using when you created the XML file (for example, ISO-8859-1).

Example 4-9 Parsing a Document with Accented Characters

```
DOMParser parser=new DOMParser();
parser.setPreserveWhitespace(true);
parser.setErrorStream(System.err);
parser.setValidationMode(false);
parser.showWarnings(true);
parser.parse (new FileInputStream(new File("file_with_accents.xml")));
```

4.7.4.6 Handling Special Characters in Tag Names

Tips for handling special characters in XML element names are presented.

If a tag (element) name contains special characters (&, \$, and #, and so on), then the parser issues an error about invalid characters.

If you are creating a new XML document, choose tag names that have no invalid NameChar characters. For example, if you want to name the tags after companies, and one company has the name A&B, then instead of the invalid tag `<A&B>`, choose `<A_B>`, `<AB>`, or `<A_AND_B>`.

If you are generating XML from external data sources such as database tables, then:

- XML 1.0 does not address this problem.
- In XML 1.1, the data type `XMLType` addresses this problem by providing the `setConvertSpecialChars` and `convert` functions in the `DBMS_XMLGEN` package.

You can use these functions to control the use of special characters in structured query language (SQL) names and XML names. The SQL-to-XML name-mapping functions escape invalid XML NameChar characters in the format of `_XHHHH_`, where `HHHH` is the Unicode value of the invalid character. For example, table name `V$SESSION` is mapped to XML name `V_X0024_SESSION`.

Escaping invalid characters provides a way to serialize names so that they can be reloaded somewhere else.

Using Binary XML with Java

Topics here explain how to use Binary XML with Java.

Topics:

- [Introduction to Binary XML for Java](#) (page 5-1)
- [Models for Using Binary XML](#) (page 5-2)
- [Components of Binary XML for Java](#) (page 5-4)
- [Binary XML Vocabulary Management](#) (page 5-5)
- [Using the Java Binary XML Package](#) (page 5-6)

5.1 Introduction to Binary XML for Java

Binary XML makes it possible to encode and decode between XML text and compressed binary XML. Application programming interfaces (APIs) are provided on top of Binary XML for direct consumption by the XML applications. Compression and decompression of fragments of an XML document facilitate incremental processing.

This chapter assumes that you are familiar with the XML Parser for Java.

See Also:

[XML Parsing for Java](#) (page 4-1)

5.1.1 Binary XML Storage Format – Java

Binary XML is a compact XML-Schema-aware encoding of XML data, but it can be used with XML data that is not based on an XML schema. You can also use binary XML for XML data which is outside the database (in a client-side application, for instance). Binary XML allows for encoding and decoding of XML documents, from text to binary and binary to text. Binary XML is post-parse persistent XML with native database data types.

XMLType tables and columns can be created using the binary XML storage option. The XML data in binary format can be accessed and manipulated by all the existing structured query language (SQL) operators and functions and Procedural Language/Structured Query Language (PL/SQL) APIs that operate on XMLType.

Binary XML provides more efficient database storage, updating, indexing, query performance, and fragment extraction than unstructured storage. It can store data and metadata together, or separately.

See Also:

Oracle XML DB Developer's Guide for a discussion of all the storage models in Oracle XML DB.

5.1.2 Binary XML Processors

A *binary XML processor* is an abstract term for a component that processes and transforms binary XML into text and XML text into binary XML. It can also provide a cache for storing schemas. A binary XML processor can originate or receive network protocol requests.

The base class for a binary XML processor is `BinXMLProcessor`.

5.2 Models for Using Binary XML

There are several models for using binary XML in applications. These subsections describe the terminology and the models for using binary XML.

5.2.1 Usage Terminology for Binary XML

Terms related to binary XML usage are described.

- *doc-id*: Each encoded XML document is identified by a unique doc-id. It is either a 16-byte Global User identifier (GUID) or an opaque sequence of bytes like a URL.
- *token table*: When a text XML document does not have a schema associated with it, then a token (or symbol) table is used to minimize space for repeated items.
- *vocabulary id*: Can be a schema-id or a namespace Universal Resource Identifier (URI) for a token table.
- *schema-id*: A unique opaque binary identifier for a schema scoped to the binary XML processor. The schema-id is unique for a binary XML processor and is identifiable only within the scope of that binary XML processor. The schema-id remains constant even when the schema is evolved. A schema-id represents the entire set of schema documents, including imported and included schemas.
- *schema version*: Every annotated schema has a version number associated with it. The version number is specified as part of the system level annotations. It is incremented by the binary XML processor when a schema is evolved (that is, a new version of the same schema is registered with the binary XML processor).
- *partial validity*: Binary XML stream encoding using schema implies at least partial validity with the schema. Partial validity implies no validation for unique keys, keyrefs, identifiers (IDs), or DTD attributes such as IDREF.

5.2.2 Standalone Model

This is the simplest usage scenario for binary XML. There is a single binary XML processor.

The only repository available is the local in-memory vocabulary cache that is not persistent and is available only for the life of the binary XML processor. All schemas must be registered in advance with the binary XML Processor before the encoding, or they can be registered automatically when the XML Processor sees the

`xsi:SchemaLocation` tag. For decoding, the schema is already available in the vocabulary cache.

5.2.3 Client/Server Model

In a client-server scenario, the binary XML processor is connected to a database using Java Database Connectivity (JDBC). It is assumed that the XML schema is registered with the database before encoding.

Here is an example of how to achieve that:

```
BEGIN
  DBMS_XMLSCHEMA.registerSchema(
    SCHEMAURL =>
      'http://xmlns.oracle.com/xdb/documentation/purchaseOrder.xsd',
    SCHEMADOC =>
      bfilename('XMLDIR', 'purchaseOrder.xsd'),
    CSID => nls_charset_id('AL32UTF8'),
    GENTYPES => FALSE,
    OPTIONS => REGISTER_BINARYXML );
END;
/
```

Unless a separate connection is specified for data (using `associateDataConnection()`) it is assumed that all data and metadata is stored and retrieved using a single connection for encoding and decoding.

5.2.4 Web Services Model With Repository

In this scenario there are multiple clients, each running a binary XML processor. One encodes and another decodes. There is a common repository (that is not necessarily a database) connected to all the clients for metadata storage. It can be a file system or some other repository.

The first binary XML processor ensures that the schema is registered with the repository before performing the encoding, or the schema might be automatically registered using the `xsi:schemaLocation` tag at the time of encoding. The second binary XML processor is used for decoding, is not aware of the location of the schema, and fetches the schema from the repository.

If the first binary XML processor registers a schema and the second binary XML processor registers the same schema in the repository, the binary XML processor does not compile the schema, but simply returns the `vocabulary-id` of the existing compiled schema in the local vocabulary cache.

The `BinXMLProcessor` is not thread-safe, so multiple threads or clients accessing the repository must implement their own thread safety scheme.

5.2.5 Web Services Model Without Repository

In this scenario, there are multiple clients, each running a binary XML processor. Encoding and decoding can happen on different clients. There is no common metadata repository.

The encoder must ensure that the binary data passed to the next client is independent of schema: that is, has inline token definitions. This can be achieved by setting `schemaAware = false` and `inlineTokenDefs = true`, using the `setProperty()` method, during encoding. While decoding, there is no schema required.

5.3 Components of Binary XML for Java

The components of binary XML for Java are described.

These are the components:

- Binary XML encoding—The binary XML encoder converts XML 1.0 infoset to binary XML.
- Binary XML decoding—The binary XML decoder converts binary XML to XML infoset.
- Binary XML vocabulary management, which includes schema management and token management.

5.3.1 Binary XML Encoding

The encoder is created from a `BinXMLStream`. It takes XML text as input, and it outputs the encoded binary XML to the `BinXMLStream`. It reads the XML text using streaming SAX. The encoding of the XML text is based on the results of parsing the XML text.

Set the `schemaAware` flag on the encoder that specifies whether the encoding is schema-aware or schema-less.

For schema-aware encoding, the encoder determines whether the schema with the specified schema URL has been registered with the vocabulary manager. For a repository-based or a database-based processor, the encoder queries the repository or the database for the compiled schema based on the schema URL. If the schema is available in the database, it is fetched from the repository or database in the binary XML format and registered with the local vocabulary manager. The vocabulary is schema.

Also set a flag to indicate that the encoding produces a binary XML stream that is independent of a schema. In this case, the resulting binary XML stream contains all token definitions inline and is not dependent on schema or external token sets.

If the encoding is schema-aware, the encoder uses the data type information from the schema object for more efficient encoding of the SAX stream. There is a default encoding data type associated with each schema built-in data type. Binary XML stream encoding using a schema implies at least partial validity with the schema (For partial validity there is no validation for unique key, or keyref, or ID, or DTD attributes such as IDREF). If the data is known to be completely valid with a schema, the encoded binary XML stream stores this information.

See Also:

Oracle XML DB Developer's Guide for tables of the binary encoding data types and their mappings from XML schema data types

If there is no schema associated with the text XML, then integer token ids are generated for repeated items in the text XML. Creating a token table of token ids and token definitions is an important compression technique. The token definitions are stored as token tables in the vocabulary cache. If the property for inline token definitions is set, then the token definitions are present inline.

See Also:

[Token Management](#) (page 5-6)

Another property on the encoder is specifying PSVI (Post-Schema-Validated Infoset) information as part of the binary stream. If this is set to true then PSVI information can be accessed using XDK extension APIs for PSVI on DOM. If `psvi = true` then the input XML is fully validated with the schema. If `psvi` is false then PSVI information is not included in the output binary stream. The default is false.

5.3.2 Binary XML Decoding

The binary XML decoder converts binary XML to XML infoset. The decoder is created from the `BinXMLStream`; it reads binary XML from this stream and outputs SAX events or provide a pull style `InfosetReader` API for reading the decoded XML.

If an XML schema is associated with the `BinXMLStream`, the binary XML decoder retrieves the associated schema object from the vocabulary cache, using the vocabulary id before decoding. If the schema is not available in the vocabulary cache and the connection information to the server is available, then the schema is fetched from the server.

If no schema is associated with `BinXMLStream`, then the token definitions can be either inline in the `BinXMLStream` or stored in a token set. If tokens of a corresponding namespace are not stored in the local vocabulary cache, then the token set is fetched from the repository.

5.4 Binary XML Vocabulary Management

The binary XML processors are of different types depending on where the metadata (schema or token sets) are located—either local binary XML processor or repository binary XML processor.

5.4.1 Schema Management

For metadata persistence, Oracle recommends that you use the DB Binary XML processor. In this case, schemas and token sets are registered with the database. The vocabulary manager fetches the schema or token sets from the database and cache it in the local vocabulary cache for encoding and decoding.

See Also:

[Binary XML](#) (page 5-9)

If you must use a persistent metadata repository that is not a database, you can plug in your own metadata repository. You must implement the interface for communicating with this repository, `BinXMLMetadataProvider`.

5.4.1.1 Schema Registration for Binary XML Vocabulary Management

Register XML schemas locally with the local binary XML processor. It contains a vocabulary manager that maintains all XML schemas submitted by a user for the duration of its existence. The vocabulary manager associated with a local binary XML processor does not provide for XML schema persistence.

If you register the same XML schema again (same schema location and same target namespace) then it is not parsed, and the existing vocabulary identifier is returned.

If a new XML schema with the same target namespace and a different schema location is registered, then the existing XML schema definition is augmented with the new schema definitions. In case of conflict, an error is raised.

5.4.1.2 Schema Identification

Each schema is identified by a vocabulary id. The vocabulary id is in the scope of the processor and is unique within the processor. Any document that validates with a schema is required to validate with a latest version of the schema.

5.4.1.3 Schema Annotations

Binary XML Schema annotations can appear only within element `<xsd:appInfo>` in an XML schema. The vocabulary manager interprets user-level and system-level annotations during XML schema registration. All other schema annotations, such as database-related annotations, are ignored.

5.4.1.4 User-Level Annotations

User-level annotations are specified by a user before registration.

`encodingType`—This annotation can be used within a `xsd:element`, `xsd:attribute` or `xsd:simpleType` elements. It indicates the data type to be used for encoding the node value of the element or attribute. For strings, there is support only for 8-bit encoding of Unicode (UTF-8) encoding in this release.

5.4.1.5 System-Level Annotations

The vocabulary manager adds system-level annotations at the time of registration. You cannot overwrite them.

5.4.2 Token Management

Token sets can be fetched from the database or metadata repository, cached in the local vocabulary manager, and used for decoding. While encoding, token sets can be pushed to the repository for persistence.

Token definitions can also be included as part of the binary XML stream by setting a flag on the encoder.

5.5 Using the Java Binary XML Package

Use of the binary XML package is described.

A `BinXMLStream` class represents the binary XML stream. The different storage locations defined for the binary XML stream are:

- `InputStream`—stream for reading.
- `OutputStream`—stream for writing.
- `URL`—stream for reading.
- `File`—stream for read and write.
- `BLOB`—stream for reading and writing.
- `Byte array`—stream for reading and writing.

- In memory—stream for reading and writing.

The `BinXMLStream` object specifies the type of storage during creation.

A `BinXMLStream` object can be created from a `BinXMLProcessor` factory. This factory can be initialized with a JDBC connection (for remote metadata access), connection pool, URL or a `PageManagerPool` (for lazy in-memory storage). `BinXMLEncoder` and `BinXMLDecoder` can be created from the `BinXMLStream` for encoding or decoding.

Here is an example of creating a processor without a repository, registering a schema, encoding XML SAX events into schema-aware binary format, and storing in a file:

```
BinXMLProcessor proc = BinXMLProcessorFactory.createProcessor();
proc.registerSchema(schemaURL);
BinXMLStream outbin = proc.createBinaryStream(outFile);
BinXMLEncoder enc = outbin.getEncoder();
enc.setSchemaAware(true);
ContentHandler hdlr = enc.getContentHandler();
```

In addition to getting the `ContentHandler`, you can also get the other handlers, such as:

```
LexicalHandler lexhdlr = enc.getLexicalHandler();
DTDHandler dtdhdlr = enc.getDTDHandler();
DeclHandler declhdlr = enc.getDeclHandler();
ErrorHandler errhdlr = enc.getErrorHandler();
```

Use `hdlr` in the application that generates the SAX events.

2. Here is an example of creating a processor with a database repository, decoding a schema-aware binary stream and reading the decoded XML using pull API. The schema is fetched from the database repository for decoding.

```
DBBinXMLMetadataProvider dbrep =
    BinXMLMetadataProviderFactory.createDBMetadataProvider();
BinXMLProcessor proc = BinXMLProcessorFactory.createProcessor(dbrep);
BinXMLStream inpbin = proc.createBinaryStream(blob);
BinXMLDecoder dec = inpbin.getDecoder();
InfosetReader xmlreader = dec.getReader();
```

Use `xmlreader` to read XML in a pull-style from the decoder.

5.5.1 Binary XML Encoder

The encoder takes XML input, which is parsed and read using SAX events, and outputs binary XML.

5.5.1.1 Schema-Less Option

You can specify the schema-aware or the schema-less option before encoding. The default is schema-less encoding.

If the schema-aware option is set, then the encoding is done based on schema(s) specified in the instance document. The annotated schemas used for encoding are also required at the time of decoding. If the schema-less option is specified, then the encoding is independent of schemas, but the tokens are inline by default. To override the default, set `Inline-token = false`.

5.5.1.2 Inline-Token Option

You can set an option to create a binary XML stream with inline token definitions before encoding. If inlining is turned off then you must ensure that the encoder or decoder processors use the same metadata repository. By default, token definition is inline.

Flag `Inline-token` is ignored if the schema-aware option is turned on.

Figure 5-1 Binary XML Encoding

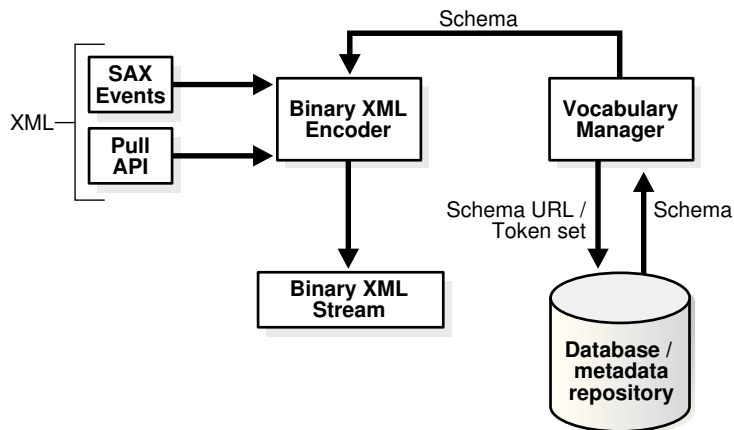

5.5.2 Binary XML Decoder

The binary XML decoder takes a binary XML stream as input and generates SAX Events as output, or it provides a pull interface to read the decoded XML. For an XML schema-aware binary XML stream, the binary XML decoder interacts with the vocabulary manager to extract the schema information.

If the vocabulary manager does not contain the required schema, and the processor is of type binary XML with a valid JDBC connection, then the remote schema is fetched from the database or the metadata repository based on the vocabulary id in the binary XML stream to be decoded. Similarly, the set of token definitions can be fetched from the database or the metadata repository.

Figure 5-2 Binary XML Decoder

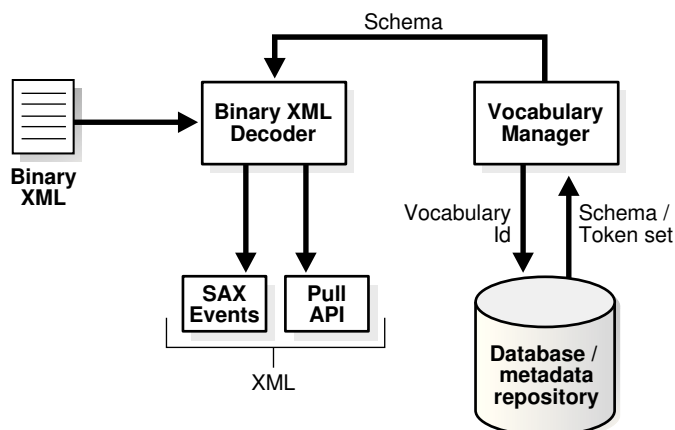

5.5.3 Schema Registration Overview

You register an XML schema with the Binary XML Processor. The schema is a text file that can contain user-level annotations. As part of the registration process, the processor adds system-level annotations. The resulting annotated schema is then processed by the Schema Builder to build an XML schema object.

This XML schema object is stored in the vocabulary cache. The vocabulary cache assigns a unique vocabulary id for each XML schema object, which is returned as output. The annotated DOM representation of the XML schema is sent to the binary XML encoder.

5.5.4 Resolving `xsi:schemaLocation`

How `xsi:schemaLocation` is resolved is described.

During encoding, if `schemaAware` is true and the property `ImplicitSchemaRegistration` is true, then the first `xsi:schemaLocation` tag present in the root element of an XML instance document automatically registers that schema in the local vocabulary manager. No other `schemaLocation` tags are explicitly registered. If the processor is database-oriented then the schema is also registered in the database; similarly for any metadata repository based processor.

If the encoding is set to `schemaAware` is false or `ImplicitSchemaRegistration` is false, then all `xsi:schemaLocation` tags are ignored by the encoder.

5.5.5 Binary XML

A binary XML processor can communicate with the database for various types of binary XML operations involving storage and retrieval of binary XML schemas, token sets, and binary XML streams.

A `DBBinXMLMetadataProvider` object is either instantiated with a dedicated JDBC connection or a connection pool to access vocabulary information such as schema and token set. The processor is also associated with one or more data connections to access XML data.

Database communication is involved in these ways:

1. Extracting compiled binary XML schema using the vocabulary ID or the schema URL

To retrieve a compiled binary XML schema for encoding, the database is queried based on the schema URL. For decoding the binary XML schema, fetch it from the database based on the vocabulary ID.

2. Storing noncompiled binary XML schema using the schema URL and retrieving the vocabulary id.

When the `xsi:schemaLocation` tag is encountered during encoding, the schema is registered in the database for persistent storage in the database. The vocabulary id associated with the schema, and the binary version of the compiled schema is retrieved from the database; the compiled schema object is built and stored in the local cache using the vocabulary id returned from the database.

3. Retrieving a binary token set using namespace URL.

If a binary stream to be decoded is associated with token tables for decoding, these are fetched from the database using the metadata connection.

4. Storing binary token set using namespace URL

If the XML text has been encoded without a schema, then it produces a token set of token definitions. These token tables can be stored persistently in the database. The metadata connection is used for transferring the token set to the database.

5. Binary XML stream with remote storage option

It is your responsibility to create a table containing an `XMLType` column with binary XML for storing the result of encoding and retrieving the binary XML for decoding. Communication with the database can be achieved with Oracle Net Services and JDBC. Fetch the `XMLType` object from the output result set of the JDBC query. The `BinXMLStream` for reading the binary data or for writing out binary data can be created from the `XMLType` object. The `XMLType` class must be extended to support reading and writing of binary XML data.

5.5.6 Persistent Storage of Metadata

You can provide persistent back-end storage for metadata.

A local vocabulary manager and cache stores metadata information in memory for the life of the `BinXMLProcessor`. You can plug in your own back-end storage for metadata by implementing interface `BinXMLMetadataProvider` and plugging it into the `BinXMLProcessor`. Currently only one metadata provider for each processor is supported.

You must code a `FileBinXMLMetadataProvider` that implements interface `BinXMLMetadataProvider`. The encoder and decoder uses these APIs to access metadata from the persisted back-end storage. Set up the configuration information for the persistent storage: for example, root directory for a file system in `FileBinXMLMetadataProvider` class. Instantiate `FileBinXMLMetadataProvider` and plug it into the `BinXMLProcessor`.

Using the XSLT Processor for Java

An explanation is given of how to use the Extensible Stylesheet Language Transformation (XSLT) processor for Java.

Topics:

- [Introduction to the XSLT Processor](#) (page 6-1)
- [Using the XSLT Processor for Java: Overview](#) (page 6-3)
- [Transforming XML](#) (page 6-8)
- [Programming with Oracle XSLT Extensions](#) (page 6-11)
- [Tips and Techniques for Transforming XML](#) (page 6-15)

6.1 Introduction to the XSLT Processor

Topics include prerequisites, standards and specifications, and an overview of XML transformation with XSLT.

Topics:

- [Prerequisites for Using the XSLT Processor for Java](#) (page 6-1)
- [Standards and Specifications for the XSLT Processor for Java](#) (page 6-2)
- [XML Transformation with XSLT 1.0 and 2.0](#) (page 6-2)

6.1.1 Prerequisites for Using the XSLT Processor for Java

XSLT is a language, based on Extensible Markup Language (XML), that you can use to transform one XML document into another text document. For example, you can use XSLT to accept an XML data document as input, perform arithmetic calculations on element values in the document, and generate an Extensible HyperText Markup Language (XHTML) document that shows the calculation results. In XSLT, XPath is used to navigate and process elements in the source node tree. XPath models an XML document as a tree made up of nodes; the types of nodes in the XPath node tree correspond to the types of nodes in a DOM tree.

This chapter assumes that you are familiar with these World Wide Web Consortium (W3C) standards:

- Extensible Stylesheet Language (XSL) and [Extensible Stylesheet Language Transformations \(XSLT\)](#). For a general introduction to XSLT, see the XML resources listed in [Related Documents](#) (page xxix).

6.1.2 Standards and Specifications for the XSLT Processor for Java

The Oracle XML Developer's Kit (XDK) XSLT processor supports the XSLT2.0 recommendation.

You can find the specification here:

- <http://www.w3.org/TR/xslt20/>

XPath, which is the navigational language used by XSLT and other XML languages, is available in two versions: XPath 2.0 and the XPath 1.0 Recommendation. You can find the specifications for the two XPath versions here:

- <http://www.w3.org/TR/xpath20/>
- <http://www.w3.org/TR/xpath>

See Also:

[Oracle XML Developer's Kit Standards](#) (page 33-1) for a summary of the standards supported by XDK

6.1.3 XML Transformation with XSLT 1.0 and 2.0

Oracle XML Developer's Kit (XDK) provides several useful features not included in XSLT 1.0. To use XSLT 2.0, set the `version` attribute in your stylesheet.

```
<? xml-stylesheet version="2.0" ... ?>
```

Useful XSLT 2.0 features include these:

- User-defined functions

You can use the `<xsl:function>` declaration to define functions. This element must have one `name` attribute to define the function name. The value of the `name` attribute is a QName. The content of the `<xsl:function>` element is zero or more `xsl:param` elements that specify the formal arguments of the function, followed by a sequence constructor that defines the value returned by the function.

QName can have a null namespace, but user-defined functions must have a non-null namespace. That is, if `abc` is defined as a namespace, then `add` is not a legal user-defined function, but `abc:add` is.

- Grouping

You can use the `<xsl:for-each-group>` element, `current-group()` function, and `current-grouping-key()` function to group items.

- Multiple result documents

You can use the `<xsl:result-document>` element to create a result tree. The content of the `<xsl:result-document>` element is a sequence constructor for the children of the document node of the tree.

For example, this element enables you to accept an XML document as input and break it into separate documents. You can take an XML document that describes a list of books and generate an XHTML document for each book. You can then validate each output document.

- Temporary trees

Instead of representing the intermediate XSL transformation results and XSL variables as strings, as in XSLT 1.0, you can store them as a set of document nodes. The document nodes, which you can construct with the `<xsl:variable>`, `<xsl:param>`, and `<xsl:with-param>` elements, are called temporary trees.

- Character mapping

In XSLT 1.0, you had to use the `disable-output-escaping` attribute of the `<xsl:text>` and `<xsl:value-of>` elements to specify character escaping. In XSLT 2.0, you can declare mapping characters with an `<xsl:character-map>` element as a top-level stylesheet element. You can use this element to generate files with reserved or invalid XML characters in the XSLT outputs, such as `<`, `>`, and `&`.

See Also:

<http://www.w3.org/TR/xslt20> for explanation and examples of XSLT 2.0 features

6.2 Using the XSLT Processor for Java: Overview

The XDK XSLT processor transforms an XML document into another text-based document, with a format such as XML, HTML, XHTML, or plain text. You can invoke the processor programmatically by using an application programming interface (API) or run it from the command line.

The XSLT processor can perform these tasks:

- Reads one or more XSLT stylesheets. The processor can apply multiple stylesheets to a single XML input document and generate different results.
- Reads one or more input XML documents. The processor can use a single stylesheet to transform multiple XML input documents.
- Builds output documents by applying the rules in the stylesheet to the input XML documents. The output is a Document Object Model (DOM) tree, output stream, or series of Simple API for XML (SAX) events.

Whereas XSLT is a function-based language that generally requires a DOM of the input document and stylesheet to perform the transformation, the XDK Java implementation of the XSLT processor can use SAX to create a stylesheet object to perform transformations with higher efficiency and fewer resources. You can reuse this stylesheet object to transform multiple documents without reparsing the stylesheet.

Topics:

- [Using the XSLT Processor for Java: Basic Process](#) (page 6-3)
- [Running the XSLT Processor Demo Programs](#) (page 6-4)
- [Using the XSLT Processor Command-Line Utility](#) (page 6-6)

6.2.1 Using the XSLT Processor for Java: Basic Process

The basic design of the XSLT processor for Java is presented.

Figure 6-1 (page 6-4) illustrates this process.

See Also:

Oracle Database XML Java API Reference to learn about the `XMLParser` and `XSDBuilder` classes

Figure 6-1 Using the XSLT Processor for Java

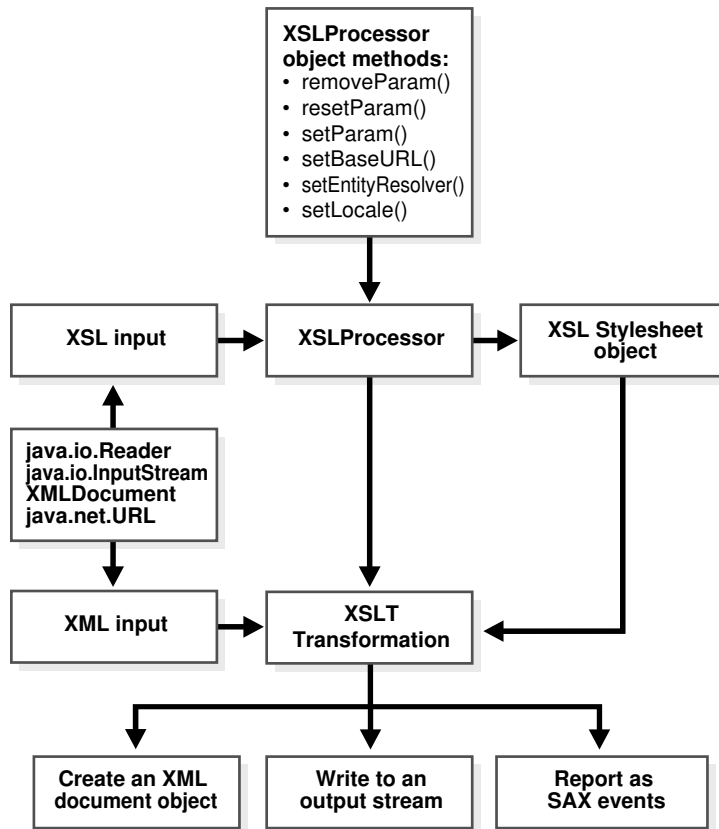

6.2.2 Running the XSLT Processor Demo Programs

Demo programs for the XSLT processor for Java are included in `$ORACLE_HOME/xdk/demo/java/parser/xslt`.

Table 6-1 (page 6-4) describes the XML files and programs that you can use to test the XSLT processor.

Table 6-1 XSLT Processor Sample Files

File	Description
<code>match.xml</code>	A sample XML document that you can use to test ID selection and pattern matching. Its associated stylesheet is <code>match.xsl</code> .
<code>match.xsl</code>	A sample stylesheet for use with <code>match.xml</code> . You can use it to test simple identity transformations.

Table 6-1 (Cont.) XSLT Processor Sample Files

File	Description
<code>math.xml</code>	A sample XML data document that you can use to perform simple arithmetic. Its associated stylesheet is <code>math.xsl</code> .
<code>math.xsl</code>	A sample stylesheet for use with <code>math.xml</code> . The stylesheet outputs an HTML page with the results of arithmetic operations performed on element values in <code>math.xml</code> .
<code>number.xml</code>	A sample XML data document that you can use to test for source tree numbering. The document describes the structure of a book.
<code>number.xsl</code>	A sample stylesheet for use with <code>number.xml</code> . The stylesheet outputs an HTML page that calculates section numbers for the sections in the book described by <code>number.xml</code> .
<code>position.xml</code>	A sample XML data document that you can use to test for <code>position()=X</code> in complex patterns. Its associated stylesheet is <code>position.xsl</code> .
<code>position.xsl</code>	A sample stylesheet for use with <code>position.xml</code> . The stylesheet outputs an HTML page with the results of complex pattern matching.
<code>reverse.xml</code>	A sample XML data document that you can use with <code>reverse.xsl</code> to traverse backward through a tree.
<code>reverse.xsl</code>	A sample stylesheet for use with <code>reverse.xml</code> . The stylesheet output the item numbers in <code>reverse.xml</code> in reverse order.
<code>string.xml</code>	A sample XML data document that you can use to test perform various string test and manipulations. Its associated stylesheet is <code>string.xsl</code> .
<code>string.xsl</code>	A sample stylesheet for use with <code>string.xml</code> . The stylesheet outputs an XML document that displays the results of the string manipulations.
<code>style.txt</code>	A stylesheet that provides the framework for an HTML page. The stylesheet is included by <code>number.xsl</code> .
<code>variable.xml</code>	A sample XML data document that you can use to test the use of XSL variables. The document describes the structure of a book. Its associated stylesheet is <code>variable.xsl</code> .
<code>variable.xsl</code>	A stylesheet for use with <code>variable.xml</code> . The stylesheet makes extensive use of XSL variables.
<code>XSLSample.java</code>	A sample application that offers a simple example of how to use the XSL processing capabilities of the Oracle XSLT processor. The program transforms an input XML document by using an input stylesheet. This program builds the result of XSL transformations as a <code>DocumentFragment</code> and does not show <code>xsl:output</code> features. Run this program with any XSLT stylesheet in the directory as a first argument and its associated <code>*.xml</code> XML document as a second argument. For example, run the program with <code>variable.xsl</code> and <code>variable.xml</code> or <code>string.xsl</code> and <code>string.xml</code> .
<code>XSLSample2.java</code>	A sample application that offers a simple example of how to use the XSL processing capabilities of the Oracle XSLT processor. The program transforms an input XML document by using an input stylesheet. This program outputs the result to a stream and supports <code>xsl:output</code> features. Like <code>XSLSample.java</code> , you can run it against any pair of XML data documents and stylesheets in the directory.

Documentation for how to compile and run the sample programs is located in the README. The basic steps are:

1. Change into the `$ORACLE_HOME/xdk/demo/java/parser/xslt` directory (UNIX) or `%ORACLE_HOME%\xdk\demo\java\parser\xslt` directory (Windows).
2. Make sure that your environment variables are set as described in [Setting Up the XDK for Java Environment](#) (page 3-5)
3. Run `make` (UNIX) or `Make.bat` (Windows) at the command line. The `make` file compiles the source code and then runs the `XSLSample` and `XSLSample2` programs for each `*.xml` file and its associated `*.xsl` stylesheet. The program writes its output for each transformation to `*.out`.
4. You can view the `*.out` files to see the output for the XML transformations. You can also run the programs on the command line as follows, where `name` is replaced by `match`, `math`, and so forth:

```
java XSLSample name.xsl name.xml
java XSLSample2 name.xsl name.xml
```

For example, run the `match.xml` demos:

```
java XSLSample match.xsl match.xml
java XSLSample2 match.xsl match.xml
```

6.2.3 Using the XSLT Processor Command-Line Utility

XDK includes `oraxsl`, which is a command-line Java interface that can apply a stylesheet to multiple XML documents. The `$ORACLE_HOME/bin/oraxsl` and `%ORACLE_HOME%\bin\oraxsl.bat` shell scripts execute the `oracle.xml.jaxb.oraxsl` class.

To use `oraxsl` ensure that your `CLASSPATH` is set as described in [Setting Up the XDK for Java Environment](#) (page 3-5).

Use this syntax on the command line to invoke `oraxsl`:

```
oraxsl options source stylesheet result
```

The `oraxsl` utility expects a stylesheet, an XML file to transform, and an optional result file. If you do not specify a result file, then the utility sends the transformed document to standard output. If multiple XML documents must be transformed by a stylesheet, then use the `-l` or `-d` options with the `-s` and `-r` options. These and other options are described in [Table 6-2](#) (page 6-6).

Table 6-2 Command-Line Options for `oraxsl`

Option	Description
<code>-w</code>	Shows warnings. By default, warnings are turned off.
<code>-e error_log</code>	Specifies file into which the program writes errors and warnings.
<code>-l xml_file_list</code>	Lists files to be processed.

Table 6-2 (Cont.) Command-Line Options for oraxsl

Option	Description
<code>-d directory</code>	Specifies the directory that contains the files to transform. The default behavior is to process all files in the directory. If only a subset of the files in that directory, for example, one file, must be processed, then change this behavior by setting <code>-l</code> and specifying the files that must be processed. You can also change the behavior by using the <code>-x</code> or <code>-i</code> option to select files based on their extension.
<code>-x source_extension</code>	Specifies extensions for the files to be excluded. Use this option with <code>-d</code> . The program does not select any files with the specified extension.
<code>-i source_extension</code>	Specifies extensions for the files to be included. Use this option with <code>-d</code> . The program selects only files with the specified extension.
<code>-s stylesheet</code>	Specifies the stylesheet. If you set <code>-d</code> or <code>-l</code> , then set <code>-s</code> to indicate the stylesheet to be used. You must specify the complete path.
<code>-r result_extension</code>	Specifies the extension to use for results. If you set <code>-d</code> or <code>-l</code> , then set <code>-r</code> to specify the extension to be used for the results of the transformation. So, if you specify the extension <code>out</code> , the program transformed an input document <code>doc</code> to <code>doc.out</code> . By default, the program places the results in the current directory. You can change this behavior by using the <code>-o</code> option, which enables you to specify a directory for the results.
<code>-o result_directory</code>	Specifies the directory in which to place results. You must set this option with the <code>-r</code> option.
<code>-p param_list</code>	Lists parameters.
<code>-t num_of_threads</code>	Specifies the number of threads to use for processing. Using multiple threads can provide performance improvements when processing multiple documents.
<code>-v</code>	Generates verbose output. The program prints some debugging information and can help in tracing any problems that are encountered during processing.
<code>-debug</code>	Generates debugging output. By default, debug mode is disabled. A graphical user interface (GUI) version of the XSLT debugger is available in Oracle JDeveloper.

6.2.3.1 Using the XSLT Processor Command-Line Utility: Example

You can test `oraxsl` on the various XML files and stylesheets in `$ORACLE_HOME/xdk/demo/java/parser/xslt`.

[Example 6-1](#) (page 6-8) displays the contents of `math.xml`.

The XSLT stylesheet named `math.xsl` is shown in [Example 6-2](#) (page 6-8).

You can run the `oraxsl` utility on these files to produce HTML output as shown in this example:

```
oraxsl math.xml math.xsl math.htm
```

The output file `math.htm` is shown in [Example 6-3](#) (page 6-8).

Example 6-1 math.xml

```
<?xml version="1.0"?>
<doc>
  <n1>5</n1>
  <n2>2</n2>
  <div>-5</div>
  <mod>2</mod>
</doc>
```

Example 6-2 math.xsl

```
<?xml version="1.0"?><xsl:stylesheet version="1.0" xmlns:xsl="http://www.w3.org/
1999/XSL/Transform">
  <xsl:template match="doc">
    <HTML>
      <H1>Test for mod.</H1>
      <HR/>
      <P>Should say "1": <xsl:value-of select="5 mod 2"/></P>
      <P>Should say "1": <xsl:value-of select="n1 mod n2"/></P>
      <P>Should say "-1": <xsl:value-of select="div mod mod"/></P>
      <P><xsl:value-of select="div or ((mod)) | or"/></P>
    </HTML>
  </xsl:template>
</xsl:stylesheet>
```

Example 6-3 math.htm

```
<HTML>
  <H1>Test for mod.</H1>
  <HR>
  <P>Should say "1": 1</P>
  <P>Should say "1": 1</P>
  <P>Should say "-1": -1</P>
  <P>true</P>
</HTML>
```

6.3 Transforming XML

Topics here include performing basic XSL transformation and getting DOM results from a transformation.

Topics:

- [Performing Basic XSL Transformation](#) (page 6-8)
- [Getting DOM Results from an XSL Transformation](#) (page 6-10)

6.3.1 Performing Basic XSL Transformation

The fundamental classes used by the XSLT processor are `DOMParser` and `XSLProcessor`. The `XSL2Sample.java` demo program provides a good illustration of how to use these classes to transform an XML document with an XSLT stylesheet.

Classes `DOMParser` and `XSLProcessor` are described in [Using the XSLT Processor for Java: Overview](#) (page 6-3).

Use these basic steps to write Java programs that use the XSLT processor:

1. Create a DOM parser object that you can use to parse the XML data documents and XSLT stylesheets. This code fragment from `XSL2Sample.java` shows how to instantiate a parser:

```
XMLDocument xml, xslDoc, out;URL xslURL;URL xmlURL;
// ...
parser = new DOMParser();parser.setPreserveWhitespace(true);
```

By default, the parser does not preserve white space unless a DTD is used. It is important to preserve white space because it enables XSLT white space rules to determine how white space is handled.

2. Parse the XSLT stylesheet with the `DOMParser.parse()` method. this code fragment from `XSL2Sample.java` shows how to perform the parse:

```
xslURL = DemoUtil.createURL(args[0]);
parser.parse(xslURL);
xslDoc = parser.getDocument();
```

3. Parse the XML data document with the `DOMParser.parse()` method. this code fragment from `XSL2Sample.java` shows how to perform the parse:

```
xmlURL = DemoUtil.createURL(args[1]);
parser.parse(xmlURL);
xml = parser.getDocument();
```

4. Create a new XSLT stylesheet object. You can pass objects of these classes to the `XSLProcessor.newXSLStylesheet()` method:

- `java.io.Reader`
- `java.io.InputStream`
- `XMLDocument`
- `java.net.URL`

For example, `XSL2Sample.java` shows how to create a stylesheet object from an `XMLDocument` object:

```
XSLProcessor processor = new XSLProcessor();
processor.setBaseURL(xslURL);
XSLStylesheet xsl = processor.newXSLStylesheet(xslDoc);
```

5. Set the XSLT processor to display any warnings. For example, `XSL2Sample.java` invokes the `showWarnings()` and `setErrorStream()` methods:

```
processor.showWarnings(true);
processor.setErrorStream(System.err);
```

6. Use the `XSLProcessor.processXSL()` method to apply the stylesheet to the input XML data document. [Table 6-3](#) (page 6-9) lists some other available `XSLProcessor` methods.

Table 6-3 XSLProcessor Methods

Method	Description
<code>removeParam()</code>	Removes parameters.
<code>resetParams()</code>	Resets all parameters.

Table 6-3 (Cont.) XSLProcessor Methods

Method	Description
<code>setParam()</code>	Sets parameters for the transformation.
<code>setBaseUrl()</code>	Sets a base URL for any relative references in the stylesheet.
<code>setEntityResolver()</code>	Sets an entity resolver for any relative references in the stylesheet.
<code>setLocale()</code>	Sets a locale for error reporting.

This code fragment from `XSL2Sample.java` shows how to apply the stylesheet to the XML document:

```
processor.processXSL(xsl, xml, System.out);
```

7. Process the transformed output. You can transform the results by creating an XML document object, writing to an output stream, or reporting SAX events.

This code fragment from `XSL2Sample.java` shows how to print the results:

```
processor.processXSL(xsl, xml, System.out);
```

See Also:

- <http://www.w3.org/TR/xslt>
 - <http://www.w3.org/style/XSL>
 - [XML Parsing for Java](#) (page 4-1)
-
-

6.3.2 Getting DOM Results from an XSL Transformation

Sample programs show how to obtain the results from an XSL transformation.

The `XSLSample.java` demo program shows how to generate an `oracle.xml.parser.v2.XMLDocumentFragment` object as the result of an XSL transformation. An `XMLDocumentFragment` is a *lightweight* `Document` object that extracts a portion of an XML document tree. The `XMLDocumentFragment` class implements the `org.w3c.dom.DocumentFragment` interface.

The `XSL2Sample.java` demo program shows how to generate a `DocumentFragment` object. The basic steps for transforming XML are the same as those described in [Performing Basic XSL Transformation](#) (page 6-8). The only difference is in the arguments passed to the `XSLProcessor.processXSL()` method. This code fragment from `XSL2Sample.java` shows how to create the DOM fragment and then print it to standard output:

```
XMLDocumentFragment result = processor.processXSL(xsl, xml);
result.print(System.out);
```

[Table 6-4](#) (page 6-11) lists some `XMLDocumentFragment` methods you can use to manipulate the object.

Table 6-4 XMLDocumentFragment Methods

Method	Description
<code>getAttributes()</code>	Gets a <code>NamedNodeMap</code> containing the attributes of this node (if it is an <code>Element</code>) or null otherwise
<code>getLocalName()</code>	Gets the local name for this element
<code>getNamespaceURI()</code>	Gets the namespace URI of this element
<code>getNextSibling()</code>	Gets the node immediately following the current node
<code>getNodeName()</code>	Gets the name of the node
<code>getNodeNameType()</code>	Gets a code that represents the type of the underlying object
<code>getParentNode()</code>	Gets the parent of the current node
<code>getPreviousSibling()</code>	Gets the node immediately preceding the current node
<code>reportSAXEvents()</code>	Reports SAX events from a DOM tree

6.4 Programming with Oracle XSLT Extensions

Topics here include an overview, specifying namespaces for extension functions, using Java methods, using constructor extension functions, and using return value extension functions.

Topics:

- [Overview of Oracle XSLT Extensions](#) (page 6-11)
- [Specifying Namespaces for XSLT Extension Functions](#) (page 6-12)
- [Using Static and Nonstatic Java Methods in XSLT](#) (page 6-12)
- [Using Constructor Extension Functions](#) (page 6-13)
- [Using Return Value Extension Functions](#) (page 6-13)

6.4.1 Overview of Oracle XSLT Extensions

The XSLT 1.0 standard defines two kinds of extensions: extension elements and extension functions. XDK provides extension functions for XSLT processing that enable users of the XSLT processor to invoke any Java method from XSL expressions. When using Oracle XSLT extensions, follow these guidelines:

- When you define an XSLT extension in a given programming language, you can use only the XSLT stylesheet with XSLT processors that can invoke this extension. Thus, only the Java version of the processor can invoke extension functions that are defined in Java.
- Use XSLT extensions only if the built-in XSL functions cannot solve a given problem.

- As explained in this section, the namespace of the extension class must start with the proper URL.

These Oracle extension functions are especially useful:

- `<ora:output>`, you can use `<ora:output>` as a top-level element or in an XSL template. If used as a top-level element, it is similar to the `<xsl:output>` extension function, except that it has an additional `name` attribute. When used as a template, it has the additional attributes `use` and `href`. This function is useful for creating multiple outputs from one XSL transformation.
- `<ora:node-set>`, which converts a result tree fragment into a node-set. This function is useful when you want to refer the existing text or intermediate text results in XSL for further transformation.

6.4.2 Specifying Namespaces for XSLT Extension Functions

The Oracle Java extension functions belong to the namespace that corresponds to this Universal Resource Identifier (URI): `http://www.oracle.com/XSL/Transform/java/`. An extension function that belongs to this namespace refers to methods in the Java `classname`, so that you can construct URIs in this format: `http://www.oracle.com/XSL/Transform/java/classname`.

For example, you can use this namespace to invoke `java.lang.String` methods from XSL expressions: `http://www.oracle.com/XSL/Transform/java/java.lang.String`.

Note:

When assigning the `xsl` prefix to a namespace, the correct URI is `xmlns:xsl="http://www.w3.org/1999/XSL/Transform"`. Any other URI fails to give correct output.

6.4.3 Using Static and Nonstatic Java Methods in XSLT

If a Java method is a *nonstatic* method of a class then the first parameter is used as the instance on which the method is invoked, and the rest of the parameters are passed to the method. If the extension function is a *static* method, however, then *all* the parameters of the extension function are passed as parameters to the static function.

[Example 6-4](#) (page 6-13) shows how to use the `java.lang.Math.ceil()` method in an XSLT stylesheet.

For example, you can create [Example 6-4](#) (page 6-13) as stylesheet `ceil.xml` and then apply it to any well-formed XML document. For example, run the `oraxsl` utility:

```
oraxsl ceil.xml ceil.xml ceil.out
```

The output document `ceil.out` has this content:

```
<?xml version = '1.0' encoding = 'UTF-8'?>
13
```

Note:

The XSL class loader recognizes only statically added JARs and paths in the CLASSPATH and those specified by `wrapper.classpath`. Files added dynamically are not visible to XSLT processor.

Example 6-4 Using a Static Function in an XSLT Stylesheet

```
<xsl:stylesheet version="1.0"
  xmlns:xsl="http://www.w3.org/1999/XSL/Transform"
  xmlns:math="http://www.oracle.com/XSL/Transform/java/java.lang.Math">
  <xsl:template match="/">
    <xsl:value-of select="math:ceil('12.34')"/>
  </xsl:template>
</xsl:stylesheet>
```

6.4.4 Using Constructor Extension Functions

The extension function `new` creates a new instance of a class and acts as the constructor.

[Example 6-5](#) (page 6-13) creates a new `String` object with the value `Hello World`, stores it in the XSL variable `str1`, and then outputs it in uppercase.

For example, you can create this stylesheet as `hello.xsl` and apply it to any well-formed XML document. For example, run the `oraxsl` utility:

```
oraxsl hello.xsl hello.xml hello.out
```

The output document `hello.out` has this content:

```
<?xml version = '1.0' encoding = 'UTF-8'?>
HELLO WORLD
```

Example 6-5 Using a Constructor in an XSLT Stylesheet

```
<xsl:stylesheet version="1.0"
  xmlns:xsl="http://www.w3.org/1999/XSL/Transform"
  xmlns:jstring="http://www.oracle.com/XSL/Transform/java/java.lang.String">
  <xsl:template match="/">
    <!-- creates a new java.lang.String and stores it in the variable str1 -->
    <xsl:variable name="str1" select="jstring:new('HeLlO wOrLd')"/>
    <xsl:value-of select="jstring:toUpperCase($str1)"/>
  </xsl:template>
</xsl:stylesheet>
```

6.4.5 Using Return Value Extension Functions

The result of an extension function can be of any type, including the five types defined in XSL and the additional simple XML Schema data types defined in XSLT 2.0:

- NodeSet
- Boolean
- String
- Number
- ResultTree

You can store these data types in variables or pass them to other extension functions. If the result is one of the five types defined in XSL, it can be returned as the result of an XSL expression.

The XSLT Processor supports overloading based on the number of parameters and type. The processor performs implicit type conversion between the five XSL types as defined in XSL. It performs type conversion implicitly among these data types, and also from `NodeSet` to these data types:

- `String`
- `Number`
- `Boolean`
- `ResultTree`

Overloading based on two types that can be implicitly converted to each other is not permitted. This overloading causes an error in XSL because `String` and `Number` can be implicitly converted to each other:

- `overloadme(int i){}`
- `overloadme(String s){}`

Mapping between XSL data types and Java data types is done as follows:

```
String    ->    java.lang.String
Number    ->    int, float, double
Boolean   ->    boolean
NodeSet   ->    NodeList
ResultTree ->    XMLDocumentFragment
```

The stylesheet in [Example 6-6](#) (page 6-14) parses the `variable.xml` document, which is located in the directory `$ORACLE_HOME/xdk/demo/java/parser/xslt`, and retrieves the value of the `<title>` child of the `<chapter>` element.

You can create [Example 6-6](#) (page 6-14) as `getttitle.xml` and then run `oraxsl`:

```
oraxsl getttitle.xml getttitle.xml variable.out
```

The output document `variable.out` has this content:

```
<?xml version = '1.0' encoding = 'UTF-8'?>
The value of the title element is: Section Tests
```

Example 6-6 *getttitle.xml*

```
<xsl:stylesheet version="1.0"
  xmlns:xsl="http://www.w3.org/1999/XSL/Transform"
  xmlns:parser = "http://www.oracle.com/XSL/Transform/java/
oracle.xml.parser.v2.DOMParser"
  xmlns:document =
    "http://www.oracle.com/XSL/Transform/java/oracle.xml.parser.v2.XMLDocument">

  <xsl:template match = "/">
    <!-- Create a new instance of the parser and store it in myparser variable -->
    <xsl:variable name="myparser" select="parser:new()"/>

    <!-- Call an instance method of DOMParser. The first parameter is the object.
    The PI is equivalent to $myparser.parse('file:/my_path/variable.xml'). Note
    that you should replace my_path with the absolute path on your system. -->
    <xsl:value-of select="parser:parse($myparser, 'file:/my_path/variable.xml')"/>
```

```

<!-- Get the document node of the XML Dom tree -->
<xsl:variable name="mydocument" select="parser:getDocument($myparser)"/>

<!-- Invoke getelementsbytagname on mydocument -->
<xsl:for-each select="document:getElementsByTagName($mydocument,'chapter')">
  The value of the title element is: <xsl:value-of select="docinfo/title" />
</xsl:for-each>
</xsl:template>
</xsl:stylesheet>

```

6.5 Tips and Techniques for Transforming XML

Topics here include using XSLT to merge XML documents and creating an HTML input form based on the columns of a database table.

- [Merging XML Documents with XSLT](#) (page 6-15)
- [Creating an HTML Input Form Based on the Columns in a Table](#) (page 6-16)

6.5.1 Merging XML Documents with XSLT

Examples show how to merge XML documents using XSLT.

[Merging Documents with appendChild\(\)](#) (page 4-53) discusses the DOM technique for merging documents. If the merging operation is simple, then you can also use an XSLT-based approach. For example, you might want to merge the XML documents shown in [Example 6-7](#) (page 6-15) and [Example 6-8](#) (page 6-15).

[Example 6-9](#) (page 6-16) displays a sample stylesheet that merges the two XML documents based on matching the `<key/>` element values.

Create the XML files in [Example 6-7](#) (page 6-15), [Example 6-8](#) (page 6-15), and [Example 6-9](#) (page 6-16) and run this at the command line:

```
oraxsl msg_w_num.xml msgmerge.xsl msgmerge.xml
```

[Example 6-10](#) (page 6-16) shows the output document, which merges the data contained in `msg_w_num.xml` and `msg_w_text.xml`.

This technique is not as efficient for larger files as an equivalent database join of two tables, but it is useful if you have only XML files.

Example 6-7 *msg_w_num.xml*

```

<messages>
  <msg>
    <key>AAA</key>
    <num>01001</num>
  </msg>
  <msg>
    <key>BBB</key>
    <num>01011</num>
  </msg>
</messages>

```

Example 6-8 *msg_w_text.xml*

```

<messages>
  <msg>
    <key>AAA</key>
    <text>This is a Message</text>

```

```

</msg>
<msg>
  <key>BBB</key>
  <text>This is another Message</text>
</msg>
</messages>

```

Example 6-9 msgmerge.xsl

```

<xsl:stylesheet version="1.0" xmlns:xsl="http://www.w3.org/1999/XSL/Transform">
  <xsl:output indent="yes"/>
  <!-- store msg_w_text.xml in doc2 variable -->
  <xsl:variable name="doc2" select="document('msg_w_text.xml')"/>

  <!-- match each node in input xml document, that is, msg_w_num.xml -->
  <xsl:template match="@*|node()">
    <!-- copy the current node to the result tree -->
    <xsl:copy>
      <xsl:apply-templates select="@*|node()"/>
    </xsl:copy>
  </xsl:template>

  <!-- match each <msg> element in msg_w_num.xml -->
  <xsl:template match="msg">
    <xsl:copy>
      <xsl:apply-templates select="@*|node()"/>
      <!-- insert two spaces so indentation is correct in output document -->
      <xsl:text> </xsl:text>
      <!-- copy <text> node from msg_w_text.xml into result tree -->
      <text><xsl:value-of
        select="$doc2/messages/msg[key=current()/key]/text"/>
      </text>
    </xsl:copy>
  </xsl:template>
</xsl:stylesheet>

```

Example 6-10 msgmerge.xml

```

<?xml version = '1.0' encoding = 'UTF-8'?>
<messages>
  <msg>
    <key>AAA</key>
    <num>01001</num>
    <text>This is a Message</text>
  </msg>
  <msg>
    <key>BBB</key>
    <num>01011</num>
    <text>This is another Message</text>
  </msg>
</messages>

```

6.5.2 Creating an HTML Input Form Based on the Columns in a Table

To generate an HTML form for inputting data that uses column names from a database table, you can use the XML SQL Utility (XSU) to get an XML document based on the `user_tab_columns` table and then use XSLT to transform the XML into an HTML form.

1. Use XSU to generate an XML document based on the columns in the table. For example, using the table `hr.employees`, you can run XSU from the command line:

```
java OracleXML getXML -user "hr/password\"
"SELECT column_name FROM user_tab_columns WHERE table_name = 'EMPLOYEES'"
```

2. Save the XSU output as an XML file called `emp_columns.xml`. The XML looks like this, with one `<ROW>` element corresponding to each column in the table (some `<ROW>` elements have been removed to conserve space):

```
<?xml version = '1.0'?><ROWSET>
  <ROW num="1">
    <COLUMN_NAME>EMPLOYEE_ID</COLUMN_NAME>
  </ROW>
  <ROW num="2">
    <COLUMN_NAME>FIRST_NAME</COLUMN_NAME>
  </ROW>
  <!-- rows 3 through 10 -->
  <ROW num="11">
    <COLUMN_NAME>DEPARTMENT_ID</COLUMN_NAME>
  </ROW>
</ROWSET>
```

3. Create an XSLT stylesheet to transform the XML into HTML. For example, create the `columns.xsl` stylesheet:

```
<xsl:stylesheet version="1.0" xmlns:xsl="http://www.w3.org/1999/XSL/Transform">
  <xsl:output method="html" />
  <xsl:template match="/">
    <HTML>
      <xsl:apply-templates select="@*|node()" />
    </HTML>
  </xsl:template>
  <xsl:template match="ROW">
    <xsl:value-of select="COLUMN_NAME" />
    <xsl:text>&nbsp;</xsl:text>
    <INPUT NAME="{COLUMN_NAME}" />
    <BR/>
  </xsl:template>
</xsl:stylesheet>
```

4. Run the `oraxsl` utility to generate the HTML form. For example:

```
oraxsl emp_columns.xml columns.xsl emp_form.htm
```

5. Review the output HTML form, which has contents similar to these:

```
<HTML>
  EMPLOYEE_ID&nbsp;<INPUT NAME="EMPLOYEE_ID"><BR>
  FIRST_NAME&nbsp;<INPUT NAME="FIRST_NAME"><BR>
  LAST_NAME&nbsp;<INPUT NAME="LAST_NAME"><BR>
  EMAIL&nbsp;<INPUT NAME="EMAIL"><BR>
  PHONE_NUMBER&nbsp;<INPUT NAME="PHONE_NUMBER"><BR>
  HIRE_DATE&nbsp;<INPUT NAME="HIRE_DATE"><BR>
  JOB_ID&nbsp;<INPUT NAME="JOB_ID"><BR>
  SALARY&nbsp;<INPUT NAME="SALARY"><BR>
  COMMISSION_PCT&nbsp;<INPUT NAME="COMMISSION_PCT"><BR>
  MANAGER_ID&nbsp;<INPUT NAME="MANAGER_ID"><BR>
  DEPARTMENT_ID&nbsp;<INPUT NAME="DEPARTMENT_ID"><BR>
</HTML>
```

Using the XQuery Processor for Java

An explanation is given of how to use the Oracle XML Developer's Kit (XDK) XQuery processor for Java.

Topics:

- [Introduction to the XQuery Processor for Java](#) (page 7-1)
- [XQJ Entity Resolution](#) (page 7-2)
- [XQuery Output Declarations](#) (page 7-13)
- [Improving Application Performance and Scalability with XQuery](#) (page 7-15)
- [Performing Updates](#) (page 7-19)
- [Standards and Specifications for the XQuery Processor for Java](#) (page 7-29)

7.1 Introduction to the XQuery Processor for Java

XDK provides a standalone XQuery processor for use by Java applications. XQuery is the World Wide Web Consortium (W3C) standard query language for Extensible Markup Language (XML). Using XQuery to process XML within a Java application can improve developer productivity and application performance.

Applications written with XQuery often require less code, run faster, and use less memory than applications written fully in Java.

JSR 225: XQuery API for Java (XQJ) defines how queries can be executed from a Java application. To use XQJ, your application must run with Java version 1.6. In addition, these JAR files are required:

- `jlib/oxquery.jar`
- `jlib/xqjapi.jar`
- `jlib/orai18n-mapping.jar`
- `lib/xmlparserv2.jar`
- `jdk/jlib/apache-xmlbeans.jar`

The directory paths for these Java Archive (JAR) files are relative to the `ORACLE_HOME` directory of your Oracle Database installation.

[Example 7-1](#) (page 7-2) shows how to execute a simple "Hello World" query using XQuery API for Java (XQJ). Because the XQuery processor runs directly in the Java Virtual Machine (JVM), you need no database or server to run this example. The example prints the output `<hello-world>2</hello-world>`.

This chapter describes the features and extensions that are specific to the Oracle implementation of XQuery. General information about XQuery and XQJ is documented outside of this document.

See Also:

- *Oracle Database XML Java API Reference, XQuery Packages*, for the related API documentation
 - <https://jcp.org/aboutJava/communityprocess/final/jsr225/index.html> for information about JSR 225: XQuery API for Java (XQJ)
 - <http://www.w3.org/TR/xquery-30/> for information about XQuery 3.0: An XML Query Language
-
-

Note:

Oracle also implements XQuery and XQJ as part of Oracle XML DB. See [Using XQuery API for Java to Access Oracle XML DB](#) (page 8-1) for details about Oracle XML DB.

Example 7-1 Simple Query Using XQJ

```
import javax.xml.xquery.XQConnection;
import javax.xml.xquery.XQException;
import javax.xml.xquery.XQPreparedExpression;
import javax.xml.xquery.XQSequence;

import oracle.xml.xquery.OXQDataSource;

public class HelloWorld {

    public static void main(String[] args) throws XQException {
        OXQDataSource ds = new OXQDataSource();
        XQConnection con = ds.getConnection();
        String query = "<hello-world>{1 + 1}</hello-world>";
        XQPreparedExpression expr = con.prepareExpression(query);
        XQSequence result = expr.executeQuery();

        // prints "<hello-world>2</hello-world>"
        System.out.println(result.getSequenceAsString(null));

        result.close();
        expr.close();
        con.close();
    }
}
```

7.2 XQJ Entity Resolution

XDK extends XQJ with an entity resolver framework for controlling how documents, schemas, modules, collations, and external functions are obtained during query processing. The examples in this section show how to use an entity resolver for several types of entities.

See the class `oracle.xml.xquery.OXQEntity` in *Oracle Database XML Java API Reference* for a complete list of the types of entities that the query processor can request.

This section includes these subsections:

- [Resolution of Documents for `fn:doc`](#) (page 7-3)
- [Resolution of External XQuery Functions](#) (page 7-5)
- [Resolution of Imported XQuery Modules](#) (page 7-8)
- [Resolution of XML Schemas Imported by an XQuery Query](#) (page 7-9)
- [Prefabricated Entity Resolvers for XQuery](#) (page 7-11)
- [Resolution of Other Types of Entity](#) (page 7-13)

7.2.1 Resolution of Documents for `fn:doc`

The example in this section shows how you can use an entity resolver to determine which document is returned by XQuery function `fn:doc`.

[Example 7-2](#) (page 7-3) displays the contents of `books.xml`.

[Example 7-3](#) (page 7-3) displays the contents of `books.xq`.

[Example 7-4](#) (page 7-3) shows how to execute the query `books.xq` with a custom entity resolver.

The instance of `MyEntityResolver` is passed to the XQuery processor by setting it on the connection. The XQuery processor invokes the entity resolver during query processing to get the document to be returned by the `fn:doc` function.

Example 7-2 *books.xml*

```
<books>
  <book>
    <title>A Game of Thrones</title>
    <author><first>George</first><last>Martin</last></author>
    <price>10.99</price>
  </book>
  <book>
    <title>The Pillars of the Earth</title>
    <author><first>Ken</first><last>Follett</last></author>
    <price>7.99</price>
  </book>
</books>
```

Example 7-3 *books.xq*

```
for $book in fn:doc('books.xml')/books/book
where xs:decimal($book/price) gt 10.00
return
  $book/title
```

Example 7-4 *Executing a Query with a Custom Entity Resolver*

```
import java.io.File;
import java.io.FileInputStream;
import java.io.IOException;
import java.net.URI;

import javax.xml.xquery.XQConnection;
```

```
import javax.xml.xquery.XQException;
import javax.xml.xquery.XQPreparedExpression;
import javax.xml.xquery.XQSequence;
import javax.xml.xquery.XQStaticContext;

import oracle.xml.xquery.OXQConnection;
import oracle.xml.xquery.OXQDataSource;
import oracle.xml.xquery.OXQEntity;
import oracle.xml.xquery.OXQEntityKind;
import oracle.xml.xquery.OXQEntityLocator;
import oracle.xml.xquery.OXQEntityResolver;
import oracle.xml.xquery.OXQEntityResolverRequestOptions;
import oracle.xml.xquery.OXQView;

public class ResolveDocument {

    private static class MyEntityResolver extends OXQEntityResolver {
        @Override
        public OXQEntity resolveEntity(OXQEntityKind kind, OXQEntityLocator locator,
            OXQEntityResolverRequestOptions options) throws IOException {
            if (kind == OXQEntityKind.DOCUMENT) {
                URI systemId = locator.getSystemIdAsURI();
                if ("file".equals(systemId.getScheme())) {
                    File file = new File(systemId);
                    FileInputStream input = new FileInputStream(file);
                    OXQEntity result = new OXQEntity(input);
                    result.enlistCloseable(input);
                    return result;
                }
            }
            return null;
        }
    }

    public static void main(String[] args) throws XQException, IOException {
        OXQDataSource ds = new OXQDataSource();
        XQConnection con = ds.getConnection();

        // OXQView is used to access Oracle extensions on XQJ objects.
        OXQConnection ocon = OXQView.getConnection(con);
        ocon.setEntityResolver(new MyEntityResolver());

        File query = new File("books.xq");

        // Relative URIs are resolved against the base URI before invoking the entity resolver.
        // The relative URI 'books.xml' used in the query will be resolved against this URI.
        XQStaticContext ctx = con.getStaticContext();
        ctx.setBaseURI(query.toURI().toString());

        FileInputStream queryInput = new FileInputStream(query);
        XQPreparedExpression expr = con.prepareExpression(queryInput, ctx);
        queryInput.close();
        XQSequence result = expr.executeQuery();

        // Prints "<title>A Game of Thrones</title>"
        System.out.println(result.getSequenceAsString(null));

        result.close();
        expr.close();
        con.close();
    }
}
```

The example generates this output:

```
<title>A Game of Thrones</title>
```

7.2.2 Resolution of External XQuery Functions

You can use an entity resolver to define the implementation of an XQuery external function.

For each external XQuery function that is declared in a query, the entity resolver is called with the entity kind `oracle.xml.xquery.OXQEntityKind.EXTERNAL_FUNCTION`. The `oracle.xml.xquery.OXQEntityLocator` instance that is passed in the call to the entity resolver provides the name of the XQuery function and its argument types. The entity resolver can then return any class that extends `oracle.xml.xquery.OXQFunctionEvaluator` and has a public constructor. The XQuery processor then instantiates the returned class. When the XQuery external function call is evaluated, method `evaluate()` is invoked.

[Example 7-5](#) (page 7-5) displays an XQuery query that is the content of file `trim.xq`.

External XQuery function `util:trim` removes white space from the beginning and end of a string value. This function is implemented in Java and called within the query.

[Example 7-6](#) (page 7-5) uses `trim.xq` and shows how to define the implementation of an external XQuery function. The entity resolver in this example returns a class that extends `OXQFunctionEvaluator`.

In some cases it is more convenient to return a Java static method instead of a class. When a static method is returned, the query processor automatically maps the method arguments and the return value to the XQuery data model, as defined by the XQJ specification.

[Example 7-7](#) (page 7-6) also runs `trim.xq`, but in this case the external function is bound to a Java static method.

Example 7-5 *trim.xq*

```
declare namespace util = "http://example.com/util";

declare function util:trim($arg as xs:string) as xs:string external;

(: a string with surrounding white space :)
declare variable $input := "  John Doe  ";

<result>{util:trim($input)}</result>
```

Example 7-6 *Defining the Implementation of an External XQuery Function*

```
import java.io.FileInputStream;
import java.io.IOException;
import java.util.Collections;

import javax.xml.namespace.QName;
import javax.xml.xquery.XQConnection;
import javax.xml.xquery.XQException;
import javax.xml.xquery.XQPreparedExpression;
import javax.xml.xquery.XQSequence;

import oracle.xml.xquery.OXQConnection;
import oracle.xml.xquery.OXQDataSource;
import oracle.xml.xquery.OXQEntity;
import oracle.xml.xquery.OXQEntityKind;
import oracle.xml.xquery.OXQEntityLocator;
import oracle.xml.xquery.OXQEntityResolver;
```

```

import oracle.xml.xquery.OXQEntityResolverRequestOptions;
import oracle.xml.xquery.OXQFunctionContext;
import oracle.xml.xquery.OXQFunctionEvaluator;
import oracle.xml.xquery.OXQFunctionMetaData;
import oracle.xml.xquery.OXQView;

public class ResolveExternalFunction {

    public static class TrimFunction extends OXQFunctionEvaluator {
        @Override
        public XQSequence evaluate(OXQFunctionContext context, XQSequence[] params) throws XQException {
            XQConnection con = context.getConnection();
            XQSequence arg = params[0];
            String value = arg.getSequenceAsString(null);
            String trimmed = value.trim();
            return con.createSequence(Collections.singleton(trimmed).iterator());
        }
    }

    private static class MyEntityResolver extends OXQEntityResolver {
        @Override
        public OXQEntity resolveEntity(OXQEntityKind kind, OXQEntityLocator locator,
            OXQEntityResolverRequestOptions options) throws XQException, IOException {
            if (kind == OXQEntityKind.EXTERNAL_FUNCTION) {
                OXQFunctionMetaData metaData = (OXQFunctionMetaData)locator.getExtension();
                QName name = metaData.getName();
                int arity = metaData.getParameterTypes().length;
                if ("http://example.com/util".equals(name.getNamespaceURI()) &&
                    "trim".equals(name.getLocalPart()) && arity == 1) {
                    return new OXQEntity(TrimFunction.class);
                }
            }
            return null;
        }
    }

    public static void main(String[] args) throws IOException, XQException {
        OXQDataSource ds = new OXQDataSource();
        XQConnection con = ds.getConnection();
        OXQConnection ocon = OXQView.getConnection(con);
        ocon.setEntityResolver(new MyEntityResolver());

        FileInputStream query = new FileInputStream("trim.xq");
        XQPreparedExpression expr = con.prepareExpression(query);
        query.close();

        XQSequence result = expr.executeQuery();

        System.out.println(result.getSequenceAsString(null));

        result.close();
        expr.close();
        con.close();
    }
}

```

The example prints this output: `<result>John Doe</result>`.

Example 7-7 Binding an External Function to a Java Static Method

```

import java.io.FileInputStream;
import java.io.IOException;
import java.lang.reflect.Method;

import javax.xml.namespace.QName;
import javax.xml.xquery.XQConnection;
import javax.xml.xquery.XQException;
import javax.xml.xquery.XQPreparedExpression;
import javax.xml.xquery.XQSequence;

```

```

import oracle.xml.xquery.OXQConnection;
import oracle.xml.xquery.OXQDataSource;
import oracle.xml.xquery.OXQEntity;
import oracle.xml.xquery.OXQEntityKind;
import oracle.xml.xquery.OXQEntityLocator;
import oracle.xml.xquery.OXQEntityResolver;
import oracle.xml.xquery.OXQEntityResolverRequestOptions;
import oracle.xml.xquery.OXQFunctionMetaData;
import oracle.xml.xquery.OXQView;

public class ResolveExternalFunction2 {

    public static String trim(String value) {
        return value.trim();
    }

    private static class MyEntityResolver extends OXQEntityResolver {
        @Override
        public OXQEntity resolveEntity(OXQEntityKind kind, OXQEntityLocator locator,
            OXQEntityResolverRequestOptions options) throws XQException, IOException {
            if (kind == OXQEntityKind.EXTERNAL_FUNCTION) {
                OXQFunctionMetaData metaData = (OXQFunctionMetaData)locator.getExtension();
                QName name = metaData.getName();
                int arity = metaData.getParameterTypes().length;
                if ("http://example.com/util".equals(name.getNamespaceURI()) &&
                    "trim".equals(name.getLocalPart()) && arity == 1) {
                    Method staticMethod = null;
                    try {
                        staticMethod = ResolveExternalFunction2.class.getMethod("trim", String.class);
                    } catch (NoSuchMethodException e) {
                        throw new IllegalStateException(e);
                    }
                }
                return new OXQEntity(staticMethod);
            }
            return null;
        }
    }

    public static void main(String[] args) throws IOException, XQException {
        OXQDataSource ds = new OXQDataSource();
        XQConnection con = ds.getConnection();
        OXQConnection ocon = OXQView.getConnection(con);
        ocon.setEntityResolver(new MyEntityResolver());

        FileInputStream query = new FileInputStream("trim.xq");
        XQPreparedExpression expr = con.prepareExpression(query);
        query.close();

        XQSequence result = expr.executeQuery();

        // Prints "<result>John Doe</result>"
        System.out.println(result.getSequenceAsString(null));

        result.close();
        expr.close();
        con.close();
    }
}

```

The example prints the same output as for [Example 7-6](#) (page 7-5): `<result>John Doe</result>`.

7.2.3 Resolution of Imported XQuery Modules

The entity resolver can locate the XQuery modules imported by an XQuery library module.

An XQuery library module provides functions and variables that can be imported by other modules. For each imported module, the entity resolver is called with the entity kind `oracle.xml.xquery.OXQEntityKind.MODULE`. Using the `oracle.xml.xquery.OXQEntityLocator` instance, you can invoke the `getSystemId()` method to get the location of the module being imported. If no location is provided in the module import, you can invoke the method `getNamespace()` to get the target namespace of the module. The entity resolver can then return the corresponding library module.

The example in this section shows how you can use an entity resolver to control the resolution of XQuery library modules.

[Example 7-8](#) (page 7-8) displays the contents of `math.xq`.

[Example 7-9](#) (page 7-8) displays the contents of `main.xq`.

[Example 7-10](#) (page 7-8) shows how to execute a query that imports a library module.

The query `main.xq` imports the library module `math.xq`, and then invokes the function `math:circumference` to compute the circumference of a circle.

Example 7-8 *math.xq*

```
module namespace math = "http://example.com/math";

declare variable $math:pi as xs:decimal := 3.14159265;

declare function math:circumference($diameter as xs:decimal) {
    $math:pi * $diameter
};
```

Example 7-9 *main.xq*

```
import module namespace math = "http://example.com/math" at "math.xq";

math:circumference(6.54)
```

Example 7-10 *Executing a Query that Imports a Library Module*

```
import java.io.File;
import java.io.FileInputStream;
import java.io.IOException;
import java.net.URI;

import javax.xml.xquery.XQConnection;
import javax.xml.xquery.XQException;
import javax.xml.xquery.XQPreparedExpression;
import javax.xml.xquery.XQSequence;
import javax.xml.xquery.XQStaticContext;

import oracle.xml.xquery.OXQConnection;
import oracle.xml.xquery.OXQDataSource;
import oracle.xml.xquery.OXQEntity;
import oracle.xml.xquery.OXQEntityKind;
import oracle.xml.xquery.OXQEntityLocator;
import oracle.xml.xquery.OXQEntityResolver;
import oracle.xml.xquery.OXQEntityResolverRequestOptions;
import oracle.xml.xquery.OXQView;
```



```

public class ResolveLibraryModule {

    private static class MyEntityResolver extends OXQEntityResolver {
        @Override
        public OXQEntity resolveEntity(OXQEntityKind kind, OXQEntityLocator locator,
            OXQEntityResolverRequestOptions options) throws IOException {
            if (kind == OXQEntityKind.MODULE) {
                URI systemId = locator.getSystemIdAsURI();
                if (systemId != null && "file".equals(systemId.getScheme())) {
                    File file = new File(systemId);
                    FileInputStream input = new FileInputStream(file);
                    OXQEntity result = new OXQEntity(input);
                    result.enlistCloseable(input);
                    return result;
                }
            }
            return null;
        }
    }

    public static void main(String[] args) throws XQException, IOException {
        OXQDataSource ds = new OXQDataSource();
        XQConnection con = ds.getConnection();

        // OXQView is used to access Oracle extensions on XQJ objects.
        OXQConnection ocon = OXQView.getConnection(con);
        ocon.setEntityResolver(new MyEntityResolver());

        File query = new File("main.xq");

        // Relative URIs are resolved against the base URI before invoking the entity resolver.
        // The relative URI 'math.xq' used in the query will be resolved against this URI.
        XQStaticContext ctx = con.getStaticContext();
        ctx.setBaseURI(query.toURI().toString());

        FileInputStream queryInput = new FileInputStream(query);
        XQPreparedExpression expr = con.prepareExpression(queryInput, ctx);
        queryInput.close();

        XQSequence result = expr.executeQuery();

        // Prints the result: "20.546015931"
        System.out.println(result.getSequenceAsString(null));

        result.close();
        expr.close();
        con.close();
    }
}

```

The example generates this output:

```
20.546015931
```

7.2.4 Resolution of XML Schemas Imported by an XQuery Query

You can use an entity resolver to control which XML schema is imported by an XQuery query.

An XQuery schema import imports type definitions and declarations of elements and attributes from an XML schema. You can use imported declarations and definitions in a query to validate and test data instances.

[Example 7-11](#) (page 7-10) displays the contents of XML schema file `size.xsd`.

[Example 7-12](#) (page 7-10) displays the contents of XQuery file `size.xq`.

[Example 7-13](#) (page 7-10) shows how to execute a query that imports a schema. `size.xq` uses the type `shirt-size` defined in `size.xsd` to test a list of values.

Example 7-11 `size.xsd`

```
<xs:schema
  xmlns:xs="http://www.w3.org/2001/XMLSchema"
  targetNamespace="http://example.com/size">

  <xs:simpleType name="shirt-size">
    <xs:restriction base="xs:string">
      <xs:enumeration value="XS"/>
      <xs:enumeration value="S"/>
      <xs:enumeration value="M"/>
      <xs:enumeration value="L"/>
      <xs:enumeration value="XL"/>
    </xs:restriction>
  </xs:simpleType>

</xs:schema>
```

Example 7-12 `size.xq`

```
import schema namespace ns = "http://example.com/size" at "size.xsd";

for $size in ("S", "big", "XL", 42)
return
  if ($size castable as ns:shirt-size) then
    ns:shirt-size($size)
  else
    concat("INVALID:", $size)
```

Example 7-13 *Executing an XQuery Query that Imports an XML Schema*

```
import java.io.File;
import java.io.FileInputStream;
import java.io.IOException;
import java.net.URI;

import javax.xml.xquery.XQConnection;
import javax.xml.xquery.XQException;
import javax.xml.xquery.XQPreparedExpression;
import javax.xml.xquery.XQSequence;
import javax.xml.xquery.XQStaticContext;

import oracle.xml.xquery.OXQConnection;
import oracle.xml.xquery.OXQDataSource;
import oracle.xml.xquery.OXQEntity;
import oracle.xml.xquery.OXQEntityKind;
import oracle.xml.xquery.OXQEntityLocator;
import oracle.xml.xquery.OXQEntityResolver;
import oracle.xml.xquery.OXQEntityResolverRequestOptions;
import oracle.xml.xquery.OXQView;

public class ResolveSchema {

  private static class MyEntityResolver extends OXQEntityResolver {
    @Override
    public OXQEntity resolveEntity(OXQEntityKind kind, OXQEntityLocator locator,
      OXQEntityResolverRequestOptions options) throws IOException {
      if (kind == OXQEntityKind.SCHEMA) {
        URI systemId = locator.getSystemIdAsURI();
        if (systemId != null && "file".equals(systemId.getScheme())) {
          File file = new File(systemId);
          FileInputStream input = new FileInputStream(file);

```

```

        OXQEntity result = new OXQEntity(input);
        result.enlistCloseable(input);
        return result;
    }
    }
    return null;
}
}

public static void main(String[] args) throws XQException, IOException {
    OXQDataSource ds = new OXQDataSource();
    XQConnection con = ds.getConnection();

    // OXQView is used to access Oracle extensions on XQJ objects.
    OXQConnection ocon = OXQView.getConnection(con);
    ocon.setEntityResolver(new MyEntityResolver());

    File query = new File("size.xq");

    // Relative URIs are resolved against the base URI before invoking the entity resolver.
    // The relative URI 'math.xq' used in the query will be resolved against this URI.
    XQStaticContext ctx = con.getStaticContext();
    ctx.setBaseURI(query.toURI().toString());

    FileInputStream queryInput = new FileInputStream(query);
    XQPreparedExpression expr = con.prepareExpression(queryInput, ctx);
    queryInput.close();

    XQSequence result = expr.executeQuery();

    // Prints "S INVALID:big XL INVALID:42"
    System.out.println(result.getSequenceAsString(null));

    result.close();
    expr.close();
    con.close();
}
}

```

The example prints this output: S INVALID:big XL INVALID:42.

7.2.5 Prefabricated Entity Resolvers for XQuery

XDK includes several implementations of `OXQEntityResolver` that you can use for common tasks such as file system and HTTP resolution. This can sometimes save you needing to implement your own entity resolver.

[Example 7-14](#) (page 7-12) shows how you can run the query in [Example 7-3](#) (page 7-3) using a prefabricated file resolver.

An instance of the factory `oracle.xml.xquery.OXQFileResolverFactory` is created from the connection. Then, this factory is used to create an entity resolver that resolves schemas, modules, and documents against the file system. By contrast with this example, [Example 7-4](#) (page 7-3) uses the custom entity resolver `MyEntityResolver` to resolve only documents against the file system.

XDK provides these entity resolver factories:

- `oracle.xml.xquery.OXQFileResolverFactory`: Creates an entity resolver that resolves 'file:' URIs for schema, module, and document locations.
- `oracle.xml.xquery.OXQHttpResolverFactory`: Creates an entity resolver that resolves 'http:' URIs for schema, module, and document locations.

- `oracle.xml.xquery.OXQCompositeResolverFactory`: Creates an entity resolver that delegates requests to other entity resolvers. For any kind of request, the resolver returns the first nonnull result it receives from one of the delegate resolvers.
- `oracle.xml.xquery.OXQJavaResolverFactory`: Creates an entity resolver that resolves external functions and modules to Java static methods or classes.

See Also:

Oracle Database XML Java API Reference, package `oracle.xml.xquery`, for API information about these factory interfaces

Example 7-14 Executing a Query with a Prefabricated File Resolver

```
import java.io.File;
import java.io.FileInputStream;
import java.io.IOException;

import javax.xml.xquery.XQConnection;
import javax.xml.xquery.XQException;
import javax.xml.xquery.XQPreparedExpression;
import javax.xml.xquery.XQSequence;
import javax.xml.xquery.XQStaticContext;

import oracle.xml.xquery.OXQConnection;
import oracle.xml.xquery.OXQDataSource;
import oracle.xml.xquery.OXQFileResolverFactory;
import oracle.xml.xquery.OXQView;

public class ResolverFactory {
    public static void main(String[] args) throws XQException, IOException {
        OXQDataSource ds = new OXQDataSource();
        XQConnection con = ds.getConnection();

        // OXQView is used to access Oracle extensions on XQJ objects.
        OXQConnection ocon = OXQView.getConnection(con);
        OXQFileResolverFactory factory = ocon.createEntityResolverFactory(OXQFileResolverFactory.class);
        ocon.setEntityResolver(factory.createResolver());

        File query = new File("books.xq");

        // Relative URIs are resolved against the base URI before invoking the entity resolver.
        // The relative URI 'books.xml' used in the query will be resolved against this URI.
        XQStaticContext ctx = con.getStaticContext();
        ctx.setBaseURI(query.toURI().toString());

        FileInputStream queryInput = new FileInputStream(query);
        XQPreparedExpression expr = con.prepareExpression(queryInput, ctx);
        queryInput.close();

        XQSequence result = expr.executeQuery();

        // Prints "<title>A Game of Thrones</title>"
        System.out.println(result.getSequenceAsString(null));

        result.close();
        expr.close();
        con.close();
    }
}
```

The example prints this output: `<title>A Game of Thrones</title>`.

7.2.6 Resolution of Other Types of Entity

You can use the XQJ entity resolver to obtain other entities, besides documents, schemas, modules, and external functions.

[Table 7-1](#) (page 7-13) describes these other entities.

Table 7-1 *Descriptions of Various Types of Entity*

OXQEntityKind	Description
TEXT	Result of <code>fn:unparsed-text</code> and <code>fn:unparsed-text-lines</code> .
ENVIRONMENT_VARIABLE	Result of <code>fn:available-environment-variables</code> and <code>fn:environment-variable</code> .
DOCUMENT_TYPE	Static type for function <code>fn:doc</code> .
COLLECTION	Documents returned by <code>fn:collection</code> .
URI_COLLECTION	URIs returned by <code>fn:uri-collection</code> .
XML_PARSER_FACTORY	StAX implementation used for parsing XML data.
XML_ENTITY	Used when a StAX parser needs to resolve an external XML resource.
UPD_PUT	Controls the behavior of <code>fn:put</code> .
COLLATION	Controls the behavior of collation URIs.

For details on how these entity types are used, see class `oracle.xml.xquery.OXQEntity` in *Oracle Database XML Java API Reference*.

7.3 XQuery Output Declarations

XQuery 3.0 defines output declarations, which you can use to set the values of serialization parameters from within a query.

An output declaration is an option declaration in namespace `http://www.w3.org/2010/xslt-xquery-serialization`. You use it in a query to declare and set serialization parameters on the static context.

By default, these static context serialization parameters are ignored, but they can be accessed using XQJ methods

`OXQPreparedExpression#getExpressionStaticContext()` and `OXQStaticContext#getSerializationParameters()`.

[Example 7-15](#) (page 7-14) shows how to access the values of option declarations.

You can also use an option declaration when serializing the result of a query.

[Example 7-16](#) (page 7-14) is similar to [Example 7-15](#) (page 7-14), but it uses the static context serialization parameters when serializing the result of the query.

Note: The URI value of option `output:parameter-document` is resolved to a document using entity resolver `OXQEntityResolver` and entity kind `OXQEntityKind#DOCUMENT` — see [Resolution of Other Types of Entity](#) (page 7-13).

See Also:

XQuery 3.0: An XML Query Language, section *Serialization*, at <http://www.w3.org/TR/xquery-30/#id-serialization>

Example 7-15 Accessing the Values of Option Declarations

```
import javax.xml.xquery.XQConnection;
import javax.xml.xquery.XQException;
import javax.xml.xquery.XQPreparedExpression;
import javax.xml.xquery.XQStaticContext;

import oracle.xml.xquery.OXQDataSource;
import oracle.xml.xquery.OXQPreparedExpression;
import oracle.xml.xquery.OXQSerializationParameters;
import oracle.xml.xquery.OXQStaticContext;
import oracle.xml.xquery.OXQView;

public class OptionDeclarations1 {

    public static void main(String[] args) throws XQException {
        OXQDataSource ds = new OXQDataSource();
        XQConnection con = ds.getConnection();
        String query =
            "declare option output:indent 'yes'; \n" +
            "declare option output:encoding 'UTF-16'; \n" +
            "<person><first>John</first><last>Doe</last></person>";

        XQPreparedExpression expr = con.prepareExpression(query);

        OXQPreparedExpression oexpr = OXQView.getPreparedExpression(expr);
        XQStaticContext ctx = oexpr.getExpressionStaticContext();
        OXQStaticContext octx = OXQView.getStaticContext(ctx);
        OXQSerializationParameters params = octx.getSerializationParameters();

        System.out.println("indent=" + params.isIndent());
        System.out.println("encoding=" + params.getEncoding());

        expr.close();
        con.close();
    }
}
```

This produces the following output:

```
indent=true
encoding=UTF-16
```

Example 7-16 Using Option Declarations When Serializing a Query Result

```
package oracle.xml.xquery.examples.published;

import javax.xml.xquery.XQConnection;
import javax.xml.xquery.XQException;
import javax.xml.xquery.XQPreparedExpression;
import javax.xml.xquery.XQResultSequence;
import javax.xml.xquery.XQStaticContext;

import oracle.xml.xquery.OXQDataSource;
import oracle.xml.xquery.OXQPreparedExpression;
```

```

import oracle.xml.xquery.OXQSerializationParameters;
import oracle.xml.xquery.OXQStaticContext;
import oracle.xml.xquery.OXQView;

public class OptionDeclarations2 {

    public static void main(String[] args) throws XQException {
        OXQDataSource ds = new OXQDataSource();
        XQConnection con = ds.getConnection();
        String query =
            "declare option output:indent 'yes'; \n" +
            "declare option output:omit-xml-declaration 'no'; \n" +
            "<person><first>John</first><last>Doe</last></person>";

        XQPreparedExpression expr = con.prepareExpression(query);

        OXQPreparedExpression oexpr = OXQView.getPreparedExpression(expr);
        XQStaticContext ctx = oexpr.getExpressionStaticContext();
        OXQStaticContext octx = OXQView.getStaticContext(ctx);
        OXQSerializationParameters params = octx.getSerializationParameters();

        XQResultSequence result = expr.executeQuery();
        result.writeSequence(System.out, params.createProperties());
        result.close();

        expr.close();
        con.close();
    }
}

```

This produces the following output:

```

<?xml version="1.0" encoding="UTF-8"?>
<person>
  <first>John</first>
  <last>Doe</last>
</person>

```

7.4 Improving Application Performance and Scalability with XQuery

The XDK XQuery processor provides several features for improving the performance and scalability of your application.

Topics:

- [Streaming Query Evaluation](#) (page 7-15)
- [External Storage](#) (page 7-17)
- [Thread Safety for XQJ](#) (page 7-18)

7.4.1 Streaming Query Evaluation

The XDK XQuery processor for Java supports streaming evaluation for many types of queries. Streaming evaluation requires a small amount of main memory, even when the input XML is very large.

To facilitate streaming evaluation, the following actions are recommended:

- Set the binding mode on the static context to deferred mode (see the method `javax.xml.xquery.XQStaticContext.setBindingMode(int)` in *Oracle*

Database XML Java API Reference). If the binding mode is not deferred, the input XML is fully materialized when it is bound.

- Provide the input XML as an instance of `java.io.InputStream`, `java.io.Reader`, or `javax.xml.stream.XMLStreamReader`. Input XML is provided to the query processor by binding it to the expression, or by returning it from an entity resolver.
- Ensure that the `javax.xml.xquery.XQSequence` instance is consumed in a way that does not require materialization:
 - The string serialization methods `getSequenceAsString(...)` and `getItemAsString(...)` produce data as a string that is held in memory. Instead, use the `writeSequence(...)` or the `writeItem(...)` method to serialize the sequence.
 - The `getNode()` method builds a Document Object Model (DOM) node that is held in memory. Instead, consider using the `getSequenceAsStream()` or the `getItemAsStream()` method to get a Streaming API for XML (StAX) stream.
 - The `getItem()` method copies and materializes the current item in memory. Instead, use methods directly on the `java.xml.xquery.XQSequence` instance to access the current item (see the interface `javax.xml.xquery.XQItemAccessor` in *Oracle Database XML Java API Reference*).

The code shown in this section invokes a query using XQJ in a way that does not prevent streaming evaluation.

[Example 7-17](#) (page 7-16) displays the contents of `books2.xq`.

[Example 7-18](#) (page 7-16) sets up the query to enable streaming evaluation. The example writes this output to file `results.xml`: `<title>A Game of Thrones</title>`.

The binding mode is set to the value `BINDING_MODE_DEFERRED` to avoid materializing `books.xml` when it is bound to the prepared expression. Likewise, the result is written to an output stream, and it is not materialized.

To simplify the example, the input file `books.xml` is small. Even if this file contained millions of books, evaluating the query would require only a small maximum heap size because only one book element is held in memory at one time. In contrast with the query `books.xq`, shown in [Example 7-3](#) (page 7-3), the query `books2.xq` does not require you to define an entity resolver. Both examples (`books.xq` and `books2.xq`) are streamable.

Example 7-17 `books2.xq`

```
declare variable $doc external;

for $book in $doc/books/book
where xs:decimal($book/price) gt 10.00
return
  $book/title
```

Example 7-18 *Facilitating Streaming Evaluation*

```
import java.io.FileInputStream;
import java.io.FileOutputStream;
import java.io.IOException;

import javax.xml.namespace.QName;
```



```

import javax.xml.xquery.XQConnection;
import javax.xml.xquery.XQConstants;
import javax.xml.xquery.XQException;
import javax.xml.xquery.XQPreparedExpression;
import javax.xml.xquery.XQSequence;
import javax.xml.xquery.XQStaticContext;

import oracle.xml.xquery.OXQDataSource;

public class Streaming {

    public static void main(String[] args) throws XQException, IOException {
        OXQDataSource ds = new OXQDataSource();
        XQConnection con = ds.getConnection();

        XQStaticContext ctx = con.getStaticContext();
        ctx.setBindingMode(XQConstants.BINDING_MODE_DEFERRED);
        con.setStaticContext(ctx);

        FileInputStream input = new FileInputStream("books.xml");
        FileInputStream query = new FileInputStream("books2.xq");
        FileOutputStream output = new FileOutputStream("result.xml");

        XQPreparedExpression expr = con.prepareExpression(query);
        query.close();
        expr.bindDocument(new QName("doc"), input, null, null);

        XQSequence result = expr.executeQuery();

        // Writes "<title>A Game of Thrones</title>" to file results.xml
        result.writeSequence(output, null);

        result.close();
        input.close();
        output.close();
        expr.close();
        con.close();
    }
}

```

7.4.2 External Storage

Depending on the query, the processor might have to store part of the input XML in main memory during query evaluation.

For example, this scenario can occur in cases such as these:

- A sequence is sorted.
- The value bound to a variable is used multiple times.
- A path expression uses a reverse-axis step.

To reduce memory usage in such cases, you can configure the XQuery processor to use external storage for materializing XML, rather than main memory. To enable the use of external storage, set the data source property `OXQConstants.USE_EXTERNAL_STORAGE` to `true`, and set an `oracle.xml.scalable.PageManager` instance on the dynamic context.

Note:

Using external storage can significantly reduce the amount of main memory that is consumed during query processing. However, it can also reduce performance.

Example 7-19 (page 7-18) shows how to enable the XQuery processor to use disk-based storage rather than main memory when XML is materialized. The example writes this output to file `results.xml`: `<title>A Game of Thrones</title>`.

Example 7-19 *Configuring the XQuery Processor to Use External Storage*

```
import java.io.File;
import java.io.FileInputStream;
import java.io.FileOutputStream;
import java.io.IOException;

import javax.xml.namespace.QName;
import javax.xml.xquery.XQConnection;
import javax.xml.xquery.XQConstants;
import javax.xml.xquery.XQException;
import javax.xml.xquery.XQPreparedExpression;
import javax.xml.xquery.XQSequence;
import javax.xml.xquery.XQStaticContext;

import oracle.xml.scalable.FilePageManager;
import oracle.xml.xquery.OXQDataSource;
import oracle.xml.xquery.OXQPreparedExpression;
import oracle.xml.xquery.OXQView;

public class ExternalStorage {

    public static void main(String[] args) throws XQException, IOException {
        OXQDataSource ds = new OXQDataSource();
        ds.setProperty(OXQDataSource.USE_EXTERNAL_STORAGE, "true");

        XQConnection con = ds.getConnection();
        XQStaticContext ctx = con.getStaticContext();
        ctx.setBindingMode(XQConstants.BINDING_MODE_DEFERRED);
        con.setStaticContext(ctx);

        FileInputStream input = new FileInputStream("books.xml");
        FileInputStream query = new FileInputStream("books2.xq");
        FileOutputStream output = new FileOutputStream("results.xml");

        XQPreparedExpression expr = con.prepareExpression(query);
        query.close();
        expr.bindDocument(new QName("doc"), input, null, null);

        // Set a page manager that will be used by the XQuery processor if XML needs to be materialized
        OXQPreparedExpression oexpr = OXQView.getPreparedExpression(expr);
        File temporaryFile = File.createTempFile("books", ".pagefile");
        temporaryFile.deleteOnExit();
        oexpr.setPageManager(new FilePageManager(temporaryFile.getAbsolutePath()));

        XQSequence result = expr.executeQuery();

        // Writes to file results.xml: "<title>A Game of Thrones</title>"
        result.writeSequence(output, null);

        result.close();
        input.close();
        output.close();
        expr.close();
        con.close();
    }
}
```

7.4.3 Thread Safety for XQJ

The Oracle implementation of XQJ is not thread-safe. For example, an instance of `javax.xml.xquery.XQSequence` must be accessed by only one thread. However, a

restricted form of thread safety is supported for managing instances of `javax.xml.xquery.XQConnection`.

- An instance of `XQConnection` serves as a factory for creating instances of `XQExpression`, `XQPreparedExpression`, `XQItem`, `XQSequence`, `XQItemType`, and `XQSequenceType`. One thread can manage the creation of these objects for use by other threads. For example, `XQPreparedExpression` instances created in one thread by the same connection can be used in other threads. Each `XQPreparedExpression` instance, however, must be executed by only one thread. Any user-defined implementations of `oracle.xml.xquery.OXQEntityResolver` that are specified must be thread-safe when expressions from the same connection are evaluated concurrently.
- Method `XQConnection.close()` closes all `XQExpression` and `XQPreparedExpression` instances that were obtained from the connection. Closing those instances closes all `XQResultSequence` and `XQResultItem` instances obtained from the expressions. Method `XQConnection.close()` can be called while expressions obtained from the connection are being processed in other threads. In that case, all registered resources held by the expressions (such as `java.io.InputStream` and `java.io.Reader`) are closed. This contract assumes that all registered resources support a thread-safe close method. For example, many JDK implementations of `java.io.Closeable` satisfy this requirement. But, many implementations of `javax.xml.stream.XMLStreamReader` do not provide a thread-safe close method. Implementations without this support can give unpredictable results if they are closed while a second thread is still reading (see interface `oracle.xml.xquery.OXQCloseable` in *Oracle Database XML Java API Reference*).

See Also:

Oracle Database XML Java API Reference, method `oracle.xml.xquery.OXQConnection.copyExpression(XQPreparedExpression)`

7.5 Performing Updates

XDK extends XQJ with the ability to execute updating queries. XML documents can be read as an instance of `javax.xml.xquery.XQItem`, and then modified using XQuery Update Facility extensions.

This feature is disabled by default. You can enable it by setting the update mode on the dynamic context to `oracle.xml.xquery.OXQConstants.UPDATE_MODE_ENABLED`.

Documents to be updated must be bound in deferred mode (see method `javax.xml.xquery.XQStaticContext.setBindingMode(int)` in *Oracle Database XML Java API Reference*). If the binding mode is not set to deferred, the input bindings are copied before query execution. Thus, only the copy is updated.

The example in this section shows how you can modify an XML document using the XQuery Update Facility.

[Example 7-20](#) (page 7-20) displays the contents of `configuration.xml`.

[Example 7-21](#) (page 7-20) displays the contents of `update.xq`.

[Example 7-22](#) (page 7-20) displays the contents of `configuration.xml` after an update.

[Example 7-23](#) (page 7-21) shows how to execute the query `update.xq`.

In the example, these actions occur:

1. The XML file `configuration.xml` is read as an instance of `javax.xml.xquery.XQItem`.
2. The item is bound to the prepared expression for the query `update.xq`.
3. The query `update.xq` is executed.
4. The modified document is written to the file `configuration.xml`.

See Also:

- <http://www.w3.org/TR/xquery-update-10/> for information about XQuery Update Facility 1.0
 - *Oracle Database XML Java API Reference*, interface `oracle.xml.xquery.OXQDynamicContext`
-
-

Example 7-20 configuration.xml

```
<configuration>
  <property>
    <name>hostname</name>
    <value>example.com</value>
  </property>
  <property>
    <name>timeout</name>
    <value>1000</value>
  </property>
</configuration>
```

Example 7-21 update.xq

```
declare variable $doc external;

let $timeout := $doc/configuration/property[name eq "timeout"]
return
  replace value of node $timeout/value
  with 2 * xs:integer($timeout/value)
```

Example 7-22 Updated File configuration.xml

```
<configuration>
  <property>
    <name>hostname</name>
    <value>example.com</value>
  </property>
  <property>
    <name>timeout</name>
    <value>2000</value>
  </property>
</configuration>
```

Example 7-23 Executing the Updating Query `update.xq`

```

import java.io.FileInputStream;
import java.io.IOException;
import java.io.FileOutputStream;

import javax.xml.namespace.QName;
import javax.xml.xquery.XQConnection;
import javax.xml.xquery.XQConstants;
import javax.xml.xquery.XQException;
import javax.xml.xquery.XQItem;
import javax.xml.xquery.XQPreparedExpression;
import javax.xml.xquery.XQStaticContext;

import oracle.xml.xquery.OXQConstants;
import oracle.xml.xquery.OXQDataSource;
import oracle.xml.xquery.OXQView;

public class UpdateDocument {
    public static void main(String[] args) throws XQException, IOException {
        OXQDataSource ds = new OXQDataSource();
        XQConnection con = ds.getConnection();

        XQStaticContext ctx = con.getStaticContext();
        // Set the binding mode to deferred so the document
        // item is not copied when it is bound.
        ctx.setBindingMode(XQConstants.BINDING_MODE_DEFERRED);
        con.setStaticContext(ctx);

        FileInputStream input = new FileInputStream("configuration.xml");
        XQItem doc = con.createItemFromDocument(input, null, null);
        input.close();

        System.out.println("Before update: \n" + doc.getItemAsString(null));

        FileInputStream query = new FileInputStream("update.xq");
        XQPreparedExpression expr = con.prepareExpression(query);
        query.close();
        expr.bindItem(new QName("doc"), doc);
        // Enable updates (disabled by default)
        OXQView.getDynamicContext(expr).setUpdateMode(OXQConstants.UPDATE_MODE_ENABLED);
        expr.executeQuery();

        System.out.println("After update: \n" + doc.getItemAsString(null));

        // Write the modified document back to the file
        FileOutputStream out = new FileOutputStream("configuration.xml");
        doc.writeItem(out, null);

        expr.close();
        con.close();
    }
}

```

7.6 Oracle XQuery Functions and Operators

Oracle supports the standard XQuery functions and operators, as well as some Oracle-specific functions.

The standard XQuery functions and operators are specified in <http://www.w3.org/TR/xpath-functions-30/>. See [Standards and Specifications for the XQuery Processor for Java](#) (page 7-29) for Oracle XML Developer's Kit (XDK) support of XQuery.

Oracle-specific XQuery functions use namespace `http://xmlns.oracle.com/xdk/xquery/function`. Namespace prefix `ora-fn` is predeclared, and the module is automatically imported.

- [Oracle XQuery Functions for Duration, Date, and Time](#) (page 7-22)
- [Oracle XQuery Functions for Strings](#) (page 7-26)

7.6.1 Oracle XQuery Functions for Duration, Date, and Time

You can manipulate durations, dates, and times in XQuery using Oracle XQuery functions.

The Oracle XQuery functions are in namespace `http://xmlns.oracle.com/xdk/xquery/function`. Namespace prefix `ora-fn` is predeclared, and the module is automatically imported.

- [ora-fn:date-from-string-with-format](#) (page 7-22)
- [ora-fn:date-to-string-with-format](#) (page 7-22)
- [ora-fn:dateTime-from-string-with-format](#) (page 7-23)
- [ora-fn:dateTime-to-string-with-format](#) (page 7-24)
- [ora-fn:time-from-string-with-format](#) (page 7-24)
- [ora-fn:time-to-string-with-format](#) (page 7-25)

7.6.1.1 ora-fn:date-from-string-with-format

This Oracle XQuery function returns a new date value from a string according to a given pattern.

Signature

```
ora-fn:date-from-string-with-format($format as xs:string?,  
                                   $dateString as xs:string?,  
                                   $locale as xs:string*)  
                                   as xs:date?
```

```
ora-fn:date-from-string-with-format($format as xs:string?,  
                                   $dateString as xs:string?)  
                                   as xs:date?
```

Parameters

`$format`: The pattern; see [Format Argument](#) (page 7-25)

`$dateString`: An input string that represents a date

`$locale`: A one- to three-field value that represents the locale; see [Locale Argument](#) (page 7-25)

Example

This example returns the specified date in the current time zone:

```
ora-fn:date-from-string-with-format("yyyy-MM-dd G", "2013-06-22 AD")
```

7.6.1.2 ora-fn:date-to-string-with-format

This Oracle XQuery function returns a date string with a given pattern.

Signature

```
ora-fn:date-to-string-with-format($format as xs:string?,
                                $date as xs:date?,
                                *$locale as xs:string?)
                                as xs:string?
```

```
ora-fn:date-to-string-with-format($format as xs:string?,
                                $date as xs:date?)
                                as xs:string?
```

Parameters

\$format: The pattern; see [Format Argument](#) (page 7-25)

\$date: The date

\$locale: A one- to three-field value that represents the locale; see [Locale Argument](#) (page 7-25)

Example

This example returns the string 2013-07-15:

```
ora-fn:date-to-string-with-format("yyyy-mm-dd", xs:date("2013-07-15"))
```

7.6.1.3 ora-fn:dateTime-from-string-with-format

This Oracle XQuery function returns a new date-time value from an input string, according to a given pattern.

Signature

```
ora-fn:dateTime-from-string-with-format($format as xs:string?,
                                       $dateTimeString as xs:string?,
                                       $locale as xs:string?)
                                       as xs:dateTime?
```

```
ora-fn:dateTime-from-string-with-format($format as xs:string?,
                                       $dateTimeString as xs:string?)
                                       as xs:dateTime?
```

Parameters

\$format: The pattern; see [Format Argument](#) (page 7-25)

\$dateTimeString: The date and time

\$locale: A one- to three-field value that represents the locale; see [Locale Argument](#) (page 7-25)

Examples

This example returns the specified date and 11:04:00AM in the current time zone:

```
ora-fn:dateTime-from-string-with-format("yyyy-MM-dd 'at' hh:mm",
                                       "2013-06-22 at 11:04")
```

The next example returns the specified date and 12:00:00AM in the current time zone:

```
ora-fn:dateTime-from-string-with-format("yyyy-MM-dd G",
                                       "2013-06-22 AD")
```

7.6.1.4 ora-fn:dateTime-to-string-with-format

This Oracle XQuery function returns a date and time string with a given pattern.

Signature

```
ora-fn:dateTime-to-string-with-format($format as xs:string?,
                                     $dateTime as xs:dateTime?,
                                     $locale as xs:string?)
                                     as xs:string?
```

```
ora-fn:dateTime-to-string-with-format($format as xs:string?,
                                     $dateTime as xs:dateTime?)
                                     as xs:string?
```

Parameters

`$format`: The pattern; see [Format Argument](#) (page 7-25)

`$dateTime`: The date and time

`$locale`: A one- to three-field value that represents the locale; see [Locale Argument](#) (page 7-25)

Examples

This example returns the string 07 JAN 2013 10:09 PM AD:

```
ora-fn:dateTime-to-string-with-format("dd MMM yyyy hh:mm a G",
                                     xs:dateTime("2013-01-07T22:09:44"))
```

The next example returns the string "01-07-2013":

```
ora-fn:dateTime-to-string-with-format("MM-dd-yyyy",
                                     xs:dateTime("2013-01-07T22:09:44"))
```

7.6.1.5 ora-fn:time-from-string-with-format

This Oracle XQuery function returns a new time value from an input string, according to a given pattern.

Signature

```
ora-fn:time-from-string-with-format($format as xs:string?,
                                    $timeString as xs:string?,
                                    $locale as xs:string?)
                                    as xs:time?
```

```
ora-fn:time-from-string-with-format($format as xs:string?,
                                    $timeString as xs:string?)
                                    as xs:time?
```

Parameters

`$format`: The pattern; see [Format Argument](#) (page 7-25)

`$timeString`: The time

`$locale`: A one- to three-field value that represents the locale; see [Locale Argument](#) (page 7-25)

Example

This example returns 9:45:22 PM in the current time zone:

```
ora-fn:time-from-string-with-format("HH.mm.ss", "21.45.22")
```

The next example returns 8:07:22 PM in the current time zone:

```
fn-bea:time-from-string-with-format("hh:mm:ss a", "8:07:22 PM")
```

7.6.1.6 ora-fn:time-to-string-with-format

This Oracle XQuery function returns a time string with a given pattern.

Signature

```
ora-fn:time-to-string-with-format($format as xs:string?,
                                $time as xs:time?,
                                $locale as xs:string?)
                                as xs:string?
```

```
ora-fn:time-to-string-with-format($format as xs:string?, $time as xs:time?) as
xs:string?
```

Parameters

`$format`: The pattern; see [Format Argument](#) (page 7-25)

`$time`: The time

`$locale`: A one- to three-field value that represents the locale; see [Locale Argument](#) (page 7-25)

Examples

This example returns the string "10:09 PM":

```
ora-fn:time-to-string-with-format("hh:mm a", xs:time("22:09:44"))
```

The next example returns the string "22:09 PM":

```
ora-fn:time-to-string-with-format("HH:mm a", xs:time("22:09:44"))
```

7.6.1.7 Format Argument

The `$format` argument identifies the various fields that compose a date or time value.

See Also:

The `SimpleDateFormat` class in the *Java Standard Edition 7 Reference* at <http://docs.oracle.com/javase/7/docs/api/java/text/SimpleDateFormat.html>

7.6.1.8 Locale Argument

The `$locale` represents a specific geographic, political, or cultural region.

It is defined by up to three fields:

1. **Language code:** The ISO 639 alpha-2 or alpha-3 language code, or the registered language subtags of up to eight letters. For example, `en` for English and `ja` for Japanese.
2. **Country code:** The ISO 3166 alpha-2 country code or the UN M.49 numeric-3 area code. For example, `US` for the United States and `029` for the Caribbean.
3. **Variant:** Indicates a variation of the locale, such as a particular dialect. Order multiple values in order of importance and separate them with an underscore (`_`). These values are case sensitive.

See Also:

- The `Locale` class in *Java Standard Edition 7 Reference* at <http://docs.oracle.com/javase/7/docs/api/java/util/Locale.html>
 - All language, country, and variant codes in the Internet Assigned Numbers Authority (IANA) Language Subtag Registry at <http://www.iana.org/assignments/language-subtag-registry/language-subtag-registry>
-
-

7.6.2 Oracle XQuery Functions for Strings

You can manipulate strings in XQuery using Oracle XQuery functions.

The Oracle XQuery functions are in namespace `http://xmlns.oracle.com/xdk/xquery/function`. Namespace prefix `ora-fn` is predeclared, and the module is automatically imported.

- [ora-fn:pad-left](#) (page 7-26)
- [ora-fn:pad-right](#) (page 7-27)
- [ora-fn:trim](#) (page 7-28)
- [ora-fn:trim-left](#) (page 7-28)
- [ora-fn:trim-right](#) (page 7-29)

7.6.2.1 ora-fn:pad-left

Adds padding characters to the left of a string to create a fixed-length string. If the input string exceeds the specified size, then it is truncated to return a substring of the specified length. The default padding character is a space (ASCII 32).

Signature

```
ora-fn:pad-left($str as xs:string?,  
               $size as xs:integer?,  
               $pad as xs:string?)  
as xs:string?
```

```
ora-fn:pad-left($str as xs:string?,  
               $size as xs:integer?)  
as xs:string?
```

Parameters

`$str`: The input string

`$size`: The desired fixed length, which is obtained by adding padding characters to `$str`

`$pad`: The padding character

If either argument is an empty sequence, then the function returns an empty sequence.

Examples

This example prefixes "01" to the input string up to the maximum of six characters. The returned string is "010abc". The function returns one complete and one partial pad character.

```
ora-fn:pad-left("abc", 6, "01")
```

The example returns only "ab" because the input string exceeds the specified fixed length:

```
ora-fn:pad-left("abcd", 2, "01")
```

This example prefixes spaces to the string up to the specified maximum of six characters. The returned string has a prefix of two spaces: " abcd":

```
ora-fn:pad-left("abcd", 6)
```

The next example returns only "ab" because the input string exceeds the specified fixed length:

```
ora-fn:pad-left("abcd", 2)
```

7.6.2.2 ora-fn:pad-right

Adds padding characters to the right of a string to create a fixed-length string. If the input string exceeds the specified size, then it is truncated to return a substring of the specified length. The default padding character is a space (ASCII 32).

Signature

```
ora-fn:pad-right($str as xs:string?,
                 $size as xs:integer?,
                 $pad as xs:string?)
as xs:string?
```

```
ora-fn:pad-right($str as xs:string?,
                 $size as xs:integer?)
as xs:string?
```

Parameters

`$str`: The input string

`$size`: The desired fixed length, which is obtained by adding padding characters to `$str`

`$pad`: The padding character

If either argument is an empty sequence, then the function returns an empty sequence.

Examples

This example appends "01" to the input string up to the maximum of six characters. The returned string is "abc010". The function returns one complete and one partial pad character.

```
ora-fn:pad-right("abc", 6, "01")
```

This example returns only "ab" because the input string exceeds the specified fixed length:

```
ora-fn:pad-right("abcd", 2, "01")
```

This example appends spaces to the string up to the specified maximum of six characters. The returned string has a suffix of two spaces: "abcd ":

```
ora-fn:pad-right("abcd", 6)
```

The next example returns only "ab" because the input string exceeds the specified fixed length:

```
ora-fn:pad-right("abcd", 2)
```

7.6.2.3 ora-fn:trim

Removes any leading or trailing white space from a string.

Signature

```
ora-fn:trim($input as xs:string?) as xs:string?
```

Parameters

`$input`: The string to trim. If `$input` is an empty sequence, then the function returns an empty sequence. Other data types trigger an error.

Example

This example returns the string "abc":

```
ora-fn:trim(" abc ")
```

7.6.2.4 ora-fn:trim-left

Removes any leading white space.

Signature

```
ora-fn:trim-left($input as xs:string?) as xs:string?
```

Parameters

`$input`: The string to trim. If `$input` is an empty sequence, then the function returns an empty sequence. Other data types trigger an error.

Example

This example removes the leading spaces and returns the string "abc ":

```
ora-fn:trim-left(" abc ")
```

7.6.2.5 ora-fn:trim-right

Removes any trailing white space.

Signature

```
ora-fn:trim-right($input as xs:string?) as xs:string?
```

Parameters

`$input`: The string to trim. If `$input` is an empty sequence, then the function returns an empty sequence. Other data types trigger an error.

Example

This example removes the trailing spaces and returns the string " abc":

```
ora-fn:trim-left(" abc ")
```

7.7 Standards and Specifications for the XQuery Processor for Java

The standards and specifications to which the XDK XQuery processor for Java conforms are listed.

- XQuery 3.0:

<http://www.w3.org/TR/xquery-30/>

Note: All XQuery 1.0 level features are supported. XQuery 3.0 level features are supported except for the following: FLWOR window clause, FLWOR count clause, namespace constructors, decimal format declarations, `fn:format-number`, `fn:format-integer`, `fn:format-date`, `fn:format-time`, `fn:path`, and higher order XQuery functions.

- XQuery Update Facility 1.0:

<http://www.w3.org/TR/xquery-update-10/>

- XML Syntax for XQuery 3.0 (XQueryX):

<http://www.w3.org/TR/xqueryx-30/>

- JSR 225: XQuery API for Java (XQJ):

<https://jcp.org/aboutJava/communityprocess/final/jsr225/index.html>

Note:

The XDK XQuery processor for Java is not interoperable with other XQJ implementations, including the Oracle XQJ implementation for Oracle XML DB. (See JSR-225: XQuery API for Java for the meaning of *interoperable*.)

This section includes these subsections:

- [Optional XQuery Features](#) (page 7-30)

- [Implementation-Defined Items](#) (page 7-30)

7.7.1 Optional XQuery Features

The XQuery specification defines certain features as optional. Those that are supported by XDK are listed, together with the standards that specify them.

Table 7-2 XQuery Optional Features Supported by XDK

Feature	For more information
Schema import	http://www.w3.org/TR/xquery-30/#dt-schema-import
Schema validation	http://www.w3.org/TR/xquery-30/#id-validate
Static typing	http://www.w3.org/TR/xquery-30/#id-static-typing-feature http://www.w3.org/TR/xquery-update-10/#id-update-static
Full axis support	http://www.w3.org/TR/xquery-30/#id-full-axis-feature
Modules	http://www.w3.org/TR/xquery-30/#id-module-feature
Serialization	http://www.w3.org/TR/xquery-30/#id-serialization-feature

7.7.2 Implementation-Defined Items

The XQJ and XQuery specifications leave the definition of certain aspects up to the implementation. The implementation-defined items for XDK are described briefly.

[Table 7-3](#) (page 7-30) summarizes the XQJ implementation-defined items.

Table 7-3 XQJ Implementation-Defined Items

Description	Behavior
Class name of <code>XQDataSource</code> implementation	<code>oracle.xml.xquery.OXQDataSource</code> .
Properties defined on <code>OXQDataSource</code>	None. The username and password are silently ignored.
JDBC connection support	JDBC connections are not supported.
Commands	Not supported.
Cancelling of query execution with method <code>XQPreparedExpression.cancel()</code>	Yes.
Serialization	Yes.
Additional StAX or SAX events	None.
User-defined schema types	Yes.
Node identity, document order, and full-node context preservation when a node is bound to an external variable	Not preserved.

Table 7-3 (Cont.) XQJ Implementation-Defined Items

Description	Behavior
Login timeout	Not supported.
Transactions	Not supported. An exception is thrown if a transaction method is called.
<code>XQItemAccessor.getNodeUri()</code> method behavior if the input node is not a document node	Exception.
<code>XQItemType.getTypeName()</code> method for anonymous types	A unique name.
<code>XQItemType.getSchemaURI()</code> method	The schema URI is returned when a type is created from XQJ. No otherwise.
<code>XQDataFactory.createItemFromDocument()</code> and <code>bindDocument()</code> methods if the input is not a well-formed XML document	Exception.
Additional error codes returned by class <code>XQQueryException</code>	The qualified names of Oracle-specific error codes are in the namespace <code>http://xmlns.oracle.com/xdk/xquery/errors</code> .
<code>ConnectionPoolXQDataSource</code> , <code>PooledXQConnection</code> , <code>XQConnectionEvent</code> , <code>XQConnectionEventListener</code> interfaces	No.
<code>XQDataSource.getConnection(java.sql.Connection)</code>	JDBC connections are not supported. An exception is thrown if this method is called.
<code>XQDataSource.getConnection(java.lang.String, java.lang.String)</code>	Same as <code>getConnection()</code> . Parameters are ignored.

Note:

XDK support for the features in [Table 7-3](#) (page 7-30) differs from the Oracle XML DB support for them.

[Table 7-4](#) (page 7-31) summarizes the XQuery implementation-defined items.

Table 7-4 XQuery Implementation-Defined Items

Item	Behavior
The version of Unicode that is used to construct expressions	Depends on the version of Java used. Different Java versions support different versions of Unicode.
The statically-known collations	Unicode codepoint collation and collations derived from classes <code>java.text.Collator</code> or <code>oracle.i18n.text.OraCollator</code> .
The implicit time zone.	Uses the default time zone, as determined by method <code>java.util.Calendar.getInstance()</code> .

Table 7-4 (Cont.) XQuery Implementation-Defined Items

Item	Behavior
The circumstances in which warnings are raised, and the ways in which warnings are handled	None.
The method by which errors are reported to the external processing environment	Exception <code>javax.xml.xquery.XQException</code> .
Whether the implementation is based on the rules of XML 1.0 and XML Names, or the rules of XML 1.1 and XML Names 1.1	1.0.
Any components of the static context or dynamic context that are overwritten or augmented by the implementation	See Table 7-6 (page 7-35).
Which of the optional axes are supported by the implementation, if the Full-Axis Feature is not supported	Full support.
The default handling of empty sequences returned by an ordering key (sortspec) in an order by clause (empty least or empty greatest)	least.
The names and semantics of any extension expressions (pragmas) recognized by the implementation	None.
The names and semantics of any option declarations recognized by the implementation	None.
Protocols (if any) by which parameters can be passed to an external function, and the result of the function can be returned to the invoking query	Defined by XQJ.
The process by which the specific modules to be imported by a module import are identified, if the Module feature is supported (includes processing of location hints, if any)	Entity resolvers. See XQJ Entity Resolution (page 7-2).
Any static typing extensions supported by the implementation, if the Static Typing feature is supported	Strict mode (based on subtype) and optimistic mode (based on type intersection). Optimistic mode is the default.
The means by which serialization is invoked, if the Serialization feature is supported	Defined by XQJ.
The default values for the <code>byte-order-mark</code> , <code>encoding</code> , <code>media-type</code> , <code>normalization-form</code> , <code>omit-xml-declaration</code> , <code>standalone</code> , and <code>version</code> parameters, if the Serialization feature is supported	See the interface <code>oracle.xml.xquery.OXQSerializationParameters</code> in <i>Oracle Database XML Java API Reference</i> .
Limits on ranges of values for various data types.	Decimal and integer values have arbitrary precision.

Table 7-4 (Cont.) XQuery Implementation-Defined Items

Item	Behavior
The signatures of functions provided by the implementation or via an implementation-defined API (see the XQuery standard, section 2.1.1, <i>Static Context</i>).	See Oracle XQuery Functions and Operators (page 7-21).
Any environment variables provided by the implementation.	Entity resolvers. See XQJ Entity Resolution (page 7-2).
Any rules used for static typing (see the XQuery standard, section 2.2.3.1, <i>Static Analysis Phase</i>).	Defaults to optimistic, pessimistic configurable.
Any serialization parameters provided by the implementation (see the XQuery standard, section 2.2.4 <i>Serialization</i>).	See <code>OXQSerializationParameters</code> . See <i>Oracle Database XML Java API Reference</i> .
The means by which the location hint for a serialization parameter document identifies the corresponding XDM instance (see the XQuery standard, section 2.2.4, <i>Serialization</i>).	Entity resolvers, <code>OXQEntityKind.DOCUMENT</code> . See XQJ Entity Resolution (page 7-2).
What error, if any, is returned if an external function's implementation does not return the declared result type (see the XQuery standard, section 2.2.5, <i>Consistency Constraints</i>).	XPTY0004.
Any annotations defined by the implementation, and their associated behavior (see the XQuery standard, section 4.15, <i>Annotations</i>).	<p>You can use <code>%ora-fn:context-item</code> to allow the context item of a function caller to be implicitly passed as the first argument to the function.</p> <p>For example, this query evaluates to <code>e, f, g</code>:</p> <pre> declare %ora-fn:context-item function local:foo(\$arg as node()) { node-name(\$arg) }; (<e/>, <f/>)/local:foo(), local:foo(<g/>) </pre>
Any function assertions defined by the implementation.	None.
The effect of function assertions understood by the implementation on section 2.5.6.3. The judgment subtype-assertions (<code>AnnotationsA</code> , <code>AnnotationsB</code>).	Not applicable.
Any implementation-defined variables defined by the implementation. (see the XQuery standard, section 3.1.2, <i>Variable References</i>).	None.
The ordering associated with <code>fn:unordered</code> in the implementation (see the XQuery standard, section 3.11, <i>Ordered and Unordered Expressions</i>).	It does not change the order of the input sequence.
Any additional information provided for <code>try/catch</code> by variable <code>err:additional</code> (see the XQuery standard, section 3.15, <i>Try/Catch Expressions</i>).	None.

Table 7-4 (Cont.) XQuery Implementation-Defined Items

Item	Behavior
The default boundary-space policy (see the XQuery standard, section 4.3, <i>Boundary-space Declaration</i>).	strip.
The default collation (see the XQuery standard, section 4.4, <i>Default Collation Declaration</i>).	Unicode.
The default base URI (see the XQuery standard, section 4.5, <i>Base URI Declaration</i>).	None.

[Table 7-5](#) (page 7-34) summarizes the XQuery Update Facility implementation-defined items.

Table 7-5 XQuery Update Facility Implementation-Defined Items

Item	Behavior
The revalidation modes that are supported by this implementation.	skip.
The default revalidation mode for this implementation.	skip.
The mechanism (if any) by which an external function can return an XDM instance, or a pending update list, or both to the invoking query.	Returning a pending update list from an external function is not supported.
The semantics of <code>fn:put()</code> , including the kinds of nodes accepted as operands by this function.	Any node type is accepted. Storage of the node is determined by the entity resolver. See class <code>oracle.xml.xquery.OXQEntity</code> in <i>Oracle Database XML Java API Reference</i> , specifically the documentation for entity kind <code>UPD_PUT</code> .

[Table 7-6](#) (page 7-35) summarizes the default initial values for the static context.

Table 7-6 Default Initial Values for the Static Context

Context Component	Default Value
Statically known namespaces	<p>err=http://w3.org/2005/xqt-errors fn=http://www.w3.org/2005/xpath-functions local=http://www.w3.org/2005/xquery-local-functions math=http://www.w3.org/2005/xpath-functions/math ora-ext=http://xmlns.oracle.com/xdk/xquery/extension ora-java=http://xmlns.oracle.com/xdk/xquery/java ora-xml=http://xmlns.oracle.com/xdk/xquery/xml ora-fn=http://xmlns.oracle.com/xdk/xquery/function output=http://www.w3.org/2010/xslt-xquery-serialization xml=http://www.w3.org/XML/1998/namespace xs=http://www.w3.org/2001/XMLSchema xsi=http://www.w3.org/2001/XMLSchema-instance</p> <p>Prefixes that begin with ora- are reserved for use by Oracle. Additional prefixes that begin with ora- may be added to the default statically known namespaces in a future release.</p>
Default element/type namespace	No namespace.
Default function namespace	fn.
In-scope schema types	Built-in types in xs.
In-scope element declarations	None.
In-scope attribute declarations	None.
In-scope variables	None.
Context item static type	item().
Function signatures	Functions in namespace fn, and constructors for built-in atomic types.
Statically known collations	Unicode codepoint collation and collations derived from class <code>java.text.Collator</code> or <code>oracle.i18n.text.OraCollator</code> .
Default collation	Unicode codepoint collation: http://www.w3.org/2005/xpath-functions/collation/codepoint .
Construction mode	preserve.
Ordering mode	ordered.
Default order for empty sequences	least.
Boundary-space policy	strip.
Copy-namespaces mode	preserve, no-inherit.
Base URI	As defined in the standard.

Table 7-6 (Cont.) Default Initial Values for the Static Context

Context Component	Default Value
Statically known documents	None.
Statically known collections	None.
Statically known default collection type	<code>node () *</code> .
Serialization parameters	Same as the defaults for <code>OXQSerializationParameters</code> . See <i>Oracle Database XML Java API Reference</i> .

Using XQuery API for Java to Access Oracle XML DB

An explanation is given of how to use the XQuery API for Java (XQJ) to access Oracle XML DB.

Topics:

- [Introduction to Oracle XML DB Support for XQJ](#) (page 8-1)
- [Examples: Using XQJ to Query Oracle XML DB](#) (page 8-2)
- [XQJ Support for Oracle XML DB](#) (page 8-5)
- [XQJ Performance Considerations for Use with Oracle XML DB](#) (page 8-8)

8.1 Introduction to Oracle XML DB Support for XQJ

XQuery API for Java (XQJ), also known as JSR-225, provides an industry-standard way for Java programs to access Extensible Markup Language (XML) data using XQuery. It lets you evaluate XQuery expressions against XML data sources and process the results as XML data.

Oracle provides two XQuery engines for evaluating XQuery expressions: one in Oracle XML DB, for use with XML data in the database, and one in Oracle XML Developer's Kit (XDK), for use with XML data outside the database. (See [Using the XQuery Processor for Java](#) (page 7-1) for information about the XQuery engine for XDK).

Oracle provides two different XQJ implementations for accessing these two XQuery engines. Both implementations are part of XDK, enabling you to use XDK to access XML data with a standard XQJ API whether that data resides in the database or elsewhere.

The queries executed by XQJ are written in standard World Wide Web Consortium (W3C) XQuery 1.0 language, as supported by Oracle XML DB. A typical use case for this feature is to access XML data stored in remote databases (in Oracle XML DB) from a local Java program.

General information about XQuery and XQJ is documented outside of this document.

See Also:

- *Oracle XML DB Developer's Guide* for more information about Oracle XML DB, including details about XQuery capabilities and support in Oracle XML DB
- XQuery Packages in *Oracle Database XML Java API Reference* for the related API documentation
- <http://www.w3.org/TR/xquery/> for information about XQuery 1.0: An XML Query Language (Second Edition)
- JSR-000225 XQuery API for Java (XQJ) (Final Release), <https://jcp.org/aboutJava/communityprocess/final/jsr225/index.html>

This specification is very concrete, with understandable examples.

8.1.1 Prerequisites for Using XQJ to Access Oracle XML DB

You need Java Runtime Environment 1.6 to use XQJ with Oracle XML DB. You also need certain Java Archive (JAR) files to be either in your CLASSPATH environment variable or passed using command-line option `classpath`.

The JAR files are as follows:

- The required JAR files listed in [Introduction to the XQuery Processor for Java](#) (page 7-1)
- `jdbc/lib/ojdbc6.jar`
- `rdbms/jlib/xdm6.jar`

The directory paths for these JAR files are relative to the `ORACLE_HOME` directory of your database installation.

8.2 Examples: Using XQJ to Query Oracle XML DB

Examples here show how you can use XQJ to query and retrieve data in Oracle XML DB.

Example 8-1 (page 8-4) shows how to use XQJ to query data from a table in Oracle XML DB. It uses the `WAREHOUSES` table in the Order Entry (OE) database sample schema. The OE sample schema contains XML documents with warehouse information in the `WAREHOUSES` table. The `WAREHOUSES` table contains an `XMLType` column `warehouse_spec` and other columns. (See the discussion about standard database schemas in *Oracle XML DB Developer's Guide* for more information about the data used in this example.)

Specifically, **Example 8-1** (page 8-4) shows how to perform these steps:

1. Get an XQJ connection to Oracle XML DB.
Every program using XQJ to connect to Oracle XML DB must first create an `OXQDDataSource` object. Then, `OXQDDataSource` must be initialized with the required property values before getting an XQJ connection to the Oracle XML DB instance.
2. Prepare an XQuery expression.

3. Submit the XQuery expression for evaluation.
4. Print each item in the resulting XQuery sequence.

In [Example 8-1](#) (page 8-4), the XQuery expression accesses the `WAREHOUSES` table through the use of the Universal Resource Identifier (URI) scheme `oradb`. (See the discussion about the URI scheme `oradb` in *Oracle XML DB Developer's Guide* for more information about using XQuery with XML DB to query table or view data.)

[Example 8-1](#) (page 8-4) also shows how to bind external variable values in XQJ. The query has an external variable `$x`, which is used to filter the returned rows from the `WAREHOUSES` table, by `WAREHOUSE_ID`.

[Example 8-1](#) (page 8-4) generates this output (reformatted for better readability):

```
<Warehouse><Building>Owned</Building><Area>25000</Area><Docks>2</Docks>
  <DockType>Rearload</DockType><WaterAccess>Y</WaterAccess>
  <RailAccess>N</RailAccess><Parking>Street</Parking>
  <VClearance>10 ft</VClearance></Warehouse>

<Warehouse><Building>Rented</Building><Area>50000</Area><Docks>1</Docks>
  <DockType>Sideload</DockType><WaterAccess>Y</WaterAccess>
  <RailAccess>N</RailAccess><Parking>Lot</Parking>
  <VClearance>12 ft</VClearance></Warehouse>
```

[Example 8-2](#) (page 8-4) shows how to use XQJ to retrieve data from the Oracle XML DB repository. This example assumes that two files, `depts.xml` and `emps.xml`, have been uploaded into the XML DB repository under the folder `/public`. For example, you can use FTP to upload the two files into the Oracle XML DB repository. (See the discussion about using the Oracle XML DB repository in *Oracle XML DB Developer's Guide* for more information about storing data in and using the Oracle XML DB Repository.)

The content of `depts.xml` is:

`depts.xml`:

```
<?xml version="1.0"?>
  <depts>
    <dept deptno="10" dname="Administration"/>
    <dept deptno="20" dname="Marketing"/>
    <dept deptno="30" dname="Purchasing"/>
  </depts>
```

The content of `emps.xml` is:

`emps.xml`:

```
<?xml version="1.0"?>
  <emps>
    <emp empno="1" deptno="10" ename="John" salary="21000"/>
    <emp empno="2" deptno="10" ename="Jack" salary="310000"/>
    <emp empno="3" deptno="20" ename="Jill" salary="100001"/>
  </emps>
```

You can use the `fn:doc` and `fn:collection` functions to query the data in the Oracle XML DB repository with XQuery. [Example 8-2](#) (page 8-4) shows how to use the `fn:doc` function within XQuery to access the repository. (See the discussion about querying XML data in the Oracle XML DB repository in *Oracle XML DB Developer's Guide* for more information about using these XQuery functions.)

[Example 8-2](#) (page 8-4) generates this output:

```
<emp ename="Jack" dept="Administration"/>
<emp ename="Jill" dept="Marketing"/>
```

Example 8-1 Using XQJ to Query an XML DB Table with XQuery

```
import oracle.xml.xquery.xqjdb.OXQDDataSource;

import javax.xml.xquery.XQItemType;
import javax.xml.xquery.XQResultSequence;
import javax.xml.xquery.XQConnection;
import javax.xml.xquery.XQPreparedExpression;
import javax.xml.namespace.QName;

public class example1
{
    public static void main(String argv[])
    {
        try
        {
            // Create a new OXQDDataSource for connecting to Oracle XML DB
            OXQDDataSource oxqDS = new OXQDDataSource();
            // Set appropriate connection information for the database instance.
            // Must use the thin driver
            oxqDS.setProperty("driver", "jdbc:oracle:thin");
            oxqDS.setProperty("dbusername", "oe");
            oxqDS.setProperty("dbpassword", "oe");
            // Machine hostname
            oxqDS.setProperty("dbserver", "myserver");
            // Database instance port number
            oxqDS.setProperty("dbport", "6479");
            // Database instance port number
            oxqDS.setProperty("serviceName", "mydbinstance");
            XQConnection conn = oxqDS.getConnection();
            XQItemType itemTypeInt = conn.createAtomicType(XQItemType.XQBASETYPE_INT);
            XQPreparedExpression expr = conn.prepareExpression("declare variable $x as
                xs:int external; for $i in fn:collection('oradb:/OE/WAREHOUSES') where
                $i/ROW/WAREHOUSE_ID < $x return $i/ROW/WAREHOUSE_SPEC/Warehouse");
            expr.bindInt(new QName("x"), 3, itemTypeInt);
            XQResultSequence xqSeq = expr.executeQuery();
            while (xqSeq.next())
                System.out.println (xqSeq.getItemAsString(null));
        }
        catch (Exception e)
        {
            e.printStackTrace();
        }
    }
}
```

Example 8-2 Using XQJ to Query the XML DB Repository with XQuery

```
import oracle.xml.xquery.xqjdb.OXQDDataSource;

import javax.xml.xquery.XQItemType;
import javax.xml.xquery.XQResultSequence;
import javax.xml.xquery.XQConnection;
import javax.xml.xquery.XQPreparedExpression;
import javax.xml.namespace.QName;

public class example2
{
    public static void main(String argv[])
```



```

{
  try
  {
    // Create a new OXQDDataSource for connecting to Oracle XML DB
    OXQDDataSource oxqDS = new OXQDDataSource();
    // Set appropriate connection information for the database instance.
    // Must use the thin driver
    oxqDS.setProperty("driver", "jdbc:oracle:thin");
    oxqDS.setProperty("dbusername", "oe");
    oxqDS.setProperty("dbpassword", "oe");
    // Machine hostname
    oxqDS.setProperty("dbserver", "myserver");
    // Database instance port number
    oxqDS.setProperty("dbport", "6479");
    // Database instance port number
    oxqDS.setProperty("serviceName", "mydbinstance");
    XQConnection conn = oxqDS.getConnection();
    XQPreparedExpression expr = conn.prepareExpression("for $e in
      doc(\"/public/emp.xml\")/emp/emp let $d :=
      doc(\"/public/depts.xml\")//dept[@deptno = $e/@deptno]/@dname where
      $e/@salary > 100000 order by $e/@empno return
      <emp ename=\"{$e/@ename}\" dept=\"{$d}\"/>");
    XQResultSequence xqSeq = expr.executeQuery();
    while (xqSeq.next())
      System.out.println (xqSeq.getItemAsString(null));
  }
  catch (Exception e)
  {
    e.printStackTrace();
  }
}

```

8.3 XQJ Support for Oracle XML DB

The two Oracle XQJ implementations differ in some respects. Oracle XML DB support for XQJ is described.

[Using the XQuery Processor for Java](#) (page 7-1) provides information about using XQJ to access the mid-tier XQuery engine.

[Table 8-1](#) (page 8-5) describes the OXQDDataSource properties to be used for connection to Oracle XML DB. To create an XQJ connection to Oracle XML DB, you must set the values for these properties. You must set either the `dbName` or the `serviceName` property value, and all the other OXQDDataSource property values listed in [Table 8-1](#) (page 8-5).

Table 8-1 OXQDDataSource Properties

Property	Value	Get Method	Set Method
<code>driver</code>	<code>jdbc:oracle:thin</code>	<code>getDriver</code>	<code>setDriver</code>
<code>dbusername</code>	Database schema (user) name	<code>getDBUserName</code>	<code>setDBUserName</code>
<code>dbpassword</code>	Password for database schema	<code>getDBPassword</code>	<code>setDBPassword</code>
<code>dbserver</code>	Host name for the database instance	<code>getDBServer</code>	<code>setDBServer</code>

Table 8-1 (Cont.) OXQDDataSource Properties

Property	Value	Get Method	Set Method
dbport	Port number of the database instance for XQJ connection	getDBPort	setDBPort
dbname	Database instance name (service id) ¹	getDBName	setDBName
serviceName	Service name ¹	getServiceName	setServiceName

¹ You can identify the database using either the service id or the service name.

[Table 8-2](#) (page 8-6) describes the Oracle XML DB support for optional XQJ features.

Note:

Oracle XML DB support for some XQJ features differs from their support by the mid-tier XQuery engine. In particular, the Oracle XML DB XQJ implementation does not support the use of user-defined types.

Table 8-2 Oracle XML DB Support for Optional XQJ Features

XQJ Feature	Oracle XML DB Support
Class name of XQDataSource implementation	oracle.xml.xquery.xqjdb.OXQDDataSource
JDBC connections	Not supported.
Properties defined on OXQDDataSource (connection information)	See Table 8-1 (page 8-5).
Commands	Not supported.
XQPreparedExpression.cancel (cancelling of query execution)	Not supported.
Serialization	Only parameter method with value xml and parameter encoding with value UTF-8 or UTF-16.
Additional StAX and SAX events	Not supported.
User-defined schema types	Not supported.
Node identity, document order, and full-node context preservation when a node is bound to an external variable	Not supported.
Login timeout	Not supported.
Transactions	Not supported.
Behavior of XQItemAccessor method getNodeUri() when the input node is not a document node	Return NULL.
Behavior of XQItemType method getTypeName() for anonymous types	Return false.

Table 8-2 (Cont.) Oracle XML DB Support for Optional XQJ Features

XQJ Feature	Oracle XML DB Support
Behavior of <code>XQItemType</code> method <code>getSchemaURI()</code>	Return <code>NULL</code> or the schema URI provided during type creation. Currently, the Oracle XML DB XQJ implementation does not use the schema URI to get type information, and user-defined types are not supported.
Behavior of <code>XQDataFactory</code> methods <code>createItemFromDocument()</code> and <code>bindDocument()</code> if the input is not a well-formed XML document	Raise an exception.
Additional error codes returned from <code>XQQueryException</code>	Not supported.
Interfaces <code>ConnectionPoolXQDataSource</code> , <code>PooledXQConnection</code> , <code>XQConnectionEvent</code> , <code>XQConnectionEventListener</code>	Not supported.
<code>XQDataSource.getConnection(java.sql.Connection)</code>	Not supported. (JDBC connections are not supported.)
<code>XQDataSource.getConnection(java.lang.String, java.lang.String)</code>	Same as <code>getConnection()</code> with no arguments: the arguments are ignored.

See Also:

Oracle XML DB Developer's Guide for information about using the XQuery language with Oracle XML DB

8.3.1 Other Oracle XML DB XQJ Support Limitations

The limitations of Oracle XML DB support for XQJ are described. None of them apply to mid-tier XQuery engine support for XQJ.

Oracle XML DB support for XQJ is limited in these ways:

- All Oracle XML DB XQuery support limitations apply to Oracle XML DB support for XQJ as well.
- Only the XDK Document Object Model (DOM) is supported. Use of any other DOM can cause errors.
- Do not expect the Oracle XML DB XQJ implementation to be interoperable with another XQJ implementation, including the XDK Java implementation of XQJ. (See the XQJ standard (JSR-225) for the meaning of "interoperable".)
- `XQDataSource` methods `getLogWriter` and `setLogWriter` have no effect (they are ignored).

- XQStaticContent methods `getBoundarySpacePolicy`, `setBoundarySpacePolicy`, `getDefaultCollation`, and `setDefaultCollation` have no effect (they are ignored).
- The copy namespaces mode for XQStaticContent methods `setCopyNamespacesModPreserve` and `setCopyNamespacesModeInherit` has no effect (it is ignored). The values used are always `preserve` and `inherit`, respectively.
- Use of XQDynamicContext methods to bind DocumentFragment objects is not supported.
- Values of type `xs:duration` are not supported. Using an XQDynamicContext method to bind `xs:duration`, or accessing an `xs:duration` value, raises an error.
- The year of a `xs:date`, `xs:dateTime`, `xs:gYear`, and `xs:gYearMonth` value must be from -4712 to 9999, inclusive. Using a year outside this range can raise an error or produce unpredictable results.

8.4 XQJ Performance Considerations for Use with Oracle XML DB

To fetch a sequence of items from the database, use `XQResultSequence` method `next()` to retrieve a single item at a time; then use an `XQItemAccessor` method to fetch all data corresponding to that item.

This provides better performance than using these whole-sequence fetch methods, which each materialize the entire sequence before returning any data.

- `getSequenceAsStream()`
- `getSequenceAsString(java.util.Properties props)`
- `writeSequence(java.io.OutputStream os, java.util.Properties props)`
- `writeSequence(java.io.Writer ow, java.util.Properties props)`
- `writeSequenceToResult(javax.xml.transform.Result result)`
- `writeSequenceToSAX(org.xml.sax.ContentHandler saxhdlr)`

For example, if you invoke `getSequenceAsStream()`, all of the XQuery result sequence data is fetched from the database before the `XMLStreamReader` instance that is built from it is returned to your program.

Be aware also that items themselves are not streamable: the item accessor methods always materialize an entire item before outputting any part of it.

For inputting, all bind methods defined on `XQDynamicContext` fully materialize the input data before passing it to the database.

For example, when you invoke `bindDocument(javax.xml.namespace.QName varName, javax.xml.stream.XMLStreamReader value, XQItemType type)`, all the data that is referenced by the input `XMLStreamReader` instance is processed before the external XQuery variable is bound to it.

Using the XML Schema Processor for Java

Topics here cover how to use the Extensible Markup Language (XML) schema processor for Java.

Topics:

- [Introduction to XML Validation](#) (page 9-1)
- [Using the XML Schema Processor: Overview](#) (page 9-7)
- [Validating XML with XML Schemas](#) (page 9-13)
- [Tips and Techniques for Programming with XML Schemas](#) (page 9-21)

9.1 Introduction to XML Validation

Topics cover the different techniques for XML validation.

Topics:

- [Prerequisites for Using the XML Schema Processor for Java](#) (page 9-1)
- [Standards and Specifications for the XML Schema Processor for Java](#) (page 9-2)
- [XML Validation with DTDs](#) (page 9-2)
- [XML Validation with XML Schemas](#) (page 9-3)
- [Differences Between XML Schemas and DTDs](#) (page 9-6)

9.1.1 Prerequisites for Using the XML Schema Processor for Java

Prerequisites for using the XML schema processor are covered.

This section assumes that you have working knowledge of these technologies:

- [document type definition \(DTD\)](#). An XML document type definition (DTD) defines the legal structure of an XML document.
- [XML Schema language](#). XML Schema defines the legal structure of an XML document.

To learn more about these technologies, consult the XML resources in [Related Documents](#) (page xxix).

See Also:

- http://www.w3schools.com/xml/xml_dtd_intro.asp for a DTD tutorial
 - http://www.w3schools.com/xml/schema_intro.asp for an XML Schema language tutorial
-

9.1.2 Standards and Specifications for the XML Schema Processor for Java

XML Schema is a World Wide Web Consortium (W3C) standard.

You can find the XML Schema specifications at these locations:

- <http://www.w3.org/TR/xmlschema-0/> for the W3C XML Schema Primer
- <http://www.w3.org/TR/xmlschema-1/> for the definition of the XML Schema language structures
- <http://www.w3.org/TR/xmlschema-2/> for the definition of the XML Schema language data types

The Oracle XML Schema processor supports the W3C XML Schema specifications.

See Also:

[Oracle XML Developer's Kit Standards](#) (page 33-1) for a summary of the standards supported by Oracle XML Developer's Kit (XDK)

9.1.3 XML Validation with DTDs

Document type definition (DTDs) were originally developed for SGML. XML DTDs are a subset of those available in SGML and provide a mechanism for declaring constraints on XML markup. XML DTDs enable the specification of:

- Which elements can be in your XML documents.
- The content model of an XML element, that is, whether the element contains only data or has a set of subelements that defines its structure. DTDs can define whether a subelement is optional or mandatory and whether it can occur only once or multiple times.
- Attributes of XML elements. DTDs can also specify whether attributes are optional or mandatory.
- Entities that are legal in your XML documents.

An XML DTD is not itself written in XML, but is a context-independent grammar for defining the structure of an XML document. You can declare a DTD in an XML document itself or in a separate file from the XML document.

Validation is the process by which you verify an XML document against its associated DTD, ensuring that the structure, use of elements, and use of attributes are consistent with the definitions in the DTD. Thus, applications that handle XML documents can assume that the data matches the definition.

Using XDK, you can write an application that includes a validating XML parser; that is, a program that parses and validates XML documents against a DTD. Depending on its implementation, a validating parser may:

- Either stop processing when it encounters an error, or continue.
- Either report warnings and errors as they occur or in summary form at the end of processing.
- Enable or disable validation mode

Most processors can enable or disable validation mode, but they must still process entity definitions and other constructs of DTDs.

9.1.3.1 DTD Samples in XDK

An example DTD is shown, together with an example XML document that conforms to that DTD.

Example 9-1 (page 9-3) shows the contents of a DTD named `family.dtd`, which is located in `$ORACLE_HOME/xdk/demo/java/parser/common/`. The `<ELEMENT>` tags specify the legal nomenclature and structure of elements in the document, whereas the `<ATTLIST>` tags specify the legal attributes of elements.

Example 9-2 (page 9-3) shows the contents of an XML document named `family.xml`, which is also located in `$ORACLE_HOME/xdk/demo/java/parser/common/`. The `<!DOCTYPE>` element in `family.xml` specifies that this XML document conforms to the external DTD named `family.dtd`.

Example 9-1 *family.dtd*

```
<?xml version="1.0" encoding="UTF-8"?>
<!ELEMENT family (member*)>
<!ATTLIST family lastname CDATA #REQUIRED>
<!ELEMENT member (#PCDATA)>
<!ATTLIST member memberid ID #REQUIRED>
<!ATTLIST member dad IDREF #IMPLIED>
<!ATTLIST member mom IDREF #IMPLIED>
```

Example 9-2 *family.xml*

```
<?xml version="1.0" standalone="no"?>
<!DOCTYPE family SYSTEM "family.dtd">
<family lastname="Smith">
<member memberid="m1">Sarah</member>
<member memberid="m2">Bob</member>
<member memberid="m3" mom="m1" dad="m2">Joanne</member>
<member memberid="m4" mom="m1" dad="m2">Jim</member>
</family>
```

9.1.4 XML Validation with XML Schemas

Concepts involving validation using XML schemas are introduced.

The [XML Schema language](#), also known as [XML Schema Definition](#), was created by the W3C to use XML syntax to describe the content and the structure of XML documents. An [XML schema](#) is an XML document written in the XML Schema language. An XML schema document contains rules describing the structure of an input XML document, called an [instance document](#). An instance document is valid if and only if it conforms to the rules of the XML schema.

The XML Schema language defines such things as:

- Which elements and attributes are legal in the instance document
- Which elements can be children of other elements
- The order and number of child elements
- Data types for elements and attributes
- Default and fixed values for elements and attributes

A validating XML parser tries to determine whether an instance document conforms to the rules of its associated XML schema. Using XDK you can write a validating parser that performs this schema validation. Depending on its implementation, a validating parser may:

- Either stop processing when it encounters an error, or continue.
- Either report warnings and errors as they occur or in summary form at the end of processing.

The processor must consider entity definitions and other constructs that are defined in a DTD that is included by the instance document. The XML Schema language does not define what must occur when an instance document includes both an XML schema and a DTD. Thus, the behavior of the application in such cases depends on the implementation.

9.1.4.1 XML Schema Samples in XDK

A sample XML document is shown which contains a purchase report that describes parts that have been ordered in different regions. This document is located at `$ORACLE_HOME/xdk/demo/java/schema/report.xml`. An XML schema document, `report.xsd`, which you can use to validate `report.xml`, is also shown.

Among other things, the XML schema defines the names of the elements that are legal in the instance document and the type of data that the elements can contain.

Example 9-3 *report.xml*

```
<purchaseReport
  xmlns="http://www.example.com/Report"
  xmlns:xsi="http://www.w3.org/2001/XMLSchema-instance"
  xsi:schemaLocation="http://www.example.com/Report report.xsd"
  period="P3M" periodEnding="1999-12-31">
  <regions>
    <zip code="95819">
      <part number="872-AA" quantity="1"/>
      <part number="926-AA" quantity="1"/>
      <part number="833-AA" quantity="1"/>
      <part number="455-BX" quantity="1"/>
    </zip>
    <zip code="63143">
      <part number="455-BX" quantity="4"/>
    </zip>
  </regions>
  <parts>
    <part number="872-AA">Lawnmower</part>
    <part number="926-AA">Baby Monitor</part>
    <part number="833-AA">Lapis Necklace</part>
    <part number="455-BX">Sturdy Shelves</part>
  </parts>
</purchaseReport>
```

Example 9-4 report.xsd

```

<schema targetNamespace="http://www.example.com/Report"
        xmlns="http://www.w3.org/2001/XMLSchema"
        xmlns:r="http://www.example.com/Report"
        elementFormDefault="qualified">
  <annotation>
    <documentation xml:lang="en">
      Report schema for Example.com
      Copyright 2000 Example.com. All rights reserved.
    </documentation>
  </annotation>
  <element name="purchaseReport">
    <complexType>
      <sequence>
        <element name="regions" type="r:RegionsType">
          <keyref name="dummy2" refer="r:pNumKey">
            <selector xpath="r:zip/r:part"/>
            <field xpath="@number"/>
          </keyref>
        </element>
        <element name="parts" type="r:PartsType"/>
      </sequence>
      <attribute name="period" type="duration"/>
      <attribute name="periodEnding" type="date"/>
    </complexType>
    <unique name="dummy1">
      <selector xpath="r:regions/r:zip"/>
      <field xpath="@code"/>
    </unique>
    <key name="pNumKey">
      <selector xpath="r:parts/r:part"/>
      <field xpath="@number"/>
    </key>
  </element>
  <complexType name="RegionsType">
    <sequence>
      <element name="zip" maxOccurs="unbounded">
        <complexType>
          <sequence>
            <element name="part" maxOccurs="unbounded">
              <complexType>
                <complexContent>
                  <restriction base="anyType">
                    <attribute name="number" type="r:SKU"/>
                    <attribute name="quantity" type="positiveInteger"/>
                  </restriction>
                </complexContent>
              </complexType>
            </element>
          </sequence>
          <attribute name="code" type="positiveInteger"/>
        </complexType>
      </element>
    </sequence>
  </complexType>
  <simpleType name="SKU">
    <restriction base="string">
      <pattern value="\d{3}-[A-Z]{2}"/>
    </restriction>
  </simpleType>

```

```

<complexType name="PartsType">
  <sequence>
    <element name="part" maxOccurs="unbounded">
      <complexType>
        <simpleContent>
          <extension base="string">
            <attribute name="number" type="r:SKU"/>
          </extension>
        </simpleContent>
      </complexType>
    </element>
  </sequence>
</complexType>
</schema>

```

9.1.5 Differences Between XML Schemas and DTDs

The XML Schema language includes most of the capabilities of the DTD specification. An XML schema serves a similar purpose to a DTD, but is more flexible in specifying document constraints.

[Table 9-1](#) (page 9-6) compares some features between the two validation mechanisms.

Table 9-1 Feature Comparison Between XML Schema and DTD

Feature	XML Schema	DTD
Element nesting	X	X
Element occurrence constraints	X	X
Permitted attributes	X	X
Attribute types and default values	X	X
Written in XML	X	
Namespace support	X	
Built-In data types	X	
User-Defined data types	X	
Include/Import	X	
Refinement (inheritance)	X	

These reasons are probably the most persuasive for choosing XML schema validation over DTD validation:

- The XML Schema language enables you to define rules for the *content* of elements and attributes. You achieve control over content by using data types. With XML Schema data types you can more easily perform actions such as:
 - Declare which elements are to contain which types of data, for example, positive integers in one element and years in another
 - Process data obtained from a database

- Define restrictions on data, for example, a number between 10 and 20
- Define data formats, for example, dates in the form MM-DD-YYYY
- Convert data between different data types, for example, strings to dates
- Unlike DTD grammar, documents written in the XML Schema language are themselves written in XML. Thus, you can perform these actions:
 - Use your XML parser to parse your XML schema
 - Process your XML schema with the XML Document Object Model (DOM)
 - Transform your XML document with Extensible Stylesheet Language Transformation (XSLT)
 - Reuse your XML schemas in other XML schemas
 - Extend your XML schema by adding elements and attributes
 - Reference multiple XML schemas from the same document

9.2 Using the XML Schema Processor: Overview

The Oracle XML Schema processor is a SAX-based XML schema validator that you can use to validate instance documents against an XML schema. The processor supports both language example (LAX) and strict validation.

You can use the processor in these ways:

- Enable it in the XML parser
- Use it with a DOM tree to validate whole or part of an XML document
- Use it as a component in a processing pipeline (like a content handler)

You can configure the schema processor in different ways depending on your requirements. For example, you can:

- Use a fixed XML schema or automatically build a schema based on the `schemaLocation` attributes in an instance document.
- Set `XMLError` and `entityResolver` to gain better control over the validation process.
- Determine how much of an instance document is to be validated. You can use any of the validation modes specified in [Table 4-1](#) (page 4-10). You can also designate a type of element as the root of validation.

9.2.1 Using the XML Schema Processor for Java: Basic Process

XDK packages that are important for applications that process XML schemas are described.

These are the important packages for applications that process XML schemas:

- `oracle.xml.parser.v2`, which provides APIs for XML parsing
- `oracle.xml.parser.schema`, which provides APIs for XML Schema processing

The most important classes in the `oracle.xml.parser.schema` package are described in [Table 9-2](#) (page 9-8). These form the core of most XML schema applications.

Table 9-2 *oracle.xml.parser.schema* Classes

Class/Interface	Description	Methods
XMLSchema class	Represents XML Schema component model. An XMLSchema object is a set of XMLSchemaNodes that belong to different target namespaces. The XSDValidator class uses XMLSchema for schema validation or metadata.	The principal methods are: <ul style="list-style-type: none"> • <code>get</code> methods such as <code>getElement()</code> and <code>getSchemaTargetNS()</code> get information about the XML schema • <code>printSchema()</code> prints information about the XML schema
XMLSchemaNode class	Represents schema components in a target namespace, including type definitions, element and attribute declarations, and group and attribute group definitions.	The principal methods are <code>get</code> methods such as <code>getElementSet()</code> and <code>getAttributeDeclarations()</code> get components of the XML schema.
XSDBuilder class	Builds an XMLSchema object from an XML schema document. The XMLSchema object is a set of objects (Infoset items) corresponding to top-level schema declarations and definitions. The schema document is XML parsed and converted to a DOM tree.	The principal methods are: <ul style="list-style-type: none"> • <code>build()</code> creates an XMLSchema object. • <code>getObject()</code> returns the XMLSchema object. • <code>setEntityResolver()</code> sets an EntityResolver for resolving imports and includes.
XSDValidator class	Validates an instance XML document against an XML schema. When registered, an XSDValidator object is inserted as a pipeline node between XMLParser and XMLDocument events handlers.	The principal methods are: <ul style="list-style-type: none"> • <code>get</code> methods such as <code>getCurrentMode()</code> and <code>getElementDeclaration()</code> • <code>set</code> methods such as <code>setXMLProperty()</code> and <code>setDocumentLocator()</code> • <code>startDocument()</code> receives notification of the beginning of the document. • <code>startElement()</code> receives notification of the beginning of the element.

[Figure 9-1](#) (page 9-9) depicts the basic process of validating an instance document with the XML Schema processor for Java.

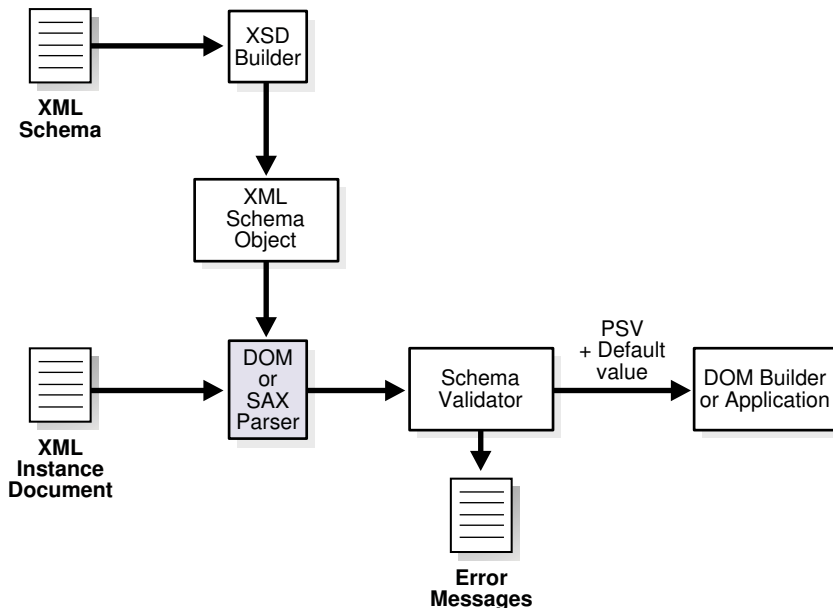
Figure 9-1 XML Schema Processor for Java

The XML Schema processor performs these major tasks:

1. A builder (`XSDBuilder` object) assembles the XML schema from an input XML schema document. Although instance documents and schemas need not exist specifically as files on the operating system, they are commonly referred to as files. They may exist as streams of bytes, fields in a database record, or collections of XML Infoset "Information Items."

This task involves parsing the schema document into an object. The builder creates the schema object explicitly or implicitly:

- In explicit mode, you pass in an XML schema when you invoke the processor. [Validating Against Externally Referenced XML Schemas](#) (page 9-15) explains how to build the schema object in explicit mode.
- In implicit mode, you do not pass in an XML schema when you invoke the processor because the schema is internally referenced by the instance document. [Validating Against Internally Referenced XML Schemas](#) (page 9-14) explains how to create the schema object in implicit mode.

2. The XML schema validator uses the schema object to validate the instance document. This task has these steps:
 - a. A Simple API for XML (SAX) parser parses the instance document into SAX events, which it passes to the validator.
 - b. The validator receives SAX events as input and validates them against the schema object, sending an error message if it finds invalid XML components. [Validation in the XML Parser](#) (page 4-9) describes the validation modes that you can use when validating the instance document. If you do not explicitly set a schema for validation with the `XSDBuilder` class, then the instance document must have the correct `xsi:schemaLocation` attribute pointing to the schema file. Otherwise, the program does not perform the validation. If the processor encounters errors, it generates error messages.

- c. The validator sends input SAX events, default values, or post-schema validation information to a DOM builder or application.

See Also:

- *Oracle Database XML Java API Reference* to learn about the `XSDBuilder`, `DOMParser`, and `SAXParser` classes
 - [Using the XML Schema Processor for Java](#) (page 9-1) to learn about the XDK SAX and DOM parsers
-
-

9.2.2 Running the XML Schema Processor Demo Programs

Demo programs for the XML Schema processor for Java are included in `$ORACLE_HOME/xdk/demo/java/schema`.

[Table 9-3](#) (page 9-10) describes the XML files and programs that you can use to test the XML Schema processor.

Table 9-3 XML Schema Sample Files

File	Description
<code>cat.xsd</code>	A sample XML schema used by the <code>XSDSetSchema.java</code> program to validate <code>catalogue.xml</code> . The <code>cat.xsd</code> schema specifies the structure of a catalogue of books.
<code>catalogue.xml</code>	A sample instance document that the <code>XSDSetSchema.java</code> program uses to validate against the <code>cat.xsd</code> schema.
<code>catalogue_e.xml</code>	A sample instance document used by the <code>XSDSample.java</code> program. When the program tries to validate this document against the <code>cat.xsd</code> schema, it generates schema errors.
<code>DTD2Schema.java</code>	This sample program converts a DTD (first argument) into an XML Schema and uses it to validate an XML file (second argument).
<code>embedded_xsql.xsd</code>	The XML schema used by <code>XSDLax.java</code> . The schema defines the structure of an XSQL page.
<code>embedded_xsql.xml</code>	The instance document used by <code>XSDLax.java</code> .
<code>juicer1.xml</code>	A sample XML document for use with <code>xsdproperty.java</code> . The XML schema that defines this document is <code>juicer1.xsd</code> .
<code>juicer1.xsd</code>	A sample XML schema for use with <code>xsdproperty.java</code> . This XML schema defines <code>juicer1.xml</code> .
<code>juicer2.xml</code>	A sample XML document for use with <code>xsdproperty.java</code> . The XML schema that defines this document is <code>juicer2.xsd</code> .
<code>juicer2.xsd</code>	A sample XML document for use with <code>xsdproperty.java</code> . This XML schema defines <code>juicer2.xml</code> .

Table 9-3 (Cont.) XML Schema Sample Files

File	Description
report.xml	The sample XML file that XSDSetSchema.java uses to validate against the XML schema report.xsd.
report.xsd	A sample XML schema used by the XSDSetSchema.java program to validate the contents of report.xml. The report.xsd schema specifies the structure of a purchase order.
report_e.xml	When the program validates this sample XML file using XSDSample.java, it generates XML Schema errors.
xsddom.java	This program shows how to validate an instance document by get a DOM representation of the document and using an XSDValidator object to validate it.
xsdent.java	This program validates an XML document by redirecting the referenced schema in the SchemaLocation attribute to a local version.
xsdent.xml	This XML document describes a book. The file is used as an input to xsdent.java.
xsdent.xsd	This XML schema document defines the rules for xsdent.xml. The schema document contains a schemaLocation attribute set to xsdent-1.xsd.
xsdent-1.xsd	The XML schema document referenced by the schemaLocation attribute in xsdent.xsd.
xsdproperty.java	This demo shows how to configure the XML Schema processor to validate an XML document based on a complex type or element declaration.
xsd sax.java	This demo shows how to validate an XML document received as a SAX stream.
XSDLax.java	This demo is the same as XSDSetSchema.java but sets the SCHEMA_LAX_VALIDATION flag for LAX validation.
XSDSample.java	This program is a sample driver that you can use to process XML instance documents.
XSDSetSchema.java	This program is a sample driver to process XML instance documents by overriding the schemaLocation. The program uses the XML Schema specification from cat.xsd to validate the contents of catalogue.xml.

Documentation for how to compile and run the sample programs is located in the README in the same directory. The basic steps are:

1. Change into the \$ORACLE_HOME/xdk/demo/java/schema directory (UNIX) or %ORACLE_HOME%\xdk\demo\java\schema directory (Windows).
2. Run make (UNIX) or Make.bat (Windows) at the command line.
3. Add xmlparserv2.jar, xschema.jar, and the current directory to the CLASSPATH. These JAR files are located in \$ORACLE_HOME/lib (UNIX) and

%ORACLE_HOME%\lib (Windows). For example, you can set the CLASSPATH with the tcsh shell on UNIX:

```
setenv CLASSPATH
"$CLASSPATH":$ORACLE_HOME/lib/xmlparserv2.jar:$ORACLE_HOME/lib/schema.jar:.
```

Note:

The XML Schema processor requires JDK version 1.2 or later, and it is usable on any operating system with Java 1.2 support.

4. Run the sample programs with the XML files that are included in the directory:

- These examples use `report.xsd` to validate the contents of `report.xml`:

```
java XSDSample report.xml
java XSDSetSchema report.xsd report.xml
```

- This example validates an instance document in Lax mode:

```
java XSDLax embedded_xsql.xsd embedded_xsql.xml
```

- These examples use `cat.xsd` to validate the contents of `catalogue.xml`:

```
java XSDSample catalogue.xml
java XSDSetSchema cat.xsd catalogue.xml
```

- These examples generates error messages:

```
java XSDSample catalogue_e.xml
java XSDSample report_e.xml
```

- This example uses the `schemaLocation` attribute in `xsdent.xsd` to redirect the XML schema to `xsdent-1.xsd` for validation:

```
java xsdent xsdent.xml xsdent.xsd
```

- This example generates a SAX stream from `report.xml` and validates it against the XML schema defined in `report.xsd`:

```
java xsdsax report.xsd report.xml
```

- This example creates a DOM representation of `report.xml` and validates it against the XML schema defined in `report.xsd`:

```
java xsddom report.xsd report.xml
```

- These examples configure validation starting with an element declaration or complex type definition:

```
java xsdproperty juicer1.xml juicer1.xsd http://www.juicers.org \
juicersType false > juicersType.out
```

```
java xsdproperty juicer2.xml juicer2.xsd http://www.juicers.org \
Juicers true > juicers_e.out
```

- This example converts a DTD (`dtd2schema.dtd`) into an XML schema and uses it to validate an instance document (`dtd2schema.xml`):

```
java DTD2Schema dtd2schema.dtd dtd2schema.xml
```

9.2.3 Using the XML Schema Processor Command-Line Utility

You can use the XML parser command-line utility (`oraxml`) to validate instance documents against XML schemas and DTDs.

[Using the Java XML Parser Command-Line Utility \(`oraxml`\)](#) (page 4-15) describes how to run `oraxml`.

9.2.3.1 Using `oraxml` to Validate Against a Schema

An example shows how you can validate document `report.xml` against the XML schema `report.xsd` by invoking `oraxml` on the command line.

Example 9-5 Using `oraxml` to Validate Against a Schema

Invoke this command in directory `$ORACLE_HOME/xdk/demo/java/schema`:

```
oraxml -schema -enc report.xml
```

The expected output is:

```
The encoding of the input file: UTF-8
The input XML file is parsed without errors using Schema validation mode.
```

9.2.3.2 Using `oraxml` to Validate Against a DTD

An example shows how you can validate document `family.xml` against the DTD `family.dtd` by invoking `oraxml` on the command line.

Example 9-6 Using `oraxml` to Validate Against a DTD

Invoke this command in directory `$ORACLE_HOME/xdk/demo/java/parser/common`:

```
oraxml -dtd -enc family.xml
```

The expected output is:

```
The encoding of the input file: UTF-8
The input XML file is parsed without errors using DTD validation mode.
```

9.3 Validating XML with XML Schemas

Topics cover various ways to validate XML documents using XML schemas.

Topics:

- [Validating Against Internally Referenced XML Schemas](#) (page 9-14)
- [Validating Against Externally Referenced XML Schemas](#) (page 9-15)
- [Validating a Subsection of an XML Document](#) (page 9-16)
- [Validating XML from a SAX Stream](#) (page 9-17)
- [Validating XML from a DOM](#) (page 9-18)
- [Validating XML from Designed Types and Elements](#) (page 9-19)

9.3.1 Validating Against Internally Referenced XML Schemas

`$ORACLE_HOME/xdk/demo/java/schema/XSDSample.java` shows how to validate against an implicit XML Schema. The validation mode is implicit because the XML schema is referenced in the instance document itself.

Follow the steps in this section to write programs that use the `setValidationMode()` method of the `oracle.xml.parser.v2.DOMParser` class:

1. Create a DOM parser to use for the validation of an instance document. this code fragment from `XSDSample.java` shows how to create the `DOMParser` object:

```
public class XSDSample
{
    public static void main(String[] args) throws Exception
    {
        if (args.length != 1)
        {
            System.out.println("Usage: java XSDSample <filename>");
            return;
        }
        process (args[0]);
    }

    public static void process (String xmlURI) throws Exception
    {
        DOMParser dp = new DOMParser();
        URL url = createURL(xmlURI);
        ...
    }
    ...
}
```

`createURL()` is a helper method that constructs a URL from a file name passed to the program as an argument.

2. Set the validation mode for the validating DOM parser with the `DOMParser.setValidationMode()` method. For example, `XSDSample.java` shows how to specify XML schema validation:

```
dp.setValidationMode(XMLParser.SCHEMA_VALIDATION);
dp.setPreserveWhitespace(true);
```

3. Set the output error stream with the `DOMParser.setErrorStream()` method. For example, `XSDSample.java` sets the error stream for the DOM parser object:

```
dp.setErrorStream (System.out);
```

4. Validate the instance document with the `DOMParser.parse()` method. You do not have to create an XML schema object explicitly because the schema is internally referenced by the instance document. For example, `XSDSample.java` validates the instance document:

```
try
{
    System.out.println("Parsing "+xmlURI);
    dp.parse(url);
    System.out.println("The input file <"+xmlURI+"> parsed without errors");
}
```

```

catch (XMLParseException pe)
{
    System.out.println("Parser Exception: " + pe.getMessage());
}
catch (Exception e)
{
    System.out.println("NonParserException: " + e.getMessage());
}

```

9.3.2 Validating Against Externally Referenced XML Schemas

`$ORACLE_HOME/xdk/demo/java/schema/XSDSetSchema.java` shows how to validate an XML schema explicitly. The validation mode is explicit because you use the `XSDBuilder` class to specify the schema to use for validation: the schema is not specified in the instance document as in implicit validation.

Follow the basic steps in this section to write Java programs that use the `build()` method of the `oracle.xml.parser.schema.XSDBuilder` class:

1. Build an XML schema object from the XML schema document with the `XSDBuilder.build()` method. This code fragment from `XSDSetSchema.java` shows how to create the object:

```

public class XSDSetSchema
{
    public static void main(String[] args) throws Exception
    {
        if (args.length != 2)
        {
            System.out.println("Usage: java XSDSample <schema_file> <xml_file>");
            return;
        }

        XSDBuilder builder = new XSDBuilder();
        URL url = createURL(args[0]);

        // Build XML Schema Object
        XMLSchema schemadoc = (XMLSchema)builder.build(url);
        process(args[1], schemadoc);
    }
    . . .
}

```

The `createURL()` method is a helper method that constructs a URL from the schema document file name specified on the command line.

2. Create a DOM parser to use for validation of the instance document. This code from `XSDSetSchema.java` shows how to pass the instance document file name and XML schema object to the `process()` method:

```

public static void process(String xmlURI, XMLSchema schemadoc) throws Exception{
    DOMParser dp = new DOMParser();
    URL url = createURL(xmlURI);
    . . .
}

```

3. Specify the schema object to use for validation with the `DOMParser.setXMLSchema()` method. This step is not necessary in implicit validation mode because the instance document already references the schema. For example, `XSDSetSchema.java` specifies the schema:

```

dp.setXMLSchema(schemadoc);

```

4. Set the validation mode for the DOM parser object with the `DOMParser.setValidationMode()` method. For example, `XSDSample.java` shows how to specify XML schema validation:

```
dp.setValidationMode(XMLParser.SCHEMA_VALIDATION);
dp.setPreserveWhitespace(true);
```

5. Set the output error stream for the parser with the `DOMParser.setErrorStream()` method. For example, `XSDSetSchema.java` sets it:

```
dp.setErrorStream (System.out);
```

6. Validate the instance document against the XML schema with the `DOMParser.parse()` method. For example, `XSDSetSchema.java` includes this code:

```
try
{
    System.out.println("Parsing "+xmlURI);
    dp.parse (url);
    System.out.println("The input file <"+xmlURI+"> parsed without errors");
}
catch (XMLParseException pe)
{
    System.out.println("Parser Exception: " + pe.getMessage());
}
catch (Exception e)
{
    System.out.println ("NonParserException: " + e.getMessage());
}
```

9.3.3 Validating a Subsection of an XML Document

In LAX mode, you can validate parts of an XML document without validating all of it. LAX parsing validates elements in a document that are declared in an associated XML schema. The processor does not consider the instance document invalid if it contains no elements declared in the schema.

By using LAX mode, you can define the schema only for the part of the XML to be validated. The `$ORACLE_HOME/xdk/demo/java/schema/XSDLax.java` program shows how to use LAX validation. The program follows the basic steps described in [Validating Against Externally Referenced XML Schemas](#) (page 9-15):

1. Build an XML schema object from the user-specified XML schema document.
2. Create a DOM parser to use for validation of the instance document.
3. Specify the XML schema to use for validation.
4. Set the validation mode for the DOM parser object.
5. Set the output error stream for the parser.
6. Validate the instance document against the XML schema by invoking `DOMParser.parse()`.

To enable LAX validation, the program sets the validation mode in the parser to `SCHEMA_LAX_VALIDATION` rather than to `SCHEMA_VALIDATION`. This code fragment from `XSDLax.java` shows this technique:

```

dp.setXMLSchema(schemadoc);
dp.setValidationMode(XMLParser.SCHEMA_LAX_VALIDATION);
dp.setPreserveWhitespace (true);
. . .

```

You can test LAX validation by running the sample program:

```
java XSDLax embedded_xsql.xsd embedded_xsql.xml
```

9.3.4 Validating XML from a SAX Stream

`$ORACLE_HOME/xdk/demo/java/schema/xsdsax.java` shows how to validate an XML document received as a SAX stream. You instantiate an `XSDValidator` and register it with the SAX parser as the content handler.

Follow the steps in this section to write programs that validate XML from a SAX stream:

1. Build an XML schema object from the user-specified XML schema document by invoking the `XSDBuilder.build()` method. This code fragment shows how to create the object:

```

XSDBuilder builder = new XSDBuilder();
URL url = XMLUtil.createURL(args[0]);

// Build XML Schema Object
XMLSchema schemadoc = (XMLSchema)builder.build(url);
process(args[1], schemadoc);
. . .

```

`createURL()` is a helper method that constructs a URL from the file name specified on the command line.

2. Create a SAX parser (`SAXParser` object) to use for validation of the instance document. This code fragment from `saxxsd.java` passes the handles to the XML document and schema document to the `process()` method:

```

process(args[1], schemadoc);...public static void process(String xmlURI,
XMLSchema schemadoc)
throws Exception
{
    SAXParser dp = new SAXParser();
...

```

3. Configure the SAX parser. This code fragment sets the validation mode for the SAX parser object with the `XSDBuilder.setValidationMode()` method:

```

dp.setPreserveWhitespace (true);
dp.setValidationMode(XMLParser.NONVALIDATING);

```

4. Create and configure a validator (`XSDValidator` object). This code fragment shows this technique:

```

XMLERror err;... err = new XMLERror();
...
XSDValidator validator = new XSDValidator();
...
validator.setError(err);

```

5. Specify the XML schema to use for validation by invoking the `XSDBuilder.setXMLProperty()` method. The first argument is the name of the

property, which is `fixedSchema`, and the second is the reference to the XML schema object. This code fragment shows this technique:

```
validator.setXMLProperty(XSDNode.FIXED_SCHEMA, schemadoc);  
...
```

6. Register the validator as the SAX content handler for the parser. This code fragment shows this technique:

```
dp.setContentHandler(validator);  
...
```

7. Validate the instance document against the XML schema by invoking the `SAXParser.parse()` method. This code fragment shows this technique:

```
dp.parse (url);
```

9.3.5 Validating XML from a DOM

`$ORACLE_HOME/xdk/demo/java/schema/xsddom.java` shows how to validate an instance document by get a DOM representation of the document and using an `XSDValidator` object to validate it.

The `xsddom.java` program follows these steps:

1. Build an XML schema object from the user-specified XML schema document by invoking the `XSDBuilder.build()` method. This code fragment shows how to create the object:

```
XSDBuilder builder = new XSDBuilder();  
URL url = XMLUtil.createURL(args[0]);  
  
XMLSchema schemadoc = (XMLSchema)builder.build(url);  
process(args[1], schemadoc);
```

`createURL()` is a helper method that constructs a URL from the file name specified on the command line.

2. Create a DOM parser (`DOMParser` object) to use for validation of the instance document. This code fragment from `domxsd.java` passes the handles to the XML document and schema document to the `process()` method:

```
process(args[1], schemadoc);...public static void process(String xmlURI,  
XMLSchema schemadoc)  
throws Exception  
{  
    DOMParser dp = new DOMParser();  
    . . .
```

3. Configure the DOM parser. This code fragment sets the validation mode for the parser object with the `DOMParser.setValidationMode()` method:

```
dp.setPreserveWhitespace (true);  
dp.setValidationMode(XMLParser.NONVALIDATING);  
dp.setErrorStream (System.out);
```

4. Parse the instance document. This code fragment shows this technique:

```
dp.parse (url);
```

5. Get the DOM representation of the input document. This code fragment shows this technique:

```
XMLDocument doc = dp.getDocument();
```

6. Create and configure a validator (XSDValidator object). This code fragment shows this technique:

```
XMLERror err;... err = new XMLERror();
...
XSDValidator validator = new XSDValidator();
...
validator.setError(err);
```

7. Specify the schema object to use for validation by invoking the XSDBuilder.setXMLProperty() method. The first argument is the name of the property, which in this example is fixedSchema, and the second is the reference to the schema object. This code fragment shows this technique:

```
validator.setXMLProperty(XSDNode.FIXED_SCHEMA, schemadoc);
. . .
```

8. Get the root element (XMLElement) of the DOM tree and validate. This code fragment shows this technique:

```
XMLElement root = (XMLElement)doc.getDocumentElement();
XMLElement copy = (XMLElement)root.validateContent(validator, true);
copy.print(System.out);
```

9.3.6 Validating XML from Designed Types and Elements

\$ORACLE_HOME/xdk/demo/java/schema/xsdproperty.java shows how to configure the XML Schema processor to validate an XML document based on a complex type or element declaration.

The xsdproperty.java program follows these steps:

1. Create String objects for the instance document name, XML schema name, root node namespace, root node local name, and specification of element or complex type ("true" means the root node is an element declaration). This code fragment shows this technique:

```
String xmlfile = args[0];
String xsdfile = args[1];
...
String ns = args[2]; //namespace for the root node
String nm = args[3]; //root node's local name
String el = args[4]; //true if root node is element declaration,
                    // otherwise, the root node is a complex type
```

2. Create an XSD builder and use it to create the schema object. This code fragment shows this technique:

```
XSDBuilder builder = new XSDBuilder();
URL url = XMLUtil.createURL(xsdfile);
XMLSchema schema;
...
schema = (XMLSchema) builder.build(url);
```

3. Get the node. Invoke different methods depending on whether the node is an element declaration or a complex type:

- If the node is an element declaration, pass the local name and namespace to the `getElement()` method of the schema object.
- If the node is an element declaration, pass the namespace, local name, and root complex type to the `getType()` method of the schema object.

`xsdproperty.java` uses this control structure:

```
QxName qname = new QxName(ns, nm);
...
XSDNode nd;
...
if (el.equals("true"))
{
    nd = schema.getElement(ns, nm);
    /* process ... */
}
else
{
    nd = schema.getType(ns, nm, XSDNode.TYPE);
    /* process ... */
}
```

4. After getting the node, create a new parser and set the schema to the parser to enable schema validation. This code fragment shows this technique:

```
DOMParser dp = new DOMParser();
URL url = XMLUtil.createURL (xmlURI);
```

5. Set properties on the parser and then parse the URL. Invoke the `schemaValidatorProperty()` method:
 - a. Set the root element or type property on the parser to a fully qualified name.

For a top-level element declaration, set the property name to `XSDNode.ROOT_ELEMENT` and the value to a `QName`, as shown by the `process1()` method.

For a top-level type definition, set the property name to `XSDNode.ROOT_TYPE` and the value to a `QName`, as shown by the `process2()` method.

- b. Set the root node property on the parser to an element or complex type node.

For an element node, set the property name to `XSDNode.ROOT_NODE` and the value to an `XSDElement` node, as shown by the `process3()` method.

For a type node, set the property name to `XSDNode.ROOT_NODE` and the value to an `XSDComplexType` node, as shown by the `process3()` method.

This code fragment shows the sequence of method invocation:

```
if (el.equals("true"))
{
    nd = schema.getElement(ns, nm);
    process1(xmlfile, schema, qname);
    process3(xmlfile, schema, nd);
}
else
{
    nd = schema.getType(ns, nm, XSDNode.TYPE);
    process2(xmlfile, schema, qname);
}
```



```

    process3(xmlfile, schema, nd);
}

```

The processing methods are implemented:

```

static void process1(String xmlURI, XMLSchema schema, QName qname)
    throws Exception
{
    /* create parser... */
    dp.setXMLSchema(schema);
    dp.setSchemaValidatorProperty(XSDNode.ROOT_ELEMENT, qname);
    dp.setPreserveWhitespace (true);
    dp.setErrorStream (System.out);
    dp.parse (url);
    ...
}

static void process2(String xmlURI, XMLSchema schema, QName qname)
    throws Exception
{
    /* create parser...
*/

    dp.setXMLSchema(schema);
    dp.setSchemaValidatorProperty(XSDNode.ROOT_TYPE, qname);
    dp.setPreserveWhitespace (true);
    dp.setErrorStream (System.out);
    dp.parse (url);
    ...
}

static void process3(String xmlURI, XMLSchema schema, XSDNode node)
    throws Exception
{
    /* create parser... */

    dp.setXMLSchema(schema);
    dp.setSchemaValidatorProperty(XSDNode.ROOT_NODE, node);
    dp.setPreserveWhitespace (true);
    dp.setErrorStream (System.out);
    dp.parse (url);
    ...
}

```

9.4 Tips and Techniques for Programming with XML Schemas

Topics include overriding schema location and converting a DTD to an XML schema.

Topics:

- [Overriding the Schema Location with an Entity Resolver](#) (page 9-21)
- [Converting DTDs to XML Schemas](#) (page 9-23)

9.4.1 Overriding the Schema Location with an Entity Resolver

When `XSDBuilder` builds a schema, it might need to include or import other schemas that are specified as URLs in a `schemaLocation` attribute. In some situations, you

might want to override the schema locations specified in `<import>` and supply the builder with the required schema documents.

The `xsdent.java` demo described in [Table 9-3](#) (page 9-10) shows a case where a schema specified as `schemaLocation` needs to be imported. The document element in `xsdent.xml` file contains this attribute:

```
xsi:schemaLocation = "http://www.example.com/BookCatalogue
                      xsdent.xsd">
```

The `xsdent.xsd` document contains these elements:

```
<schema xmlns="http://www.w3.org/2001/XMLSchema"
        targetNamespace="http://www.example.com/BookCatalogue"
        xmlns:catd = "http://www.example.com/Digest"
        xmlns:cat = "http://www.example.com/BookCatalogue"
        elementFormDefault="qualified">
<import namespace = "http://www.example.com/Digest"
        schemaLocation = "xsdent-1.xsd" />
```

As an example of wanting to override schema locations specified in `<import>` and supplying the builder with the required schema documents, suppose that you have downloaded the schemas documents from external web sites and stored them in a database. In such a situation, you can set an entity resolver in the `XSDBuilder`. `XSDBuilder` passes the schema location to the resolver, which returns an `InputStream`, `Reader`, or `URL` as an `InputSource`. The builder can read the schema documents from the `InputSource`.

The `xsdent.java` program shows how you can override the schema location with an entity resolver. You must implement the `EntityResolver` interface, instantiate the entity resolver, and set it in the XML schema builder. In the demo code, `sampleEntityResolver1` returns `InputSource` as an `InputStream` whereas `sampleEntityResolver2` returns `InputSource` as a `URL`.

Follow these basic steps:

1. Create a new XML schema builder:

```
XSDBuilder builder = new XSDBuilder();
```

2. Set the builder to your entity resolver. An entity resolver is a class that implements the `EntityResolver` interface. The purpose of the resolver is to enable the XML reader to intercept any external entities before including them. This code fragment creates an entity resolver and sets it in the builder:

```
builder.setEntityResolver(new sampleEntityResolver1());
```

The `sampleEntityResolver1` class implements the `resolveEntity()` method. You can use this method to redirect external system identifiers to local URIs. The source code is:

```
class sampleEntityResolver1 implements EntityResolver
{
    public InputSource resolveEntity (String targetNS, String systemId)
    throws SAXException, IOException
    {
        // perform any validation check if needed based on targetNS & systemId
        InputSource mySource = null;
        URL u = XMLUtil.createURL(systemId);
        // Create input source with InputStream as input
    }
}
```

```

        mySource = new InputSource(u.openStream());
        mySource.setSystemId(systemId);
        return mySource;
    }
}

```

The `sampleEntityResolver1` class initializes the `InputSource` with a stream.

3. Build the XML schema object. This code shows this technique:

```
schemadoc = builder.build(url);
```

4. Validate the instance document against the XML schema. The program executes this statement:

```
process(xmlfile, schemadoc);
```

The `process()` method creates a DOM parser, configures it, and invokes the `parse()` method. The method is implemented:

```

public static void process(String xmlURI, Object schemadoc)
    throws Exception
{
    DOMParser dp = new DOMParser();
    URL url = XMLUtil.createURL (xmlURI);

    dp.setXMLSchema(schemadoc);
    dp.setValidationMode(XMLParser.SCHEMA_VALIDATION);
    dp.setPreserveWhitespace (true);
    dp.setErrorStream (System.out);
    try {
        dp.parse (url);
        ...
    }
}

```

9.4.2 Converting DTDs to XML Schemas

Because of the power and flexibility of the XML Schema language, you may want to convert your existing DTDs to XML schema documents. You can use XDK to perform this transformation.

The `$ORACLE_HOME/xdk/demo/java/schema/DTD2Schema.java` program shows how to convert a DTD. You can test the program:

```
java DTD2Schema dtd2schema.dtd dtd2schema.xml
```

Follow these basic steps to convert a DTD to an XML schema document:

1. Parse the DTD with the `DOMParser.parseDTD()` method. This code fragment from `DTD2Schema.java` shows how to create the DTD object:

```

XSDBuilder builder = new XSDBuilder();
URL dtdURL = createURL(args[0]);
DTD dtd = getDTD(dtdURL, "abc");

```

The `getDTD()` method is implemented:

```

private static DTD getDTD(URL dtdURL, String rootName)
    throws Exception
{
    DOMParser parser = new DOMParser();

```

```
    DTD dtd;
    parser.setValidationMode(true);
    parser.setErrorStream(System.out);
    parser.showWarnings(true);
    parser.parseDTD(dtdURL, rootName);
    dtd = (DTD)parser.getDoctype();
    return dtd;
}
```

2. Convert the DTD to an XML schema DOM tree with the `DTD.convertDTD2Schema()` method. This code fragment from `DTD2Schema.java` shows this technique:

```
XMLDocument dtddoc = dtd.convertDTD2Schema();
```

3. Write the XML schema DOM tree to an output stream with the `XMLDocument.print()` method. This code fragment from `DTD2Schema.java` shows this technique:

```
FileOutputStream fos = new FileOutputStream("dtd2schema.xsd.out");
dtddoc.print(fos);
```

4. Create an XML schema object from the schema DOM tree with the `XSDBuilder.build()` method. This code fragment from `DTD2Schema.java` shows this technique:

```
XMLSchema schemadoc = (XMLSchema)builder.build(dtddoc, null);
```

5. Validate an instance document against the XML schema with the `DOMParser.parse()` method. This code fragment from `DTD2Schema.java` shows this technique:

```
validate(args[1], schemadoc);
```

The `validate()` method is implemented:

```
DOMParser dp = new DOMParser();
URL url = createURL(xmlURI);
dp.setXMLSchema(schemadoc);
dp.setValidationMode(XMLParser.SCHEMA_VALIDATION);
dp.setPreserveWhitespace(true);
dp.setErrorStream(System.out);
try
{
    System.out.println("Parsing "+xmlURI);
    dp.parse(url);
    System.out.println("The input file <"+xmlURI+"> parsed without errors");
}
...

```

Using the JAXB Class Generator

An explanation is given of how to use the Java Architecture for XML Binding (JAXB) class generator.

Topics:

- [Introduction to the JAXB Class Generator](#) (page 10-1)
- [Using the JAXB Class Generator: Overview](#) (page 10-4)
- [Processing XML with the JAXB Class Generator](#) (page 10-11)

Note:

Use the Java Architecture for XML Binding (JAXB) class generator for new applications to take advantage of the object binding feature for Extensible Markup Language (XML) data. The Oracle9i class generator for Java is deprecated. Oracle Database 10g supports the Oracle9i class generator for backward compatibility.

See Also:

[JAXB](#)

10.1 Introduction to the JAXB Class Generator

Topics introducing the JAXB class generator include prerequisites, standards and specifications, marshalling and unmarshalling, validation, and customization.

Topics:

- [Prerequisites for Using the JAXB Class Generator](#) (page 10-1)
- [Standards and Specifications for the JAXB Class Generator](#) (page 10-2)
- [Marshalling and Unmarshalling with JAXB](#) (page 10-3)
- [Validation with JAXB](#) (page 10-3)
- [JAXB Customization](#) (page 10-4)

10.1.1 Prerequisites for Using the JAXB Class Generator

Prerequisites for using the JAXB class generator are listed.

This chapter assumes that you have some familiarity with these topics:

- [Java Architecture for XML Binding \(JAXB\)](#). For a more thorough introduction to JAXB than is possible in this chapter, consult the XML resources listed in [Related Documents](#) (page xxix).
- [XML Schema language](#). See [Using the XML Schema Processor for Java](#) (page 9-1) for an overview and links to suggested reading.

10.1.2 Standards and Specifications for the JAXB Class Generator

The Oracle JAXB processor implements JSR-31 "The Java Architecture for XML Binding (JAXB)", Version 1.0, which is a recommendation of the JCP (Java Community Process).

The Oracle XML Developer's Kit (XDK) implementation of the JAXB 1.0 specification does not support these optional features:

- Javadoc generation
- Fail Fast validation
- External customization file
- XML Schema concepts described in section E.2 of the specification

[JSR](#) is a Java Specification Request of the Java Community Process (JCP). You can find a description of the JSR here:

<http://jcp.org/en/jsr/overview>

See Also:

[Oracle XML Developer's Kit Standards](#) (page 33-1) for a summary of the standards supported by XDK

10.1.3 JAXB Class Generator Features

The JAXB class generator for Java generates the interfaces and the implementation classes corresponding to an XML Schema. Its principal advantage to Java developers is automation of the mapping between XML documents and Java code, which enables programs to use generated code to read, manipulate, and re-create XML data.

The Java classes, which can be extended, give the developer access to the XML data without knowledge of the underlying XML data structure.

The Oracle JAXB class generator provides these advantages for XML application development in Java:

- **Speed**
Because the schema-to-code conversion is automated, you can rapidly generate Java code from an input XML schema.
- **Ease of use**
You can invoke generated `get` and `set` methods rather than code your own from the start.
- **Automated data conversion**
You can automate the conversion of XML document data into Java data types.

- Customization

JAXB provides a flexible framework that enables you to customize the binding of XML elements and attributes.

10.1.4 Marshalling and Unmarshalling with JAXB

JAXB is an application programming interface (API) and set of tools that maps XML data to Java objects. JAXB simplifies access to an XML document from a Java program by presenting the XML document to the program in a Java format.

You can use the JAXB API and tools to perform these basic tasks:

1. Generate and compile JAXB classes from an XML schema with the `ora jaxb` command-line utility.

To use the JAXB class generator to generate Java classes you must provide it with an XML schema. Document type definitions (DTDs) are not supported by JAXB. As explained in [Converting DTDs to XML Schemas](#) (page 9-23), however, you can use the `DTD2Schema` program to convert a DTD to an XML schema. Afterwards, you can use the JAXB class generator to generate classes from the schema.

The JAXB compiler generates Java classes that map to constraints in the source XML schema. The classes implements `get` and `set` methods that you can use to get and specify data for each type of element and attribute in the schema.

2. Process XML documents by instantiating the generated classes in a Java program.

Specifically, you can write a program that uses the JAXB binding framework to perform these tasks:

- a. Unmarshal the XML documents.

As explained in the JAXB specification, [unmarshalling](#) is defined as moving data from an XML document to the Java-generated objects.

- b. Validate the XML documents.

You can validate before or during the unmarshalling of the contents into the content tree. You can also validate on demand by invoking the validation API on the Java object. See [Validation with JAXB](#) (page 10-3).

- c. Modify Java content objects.

The content tree of data objects represents the structure and content of the source XML documents. You can use the `set` methods defined for a class to modify the content of elements and attributes.

- d. Marshal Java content objects back to XML.

In contrast to unmarshalling, [marshalling](#) is creating an XML document from Java objects by traversing a content tree of instances of Java classes. You can serialize the data to a Document Object Model (DOM) tree, Simple API for XML (SAX) content handler, transformation result, or output stream.

10.1.5 Validation with JAXB

A Java content tree is considered valid with an XML schema when marshalling the tree generates a valid XML document.

JAXB applications can perform validation in these circumstances:

- Unmarshalling-time validation that notifies the application of errors and warnings during unmarshalling. If unmarshalling includes validation that is error-free, then the input XML document and the Java content tree are valid.
- On-demand validation of a Java content tree initiated by the application.
- Fail-fast validation that gives immediate results while updating the Java content tree with `set` and `get` methods. As specified in [Standards and Specifications for the JAXB Class Generator](#) (page 10-2), fail-fast validation is an optional feature in the JAXB 1.0 specification that is not supported in the XDK implementation of the JAXB class generator.

JAXB applications must be able to marshal a valid Java content tree, but they are not required to ensure that the Java content tree is valid before invoking a marshalling API. The marshalling process does not itself validate the content tree. Programs are required to throw a `javax.xml.bind.MarshalException` when marshalling fails due to invalid content.

10.1.6 JAXB Customization

The declared element and type names in an XML schema do not always provide the most useful Java class names. You can override the default JAXB bindings by using custom binding declarations, which are described in the JAXB specification.

These declarations let you customize your generated JAXB classes beyond the XML-specific constraints in an XML schema, to include Java-specific refinements such as class and package name mappings.

You can annotate the schema to perform these customizations:

- Bind XML names to user-defined Java class names
- Name the package, derived classes, and methods
- Choose which elements to bind to which classes
- Decide how to bind each attribute and element declaration to a property in the appropriate content class
- Choose the type of each attribute-value or content specification

Several of the demos programs listed in [Table 10-2](#) (page 10-7) show JAXB customizations.

See Also:

[Customizing a Class Name in a Top-Level Element](#) (page 10-15) for a detailed explanation of a customization demo

10.2 Using the JAXB Class Generator: Overview

Topics here include the basic process of using the JAXB processor, running the XML schema processor demo programs, and using the JAXB class generator command-line utility.

Topics:

- [Using the JAXB Processor: Basic Process](#) (page 10-5)

- [Running the XML Schema Processor Demo Programs](#) (page 10-7)
- [Using the JAXB Class Generator Command-Line Utility](#) (page 10-9)

10.2.1 Using the JAXB Processor: Basic Process

The XDK JAXB API basic process is described.

The XDK JAXB API exposes these packages:

- `javax.xml.bind`, which provides a runtime binding framework for client applications including unmarshalling, marshalling, and validation
- `javax.xml.bind.util`, which provides useful client utility classes

The most important classes and interfaces in the `javax.xml.bind` package are described in [Table 10-1](#) (page 10-5). These form the core of most JAXB applications.

Table 10-1 *javax.xml.bind* Classes and Interfaces

Class/Interface	Description	Methods
JAXBContext class	Provides an abstraction for managing the XML/Java binding information necessary to implement the JAXB binding framework operations: unmarshal, marshal, and validate. A client application gets new instances of this class by invoking the <code>newInstance()</code> method.	The principal methods are: <ul style="list-style-type: none"> • <code>newInstance()</code> creates a JAXB content class. Supply this method the name of the package containing the generated classes. • <code>createMarshaller()</code> creates a marshaller that you can use to convert a content tree to XML. • <code>createUnmarshaller()</code> creates an unmarshaller that you can use to convert XML to a content tree. • <code>createValidator()</code> creates a <code>Validator</code> object that can validate a java content tree against its source schema.
Marshaller interface	Governs the process of serializing Java content trees into XML data.	The principal methods are: <ul style="list-style-type: none"> • <code>getEventHandler()</code> returns the current or default event handler. • <code>getProperty()</code> gets the property in the underlying implementation of marshaller. • <code>marshal()</code> marshals the content tree into a DOM, SAX2 events, output stream, transformation result, or <code>Writer</code>. • <code>setEventHandler()</code> creates a <code>Validator</code> object that validates a java content tree against its source schema.

Table 10-1 (Cont.) javax.xml.bind Classes and Interfaces

Class/Interface	Description	Methods
Unmarshaller interface	Governs the process of deserializing XML data into newly created Java content trees, optionally validating the XML data as it is unmarshalled.	<p>The principal methods are:</p> <ul style="list-style-type: none"> • <code>getEventHandler()</code> returns the current or default event handler. • <code>getUnmarshallerHandler()</code> returns an unmarshaller handler object usable as a component in an XML pipeline. • <code>isValidating()</code> indicates whether the unmarshaller is set to validate mode. • <code>setEventHandler()</code> allows an application to register a <code>ValidationEventHandler</code>. • <code>setValidating()</code> specifies whether the unmarshaller validates during unmarshal operations. • <code>marshal()</code> unmarshals XML data from the specified file, URL, input stream, input source, SAX, or DOM.
Validator interface	Controls the validation of content trees during run time. Specifically, this interface controls on-demand validation, which enables clients to receive data about validation errors and warnings detected in the Java content tree.	<p>The principal methods are:</p> <ul style="list-style-type: none"> • <code>getEventHandler()</code> returns the current or default event handler. • <code>setEventHandler()</code> allows an application to register a <code>ValidationEventHandler</code>. • <code>validate()</code> validates Java content trees on-demand at run time. This method can validate any arbitrary subtree of the Java content tree. • <code>validateRoot()</code> validates the Java content tree rooted at <code>rootObj</code>. You can use this method to validate an entire Java content tree.

Figure 10-1 (page 10-6) depicts the process flow of a framework that uses the JAXB class generator.

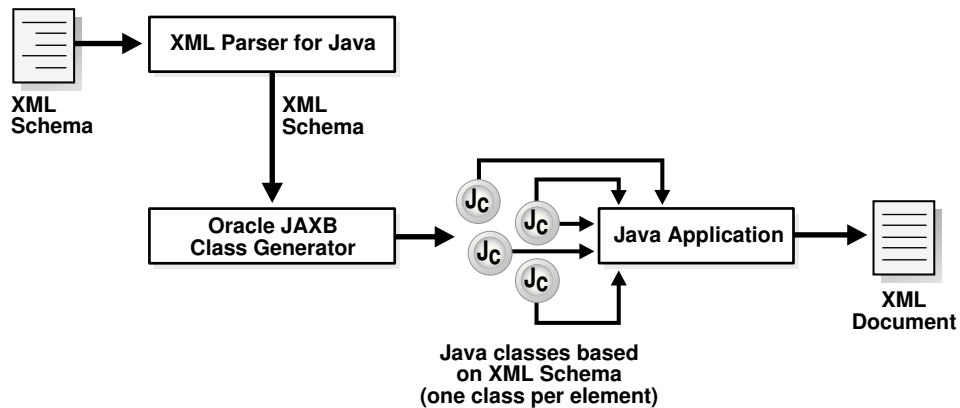
Figure 10-1 JAXB Class Generator for Java

The basic stages of the process shown in Figure 10-1 (page 10-6) are:

1. The XML parser parses the XML schema and sends the parsed data to the JAXB class generator.
2. The class generator creates Java classes and interfaces based on the input XML schema.

By default, one XML element or type declaration generates one interface and one class. For example, if the schema defines an element named `<anElement>`, then by default the JAXB class generator generates a source file named `AnElement.java` and another named `AnElementImpl.java`. You can use customize binding declarations to override the default binding of XML Schema components to Java representations.

3. The Java compiler compiles the `.java` source files into class files. All of the generated classes, source files, and application code must be compiled.
4. Your Java application uses the compiled classes and the binding framework to perform these types of tasks:
 - Create a JAXB context. You use this context to create the marshaller and unmarshaller.
 - Build object trees representing XML data that is valid against the XML schema. You can perform this task by either unmarshalling the data from an XML document that conforms to the schema or instantiating the classes.
 - Access and modify the data.
 - Optionally validate the modifications to the data relative to the constraints expressed in the XML schema.
 - Marshal the data to new XML documents.

See Also:

- *Oracle Database XML Java API Reference* for details of the JAXB API
 - [Processing XML with the JAXB Class Generator](#) (page 10-11) for detailed explanations of JAXB processing
-
-

10.2.2 Running the XML Schema Processor Demo Programs

Demo programs for the JAXB class generator for Java are included in `$ORACLE_HOME/xdk/demo/java/jaxb`.

Specifically, XDK includes the JAXB demos listed in [Table 10-2](#) (page 10-7).

Table 10-2 *JAXB Class Generator Demos*

Program	Subdirectory within Oracle Home	Demonstrates . . .
<code>SampleApp1.java</code>	<code>/xdk/demo/java/jaxb/Sample1</code>	The binding of top-level element and <code>complexType</code> definitions in the <code>sample1.xsd</code> schema to Java classes.

Table 10-2 (Cont.) JAXB Class Generator Demos

Program	Subdirectory within Oracle Home	Demonstrates . . .
SampleApp2.java	/xdk/demo/java/jaxb/Sample2	The binding of a top-level element with an inline simpleType definition in the sample2.xsd schema.
SampleApp3.java	/xdk/demo/java/jaxb/Sample3	The binding of a top-level complexType element that is derived by extension from another top-level complexType definition. See Binding Complex Types (page 10-11) for a detailed explanation of this program.
SampleApp4.java	/xdk/demo/java/jaxb/Sample4	The binding of a content model within a complexType that refers to a top-level named group.
SampleApp5.java	/xdk/demo/java/jaxb/Sample5	The binding of <choice> with maxOccurs unbounded within a complexType.
SampleApp6.java	/xdk/demo/java/jaxb/Sample6	The binding of atomic data types.
SampleApp7.java	/xdk/demo/java/jaxb/Sample7	The binding a complexType definition in which mixed="true".
SampleApp8.java	/xdk/demo/java/jaxb/Sample8	The binding of elements and types declared in two different namespaces.
SampleApp9.java	/xdk/demo/java/jaxb/Sample9	The customization of a Java package name.
SampleApp10.java	/xdk/demo/java/jaxb/Sample10	The customization of class name in a top-level element. See Customizing a Class Name in a Top-Level Element (page 10-15) for a detailed explanation of this program.
SampleApp11.java	/xdk/demo/java/jaxb/Sample11	The customization of class name of a local element occurring in a repeating model group declared inside a complexType element.
SampleApp12.java	/xdk/demo/java/jaxb/Sample12	The customization of the attribute name.
SampleApp13.java	/xdk/demo/java/jaxb/Sample13	The javaType customization specified on a global simpleType. The javaType customization specifies the parse and print method declared on a user-defined class.
SampleApp14.java	/xdk/demo/java/jaxb/Sample14	The customization of the typesafe enum class name.

You can find documentation that describes how to compile and run the sample programs in the README in the same directory. The basic steps are:

1. Change into the \$ORACLE_HOME/xdk/demo/java/jaxb directory (UNIX) or %ORACLE_HOME%\xdk\demo\java\jaxb directory (Windows).

2. Make sure that your environment variables are set as described in [Setting Up the XDK for Java Environment](#) (page 3-5).
3. Run `make` (UNIX) or `Make.bat` (Windows) at the system prompt. The `make` utility performs these sequential actions for each sample subdirectory:

- a. Runs the `ora jaxb` utility to generate Java class files based on an input XML schema. For most of the demos, the output classfiles are written to the `generated` subdirectory. For example, the `make` file performs these commands for the `sample1.xsd` schema in the `Sample1` subdirectory:

```
cd ./Sample1; $(JAVA_HOME)/bin/java -classpath "$(MAKE_CLASSPATH)" \
oracle.xml.jaxb.ora jaxb -schema sample1.xsd -targetPkg generated; echo;
```

- b. Runs the `javac` utility to compile the Java classes. For example, the `make` utility performs these commands for the Java class files in the `Sample1/generated/` subdirectory:

```
cd ./Sample1/generated; $(JAVA_HOME)/bin/javac -classpath \
"$(MAKE_CLASSPATH)" *.java
```

- c. Runs the `javac` utility to compile a sample Java application that uses the classes compiled in the preceding step. For example, the `make` utility compiles the `SampleApp1.java` program:

```
cd ./Sample1; $(JAVA_HOME)/bin/javac -classpath "$(MAKE_CLASSPATH)" \
SampleApp1.java
```

- d. Runs the sample Java application and writes the results to a log file. For example, the `make` utility executes the `SampleApp1` class and writes the output to `sample1.out`:

```
cd ./Sample1; $(JAVA_HOME)/bin/java -classpath "$(MAKE_CLASSPATH)" \
\SampleApp1 > sample1.out
```

10.2.3 Using the JAXB Class Generator Command-Line Utility

XDK includes `ora jaxb`, which is a command-line Java interface that generates Java classes from input XML schemas. Shell scripts `$(ORACLE_HOME)/bin/ora jaxb` and `%ORACLE_HOME%\bin\ora jaxb.bat` execute class `oracle.xml.jaxb.ora jaxb`.

To use `ora jaxb` ensure that your `CLASSPATH` is set as described in [Setting Up the XDK for Java Environment](#) (page 3-5).

[Table 10-3](#) (page 10-9) lists the `ora jaxb` command-line options.

Table 10-3 *ora jaxb* Command-Line Options

Option	Purpose
<code>-help</code>	Prints the help message.
<code>-version</code>	Prints the release version.
<code>-outputdir <i>OutputDir</i></code>	Specifies the directory in which to generate the Java source files. If the schema has a namespace, then the program generates the java code in the package (corresponding to the namespace) referenced from the <code>outputDir</code> . By default, the current directory is the <code>outputDir</code> .
<code>-schema <i>SchemaFile</i></code>	Specifies the input XML schema.

Table 10-3 (Cont.) orajaxb Command-Line Options

Option	Purpose
<code>-targetPkg <i>targetPkg</i></code>	Specifies the target package name. This option overrides any binding customization for package name, and also the default package name algorithm defined in the JAXB specification.
<code>-interface</code>	Generates only the interfaces.
<code>-verbose</code>	Lists the generated classes and interfaces.
<code>-defaultCus <i>fileName</i></code>	Generates the default customization file.
<code>-extension</code>	Allows vendor specific extensions and does not strictly follow the compatibility rules specified in Appendix E.2 of the JAXB 1.0 specification. When specified, the program ignores JAXB 1.0 unsupported features such as notations, substitution groups, and any attributes.

10.2.3.1 Using the JAXB Class Generator Command-Line Utility: Example

An example shows how to use the JAXB class generator command-line utility.

To test `orajaxb`, change to directory `$ORACLE_HOME/xdk/demo/java/jaxb/Sample1`. If you have run `make` then the directory contains these files:

```
SampleAppl.class
SampleAppl.java
generated/
sample1.out
sample1.xml
sample1.xsd
```

File `sample.xsd` is the XML schema associated with XML document `sample1.xml`. Subdirectory `generated/` contains the classes generated from the input schema. You can test `orajaxb` by deleting the contents of `generated/` and regenerating the classes.

```
rm generated/*
orajaxb -schema sample1.xsd -targetPkg generated -verbose
```

The terminal displays this output:

```
generated/CType.java
generated/AComplexType.java
generated/AnElement.java
generated/RElemOfCTypeInSameNs.java
generated/RType.java
generated/RElemOfSTypeInSameNs.java

generated/CTypeImpl.java
generated/AComplexTypeImpl.java
generated/AnElementImpl.java
generated/RElemOfCTypeInSameNsImpl.java
generated/RTypeImpl.java
generated/RElemOfSTypeInSameNsImpl.java
generated/ObjectFactory.java
```

10.2.4 JAXB Features Not Supported in XDK

Features not supported by the XDK implementation of the JAXB specification are described.

The XDK implementation of the JAXB specification does not support these features:

- Javadoc generation
- XML Schema component "any" and substitution groups

See Also:

<https://jcp.org/aboutJava/communityprocess/final/jsr031/index.html> for the JAXB specification

10.3 Processing XML with the JAXB Class Generator

Topics include binding complex types and customizing a class name in a top-level element.

Topics:

- [Binding Complex Types](#) (page 10-11)
- [Customizing a Class Name in a Top-Level Element](#) (page 10-15)

10.3.1 Binding Complex Types

`Sample3.java` shows how to bind a complex type definition to a Java content interface. One complex type defined in the XML schema is derived by extension from another complex type.

10.3.1.1 Defining the Schema to Validate `sample3.xml`

An XML schema, `schema3.xsd`, is defined for validating XML document `sample3.xml`.

[Example 10-1](#) (page 10-12) shows the XML data document that provides the input to the sample application. The `sample3.xml` document describes the address of an employee.

The XML schema shown in [Example 10-2](#) (page 10-12) defines the structure that you use to validate `sample3.xml`. The schema defines two complex types and one element, which are defined:

- The first complex type, which is named `Address`, is a sequence of elements. Each element in the sequence describes one part of the address: name, door number, and so forth.
- The second complex type, which is named `USAddress`, uses the `<extension base="exp:Address">` element to extend `Address` by adding US-specific elements to the `Address` sequence: state, zip, and so forth. The `exp` prefix specifies the `http://www.oracle.com/sample3/` namespace.
- The element is named `myAddress` and is of type `exp:USAddress`. The `exp` prefix specifies the `http://www.oracle.com/sample3/` namespace. In

sample3.xml, the myAddress top-level element, which is in namespace http://www.oracle.com/sample3/, conforms to the schema definition.

Example 10-1 sample3.xml

```
<?xml version="1.0"?>
<myAddress xmlns = "http://www.oracle.com/sample3/"
           xmlns:xsi = "http://www.w3.org/2001/XMLSchema-instance"
           xsi:schemaLocation = "http://www.oracle.com/sample3 sample3.xsd">
  <name>James Bond</name>
  <doorNumber>420</doorNumber>
  <street>Oracle parkway</street>
  <city>Redwood shores</city>
  <state>CA</state>
  <zip>94065</zip>
  <country>United States</country>
</myAddress>
```

Example 10-2 sample3.xsd

```
<?xml version="1.0"?>

<!-- Binding a complex type definition to java content interface
The complex type definition is derived by extension
-->

<schema xmlns = "http://www.w3.org/2001/XMLSchema"
        xmlns:exp="http://www.oracle.com/sample3/"
        targetNamespace="http://www.oracle.com/sample3/"
        elementFormDefault="qualified">

  <complexType name="Address">
    <sequence>
      <element name="name" type="string"/>
      <element name="doorNumber" type="short"/>
      <element name="street" type="string"/>
      <element name="city" type="string"/>
    </sequence>
  </complexType>

  <complexType name="USAddress">
    <complexContent>
      <extension base="exp:Address">
        <sequence>
          <element name="state" type="string"/>
          <element name="zip" type="integer"/>
          <element name="country" type="string"/>
        </sequence>
      </extension>
    </complexContent>
  </complexType>

  <element name="myAddress" type="exp:USAddress"/>

</schema>
```

10.3.1.2 Generating and Compiling the Java Classes

If you have an XML document and corresponding XML schema, then the next stage of processing is to generate the Java classes from the XML schema.

You can use the JAXB command-line interface described in [Using the JAXB Class Generator Command-Line Utility](#) (page 10-9) to perform this task.

Assuming that your environment is set up as described in [Setting Up the XDK for Java Environment](#) (page 3-5), you can create the source files in the generated package:

```
cd $ORACLE_HOME/xdk/demo/java/jaxb/Sample3
orajaxb -schema sample1.xsd -targetPkg generated
```

The preceding `orajaxb` command creates these source files in the `./generated/` subdirectory:

```
Address.java
AddressImpl.java
MyAddress.java
MyAddressImpl.java
ObjectFactory.java
USAddress.java
USAddressImpl.java
```

The complex types `Address` and `USAddress` each has two associated source files, as does the element `MyAddress`. The source file named after the element contains the interface; the file with the suffix `Impl` contains the class that implements the interface. For example, `Address.java` contains the interface `Address`, whereas `AddressImpl.java` contains the class that implements `Address`.

The content of the `Address.java` source file is shown in [Example 10-3](#) (page 10-13).

The `Address` complex type defined a sequence of elements: `name`, `doorNumber`, `street`, and `city`. Consequently, the `Address` interface includes a `get` and `set` method signature for each of the four elements. For example, the interface includes `getName()` for retrieving data in the `<name>` element and `setName()` for modifying data in this element.

You can compile the Java source files with `javac`:

```
cd $ORACLE_HOME/xdk/demo/java/jaxb/Sample3/generated
javac *.java
```

Example 10-3 Address.java

```
package generated;
public interface Address
{
    public void setName(java.lang.String n);
    public java.lang.String getName();
    public void setDoorNumber(short d);
    public short getDoorNumber();
    public void setStreet(java.lang.String s);
    public java.lang.String getStreet();
    public void setCity(java.lang.String c);
    public java.lang.String getCity();
}
```

10.3.1.3 Processing the XML Data in sample3.xml

`Sample3.java` unmarshals an XML data document, marshals it, and uses the generated classes to print and modify the address data.

It shows how you can process the `sample3.xml` document by using the Java class files that you generated in [Generating and Compiling the Java Classes](#) (page 10-12).

The `Sample3.java` program processes the data as follows:

1. Create strings for the XML data document file name and the name of the directory that contains the generated classes. This name is the package name. For example:

```
String fileName = "sample3.xml";
String instancePath = "generated";
```

2. Instantiate a JAXB context by invoking `JAXBContext.newInstance()`. A client application gets a new instance of this class by initializing it with a context path. The path contains a list of Java package names that contain the interfaces available to the marshaller. This statement shows this technique:

```
JAXBContext jc = JAXBContext.newInstance(instancePath);
```

3. Instantiate the unmarshaller. The `Unmarshaller` class governs the process of deserializing XML data into newly created objects, optionally validating the XML data as it is unmarshalled. This statement shows this technique:

```
Unmarshaller u = jc.createUnmarshaller();
```

4. Unmarshal the XML document. Invoke the `Unmarshaller.unmarshal()` method to deserialize the `sample3.xml` document and return the content trees as an `Object`. You can create a URL from the XML file name by invoking the `fileToUrl()` helper method. This statement shows the technique:

```
Object obj = u.unmarshal(fileToURL(fileName));
```

5. Instantiate a marshaller. The `Marshaller` class governs the process of serializing Java content trees back into XML data. This statement shows this technique:

```
Marshaller m = jc.createMarshaller();
```

6. Marshal the content tree. Invoke the `Marshaller.marshal()` method to marshal the content tree `Object` returned by the unmarshaller. You can serialize the data to a DOM tree, SAX content handler, transformation result, or output stream. This statement serializes the XML data, including markup, as an output stream:

```
m.marshal(obj, System.out);
```

By default, the marshaller uses 8-bit encoding of Unicode (UTF-8) encoding when writing XML data to an output stream.

7. Print the contents of the XML document. The program implements a `process()` method that accepts the content tree and marshaller as parameters.

The first stage of processing prints the data in the XML document without the XML markup. The method casts the `Object` generated by the marshaller into type `MyAddress`. It proceeds to invoke a series of methods whose method names are constructed by prefixing `get` to the name of an XML element. For example, to get the data in the `<city>` element in [Example 10-1](#) (page 10-12), the program invokes `getCity()`. This code fragment shows this technique:

```
public static void process(Object obj, Marshaller m) throws Throwable
{
    generated.MyAddress elem = (generated.MyAddress)obj;
    System.out.println();
    System.out.println(" My address is: ");
    System.out.println(" name: " + elem.getName() + "\n" +
        " doorNumber " + elem.getDoorNumber() + "\n" +
        " street: " + elem.getStreet() + "\n" +
        " city: " + elem.getCity() + "\n" +
```

```

" state: " + elem.getState() + "\n" +
" zip:  " + elem.getZip() + "\n" +
" country: " + elem.getCountry() + "\n" +
"\n" );

```

...

8. Change the XML data and print it. The `process()` method continues by invoking set methods that are analogous to the preceding get methods. The name of each set method is constructed by prefixing `set` to the name of an XML element. For example, `setCountry()` changes the value in the `<country>` element. These statements show this technique:

```

short num = 550;
elem.setDoorNumber(num);
elem.setCountry("India");
num = 10100;
elem.setZip(new java.math.BigInteger("100100"));
elem.setCity("Noida");
elem.setState("Delhi");

```

After changing the data, the program prints the data by invoking the same get methods as in the previous step.

10.3.2 Customizing a Class Name in a Top-Level Element

The `Sample10.java` program shows one form of JAXB customization. The program shows you can change the name of a class that corresponds to an element in the input XML schema.

10.3.2.1 Defining the Schema to Validate `schema10.xml`

An XML schema, `schema10.xsd`, is defined for validating XML document `schema10.xml`.

[Example 10-4](#) (page 10-15) shows the XML data document that provides the input to the sample application. The `sample10.xml` document describes a business.

[Example 10-5](#) (page 10-15) shows the XML schema that defines the structure of `sample10.xml`. The schema defines one complex type and one element as follows:

- The complex type, which is named `businessType`, is a sequence of elements. Each element in the sequence describes a part of the business: title, owner, and id.
- The element, which is named `business`, is of type `biz:businessType`. The `biz` prefix specifies the `http://jaxbcustomized/sample10/` namespace. In `sample10.xml`, the `business` top-level element, which is in namespace `http://jaxbcustomized/sample10/`, conforms to the schema definition.

Example 10-4 *sample10.xml*

```

<?xml version="1.0"?>
<business xmlns="http://jaxbcustomized/sample10/">
  <title>Software Development</title>
  <owner>Larry Peterson</owner>
  <id>45123</id>
</business>

```

Example 10-5 *sample10.xsd*

```

<?xml version="1.0"?>

```

```

<!-- Customization of class name in top level element -->

<schema xmlns="http://www.w3.org/2001/XMLSchema"
        targetNamespace="http://jaxbcustomized/sample10/"
        xmlns:biz="http://jaxbcustomized/sample10/"
        xmlns:jaxb="http://java.sun.com/xml/ns/jaxb"
        jaxb:version="1.0"
        elementFormDefault="qualified">

    <element name="business" type="biz:businessType">
        <annotation>
            <appinfo>
                <jaxb:class name="myBusiness"/>
            </appinfo>
        </annotation>
    </element>

    <complexType name="businessType">
        <sequence>
            <element name="title" type="string"/>
            <element name="owner" type="string"/>
            <element name="id" type="integer"/>
        </sequence>
    </complexType>

</schema>

```

10.3.2.1.1 Customizing the Schema Binding

Binding customizations used in XML schema `sample10.xsd` are described.

The schema shown in [Example 10-5](#) (page 10-15) customizes the binding of the `business` element with an inline binding declaration. The general form for inline customizations is:

```

<xs:annotation>
  <xs:appinfo>
    .
    .
    binding declarations
    .
    .
  </xs:appinfo>
</xs:annotation>

```

[Example 10-5](#) (page 10-15) uses the `<class>` binding declaration to bind a schema element to a Java class name. You can use the declaration to customize the name for an interface or the class that implements an interface. The JAXB class generator supports this syntax for `<class>` customizations:

```
<class [ name = "className" ] >
```

The `name` attribute specifies the name of the derived Java interface. [Example 10-5](#) (page 10-15) contains this customization:

```
<jaxb:class name="myBusiness"/>
```

Thus, the schema binds the `business` element to the interface `myBusiness` rather than to the interface `business`, which is the default.

10.3.2.2 Generating and Compiling the Java Classes

After you have an XML document and corresponding XML schema, the next stage is to generate the Java classes from the XML schema. You can use the JAXB command-line interface to perform this task.

If your environment is set up as described in [Setting Up the XDK for Java Environment](#) (page 3-5), then you can create the source files in the generated package:

```
cd $ORACLE_HOME/xdk/demo/java/jaxb/Sample10
orajaxb -schema sample10.xsd
```

Because the preceding command does not specify a target package, the package name is constructed from the target namespace of the schema, which is `http://jaxbcustomized/sample10/`. Consequently, the utility generates these source files in the `./jaxbcustomized/sample10/` subdirectory:

```
BusinessType.java
BusinessTypeImpl.java
MyBusiness.java
MyBusinessImpl.java
ObjectFactory.java
```

The complex type `businessType` has two source files, `BusinessType.java` and `BusinessTypeImpl.java`. Because of the JAXB customization, the `business` element is bound to interface `MyBusiness` and implementing class `MyBusinessImpl`.

The content of the `BusinessType.java` source file is shown in [Example 10-6](#) (page 10-17).

The `BusinessType` complex type defined a sequence of elements: `title`, `owner`, and `id`. Consequently, the `Address` interface includes a `get` and `set` method signature for each of the elements. For example, the interface includes `getTitle()` for retrieving data in the `<title>` element and `setTitle()` for modifying data in this element.

You can compile the Java source files with `javac`:

```
cd $ORACLE_HOME/xdk/demo/java/jaxb/Sample10/jaxbcustomized/sample10
javac *.java
```

Example 10-6 *BusinessType.java*

```
package jaxbcustomized.sample10;

public interface BusinessType
{
    public void setTitle(java.lang.String t);
    public java.lang.String getTitle();
    public void setOwner(java.lang.String o);
    public java.lang.String getOwner();
    public void setId(java.math.BigInteger i);
    public java.math.BigInteger getId();
}
```

10.3.2.3 Processing the XML Data in `sample10.xml`

`Sample10.java` unmarshals an XML document, prints its content, and marshals the XML to standard output.

Sample10.java shows how you can process the data in the sample10.xml document by using the class files that you generated in [Generating and Compiling the Java Classes](#) (page 10-17).

The Sample10.java program processes the XML data as follows:

1. Create strings for the XML data document file name and the name of the directory that contains the generated classes. This name is the package name. For example:

```
String fileName = "sample10.xml";
String instancePath = "jaxbcustomized.sample10";
```

2. Instantiate a JAXB context by invoking the `JAXBContext.newInstance()` method. This statement shows this technique:

```
JAXBContext jc = JAXBContext.newInstance(instancePath);
```

3. Create the unmarshaller. This statement shows this technique:

```
Unmarshaller u = jc.createUnmarshaller();
```

4. Unmarshal the XML document. The program unmarshals the document twice: it first returns an `Object` and then uses a cast to return a `MyBusiness` object. This statement shows this technique:

```
Object obj = u.unmarshal(fileToURL(fileName));
jaxbcustomized.sample10.MyBusiness bus =
    (jaxbcustomized.sample10.MyBusiness) u.unmarshal(fileToURL(fileName));
```

5. Print the contents of the XML document. The program invokes the `get` methods on the `MyBusiness` object. This code fragment shows this technique:

```
System.out.println("My business details are: ");
System.out.println("  title: " + bus.getTitle());
System.out.println("  owner: " + bus.getOwner());
System.out.println("  id:    " + bus.getId().toString());
System.out.println();
```

6. Create a marshaller. This statement shows this technique:

```
Marshaller m = jc.createMarshaller();
```

7. Configure the marshaller. You can invoke `setProperty()` to configure various properties the marshaller. The `JAXB_FORMATTED_OUTPUT` constant specifies that the marshaller must format the resulting XML data with line breaks and indentation. This statements show this technique:

```
m.setProperty(Marshaller.JAXB_FORMATTED_OUTPUT, new Boolean(true));
```

8. Marshal the content tree. This statement serializes the XML data, including markup, as an output stream:

```
m.marshal(bus, System.out);
```

By default, the marshaller uses UTF-8 encoding when writing XML data to an output stream.

Using the XML Pipeline Processor for Java

An explanation is given of how to use the Extensible Markup Language (XML) pipeline processor for Java.

Topics:

- [Introduction to the XML Pipeline Processor](#) (page 11-1)
- [Using the XML Pipeline Processor for Java: Overview](#) (page 11-4)
- [Processing XML in a Pipeline](#) (page 11-10)

11.1 Introduction to the XML Pipeline Processor

Topics here include prerequisites, standards and specifications, multistage processing, and customized pipeline processing.

Topics:

- [Prerequisites for Using the XML Pipeline Processor for Java](#) (page 11-1)
- [Standards and Specifications for the XML Pipeline Processor for Java](#) (page 11-2)
- [Multistage XML Processing](#) (page 11-2)
- [Customized Pipeline Processes](#) (page 11-3)

11.1.1 Prerequisites for Using the XML Pipeline Processor for Java

Prerequisites for using the XML Pipeline processor are listed.

This chapter assumes that you are familiar with these topics:

- [XML Pipeline Definition Language](#). This XML vocabulary enables you to describe the processing relations between XML resources. For a more thorough introduction to the Pipeline Definition Language, consult the XML resources listed in [Related Documents](#) (page xxix).
- [Document Object Model \(DOM\)](#). DOM is an in-memory tree representation of the structure of an XML document.
- [Simple API for XML \(SAX\)](#). SAX is a standard for event-based XML parsing.
- [XML Schema language](#). See [Using the XML Schema Processor for Java](#) (page 9-1) for an overview and links to suggested reading.

11.1.2 Standards and Specifications for the XML Pipeline Processor for Java

The Oracle XML Pipeline processor is based on the World Wide Web Consortium (W3C) XML Pipeline Definition Language Version 1.0 Note. The W3C Note defines an XML vocabulary rather than an application programming interface (API).

You can find the Pipeline specification here:

<http://www.w3.org/TR/xml-pipeline/>

[Pipeline Definition Language Standard for XDK for Java](#) (page 33-5) describes the differences between the W3C Note and the Oracle XML Developer's Kit (XDK) implementation of the Oracle XML Pipeline processor.

See Also:

[Table 33-1](#) (page 33-1)

11.1.3 Multistage XML Processing

The Oracle XML Pipeline processor is built on the XML Pipeline Definition Language. The processor can take an input XML pipeline document and execute pipeline processes according to derived dependencies.

A **pipeline document**, which is written in XML, specifies the processes to be executed in a declarative manner. You can associate Java classes with processes by using the `<processdef />` element in the pipeline document.

Use the Pipeline processor for multistage processing, which occurs when you process XML components sequentially or in parallel. The output of one stage of processing can become the input of another stage of processing. You can write a pipeline document that defines the inputs and outputs of the processes. [Figure 11-1](#) (page 11-2) shows a possible pipeline sequence.

Figure 11-1 Pipeline Processing

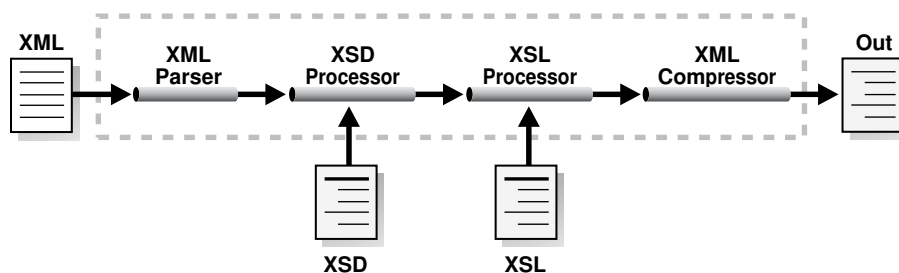

In addition to the XML Pipeline processor itself, XDK provides an API for processes that you can pipe together in a pipeline document. [Table 11-2](#) (page 11-4) summarizes the classes provided in the `oracle.xml.pipeline.processes` package.

The typical stages of processing XML in a pipeline are:

1. Parse the input XML documents. The `oracle.xml.pipeline.processes` package includes `DOMParserProcess` for DOM parsing and `SAXParserProcess` for SAX parsing.
2. Validate the input XML documents.

3. Serialize or transform the input documents. The Pipeline processor does not enable you to connect the SAX parser to the Extensible Stylesheet Language Transformation (XSLT) processor, which requires a DOM.

In multistage processing, SAX is ideal for filtering and searching large XML documents. Use DOM to change or access XML content efficiently and dynamically.

See Also:

[Processing XML in a Pipeline](#) (page 11-10) to learn how to write a pipeline document that provides the input for a pipeline application

11.1.4 Customized Pipeline Processes

Class `oracle.xml.pipeline.controller.Process` is the base class for all pipeline process definitions. The classes in package `oracle.xml.pipeline.processes` extend this base class. To create a customized pipeline process, you must create a class that extends class `Process`.

At the minimum, every custom process must override the do-nothing `initialize()` and `execute()` methods of the `Process` class. If the customized process accepts SAX events as input, then it should override the `SAXContentHandler()` method to return the appropriate `ContentHandler` that handles incoming SAX events. It should also override the `SAXErrorHandler()` method to return the appropriate `ErrorHandler`. [Table 11-1](#) (page 11-3) provides further descriptions of the preceding methods.

Table 11-1 Methods in Class `oracle.xml.pipeline.controller.Process`

Class	Description
<code>initialize()</code>	Initializes the process before execution. Invoke <code>getInput()</code> to fetch a specific input object associated with the process element and invoke <code>supportType()</code> to indicate the types of input supported. Analogously, invoke <code>getOutput()</code> and <code>supportType()</code> for output.
<code>execute()</code>	Executes the process. Invoke <code>getInParameterValue()</code> , <code>getInput()</code> , or <code>getInputSource()</code> to fetch the inputs to the process. If a custom process outputs SAX events, then it should invoke the <code>getSAXContentHandler()</code> and <code>getSAXErrorHandler()</code> methods in <code>execute()</code> to get the SAX handlers of these processes in the pipeline: Invoke <code>setOutputResult()</code> , <code>getOutputStream()</code> , <code>getOutputWriter()</code> or <code>setOutParam()</code> to set the outputs or outparams generated by this process. Invoke <code>getErrorSource()</code> , <code>getErrorStream()</code> , or <code>getErrorDocument()</code> to access the pipeline error element associated with this process element. If an exception occurs during <code>execute()</code> , invoke <code>error()</code> or <code>info()</code> to propagate it to the <code>PipelineErrorHandler</code> .
<code>SAXContentHandler()</code>	Returns the SAX <code>ContentHandler</code> . If dependencies from other processes are not available, then return <code>null</code> . When these dependencies are available, the method is executed till the end.
<code>SAXErrorHandler()</code>	Returns the SAX <code>ErrorHandler</code> . If you do not override this method, then the JAXB processor uses the default error handler implemented by this class to handle SAX errors.

See Also:

Oracle Database XML Java API Reference for information about package `oracle.xml.pipeline.processes`

11.2 Using the XML Pipeline Processor for Java: Overview

Topics here include the basic process, running the demo programs, and using the XML pipeline processor command-line utility.

Topics:

- [Using the XML Pipeline Processor for Java: Basic Process](#) (page 11-4)
- [Running the XML Pipeline Processor Demo Programs](#) (page 11-8)
- [Using the XML Pipeline Processor Command-Line Utility](#) (page 11-10)

11.2.1 Using the XML Pipeline Processor for Java: Basic Process

The basic process of the XML Pipeline Processor for Java is described.

The XML Pipeline processor for Java is accessible through these packages:

- `oracle.xml.pipeline.controller`, which provides an XML Pipeline controller that executes XML processes in a pipeline based on dependencies.
- `oracle.xml.pipeline.processes`, which provides wrapper classes for XML processes that can be executed by the XML Pipeline controller. The `oracle.xml.pipeline.processes` package contains the classes that you can use to design a pipeline application framework. Each class extends the `oracle.xml.pipeline.controller.Process` class.

[Table 11-2](#) (page 11-4) lists the components in the package. You can connect these components and processes through a combination of the XML Pipeline processor and a pipeline document.

Table 11-2 *Classes in oracle.xml.pipeline.processes*

Class	Description
<code>CompressReaderProcesses</code>	Receives compressed XML and outputs parsed XML.
<code>CompressWriterProcesses</code>	Receives XML parsed with DOM or SAX and outputs compressed XML.
<code>DOMParserProcess</code>	Parses incoming XML and outputs a DOM tree.
<code>SAXParserProcess</code>	Parses incoming XML and outputs SAX events.
<code>XPathProcess</code>	Accepts a DOM as input, uses an XPath pattern to select one or more nodes from an XML Document or an XML DocumentFragment, and outputs a Document or DocumentFragment.

Table 11-2 (Cont.) Classes in oracle.xml.pipeline.processes

Class	Description
XSDSchemaBuilder	Parses an XML schema and outputs a schema object for validation. This process is built into the XML Pipeline processor and builds schema objects used for validating XML documents.
XSDValProcess	Validates against a local schema, analyzes the results, and reports errors if necessary.
XSLProcess	Accepts DOM as input, applies an XSL stylesheet, and outputs the result of the transformation.
XSLStylesheetProcess	Receives an XSL stylesheet as a stream or DOM and creates an XSLStylesheet object.

[Figure 11-2](#) (page 11-6) shows how to pass a pipeline document to a Java application that uses the XML Pipeline processor, configure the processor, and execute the pipeline.

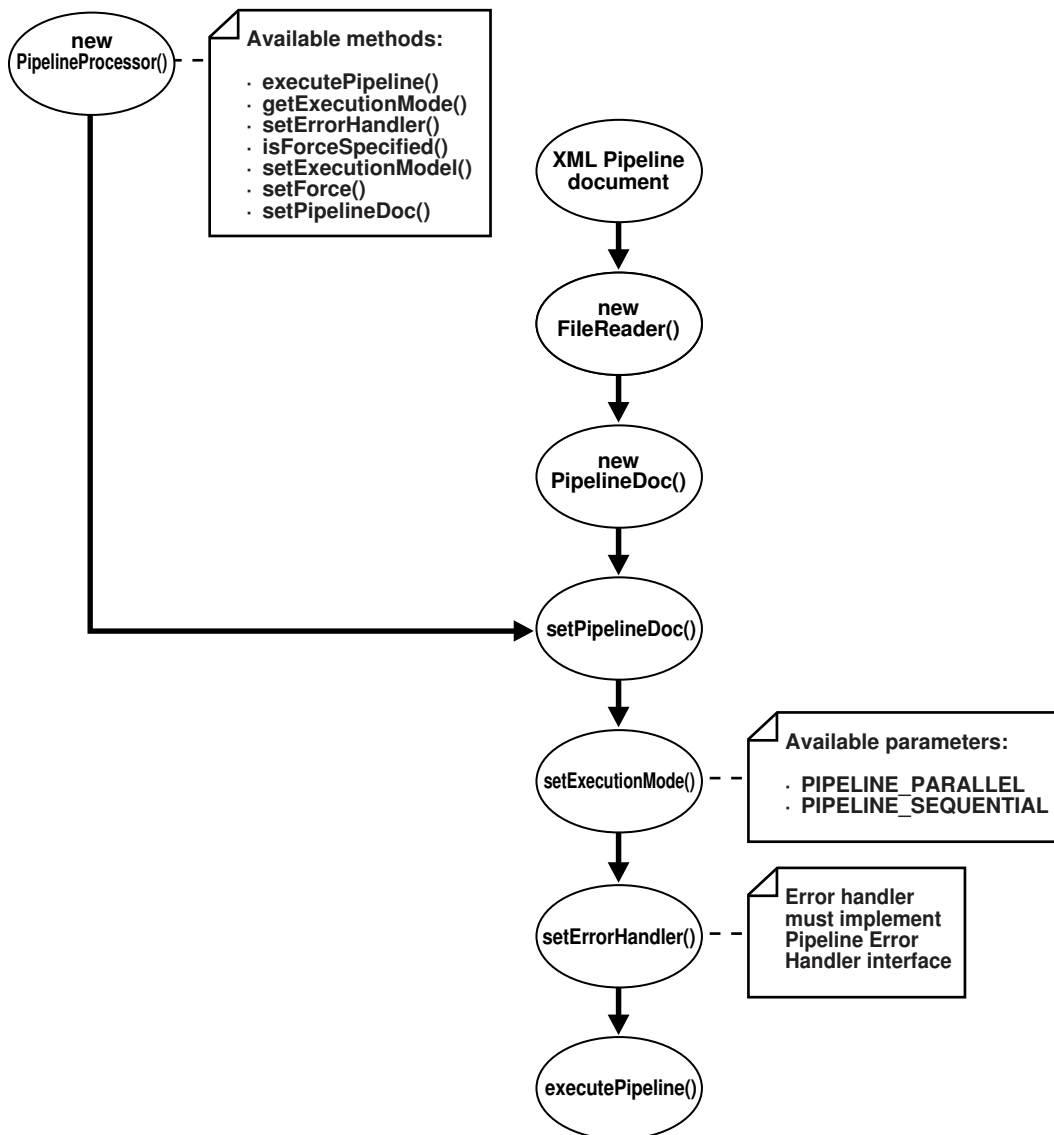
Figure 11-2 Using the Pipeline Processor for Java

The basic steps are:

1. Instantiate a pipeline document, which forms the input to the pipeline execution. Create the object by passing a `FileReader` to the constructor:

```

PipelineDoc pipe;
FileReader f;
pipe = new PipelineDoc((Reader)f, false);

```

2. Instantiate a pipeline processor. `PipelineProcessor` is the top-level class that executes the pipeline. [Table 11-3](#) (page 11-6) describes some available methods.

Table 11-3 PipelineProcessor Methods

Method	Description
<code>executePipeline()</code>	Executes the pipeline based on the <code>PipelineDoc</code> set by invoking <code>setPipelineDoc()</code> .

Table 11-3 (Cont.) PipelineProcessor Methods

Method	Description
<code>getExecutionMode()</code>	Gets the type of execution mode: PIPELINE_SEQUENTIAL or PIPELINE_PARALLEL.
<code>setErrorHandler()</code>	Sets the error handler for the pipeline. This invocation is mandatory to execute the pipeline.
<code>setExecutionMode()</code>	Sets the execution mode. PIPELINE_PARALLEL is the default and specifies that the processes in the pipeline must execute in parallel. PIPELINE_SEQUENTIAL specifies that the processes in the pipeline must execute sequentially.
<code>setForce()</code>	Sets execution behavior. If TRUE, then the pipeline executes regardless of whether the target is up-to-date with the pipeline inputs.
<code>setPipelineDoc()</code>	Sets the PipelineDoc object for the pipeline.

This statement instantiates the pipeline processor:

```
proc = new PipelineProcessor();
```

3. Set the processor to the pipeline document. For example:

```
proc.setPipelineDoc(pipe);
```

4. Set the execution mode for the processor and perform any other needed configuration. For example, set the mode by passing a constant to `PipelineProcessor.setExecutionMode()`.

This statement specifies sequential execution:

```
proc.setExecutionMode(PipelineConstants.PIPELINE_SEQUENTIAL);
```

5. Instantiate an error handler. The error handler must implement the `PipelineErrorHandler` interface. For example:

```
errHandler = new PipelineSampleErrHdlr(logname);
```

6. Set the error handler for the processor by invoking `setErrorHandler()`. For example:

```
proc.setErrorHandler(errHandler);
```

7. Execute the pipeline. For example:

```
proc.executePipeline();
```

See Also:

- *Oracle Database XML Java API Reference* to learn about the `oracle.xml.pipeline` subpackages
 - [Creating a Pipeline Document](#) (page 11-11)
-

11.2.2 Running the XML Pipeline Processor Demo Programs

Demo programs for the XML Pipeline processor are included in `$ORACLE_HOME/xdk/demo/java/pipeline`.

[Table 11-4](#) (page 11-8) describes the XML files and Java source files that you can use to test the utility.

Table 11-4 Pipeline Processor Sample Files

File	Description
README	A text file that describes how to set up the Pipeline processor demos.
PipelineSample.java	A sample Pipeline processor application. The program takes <code>pipedoc.xml</code> as its first argument.
PipelineSampleErrHdlr.java	A sample program to create an error handler used by <code>PipelineSample</code> .
book.xml	A sample XML document that describes a series of books. This document is specified as an input by <code>pipedoc.xml</code> , <code>pipedoc2.xml</code> , and <code>pipedocerr.xml</code> .
book.xsl	An XSLT stylesheet that transforms the list of books in <code>book.xml</code> into an HTML table.
book_err.xsl	An XSLT stylesheet specified as an input by the <code>pipedocerr.xml</code> pipeline document. This stylesheet contains an intentional error.
id.xsl	An XSLT stylesheet specified as an input by the <code>pipedoc3.xml</code> pipeline document.
items.xsd	An XML schema document specified as an input by the <code>pipedoc3.xml</code> pipeline document.
pipedoc.xml	A pipeline document. This document specifies that process p1 must parse <code>book.xml</code> with DOM, process p2 must parse <code>book.xsl</code> and create a stylesheet object, and process p3 must apply the stylesheet to the DOM to generate <code>myresult.html</code> .
pipedoc2.xml	A pipeline document. This document specifies that process p1 must parse <code>book.xml</code> with SAX, process p2 must generate compressed XML <code>comp.xml</code> from the SAX events, and process p3 must regenerate the XML from the compressed stream as <code>myresult2.html</code> .

Table 11-4 (Cont.) Pipeline Processor Sample Files

File	Description
<code>pipedoc3.xml</code>	A pipeline document. This document specifies that a process <code>p5</code> must parse <code>po.xml</code> with DOM, process <code>p1</code> must select a single node from the DOM tree with an XPath expression, process <code>p4</code> must parse <code>items.xsd</code> and generate a schema object, process <code>p6</code> must validate the selected node against the schema, process <code>p3</code> must parse <code>id.xsl</code> and generate a stylesheet object, and validated node to produce <code>myresult3.html</code> .
<code>pipedocerr.xml</code>	A pipeline document. This document specifies that process <code>p1</code> must parse <code>book.xml</code> with DOM, process <code>p2</code> must parse <code>book_err.xsl</code> and generate a stylesheet object if it encounters no errors and apply an inline stylesheet if it encounters errors, and process <code>p3</code> must apply the stylesheet to the DOM to generate <code>myresulterr.html</code> . Because <code>book_err.xsl</code> contains an error, the program must write the text contents of the input XML to <code>myresulterr.html</code> .
<code>po.xml</code>	A sample XML document that describes a purchase order. This document is specified as an input by <code>pipedoc3.xml</code> .

Documentation for how to compile and run the sample programs is located in the README. The basic steps are:

1. Change into the `$ORACLE_HOME/xdk/demo/java/pipeline` directory (UNIX) or `%ORACLE_HOME%\xdk\demo\java\pipeline` directory (Windows).
2. Ensure that your environment variables are set as described in [Setting Up the XDK for Java Environment](#) (page 3-5).
3. Run `make` (UNIX) or `Make.bat` (Windows) at the system prompt to generate class files for `PipelineSample.java` and `PipelineSampleErrHdler.java` and run the demo programs. The programs write output files to the `log` subdirectory.

Alternatively, you can run the demo programs manually by using this syntax:

```
java PipelineSample pipedoc pipelog [ seq | para ]
```

The `pipedoc` option specifies which pipeline document to use. The `pipelog` option specifies the name of the pipeline log file, which is optional unless you specify `seq` or `para`, in which case a file name is required. If you do not specify a log file, then the program generates `pipeline.log` by default. The `seq` option processes threads sequentially; `para` processes in parallel. If you specify neither `seq` or `para`, then the default is parallel processing.

4. View the files generated from the pipeline, which are all named with the initial string `myresult`, and the log files.

11.2.3 Using the XML Pipeline Processor Command-Line Utility

The command-line interface for the XML Pipeline processor is named `orapipe`. The Pipeline processor is packaged with Oracle Database. By default, the Oracle Universal Installer installs the utility on disk in `$ORACLE_HOME/bin`.

Before running the utility for the first time, ensure that your environment variables are set as described in [Setting Up the XDK for Java Environment](#) (page 3-5). Run `orapipe` at the operating system command line with this syntax:

```
orapipe options pipedoc
```

The `pipedoc` is the pipeline document, which is required. [Table 11-5](#) (page 11-10) describes the available options for the `orapipe` utility.

Table 11-5 *orapipe* Command-Line Options

Option	Purpose
<code>-help</code>	Prints the help message
<code>-log logfile</code>	Writes errors and messages to the specified log file. The default is <code>pipeline.log</code> .
<code>-noinfo</code>	Does not log informational items. The default is on.
<code>-nowarning</code>	Does not log warnings. The default is on.
<code>-validate</code>	Validates the input <code>pipedoc</code> with the pipeline schema. Validation is turned off by default. If <code>outparam</code> feature is used, then <code>validate</code> fails with the current pipeline schema because this is an additional feature.
<code>-version</code>	Prints the release version.
<code>-sequential</code>	Executes the pipeline in sequential mode. The default is parallel.
<code>-force</code>	Executes pipeline even if target is up-to-date. By default no force is specified.
<code>-attr name value</code>	Sets the value of <code>\$name</code> to the specified <code>value</code> . For example, if the attribute name is <code>source</code> and the value is <code>book.xml</code> , then you can pass this value to an element in the pipeline document: <code><input ... label="\$source"></code> .

11.3 Processing XML in a Pipeline

Topics here include creating a pipeline document, writing a pipeline processor application, and writing a pipeline error handler.

Topics:

- [Creating a Pipeline Document](#) (page 11-11)
- [Writing a Pipeline Processor Application](#) (page 11-12)
- [Writing a Pipeline Error Handler](#) (page 11-14)

11.3.1 Creating a Pipeline Document

To use the Oracle XML Pipeline processor, you must create an XML document according to the rules of the Pipeline Definition Language specified in the W3C Note. The W3C specification defines the XML processing components and the inputs and outputs for these processes.

The XML Pipeline processor includes support for these XDK components:

- XML parser
- XML compressor
- XML Schema validator
- XSLT processor

11.3.1.1 Example of a Pipeline Document

The XML Pipeline processor executes a sequence of XML processing according to the rules in the pipeline document and returns a result. The sample pipeline document that is included in the demo directory is presented.

Example 11-1 *pipedoc.xml*

```
<pipeline xmlns="http://www.w3.org/2002/02/xml-pipeline"
          xml:base="http://example.org/">

  <param name="target" select="myresult.html"/>

  <processdef name="domparser.p"
    definition="oracle.xml.pipeline.processes.DOMParserProcess"/>
  <processdef name="xslstylesheet.p"
    definition="oracle.xml.pipeline.processes.XSLStylesheetProcess"/>
  <processdef name="xslprocess.p"
    definition="oracle.xml.pipeline.processes.XSLProcess"/>

  <process id="p2" type="xslstylesheet.p" ignore-errors="false">
    <input name="xsl" label="book.xsl"/>
    <outparam name="stylesheet" label="xslstyle"/>
  </process>

  <process id="p3" type="xslprocess.p" ignore-errors="false">
    <param name="stylesheet" label="xslstyle"/>
    <input name="document" label="xmldoc"/>
    <output name="result" label="myresult.html"/>
  </process>

  <process id="p1" type="domparser.p" ignore-errors="true">
    <input name="xmlsource" label="book.xml"/>
    <output name="dom" label="xmldoc"/>
    <param name="preserveWhitespace" select="true"></param>
    <error name="dom">
      <html xmlns="http://www.w3.org/1999/xhtml">
        <head>
          <title>DOMParser Failure!</title>
        </head>
        <body>
          <h1>Error parsing document</h1>
        </body>
      </html>
    </error>
  </process>
```

```
        </error>
    </process>

</pipeline>
```

11.3.1.1.1 Processes Specified in the Pipeline Document

The processes specified in the pipeline document are described.

In [Example 11-1](#) (page 11-11), three processes are called and associated with Java classes in the `oracle.xml.pipeline.processes` package. The pipeline document uses element `processdef` to make these associations:

- `domparser.p` is associated with the `DOMParserProcess` class
- `xslstylesheet.p` is associated with the `XSLStylesheetProcess` class
- `xslprocess.p` is associated with the `XSLProcess` class

11.3.1.1.2 Processing Architecture Specified in the Pipeline Document

The basic design of and the processing architecture of the pipeline are described.

The `PipelineSample` program accepts the `pipedoc.xml` document shown in [Example 11-1](#) (page 11-11) as input along with XML documents `book.xml` and `book.xsl`. The basic design of the pipeline is:

1. Parse the incoming `book.xml` document and generate a DOM tree. This task is performed by `DOMParserProcess`.
2. Parse `book.xsl` as a stream and generate an `XSLStylesheet` object. This task is performed by `XSLStylesheetProcess`.
3. Receive the DOM of `book.xml` as input, apply the stylesheet object, and write the result to `myresult.html`. This task is performed by `XSLProcess`.

Note these aspects of the processing architecture used in the pipeline document:

- The target information set, `http://example.org/myresult.html`, is inferred from the default value of the `target` parameter and the `xml:base` setting.
- The process `p2` has an input of `book.xsl` and an output parameter with the label `xslstyle`, so it must run to produce the input for `p3`.
- The `p3` process depends on input parameter `xslstyle` and document `xmldoc`.
- The `p3` process has an output parameter with the label `http://example.org/myresult.html`, so it must run to produce the target.
- The process `p1` depends on input document `book.xml` and outputs `xmldoc`, so it must run to produce the input for `p3`.

In [Example 11-1](#) (page 11-11), more than one order of processing can satisfy all of the dependencies. Given the rules, the XML Pipeline processor must process `p3` last but can process `p1` and `p2` in either order or process them in parallel.

11.3.2 Writing a Pipeline Processor Application

The `PipelineSample.java` source file shows a basic pipeline application.

You can use the application with any of the pipeline documents in [Table 11-4](#) (page 11-8) to parse and transform an input XML document.

The basic steps of the program are:

1. Perform the initial setup. The program declares references of type `FileReader` (for the input XML file), `PipelineDoc` (for the input pipeline document), and `PipelineProcessor` (for the processor). The first argument is the pipeline document, which is required. If a second argument is received, then it is stored in the `logname` `String`. This code fragment shows this technique:

```
public static void main(String[] args)
{
    FileReader f;
    PipelineDoc pipe;
    PipelineProcessor proc;

    if (args.length < 1)
    {
        System.out.println("First argument needed, other arguments are ".
                           "optional:");
        System.out.println("pipedoc.xml <output_log> <'seq'>");
        return;
    }
    if (args.length > 1)
        logname = args[1];
    ...
}
```

2. Create a `FileReader` object by passing the first command-line argument to the constructor as the file name. For example:

```
f = new FileReader(args[0]);
```

3. Create a `PipelineDoc` object by passing the reference to the `FileReader` object. This example casts the `FileReader` to a `Reader` and specifies no validation:

```
pipe = new PipelineDoc((Reader)f, false);
```

4. Instantiate an XML Pipeline processor. This statement instantiates the pipeline processor:

```
proc = new PipelineProcessor();
```

5. Set the processor to the pipeline document. For example:

```
proc.setPipelineDoc(pipe);
```

6. Set the execution mode for the processor and perform any other configuration. This code fragment uses a condition to determine the execution mode. If three or more arguments are passed to the program, then it sets the mode to sequential or parallel depending on which argument is passed. For example:

```
String execMode = null;
if (args.length > 2)
{
    execMode = args[2];
    if(execMode.startsWith("seq"))
        proc.setExecutionMode(PipelineConstants.PIPELINE_SEQUENTIAL);
    else if (execMode.startsWith("para"))
        proc.setExecutionMode(PipelineConstants.PIPELINE_PARALLEL);
}
```

7. Instantiate an error handler. The error handler must implement the `PipelineErrorHandler` interface. The program uses the

`PipelineSampleErrHdlr` shown in `PipelineSampleErrHdlr.java`. This code fragment shows this technique:

```
errHandler = new PipelineSampleErrHdlr(logname);
```

8. Set the error handler for the processor by invoking `setErrorHandler()`. This statement shows this technique:

```
proc.setErrorHandler(errHandler);
```

9. Execute the pipeline. This statement shows this technique:

```
proc.executePipeline();
```

See Also:

Oracle Database XML Java API Reference to learn about the `oracle.xml.pipeline` subpackages

11.3.3 Writing a Pipeline Error Handler

An application invoking the XML Pipeline processor must implement the `PipelineErrorHandler` interface to handle errors received from the processor. Set the error handler in the processor by invoking `setErrorHandler()`. When writing the error handler, you can choose to throw an exception for different types of errors.

The `oracle.xml.pipeline.controller.PipelineErrorHandler` interface declares the methods shown in [Table 11-6](#) (page 11-14), all of which return `void`.

Table 11-6 *PipelineErrorHandler Methods*

Method	Description
<code>error(java.lang.String msg, PipelineException e)</code>	Handles <code>PipelineException</code> errors.
<code>fatalError(java.lang.String msg, PipelineException e)</code>	Handles fatal <code>PipelineException</code> errors.
<code>warning(java.lang.String msg, PipelineException e)</code>	Handles <code>PipelineException</code> warnings.
<code>info(java.lang.String msg)</code>	Prints optional, additional information about errors.

The first three methods in [Table 11-6](#) (page 11-14) receive a reference to an `oracle.xml.pipeline.controller.PipelineException` object. These methods of the `PipelineException` class are especially useful:

- `getExceptionType()`, which gets the type of exception thrown
- `getProcessId()`, which gets the process ID where the exception occurred
- `getMessage()`, which returns the message string of this `Throwable` error

The `PipelineSampleErrHdlr.java` source file implements a basic error handler for use with the `PipelineSample` program. The basic steps are:

1. Implement a constructor. The constructor accepts the name of a log file and wraps it in a `FileWriter` object:

```

PipelineSampleErrHdlr(String logFile) throws IOException
{
    log = new PrintWriter(new FileWriter(logFile));
}

```

2. Implement the `error()` method. This implementation prints the process ID, exception type, and error message. It also increments a variable holding the error count. For example:

```

public void error (String msg, PipelineException e) throws Exception
{
    log.println("\nError in: " + e.getProcessId());
    log.println("Type: " + e.getExceptionType());
    log.println("Message: " + e.getMessage());
    log.println("Error message: " + msg);
    log.flush();
    errCount++;
}

```

3. Implement the `fatalError()` method. This implementation follows the pattern of `error()`. For example:

```

public void fatalError (String msg, PipelineException e) throws Exception
{
    log.println("\nFatalError in: " + e.getProcessId());
    log.println("Type: " + e.getExceptionType());
    log.println("Message: " + e.getMessage());
    log.println("Error message: " + msg);
    log.flush();
    errCount++;
}

```

4. Implement the `warning()` method. This implementation follows the basic pattern of `error()` except it increments the `warnCount` variable rather than the `errCount` variable. For example:

```

public void warning (String msg, PipelineException e) throws Exception
{
    log.println("\nWarning in: " + e.getProcessId());
    log.println("Message: " + e.getMessage());
    log.println("Error message: " + msg);
    log.flush();
    warnCount++;
}

```

5. Implement the `info()` method. Unlike the preceding methods, this method does not receive a `PipelineException` reference as input. This implementation prints the `String` received by the method and increments the value of the `warnCount` variable:

```

public void info (String msg)
{
    log.println("\nInfo : " + msg);
    log.flush();
    warnCount++;
}

```

6. Implement a method to close the `PrintWriter`. This code implements the method `closeLog()`, which prints the number of errors and warnings and invokes `PrintWriter.close()`:

```
public void closeLog()
{
    log.println("\nTotal Errors: " + errCount + "\nTotal Warnings: " +
        warnCount);
    log.flush();
    log.close();
}
```

See Also:

Oracle Database XML Java API Reference to learn about the `PipelineErrorHandler` interface and the `PipelineException` class

Determining XML Differences Using Java

An explanation is given of how to determine the differences between two Extensible Markup Language (XML) inputs, using the Java library included in the Oracle XML Developer's Kit (XDK).

Topics:

- [Overview of XML Diffing Utilities for Java](#) (page 12-1)
- [User Options for the Java XML Diffing Library](#) (page 12-2)
- [Using Java XML Diffing Methods to Find Differences](#) (page 12-3)
- [Invoking diff and difftoDoc Methods in a Java Application](#) (page 12-7)
- [Using Java XML hash and equal Methods to Identify and Compare Inputs](#) (page 12-10)
- [Diff Output Schema](#) (page 12-10)

12.1 Overview of XML Diffing Utilities for Java

The Java XML diffing library includes diffing, hashing, and equality-comparison methods for XML inputs in class `XmlUtils` of package `oracle.xml.diff`.

The `Options` class in the `oracle.xml.diff` package provides options that enable users to control how the input is processed by the methods in the `XmlUtils` class (see [User Options for the Java XML Diffing Library](#) (page 12-2)). One of these supported options is white space normalization, which is enabled by default.

The algorithm used by the XML diffing methods is specifically designed for the use case of finding differences between two large XML documents (5 MB or more) within seconds, where the minimal diff is not required. The minimal diff is the smallest possible set of changes which, when applied to the first XML input, produces an output equivalent (identical) to the second XML input. Known minimal diff algorithms require prohibitively large amounts of memory and time for processing multimegabyte inputs. The algorithm used in the XML diff methods produces best quality (as close to minimal as possible) diffs in the absence of recurring identical subtrees in the XML inputs.

The Java XML diffing library provides several equivalent variants of each method to allow XML inputs in different forms, including Document Object Model (DOM) nodes, files, and input streams. Internally, the diffing, hashing, and equality comparisons operate on a DOM tree. Input that is not in the form of a DOM tree is internally converted to a DOM tree. To reduce computational overhead, Oracle recommends passing in DOM directly whenever possible.

The Java XML diffing library includes methods to return the diff output as a DOM document, or as a list of objects, each representing a diff operation. With the second

option, you can avoid the overhead of XML document generation. With the first option, the resulting document conforms to the XML schema described in [Diff Output Schema](#) (page 12-10). The first option is useful, for example, if the diff output must be stored as a log for future reference.

The hash methods provided by the Java XML diffing library compute the hash value of XML input. If the hash values of the two XML inputs are equal, they are identical with a very high probability.

The equal methods provided in the Java XML diffing library compare two inputs for equality.

To use the Java XML diffing library, your application must run with Java version 1.6 or later, with any DOM implementation.

Note:

The application programming interface (API) components described in this chapter are contained within the Java package `oracle.xml.diff`. For brevity, fully qualified names are used only when necessary to avoid confusion.

See *Oracle Database XML Java API Reference* for more information about the `oracle.xml.diff` package.

12.2 User Options for the Java XML Diffing Library

The Java XML diffing library supports two options, which you can set using methods in the `Options` class of the `oracle.xml.diff` package. The `Options` object is passed in directly to the `diff`, `hash`, and `equal` methods on each invocation.

- Text Node Normalization (enabled by default)

Text nodes are normalized in the DOM trees on which the `diff`, `hash`, and `equal` methods operate. Text node normalization involves coalescing adjacent text nodes, followed by stripping leading and trailing white space from the coalesced nodes. Single text nodes have their leading and trailing white space stripped. White-space-only text nodes are eliminated.

Normalization is performed within the library with minimal additional space, and without modifying the provided XML inputs.

To perform your own normalization on the DOM inputs before passing them to the library, you must invoke the method `normalizeTextNodes(false)` on the `Options` object to turn off the default normalization.

Oracle does not recommend invoking the `diff` methods without performing some type of normalization, either the default or your own. The `diff` quality suffers in the presence of identical white space text nodes, which commonly occur in XML documents.

- Ignoring Namespace Prefix Differences (enabled by default)

XML namespace prefix differences are ignored by the `diff`, `hash`, and `equal` methods. For example, two DOM nodes are considered equal if they are identical except for having different prefixes (even if the two different prefixes map to Universal Resource Identifier (URI) of the same namespace). To configure the library to treat different namespace prefixes as truly different, even if they map to

the same URI, you can invoke the method `ignorePrefixDifferences(false)` on the `Options` object to turn off the default namespace prefix behavior.

See Also:

Oracle Database XML Java API Reference for details about the methods in the `Options` class

12.3 Using Java XML Diffing Methods to Find Differences

The Java XML diffing library provides various `diff` and `diffToDoc` methods in the `XmlUtils` class of the `oracle.xml.diff` package. You can use these methods to compare two XML inputs to determine if there are any differences between them.

The `diffToDoc` methods return the output as a DOM document that conforms to the schema described in [Diff Output Schema](#) (page 12-10). The Java XML diffing library includes several equivalent variants of these methods, which accept inputs in different forms (DOM nodes, files, and others).

The Java XML diffing library includes an equivalent set of `diff` methods that enable you to work on the diff output that is returned as a list of diff operation objects.

Because the DOM document that represents the diff does not need to be constructed, using the `diff` methods is more efficient than using the `diffToDoc` methods. You should consider using these methods whenever you do not need a representation of the diff in XML form. To use the `diff` methods, you must create an implementation of the `DiffOpReceiver` interface, and then pass it as a parameter to the `diff` methods. The `DiffOpReceiver.receiveDiff` method receives the diff as a list of `DiffOp` objects.

The diff result, whether it is returned as a DOM document or as a list of `DiffOps` objects, can be understood as a series of diff operations. The possible diff operations are:

- append-node
- insert-node-before
- delete-node

Applying the sequence of diff operations on the first DOM tree produces a tree that is equivalent to the second DOM tree. For example, using these two XML inputs:

First input: `<a>`

Second input: `<a><c/>`

The diff result from comparing the first and second input is a list, with these two diff operations:

```
delete-node /a[1]/b[1]
append-node <c/> to /a[1]
```

Deleting the node represented by the XPath expression `/a/b` in the first input, and then appending `<c/>` to the node represented by the XPath expression `/a` in the first input produces the result `<a><c/>`, which is equivalent to the second input.

When the diff operations are output to a DOM document by the `domToDoc(...)` method, they rely on XPath expressions to indicate the node locations. These XPath

locations refer to node positions in the original first input. They do not reflect the applied diff operations.

Note:

The Java XML diffing library does not support append-node, insert-node-before, and delete-node operations for attribute nodes. Thus, when any attributes of a node are changed, the change is shown as a delete of the whole node, followed by the insert or the append of the new node with the changed attributes.

For example, for these two inputs:

First input: `<a attr1="val1">`

Second input: `<a attr2="val2">`

The diff consists of these two diff operations:

```
insert <a attr2="val2"><b/></a> before /a[1]
delete /a[1]
```

Topics:

- [About the append-node Operation](#) (page 12-4)
- [About the insert-node-before Operation](#) (page 12-5)
- [About the delete-node Operation](#) (page 12-6)

Note:

This section uses XML document output to describe each diff operation. Although they are not described here, diff operation results that are returned programmatically are equivalent.

See Also:

Oracle Database XML Java API Reference for more information about the `DiffOpReceiver` interface, and for details about the methods in the `XmlUtils` class

12.3.1 About the append-node Operation

The append-node operation specifies that a given node is to be appended as the last child of a particular first input node.

[Example 12-1](#) (page 12-5) shows an append-node operation that adds the highlighted node `<enumeration value="FL"/>` to a document.

Invoking a `diffToDoc(...)` method, using the original document (without the highlighted change) and the changed document as input produces this output:

```
<xd:append-node
  xd:parent-xpath="/schema[1]/simpleType[1]/restriction[1]"
  xd:node-type="element">
```

```

    <xd:content>
      <enumeration value="FL"/>
    </xd:content>
  </xd:append-node>

```

The `append-node` operation is represented by the `<append-node>` element in the preceding output. This element specifies that a node of the given type is added as the last child of the given first input parent node. The `parent-xpath` attribute specifies the parent node. The `node-type` attribute specifies the type of the node to be appended. The `<content>` child element specifies the node to be appended.

Alternatively, when the `diff(...)` methods are used, the `append-node` operation is accessible in the `DiffOpReceiver.receiverDiff(...)` method as a `DiffOp` object. In this case, the operation returns the actual references to the nodes in the two DOM trees involved in the `diff` operation. The reference to the parent node in the first input is returned by invoking the `getParent()` method of `DiffOp`. The reference to the node to be appended from the second input is returned by invoking the `getNew()` method of `DiffOp`.

Example 12-1 Appending a Node

```

<schema>
...
  <simpleType name="USState">
    <restriction base="string">
      <enumeration value="NY"/>
      <enumeration value="TX"/>
      <enumeration value="CA"/>
      <enumeration value="FL"/>
    </restriction>
  </simpleType>
...
</schema>

```

12.3.2 About the insert-node-before Operation

The `insert-node-before` operation specifies that a given node is to be inserted before a particular node in the first input.

[Example 12-2](#) (page 12-6) shows an `insert-node-before` operation that inserts the highlighted node `<!-- A type representing US States -->` before the node `<simpleType name="USState">` in a document.

Invoking a `diffToDoc(...)` method, using the original document (without the highlighted change) and the changed document as input produces this output:

```

<xd:insert-node-before xd:node-type="comment"
  xd:xpath="/schema[1]/simpleType[1]">
  <xd:content>
    <!-- A type representing US States -->
  </xd:content>
</xd:insert-node-before>

```

The `insert-node-before` operation is represented by the `<insert-node-before>` element in the preceding output. This element specifies that a node of the given type is inserted before the given first input node. The `xpath` attribute specifies the location of the first input node. The `node-type` attribute specifies the type of the node to be inserted. The `<content>` child element specifies the node to be inserted.

Alternatively, when the `diff(...)` methods are used, the `insert-node-before` operation is accessible in the `DiffOpReceiver.receiverDiff(...)` method as a `DiffOp`

object. In this case, the operation returns the actual references to the nodes in the two DOM trees involved in the diff operation. The reference to the node before which to insert a node in the first input is returned by invoking the `getSibling()` method of `DiffOp`. The reference to the node to be inserted from the second input is returned by invoking the `getNew()` method of `DiffOp`.

Example 12-2 Inserting a Node

```
<schema>
...
  <!-- A type representing US States -->
  <simpleType name="USState">
    <restriction base="string">
      <enumeration value="NY"/>
      <enumeration value="TX"/>
      <enumeration value="CA"/>
    </restriction>
  </simpleType>
...
</schema>
```

12.3.3 About the delete-node Operation

The delete-node operation specifies that a particular node (and its subtree) in the first input is to be deleted.

[Example 12-3](#) (page 12-6) shows a delete-node operation that deletes the highlighted node `<element name="LineItems" maxOccurs="unbounded">` from a document.

Invoking a `diffToDoc(...)` method, using the original document (without the highlighted change) and the changed document as input produces this output:

```
<xd:delete-node xd:node-type="element" xd:xpath=
  "/schema[1]/element[1]/complexType[1]/sequence[1]/element[1]/element[1]"/>
```

The delete-node operation is represented by the `<delete-node>` element in the preceding output. This element specifies that a node of the given type is deleted. The `xpath` attribute specifies the location of the first input node. The `node-type` attribute specifies the type of the node to be deleted.

Alternatively, when the `diff(...)` methods are used, the delete-node operation is accessible in the `DiffOpReceiver.receiverDiff(...)` method as a `DiffOp` object. In this case, the operation returns the actual reference to the node in the first input DOM tree. The reference to the node to be deleted from the first input is returned by invoking `getCurrent()` method of `DiffOp`.

Example 12-3 Deleting a Node

```
<schema>
...
  <element name="PurchaseOrder">
    <complexType>
      <sequence>
        <element name="PO-Number" type="string">
          <element name="LineItems" maxOccurs="unbounded">
...
</schema>
```

12.4 Invoking diff and diffToDoc Methods in a Java Application

Examples here show how to compare two inputs by invoking `diff` and `diffToDoc` methods from a Java application.

[Example 12-4](#) (page 12-8) shows how to use the `diffToDoc` method to compare the input files `doc` and `doc1`.

Continuing with this example, the two input files `f1.xml` and `f2.xml` contain the same data as in [Example 12-1](#) (page 12-5).

This sample code displays the contents of `f1.xml`:

```
<schema>
  <simpleType name="USState">
    <restriction base="string">
      <enumeration value="NY"/>
      <enumeration value="TX"/>
      <enumeration value="CA"/>
    </restriction>
  </simpleType>
</schema>
```

And this sample code displays the contents of `f2.xml`:

```
<schema>
  <simpleType name="USState">
    <restriction base="string">
      <enumeration value="NY"/>
      <enumeration value="TX"/>
      <enumeration value="CA"/>
      <enumeration value="FL"/>
    </restriction>
  </simpleType>
</schema>
```

Assume that `textDiff.java` and the input files are in the current directory. Then enter these commands to compile and run the example:

```
javac -classpath "xml.jar" textDiff.java
java -classpath "xml.jar:." textDiff f1.xml f2.xml
```

Serializing the resulting `diffAsDom` document produces this output:

```
<xd:xdiff xmlns:xd="http://xmlns.oracle.com/xdb/xdiff.xsd"
  xmlns:xsi="http://www.w3.org/2001/XMLSchema-instance" xsi:schemaLocation="http://
xmlns.oracle.com/xdb/xdiff.xsd http://xmlns.oracle.com/xdb/xdiff.xsd">
  <?oracle-xmldiff operations-in-docorder="true"
  output-model="snapshot" diff-algorithm="greedy-heuristic"?>
  <xd:append-node xd:node-type="element"
  xd:parent-xpath="/schema[1]/simpleType[1]/restriction[1]">
    <xd:content>
      <enumeration value="FL"/>
    </xd:content>
  </xd:append-node>
</xd:xdiff>
```

[Example 12-5](#) (page 12-8) shows how to use an implementation of the `DiffOpReceiver` interface to process the `diff` returned from the comparison between two XML inputs as a list of `DiffOp` objects.

Enter these commands to compile and run the example:

```
javac -classpath "xml.jar" progDiff.java
java -classpath "xml.jar:." progDiff f1.xml f2.xml
```

The example generates this output:

```
APPENDING NODE:
<enumeration value="FL"/>
TO THE PARENT NODE:
<restriction base="string">
  <enumeration value="NY"/>
  <enumeration value="TX"/>
  <enumeration value="CA"/>
</restriction>
```

Example 12-4 Getting a diff as a Document from a Java Application

```
import oracle.xml.diff.XmlUtils;
import oracle.xml.diff.Options;

import java.io.File;

import org.w3c.dom.Node;
import org.w3c.dom.Document;

import javax.xml.parsers.DocumentBuilderFactory;
import javax.xml.parsers.DocumentBuilder;

public class textDiff
{
    public static void main(String[] args) throws Exception
    {
        XmlUtils xmlUtils = new XmlUtils();

        //Parse the two input files
        DocumentBuilderFactory dbFactory =
            DocumentBuilderFactory.newInstance();
        dbFactory.setNamespaceAware(true);
        DocumentBuilder docBuilder =
            dbFactory.newDocumentBuilder();
        Node doc = docBuilder.parse(new File(args[0]));
        Node doc1 = docBuilder.parse(new File(args[1]));

        //Run the diff
        try
        {
            Document diffAsDom = xmlUtils.diffToDoc(doc,
                doc1, new Options());
        }
        catch (Exception e)
        {
            e.printStackTrace();
        }
    }
}
```

Example 12-5 Getting a diff Using DiffOpReceiver from a Java Application

```
import oracle.xml.diff.DiffOp;
import oracle.xml.diff.DiffOpReceiver;
```

```

import java.util.List;
import java.util.Properties;

import java.io.File;

import org.w3c.dom.Node;

import javax.xml.parsers.DocumentBuilderFactory;
import javax.xml.parsers.DocumentBuilder;

public class progDiff
{
    public static void main(String[] args) throws Exception
    {
        XmlUtils xmlUtils = new XmlUtils();

        //Parse the two input files
        DocumentBuilderFactory dbFac =
            DocumentBuilderFactory.newInstance();
        dbFac.setNamespaceAware(true);
        DocumentBuilder docBuilder = dbFac.newDocumentBuilder();
        Node doc = docBuilder.parse(new File(args[0]));
        Node doc1 = docBuilder.parse(new File(args[1]));

        Options opt = new Options();

        //Instantiate the DiffOpReceiver. This is the object that
        //will receive DiffOps, ie diff operations that the XmlDiff
        //outputs. Each object represents either deletion or insert
        //or append of a node. In this DiffOpReceiverImpl
        //implementation (see below) of the DiffOpReceiver
        //interface, we simply print out each diff operation.
        DiffOpReceiver diffOpRec =
            new progDiff().new DiffOpReceiverImpl();
        xmlUtils.diff(doc, doc1, diffOpRec, opt);
    }

    class DiffOpReceiverImpl implements DiffOpReceiver
    {
        public void receiveDiff(List<DiffOp> diffOps)
        {
            try
            {
                for (int i = 0; i < diffOps.size(); i++)
                {
                    DiffOp diffOperation= diffOps.get(i);

                    //Delete operation, print out the deleted
                    // node from the first tree
                    if (diffOperation.getOpName() ==
                        DiffOp.Name.DELETE)
                        System.out.println ("DELETING NODE:\n" +
                            XmlUtils.nodeToString(diffOperation.getCurrent(), false));

                    //Insert operation. Print out the node
                    //from the second tree to be inserted,
                    //and the node from the first tree
                    //before which the insertion will happen
                    else if (diffOperation.getOpName() ==
                        DiffOp.Name.INSERT_BEFORE_NODE)
                        System.out.println ("INSERTING NODE:\n" +

```

```
        XmlUtils.nodeToString(diffOperation.getNew(), false) +
                                "BEFORE NODE:\n" +
        XmlUtils.nodeToString(diffOperation.getSibling(), false));

        //Append as the last node of the parent.
        //Print out the node from the second tree
        //that will be appended, and the parent
        //node from the first tree to which the
        //former node will be appended as the
        //last child.
        else if (diffOperation.getOpName() ==
                DiffOp.Name.INSERT_BY_APPENDING)
            System.out.println ("APPENDING NODE:\n" +
                XmlUtils.nodeToString(diffOperation.getNew(), false) +
                                "TO THE PARENT NODE:\n" +
                XmlUtils.nodeToString(diffOperation.getParent(), false));
    }
}
catch (Exception e)
{
    System.err.println ("Error while printing out the
                        diff result:" + e.getMessage());
}
}
}
```

12.5 Using Java XML hash and equal Methods to Identify and Compare Inputs

The Java XML diffing library provides hash methods to compute a hash value that uniquely identifies the input, with a high probability. Because there is a very low probability of a hash collision, there can be no guarantee that two inputs are identical when their hash values match.

To check that two inputs are truly identical with absolute certainty, use the `equal` methods. The `equal` methods process both inputs simultaneously, while checking them for absolute equality.

The Java XML diffing library provides several equivalent variants of the `hash` and `equal` methods that accept inputs in different forms (DOM nodes, files, and more).

See Also:

Oracle Database XML Java API Reference for details about the `hash` and `equal` methods in the `XmlUtils` class

12.6 Diff Output Schema

The output schema `xdiff.xsd`, to which the Java XML diffing library conforms, is presented.

Example 12-6 Diff Output Schema: `xdiff.xsd`

```
<schema targetNamespace="http://xmlns.oracle.com/xdb/xdiff.xsd"
        xmlns="http://www.w3.org/2001/XMLSchema"
        xmlns:xd="http://xmlns.oracle.com/xdb/xdiff.xsd"
```



```

version="1.0" elementFormDefault="qualified"
attributeFormDefault="qualified">
<annotation>
  <documentation xml:lang="en">
    Defines the structure of XML documents that capture the difference
    between two XML inputs. Changes that are not supported by Oracle
    XmlDiff may not be expressible in this schema.

    'oracle-xmldiff' PI:

    We use 'oracle-xmldiff' PI to describe certain aspects of the diff.
    This should be the first element of top level xdiff element.

    version-number: version number of the XML diff schema

    output-model: output model for representing the diff. Currently, only
    the "snapshot" model is supported.

    Snapshot model:
    Each operation uses XPath as if no operations
    have been applied to the input document.
    Default and works for both XmlDiff and XmlPatch.

    <!-- Example:
    <?oracle-xmldiff version-number = "1.0" output-model = "snapshot"?>
    -->
  </documentation>
</annotation>
<!-- Enumerate the supported node types -->
<simpleType name="xdiff-nodetype">
  <restriction base="string">
    <enumeration value="element"/>
    <enumeration value="text"/>
    <enumeration value="cdata"/>
    <enumeration value="processing-instruction"/>
    <enumeration value="comment"/>
  </restriction>
</simpleType>

<element name="xdiff">
  <complexType>
    <choice minOccurs="0" maxOccurs="unbounded">

      <element name="append-node">
        <complexType>
          <sequence>
            <element name="content" type="anyType"/>
          </sequence>
          <attribute name="node-type" type="xd:xdiff-nodetype"/>
          <attribute name="parent-xpath" type="string"/>
        </complexType>
      </element>

      <element name="insert-node-before">
        <complexType>
          <sequence>
            <element name="content" type="anyType"/>
          </sequence>
          <attribute name="xpath" type="string"/>
          <attribute name="node-type" type="xd:xdiff-nodetype"/>
        </complexType>
      </element>

      <element name="delete-node">
        <complexType>
          <attribute name="node-type" type="xd:xdiff-nodetype"/>
          <attribute name="xpath" type="string"/>
        </complexType>
    </choice>
  </complexType>
</element>

```

```
        </element>
      </choice>
    </complexType>
  </element>
</schema>
```

Using the XML SQL Utility

An explanation is given of how to use the Extensible Markup Language (XML) SQL Utility (XSU).

Topics:

- [Introduction to the XML SQL Utility \(XSU\)](#) (page 13-1)
- [Using the XML SQL Utility: Overview](#) (page 13-3)
- [Programming with the XSU Java API](#) (page 13-19)
- [Programming with the XSU PL/SQL API](#) (page 13-33)
- [Tips and Techniques for Programming with XSU](#) (page 13-41)

13.1 Introduction to the XML SQL Utility (XSU)

XML SQL Utility (XSU) is an Oracle XML Developer's Kit (XDK) component that lets you transfer XML data using Oracle SQL statements.

You can use [XML SQL Utility \(XSU\)](#) to perform these tasks:

- Transform data in object-relational database tables or views into XML. XSU can query the database and return the result set as an XML document.
- Extract data from an XML document and use canonical mapping to insert the data into a table or a view or update or delete values of the appropriate columns or attributes.

Topics:

- [Prerequisites for Using the XML SQL Utility \(XSU\)](#) (page 13-1)
- [XSU Features](#) (page 13-2)
- [XSU Restrictions](#) (page 13-2)

13.1.1 Prerequisites for Using the XML SQL Utility (XSU)

Prerequisites for using the XML SQL Utility (XSU) are covered.

This section assumes that you are familiar with these technologies:

- Oracle Database structured query language (SQL). XSU transfers XML to and from a database through `SELECT` statements and data manipulation language (DML).

- Procedural Language/Structured Query Language (PL/SQL). XDK supplies a PL/SQL application programming interface (API) for XSU that mirrors the Java API.
- [Java Database Connectivity \(JDBC\)](#). Java applications that use XSU to transfer XML to and from a database require a JDBC connection.

13.1.2 XSU Features

The main features provided by XML SQL Utility (XSU) are described.

XSU:

- Dynamically generates document type definitions (DTDs) or XML schemas.
- Generates XML documents in their string or Document Object Model (DOM) representations.
- Performs simple transformations during generation such as modifying default tag names for each <ROW> element. You can also register an XSL transformation that XSU applies to the generated XML documents as needed.
- Generates XML as a stream of Simple API for XML (SAX2) callbacks.
- Supports XML attributes during generation, which enables you to specify that a particular column or group of columns maps to an XML attribute instead of an XML element.
- Allows SQL-to-XML-tag escaping. Sometimes column names are not valid XML tag names. To avoid this problem you can either alias all the column names or turn on tag escaping.
- Supports XMLType columns in objects or tables.
- Inserts XML into relational database tables or views. When given an XML document, XSU can also update or delete records from a database object.

13.1.3 XSU Restrictions

Some restrictions for using XSU are described.

- XSU can store data only in a single table. You can store XML across tables, however, by using the Oracle Extensible Stylesheet Language Transformation (XSLT) processor to transform a document into multiple documents and inserting them separately. You can also define views over multiple tables and perform insertions into the views. If a view is nonupdatable (because of complex joins), then you can use `INSTEAD OF` triggers over the views to perform the inserts.
- You cannot use XSU to load XML data stored in attributes into a database schema, but you can use an XSLT transformation to change the attributes into elements.
- By default XSU is case-sensitive. You can either use the correct case, or specify that case is to be ignored.
- XSU cannot generate a relational database schema from an input DTD.
- Inserting into XMLType tables using XSU is not supported. XMLType columns are supported.

13.2 Using the XML SQL Utility: Overview

Topics here include basic XSU use, installing XSU, running the XSU demo programs, and using the XSU command-line utility.

Topics:

- [Using XSU: Basic Process](#) (page 13-3)
- [Installing XSU](#) (page 13-8)
- [Running the XSU Demo Programs](#) (page 13-11)
- [Using the XSU Command-Line Utility](#) (page 13-15)

13.2.1 Using XSU: Basic Process

The basic process of using XSU is described.

XSU is accessible through these interfaces:

- The `OracleXMLQuery` and `OracleXMLSave` Java classes in the `oracle.xml.sql.query` package. Use the `OracleXMLQuery` class to generate XML from relational data and `OracleXMLSave` class to perform DML.
- PL/SQL packages `DBMS_XMLQuery` and `DBMS_XMLSave`, which mirror the Java classes.

You can write these types of XSU applications:

- Java programs that run inside the database and access the internal XSU Java API
- Java programs that run on the client and access the client-side XSU Java API
- PL/SQL programs that access XSU through PL/SQL packages

13.2.1.1 Generating XML with the XSU Java API: Basic Process

Class `OracleXMLQuery` makes up the XML generation part of the XSU Java API.

[Figure 13-1](#) (page 13-3) shows the basic process for generating XML with XSU.

The basic steps in [Figure 13-1](#) (page 13-3) are:

Figure 13-1 *Generating XML with XSU*

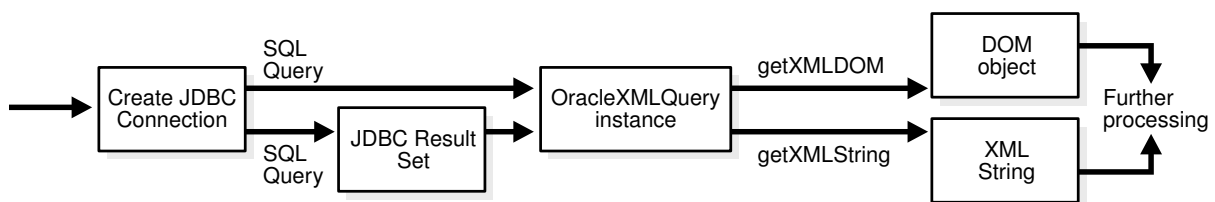

1. Create a JDBC connection to the database. Normally, you establish a connection with the `DriverManager` class, which manages a set of JDBC drivers. After the JDBC drivers are loaded, invoke `getConnection()`. When it finds the right driver, this method returns a `Connection` object that represents a database session. All SQL statements are executed within the context of this session.

You have these options:

- Create the connection with the JDBC Oracle Call Interface (OCI) driver. This code fragment shows this technique:

```
// import the Oracle driver class
import oracle.jdbc.*;
// load the Oracle JDBC driver
DriverManager.registerDriver(new oracle.jdbc.OracleDriver());
// create the connection
Connection conn =
    DriverManager.getConnection("jdbc:oracle:oci:@", "hr", "password");
```

The preceding example uses the default connection for the JDBC OCI driver.

- Create the connection with the JDBC thin driver. The thin driver is written in pure Java and can be called from any Java program. This code fragment shows this technique:

```
Connection conn =
    DriverManager.getConnection("jdbc:oracle:thin:@dlsun489:1521:ORCL",
        "hr", "password");
```

The thin driver requires the host name (dlsun489), port number (1521), and the Oracle system identifier (SID), ORCL. The database must have an active Transmission Control Protocol/Internet Protocol (TCP/IP) listener.

- Use default connection used by the server-side internal JDBC driver. This driver runs within a default session and default transaction context. You are already connected to the database; your SQL operations are part of the default transaction. Thus, you do not have to register the driver. Create the Connection object:

```
Connection conn = new oracle.jdbc.OracleDriver().defaultConnection ();
```

Note:

OracleXMLDataSetExtJdbc is used only for Oracle JDBC, whereas OracleXMLDataSetGenJdbc is used for non-Oracle JDBC. These classes are in the oracle.xml.sql.dataset package.

2. Create an XML query object and assign it a SQL query. You create an OracleXMLQuery Class instance by passing a SQL query to the constructor, as shown in this example:

```
OracleXMLQuery qry = new OracleXMLQuery (conn, "SELECT * from EMPLOYEES");
```

3. Configure the XML query object by invoking OracleXMLQuery methods. This example specifies that only 20 rows are to be included in the result set:

```
xmlQry.setMaxRows(20);
```

4. Return a DOM object or string by invoking OracleXMLQuery methods. For example, get a DOM object:

```
XMLDocument domDoc = (XMLDocument)qry.getXMLDOM();
```

Get a string object:

```
String xmlString = qry.getXMLString();
```

5. Perform additional processing on the string or DOM as needed.

See Also:

- *Oracle Database Java Developer's Guide* to learn about Oracle JDBC
 - *Oracle Database XML Java API Reference* to learn about OracleXMLQuery methods
-
-

13.2.1.2 Performing DML with the XSU Java API: Basic Process

Use the `OracleXMLSave` class to insert, update, and delete XML in the database.

[Figure 13-2](#) (page 13-5) shows the basic process.

Figure 13-2 Storing XML in the Database Using XSU

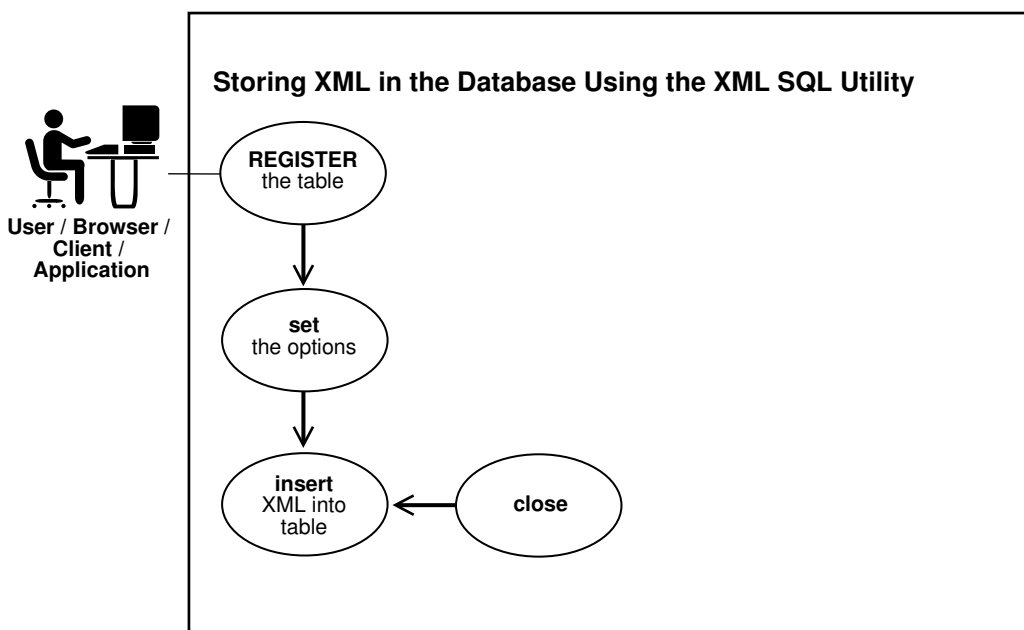

The basic steps in [Figure 13-2](#) (page 13-5) are:

1. Create a JDBC connection to the database. This step is identical to the first step described in [Generating XML with the XSU Java API: Basic Process](#) (page 13-3).
2. Create an XML save object and assign it a table on which to perform DML. Pass a table or view name to the constructor, as shown in this example:

```
OracleXMLSave sav = new OracleXMLSave(conn, "employees");
```

3. Specify the primary key columns. For example, this code specifies that `employee_id` is the key column:

```
String [] keyColNames = new String[1];
keyColNames[0] = "EMPLOYEE_ID";
sav.setKeyColumnList(keyColNames);
```

4. Configure the XML save object by invoking `OracleXMLSave` methods. This example specifies an update of the `salary` and `job_id` columns:

```
String[] updateColNames = new String[2];
updateColNames[0] = "SALARY";
updateColNames[1] = "JOB_ID";
sav.setUpdateColumnList(updateColNames); // set the columns to update
```

5. Invoke the `insertXML()`, `updateXML()`, or `deleteXML()` methods on the `OracleXMLSave` object. This example shows an update:

```
// Assume that the user passes in this XML document as the first argument
sav.updateXML(sav.getURL(argv[0]));
```

When performing the DML, XSU performs these tasks:

- a. Parses the input XML document.
 - b. Matches element names to column names in the target table or view.
 - c. Converts the elements to SQL types and binds them to the appropriate statement.
6. Close the `OracleXMLSave` object and deallocate all contexts associated with it, as shown in this example:

```
sav.close();
```

See Also:

- *Oracle Database Java Developer's Guide* to learn about JDBC
 - *Oracle Database XML Java API Reference* to learn about `OracleXMLSave`
-
-

13.2.1.3 Generating XML with the XSU PL/SQL API: Basic Process

The XSU PL/SQL API reflects the Java API in the generation and storage of XML documents from and to a database. Package `DBMS_XMLQuery` reflects the methods in Java class `OracleXMLQuery`.

Package `DBMS_XMLQuery` has a context handle associated with it. Create a context by invoking a constructor-like function to get the handle, and then use the handle in all subsequent invocations.

Note:

For improved performance, consider using the C-based `DBMS_XMLGEN`, which is written in C and built into the database, rather than `DBMS_XMLQUERY`.

XSU supports the `XMLType` data type. Using XSU with `XMLType` is useful if, for example, you have `XMLType` columns in objects or tables.

Generating XML results in a character large object (CLOB) that contains the XML document. To use `DBMS_XMLQuery` and the XSU generation engine, follow these basic steps:

1. Declare a variable for the XML query context and a variable for the generated XML. For example:

```
v_queryCtx DBMS_XMLQuery.ctxType;
v_result   CLOB;
```

2. Get a context handle by invoking the `DBMS_XMLQuery.newContext` function and supplying it the query, either as a CLOB or a VARCHAR2. This example registers a query to select the rows from the `employees` table with the WHERE clause containing the bind variables `:EMPLOYEE_ID` and `:FIRST_NAME`:

```
v_queryCtx = DBMS_XMLQuery.newContext('SELECT * FROM employees
                                     WHERE employee_id=:EMPLOYEE_ID AND first_name=:FIRST_NAME');
```

3. Bind values to the query. The binds work by binding a name to the position. `clearBindValues` clears all the bind variables, whereas `setBindValue` sets a single bind variable with a string value. For example, bind the `employee_id` and `first_name` values as shown:

```
DBMS_XMLQuery.setBindValue(v_queryCtx, 'EMPLOYEE_ID', 20);
DBMS_XMLQuery.setBindValue(v_queryCtx, 'FIRST_NAME', 'John');
```

4. Configure the query context. Set optional arguments such as the ROW tag name, the ROWSET tag name, or the number of rows to fetch, and so on. This example specifies changes the default ROWSET element name to `EMPSET`:

```
DBMS_XMLQuery.setRowSetTag(v_queryCtx, 'EMPSET');
```

5. Fetch the results. You can get the XML as a CLOB with the `getXML` function, which generates XML with or without a DTD or XML schema. This example applies bind values to the statement and gets the result corresponding to the predicate `employee_id = 20` and `first_name = 'John'`:

```
v_result := DBMS_XMLQuery.getXML(v_queryCtx);
```

6. Process the results of the XML generation. For example, suppose that your program declared these variables:

```
v_xmlstr VARCHAR2(32767);
v_line   VARCHAR2(2000);
```

You can print the CLOB stored in `v_result`:

```
v_xmlstr := DBMS_LOB.SUBSTR(v_result, 32767);
LOOP
  EXIT WHEN v_xmlstr IS NULL;
  v_line := substr(v_xmlstr, 1, INSTR(v_xmlstr, CHR(10))-1);
  DBMS_OUTPUT.PUT_LINE(' | ' || v_line);
  v_xmlstr := SUBSTR(v_xmlstr, INSTR(v_xmlstr, CHR(10))+1);
END LOOP;
```

7. Close the context. For example:

```
DBMS_XMLQuery.closeContext(v_queryCtx);
```

13.2.1.4 Performing DML with the PL/SQL API: Basic Process

`DBMS_XMLSave` is the PL/SQL package that reflects the methods in Java class `OracleXMLSave`. This package has a context handle associated with it. You create a context by invoking a constructor-like function to get the handle, and then use the handle in all subsequent invocations.

To use `DBMS_XMLSave`, follow these basic steps:

1. Declare a variable for the XML save context and a variable for the number of rows touched by the DML. For example:

```
savCtx DBMS_XMLSave.ctxType;
v_rows NUMBER;
```

2. Create a context handle by invoking the `DBMS_XMLSave.newContext` function and supply it the table name to use for the DML operations.

```
savCtx := DBMS_XMLSave.newContext('hr.employees');
```

3. Set options based on the type of DML to perform.

For inserts you can set the list of columns to insert into the `setUpdateColumn` function. The default is to insert values into all columns. This example sets five columns in the `employees` table:

```
DBMS_XMLSave.setUpdateColumn(savCtx, 'EMPLOYEE_ID');
DBMS_XMLSave.setUpdateColumn(savCtx, 'LAST_NAME');
DBMS_XMLSave.setUpdateColumn(savCtx, 'EMAIL');
DBMS_XMLSave.setUpdateColumn(savCtx, 'JOB_ID');
DBMS_XMLSave.setUpdateColumn(savCtx, 'HIRE_DATE');
```

For updates you must supply the list of key columns. Optionally, you can then supply the list of columns for update. In this case, the tags in the XML document matching the key column names are used in the `WHERE` clause of the `UPDATE` statement and the tags matching the update column list are used in the `SET` clause of the `UPDATE` statement. For example:

```
DBMS_XMLSave.setKeyColumn(savCtx, 'employee_id'); -- set key column
-- set list of columns to update.
DBMS_XMLSave.setUpdateColumn(savCtx, 'salary');
DBMS_XMLSave.setUpdateColumn(savCtx, 'job_id');
```

For deletes the default is to create a `WHERE` clause to match all the tag values present in each `<ROW>` element of the document supplied. To override this behavior, set the list of key columns. In this case only those tag values whose tag names match these columns are used to identify the rows to delete (in effect used in the `WHERE` clause of the `DELETE` statement). For example:

```
DBMS_XMLSave.setKeyColumn(savCtx, 'EMPLOYEE_ID');
```

4. Supply a context and XML document to the `insertXML`, `updateXML`, or `deleteXML` functions. For example:

```
v_rows := DBMS_XMLSave.deleteXML(savCtx,xmlDoc);
```

5. Repeat the DML any number of times if needed.
6. Close the context. For example:

```
DBMS_XMLSave.closeContext(savCtx);
```

For a model use the Java examples described in [Programming with the XSU Java API](#) (page 13-19).

13.2.2 Installing XSU

XSU is included as part of Oracle Database, along with the other XDK utilities.

[XDK for Java Component Dependencies](#) (page 3-2) describes the XSU components and dependencies.

By default, the Oracle Universal Installer installs XSU on disk and loads it into the database. No user intervention is required. If you did not load XSU in the database when installing Oracle, you can install XSU manually as follows:

1. Ensure that Oracle XML DB is installed (it is installed by default as part of Oracle Database).
2. Load the `xsu12.jar` file into the database. This JAR file, which has a dependency on `xdb.jar` for XMLType access, is described in [Table 3-1](#) (page 3-3).
3. Run the `$ORACLE_HOME/rdbms/admin/dbmsxsu.sql` script. This SQL script builds the XSU PL/SQL API.

As explained in [Using XSU: Basic Process](#) (page 13-3), you do not have to load XSU into the database to use it. XSU can reside in any tier that supports Java.

These sections describe your installation options:

- [XSU in the Database](#) (page 13-9)
- [XSU in an Application Server](#) (page 13-10)
- [XSU in a Web Server](#) (page 13-10)

13.2.2.1 XSU in the Database

The typical architecture is shown for applications that use the XSU libraries installed in the database.

[Figure 13-3](#) (page 13-9) illustrates this typical architecture. XML generated from XSU running in the database can be placed in advanced queues in the database to be queued to other systems or clients. You deliver the XML internally through stored procedures in the database or externally through web servers or application servers.

In [Figure 13-3](#) (page 13-9) all lines are bidirectional. Because XSU can generate and save data, resources can deliver XML to XSU running inside the database, which can then insert it in the appropriate database tables.

Figure 13-3 Running XSU in the Database

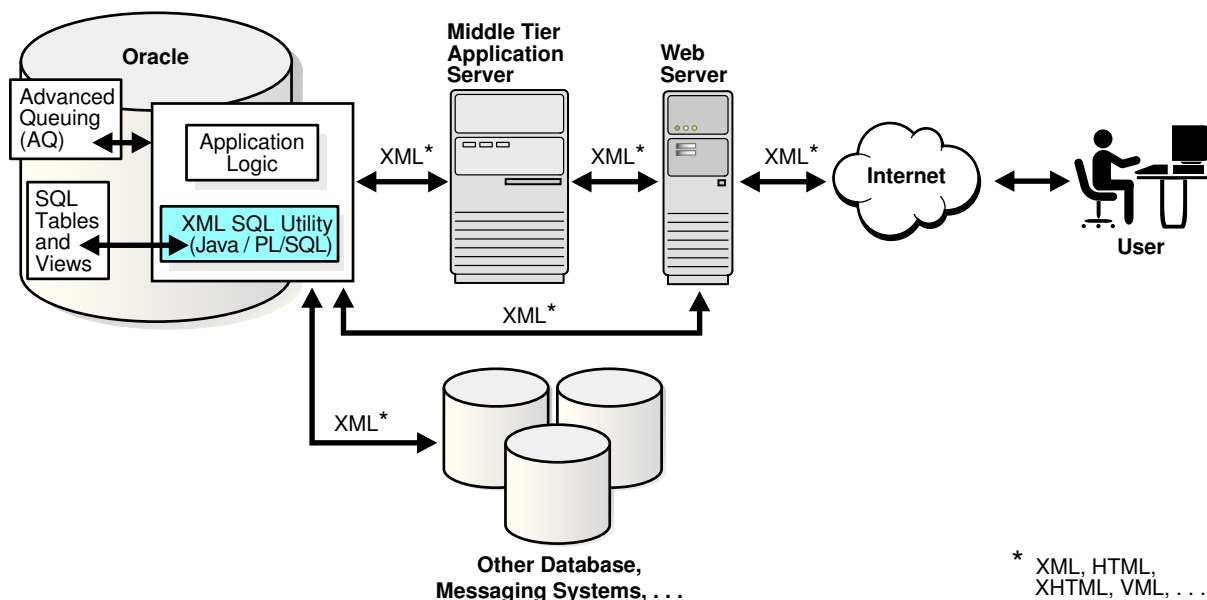

13.2.2.2 XSU in an Application Server

You can run XSU in an application server.

Your application architecture may require an application server in the middle tier. The application tier can be a database or an application server that supports Java programs.

You can generate XML in the middle tier from SQL queries or `ResultSet`s for various reasons, for example, to integrate different JDBC data sources in the middle tier. In this case, you can install XSU in your middle tier, thereby enabling your Java programs to make use of XSU through its Java API.

Figure 13-4 (page 13-10) shows a typical architecture for running XSU in a middle tier. In the middle tier, data from JDBC sources is converted by XSU into XML and then sent to web servers or other systems. Again, the process is bidirectional, which means that the data can be put back into the JDBC sources (database tables or views) with XSU. If a database is used as the application server, then you can use the PL/SQL front end instead of Java.

Figure 13-4 Running XSU in the Middle Tier

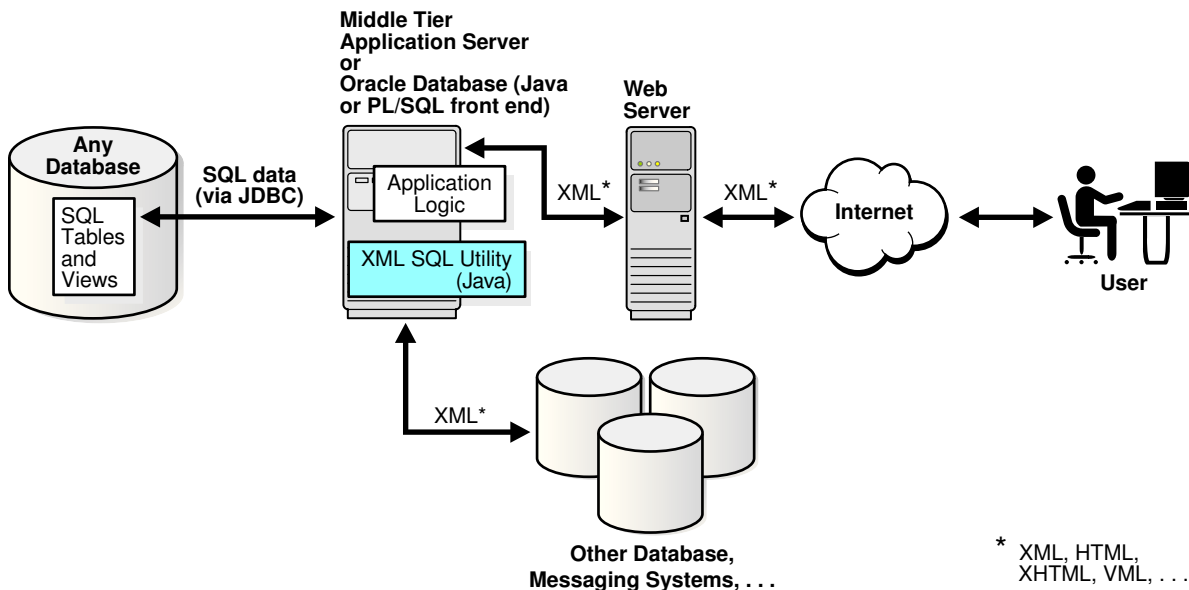

13.2.2.3 XSU in a Web Server

You can run XSU in a web server because the web server supports Java servlets.

Figure 13-5 (page 13-11) shows XSU running in a web server.

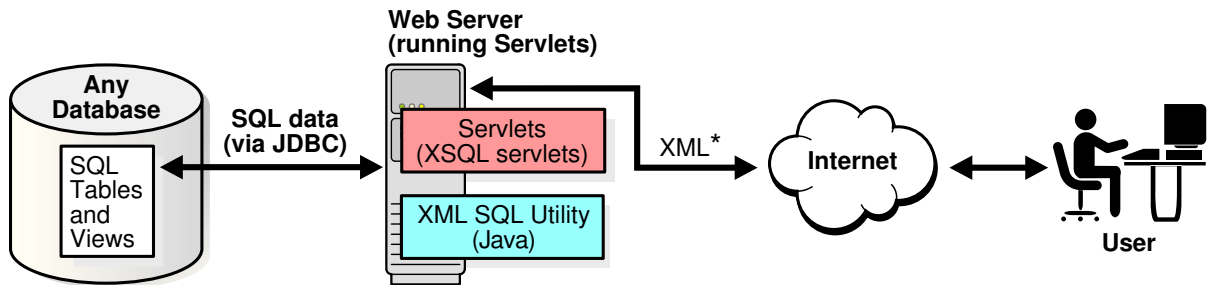
Figure 13-5 Running XSU in a Web Server

* XML, HTML, XHTML, VML, . . .

You can write Java servlets that use XSU. XSQL Servlet is a standard servlet provided by Oracle. It is built on top of XSU and provides a template-like interface to XSU functionality. To perform XML processing in the web server and avoid intricate servlet programming, you can use the XSQL Servlet.

See Also:

- *Oracle XML DB Developer's Guide*, especially the chapter on generating XML, for examples on using XSU with `XMLType`
 - *Oracle Database XML Java API Reference* to learn about the classes `OracleXMLQuery` and `OracleXMLSave`
 - *Oracle Database PL/SQL Packages and Types Reference* to learn about the package `DBMS_XMLQuery`
 - *Oracle Database PL/SQL Packages and Types Reference* to learn about the package `DBMS_XMLSave`
 - [Using the XSQL Pages Publishing Framework](#) (page 16-1) to learn about XSQL Servlet
-

13.2.3 Running the XSU Demo Programs

Demo programs for XSU are included in `$ORACLE_HOME/xdk/demo/java/xsu`.

[Table 13-1](#) (page 13-11) describes the XML files and programs that you can use to test XSU.

Table 13-1 XSU Sample Files

File	Description
<code>bindSQLVariables.sql</code>	An PL/SQL script that binds values for <code>EMPLOYEE_ID</code> and <code>FIRST_NAME</code> to columns in the <code>employees</code> table. See Binding Values in XSU (page 13-35).
<code>changeElementName.sql</code>	A PL/SQL program that gets the first 20 rows of the <code>employees</code> table as an XML document. See Specifying Element Names with DBMS_XMLQuery (page 13-34).

Table 13-1 (Cont.) XSU Sample Files

File	Description
<code>createObjRelSchema.sql</code>	A SQL script that sets up an object-relational schema and populates it. See XML Mapping Against an Object-Relational Schema (page 13-42).
<code>createObjRelSchema2.sql</code>	A SQL script that sets up an object-relational schema and populates it. See Altering the Database Schema or SQL Query (page 13-44).
<code>createRelSchema.sql</code>	A SQL script that creates a relational table and then creates a customer view that contains a customer object on top of it. See Altering the Database Schema or SQL Query (page 13-44).
<code>customer.xml</code>	An XML document that describes a customer. See Altering the Database Schema or SQL Query (page 13-44).
<code>deleteEmployeeByKey.sql</code>	A PL/SQL program that deletes an employee by primary key. See Deleting by Key with XSU (page 13-40).
<code>deleteEmployeeByRow.sql</code>	A PL/SQL program that deletes an employee by row. See Deleting by Row with XSU (page 13-39).
<code>domTest.java</code>	A program that generates a DOM tree and then traverses it in document order, printing the nodes one by one. See Generating a DOM Tree with OracleXMLQuery (page 13-21).
<code>index.txt</code>	A README that describes the programs in the demo directory.
<code>insProc.sql</code>	A PL/SQL program that inserts an XML document into a table. See Inserting Values into All Columns using XSU (page 13-35).
<code>insertClob.sql</code>	A SQL script that creates a table called <code>xmlDocument</code> and stores an XML document in the table as a CLOB. See Inserting Values into All Columns using XSU (page 13-35).
<code>insertClob2.sql</code>	A SQL script that inserts an XML document into the <code>xmlDocument</code> table. See Inserting into a Set of Columns using XSU (page 13-36).
<code>insertClob3.sql</code>	A SQL script that inserts an XML document into the <code>xmlDocument</code> table. See Updating Key Columns using PL/SQL (page 13-37).
<code>insertClob4.sql</code>	A SQL script that inserts an XML document into the <code>xmlDocument</code> table. See Updating a Set of Columns using XSU (page 13-38).
<code>insertEmployee.sql</code>	A PL/SQL script that invokes the <code>insProc</code> stored procedure and inserts an employee into the <code>employees</code> table. See Inserting XML using XSU (page 13-35).
<code>insertEmployee2.sql</code>	A PL/SQL script that invokes the <code>testInsert</code> procedure to insert the XML data for an employee into the <code>hr.employees</code> table. See Inserting into a Set of Columns using XSU (page 13-36).
<code>mapColumnToAtt.sql</code>	A SQL script that queries the <code>employees</code> table, rendering <code>employee_id</code> as an XML attribute. See Altering the Database Schema or SQL Query (page 13-44).

Table 13-1 (Cont.) XSU Sample Files

File	Description
<code>new_emp.xml</code>	An XML document that describes a new employee. See Running the testInsert Program (page 13-26).
<code>new_emp2.xml</code>	An XML document that describes a new employee. See Running the testInsertSubset Program (page 13-27).
<code>noRowsTest.java</code>	A program that throws an exception when there are no more rows. See Raising a No Rows Exception (page 13-32).
<code>pageTest.java</code>	A program that uses the JDBC <code>ResultSet</code> to generate XML one page at a time. See Generating Scrollable Result Sets (page 13-23).
<code>paginateResults.java</code>	A program that generates an XML page that paginates results. See Paginating Results with OracleXMLQuery: Example (page 13-23).
<code>paginateResults.sql</code>	A PL/SQL script that paginates results. It skips the first 3 rows of the <code>employees</code> table and then prints the rest of the rows 10 at a time by setting <code>skipRows</code> to 3 for the first batch of 10 rows and then to 0 for the rest of the batches. See Paginating Results with DBMS_XMLQUERY (page 13-34).
<code>printClobOut.sql</code>	A PL/SQL script that prints a CLOB to the output buffer. See Generating XML from Simple Queries with DBMS_XMLQuery (page 13-34).
<code>raiseException.sql</code>	A PL/SQL script that invokes the <code>DBMS_XMLQuery.getExceptionContent</code> procedure. See Handling Exceptions with XSU (page 13-40).
<code>refCurTest.java</code>	A program that generates XML from the results of the SQL query defined in the <code>testRefCur</code> function. See Generating XML from Cursor Objects (page 13-24).
<code>samp1.java</code>	A program that queries the <code>scott.emp</code> table, then generates an XML document from the query results.
<code>samp10.java</code>	A program that inserts <code>sampdoc.xml</code> into the <code>xmltest_tab1</code> table.
<code>samp2.java</code>	A program that queries the <code>scott.emp</code> table, then generates an XML document from the query results. This program demonstrates how you can customize the generated XML document.
<code>sampdoc.xml</code>	A sample XML data document that <code>samp10.java</code> inserts into the database.
<code>samps.sql</code>	A SQL script that creates the <code>xmltest_tab1</code> table used by <code>samp10.java</code> .
<code>simpleQuery.sql</code>	A PL/SQL script that selects 20 rows from the <code>hr.employees</code> table and gets an XML document as a CLOB. See Generating XML from Simple Queries with DBMS_XMLQuery (page 13-34).
<code>testDML.sql</code>	A PL/SQL script that uses the same context and settings to perform DML depending on user input. See Reusing the Context Handle with XSU (page 13-40).

Table 13-1 (Cont.) XSU Sample Files

File	Description
<code>testDeleteKey.java</code>	A program that limits the number of elements used to identify a row, which improves performance by caching the DELETE statement and batching transactions. See Deleting by Key with OracleXMLSave (page 13-31).
<code>testDeleteKey.sql</code>	A PL/SQL script that deletes a row from the <code>employees</code> table for every <ROW> element in an input XML document. See Deleting by Key with XSU (page 13-40).
<code>testDeleteRow.java</code>	A program that accepts an XML document file name as input and deletes the rows corresponding to the elements in the document. See Deleting by Row with OracleXMLSave (page 13-30).
<code>testDeleteRow.sql</code>	A SQL script that deletes a row from the <code>employees</code> table for every <ROW> element in an input XML document. See Deleting by Row with XSU (page 13-39).
<code>testException.java</code>	A sample program shown that throws a runtime exception and then gets the parent exception by invoking <code>Exception.getParentException()</code> . See Getting the Parent Exception (page 13-32).
<code>testInsert.java</code>	A Java program that inserts XML values into all columns of the <code>hr.employees</code> table. See Inserting XML into All Columns with OracleXMLSave (page 13-25).
<code>testInsert.sql</code>	A PL/SQL script that inserts XML data into a subset of columns. See Inserting into a Set of Columns using XSU (page 13-36).
<code>testInsertSubset.java</code>	A program shown that inserts XML data into a subset of columns. See Inserting XML into a Subset of Columns with OracleXMLSave (page 13-26).
<code>testRef.sql</code>	A PL/SQL script that creates a function that defines a REF cursor and returns it. Every time the <code>testRefCur</code> function is called, it opens a cursor object for the SELECT query and returns that cursor instance. See Generating XML from Cursor Objects (page 13-24).
<code>testUpdate.java</code>	A sample program that updates the <code>hr.employees</code> table by invoking the <code>OracleXMLSave.setKeyColumnList()</code> method. See Updating Rows Using OracleXMLSave (page 13-27).
<code>testUpdateKey.sql</code>	A PL/SQL that creates a PL/SQL procedure called <code>testUpdateKey</code> that uses the <code>employee_id</code> column of the <code>employees</code> table as a primary key. See Updating Key Columns using PL/SQL (page 13-37).
<code>testUpdateList.java</code>	Suppose you want to update only the salary and job title for each employee and ignore the other information. If you know that all the elements to be updated are the same for all ROW elements in the XML document, then you can use the <code>OracleXMLSave.setUpdateColumnNames()</code> method to specify the columns. See Updating a Column List Using OracleXMLSave (page 13-28).
<code>testUpdateSubset.sql</code>	A SQL script that creates the procedure <code>testUpdateSubset</code> . The procedure specifies the <code>employee_id</code> column as the key, and specifies that <code>salary</code> and <code>job_id</code> are to be updated. See Updating a Set of Columns using XSU (page 13-38).

Table 13-1 (Cont.) XSU Sample Files

File	Description
testXMLSQL.java	A sample program that uses XSU to generate XML as a <code>String</code> object. This program queries the <code>hr.employees</code> table and prints the result set to standard output. See Generating a String with OracleXMLQuery (page 13-20).
upd_emp.xml	An XML document that contains updated salary and other information for a series of employees. See Running the testUpdate Program (page 13-28).
upd_emp2.xml	An XML document that contains updated salary and other information for a series of employees. See Running the testUpdate Program (page 13-28).
updateEmployee.sql	An XML document that contains new data for two employees. See Running the testUpdateList Program (page 13-30).
updateEmployee2.sql	A PL/SQL script that passes an XML document to the <code>testUpdateSubset</code> procedure and generates two <code>UPDATE</code> statements. See Updating a Set of Columns using XSU (page 13-38).

The steps for running the demos are:

1. Change into the `$ORACLE_HOME/xdk/demo/java/xsu` directory (UNIX) or `%ORACLE_HOME%\xdk\demo\java\xsu` directory (Windows).
2. Ensure that your environment variables are set as described in [Setting Up the XDK for Java Environment](#) (page 3-5). In particular, ensure that the Java classpath includes `xsu12.jar` for XSU and `ojdbc6.jar` (Java 1.6) for JDBC. If you use a multibyte character set other than UTF-8, ISO8859-1, or JA16SJIS, then place `ora118n.jar` in your classpath so that JDBC can convert the character set of the input file to the database character set.
3. Compile the Java programs as shown in this example:

```
javac samp1.java samp2.java samp10.java
```

4. Connect to a database as user `hr` and run SQL script `createRelSchema`:

```
CONNECT hr
@$ORACLE_HOME/xdk/demo/java/xsu/createRelSchema
```

These sections describe the XSU demos in detail.

13.2.4 Using the XSU Command-Line Utility

XDK includes a command-line Java interface for XSU. XSU command-line options are provided through the Java class `OracleXML`.

To use this API ensure that your Java classpath is set as described in [Setting Up the XDK for Java Environment](#) (page 3-5).

To print usage information for XSU to standard output, run this command:

```
java OracleXML
```

To use XSU, invoke it with either the `getXML` or `putXML` parameter:

```
java OracleXML getXML options
java OracleXML putXML options
```

Table 13-2 (page 13-16) describes the `getXML` options.

Table 13-2 *getXML Options*

getXML Option	Description
<code>-user "username/password"</code>	Specifies the user name and password to connect to the database. The connect string is also specified. You can specify the user name and password as part of the connect string.
<code>-conn "JDBC_connect_string"</code>	Specifies the JDBC database connect string. By default the connect string is: "jdbc:oracle:oci:@".
<code>-withDTD</code>	Instructs the XSU to generate the DTD along with the XML document.
<code>-withSchema</code>	Instructs the XSU to generate the schema along with the XML document.
<code>-rowsetTag tag_name</code>	Specifies the rowset tag, which is tag that encloses all the XML elements corresponding to the records returned by the query. The default rowset tag is <ROWSET>. If you specify an empty string ("") for rowset, then XSU omits the rowset element.
<code>-rowTag tag_name</code>	Specifies the row tag that encloses the data corresponding to a database row. The default row tag is <ROW>. If you specify an empty string ("") for the row tag, then XSU omits the row tag.
<code>-rowIdAttr</code> <code>row_id_attribute_name</code>	Names the attribute of the ROW element that keeps track of the cardinality of the rows. By default this attribute is num. If you specify an empty string as the rowID attribute, then XSU omits the attribute.
<code>-rowIdColumn row_Id_column_name</code>	Specifies that the value of a scalar column from the query is to be used as the value of the rowID attribute.
<code>-collectionIdAttr</code> <code>collect_id_attr_name</code>	Names the attribute of an XML list element that keeps track of the cardinality of the elements of the list. The generated XML lists correspond to either a cursor query, or collection. If you specify an empty string ("") as the rowID attribute, then XSU omits the attribute.
<code>-useTypeForCollElemTag</code>	Specifies the use type name for the column-element tag. By default XSU uses the <code>column-name_item</code> .
<code>-useNullAttrId</code>	Specifies the attribute NULL (TRUE/FALSE) to indicate the nullness of an element.
<code>-stylesheet stylesheet_URI</code>	Specifies the stylesheet in the XML processing instruction.
<code>-stylesheetType stylesheet_type</code>	Specifies the stylesheet type in the XML processing instruction.
<code>-setXSLT URI</code>	Specifies the XSLT stylesheet to apply to the XML document.
<code>-setXSLTRef URI</code>	Sets the XSLT external entity reference.

Table 13-2 (Cont.) getXML Options

getXML Option	Description
-useLowerCase -useUpperCase	Generates lowercase or uppercase tag names. The default is to match the case of the SQL object names from which the tags are generated.
-withEscaping	Specifies the treatment of characters that are legal in SQL object names but illegal in XML tags. If such a character is encountered, then it is escaped so that it does not throw an exception.
-errorTag <i>error tag_name</i>	Specifies the tag to enclose error messages that are formatted as XML.
-raiseException	Specifies that XSU must throw a Java exception. By default XSU catches any error and produces the XML error.
-raiseNoRowsException	Raises an exception if no rows are returned.
-useStrictLegalXMLCharCheck	Performs strict checking on input data.
-maxRows <i>maximum_rows</i>	Specifies the maximum number of rows to be retrieved and converted to XML.
-skipRows <i>number_of_rows_to_skip</i>	Specifies the number of rows to be skipped.
-encoding <i>encoding_name</i>	Specifies the character set encoding of the generated XML.
-dateFormat <i>date_format</i>	Specifies the date format for the date values in the XML document.
-fileName <i>SQL_query_fileName</i> <i>SQL_query</i>	Specifies the file name that contains the query or the query itself.

[Table 13-3](#) (page 13-17) describes the putXML options.

Table 13-3 putXML Options

putXML Options	Description
-user " <i>username/password</i> "	Specifies the user name and password to connect to the database. The connect string is also specified. You can specify the user name and password as part of the connect string.
-conn " <i>JDBC_connect_string</i> "	Specifies the JDBC database connect string. By default the connect string is: "jdbc:oracle:oci:@".
-batchSize <i>batching_size</i>	Specifies the batch size that controls the number of rows that are batched together and inserted in a single trip to the database to improve performance.
-commitBatch <i>commit_size</i>	Specifies the number of inserted records after which a commit is to be executed. If the autocommit is TRUE (the default), then setting commitBatch has no consequence.

Table 13-3 (Cont.) putXML Options

putXML Options	Description
<code>-rowTag tag_name</code>	Specifies the row tag, which is tag used to enclose the data corresponding to a database row. The default row tag is <code><ROW></code> . If you specify an empty string for the row tag, then XSU omits the row tag.
<code>-dateFormat date_format</code>	Specifies the date format for the date values in the XML document.
<code>-withEscaping</code>	Turns on reverse mapping if SQL to XML name escaping was used when generating the doc.
<code>-ignoreCase</code>	Makes the matching of the column names with tag names case insensitive. For example, <code>EmpNo</code> matches with <code>EMPNO</code> if <code>ignoreCase</code> is on.
<code>-preserveWhitespace</code>	Preserves the white space in the inserted XML document.
<code>-setXSLT URI</code>	Specifies the XSLT to apply to the XML document before inserting.
<code>-setXSLTref URI</code>	Sets the XSLT external entity reference.
<code>-fileName file_name</code> <code>-URL URL</code> <code>-xmlDoc xml_document</code>	Specifies the XML document to insert: a local file, a URL, or an XML document as a string on the command line.
<code>table_name</code>	Specifies the name of the table to put the values into.

13.2.4.1 Generating XML with the XSU Command-Line Utility

To generate XML from the database schema use the `getXML` parameter.

For example, to generate an XML document by querying the `employees` table in the `hr` schema, you can use this syntax:

```
java OracleXML getXML -user "hr/password" "SELECT * FROM employees"
```

The preceding command performs these tasks:

1. Connects to the current default database
2. Executes the specified `SELECT` query
3. Converts the SQL result set to XML
4. Prints the XML to standard output

The `getXML` parameter supports a wide range of options, which are explained in [Table 13-2](#) (page 13-16).

13.2.4.2 Generating XMLType Data with the XSU Command-Line Utility

You can use XSU to generate XML from tables with `XMLType` columns.

Suppose that you run the demo script `setup_xmltype.sql` to create and populate the `parts` table. You can generate XML from this table with XSU:

```
java OracleXML getXML -user "hr/password" -rowTag "Part" "SELECT * FROM parts"
```

The output of the command is shown below:

```
<?xml version = '1.0'?>
<ROWSET>
  <Part num="1">
    <PARTNO>1735</PARTNO>
    <PARTNAME>Gizmo</PARTNAME>
    <PARTDESC>
      <Description>
        <Title>Description of the Gizmo</Title>
        <Author>John Smith</Author>
        <Body>
          The <b>Gizmo</b> is <i>grand</i>.
        </Body>
      </Description>
    </PARTDESC>
  </Part>
</ROWSET>
```

13.2.4.3 Performing DML with the XSU Command-Line Utility

An example shows how to insert an XML document into a database table.

To insert an XML document called `new_employees.xml` into the `hr.employees` table, use this syntax:

```
java OracleXML putXML -user "hr/password" -fileName "new_employees.xml" employees
```

The preceding command performs these tasks:

1. Connects to the current database as `hr`
2. Reads the XML document named `new_emp.xml`
3. Parses the XML document, matching the tags with column names
4. Inserts the values appropriately into the `employees` table

The `getXML` parameter supports a wide range of options, which are explained in [Table 13-2](#) (page 13-16).

13.3 Programming with the XSU Java API

Topics here include using `OracleXMLQuery` and `OracleXMLSave` to perform various operations, and handling XSU Java exceptions.

Topics:

- [Generating a String with OracleXMLQuery](#) (page 13-20)
- [Generating a DOM Tree with OracleXMLQuery](#) (page 13-21)
- [Paginating Results with OracleXMLQuery](#) (page 13-21)
- [Generating Scrollable Result Sets](#) (page 13-23)
- [Generating XML from Cursor Objects](#) (page 13-24)
- [Inserting Rows with OracleXMLSave](#) (page 13-25)
- [Updating Rows Using OracleXMLSave](#) (page 13-27)

- [Deleting Rows using XSU](#) (page 13-30)
- [Handling XSU Java Exceptions](#) (page 13-32)

13.3.1 Generating a String with OracleXMLQuery

The `testXMLSQL.java` demo program uses XSU to generate XML as a `String` object. The program queries table `hr.employees` and prints the result set to standard output.

The `testXMLSQL.java` program follows these steps:

1. Register the JDBC driver and create a database connection. This code fragment uses the OCI JDBC driver and connects with the user name `hr`:

```
import oracle.jdbc.*;...Connection conn = getConnection("hr","password");
...
private static Connection getConnection(String username, String password)
    throws SQLException
{
    // register the JDBC driver
    DriverManager.registerDriver(new oracle.jdbc.OracleDriver());
    // create the connection using the OCI driver
    Connection conn =
        DriverManager.getConnection("jdbc:oracle:oci:@",username,password);
    return conn;
}
```

2. Create an XML query object and initialize it with a SQL query. This code fragment initializes the object with a `SELECT` statement on `hr.employees`:

```
OracleXMLQuery qry = new OracleXMLQuery(conn, "SELECT * FROM employees");
```

3. Get the query result set as a `String` object. The `getXMLString()` method transforms the object-relational data specified in the constructor into an XML document. This example shows this technique:

```
String str = qry.getXMLString();
```

4. Close the query object to release any resources, as shown in this code:

```
qry.close();
```

13.3.1.1 Running the testXMLSQL Program

The `testXMLSQL` program is described.

To run the `testXMLSQL.java` program perform these steps:

1. Compile `testXMLSQL.java` with `javac`.
2. Execute `java testXMLSQL` on the command line.

You must have the `CLASSPATH` pointing to this directory for the Java executable to find the class. Alternatively, use visual Java tools such as Oracle JDeveloper to compile and run this program. When run, this program prints out the XML file to the screen. This code shows sample output with some rows edited out:

```
<?xml version = '1.0'?>
<ROWSET>
  <ROW num="1">
    <EMPLOYEE_ID>100</EMPLOYEE_ID>
```

```

    <FIRST_NAME>Steven</FIRST_NAME>
    <LAST_NAME>King</LAST_NAME>
    <EMAIL>SKING</EMAIL>
    <PHONE_NUMBER>515.123.4567</PHONE_NUMBER>
    <HIRE_DATE>6/17/1987 0:0:0</HIRE_DATE>
    <JOB_ID>AD_PRES</JOB_ID>
    <SALARY>24000</SALARY>
    <DEPARTMENT_ID>90</DEPARTMENT_ID>
  </ROW>
<!-- ROW num="2" through num="107" ... -->
</ROWSET>

```

13.3.2 Generating a DOM Tree with OracleXMLQuery

To generate a DOM tree from the XML generated by XSU, you can directly request a DOM document from XSU. This technique saves the overhead of creating a string representation of the XML document and then parsing it to generate the DOM tree.

XSU invokes the Oracle XML parser to construct the DOM tree from the data values. The `domTest.java` demo program generates a DOM tree and then traverses it in document order, printing the nodes one by one.

The first two steps in the `domTest.java` program are the same as in the `testXMLSQL.java` program described in [Generating a String with OracleXMLQuery](#) (page 13-20). The program proceeds as follows:

1. Get the DOM by invoking `getXMLDOM()` method. The following example shows this technique:

```
XMLDocument domDoc = (XMLDocument)qry.getXMLDOM();
```

2. Print the DOM tree. The following code prints to standard output:

```
domDoc.print(System.out);
```

You can also create a `StringWriter` and wrap it in a `PrintWriter`:

```
StringWriter s = new StringWriter(10000);
domDoc.print(new PrintWriter(s));
System.out.println(" The string version ---> \n"+s.toString());
```

After compiling the program, run it from the command line:

```
java domTest
```

13.3.3 Paginating Results with OracleXMLQuery

Topics here include limiting the rows in a result set, keeping an object open during a user session, and paginating results using `OracleXMLQuery`.

Topics:

- [Limiting the Number of Rows in the Result Set](#) (page 13-21)
- [Keeping an Object Open for the Duration of the User's Session](#) (page 13-22)
- [Paginating Results with OracleXMLQuery: Example](#) (page 13-23)

13.3.3.1 Limiting the Number of Rows in the Result Set

Different ways to limit the number of rows in a result set are described.

In `testXMLSQL.java` and `domTest.java`, XSU generated XML from all rows returned by the query. Suppose that you query a table that contains 1000 rows, but you want only 100 rows at a time. One approach is to execute one query to get the first 100 rows, another to get the next 100 rows, and so on. With this technique you cannot skip the first five rows of the query and then generate the result. To avoid these problems, use these Java methods:

- `OracleXMLSave.setSkipRows()` forces XSU to skip the desired number of rows before starting to generate the result. The command-line equivalent to this method is the `-skipRows` parameter.
- `OracleXMLSave.setMaxRows()` limits the number of rows converted to XML. The command-line equivalent to this method is the `-maxRows` parameter.

Example 13-1 (page 13-22) sets `skipRows` to a value of 5 and `maxRows` to a value of 1, which causes XSU to skip the first 5 rows and then generate XML for the next row when querying the `hr.employees` table.

The following shows sample output (only row 6 of the query result set is returned):

```
<?xml version = '1.0'?>
<ROWSET>
  <ROW num="6">
    <EMPLOYEE_ID>105</EMPLOYEE_ID>
    <FIRST_NAME>David</FIRST_NAME>
    <LAST_NAME>Austin</LAST_NAME>
    <EMAIL>DAUSTIN</EMAIL>
    <PHONE_NUMBER>590.423.4569</PHONE_NUMBER>
    <HIRE_DATE>6/25/1997 0:0:0</HIRE_DATE>
    <JOB_ID>IT_PROG</JOB_ID>
    <SALARY>4800</SALARY>
    <MANAGER_ID>103</MANAGER_ID>
    <DEPARTMENT_ID>60</DEPARTMENT_ID>
  </ROW>
</ROWSET>
```

Example 13-1 Specifying `skipRows` and `maxRows` on the Command Line

```
java OracleXML getXML -user "hr/password" -skipRows 5 -maxRows 1 \
  "SELECT * FROM employees"
```

13.3.3.2 Keeping an Object Open for the Duration of the User's Session

In some situations, you might want to keep a query object open for the duration of the user session. You can handle such cases with the `maxRows()` method and the `keepObjectOpen()` method.

Consider a web search engine that paginates search results. The first page lists 10 results, the next page lists 10 more, and so on. To perform this task with XSU, request 10 rows at a time and keep the `ResultSet` open so that the next time you ask XSU for more results, it starts generating from where the last generation finished. If `OracleXMLQuery` creates a result set from the SQL query string, then it typically closes the `ResultSet` internally because it assumes no more results are required. Thus, you must invoke `keepObjectOpen()` to keep the cursor active.

A different case requiring an open query object is when the number of rows or number of columns in a row is very large. In this case, you can generate multiple small documents rather than one large document.

See Also:

[Paginating Results with OracleXMLQuery: Example](#) (page 13-23)

13.3.3.3 Paginating Results with OracleXMLQuery: Example

The `paginateResults.java` program shows how you can generate an XML page that paginates results. The output XML displays only 20 rows of the `hr` table.

The `paginateResults.java` program shows how you can generate an XML page that paginates results. The output XML displays only 20 rows of the `hr` table.

The first step of the `paginateResults.java` program, which creates the connection, is the same as in `testXMLSQL.java`. The program continues as follows:

1. Create a SQL statement object and initialize it with a SQL query. The following code fragment sets two options in `java.sql.ResultSet`:

```
Statement stmt = conn.createStatement(ResultSet.TYPE_SCROLL_SENSITIVE,
                                     ResultSet.CONCUR_READ_ONLY);
```

2. Create the query as a string and execute it by invoking `Statement.executeQuery()`. The return object is of type `ResultSet`. The following example shows this technique:

```
String sCmd = "SELECT first_name, last_name FROM hr.employees";
ResultSet rs = stmt.executeQuery(sCmd);
```

3. Create the query object, as shown in this code:

```
OracleXMLQuery xmlQry = new OracleXMLQuery(conn, rs);
```

4. Configure the query object. The following code specifies that the query object is open for the duration of the session. It also limits the number of rows returned to 20:

```
xmlQry.keepObjectOpen(true);
xmlQry.setRowsetTag("ROWSET");
xmlQry.setRowTag("ROW");
xmlQry.setMaxRows(20);
```

5. Retrieve the result as a `String` and print:

```
String sXML = xmlQry.getXMLString();
System.out.println(sXML);
```

After compiling the program, run it from the command line:

```
java paginateResults
```

13.3.4 Generating Scrollable Result Sets

You might want to perform a query and then retrieve a previous page of results from within the result set. To enable scrolling, instantiate the `Oracle.jdbc.ResultSet` class. You can use the `ResultSet` object to move back and forth within the result set and use XSU to generate XML each time.

The `pageTest.java` program shows how to use the JDBC `ResultSet` to generate XML a page at a time. Using `ResultSet` may be necessary in cases that are not handled directly by XSU, for example, when setting the batch size and binding values.

The `pageTest.java` program creates a `pageTest` object and initializes it with a SQL query. The constructor for the `pageTest` object performs these steps:

1. Create a JDBC connection by invoking the same `getConnection()` method defined in `paginateResults.java`:

```
Connection conn;
...
conn = getConnection("hr", "password");
```

2. Create a statement:

```
Statement stmt;
...
stmt = conn.createStatement();
```

3. Execute the query passed to the constructor to get the scrollable result set. The following code shows this technique:

```
ResultSet rset = stmt.executeQuery(sqlQuery);
```

4. Create a query object by passing references to the connection and result set objects to the constructor. The following code fragment shows this technique:

```
OracleXMLQuery qry;
...
qry = new OracleXMLQuery(conn, rset);
```

5. Configure the query object. The following code fragment specifies that the query object be kept open, and that it raise an exception when there are no more rows:

```
qry.keepObjectOpen(true);
qry.setRaiseNoRowsException(true);
qry.setRaiseException(true);
```

6. After creating the query object by passing it the string `"SELECT * FROM employees"`, the program loops through the result set. The `getResult()` method receives integer values specifying the start row and end row of the set. It sets the maximum number of rows to retrieve by calculating the difference of these values and then retrieves the result as a string. The following `while` loop retrieves and prints ten rows at a time:

```
int i = 0;
while ((str = test.getResult(i, i+10)) != null)
{
    System.out.println(str);
    i+= 10;
}
```

After compiling the program, run it from the command line:

```
java pageTest
```

13.3.5 Generating XML from Cursor Objects

You can initialize a `CallableStatement` object, execute a PL/SQL function that returns a cursor variable, get the `OracleResultSet` object, and send it to an `OracleXMLQuery` object to obtain the desired XML data.

Class `OracleXMLQuery` provides XML conversion only for query strings or `ResultSet` objects. If your program uses PL/SQL procedures that return REF

cursors, then how do you perform the conversion? You can use the `ResultSet` conversion mechanism described in [Generating Scrollable Result Sets](#) (page 13-23).

REF cursors are references to cursor objects in PL/SQL. These cursor objects are SQL statements over which a program can iterate to get a set of values. The cursor objects are converted into `OracleResultSet` objects in the Java world. In your Java program you can initialize a `CallableStatement` object, execute a PL/SQL function that returns a cursor variable, get the `OracleResultSet` object, and then send it to the `OracleXMLQuery` object to get the desired XML.

Consider the `testRef` PL/SQL package defined in the `testRef.sql` script. It creates a function that defines a REF cursor and returns it. Every time the `testRefCur` PL/SQL function is called, it opens a cursor object for the SELECT query and returns that cursor instance. To convert the object to XML, do this:

1. Run the `testRef.sql` script to create the `testRef` package in the `hr` schema.
2. Compile and run the `refCurTest.java` program to generate XML from the results of the SQL query defined in the `testRefCur` function.

To apply the stylesheet, you can use the `applyStylesheet` command, which forces the stylesheet to be applied before generating the output.

13.3.6 Inserting Rows with OracleXMLSave

To insert a document into a table or view, supply the table or view name and the document. XSU parses the document and creates an INSERT statement into which it binds the values. By default, XSU inserts values into all columns of the table or view.

An absent element is treated as a NULL value. The following example shows how you can store the XML document generated from the `hr.employees` table in the table.

13.3.6.1 Inserting XML into All Columns with OracleXMLSave

The `testInsert.java` demo program inserts XML values into all columns of the `hr.employees` table.

The program follows these steps:

1. Create a JDBC OCI connection. The program invokes the same `getConnection()` method used by the previous examples in this chapter:

```
Connection conn = getConnection("hr","password");
```

2. Create an XML save object. You initialize the object by passing it the `Connection` reference and the name of the table on which you want to perform DML. The following example shows this technique:

```
OracleXMLSave sav = new OracleXMLSave(conn, "employees");
```

3. Insert the data in an input XML document into the `hr.employees` table. The following code fragment creates a URL from the document file name specified on the command line:

```
sav.insertXML(sav.getURL(argv[0]));
```

4. Close the XML save object:

```
sav.close();
```

13.3.6.1.1 Running the testInsert Program

The `testInsert` program is described.

Assume that you write the `new_emp.xml` document to describe new employee Janet Smith, who has employee ID 7369. You pass the file name `new_emp.xml` as an argument to the `testInsert` program:

```
java testInsert "new_emp.xml"
```

The program inserts a new row in the `employees` table that contains the values for the columns specified. Any absent element inside the row element is treated as `NULL`.

Running the program generates an `INSERT` statement of this form:

```
INSERT INTO hr.employees
  (employee_id, first_name, last_name, email, phone_number, hire_date,
   salary, commission_pct, manager_id, department_id)
VALUES
  (?, ?, ?, ?, ?, ?, ?, ?, ?);
```

XSU matches the element tags in the input XML document that match the column names and binds their values.

13.3.6.2 Inserting XML into a Subset of Columns with OracleXMLSave

In some situations, you might not want to insert values into all columns. For example, the group of values that you get might not be the complete set, requiring you to use triggers or default values for the remaining columns.

The `testInsertSubset.java` demo program shows how to handle this case. It follows these steps:

1. Create a JDBC OCI connection. The program invokes the same `getConnection()` method used by the previous examples in this chapter:

```
Connection conn = getConnection("hr","password");
```

2. Create an XML save object. Initialize the object by passing it the `Connection` reference and the name of the table on which you want to perform DML. The following example shows this technique:

```
OracleXMLSave sav = new OracleXMLSave(conn, "employees");
```

3. Create an array of strings. Each element of the array must contain the name of a column in which values are inserted. The following code fragment specifies the names of five columns:

```
String [] colNames = new String[5];
colNames[0] = "EMPLOYEE_ID";
colNames[1] = "LAST_NAME";
colNames[2] = "EMAIL";
colNames[3] = "JOB_ID";
colNames[4] = "HIRE_DATE";
```

4. Configure the XML save object to update the specified columns. The following statement passes a reference to the array to the `OracleXMLSave.setUpdateColumnList()` method:

```
sav.setUpdateColumnList(colNames);
```

5. Insert the data in an input XML document into the `hr.employees` table. The following code fragment creates a URL from the document file name specified on the command line:

```
sav.insertXML(sav.getURL(argv[0]));
```

6. Close the XML save object:

```
sav.close();
```

13.3.6.2.1 Running the testInsertSubset Program

The `testInsertSubset` program is described.

Assume that you use the `new_emp2.xml` document to store data for new employee Adams, who has employee ID 7400. You pass `new_emp2.xml` as an argument to the `testInsert` program:

```
java testInsert new_emp2.xml
```

The program ignores values for the columns that were not specified in the input file. It performs an `INSERT` for each `ROW` element in the input and batches the `INSERT` statements by default.

The program generates this `INSERT` statement:

```
INSERT INTO hr.employees (employee_id, last_name, email, job_id, hire_date)
VALUES (?, ?, ?, ?, ?);
```

13.3.7 Updating Rows Using OracleXMLSave

Examples show how to update the fields in a table or view. You supply the table or view name and an XML document. XSU parses the document (if a string is given) and creates one or more `UPDATE` statements into which it binds all of the values.

The following examples use an XML document to update table `hr.employees`.

13.3.7.1 Updating Key Columns Using OracleXMLSave

Demo program `testUpdate.java` invokes method `OracleXMLSave.setKeyColumnList()` to update table `hr.employees`.

`testUpdate.java` follows these steps:

1. Create a JDBC OCI connection. The program invokes the same `getConnection()` method used by the previous examples in this chapter:

```
Connection conn = getConnection("hr","password");
```

2. Create an XML save object. You initialize the object by passing it the `Connection` reference and the name of the table on which you want to perform DML. The following example shows this technique:

```
OracleXMLSave sav = new OracleXMLSave(conn, "employees");
```

3. Create a single-element `String` array to hold the name of the primary key column in the table to be updated. The following code fragment specifies the name of the `employee_id` column:

```
String [] keyColNames = new String[1];
colNames[0] = "EMPLOYEE_ID";
```

4. Set the XML save object to the primary key specified in the array. The following statement passes a reference to the `keyColNames` array to the `OracleXMLSave.setKeyColumnList()` method:

```
sav.setKeyColumnList(keyColNames);
```

5. Update the rows specified in the input XML document. The following statement creates a URL from the file name specified on the command line:

```
sav.updateXML(sav.getURL(argv[0]));
```

6. Close the XML save object:

```
sav.close();
```

13.3.7.1.1 Running the testUpdate Program

The `testUpdate` program is described.

You can use XSU to update specified fields in a table. [Example 13-2](#) (page 13-28) shows `upd_emp.xml`, which contains updated salary and other information for the two employees that you just added, 7369 and 7400.

For updates, supply XSU with the list of key column names in the `WHERE` clause of the `UPDATE` statement. In the `hr.employees` table the `employee_id` column is the key.

Pass the file name `upd_emp.xml` as an argument to the preceding program:

```
java testUpdate upd_emp.xml
```

The program generates two `UPDATE` statements. For the first `ROW` element, the program generates an `UPDATE` statement to update the `SALARY` field:

```
UPDATE hr.employees SET salary = 3250 WHERE employee_id = 7400;
```

For the second `ROW` element the program generates this statement:

```
UPDATE hr.employees SET job_id = 'SA_REP' AND MANAGER_ID = 145
WHERE employee_id = 7369;
```

Example 13-2 upd_emp.xml

```
<?xml version='1.0'?>
<ROWSET>
  <ROW num="1">
    <EMPLOYEE_ID>7400</EMPLOYEE_ID>
    <SALARY>3250</SALARY>
  </ROW>
  <ROW num="2">
    <EMPLOYEE_ID>7369</EMPLOYEE_ID>
    <JOB_ID>SA_REP</JOB_ID>
    <MANAGER_ID>145</MANAGER_ID>
  </ROW>
  <!-- additional rows ... -->
</ROWSET>
```

13.3.7.2 Updating a Column List Using OracleXMLSave

You can update a table using only a subset of the elements in an XML document, by specifying a list of columns. This is fast because XSU uses the same `UPDATE` statement, with bind variables for all of the `ROW` elements. Other tags in the document can be ignored.

Note:

When you specify a list of columns to update, if an element corresponding to an update column is absent, XSU treats it as NULL.

Suppose you want to update the salary and job title for each employee and ignore the other data. If you know that all the elements to be updated are the same for all ROW elements in the XML document, then you can use the `OracleXMLSave.setUpdateColumnNames()` method to specify the columns. The `testUpdateList.java` program shows this technique.

The `testUpdateList.java` program follows these steps:

1. Create a JDBC OCI connection. The program invokes the same `getConnection()` method used by the previous examples in this chapter:

```
Connection conn = getConnection("hr","password");
```

2. Create an XML save object. You initialize the object by passing it the `Connection` reference and the name of the table on which you want to perform DML. The following example shows this technique:

```
OracleXMLSave sav = new OracleXMLSave(conn, "employees");
```

3. Create an array of type `String` to hold the name of the primary key column in the table to be updated. The array contains only one element, which is the name of the primary key column in the table to be updated. The following code fragment specifies the name of the `employee_id` column:

```
String [] colNames = new String[1];
colNames[0] = "EMPLOYEE_ID";
```

4. Set the XML save object to the primary key specified in the array. The following statement passes a reference to the `colNames` array to the `OracleXMLSave.setKeyColumnList()` method:

```
sav.setKeyColumnList(keyColNames);
```

5. Create an array of type `String` to hold the name of the columns to be updated. The following code fragment specifies the name of the `employee_id` column:

```
String[] updateColNames = new String[2];
updateColNames[0] = "SALARY";
updateColNames[1] = "JOB_ID";
```

6. Set the XML save object to the list of columns to be updated. The following statement performs this task:

```
sav.setUpdateColumnList(updateColNames);
```

7. Update the rows specified in the input XML document. The following code fragment creates a URL from the file name specified on the command line:

```
sav.updateXML(sav.getURL(argv[0]));
```

8. Close the XML save object:

```
sav.close();
```

13.3.7.2.1 Running the testUpdateList Program

The `testUpdateList` program is described.

Suppose that you use the sample XML document `upd_emp2.xml` to store new data for employees Steven King, who has an employee ID of 100, and William Gietz, who has an employee identifier (ID) of 206. You pass `upd_emp2.xml` as an argument to the `testUpdateList` program:

```
java testUpdateList upd_emp2.xml
```

In this example, the program generates two `UPDATE` statements. For the first `ROW` element, the program generates this statement:

```
UPDATE hr.employees SET salary = 8350 AND job_id = 'AC_ACCOUNT'  
WHERE employee_id = 100;
```

For the second `ROW` element the program generates this statement:

```
UPDATE hr.employees SET salary = 25000 AND job_id = 'AD_PRES'  
WHERE employee_id = 206;
```

13.3.8 Deleting Rows using XSU

When deleting from XML documents, you can specify a list of key columns. XSU uses these columns in the `WHERE` clause of the `DELETE` statement. If you do not supply the key column names, then XSU creates a new `DELETE` statement for each `ROW` element of the XML document.

The list of columns in the `WHERE` clause of the `DELETE` statement matches those in the `ROW` element.

13.3.8.1 Deleting by Row with OracleXMLSave

The `testDeleteRow.java` demo program accepts an XML document file name as input and deletes the rows corresponding to the elements in the document.

The `testDeleteRow.java` program follows these steps:

1. Create a JDBC OCI connection. The program invokes the same `getConnection()` method used by the previous examples in this chapter:

```
Connection conn = getConnection("hr","password");
```

2. Create an XML save object. You initialize the object by passing it the `Connection` reference and the name of the table on which you want to perform DML. The following example shows this technique:

```
OracleXMLSave sav = new OracleXMLSave(conn, "employees");
```

3. Delete the rows specified in the input XML document. The following code fragment creates a URL from the file name specified on the command line:

```
sav.deleteXML(sav.getURL(argv[0]));
```

4. Close the XML save object:

```
sav.close();
```

13.3.8.1.1 Running the testDelete Program

The `testDelete` program is described.

This section shows how to delete the employees 7400 and 7369 that you added in [Inserting Rows with OracleXMLSave](#) (page 13-25).

To make this example work correctly, connect to the database and disable a constraint on the `hr.job_history` table:

```
CONNECT hr
ALTER TABLE job_history
  DISABLE CONSTRAINT JHIST_EMP_FK;
EXIT
```

Now pass `upd_emp.xml` to the `testDeleteRow` program:

```
java testDeleteRow upd_emp.xml
```

The program forms the `DELETE` statements based on the tag names present in each `ROW` element in the XML document. It executes these statements:

```
DELETE FROM hr.employees WHERE salary = 3250 AND employee_id = 7400;
DELETE FROM hr.employees WHERE job_id = 'SA_REP' AND MANAGER_ID = 145
  AND employee_id = 7369;
```

13.3.8.2 Deleting by Key with OracleXMLSave

To use only the key values as predicates on the `DELETE` statement, invoke the `OracleXMLSave.setKeyColumnList()` method. This approach limits the number of elements used to identify a row, which has the benefit of improving performance by caching the `DELETE` statement and batching transactions. The `testDeleteKey.java` program shows this technique.

The `testDeleteKey.java` program follows these steps:

1. Create a JDBC OCI connection. The program invokes the same `getConnection()` method used by the previous examples in this chapter:

```
Connection conn = getConnection("hr","password");
```

2. Create an XML save object. You initialize the object by passing it the `Connection` reference and the name of the table on which you want to perform DML. The following example shows this technique:

```
OracleXMLSave sav = new OracleXMLSave(conn, "employees");
```

3. Create an array of type `String` to hold the name of the primary key column in the table. The array contains only one element. The following code fragment specifies the name of the `employee_id` column:

```
String [] colNames = new String[1];
colNames[0] = "EMPLOYEE_ID";
```

4. Set the XML save object to the primary key specified in the array. The following statement passes a reference to the `colNames` array to the `OracleXMLSave.setKeyColumnList()` method:

```
sav.setKeyColumnList(keyColNames);
```

5. Delete the rows specified in the input XML document. The following code fragment creates a URL from the file name specified on the command line:

```
sav.deleteXML(sav.getURL(argv[0]));
```

6. Close the XML save object:

```
sav.close();
```

13.3.8.2.1 Running the testDeleteKey Program

The testDeleteKey program is described.

This section shows how to delete employees 7400 and 7369 that you added in [Updating Key Columns Using OracleXMLSave](#) (page 13-27). If you deleted these employees in the previous example, you can add them back to the employees table:

```
java testInsert new_emp.xml
java testInsert new_emp2.xml
```

Delete employees 7400 and 7369 by passing the same upd_emp.xml document to the testDeleteRow program:

```
java testDeleteKey upd_emp.xml
```

The program forms this single generated DELETE statement:

```
DELETE FROM hr.employees WHERE employee_id=?;
```

The program executes these DELETE statements, one for each employee:

```
DELETE FROM hr.employees WHERE employee_id = 7400;
DELETE FROM hr.employees WHERE employee_id = 7369;
```

13.3.9 Handling XSU Java Exceptions

XSU catches all exceptions that occur during processing and throws `oracle.xml.sql.OracleXMLSQLException`, which is a generic runtime exception. The invoking program need not catch this exception if it can still perform the appropriate action. The exception class provides methods to get error messages and any parent exceptions.

13.3.9.1 Getting the Parent Exception

The `testException.java` demo program throws a runtime exception and then gets the parent exception by invoking `Exception.getParentException()`.

Running the program generates this error message:

```
Caught SQL Exception:ORA-00904: "SD": invalid identifier
```

13.3.9.2 Raising a No Rows Exception

When there are no rows to process, XSU returns a null string. You can throw an exception each time there are no more rows, however, so that a program can process this exception using exception handlers.

When a program invokes `OracleXMLQuery.setRaiseNoRowsException()`, XSU raises an `oracle.xml.sql.OracleXMLSQLNoRowsException` whenever there are no rows to generate for the output. This is a runtime exception and need not be caught.

The `noRowsTest.java` demo program instantiates the `pageTest` class defined in `pageTest.java`. The condition to check the termination changed from checking whether the result is null to an exception handler.

The `noRowsTest.java` program creates a `pageTest` object and initializes it with a SQL query. The program proceeds as follows:

1. Configure the query object or raise a no rows exception. The following code fragment shows this technique:

```
pageTest test = new pageTest("SELECT * from employees");
...
test.qry.setRaiseNoRowsException(true);
```

2. Loop through the result set infinitely, retrieving ten rows at a time. When no rows are available, the program throws an exception. The following code fragment invokes `pageTest.nextPage()`, which scrolls through the result set ten rows at a time:

```
try
{
    while(true)
        System.out.println(test.nextPage());
}
```

3. Catch the no rows exception and print "END OF OUTPUT". The following code shows this technique:

```
catch(oracle.xml.sql.OracleXMLSQLNoRowsException e)
{
    System.out.println(" END OF OUTPUT ");
    try
    {
        test.close();
    }
    catch ( Exception ae )
    {
        ae.printStackTrace(System.out);
    }
}
```

After compiling the program, run it from the command line:

```
java noRowsTest
```

13.4 Programming with the XSU PL/SQL API

Topics here describe programming tasks that make use of the XSU PL/SQL API.

Topics:

- [Generating XML from Simple Queries with DBMS_XMLQuery](#) (page 13-34)
- [Specifying Element Names with DBMS_XMLQuery](#) (page 13-34)
- [Paginating Results with DBMS_XMLQUERY](#) (page 13-34)
- [Setting Stylesheets in XSU](#) (page 13-35)
- [Binding Values in XSU](#) (page 13-35)
- [Inserting XML using XSU](#) (page 13-35)
- [Updating using XSU](#) (page 13-37)
- [Deleting with XSU](#) (page 13-39)
- [Handling Exceptions with XSU](#) (page 13-40)

- [Reusing the Context Handle with XSU](#) (page 13-40)

Note:

For increased performance, consider using `DBMS_XMLGen` and `DBMS_XMLStore` as alternatives to `DBMS_XMLQuery` and `DBMS_XMLSave`. The two former packages are written in C and are built in to the database kernel. You can also use SQL and XML functions such as `XMLElement` for XML access in the database.

13.4.1 Generating XML from Simple Queries with `DBMS_XMLQuery`

How you can use package `DBMS_XMLQuery` to generate XML data from a SQL query is shown.

To make the example work, connect to the database as `hr` and run the `printClobOut.sql` script. The script creates `printClobOut`, which is a simple procedure that prints a CLOB to the output buffer. If you run the `printClobOut` procedure in SQL*Plus, it prints the input CLOB to the screen. Set server output to `ON` to see the results. You might have to increase your display buffer to see all the output.

Run the `simpleQuery.sql` script to select 20 rows from the `hr.employees` table and get an XML document as a CLOB. The program first gets the context handle by passing in a query and then invokes the `getXML` function to get the CLOB value. The document is in the same encoding as the database character set. This sample application assumes that you created the `printClobOut` procedure by running `printClobOut.sql`.

13.4.2 Specifying Element Names with `DBMS_XMLQuery`

With the XSU PL/SQL API you can change the default `ROW` and the `ROWSET` element names, which are the default names placed around each row of the result and around the whole output XML document. Use PL/SQL procedures `setRowTagName` and `setRowSetTagName` to accomplish this task.

Connect as `hr` and run the `changeElementName.sql` script in SQL*Plus to get the first 20 rows of the `employees` table as an XML document. The anonymous PL/SQL block changes the `ROW` and `ROWSET` element names to `EMP` and `EMPSET`. The block invokes the `printClobOut` procedure that you created by running `printClobOut.sql`.

The generated XML document has an `<EMPSET>` document element. Each row is separated with the `<EMP>` tag.

13.4.3 Paginating Results with `DBMS_XMLQUERY`

You can paginate query results by invoking functions in PL/SQL package `DBMS_XMLQUERY`.

- Function `setMaxRows` sets the maximum number of rows to be converted to XML. This maximum is relative to the current row position from which the previous result was generated.
- Function `setSkipRows` specifies the number of rows to skip before converting the row values to XML.

Run the `paginateResult.sql` script to execute an anonymous block that paginates results. It skips the first 3 rows of the `employees` table and prints the rest of the rows 10 at a time by setting `skipRows` to 3 for the first batch of 10 rows and then to 0 for the rest of the batches. For multiple fetches, you must determine when there are no more rows to fetch, which you can do by invoking `setRaiseNoRowsException`. This procedure raises an exception if no rows are written to the CLOB. This exception can be caught and used as the termination condition.

13.4.4 Setting Stylesheets in XSU

The XSU PL/SQL API lets you set stylesheets on generated XML documents.

- Set the stylesheet header in the result with procedure `setStylesheetHeader`. This procedure adds the XML processing instruction that includes the stylesheet.
- Apply a stylesheet to the resulting XML document before generation. This method increases performance dramatically because otherwise the XML document must be generated as a CLOB, sent to the parser again, and have the stylesheet applied. XSU generates a DOM document, invokes the parser, applies the stylesheet and then generates the result. To apply the stylesheet to the resulting XML document, use procedure `setXSLT`, which uses the stylesheet to generate the result.

13.4.5 Binding Values in XSU

The XSU PL/SQL API lets you bind values to a SQL statement. The statement can contain named bind variables, which must be prefixed with a colon (:).

The `bindSQLVariables.sql` script runs an anonymous PL/SQL block that binds values for `EMPLOYEE_ID` and `FIRST_NAME` to columns in the `employees` table.

13.4.6 Inserting XML using XSU

To insert a document into a table or view, supply the table or the view name and then the XML document. XSU parses the XML document (if a string is given) and then creates an `INSERT` statement into which it binds all the values. By default, XSU inserts values into all the columns of the table or view and treats absent elements as `NULL`.

13.4.6.1 Inserting Values into All Columns using XSU

Run the `insProc.sql` demo script to create a PL/SQL stored procedure, `insProc`.

The script accepts these parameters:

- An XML document as a CLOB
- The name of the table in which to insert the document

You can invoke the `insProc` procedure to insert an XML document into the table.

Run the `insertClob.sql` script to create a table called `xmlDocument` and store an XML document in the table as a CLOB. The XML document describes employee 7370, Liz Gardner, whom you want to insert into the `hr.employees` table.

Run the `insertEmployee.sql` script shown in [Example 13-4](#) (page 13-36) to call the `insProc` stored procedure and insert Liz Gardner into the `employees` table.

As in [Inserting Rows with OracleXMLSave](#) (page 13-25), running the `callinsProc` procedure generates an `INSERT` statement of the form shown in [Example 13-5](#) (page 13-36).

XSU matches the element tags in the input XML document that match the column names and binds their values.

Example 13-3 insertClob.sql

```
CREATE TABLE hr.xmldocument
  (docid NUMBER PRIMARY KEY,
   xml_text CLOB);
-- insert an XML document into the CLOB column
INSERT INTO hr.xmldocument (docid,xml_text)
VALUES (1,
        '<?xml version="1.0"?>
        <ROWSET>
        <ROW num="1">
        <EMPLOYEE_ID>7370</EMPLOYEE_ID>
        <FIRST_NAME>Liz</FIRST_NAME>
        <LAST_NAME>Gardner</LAST_NAME>
        <EMAIL>liz.gardner@business.com</EMAIL>
        <PHONE_NUMBER>650-555-6127</PHONE_NUMBER>
        <HIRE_DATE>12/18/2004 0:0:0</HIRE_DATE>
        <SALARY>3000</SALARY>
        <COMMISSION_PCT>0</COMMISSION_PCT>
        <JOB_ID>SH_CLERK</JOB_ID>
        <MANAGER_ID>103</MANAGER_ID>
        <DEPARTMENT_ID>20</DEPARTMENT_ID>
        </ROW>
        </ROWSET>');;
```

Example 13-4 insertEmployee.sql

```
DECLARE
  v_xml_text CLOB;
BEGIN
  SELECT xml_text
  INTO v_xml_text
  FROM hr.xmldocument
  WHERE docid = 1;
  insProc(v_xml_text, 'employees');
END;
/
```

Example 13-5 Form of the INSERT Statement

```
INSERT INTO hr.employees
  (employee_id, first_name, last_name, email, phone_number, hire_date,
   salary, commission_pct, manager_id, department_id)
VALUES
  (?, ?, ?, ?, ?, ?, ?, ?, ?, ?);
```

13.4.6.2 Inserting into a Set of Columns using XSU

You can create a list of column names for insert processing and pass it to PL/SQL procedure `DBMS_XMLSave`.

As explained in [Inserting XML into a Subset of Columns with OracleXMLSave](#) (page 13-26), you may not want to insert values into all columns. You can set these values by invoking procedure `setUpdateColumnName` repeatedly and passing in a column name to update each time. Clear the column name settings by invoking `clearUpdateColumnList`.

Run the `testInsert.sql` demo script to create a PL/SQL stored procedure called `testInsert`. You can use this procedure to insert XML data of type CLOB into the `hr.employees` table.

Run the `insertClob2.sql` script shown in [Example 13-6](#) (page 13-37) to insert an XML document describing new employee Jordan into a CLOB column of the `xmlDocument` table. The document does not contain an element corresponding to every column in the `employees` table.

Running the `insertEmployee2.sql` script shown in [Example 13-7](#) (page 13-37) inserts the data for employee Jim Jordan into a subset of the columns in the `hr.employees` table.

As in [Inserting XML into a Subset of Columns with OracleXMLSave](#) (page 13-26), invoking `testInsert` generates this INSERT statement:

```
INSERT INTO hr.employees (employee_id, last_name, email, job_id, hire_date)
VALUES (?, ?, ?, ?, ?);
```

Example 13-6 *insertClob2.sql*

```
-- insert an XML document into the CLOB column of the xmlDocument table with only
-- some of the possible elements
INSERT INTO hr.xmlDocument (docid, xml_text)
VALUES (2,
'<?xml version="1.0"?>
<ROWSET>
  <ROW num="1">
    <EMPLOYEE_ID>7401</EMPLOYEE_ID>
    <LAST_NAME>Jordan</LAST_NAME>
    <EMAIL>jim.jordan@business.com</EMAIL>
    <JOB_ID>SH_CLERK</JOB_ID>
    <HIRE_DATE>12/17/2004 0:0:0</HIRE_DATE>
  </ROW>
</ROWSET>');
```

Example 13-7 *insertEmployee2.sql*

```
DECLARE
  v_xml_text CLOB;
BEGIN
  SELECT xml_text
  INTO v_xml_text
  FROM hr.xmlDocument
  WHERE docid = 2;
  testInsert(v_xml_text);
END;
/
```

13.4.7 Updating using XSU

You can use an XML document to update specified fields in a table. You can either specify a column to use as a key or pass a list of columns for updating.

This is described in [Updating Rows Using OracleXMLSave](#) (page 13-27).

13.4.7.1 Updating Key Columns using PL/SQL

Example scripts show you how to update key columns using a PL/SQL procedure.

Run the `testUpdateKey.sql` script to create a PL/SQL procedure called `testUpdateKey`. The procedure uses column `employee_id` of the `hr.employees` table as a primary key.

Run the `insertClob3.sql` script shown in shown in [Example 13-8](#) (page 13-38) to insert an XML document into the CLOB column of table `xmlDocument`. The document specifies a new salary for employee 7400 and a new job ID and manager ID for employee 7369.

Run the `updateEmployee.sql` script shown in [Example 13-9](#) (page 13-38) to pass the XML document to procedure `testUpdateKey` and generate two UPDATE statements.

For the first ROW element, the program generates an UPDATE statement:

```
UPDATE hr.employees SET salary = 3250 WHERE employee_id = 7400;
```

For the second ROW element the program generates this statement:

```
UPDATE hr.employees SET job_id = 'SA_REP' AND MANAGER_ID = 145
WHERE employee_id = 7369;
```

Example 13-8 *insertClob3.sql*

```
INSERT INTO hr.xmlDocument (docid, xml_text)
VALUES (3,
       '<?xml version="1.0"?>
       <ROWSET>
       <ROW num="1">
         <EMPLOYEE_ID>7400</EMPLOYEE_ID>
         <SALARY>3250</SALARY>
       </ROW>
       <ROW num="2">
         <EMPLOYEE_ID>7369</EMPLOYEE_ID>
         <JOB_ID>SA_REP</JOB_ID>
         <MANAGER_ID>145</MANAGER_ID>
       </ROW>
       </ROWSET>');
```

Example 13-9 *updateEmployee.sql*

```
DECLARE
  v_xml_text CLOB;
BEGIN
  SELECT xml_text
  INTO v_xml_text
  FROM hr.xmlDocument
  WHERE docid = 3;
  testUpdateKey(v_xml_text);
END;
/
```

13.4.7.2 Updating a Set of Columns using XSU

You can specify a list of columns to update and pass it to PL/SQL procedure `DBMS_XMLSave`.

This is described in [Updating a Column List Using OracleXMLSave](#) (page 13-28).

Run the `testUpdateSubset.sql` script creates the PL/SQL procedure `testUpdateSubset`. The procedure uses column `employee_id` as key and updates only the `salary` and `job_id` columns of table `hr.employees`.

Run the `insertClob4.sql` script to insert an XML document into the `xmldocument` table. The `<ROW>` elements in the document describe employees 100 and 206. Each `<ROW>` element has ten subelements that contain descriptive text.

Run the `updateEmployee2.sql` script shown in [Example 13-10](#) (page 13-39) to pass the XML CLOB to procedure `testUpdateSubset` and generate two UPDATE statements.

The procedure updates only those columns specified in the `setUpdateColumn` procedure, `salary` and `email`, for employees 100 and 206.

Example 13-10 `updateEmployee2.sql`

```
DECLARE
    v_xml_text CLOB;
BEGIN
    SELECT xml_text
        INTO v_xml_text
    FROM hr.xmldocument
    WHERE docid = 4;
    testUpdateSubset(v_xml_text);
END;
/
```

13.4.8 Deleting with XSU

you can supply a list of key columns that XSU uses to determine which rows to delete. XSU specifies these columns in the `WHERE` clause of the `DELETE` statement.

This is described in [Deleting Rows using XSU](#) (page 13-30).

13.4.8.1 Deleting by Row with XSU

You can delete a row from a table using a PL/SQL procedure.

Create the `testDeleteRow` PL/SQL procedure by running the `testDeleteRow.sql` script. The procedure deletes a row from the `hr.employees` table for every `<ROW>` element in an input XML document.

Suppose you want to delete the employee Jim Jordan that you added in [Example 13-7](#) (page 13-37). Run the `deleteEmployeeByRow.sql` script shown in [Example 13-11](#) (page 13-39) to pass the XML document as a CLOB to the `testDeleteRow` stored procedure.

The preceding invocation of `testDeleteRow` generates this `DELETE` statement:

```
DELETE FROM hr.employees
    WHERE employee_id = 7401 AND last_name = 'JORDAN'
    AND email = 'jim.jordan@business.com' AND job_id = 'SH_CLERK'
    AND hire_date = '12/17/2004 0:0:0';
```

The program forms the `DELETE` statements based on the tag names present in each `<ROW>` element in the XML document.

Example 13-11 `Deleting by Row`

```
DECLARE
    v_xml_text CLOB;
BEGIN
    SELECT xml_text
        INTO v_xml_text
    FROM hr.xmldocument
    WHERE docid = 2;
```

```

    testDeleteRow(v_xml_text);
END;
/

```

13.4.8.2 Deleting by Key with XSU

You can specify a column to use as a primary key for the deletions. Use PL/SQL function `DBMS_XMLSave.setKeyColumn` to specify the key.

This is explained in [Deleting by Key with OracleXMLSave](#) (page 13-31).

Procedure `testDeleteKey`, created by running `testDeleteKey.sql`, deletes a row from table `employees` for each `<ROW>` element in an input XML document.

Suppose you want to delete the employee Liz Gardner that you added in [Example 13-4](#) (page 13-36). Run the `deleteEmployeeByKey.sql` script shown in [Example 13-12](#) (page 13-40) to pass the XML document as a CLOB to the `testDeleteKey` stored procedure.

In the procedure call, XSU generates a single `DELETE` statement of this form:

```
DELETE FROM hr.employees WHERE employee_id=?
```

XSU uses this statement for all `ROW` elements in the input XML document.

Example 13-12 *Deleting by Key*

```

DECLARE
    v_xml_text CLOB;
BEGIN
    SELECT xml_text
        INTO v_xml_text
    FROM hr.xmldocument
    WHERE docid = 1;
    testDeleteKey(v_xml_text);
END;
/

```

13.4.9 Handling Exceptions with XSU

A sample script shows how to handle exceptions using XSU.

Good PL/SQL coding practice accounts for possible exceptions. The anonymous PL/SQL block in `raiseException.sql` demonstrates how to invoke procedure `DBMS_XMLQuery.getExceptionContent`. Run the script in `SQL*Plus` to print this error message:

```
Exception caught 904 ORA-00904: "Z": invalid identifier
```

13.4.10 Reusing the Context Handle with XSU

You can sometimes perform more than one operation using the same context handle.

In the DML examples described in the preceding sections, you can use the same context handle to perform more than one operation. That is, you can perform more than one `INSERT` with the same context, if all of the insertions access the same table specified when creating the `save` context. You can also use the same context to mix DML statements.

The `testDML.sql` script shows how to use the same context and settings to perform DML depending on user input. The example uses a PL/SQL supplied package static variable to store the context so that the same context can be used for all function invocations.

In the `testDML` package created by the script, you create a context once for the whole package (and thus the session) and reuse the context for multiple DML operations.

Note:

The key column `employee_id` is used both for updates and deletes as a way of identifying the row.

You can call any of the three procedures created by the script to update the employees table:

```
testDML.insertXML(xmlclob);
testDML.deleteXML(xmlclob);
testDML.updateXML(xmlclob);
```

Each procedure call uses the same context, which improves the performance of these operations, particularly if these operations are performed frequently.

13.5 Tips and Techniques for Programming with XSU

This section provides tips and techniques for writing programs with XSU.

Topics:

- [How XSU Maps Between SQL and XML](#) (page 13-41)
- [How XSU Processes SQL Statements](#) (page 13-46)

13.5.1 How XSU Maps Between SQL and XML

The mapping between SQL and XML is described.

The fundamental component of a table is a column, whereas the fundamental components of an XML document are elements and attributes. How do tables map to XML documents? For example, if the `hr.employees` table has a column called `last_name`, how is this structure represented in XML: as an `<EMPLOYEES>` element with a `last_name` attribute or as a `<LAST_NAME>` element within a different root element? This section answers such questions by describing how SQL maps to XML and the reverse.

Topics:

- [Default SQL-to-XML Mapping](#) (page 13-41)
- [Default XML-to-SQL Mapping](#) (page 13-44)
- [Customizing Generated XML](#) (page 13-44)

13.5.1.1 Default SQL-to-XML Mapping

The default mapping of SQL data to XML data is described.

To display data from some column of the `hr.employees` table as an XML document, run XSU at the command line:

```
java OracleXML getXML -user "hr/password" -withschema \  
"SELECT employee_id, last_name, hire_date FROM employees"
```

XSU outputs an XML document based on the input query. The root element of the document is <DOCUMENT>. The following shows sample output, with extraneous lines replaced by comments:

```
<?xml version = '1.0'?>
<DOCUMENT xmlns:xsd="http://www.w3.org/2001/XMLSchema">
  <xsd:schema xmlns:xsd="http://www.w3.org/2001/XMLSchema">
    <!-- children of schema element ... -->
  </xsd:schema>
  <ROWSET xmlns:xsi="http://www.w3.org/2001/XMLSchema-instance"
    xsi:noNamespaceSchemaLocation="#/DOCUMENT/xsd:schema[not(@targetNamespace)]">
    <ROW num="1">
      <EMPLOYEE_ID>100</EMPLOYEE_ID>
      <LAST_NAME>King</LAST_NAME>
      <HIRE_DATE>6/17/1987 0:0:0</HIRE_DATE>
    </ROW>
    <!-- additional rows ... -->
  </ROWSET>
</DOCUMENT>
```

In the generated XML, the rows returned by the SQL query are children of the <ROWSET> element. The XML document has these features:

- The <ROWSET> element has zero or more <ROW> child elements corresponding to the number of rows returned. If the query generates no rows, then no <ROW> elements are included; if the query generates one row, then one <ROW> element is included, and so forth.
- Each <ROW> element contains data from one table row. Specifically, each <ROW> element has one or more child elements whose names and content are identical to the database columns specified in the SELECT statement.

13.5.1.1.1 XML Mapping Against an Object-Relational Schema

XSU can generate an XML document from an object-relational schema.

Run the `createObjRelSchema.sql` script in SQL*Plus to set up and populate an object-relational schema. The schema contains a `dept1` table with two columns that employ user-defined types.

You can query the `dept1` table by invoking XSU from the command line:

```
% java OracleXML getXML -user "hr/password" -withschema "SELECT * FROM dept1"
```

XSU returns the XML document shown in [Example 13-13](#) (page 13-42), which is altered so that extraneous lines are replaced by comments.

As in the previous example, the mapping is canonical, that is, <ROWSET> contains <ROW> child elements, which in turn contain child elements corresponding to the columns in `dept1`. For example, the <DEPTNAME> element corresponds to the `dept1.deptname` column. The elements corresponding to scalar type columns contain the data from the columns.

Example 13-13 XSU-Generated Sample Document

```
<?xml version='1.0'?>
<DOCUMENT xmlns:xsd="http://www.w3.org/2001/XMLSchema">
  <schema targetNamespace="http://xmlns.oracle.com/xdb/SYSTEM"
    xmlns="http://www.w3.org/2001/XMLSchema"
    xmlns:SYSTEM="http://xmlns.oracle.com/xdb/SYSTEM">
    <!-- children of schema element ... -->
  </xsd:schema>
```

```

<ROWSET xmlns:xsi="http://www.w3.org/2001/XMLSchema-instance"
xsi:noNamespaceSchemaLocation="#/DOCUMENT/xsd:schema[not(@targetNamespace)]">
  <ROW num="1">
    <DEPTNO>120</DEPTNO>
    <DEPTNAME>Treasury</DEPTNAME>
    <DEPTADDR>
      <STREET>2004 Charade Rd</STREET>
      <CITY>Seattle</CITY>
      <STATE>WA</STATE>
      <ZIP>98199</ZIP>
    </DEPTADDR>
    <EMPLIST>
      <EMPLIST_ITEM>
        <EMPLOYEE_ID>1</EMPLOYEE_ID>
        <LAST_NAME>Mehta</LAST_NAME>
        <SALARY>6000</SALARY>
        <EMPLOYEE_ADDRESS>
          <STREET>500 Main Road</STREET>
          <CITY>Seattle</CITY>
          <STATE>WA</STATE>
          <ZIP>98199</ZIP>
        </EMPLOYEE_ADDRESS>
      </EMPLIST_ITEM>
    </EMPLIST>
  </ROW>
</ROWSET>
</DOCUMENT>

```

13.5.1.1.2 Default Mapping of Complex Type Columns to XML

The default mapping of complex-type columns to XML data is described.

The situation is more complex with elements corresponding to a complex-type column. In [Example 13-13](#) (page 13-42), `<DEPTADDR>` corresponds to the `dept1.deptAddr` column, which is of object type `AddressType`. Consequently, `<DEPTADDR>` contains child elements corresponding to the attributes specified in the type `AddressType`. The `AddressType` attribute `street` corresponds to the child XML element `<STREET>` and so forth. These subelements can contain data or subelements of their own, depending on whether the attribute they correspond to is of a simple or complex type.

13.5.1.1.3 Default Mapping of Collections to XML

The default mapping of database collections to XML data is described.

When dealing with elements corresponding to database collections, the situation is also different. In [Example 13-13](#) (page 13-42), the `<EMPLIST>` element corresponds to the `emplist` column of type `EmployeeListType`. Consequently, the `<EMPLIST>` element contains a list of `<EMPLIST_ITEM>` elements, each corresponding to an element of the collection. Note:

- The `<ROW>` elements contain a cardinality attribute `num`.
- If a particular column or attribute value is `NULL`, then for that row, the corresponding XML element is omitted.
- If a top-level scalar column name starts with the at sign (`@`) character, then the column is mapped to an XML attribute instead of an XML element.

13.5.1.2 Default XML-to-SQL Mapping

The default mapping of XML data to SQL data is described.

XML to SQL mapping is the reverse of SQL to XML mapping. Consider these differences when using XSU to map XML to SQL:

- When transforming XML to SQL, XSU ignores XML attributes. Thus, there is really no mapping of XML attributes to SQL.
- When transforming SQL to XML, XSU performs the mapping on a single `ResultSet` created by a SQL query. The query can span multiple database tables or views. When transforming XML into SQL, note:
 - To insert one XML document into multiple tables or views, you must create an object-relational view over the target schema.
 - If the view is not updatable, then you can use `INSTEAD OF INSERT` triggers.

If the XML document does not perfectly map to the target database schema, then you can perform these actions:

- Modify the target. Create an object-relational view over the target schema and make the view the new target.
- Modify the XML document by using XSLT to transform the XML document. You can register the XSLT stylesheet with XSU so that the incoming XML is automatically transformed before it attempts any mapping.
- Modify XSU's XML-to-SQL mapping. You can instruct XSU to perform case-insensitive matching of XML elements to database columns or attributes. For example, you can instruct XSU to do this:
 - Use the name of the element corresponding to a database row instead of `ROW`.
 - Specify the date format to use when parsing dates in the XML document.

13.5.1.3 Customizing Generated XML

In some situations, you might need to generate XML with a specific structure. Because the desired structure might differ from the default structure of the generated XML document, you need to have some flexibility in this process.

You can customize the structure of a generated XML document by using one of these methods:

- [Altering the Database Schema or SQL Query](#) (page 13-44)
- [Modifying XSU](#) (page 13-46)

13.5.1.3.1 Altering the Database Schema or SQL Query

You can perform source customizations by altering the SQL query or the database schema.

The simplest and most powerful source customizations include:

- In the database schema, create an object-relational view that maps to the desired XML document structure.
- In your query, do this:

- Use cursor subqueries or cast-multiset constructs to create nesting in the XML document that comes from a flat schema.
- Alias column and attribute names to get the desired XML element names.
- Alias top-level scalar type columns with identifiers that begin with the at sign (@) to make them map to an XML attribute instead of an XML element. For example, executing these statement generates an XML document in which the <ROW> element has the attribute empno:

```
SELECT employee_name AS "@empno",... FROM employees;
```

Consider the `customer.xml` document shown in [Example 13-14](#) (page 13-45).

Suppose you must design a set of database tables to store this data. Because the XML is nested more than one level, you can use an object-relational database schema that maps canonically to the preceding XML document. Run the `createObjRelSchema2.sql` script in SQL*Plus to create such a database schema.

You can load the data in the `customer.xml` document into the `customer_tab` table created by the script. Invoke XSU for Java from the command line:

```
java OracleXML putXML -user "hr/password" -fileName customer.xml customer_tab
```

To load `customer.xml` into a database schema that is not object-relational, you can create objects in views on top of a standard relational schema. For example, you can create a relational table that contains the necessary columns, then create a customer view that contains a customer object on top of it, as shown in the `createRelSchema.sql` script in [Example 13-15](#) (page 13-46).

You can load data into `customer_view`:

```
java OracleXML putXML -user "hr/password" -fileName customer.xml customer_view
```

Alternatively, you can flatten your XML with XSLT and then insert it directly into a relational schema. However, this is the least recommended option.

To map a particular column or a group of columns to an XML attribute instead of an XML element, you can create an alias for the column name and prepend the at sign (@) before the name of this alias. For example, you can use the `mapColumnToAtt.sql` script to query the `hr.employees` table, rendering `employee_id` as an XML attribute.

You can run the `mapColumnToAtt.sql` script from the command line:

```
java OracleXML getXML -user "hr/password" -fileName "mapColumnToAtt.sql"
```

Note:

All attributes must appear *before* any nonattribute.

Example 13-14 *customer.xml*

```
<?xml version = "1.0"?>
<ROWSET>
  <ROW num="1">
    <CUSTOMER>
      <CUSTOMERID>1044</CUSTOMERID>
      <FIRSTNAME>Paul</FIRSTNAME>
      <LASTNAME>Astoria</LASTNAME>
      <HOMEADDRESS>
```

```
<STREET>123 Cherry Lane</STREET>
<CITY>SF</CITY>
<STATE>CA</STATE>
<ZIP>94132</ZIP>
</HOMEADDRESS>
</CUSTOMER>
</ROW>
</ROWSET>
```

Example 13-15 createRelSchema.sql

```
CREATE TABLE hr.cust_tab
( customerid NUMBER(10),
  firstname VARCHAR2(20),
  lastname VARCHAR2(20),
  street VARCHAR2(40),
  city VARCHAR2(20),
  state VARCHAR2(20),
  zip VARCHAR2(20)
);

CREATE VIEW customer_view
AS
SELECT customer_type(customerid, firstname, lastname,
  address_type(street,city,state,zip)) customer
FROM cust_tab;
```

13.5.1.3.2 Modifying XSU

XSU lets you modify the rules that it uses to transform SQL data into XML.

You can make any of these changes when mapping SQL to XML:

- Change or omit the <ROWSET> or <ROW> tag.
- Change or omit the attribute num, which is the cardinality attribute of the <ROW> element.
- Specify the case for the generated XML element names.
- Specify that XML elements corresponding to elements of a collection must have a cardinality attribute.
- Specify the format for dates in the XML document.
- Specify that null values in the XML document must be indicated with a nullness attribute rather than by omitting the element.

13.5.2 How XSU Processes SQL Statements

How XSU processes SQL statements is described.

- [How XSU Queries the Database](#) (page 13-47)
- [How XSU Inserts Rows](#) (page 13-47)
- [How XSU Updates Rows](#) (page 13-47)
- [How XSU Deletes Rows](#) (page 13-48)
- [How XSU Commits After DML](#) (page 13-49)

13.5.2.1 How XSU Queries the Database

XSU executes SQL queries and retrieves the `ResultSet` from the database. XSU then acquires and analyzes metadata about the `ResultSet`.

Using the mapping described in [Default SQL-to-XML Mapping](#) (page 13-41), XSU processes the SQL result set and converts it into an XML document.

XSU cannot handle certain types of queries, especially those that mix columns of type `LONG` or `LONG RAW` with `CURSOR ()` expressions in the `SELECT` clause. `LONG` and `LONG RAW` are two examples of data types that JDBC accesses as streams and whose use is deprecated. If you migrate these columns to `CLOBs`, then the queries succeed.

13.5.2.2 How XSU Inserts Rows

The steps that XSU performs when inserting an XML document into a table or view are described.

When inserting the contents of an XML document into a table or view, XSU does the following:

1. Retrieves metadata about the target table or view.
2. Generates a SQL `INSERT` statement based on the metadata. For example, assume that the target table is `dept1` and the XML document is generated from `dept1`. XSU generates this `INSERT` statement:

```
INSERT INTO dept1 (deptno, deptname, deptaddr, emplist) VALUES (?, ?, ?, ?)
```

3. Parses the XML document, and for each record, it binds the appropriate values to the appropriate columns or attributes. For example, it binds the values for `INSERT` statement:

```
deptno    <- 100
deptname  <- SPORTS
deptaddr  <- AddressType('100 Redwood Shores Pkwy', 'Redwood Shores',
                        'CA', '94065')
emplist   <- EmployeeListType(EmployeeType(7369, 'John', 100000,
                        AddressType('300 Embarcadero', 'Palo Alto', 'CA', '94056'), ...))
```

4. Executes the statement. You can optimize `INSERT` processing to insert in batches and commit in batches.

See Also:

- [Default SQL-to-XML Mapping](#) (page 13-41)
 - [Inserting Rows with OracleXMLSave](#) (page 13-25) for more detail on batching
-

13.5.2.3 How XSU Updates Rows

Updates and delete statements differ from inserts in that they can affect more than one row in the database table.

For inserts, each `<ROW>` element of the XML document can affect at most one row in the table if no triggers or constraints are on the table. With updates and deletes, the XML element can match more than one row if the matching columns are not key columns in the table.

For update statements, you must provide a list of key columns that XSU must identify the row to update. For example, assume that you have an XML document that contains this fragment:

```
<ROWSET>
  <ROW num="1">
    <DEPTNO>100</DEPTNO>
    <DEPTNAME>SportsDept</DEPTNAME>
  </ROW>
</ROWSET>
```

You want to change the DEPTNAME value from `Sports` to `SportsDept`. If you supply the DEPTNO as the key column, then XSU generates this UPDATE statement:

```
UPDATE dept1 SET deptname = ? WHERE deptno = ?
```

XSU binds the values in this way:

```
deptno <- 100
deptname <- SportsDept
```

For updates, you can also choose to update only a set of columns and not all the elements present in the XML document.

See Also:

[Updating Rows Using OracleXMLSave](#) (page 13-27)

13.5.2.4 How XSU Deletes Rows

For row deletions, you can choose to provide a set of key columns, so that XSU can identify the rows to be deleted. If you do not provide a set of key columns then the DELETE statement tries to match all the columns in the document.

Assume that you pass this document to XSU:

```
<ROWSET>
  <ROW num="1">
    <DEPTNO>100</DEPTNO>
    <DEPTNAME>Sports</DEPTNAME>
    <DEPTADDR>
      <STREET>100 Redwood Shores Pkwy</STREET>
      <CITY>Redwood Shores</CITY>
      <STATE>CA</STATE>
      <ZIP>94065</ZIP>
    </DEPTADDR>
  </ROW>
  <!-- additional rows ... -->
</ROWSET>
```

XSU builds a DELETE statement for each ROW element:

```
DELETE FROM dept1 WHERE deptno = ? AND deptname = ? AND deptaddr = ?
```

The binding is:

```
deptno <- 100
deptname <- sports
deptaddr <- addressstype('100 redwood shores pkwy','redwood city','ca',
  '94065')
```

See Also:[Deleting Rows using XSU](#) (page 13-30)

13.5.2.5 How XSU Commits After DML

By default, XSU performs no explicit commits. If `AUTOCOMMIT` is on, which is the default for a JDBC connection, then after each batch of statement executions XSU executes a `COMMIT`.

You can override this behavior by turning `AUTOCOMMIT` off and then using `setCommitBatch` to specify the number of statement executions before XSU commits. If an error occurs, then XSU rolls back to either the state the target table was in before the call to XSU, or the state after the last commit made during the current call to XSU.

Using the TransX Utility

An explanation is given of how to use the TransX utility to transfer XML data to a database.

Topics:

- [Introduction to the TransX Utility](#) (page 14-1)
- [Using the TransX Utility: Overview](#) (page 14-3)
- [Loading Data with the TransX Utility](#) (page 14-10)

See Also:

[Data Loading Format \(DLF\) Specification](#) (page 15-1)

14.1 Introduction to the TransX Utility

The TransX utility is described.

[TransX Utility](#) lets you transfer XML data to a database. TransX is an application of [XML SQL Utility \(XSU\)](#) that loads translated seed data and messages into a database schema.

TransX is particularly useful when handling multilingual Extensible Markup Language (XML). You can use TransX to add data to a database in multiple languages. The utility does this:

- Automatically manages the change variables, start sequences, and additional structured query language (SQL) statements that would otherwise require multiple inserts or sessions. Thus, translation vendors do not have to work with unfamiliar SQL and Procedural Language/Structured Query Language (PL/SQL) scripts.
- Automates character encoding. Consequently, loading errors due to incorrect encoding are impossible if the data file conforms with the XML standard.
- Reduces globalization costs by preparing strings to be translated, translating the strings, and loading them into the database.
- Minimizes translation data format errors and accurately loads the translation contents into predetermined locations in the database. When the data is in a predefined format, the TransX utility validates it.
- Eliminates syntax errors due to varying Globalization Support settings.
- Does not require the UNISTR construct for every piece of NCHAR data.

Note:

TransX runs as the authenticated user. Care must be taken to review data files and to load data files only from a trusted source.

14.1.1 Prerequisites for Using the TransX Utility

Prerequisites for using the TransX utility are described.

This chapter assumes that you are familiar with [XML SQL Utility \(XSU\)](#) because TransX is an application of XSU.

See Also:

[Using the XML SQL Utility](#) (page 13-1)

14.1.2 TransX Utility Features

Topics here include simplified multilingual data loading, simplified data format support, and other TransX Utility features.

- [Simplified Multilingual Data Loading](#) (page 14-2)
- [Simplified Data Format Support and Interface](#) (page 14-3)
- [Additional TransX Utility Features](#) (page 14-3)

14.1.2.1 Simplified Multilingual Data Loading

The traditional translation data loading method is to change environment variable `NLS_LANG` when switching load files. This sets the language and territory used by client applications and the database server. It also sets the client character set, which is used for data entered or displayed by a client program.

When inserting multilingual data or data translations into a database, or when encoding, each XML file requires validation.

In the traditional method, each load file is encoded in a character set suitable for its language, which is necessary because translations must be performed in the same file format—typically in a SQL script—as the original. The `NLS_LANG` setting changes as files are loaded to adapt to the character set that corresponds to the language. As well as consuming time, this approach is error-prone because the encoding metadata is separate from the data itself.

With the TransX utility you use an XML document with a predefined format called a data set. The data set contains the encoding information and the data so that you can transfer multilingual data without changing `NLS_LANG` settings. The TransX utility frees development and translation groups by maintaining the correct character set while loading XML data into the database.

See Also:

Oracle Database Globalization Support Guide to learn about the `NLS_LANG` environment variable

14.1.2.2 Simplified Data Format Support and Interface

The TransX Utility provides a command-line interface and a programmable application programming interface (API). The utility complies with a data format that is the canonical method for the representation of seed data loaded into the database. The format is easy to understand and simplified for use by translation groups.

The format specification defines how translators can describe the data so that it is loaded in an expected way. You can represent the values in the data set with scalar values or expressions such as constants, sequences, and queries.

14.1.2.3 Additional TransX Utility Features

Other useful TransX Utility features are described.

Table 14-1 TransX Utility Features

Feature	TransX Utility . . .
Command-line interface	Provides easy-to-use commands.
User API	Exposes a Java API.
Validation	Validates the data format and reports errors.
White space handling	Does not consider white space characters in the data set as significant unless otherwise specified in various granularity.
Unloading	Exports the result into the standard data format based on an input query.
Intimacy with translation exchange format	Enables transformation to and from translation exchange format.
Localized user interface	Provides messages in many languages.

14.2 Using the TransX Utility: Overview

Topics here describe how to use the TransX utility.

Topics:

- [Using the TransX Utility: Basic Process](#) (page 14-3)
- [Running the TransX Utility Demo Programs](#) (page 14-6)
- [Using the TransX Command-Line Utility](#) (page 14-7)

14.2.1 Using the TransX Utility: Basic Process

The TransX API basic process is described.

TransX is accessible through this API:

- `oracle.xml.transx.loader` class, which contains the `getLoader()` method to get a TransX instance
- `oracle.xml.transx.TransX` interface, which is the TransX API

Figure 14-1 (page 14-4) shows the basic process for using the TransX API to transfer XML to a database.

Figure 14-1 Basic Process of a TransX Application

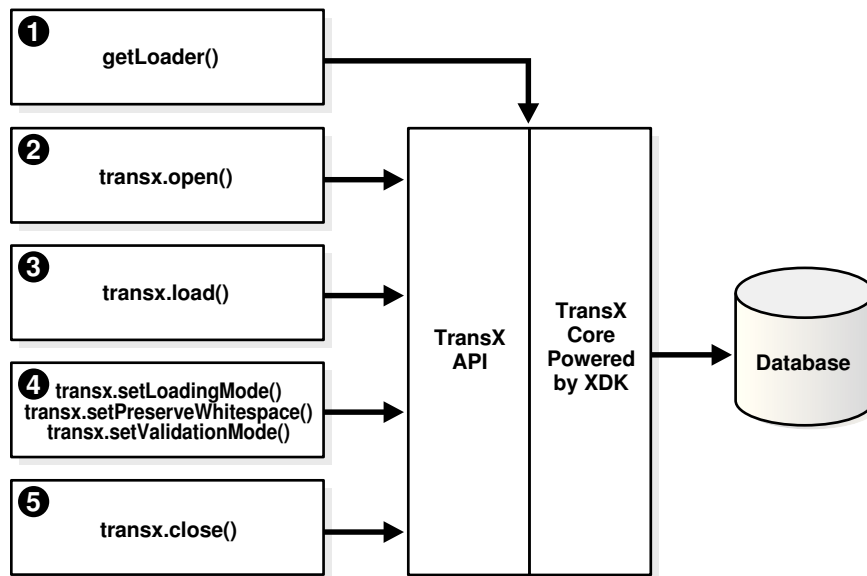

The basic process of a TransX application is:

1. Create a TransX loader object. Instantiate the TransX class by invoking `getLoader()`:

```
TransX transx = loader.getLoader();
```

2. Start a data loading session by supplying database connection information using `TransX.open()`. You create a session by supplying the Java Database Connectivity (JDBC) connect string, database user name, and database password. You can create the connection in one of these ways:

- Using the JDBC Oracle Call Interface (OCI) driver. The following code fragment shows this technique and connects with the supplied user name and password:

```
transx.open( "jdbc:oracle:oci8:@", user, passwd );
```

- Using the JDBC thin driver. The thin driver is written in pure Java and can be called from any Java program. The following code fragment shows this technique and connects:

```
transx.open( "jdbc:oracle:thin:@//myhost:1521/my servicename", user, passwd );
```

The thin driver requires the host name (`myhost`), port number (1521), and the service name (`my servicename`). The database must have an active Transmission Control Protocol/Internet Protocol (TCP/IP) listener.

Note:

If you are validating only your data format, you do not have to establish a database connection because the validation is performed by TransX. Thus, you can invoke the `TransX.validate()` method without a preceding `open()` invocation.

3. Configure the TransX loader. [Table 14-2](#) (page 14-5) describes configuration methods.

Table 14-2 TransX Configuration Methods

Method	Description
<code>setLoadingMode()</code>	Sets the operation mode on duplicates. The mode determines TransX behavior when there are one or more existing rows in the database whose values in the key columns are the same as those in the data set to be loaded. You can specify the constants <code>EXCEPTION_ON_DUPLICATES</code> , <code>SKIP_DUPLICATES</code> , or <code>UPDATE_DUPLICATES</code> in class <code>oracle.xml.transx.LoadingMode</code> . By default the loader skips duplicates.
<code>setNormalizeLangTag()</code>	Sets the case of language tag. By default the loader uses the style specified in the <code>normalize-langtag</code> attribute on Data Loading Format (DLF).
<code>setPreserveWhitespace()</code>	Specifies how the loader handles white space. The default is <code>FALSE</code> , which means that the loader ignores the type of white space characters in the data set and loads them as space characters. The loader treats consecutive white space characters in the data set as one space character.
<code>setValidationMode()</code>	Sets the validation mode. The default is <code>TRUE</code> , which means that the loader performs validation of the data set format against the canonical schema definition on each <code>load()</code> invocation. The validation mode is disabled only if the data set has already been validated.

The following example specifies that the loader must skip duplicate rows and not validate the data set:

```
transx.setLoadingMode( LoadingMode.SKIP_DUPLICATES );
transx.setValidationMode( false );
```

4. Load the data sets by invoking `TransX.load()`. The same JDBC connection is used during the iteration of the load operations. For example, load three data sets:

```
String datasrc[] = {"data1.xml", "data2.xml", "data3.xml"};
...
for ( int i = 0 ; i < datasrc.length ; i++ )
{
    transx.load( datasrc[i] );
}
```

5. Close the loading session by invoking `TransX.close()`. This method invocation closes the database connection:

```
transx.close();
```

See Also:

- *Oracle Database Java Developer's Guide* to learn about Oracle JDBC
- *Oracle Database XML Java API Reference* to learn about TransX classes and methods

14.2.2 Running the TransX Utility Demo Programs

Demo programs for the TransX utility are included in `$ORACLE_HOME/xdk/demo/java/transx`.

[Table 14-3](#) (page 14-6) describes the XML files and programs that you can use to test the utility.

Table 14-3 TransX Utility Sample Files

File	Description
README	A text file that describes how to set up the TransX demos.
emp-dlf.xml	A sample output file. The following command generates a file <code>emp.xml</code> that contains all data in the table <code>emp</code> : <pre>transx -s "jdbc:oracle:thin:@//myhost:1521/myservicename" user -pw emp.xml emp</pre> <p>The <code>emp-dlf.xml</code> file must be identical to <code>emp.xml</code>.</p>
txclean.sql	A SQL file that drops the tables and sequences created for the demo.
txdemo1.java	A sample Java application that creates a JDBC connection and loads three data sets into the database.
txdemo1.sql	A SQL script that creates two tables and a sequence for use by the demo application.
txdemo1.xml	A sample data set.

Documentation for how to compile and run the sample programs is located in the README. The basic steps are:

1. Change into the `$ORACLE_HOME/xdk/demo/java/transx` directory (UNIX) or `%ORACLE_HOME%\xdk\demo\java\transx` directory (Windows).
2. Make sure that your environment variables are set as described in [Setting Up the XDK for Java Environment](#) (page 3-5). Oracle recommends that you set the `$ORACLE_SID` (UNIX) or `%ORACLE_SID%` (Windows) environment variables to the default database.

Note:

For security, do not expose passwords in command-line interfaces. If `-pw` is specified instead of the password in TransX, the user is prompted for the password [Enter password :]. When the user types the password, it is not echoed; instead, "*"s is printed in the command window.

3. Set up the sample database objects by executing `txdemo1.sql`. Connect to the database and run the `txdemo1.sql` script:

```
@txdemo1
```

4. Run the TransX utility from the command line. This example shows how to connect with the Java thin driver, where your host is `myhost`, your port is 1521, and your service name is `myservicename`. Enter the user name where the token `user` appears. You can execute this command to load data set `txdemo1.xml`:

```
transx "jdbc:oracle:thin:@//myhost:1521/myservicename" user -pw txdemo1.xml
```

When the operation is successful, nothing is printed out on your terminal.

5. Query the database to determine whether the load was successful. For example:

```
SELECT * FROM i18n_messages;
```

6. Drop the demo objects to prepare for another test. Connect to the database and run the `txclean.sql` script:

```
@txclean
```

7. Compile the Java demo program. For example:

```
javac txdemo1.java
```

8. Run the Java program, using the same JDBC and database connection data that you used when invoking the command-line interface. For example:

```
java txdemo1 "jdbc:oracle:thin:@//myhost:1521/myservicename" user -pw\  
txdemo1.xml
```

Perform the same query test (Step 5 (page 14-7)) and cleanup operation (Step 6 (page 14-7)) as before.

9. Run the TransX Utility to unload data into the predefined XML format. For example:

```
transx -s "jdbc:oracle:thin:@//myhost:1521/myservicename" user -pw emp.xml emp
```

Compare the data in `emp.xml` with `emp-dlf.xml`.

Note:

For simplicity in demonstrating this feature, this example does not perform the password management techniques that a deployed system normally uses. In a production environment, follow the Oracle Database password management guidelines, and disable any sample accounts. See *Oracle Database Security Guide* for password management guidelines and other security recommendations.

14.2.3 Using the TransX Command-Line Utility

TransX utility is packaged with Oracle Database. By default, the Oracle Universal Installer installs the utility on disk.

As explained in [XDK for Java Component Dependencies](#) (page 3-2), the TransX library is `$ORACLE_HOME/lib/xml.jar` (UNIX) and `%ORACLE_HOME%\lib\xml.jar` (Windows).

You can run the TransX utility from the operating system command line with this syntax:

```
java oracle.xml.transx.loader
```

Oracle XML Developer's Kit (XDK) includes a script version of TransX named `$ORACLE_HOME/bin/transx` (UNIX) and `%ORACLE_HOME%\bin\transx.bat` (Windows). Assuming that your `PATH` variable is set correctly, you can run TransX:

```
transx options parameters
transx.bat options parameters
```

For example, this command shows valid syntax:

```
transx -s "jdbc:oracle:thin:@//myhost:1521/my servicename" user -pw emp.xml emp
```

14.2.3.1 TransX Utility Command-Line Options

The command-line options for the TransX Utility are described.

Table 14-4 TransX Utility Command-Line Options

Option	Meaning	Description
-u	Update existing rows.	Does not skip existing rows but updates them. To exclude a column from the update operation, set the <code>useforupdate</code> attribute to <code>no</code> .
-e	Raise exception if a given row already exists in the database.	Raises an exception if a duplicate row is found. By default, TransX skips duplicate rows. Rows are considered duplicate if the values for lookup-key column(s) in the database and the data set are the same.
-x	Print database data in the predefined format.	Similar to the <code>-s</code> option, it causes the utility to perform the opposite operation of loading. Unlike the <code>-s</code> option, it prints to <code>stdout</code> . Redirecting this output to a file is discouraged because intervention of the operating system may cause data loss due to unexpected transcoding.
-s	Save database data to a file in the predefined format.	Performs unloading. TransX Utility queries the database, formats the result into the predefined XML format, and stores it under the specified file name.
-p	Print the XML to load.	Prints out the data set for insert in the canonical format of XSU.
-t	Print the XML for update.	Prints out the data set for update in the canonical format of XSU.
-o	Omit validation (as the data set is parsed it is validated by default).	Causes TransX Utility to skip the format validation, which is performed by default.

Table 14-4 (Cont.) TransX Utility Command-Line Options

Option	Meaning	Description
-v	Validate the data format and exit without loading.	Causes TransX Utility to perform validation and exit.
-w	Preserve white space.	Causes TransX Utility to treat white space characters (such as \t, \r, \n, and ') as significant. The utility condenses consecutive white space characters in string data elements into one space character by default.
-l	Set the case of language tag.	Causes TransX Utility to override the style of normalizing the case of language tag specified in the <code>normalize-langtag</code> attribute on DLF or the <code>setNormalizeLangTag()</code> method on the TransX API. Valid options are <code>-ls</code> , <code>-lu</code> and <code>-ll</code> for standard, uppercase and lowercase, respectively.

Command-line option exceptions:

- `-u` and `-e` are mutually exclusive.
- `-v` must be the only option followed by data, as shown in the examples.
- `-x` must be the only option followed by connect information and a SQL query, as shown in the examples.

Omitting all arguments produces the display of the usage information shown in [Table 14-4](#) (page 14-8).

14.2.3.2 TransX Utility Command-Line Parameters

The command-line parameters for the TransX utility are described.

Table 14-5 TransX Utility Command-Line Parameters

Parameter	Description
<code>connect_string</code>	The JDBC connect string. See <i>Oracle Database JDBC Developer's Guide</i> ,
<code>username</code>	Database user name (schema).
<code>password</code>	Password for the database user, or <code>"-pw"</code> .
<code>datasource</code>	An XML document specified by file name or URL.
<code>options</code>	Described in Table 14-4 (page 14-8).

See Also:

Oracle Database XML Java API Reference for complete details of the TransX interface

14.3 Loading Data with the TransX Utility

You can use the TransX utility to populate a database with multilingual data. To transfer data in and out of a database schema, you create a data set that maps to this schema. A scenario is described in which you use TransX to organize translated application messages in a database.

Topics:

- [Storing Messages in the Database](#) (page 14-10)
- [Creation of a Data Set in a Predefined Format](#) (page 14-11)
- [Loading the Data](#) (page 14-16)
- [Querying the Data](#) (page 14-17)

14.3.1 Storing Messages in the Database

Data that is specific to a particular region and shares a common language and cultural conventions must be organized with a resource management facility that can retrieve locale-specific information. A database is often used to store such data because of easy maintenance and flexibility.

To build an internationalized system, it is essential to decouple localizable resources from business logic. A typical example of such a resource is translated text information.

Assume that you create the table with the structure and content shown in [Example 14-1](#) (page 14-10) and insert data.

The column `language_id` is defined in this table so that applications can retrieve messages based on the preferred language of the end user. It contains abbreviations of language names to identify the language of messages.

[Example 14-2](#) (page 14-11) shows sample data for the table.

See Also:

Oracle Database Globalization Support Guide for Oracle language abbreviations

Example 14-1 Structure of Table `translated_messages`

```
CREATE TABLE translated_messages
(
  MESSAGE_ID      NUMBER(4)
                 CONSTRAINT tm_mess_id_nn NOT NULL
, LANGUAGE_ID    VARCHAR2(42)
, MESSAGE        VARCHAR2(200)
);
```

Example 14-2 Query of translated_messages

MESSAGE_ID	LANGUAGE_ID	MESSAGE
1	us	Welcome to System X
2	us	Please enter username and password

14.3.2 Creation of a Data Set in a Predefined Format

An example shows an XML document that represents the translated_messages table.

[Data Loading Format \(DLF\) Specification](#) (page 15-1) describes the complete syntax of the DLF language. This language is used to create a DLF document that provides the input to TransX.

Given the data set (the input data) in the canonical format, the TransX Utility loads the data into the designated locations in the database. TransX does not create the database objects: you must create the tables or views before attempting to load data.

An XML document that represents the translated_messages table created in [Example 14-1](#) (page 14-10) looks something like [Example 14-3](#) (page 14-11). The data set reflects the structure of the target table, which in this case is called translated_messages.

Example 14-3 example.xml

```
<?xml version="1.0"?>
<table name="translated_messages">
  <!-- Specify the unique identifier -->
  <lookup-key>
    <column name="message_id" />
    <column name="language_id" />
  </lookup-key>
  <!-- Specify the columns into which data will be inserted -->
  <columns>
    <column name="message_id" type="number"/>
    <column name="language_id" type="string" constant="us" translate="yes"/>
    <column name="message" type="string" translate="yes"/>
  </columns>
  <!-- Specify the data to be inserted -->
  <dataset>
    <row>
      <col name="message_id">1</col>
      <col name="message" translation-note="dnt'X'">Welcome to System X</col>
    </row>
    <row>
      <col name="message_id">2</col>
      <col name="message">Please enter username and password</col>
    </row>
    <!-- ... -->
  </dataset>
</table>
```

14.3.2.1 Format of the Input XML Document

The format of the input XML document is described.

The XML document in [Example 14-3](#) (page 14-11) starts with this declaration:

```
<?xml version="1.0"?>
```

Its root element `<table>`, which has an attribute that specifies the name of the table, encloses all the other elements:

```
<table name="translated_messages">
...
</table>
```

As explained in [Elements in DLF](#) (page 15-6), the `<table>` element contains three subsections:

- [Lookup Key Elements](#) (page 15-7)
- [Metadata Elements](#) (page 15-8)
- [Data Elements](#) (page 15-8)

The preceding sections map to elements in [Example 14-3](#) (page 14-11):

```
<lookup-key>...</lookup-key>
<columns>...</columns>
<dataset>...</dataset>
```

The lookup keys are columns used to evaluate rows if they already exist in the database. Because you want a pair of message and language identifiers to identify a unique string, the document lists the corresponding columns. Thus, the `message_id`, `language_id`, and `message` columns in table `translated_messages` map to the attributes in the `<column>` element:

```
<column name="message_id" type="number"/>
<column name="language_id" type="string" constant="us" translate="yes"/>
<column name="message" type="string" translate="yes"/>
```

The columns section must mirror the table structure because it specifies which piece of data in the data set section maps to which table column. The column names must be consistent throughout the XML data set and database. You can use the `<column>` attributes in [Table 14-6](#) (page 14-12) to describe the data to be loaded. These attributes form a subset of the DLF attributes described in [Attributes in DLF](#) (page 15-9).

Table 14-6 `<column>` Attributes

Attribute	Description	Example
type	Specifies the data type of a column in the data set. This attribute specifies the kind of text contained in the <code><col></code> element in the data set. Depending on this type, the data loading tool applies different data type conventions to the data.	<code><column name="col" type="string" /></code>
constant	Specifies a constant value. A column with a fixed value for each row does not have to repeat that same value.	<code><column name="col" type="string" constant="us" /></code>

Table 14-6 (Cont.) <column> Attributes

Attribute	Description	Example
language	The language attribute indicates that the column is the language column, which stores a language tag. It works in the same way as the constant attribute, except for the role to declare the column is the language column.	<code><column name="language" type="string" language="us" /></code>
sequence	Specifies a sequence in the database used to fill in the value for this column.	<code><column name="id" type="number" sequence="id_sq" /></code>
translate	Indicates whether the text of this column or parameter is to be translated.	<code><column name="msg" type="string" translate="yes"/></code>

The constant attribute of a `<column>` element specifies a value to be stored into the corresponding column for every row in the `<dataset>` section. Because this example is working in the original language, the `language_id` column is set to the value `us`.

Defining the Language Column

Alternatively, the `language_id` column may use the `language` attribute instead of the constant attribute. A DLF document with the `language` attribute can use the `lang` attribute in the `xml` namespace. A language column can use the `"%x"` placeholder to get its value from the standard `xml:lang` attribute at the root table element. Thus `translate="yes"` is not required, because the value `"%x"` does not have to be translated. The result of loading this DLF is the same as Example 10-3.

As explained in [Table 15-10](#) (page 15-9), the valid values for the `type` attribute are `string`, `number`, `date`, and `dateTime`. These values correspond to the data types defined in the XML schema standard, so each piece of data must conform to the respective data type definition. In particular, it is important to use the International Organization for Standardization (ISO) 8601 format for the `date` and `dateTime` data types, as shown in [Table 14-7](#) (page 14-13).

Table 14-7 date and dateTime Formats

Data Type	Format	Example
date	CCYY-MM-DD	2009-05-20
dateTime	CCYY-MM-DDThh:mm:ss	2009-05-20T16:01:37

[Example 14-5](#) (page 14-14) shows how you can represent a table row with `dateTime` data in a TransX data set.

Example 14-4 example.xml with a Language Attribute

```
<?xml version="1.0"?>
<table xml:lang="us" name="translated_messages">
  <!-- Specify the unique identifier -->
  <lookup-key>
    <column name="message_id" />
  </lookup-key>
</table>
```

```

    <column name="language_id" />
</lookup-key>
<!-- Specify the columns into which data will be inserted -->
<columns>
  <column name="message_id" type="number"/>
  <column name="language_id" type="string" language="%x"/>
  <column name="message" type="string" translate="yes"/>
</columns>
<!-- Specify the data to be inserted -->
<dataset>
  <row>
    <col name="message_id">1</col>
    <col name="message" translation-note="dnt'X'">Welcome to System X</col>
  </row>
  <row>
    <col name="message_id">2</col>
    <col name="message">Please enter username and password</col>
  </row>
  <!-- ... -->
</dataset>
</table>

```

Example 14-5 *dateTime Row*

```

<row>
  <col name="article_id">12345678</col>
  <col name="author_id">10500</col>
  <col name="submission">2002-03-09T16:01:37</col>
  <col name="title">...</col>
  <!-- some columns follows -->
</row>

```

14.3.2.2 Specifying Translations in a Data Set

You can use the `translation` attribute to specify whether a column contains translated data.

This is explained in [Attributes in DLF](#) (page 15-9). In [Example 14-3](#) (page 14-11), two `<column>` elements use the `translate` attribute differently. The attribute for the `language_id` column specifies that the value of the constant attribute must be translated:

```
<column name="language_id" type="string" constant="us" translate="yes"/>
```

In contrast, this `translate` attribute requests translation of the data in the `<dataset>` section with a name that matches this column:

```
<column name="message" type="string" translate="yes"/>
```

For example, the preceding element specifies that these messages in the `<dataset>` section must be translated:

```
<col name="message" translation-note="dnt'X'">Welcome to System X</col>
<col name="message">Please enter username and password</col>
```

When translating messages for applications, you might decide to leave specified words or phrases untranslated. The `translation-note` attribute shown in the preceding example achieves this goal.

An Extensible Stylesheet Language Transformation (XSLT) processor can convert the preceding format into another format for exchanging translation data among localization service providers for use with XML-based translation tools. This

transformation insulates developers from tasks such as keeping track of revisions, categorizing translatable strings into units, and so on.

[Example 14-6](#) (page 14-15) shows what (the beginning of) the document in [Example 14-3](#) (page 14-11) looks like after translation.

[Example 14-7](#) (page 14-15) shows what the document in [Example 14-4](#) (page 14-13) looks like after translation. Unlike the previous example, the column definition is not changed.

If you use a text editor or a traditional text-based translation tool during the translation process, it is important to maintain the encoding of the document. After a document is translated, it may be in a different encoding from the original. As explained in [XML Declaration in DLF](#) (page 15-5), if the translated document is in an encoding other than Unicode, then add the encoding declaration to the XML declaration on the first line. A declaration for non-Unicode encoding looks like these:

```
<?xml version="1.0" encoding="ISO-8859-15"?>
```

To ensure that the translation process does not lose syntactic integrity, process the document as XML. Otherwise, you can check the format by specifying the `-v` option of the command-line interface. If a syntactic error exists, the utility prints the location and description of the error. You must fix errors for the data transfer to succeed.

See Also:

[Data Loading Format \(DLF\) Specification](#) (page 15-1)

Example 14-6 *example_es.xml*

```
<?xml version="1.0"?>
<table xml:lang="es" name="translated_messages">
<!-- Specify the unique identifier -->
<lookup-key>
<column name="message_id" />
<column name="language_id" />
</lookup-key>
<!-- Specify the columns into which data will be inserted -->
<columns>
<column name="message_id" type="number"/>
<column name="language_id" type="string" constant="es"
translate="yes"/>
```

Example 14-7 *example_es.xml with a Language Attribute*

```
<?xml version="1.0"?>
<table xml:lang="es" name="translated_messages">
<!-- Specify the unique identifier -->
<lookup-key>
<column name="message_id" />
<column name="language_id" />
</lookup-key>
<!-- Specify the columns into which data will be inserted -->
<columns>
<column name="message_id" type="number"/>
<column name="language_id" type="string" language="%x"/>
...
```

14.3.3 Loading the Data

The use of demo program `txdemo1.java` is described.

You can load the sample documents in [Example 14-3](#) (page 14-11) and [Example 14-8](#) (page 14-17) into the `translated_messages` table that you created in [Example 14-1](#) (page 14-10). Then, you can use the sample program in [Example 14-8](#) (page 14-17), which you can find in the TransX demo directory, to load the data.

The `txdemo1.java` program follows these steps:

1. Create a TransX loader object. For example:

```
TransX transx = loader.getLoader();
```

2. Open a data loading session. The first three command-line parameters are the JDBC connect string, database user name, and database password. These parameters are passed to the `TransX.open()` method. The program includes this statement:

```
transx.open( args[0], args[1], args[2] );
```

3. Configure the TransX loader. The program configures the loader to skip duplicate rows and to validate the input data set. The program includes these statements:

```
transx.setLoadingMode( LoadingMode.SKIP_DUPLICATES );  
transx.setValidationMode( false );
```

4. Load the data. The first three command-line parameters specify connection information; any additional parameters specify input XML documents. The program invokes the `load()` method for every specified document:

```
for ( int i = 3 ; i < args.length ; i++ )  
{  
    transx.load( args[i] );  
}
```

5. Close the data loading session. The program includes this statement:

```
transx.close();
```

After compiling the program with `javac`, you can run it from the command line. The following example uses the Java thin driver to connect to instance `mydb` on port 1521 of computer `myhost`. It connects to the `user` schema and loads the XML documents `example.xml` and `example_es.xml`:

```
java txdemo1 "jdbc:oracle:thin:@//myhost:1521/mydb" user -pw example.xml  
example_es.xml
```

In building a multilingual software system, translations usually become available at a later stage of development. They also tend to evolve over time. To add messages to the database later, run the TransX utility again to add new rows in your data set definition. TransX recognizes which rows are new and inserts only the new messages based on the columns specified in the `<lookup-key>` section. If some messages are updated, then run TransX with the `-u` option to update existing rows with the data specified in XML, as shown in this example:

```
transx -u "jdbc:oracle:thin:@//myhost:1521/mydb" user -pw example.xml  
example_es.xml
```

Example 14-8 txdemo1.java

```
// Copyright (c) 2001 All rights reserved Oracle Corporation

import oracle.xml.transx.*;

public class txdemo1 {

    /**
     * Constructor
     */
    public txdemo1() {
    }

    /**
     * main
     * @param args
     *
     * args[0] : connect string
     * args[1] : username
     * args[2] : password
     * args[3+] : xml file names
     */
    public static void main(String[] args) throws Exception {

        // instantiate a transx class
        TransX transx = loader.getLoader();

        // start a data loading session
        transx.open( args[0], args[1], args[2] );

        // specify operation modes
        transx.setLoadingMode( LoadingMode.SKIP_DUPLICATES );
        transx.setValidationMode( false );

        // load the dataset(s)
        for ( int i = 3 ; i < args.length ; i++ )
        {
            transx.load( args[i] );
        }

        // cleanup
        transx.close();
    }
}
```

14.3.4 Querying the Data

The result of querying table `translated_messages` is shown.

After using the program in [Example 14-8](#) (page 14-17) to load the data, you can query table `translated_messages` to see the result, which looks like this:

MESSAGE_ID	LANGUAGE_ID	MESSAGE
-----	-----	-----
1	us	Welcome to System X
1	es	Bienvenido al Sistema X
2	us	Please enter username and password
2	es	Porfavor entre su nombre de usuario y su contraseña

An application can retrieve a message in a specific language by using the `language_id` and `message_id` columns in a `WHERE` clause. For example, you can execute this query:

```
SELECT message
FROM   translated_messages
WHERE  message_id = 2
AND    language_id = 'es';
```

MESSAGE

Porfavor entre su nombre de usuario y su contraseña

Data Loading Format (DLF) Specification

A description is given of version 1.0 of the Data Loading Format (DLF), which is the standard format for describing translated messages and seed data loaded into the database by the TransX utility.

Topics:

- [Introduction to DLF](#) (page 15-1)
- [General Structure of DLF](#) (page 15-2)
- [DLF Specifications](#) (page 15-5)
- [DLF Examples](#) (page 15-13)

See Also:

[Using the TransX Utility](#) (page 14-1)

15.1 Introduction to DLF

DLF defines a standard format for loading data with the TransX utility. It is intended to supersede loading data with SQL scripts. DLF provides these advantages:

- Format validation. Validation reduces errors during the translation and loading processes.
- Ease of use. The user does not have to maintain the character encoding of each data file to correspond with the language used in the data file.

DLF is based on the XML 1.0 specification.

Note:

TransX runs as the authenticated user. Be sure to review your data files, and load data files only from a trusted source.

See Also:

[IETF RFC4646] Tags for the Identification of Languages, <http://www.ietf.org/rfc/rfc4646>

15.1.1 Naming Conventions for DLF

This section describes the naming conventions used in this document.

15.1.1.1 Elements and Attributes

Naming conventions for elements and attributes that are used in this document are described.

- Standard English letters
- Lowercase letters only
- Hyphen (-) may be used for concatenation
- Attribute names must be consistently defined throughout
- Industry-standard terminology must be followed wherever possible

15.1.1.2 Values

Values are case-sensitive except for some attribute values used for column names. All predefined attribute values are lowercase. No element values are defined by this specification.

15.1.1.3 File Extensions

No file extension is recommended by this specification. A future version of this specification may recommend that documents use an extension that conforms with an 8.3 standard.

15.2 General Structure of DLF

Data Loading Format is XML, so it begins with an XML declaration. After the XML declaration comes the DLF document itself, enclosed within element `<table>`.

A DLF document is composed of these required sections:

- The `<lookup-key>` element contains a list of column names that determine whether existing rows in the database are duplicates of the rows in the data set definition included in the `<dataset>` element.
- The `<columns>` element contains metadata about the `<dataset>` element such as the names, data types, and attributes of columns.
- The `<dataset>` element contains a `<row>` element for each row, which in turn contains a `<col>` element that corresponds to a piece of data that is loaded in a database column. In this way a DLF document looks similar to the familiar tabular format in printing data in the database and allows easy editing.

DLF provides one optional section, which is enclosed within a `<translation>` element. This section may precede the required sections.

In addition, DLF provides information about TransX utility processing. Such information includes but is not limited to this:

- The `<query>` element is used to retrieve the value to be loaded to the column from a SQL query.

- The `sequence` attribute is used to retrieve the value to be loaded to the column from a sequence object in the database.
- The `constant` attribute is used to specify a constant value to the column.
- The `language` attribute is used to specify the language identifier to be loaded to the column.

15.2.1 Tree Structure of DLF

The possible structure of a DLF document is shown as a tree. Each element is represented as `<element_name>`, where `element_name` is the name of an element. Attributes have no markup. Each element and attribute is followed by notation indicating its possible occurrence.

[Table 15-1](#) (page 15-3) describes the occurrence notation.

Table 15-1 Notation for Occurrence of Attributes and Elements

Symbol	Meaning
1	one
+	one or more
?	zero or one
*	zero or more
(a b c)	exactly one of a, b, and c

[Example 15-1](#) (page 15-3) shows the tree structure of a DLF document. The elements are described in [Elements in DLF](#) (page 15-6). The attributes are described in [Attributes in DLF](#) (page 15-9).

Example 15-1 DLF Tree Structure

```

<table> (page 15-7)1
|
+---- lang (page 15-9)?
|
+---- space (page 15-10)?
|
+---- normalize-langtag (page 15-10)?
|
+---- <translation> (page 15-7)?
|   |
|   +---- <target> (page 15-7)+
|   |   |
|   |   +---- <language ID>
|   |   |
|   +---- <restyle> (page 15-7)+
|   |   |
|   |   +---- name (page 15-10)1
|   |   |
|   |   +---- expansion (page 15-12)?
|   |
+---- <lookup-key> (page 15-7)1
|   |
|   +---- <column> (page 15-7)*

```

```

|
|
+---- name (page 15-10)1
+---- <columns> (page 15-8)1
|
+---- <column> (page 15-8)+
|
+---- name (page 15-10)1
|
+---- type (page 15-11)1
|
+---- translate (page 15-11)?
|
+---- translation-note (page 15-13)?
|
+---- constant (page 15-11)?
|
+---- language (page 15-11)?
|
+---- sequence (page 15-11)?
|
+---- virtual (page 15-12)?
|
+---- useforupdate (page 15-12)?
|
+---- maxsize (page 15-12)?
|
+---- size-unit (page 15-12)?
|
+---- restype (page 15-12)?
|
+---- space (page 15-10)?
|
+---- (<query> (page 15-8)|<sql> (page 15-8))?
|
+---- text (page 15-12)1
|
+---- <parameter> (page 15-8)*
|
+---- id (page 15-13)1
|
+---- (col (page 15-13)|constant (page 15-11))1
|
+---- translate (page 15-11)?
|
+---- trans-key (page 15-13)?
|
+---- translation-note (page 15-13)?
+---- <dataset> (page 15-8)1
|
+---- <row> (page 15-8)+
|
+---- space (page 15-10)?
|
+---- <col> (page 15-9)*
|
+---- space (page 15-10)?

```

```

|
+---- name (page 15-10)1
|
+---- trans-key (page 15-13)?
|
+---- translation-note (page 15-13)?
|
+---- <the text element for the data>

```

15.3 DLF Specifications

Topics here include XML declarations, entity references, elements, and attributes in DLF.

Topics:

- [XML Declaration in DLF](#) (page 15-5)
- [Entity References in DLF](#) (page 15-5)
- [Elements in DLF](#) (page 15-6)
- [Attributes in DLF](#) (page 15-9)

15.3.1 XML Declaration in DLF

The Extensible Markup Language (XML) declaration starts an XML entity. It indicates the XML version.

It can also declare the encoding of the file, as in this example:

```
<?xml version="1.0" encoding="iso-8859-1" ?>
```

As in all XML files, the default encoding for a DLF file is assumed to be either 8-bit encoding of Unicode (UTF-8), which is a superset of the 7-bit ASCII character set, or 16-bit encoding of Unicode (UTF-16), which is conceptually 2-byte Universal Character Set (UCS-2) with surrogate pairs for code points above 65,535. Thus, for these character sets, the encoding declaration is not necessary. Furthermore, all XML parsers support these character sets. If the encoding is UTF-16, then the first character of the file must be the Unicode Byte-Order-Mark, #xFEFF, which indicates the endianness of the file.

Other character sets supported by Oracle XML parsers include all Oracle character sets and commonly used Internet Assigned Numbers Authority (IANA) character set and Java encodings. The names of these character sets can be found in the parser documentation. You must declare these with encoding declarations if the document does not have an external source of encoding information such as from the execution environment or the network protocol. Therefore, Oracle recommends that you use a Unicode character encoding so that you can dispense with the encoding declaration. The recommended practice is to encode the document in UTF-8 and use this declaration:

```
<?xml version="1.0" ?>
```

15.3.2 Entity References in DLF

XML predefines five entity references: `<`, `>`, `&`, `'`, and `"`. You must use entity references `<` and `&` in place of the characters they reference.

Table 15-2 Entity References

Entity Reference	Meaning
<code>&lt;</code>	Less than sign (<)
<code>&gt;</code>	Greater than sign (>)
<code>&amp;</code>	Ampersand (&)
<code>&apos;</code>	Apostrophe or single quotation mark (')
<code>&quot;</code>	Straight, double quotation mark (")

15.3.3 Elements in DLF

Categories of DLF elements are described.

The DLF elements shown in [Example 15-1](#) (page 15-3) are divided into the categories described in [Table 15-3](#) (page 15-6). Attributes are shared among them. The attributes are described in [Attributes in DLF](#) (page 15-9).

Table 15-3 DLF Elements

Type of Element	Tag
Top-Level Table Element (page 15-6)	<code><table></code>
Translation Elements (page 15-7)	<code><target></code> , <code><restype></code>
Lookup Key Elements (page 15-7)	<code><lookup-key></code> , <code><column></code>
Metadata Elements (page 15-8)	<code><columns></code> , <code><column></code> , <code><query></code> , <code><sql></code> , <code><parameter></code>
Data Elements (page 15-8)	<code><dataset></code> , <code><row></code> , <code><col></code>

15.3.3.1 Top-Level Table Element

The top-level table element is described.

Table 15-4 Top-Level Table Element

Tag	Description	Required Attributes	Optional Attributes	Contents
<table>	Corresponds to a single table. It encloses all the other elements of the document.	name	lang, space, normalize- langtag	The order of the elements within <table> is: <ol style="list-style-type: none"> 1. <translation> (optional) 2. <lookup-key> 3. <columns> 4. <dataset>

15.3.3.2 Translation Elements

The translation elements are described.

Table 15-5 Translation Elements

Tag	Description	Required Attributes	Optional Attributes	Contents
<translation>	Contains generic information pertinent to translation.	None	None	Zero or more <target> elements and zero or more <restype> elements
<target>	Specifies a language to which this document is translated.	None	None	A language identifier as defined by [IETF RFC1766]
<restype>	Declares a type of resource.	name	expansion	Empty element

15.3.3.3 Lookup Key Elements

The lookup key elements are described.

Table 15-6 Lookup Key Elements

Tag	Description	Required Attributes	Optional Attributes	Contents
<lookup-key>	Contains the <column> element(s) based on which the TransX recognizes the rows as identical or duplicate.	name	None	Zero or more <column> elements
<column>	A <column> element under <lookup-key> element indicates a column to be used to recognize the rows as identical or duplicate. Columns with the same values in specified column(s) are considered duplicate, regardless of the values in the other column(s). A lookup key <column> must have corresponding <columns> in the <dataset> section or be declared as a <column> with a constant expression or a <query> in the <columns> section.	name	None	Empty element

15.3.3.4 Metadata Elements

The metadata elements are described.

Table 15-7 Metadata Elements

Tag	Description	Required Attributes	Optional Attributes	Contents
<columns>	Contains data about the data to be loaded.	None	None	One or more <column> elements
<column>	Specifies a column that corresponds to <col> elements under the <dataset> element. After a <column> is defined the corresponding <col> element must appear in every <row> unless the column has the sequence, constant or query attribute.	name, , type in either order. The recommended sequence is name, type, then optional attributes.	translate, constant, sequence, virtual, useforupdate, maxsize, size-unit, restype in any order	Zero or one <query> or <sql> element
<query>	Specifies a SQL query whose result is used to fill in the column to which this element belongs.	text	None	Zero or more <parameter> elements
<sql>	Specifies a SQL statement whose result, if any, is used to fill in the column to which this element belongs.	text	None	Zero or more <parameter> elements
<parameter>	Specifies a parameter of a <query> element.	id and either col or constant. If col is specified, the referenced column cannot have the query, constant, or sequence attributes.	translate, trans-key	Empty

15.3.3.5 Data Elements

The data elements are <dataset>, <row>, and <col>.

[Table 15-8](#) (page 15-8) describes the data elements.

Table 15-8 Data Elements

Tag	Description	Required Attributes	Optional Attributes	Contents
<dataset>	Contains data to be loaded into the database.	None	None	One or more <row> elements
<row>	Contains data about the data to be loaded <dataset> element.	None	None	Zero or more <col> elements

Table 15-8 (Cont.) Data Elements

Tag	Description	Required Attributes	Optional Attributes	Contents
<col>	Specifies an instance of a piece of data to be loaded to a database column, or for a virtual column, a piece of data to be used to get an actual data to be loaded to a database column.	name	trans-key	Data for use by applications

15.3.4 Attributes in DLF

The various attributes used in the DLF elements are listed. An attribute is never specified more than once for each element. Along with some of the attributes are the recommended attribute values. Values for these attributes are case-sensitive.

Table 15-9 Attributes

Type of Attribute	Attributes
DLF Attributes (page 15-9)	name, type, translate, constant, sequence, virtual, useforupdate, maxsize, size-unit, restype, text, id, col, trans-key, translation-note, normalize-langtag
XML Namespace Attributes (page 15-13)	xml:space

15.3.4.1 DLF Attributes

The DLF attributes are described. These attributes are shared among the DLF elements.

Table 15-10 DLF Attributes

Attribute	Description	Value Description	Default Value	Used by Elements
lang	Specifies the language of the document.	This is equivalent to the xml:lang attribute. The values of the attribute are language identifiers as defined by [IETF RFC4646]. This attribute does not affect data loading operation in any way.	None; if absent, "en" is assumed	<table>

Table 15-10 (Cont.) DLF Attributes

Attribute	Description	Value Description	Default Value	Used by Elements
normalize-langtag	Specifies how to normalize the case of language tag.	"none", "standard", "uppercase" or "lowercase". The meanings are: none—no normalization. the values in the language column on DLF are used as they are standard—the style as recommended by the standards * lowercase for the 2 letter language code * uppercase for the 2 letter country code * titlecase for the 4 letter script code * lowercase for others uppercase—uppercase everything lowercase—lowercase everything	none	<table>
space	Specifies how white spaces (ASCII spaces, tabs and line-breaks) are treated.	"default" or "preserve" The value "default" signals that applications' default white-space processing modes are acceptable; the value "preserve" indicates the intent that applications preserve all white space. If this intent is declared at the root table element, it is considered to apply to all string data elements in the whole document. If declared at column level, it is considered to apply to the specified column of every row. If this attribute is declared in the <dataset> section, the intent applies only to the immediate text data. Declaration at the document or column level may be overridden with another instance of the space attribute.	"default"	<table> , <column> >, <col>
name	Specifies the name of an object such as table, column, restype, and so forth.	String: This is a database table name for the <table> element, and a column name for the <column> or <col> element.	Not applicable	<table> , <column> >, <col>

Table 15-10 (Cont.) DLF Attributes

Attribute	Description	Value Description	Default Value	Used by Elements
type	The data type of a column in the data set. This attribute specifies the kind of text contained in the <col> element in the data set. Depending on this type, TransX may apply different processes to the data. Because implicit data type conversion is provided by XSU and Java Database Connectivity (JDBC), TransX does not do its own parsing based on this type information. It uses this attribute to choose appropriate intermediate data types in Java for columns of date or dateTime type, in which case the standard date formats are accepted.	String: possible values are "number", "string", "date", "dateTime" or "binary". The lexical representation of a value of number type must be supplied in the SQL language syntax, no matter what the current locale is. The SQL syntax uses no digit grouping separator (usually comma), but uses a dot as the decimal separator (usually dot). For the binary data type, the data value specified in a text field between the col tags indicates the name of a file that contains the actual binary data. Raw data cannot be embedded in the text field. For the other data types (string, date, and dateTime) the representation is constrained by the corresponding types in the XML Schema specification. For simplicity, DLF accepts only standard date formats of XML Schema in the form "CCYY-MM-DDThh:mm:ss" (dateTime) or "CCYY-MM-DD" (date). No other date format is recognized. TransX uses this attribute for: <ul style="list-style-type: none"> • Bind virtual columns to parameters of a query • Bind the result of a query to a corresponding column 	Not applicable	<column >
translate	Indicates whether to translate the text of this column or parameter.	Either "yes" or "no"	"no"	<column >, <parameter >
constant	Specifies a constant value for this column or parameter.	The value of this column for every row	Not applicable	<column >, <parameter >
language	Specifies language identifier for this column	Language identifier or a placeholder. "%x" gets the value from the xml:lang attribute of the root table element.	Not applicable	<column >
sequence	Specifies a sequence in the database used to fill in the value for this column.	String: The name of a sequence in the database	Not applicable	<column >

Table 15-10 (Cont.) DLF Attributes

Attribute	Description	Value Description	Default Value	Used by Elements
virtual	Indicates that this column provides data used to construct another piece of data, which in turn is loaded into the database. A virtual column does not exist in the database. It is typically used to provide a value of a parameter in a query. A virtual column cannot be a lookup-key column. A virtual column with a query throws the result away.	Either "yes" or "no"	"no"	<column>
useforupdate	Indicates whether to use the value of this column for the update when uploading seed data. This attribute has no effect unless TransX is in the mode to update duplicate rows. A virtual column cannot have this attribute set to yes.	Either "yes" or "no". If this attribute is set to "no", then the value of the column remains unchanged on the update operation.	"yes"	<column>
maxsize	Specifies the maximum size for the data for this column.	Numeric value in the unit specified by the <code>size-unit</code> attribute. If this attribute is set and the <code>size-unit</code> is not set, the size is assumed to be in characters.	None	<column>
size-unit	Specifies the unit of size specified in the <code>maxsize</code> attribute.	Units. Recommended values are "char" for characters, "byte" for bytes. For supplemental characters, they take two "char" units.	"char"	<column>
restype	Indicates the type of data contained in this column.	A resource type. The value must match with the name of a <restype> element.	None	<column>
expansion	Indicates the maximum size up to which translated strings are allowed to become longer for this type of resource.	A numeric value in percentage of increase.	0%	<restype>
text	Specifies a SQL query statement to get a value to put in the column to which the query belongs.	A SQL statement. Zero or more parameters can be specified with an identifier preceded by a colon. The statement returns a single row of a single value. Any excessive result is discarded.	Not applicable	<query>

Table 15-10 (Cont.) DLF Attributes

Attribute	Description	Value Description	Default Value	Used by Elements
id	Specifies a placeholder used in a SQL query statement with parameters. The value of the column specified by the sibling <code>col</code> attribute is associated as a parameter to the query.	String: an identifier that appears in the text attribute of the parent query element.	Empty string	<parameter>
col	Specifies a column to be associated with a placeholder in the query specified by the sibling <code>id</code> attribute.	String: a column name. The column must be other than the column this attribute is a part of.	Not applicable	<parameter>
trans-key	Specifies a key for translation.	String: a translation key. The value must be unique in a translation domain.	Not applicable	<col>, <parameter>
translation-note	Specifies notes for translation.	String: Translation notes.	Not applicable	<col>, <column>, <parameter>

15.3.4.2 XML Namespace Attributes

The XML namespace attributes are described.

Table 15-11 XML Namespace Attributes

Attribute	Description	Value Description	Default Value	Used by Elements
<code>xml:space</code>	Specifies how white space (ASCII spaces, tabs and line-breaks) are treated.	"default" or "preserve" The value "default" signals that applications' default white space processing modes are acceptable for this element; the value "preserve" indicates the intent that applications preserve all the white space. This declared intent is considered to apply to all elements within the content of the element where it is specified, unless overridden with another instance of the <code>xml:space</code> attribute.	"default" "	None
<code>xml:lang</code>	Specifies the language of the content.	A language tag defined by RFC 4646.	Not applicable	table

15.4 DLF Examples

Topics here include minimal, typical, and localized DLF documents.

Topics:

- [Minimal DLF Document](#) (page 15-14)
- [Typical DLF Document](#) (page 15-14)
- [Localized DLF Document](#) (page 15-16)

15.4.1 Minimal DLF Document

A minimal DLF document is presented.

Example 15-2 Minimal DLF Document

```
<?xml version="1.0" ?>
<table name="dual">
  <lookup-key/>
  <columns>
    <column name="DUMMY" type="string">
  </columns>
  <dataset>
    <row>
      <col name="DUMMY">X</col>
    </row>
  </dataset>
</table>
```

15.4.2 Typical DLF Document

A sample DLF document that contains seed data for table CLK_STATUS_L is presented.

Example 15-3 Sample DLF Document

```
<!--
- $Header: $
-
- Copyright (c) 2001 Oracle Corporation. All Rights Reserved.
-
- NAME
-   status.xml - Seed file for the CLK_STATUS_L table
-
- DESCRIPTION
-   This file contains seed data for the Status level table.
-
- NOTES
-
- MODIFIED   (MM/DD/YY)
-   dchiba    06/11/01 - Adaption to enhancements of data loading tool
-   dchiba    05/23/01 - Adaption to generic data loading tool
-   rbolsius  05/07/01 - Created
-->

<table name="clk_status_l" xml:space="preserve">
  <lookup-key>
    <!--column name="status_id" /-->
    <column name="status_code" />
  </lookup-key>

  <columns>
    <column name="status_id"           type="number" sequence="clk_status_seq" useforupdate="no"/>
    <column name="status_code"        type="number" />
```

```

<column name="status_name"          type="string" translate="yes" />
<column name="status_description"   type="string" translate="yes" />
<column name="version_created"      type="number" constant="0" />
<column name="version_updated"      type="number" constant="0" />
<column name="status_type_code"     type="string" virtual="yes" />
<column name="status_type_id"       type="number" >
  <query text="select status_type_id from clk_status_type_l where status_type_code = :1" >
    <parameter id="1" col="status_type_code" />
  </query>
</column>
</columns>

<dataset>

<row>
  <col name="status_code" >100</col>
  <col name="status_name" trans-key="stts-name-1" >Continue</col>
  <col name="status_description" trans-key="stts-desc-1" >
    The client should continue with its request.</col>
  <col name="status_type_code" >INFO</col>
</row>

<row>
  <col name="status_code" >101</col>
  <col name="status_name" trans-key="stts-name-2" >Switching Protocols</col>
  <col name="status_description" trans-key="stts-desc-2" >
    The server understands and is willing to comply with the client's
    request (via the Upgrade message header field) for a change in the
    application protocol being used on this connection.</col>
  <col name="status_type_code" >INFO</col>
</row>

<row>
  <col name="status_code" >200</col>
  <col name="status_name" trans-key="stts-name-3" >OK</col>
  <col name="status_description" trans-key="stts-desc-3" >
    The request has succeeded.</col>
  <col name="status_type_code" >SUCCESS</col>
</row>

<row>
  <col name="status_code" >201</col>
  <col name="status_name" trans-key="stts-name-4" >Created</col>
  <col name="status_description" trans-key="stts-desc-4" >
    The request has been fulfilled and resulted in a new resource being
    created.</col>
  <col name="status_type_code" >SUCCESS</col>
</row>

<row>
  <col name="status_code" >202</col>
  <col name="status_name" trans-key="stts-name-5" >Accepted</col>
  <col name="status_description" trans-key="stts-desc-5" >
    The request has been accepted for processing, but the processing has
    not been completed.</col>
  <col name="status_type_code" >SUCCESS</col>
</row>

<row>
  <col name="status_code" >203</col>
  <col name="status_name" trans-key="stts-name-6" >Non-Authoritative Information</col>

```

```

    <col name="status_description" trans-key="stts-desc-6" >
      The returned metainformation in the entity-header is not the
      definitive set as available from the origin server, but is gathered
      from a local or a third-party copy.</col>
    <col name="status_type_code" >SUCCESS</col>
  </row>

  <row>
    <col name="status_code" >204</col>
    <col name="status_name" trans-key="stts-name-7" >No Content</col>
    <col name="status_description" trans-key="stts-desc-7" >
      The server has fulfilled the request but does not need to return an
      entity-body, and might want to return updated metainformation.</col>
    <col name="status_type_code" >SUCCESS</col>
  </row>

  <!-- ... -->

</dataset>
</table>

```

15.4.3 Localized DLF Document

An example of elements and attributes for localization is shown.

Example 15-4 DLF with Localization

```

<?xml version="1.0"?>
<table name="table_name" xml:lang="en" xml:space="preserve">

  <translation>
    <target>ar</target>
    <target>bs</target>
    <target>es</target>
    <restype name="alt" expansion="50%" />
    <restype name="foo" expansion="50%" />
    <restype name="bar" expansion="30%" />
  </translation>

  <lookup-key><column name="resid" /></lookup-key>

  <columns>
    <column name="resid" type="number" sequence="seq_foo" useforupdate="no" />
    <column name="image" type="binary" />
    <column name="alt_text" type="string" translate="yes" maxsize="30"
      size-unit="byte" restype="alt" />
  </columns>

  <dataset>
    <col name="image">fool.gif</col>
    <col name="alt_text">Hello world</col>
  </dataset>

</table>

```

Using the XSQL Pages Publishing Framework

An explanation is given of how to use the basic features of the XSQL pages publishing framework.

Topics:

- [Introduction to the XSQL Pages Publishing Framework](#) (page 16-1)
- [Using the XSQL Pages Publishing Framework: Overview](#) (page 16-2)
- [Generating and Transforming XML with XSQL Servlet](#) (page 16-13)
- [Using XSQL in Java Programs](#) (page 16-24)
- [XSQL Pages Tips and Techniques](#) (page 16-25)

See Also:

[Using the XSQL Pages Publishing Framework: Advanced Topics](#) (page 17-1)

16.1 Introduction to the XSQL Pages Publishing Framework

The Oracle XSQL pages publishing framework is an extensible platform for publishing Extensible Markup Language (XML) in multiple formats.

The Java-based [XSQL servlet](#), which is the center of the framework, provides a declarative interface for dynamically publishing dynamic web content based on relational data.

The XSQL framework combines the power of structured query language (SQL), XML, and Extensible Stylesheet Language Transformation (XSLT). You can use it to create declarative templates called [XSQL pages](#) to perform these actions:

- Assemble dynamic XML datagrams based on parameterized SQL queries
- Transform datagrams with XSLT to generate a result in an XML, HTML, or text-based format

An XSQL page, so called because its default extension is `.xsql`, is an XML file that contains instructions for the XSQL servlet. The [Example 16-1](#) (page 16-2) shows a simple XSQL page. It uses the `<xsql:query>` (page 32-23) action element to query the `hr.employees` table.

You can present a browser client with the data returned from the query in [Example 16-1](#) (page 16-2). Assembling and transforming information for publishing requires no programming. You can perform most tasks in a declarative way. If a built-

in feature does not fit your needs, however, you can use Java to integrate custom data sources or perform customized server-side processing.

In the XSQL pages framework, the *assembly* of information to be published is separate from presentation. This architectural feature enables you to do this:

- Present the same data in multiple ways, including tailoring the presentation appropriately to the type of client device making the request —browser, cellular phone, personal digital assistant (PDA), and so on.
- Reuse data by aggregating existing pages into new ones
- Revise and enhance the presentation independently of the content

Example 16-1 Sample XSQL Page

```
<?xml version="1.0">
<?xml-stylesheet type="text/xsl" href="emplist.xsl"?>
<xsql:query connection="hr" xmlns:xsql="urn:oracle-xsql">
  SELECT * FROM employees
</xsql:query>
```

16.1.1 Prerequisites for Using the XSQL Pages Publishing Framework

Prerequisites for using the XSQL pages publishing framework are described.

This chapter assumes that you are familiar with these technologies:

- [Oracle Database SQL](#). The XSQL framework accesses data in a database.
- [Procedural Language/Structured Query Language \(PL/SQL\)](#). Oracle XML Developer's Kit (XDK) supplies a PL/SQL application programming interface (API) for XML SQL Utility (XSU) that mirrors the Java API.
- [Java Database Connectivity \(JDBC\)](#). The XSQL pages framework depends on a JDBC driver for database connections.
- [Extensible Stylesheet Language Transformations \(XSLT\)](#). You can use XSLT to transform the data into a format appropriate for delivery to the user.
- [XML SQL Utility \(XSU\)](#). The XSQL pages framework uses XSU to query the database.

16.2 Using the XSQL Pages Publishing Framework: Overview

Topics here include basic use, setting up, running the demo programs, and using the command-line utility.

Topics:

- [Using the XSQL Pages Framework: Basic Process](#) (page 16-3)
- [Setting Up the XSQL Pages Framework](#) (page 16-5)
- [Running the XSQL Pages Demo Programs](#) (page 16-8)
- [Using the XSQL Pages Command-Line Utility](#) (page 16-12)

16.2.1 Using the XSQL Pages Framework: Basic Process

The XSQL page processor engine interprets, caches, and processes the contents of XSQL pages. Basic use of the XSQL pages framework is described.

Figure 16-1 (page 16-3) shows the basic architecture of the XSQL pages publishing framework. The XSQL page processor provides access from this entry points:

- From the command line or in batch mode with the XSQL command-line utility. The `oracle.xml.xsql.XSQLCommandLine` class is the command-line interface.
- Over the web by using the XSQL servlet installed in a web server. The `oracle.xml.xsql.XSQLServlet` class is the servlet interface.
- As part of JSP applications by using `<jsp:include>` to include a template or `<jsp:forward>` to forward a template.
- Programmatically by using the `oracle.xml.xsql.XSQLRequest` Java class.

Figure 16-1 XSQL Pages Framework Architecture

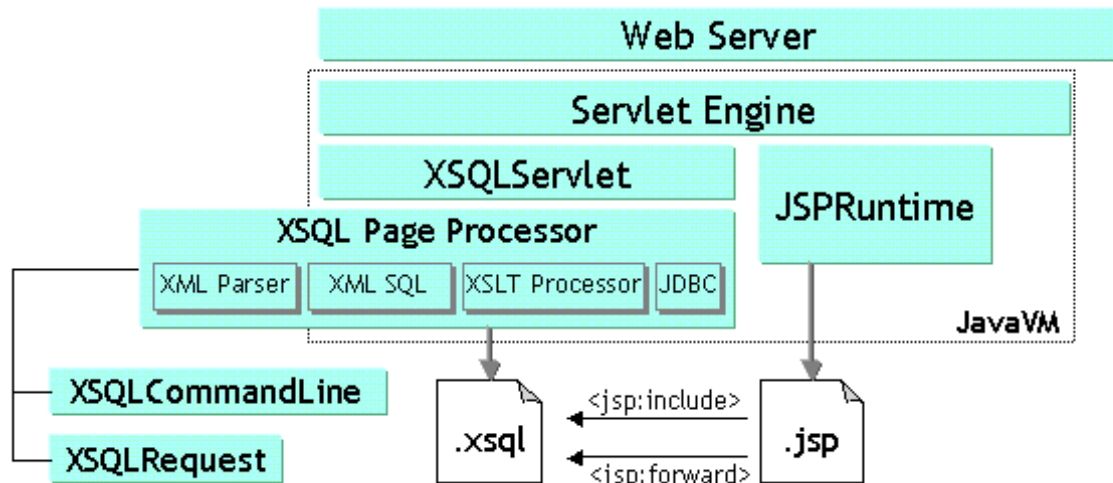

You can run the same XSQL pages from any of the access points shown in Figure 16-1 (page 16-3). Regardless of which way you use the XSQL page processor, it performs these actions to generate a result:

1. Receives a request to process an XSQL page. The request can come from the command-line utility or programmatically from an `XSQLRequest` object.
2. Assembles an XML datagram by using the result of one or more SQL queries. The query is specified in the `<xsql:query>` (page 32-23) element of the XSQL page.
3. Returns this XML datagram to the requester.
4. Optionally transforms the datagram into any XML, HTML, or text-based format.

Figure 16-2 (page 16-4) shows a typical web-based scenario in which a web server receives an HTTP request for `Page.xsql`, which contains a reference to the XSLT stylesheet `Style.xsl`. The XSQL page contains a database query.

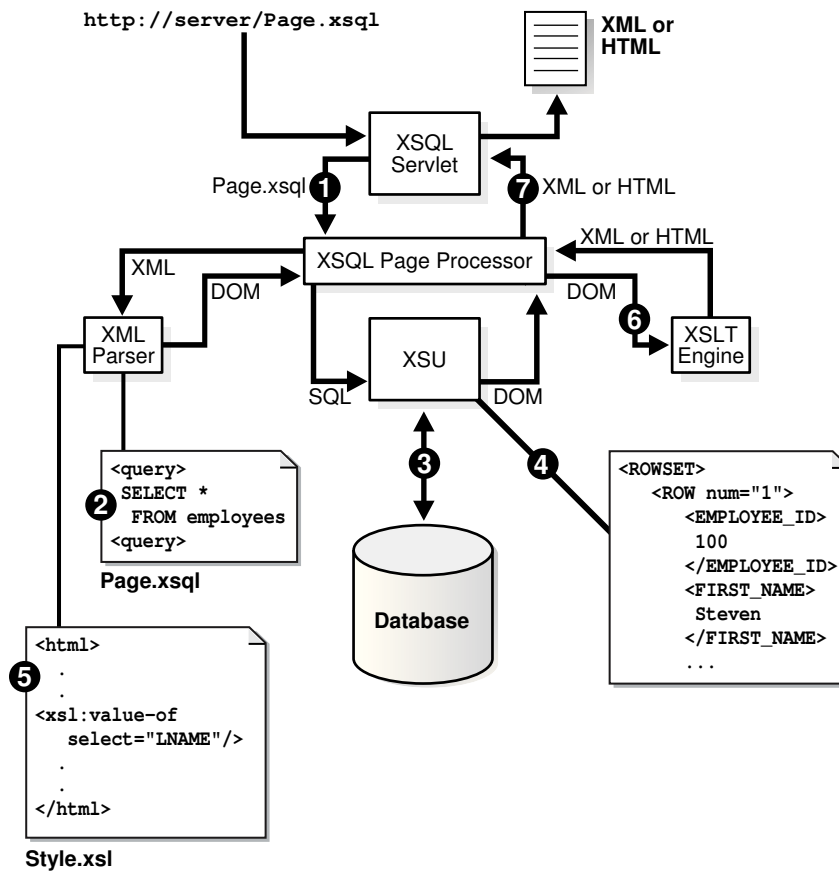
Figure 16-2 Web Access to XSQL Pages

The XSQL page processor shown in [Figure 16-2](#) (page 16-4) performs these steps:

1. Receives a request from the XSQL Servlet to process `Page.xsql`.
2. Parses `Page.xsql` with the Oracle XML Parser and caches it.
3. Connects to the database based on the value of the connection attribute on the document element.
4. Generates the XML datagram by replacing each XSQL action element, for example, `<xsql:query>` (page 32-23), with the XML results returned by its built-in action handler.
5. Parses the `Style.xsl` stylesheet and caches it.
6. Transforms the datagram by passing it and the `Style.xsl` stylesheet to the Oracle XSLT processor.
7. Returns the resulting XML or HTML document to the requester.

During the transformation step in this process, you can use stylesheets that conform with the W3C XSLT 1.0 or 2.0 standard to transform the assembled datagram into document formats such as:

- HTML for browser display
- Wireless Markup Language (WML) for wireless devices
- Scalable Vector Graphics (SVG) for data-driven charts, graphs, and diagrams

- XML Stylesheet Formatting Objects (XSL-FO), for rendering into Adobe PDF
- Text documents such as e-mails, SQL scripts, Java programs, and so on
- Arbitrary XML-based document formats

16.2.2 Setting Up the XSQL Pages Framework

You can develop and use XSQL pages in various scenarios.

- [Creating and Testing XSQL Pages with Oracle JDeveloper](#) (page 16-5)
- [Setting the CLASSPATH for XSQL Pages](#) (page 16-6)
- [Configuring the XSQL Servlet Container](#) (page 16-7)
- [Setting Up the Connection Definitions](#) (page 16-7)

16.2.2.1 Creating and Testing XSQL Pages with Oracle JDeveloper

The following Oracle JDeveloper tasks are covered here: creating an XSQL page, adding XSQL action elements to an XSQL page, checking the syntax of an XSQL page, testing an XSQL page, and adding an XSQL runtime library to your project library list so that environment variable CLASSPATH is properly set.

The IDE supports these features:

- Color-coded syntax highlighting
- XML syntax checking
- In-context drop-down lists that help you pick valid XSQL tag names and auto-complete tag and attribute names
- XSQL page deployment and testing
- Debugging tools
- Wizards for creating XSQL actions

To create an XSQL page in an Oracle JDeveloper project:

1. Create or open a project.
2. Select **File** and then **New**.
3. In the **New Gallery** dialog box, select the **General** category and then **XML**.
4. In the **Item** window, select **XSQL Page** and click **OK**. Oracle JDeveloper loads a tab for the new XSQL page into the central window.

To add XSQL action elements such as `<xsql:query>` (page 32-23) to your XSQL page, place the cursor where you want the new element to go and click an item in the Component Palette. A wizard opens that takes you through the steps of selecting which XSQL action you want to use and which attributes you must provide.

To check the syntax of an XSQL page, place the cursor in the page and right-click **Check XML Syntax**. If there are any XML syntax errors, Oracle JDeveloper displays them.

To test an XSQL page, select the page in the navigator and right-click **Run**. Oracle JDeveloper automatically starts a local web server, properly configured to run XSQL

pages, and tests your page by starting your default browser with the appropriate URL to request the page. After you have run the XSQL page, you can continue to make modifications to it in the IDE. And, you can modify any XSLT stylesheets with which it might be associated. After saving the files in the IDE, you can immediately refresh the browser to observe the effect of the changes.

You must add the XSQL runtime library to your project library list so that the CLASSPATH is properly set. The IDE adds this entry automatically when you go through the New Gallery dialog to create a new XSQL page, but you can also add it manually to the project as follows:

1. Right-click the project in the Applications Navigator.
2. Select **Project Properties**.
3. Select **Profiles** and then **Libraries** from the navigation tree.
4. Move **XSQL Runtime** from the **Available Libraries** pane to **Selected Libraries**.

16.2.2.2 Setting the CLASSPATH for XSQL Pages

Outside of the Oracle JDeveloper environment, you must ensure that the XSQL page processor engine is properly configured.

Ensure that the appropriate Java Archive (JAR) files are in the CLASSPATH of the Java Virtual Machine (JVM) that processes the XSQL Pages. The complete set of XDK JAR files is described in [Table 3-1](#) (page 3-3). The JAR files for the XSQL framework include:

- `xml.jar`, the XSQL page processor
- `xmlparserv2.jar`, the Oracle XML parser
- `xsu12.jar`, the Oracle XML SQL utility (XSU)
- `ojdbc6.jar`, the Oracle JDBC driver

Note:

The XSQL servlet can connect to any database that has Java Database Connectivity (JDBC) support. Indicate the appropriate JDBC driver class and connection URL in the XSQL configuration file connection definition. Object-relational functionality works only when using Oracle Database with the Oracle JDBC driver.

If you have configured your CLASSPATH as instructed in [Setting Up the XDK for Java Environment](#) (page 3-5), you need to add the *directory* only where the XSQL pages configuration file resides. In the database installation of XDK, the directory for `XSQLConfig.xml` is `$ORACLE_HOME/xdk/admin`.

On Windows your `%CLASSPATH%` variable contains these entries:

```
%ORACLE_HOME%\lib\ojdbc6.jar;%ORACLE_HOME%\lib\xmlparserv2.jar;  
%ORACLE_HOME%\lib\xsu12.jar;C:\xsql\lib\xml.jar;%ORACLE_HOME%\xdk\admin
```

On UNIX the `$CLASSPATH` variable contains these entries:

```
$ORACLE_HOME/lib/ojdbc6.jar:$ORACLE_HOME/lib/xmlparserv2.jar:  
$ORACLE_HOME/lib/xsu12.jar:$ORACLE_HOME/lib/xml.jar:$ORACLE_HOME\xdk\admin
```

Note:

If you are deploying your XSQL pages in a Java Platform, Enterprise Edition (Java EE) web application archive (WAR) file, then you can include the XSQL JAR files in the `./WEB-INF/lib` directory of the WAR file.

16.2.2.3 Configuring the XSQL Servlet Container

You can install the XSQL servlet in a variety of different web servers. See the file `$ORACLE_HOME/xdk/readme.html` for servlet installation instructions.

16.2.2.4 Setting Up the Connection Definitions

XSQL pages specify database connections by using a short name for a connection that is defined in the XSQL configuration file, which by default is named `$ORACLE_HOME/xdk/admin/XSQLConfig.xml`.

Note:

If you are deploying your XSQL pages in a Java EE WAR file, then you can place the `XSQLConfig.xml` file in the `./WEB-INF/classes` directory of your WAR file.

The sample XSQL page shown in [Example 16-1](#) (page 16-2) contains this connection information:

```
<xsql:query connection="hr" xmlns:xsql="urn:oracle-xsql">
```

Connection names are defined in the `<connectiondefs>` section of the XSQL configuration file. [Example 16-2](#) (page 16-8) shows the relevant section of the sample configuration file included with the database, with the `hr` connection in bold.

For each database connection, you can specify these elements:

- `<username>`, the database user name
- `<password>`, the database password
- `<dburl>`, the JDBC connection string
- `<driver>`, the fully qualified class name of the JDBC driver to use
- `<autocommit>`, which optionally forces AUTOCOMMIT to TRUE or FALSE

Specify an `<autocommit>` child element to control the setting of the JDBC autocommit for any connection. If no `<autocommit>` child element is set for a `<connection>`, then the autocommit setting is not set by the XSQL connection manager. In this case, the setting is the default autocommit setting for the JDBC driver.

You can place an arbitrary number of `<connection>` elements in the XSQL configuration file to define your database connections. An individual XSQL page refers to the connection it wants to use by putting a `connection="xxx"` attribute on the top-level element in the page (also called the "document element").

Note:

The `XSQLConfig.xml` file contains sensitive database user name and password information that must be kept secure on the database server. See [Security Considerations for XSQL Pages](#) (page 16-31) for instructions.

Example 16-2 Connection Definitions Section of XSQLConfig.xml

```
<connectiondefs>
...
<connection name="hr">
  <username>hr</username>
  <password>hr_password</password>
  <dburl>jdbc:oracle:thin:@localhost:1521:ORCL</dburl>
  <driver>oracle.jdbc.driver.OracleDriver</driver>
  <autocommit>false</autocommit>
</connection>
...
</connectiondefs>
```

16.2.3 Running the XSQL Pages Demo Programs

Demo programs for the XSQL servlet are included in `$ORACLE_HOME/xdk/demo/java/xsql`.

[Table 16-1](#) (page 16-8) lists the demo subdirectories and explains the included demos. The Demo Name column refers to the title of the demo listed on the XSQL Pages & XSQL Servlet home page. [Running the XSQL Demos](#) (page 16-11) explains how to access the home page.

Table 16-1 XSQL Servlet Demos

Directory	Demo Name	Description
home/	XSQL Pages & XSQL Servlet	Contains the pages that display the tabbed home page of the XSQL demos and the online XSQL help that you can access from that page. As explained in Running the XSQL Demos (page 16-11), you can invoke the XSQL home page from the <code>index.html</code> page.
helloworld/	Hello World Page	Shows the simplest possible XSQL page.
emp/	Employee Page	XSQL page showing XML data from the <code>hr.employees</code> table, using XSQL page parameters to control what employees are returned and which columns to use for the database sort. Uses an associated XSLT stylesheet to format the results as an HTML Form containing the <code>emp.xsql</code> page as the form action so the user can refine the search criteria.
insclaim/	Insurance Claim Page	Demonstrates several sample queries over the richly structured Insurance Claim object view. The <code>insclaim.sql</code> scripts sets up the <code>INSURANCE_CLAIM_VIEW</code> object view and populates it with sample data.

Table 16-1 (Cont.) XSQL Servlet Demos

Directory	Demo Name	Description
classerr/	Invalid Classes Page	Uses <code>invalidclasses.xml</code> to format a "live" list of current Java class compilation errors in your schema. The accompanying SQL script sets up the <code>XSQLJavaClassesView</code> object view used by the demo. The master/detail information from the object view is formatted into HTML by the <code>invalidclasses.xml</code> stylesheet in the server.
doyouxml/	Do You XML? Site	Shows how a simple, data-driven web site can be built with an XSQL page that uses SQL, XSQL substitution variables in the queries, and XSLT for formatting the site. Demonstrates using substitution parameters in both the body of SQL query statements within <code><xsql:query></code> (page 32-23) tags, and also within the attributes to <code><xsql:query></code> tags to control behavior such as how many records to display and to skip (for "paging" through query results in a stateless way).
empdept/	Emp/Dept Object Demo	Demonstrates how to use an object view to group master/detail information from two existing flat tables such as <code>scott.emp</code> and <code>scott.dept</code> . The <code>empdeptobjs.sql</code> script creates the object view and also the <code>INSTEAD OF INSERT</code> triggers that enable the master/detail view to be used as an insert target of <code>xsql:insert-request</code> . The <code>empdept.xml</code> stylesheet shows a form of an XSLT stylesheet that looks just like an HTML page without the extra <code>xsl:stylesheet</code> or <code>xsl:transform</code> at the top. Using a Literal Result Element as a stylesheet is part of the XSLT 1.0 specification. The stylesheet also shows how to generate an HTML page that includes <code><link rel="stylesheet"></code> to enable the generated HTML to fully leverage cascading stylesheets (CSS) for centralized HTML style information, found in the <code>coolcolors.css</code> file.
airport/	Airport Code Validation	Returns a datagram of information about airports based on their three-letter codes and uses <code><xsql:no-rows-query></code> as alternative queries when initial queries return no rows. After attempting to match the airport code passed in, the XSQL page tries a fuzzy match based on the airport description. The <code>airport.htm</code> page shows how to use the XML results of the <code>airport.xsql</code> page from a web page with JavaScript to exploit built-in Document Object Model (DOM) functionality in Internet Explorer. When you enter the three-letter airport code on the web page, a JavaScript fetches an XML datagram from XSQL servlet. The datagram corresponds to the code that you entered. If the return indicates no match, then the program collects a "picklist" of possible matches based on information returned in the XML datagram from XSQL servlet
airport/	Airport Code Display	Demonstrates use of the same XSQL page as the Airport Code Validation example but supplies an XSLT stylesheet name in the request. This behavior causes the airport information to be formatted as an HTML form instead of being returned as raw XML.
airport/	Airport Soap Service	Demonstrates returning airport information as a Simple Object Access Protocol (SOAP) Service.
adhocsql/	Adhoc Query Visualization	Demonstrates how to pass a SQL query and an XSLT stylesheet as parameters to the server.

Table 16-1 (Cont.) XSQL Servlet Demos

Directory	Demo Name	Description
document/	XML Document Demo	<p>Demonstrates inserting XML documents into relational tables. The <code>docdemo.sql</code> script creates a user-defined type called XMLDOCFRAG containing an attribute of type character large object (CLOB).</p> <p>Try inserting the text of the document in <code>./xsql/demo/xml99.xml</code> and providing the name <code>xml99.xsl</code> as the stylesheet, and <code>./xsql/demo/JDevRelNotes.xml</code> with the stylesheet <code>relnotes.xsl</code>.</p> <p>The <code>docstyle.xsql</code> page shows an example of the <code><xsql:include-xsql></code> (page 32-18) action element to include the output of the <code>doc.xsql</code> page into its own page before transforming the final output using a client-supplied stylesheet name.</p> <p>The demo uses the client-side XML features of Internet Explorer 5.0 to check the document for well-formedness before allowing it to be posted to the server.</p>
insertxml/ /	XML Insert Request Demo	<p>Demonstrates posting XML from a client to an XSQL page that handles inserting the posted XML data into a database table using the <code><xsql:insert-request></code> (page 32-21) action element. The demo accepts XML documents in the <code>moreover.com</code> XML-based news format.</p> <p>In this case, the program doing the posting of the XML is a client-side web page using Internet Explorer 5.0 and the <code>XMLHttpRequest</code> object from JavaScript. If you look at the source for the <code>insertnewsstory.xsql</code> page, you'll see it's specifying a table name and an XSLT Transform name. The <code>moreover-to-newsstory.xsl</code> stylesheet transforms the incoming XML information into the canonical format that the <code>OracleXMLSave</code> utility knows how to insert.</p> <p>Try copying and pasting the example <code><article></code> element several times within the <code><moreovernews></code> element to insert several new articles in one shot.</p> <p>The <code>newsstory.sql</code> script shows how INSTEAD OF triggers can be used on the database views into which you ask XSQL Pages to insert to the data to customize how incoming data is handled, default primary key values, and so on.</p>
svg/	Scalable Vector Graphics Demo	<p>The <code>deptlist.xsql</code> page displays a simple list of departments with hyperlinks to the <code>SalChart.xsql</code> page. The <code>SalChart.xsql</code> page queries employees for a given department passed in as a parameter and uses the associated <code>SalChart.xsql</code> stylesheet to format the result into a Scalable Vector Graphics drawing, a bar chart comparing salaries of the employees in that department.</p>
fop/	PDF Demo	<p>The <code>emptable.xsql</code> page displays a simple list of employees. The <code>emptable.xsl</code> stylesheet transforms the datapage into the XSL-FO Formatting Objects which, combined with the built-in FOP serializer, render the results in Adobe PDF format.</p>
cursor/	Cursor Demo	<p>Contains an example of using a nested <code>CURSOR</code> expression, which is one of three ways to use the default <code><xsql:query></code> (page 32-23) element to produce nested elements.</p>
actions/		<p>Contains the source code for two example custom actions.</p>

16.2.3.1 Setting Up the XSQL Demos

How to set up the XSQL demos is described.

1. Change into the `$ORACLE_HOME/xdk/demo/java/xsql` directory (UNIX) or `%ORACLE_HOME%\xdk\demo\java\xsql` directory (Windows).
2. Start SQL*Plus and connect to your database as `ctxsys`—the schema owner for the Oracle Text packages—and issue this statement:

```
GRANT EXECUTE ON ctx_ddl TO scott;
```

3. Connect to your database as a user with DBA privileges and issue this statement:

```
GRANT QUERY REWRITE TO scott;
```

The preceding query enables `scott` to create a function-based index that one of the demos requires to perform case-insensitive queries on descriptions of airports.

4. Connect to your database as `scott`. You are prompted for the password.
5. Run the SQL script `install.sql` in the current directory. This script runs all SQL scripts for all the demos:

```
@install.sql
```

6. Change to the `./doyouxml` subdirectory, and run this command to import sample data for the "Do You XML?" demo (you are prompted for the password):

```
imp scott file=doyouxml.dmp
```

7. To run the Scalable Vector Graphics (SVG) demonstration, install an SVG plug-in such as Adobe SVG plug-in into your browser.

16.2.3.2 Running the XSQL Demos

The XSQL demos are designed to be accessed through a web browser.

If you have set up the XSQL servlet in a web server as described in [Configuring the XSQL Servlet Container](#) (page 16-7), then you can access the demos through this URL, substituting appropriate values for `yourserver` and `port`:

```
http://yourserver:port/xsql/index.html
```

[Figure 16-3](#) (page 16-12) shows a section of the XSQL home page in Internet Explorer. (You must use browser version 5 or later.)

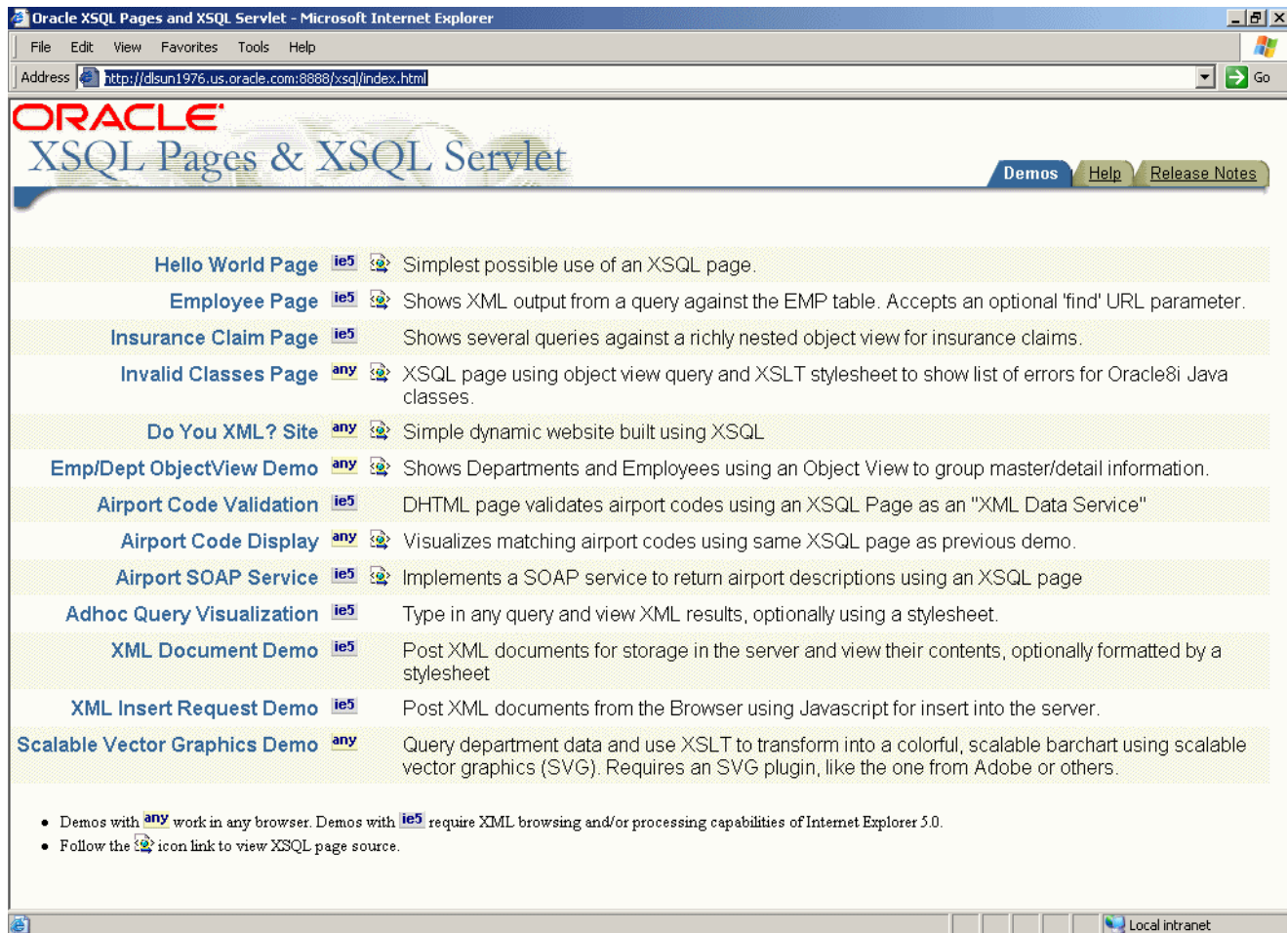
Figure 16-3 XSQL Home Page

The demos are designed to be self-explanatory. Click the demo titles—**Hello World Page**, **Employee Page**, and so forth—and follow the online instructions.

16.2.4 Using the XSQL Pages Command-Line Utility

XDK includes a command-line Java interface that runs the XSQL page processor. You can process any XSQL page with the XSQL command-line utility.

Often the content of a dynamic page is based on data that does not frequently change. To optimize performance of your web publishing, you can use operating system facilities to schedule offline processing of your XSQL pages. This technique enables the processed results to be served statically by your web server.

The `$ORACLE_HOME/xdk/bin/xsql` and `%ORACLE_HOME%\xdk\bin\xsql.bat` shell scripts run the `oracle.xml.xsql.XSQLCommandLine` class. Before invoking the class ensure that your environment is configured as described in [Setting Up the XSQL Pages Framework](#) (page 16-5). Depending on how you invoke the utility, the syntax is either of these:

```
java oracle.xml.xsql.XSQLCommandLine xsqlpage [outfile] [param1=value1 ...]
xsql xsqlpage [outfile] [param1=value1 ...]
```

If you specify an *outfile*, then the result of processing *xsqlpage* is written to it; otherwise the result goes to standard out. You can pass any number of parameters to the XSQL page processor, which are available for reference by the XSQL page

processed as part of the request. However, these parameter names are recognized by the command-line utility and have a predefined behavior:

- `xml-stylesheet=stylesheetURL`
Provides the relative or absolute URL for a stylesheet to use for the request. You can also set it to the string `none` to suppress XSLT stylesheet processing for debugging.
- `posted-xml=XMLDocumentURL`
Provides the relative or absolute URL of an XML resource to treat as if it were posted as part of the request.
- `useragent=UserAgentString`
Simulates a particular HTTP User-Agent string from the command line so that an appropriate stylesheet for that User-Agent type is selected as part of command-line processing of the page.

16.3 Generating and Transforming XML with XSQL Servlet

The basic tasks that you can perform with your server-side XSQL page templates are described.

- [Composing XSQL Pages](#) (page 16-13)
- [Producing Datagrams from SQL Queries](#) (page 16-19)
- [Transforming XML Datagrams into an Alternative XML Format](#) (page 16-20)
- [Transforming XML Datagrams into HTML for Display](#) (page 16-23)

16.3.1 Composing XSQL Pages

You can serve database information in XML format over the web with XSQL pages.

For example, suppose your aim is to serve a real-time XML datagram from Oracle of all available flights landing today at JFK airport. [Example 16-3](#) (page 16-14) shows a sample XSQL page in a file named `AvailableFlightsToday.xsql`.

The XSQL page is an XML file that contains any mix of static XML content and XSQL action elements. The file can have any extension, but `.xsql` is the default extension for XSQL pages. You can modify your servlet engine configuration settings to associate other extensions by using the same technique described in [Configuring the XSQL Servlet Container](#) (page 16-7). The servlet extension mapping is configured inside the `./WEB-INF/web.xml` file in a Java EE WAR file.

The XSQL page in [Example 16-3](#) (page 16-14) begins with this declaration:

```
<?xml version="1.0"?>
```

The first, outermost element in an XSQL page is the **document element**. `AvailableFlightsToday.xsql` contains a single XSQL action element `<xsql:query>` (page 32-23), but no static XML elements. In this case the `<xsql:query>` element is the document element. [Example 16-3](#) (page 16-14) represents the simplest useful XSQL page: one that contains a single query. The results of the query replace the `<xsql:query>` section in the XSQL page.

Note:

[XSQL Pages Reference](#) (page 32-1) describes the complete set of built-in action elements.

The `<xsql:query>` action element includes an `xmlns` attribute that declares the `xsql` namespace prefix as a synonym for the `urn:oracle-xsql` value, which is the Oracle XSQL namespace identifier:

```
<xsql:query connection="demo" bind-params="City" xmlns:xsql="urn:oracle-xsql">
```

The element also contains a `connection` attribute whose value is the name of a predefined connection in the XSQL configuration file:

```
<xsql:query connection="demo" bind-params="City" xmlns:xsql="urn:oracle-xsql">
```

The details concerning the user name, password, database, and JDBC driver to be used for the `demo` connection are centralized in the configuration file.

To include more than one query on the page, you can invent an XML element to wrap the other elements. [Example 16-4](#) (page 16-14) shows this technique.

In [Example 16-4](#) (page 16-14), the `connection` attribute and the `xsql` namespace declaration always go on the document element, whereas the `bind-params` is specific to the `<xsql:query>` action.

Example 16-3 Sample XSQL Page in AvailableFlightsToday.xsql

```
<?xml version="1.0"?>
<xsql:query connection="demo" bind-params="City" xmlns:xsql="urn:oracle-xsql">
  SELECT  Carrier, FlightNumber, Origin, TO_CHAR(ExpectedTime,'HH24:MI') AS Due
  FROM    FlightSchedule
  WHERE   TRUNC(ExpectedTime) = TRUNC(SYSDATE)
  AND     Arrived = 'N'
  AND     Destination = ? /* The "?" represents a bind variable bound */
  ORDER BY ExpectedTime /* to the value of the City parameter. */
</xsql:query>
```

Example 16-4 Wrapping the <xsql:query> Element

```
<?xml version="1.0"?>
<page connection="demo" xmlns:xsql="urn:oracle-xsql">
  <xsql:query bind-params="City">
    SELECT  Carrier, FlightNumber, Origin, TO_CHAR(ExpectedTime,'HH24:MI') AS Due
    FROM    FlightSchedule
    WHERE   TRUNC(ExpectedTime) = TRUNC(SYSDATE)
    AND     Arrived = 'N'
    AND     Destination = ? /* The ? is a bind variable bound */
    ORDER BY ExpectedTime /* to the value of the City parameter. */
  </xsql:query>
  <!-- Other xsql:query actions can go here inside <page> and </page> -->
</page>
```

16.3.1.1 Using Bind Parameters

The use of bind parameters is described.

The `<xsql:query>` element shown in [Example 16-3](#) (page 16-14) contains a `bind-params` attribute that associates the values of parameters in the request to bind variables in the SQL statement included in the `<xsql:query>` tag. The bind parameters in the SQL statement are represented by question marks.

You can use SQL bind variables to parameterize the results of any of the actions in [Table 32-1](#) (page 32-1) that allow SQL statements. Bind variables enable your XSQL page template to produce results based on the values of parameters passed in the request.

To use a bind variable, include a question mark anywhere in a statement where bind variables are allowed by SQL. Whenever a SQL statement is executed in the page, the XSQL engine binds the parameter values to the variable by specifying the `bind-params` attribute on the action element.

[Example 16-5](#) (page 16-15) shows an XSQL page that binds the bind variables to the value of the `custid` parameter in the page request.

The XML data for a customer with ID of 101 can then be requested by passing the customer id parameter in the request:

```
http://yourserver.com/fin/CustomerPortfolio.xsql?custid=1001
```

The value of the `bind-params` attribute is a space-delimited list of parameter names. The left-to-right order indicates the positional bind variable to which its value is bound in the statement. Thus, if your SQL statement contains five question marks, then the `bind-params` attribute needs a space-delimited list of five parameter names. If the same parameter value must be bound to several different occurrences of a bind variable, then repeat the name of the parameters in the value of the `bind-params` attribute at the appropriate position. Failure to include the same number of parameter names in the `bind-params` attribute as in the query causes an error when the page is executed.

You can use variables in any action that expects a SQL statement or PL/SQL block. The page shown in [Example 16-6](#) (page 16-15) shows this technique. The XSQL page contains three action elements:

- `<xsql:dml>` (page 32-10) binds `useridCookie` to an argument in the `log_user_hit` procedure.
- `<xsql:query>` (page 32-23) binds parameter `custid` to a variable in a `WHERE` clause.
- `<xsql:include-owa>` (page 32-13) binds parameters `custid` and `userCookie` to two arguments in the `historical_data` procedure.

Example 16-5 Bind Variables in CustomerPortfolio.xsql

```
<portfolio connection="prod" xmlns:xsql="urn:oracle-xsql">
  <xsql:query bind-params="custid">
    SELECT s.ticker as "Symbol", s.last_traded_price as "Price"
    FROM latest_stocks s, customer_portfolio p
    WHERE p.customer_id = ?
    AND s.ticker = p.ticker
  </xsql:query>
</portfolio>
```

Example 16-6 Bind Variables with Action Elements in CustomerPortfolio.xsql

```
<portfolio connection="prod" xmlns:xsql="urn:oracle-xsql">
  <xsql:dml commit="yes" bind-params="useridCookie">
    BEGIN log_user_hit(?); END;
  </xsql:dml>
  <current-prices>
    <xsql:query bind-params="custid">
      SELECT s.ticker as "Symbol", s.last_traded_price as "Price"
```

```

        FROM latest_stocks s, customer_portfolio p
        WHERE p.customer_id = ?
        AND s.ticker = p.ticker
    </xsql:query>
</current-prices>
<analysis>
    <xsql:include-owa bind-params="custid userCookie">
        BEGIN portfolio_analysis.historical_data(?,5 /* years */ , ?); END;
    </xsql:include-owa>
</analysis>
</portfolio>

```

16.3.1.2 Using Lexical Substitution Parameters

For any XSQL action element, you can substitute a lexical substitution parameter for the value of any attribute or the text of any contained SQL statement. Thus, you can parameterize how actions behave and substitute parts of the SQL statements that they perform.

Lexical substitution parameters are referenced with this syntax: {@ParameterName}.

[Example 16-7](#) (page 16-16) shows how you can use two lexical substitution parameters. One parameter in the `<xsql:query>` (page 32-23) element sets the maximum number of rows to be passed in, whereas the other controls the list of columns to be ordered.

[Example 16-7](#) (page 16-16) also contains two bind parameters: `dev` and `prod`. For example, you might want to get the open bugs for developer `yxsmith` against product `817`. And, you want to retrieve only 10 rows and order them by bug number. You can fetch the XML for the bug list by specifying parameter values:

```
http://server.com/bug/DevOpenBugs.xsql?dev=yxsmith&prod=817&max=10&orderby=bugno
```

You can also use the XSQL command-line utility to make the request:

```
xsql DevOpenBugs.xsql dev=yxsmith prod=817 max=10 orderby=bugno
```

Lexical parameters also enable you to specify parameters for the XSQL pages connection and the stylesheet used to process the page. [Example 16-8](#) (page 16-16) shows this technique. You can switch between stylesheets `test.xsql` and `prod.xsl` by specifying the name/value pairs `sheet=test` and `sheet=prod`.

Example 16-7 Lexical Substitution Parameters for Rows and Columns in DevOpenBugs.xsql

```

<!-- DevOpenBugs.xsql -->
<open-bugs connection="demo" xmlns:xsql="urn:oracle-xsql">
    <xsql:query max-rows="{@max}" bind-params="dev prod">
        SELECT bugno, abstract, status
        FROM   bug_table
        WHERE  programmer_assigned = UPPER(?)
        AND    product_id         = ?
        AND    status < 80
        ORDER BY {@orderby}
    </xsql:query>
</open-bugs>

```

Example 16-8 Lexical Substitution Parameters for Connections and Stylesheets in DevOpenBugs.xsql

```

<?xml version="1.0"?>
<?xml-stylesheet type="text/xsl" href="{@sheet}.xsl"?>
<!-- DevOpenBugs.xsql -->

```

```

<open-bugs connection="{@conn}" xmlns:xsql="urn:oracle-xsql">
  <xsql:query max-rows="{@max}" bind-params="dev prod">
    SELECT bugno, abstract, status
      FROM bug_table
     WHERE programmer_assigned = UPPER(?)
          AND product_id      = ?
          AND status < 80
     ORDER BY {@orderby}
  </xsql:query>
</open-bugs>

```

16.3.1.3 Providing Default Values for Bind and Substitution Parameters

You may want to provide a default value for a bind variable or a substitution parameter directly in a page. In this way, the page is parameterized without requiring the requester to explicitly pass in all values in each request.

To include a default value for a parameter, add an XML attribute of the same name as the parameter to the action element or to any ancestor element. If a value for a given parameter is not included in the request, then the XSQL page processor searches for an attribute by the same name on the current action element. If it does not find one, it keeps looking for such an attribute on each ancestor element of the current action element until it gets to the document element of the page.

The page in [Example 16-9](#) (page 16-18) defaults the value of the `max` parameter to 10 for both `<xsql:query>` actions in the page.

This page in [Example 16-10](#) (page 16-18) defaults the first query to a `max` of 5, the second query to a `max` of 7, and the third query to a `max` of 10.

All defaults are overridden if a value of `max` is supplied in the request, as shown in this example:

```
http://yourserver.com/example.xsql?max=3
```

Bind variables respect the same defaulting rules. [Example 16-11](#) (page 16-18) shows how you can set the `val` parameter to 10 by default.

If the page in [Example 16-11](#) (page 16-18) is requested without any parameters, it returns this XML datagram:

```

<example>
  <rowset>
    <row>
      <somevalue>10</somevalue>
    </row>
  </rowset>
</example>

```

Alternatively, assume that the page is requested with this URL:

```
http://yourserver.com/example.xsql?val=3
```

The preceding URL returns this datagram:

```

<example>
  <rowset>
    <row>
      <somevalue>3</somevalue>
    </row>
  </rowset>
</example>

```

You can remove the default value for the `val` parameter from the page by removing the `val` attribute. [Example 16-12](#) (page 16-18) shows this technique.

A URL request for the page that does not supply a name/value pair returns this datagram:

```
<example>
  <rowset/>
</example>
```

A bind variable that is bound to a parameter with *neither* a default value *nor* a value supplied in the request is bound to NULL, which causes the WHERE clause in [Example 16-12](#) (page 16-18) to return no rows.

Example 16-9 Setting a Default Value

```
<example max="10" connection="demo" xmlns:xsql="urn:oracle-xsql">
  <xsql:query max-rows="{@max}">SELECT * FROM TABLE1</xsql:query>
  <xsql:query max-rows="{@max}">SELECT * FROM TABLE2</xsql:query>
</example>
```

Example 16-10 Setting Multiple Default Values

```
<example max="10" connection="demo" xmlns:xsql="urn:oracle-xsql">
  <xsql:query max="5" max-rows="{@max}">SELECT * FROM TABLE1</xsql:query>
  <xsql:query max="7" max-rows="{@max}">SELECT * FROM TABLE2</xsql:query>
  <xsql:query max-rows="{@max}">SELECT * FROM TABLE3</xsql:query>
</example>
```

Example 16-11 Defaults for Bind Variables

```
<example val="10" connection="demo" xmlns:xsql="urn:oracle-xsql">
  <xsql:query tag-case="lower" bind-params="val val val">
    SELECT ? AS somevalue
    FROM DUAL
    WHERE ? = ?
  </xsql:query>
</example>
```

Example 16-12 Bind Variables with No Defaults

```
<example connection="demo" xmlns:xsql="urn:oracle-xsql">
  <xsql:query tag-case="lower" bind-params="val val val">
    SELECT ? AS somevalue
    FROM DUAL
    WHERE ? = ?
  </xsql:query>
</example>
```

16.3.1.4 How the XSQL Page Processor Handles Different Types of Parameters

XSQL pages can make use of parameters supplied in the request and also of page-private parameters. The names and values of page-private parameters are determined by actions in the page.

If an action encounters a reference to a parameter named `param` in either a `bind-params` attribute or in a lexical parameter reference, then the value of the `param` parameter is resolved in this order:

1. The value of the page-private parameter named `param`, if set
2. The value of the request parameter named `param`, if supplied

3. The default value provided by an attribute named `param` on the current action element or one of its ancestor elements
4. The value NULL for bind variables and the empty string for lexical parameters

For XSQL pages that are processed by the XSQL servlet over HTTP, you can also set and reference the HTTP-Session-level variables and HTTP Cookies parameters.

For XSQL pages processed through the XSQL servlet, the value of a parameter `param` is resolved in this order:

1. The value of the page-private parameter `param`, if set
2. The value of the cookie named `param`, if set
3. The value of the session variable named `param`, if set
4. The value of the request parameter named `param`, if supplied
5. The default value provided by an attribute named `param` on the current action element or one of its ancestor elements
6. The value NULL for bind variables and the empty string for lexical parameters

The resolution order means that users cannot supply parameter values in a request to override parameters of the same name set in the HTTP session. Also, users cannot set them as cookies that persist across browser sessions.

16.3.2 Producing Datagrams from SQL Queries

How to produce datagrams using SQL queries is described.

With XSQL servlet properly installed on your web server, you can access XSQL pages by following these basic steps:

1. Copy an XSQL file to a directory under the virtual hierarchy of your web server. [Example 16-3](#) (page 16-14) shows the sample page `AvailableFlightsToday.xsql`.

You can also deploy XSQL pages in a standard Java EE WAR file, which occurs when you use Oracle JDeveloper to develop and deploy your pages to Oracle WebLogic Server.

2. Load the page in your browser. For example, if the root URL is `yourcompany.com`, then you can access the `AvailableFlightsToday.xsql` page through a web browser by requesting this URL:

```
http://yourcompany.com/AvailableFlightsToday.xsql?City=JFK
```

The XSQL page processor automatically materializes the results of the query in your XSQL page as XML and returns them to the requester. Typically, another server program requests this XML-based datagram for processing, but if you use a browser such as Internet Explorer then you can directly view the XML result, as shown in [Figure 16-4](#) (page 16-20).

Figure 16-4 XML Result from XSQL Page (AvailableFlightsToday.xsql) Query

```

<?xml version="1.0" ?>
- <ROWSET>
- <ROW num="1">
  <CARRIER>VS</CARRIER>
  <FLIGHTNUMBER>344</FLIGHTNUMBER>
  <ORIGIN>London</ORIGIN>
  <DUE>16:10</DUE>
</ROW>
- <ROW num="2">
  <CARRIER>LH</CARRIER>
  <FLIGHTNUMBER>466</FLIGHTNUMBER>
  <ORIGIN>Frankfurt</ORIGIN>
  <DUE>21:33</DUE>
</ROW>
- <ROW num="3">
  <CARRIER>UA</CARRIER>
  <FLIGHTNUMBER>32</FLIGHTNUMBER>
  <ORIGIN>San Francisco</ORIGIN>
  <DUE>23:54</DUE>
</ROW>
</ROWSET>

```

16.3.3 Transforming XML Datagrams into an Alternative XML Format

If the canonical `<ROWSET>` and `<ROW>` XML output format is not the XML format you need, you can associate an XSLT stylesheet with your XSQL page. The stylesheet can transform the XML datagram in the server before returning the data.

The canonical output is presented in [Figure 16-4](#) (page 16-20).

When exchanging data with another program, you typically agree on a document type definition (DTD) that describes the XML format for the exchange. Assume that you are given the `flight-list.dtd` definition and are told to produce your list of arriving flights in a format compliant with the DTD. You can use a visual tool such as XML Authority to browse the structure of the `flight-list` DTD, as shown in [Figure 16-5](#) (page 16-21).

Figure 16-5 Exploring flight-list.dtd with XML Authority

Figure 16-5 (page 16-21) shows that the standard XML formats for flight lists are:

- `<flight-list>` element, which contains one or more `<flight>` elements
- `<flight>` elements, which have attributes `airline` and `number`, and each of which contains an `<arrives>` element
- `<arrives>` elements, which contains text

Example 16-13 (page 16-22) shows the XSLT stylesheet `flight-list.xsl`. By associating the stylesheet with the XSQL page, you can change the default `<ROWSET>` and `<ROW>` format into the industry-standard `<flight-list>` and `<flight>`.

The XSLT stylesheet is a template that includes the literal elements to produce in the resulting document, such as `<flight-list>`, `<flight>`, and `<arrives>`, interspersed with XSLT actions that enable you to do this:

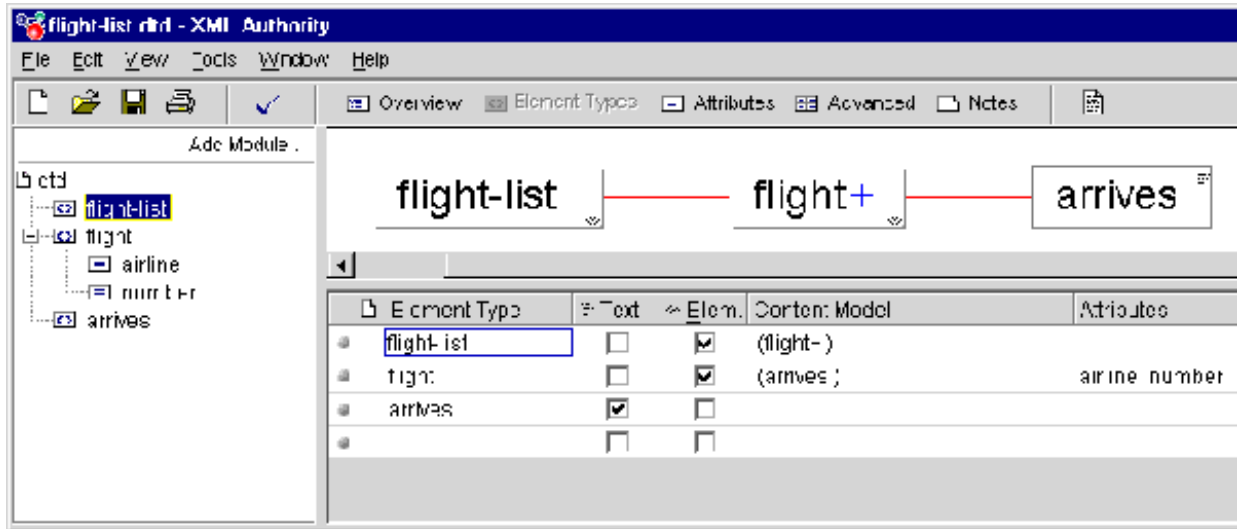
- Loop over matching elements in the source document with `<xsl:for-each>`
- Plug in the values of source document elements where necessary with `<xsl:value-of>`
- Plug in the values of source document elements into attribute values with the `{some_parameter}` notation

The following items have been added to the top-level `<flight-list>` element in the Example 16-13 (page 16-22) stylesheet:

- `xmlns:xsl="http://www.w3.org/1999/XSL/Transform"`

This attribute defines the XML namespace named `xsl` and identifies the URL string that uniquely identifies the XSLT specification. Although it looks just like a URL, think of the string `http://www.w3.org/1999/XSL/Transform` as the "global primary key" for the set of elements defined in the XSLT specification. When the namespace is defined, you can use the `<xsl:XXX>` action elements in the stylesheet to loop and plug values in where necessary.

- `xsl:version="1.0"`

This attribute identifies the document as an XSLT 1.0 stylesheet. A version attribute is required on all XSLT stylesheets for them to be valid and recognized by an XSLT processor.

You can associate the `flight-list.xml` stylesheet with the `AvailableFlightsToday.xsql` in [Example 16-3](#) (page 16-14) by adding an `<?xml-stylesheet?>` instruction to the top of the page. [Example 16-14](#) (page 16-22) shows this technique.

Associating an XSLT stylesheet with the XSQL page causes the requesting program or browser to view the XML in the format as specified by `flight-list.dtd` you were given. [Figure 16-6](#) (page 16-22) shows a sample browser display.

Figure 16-6 XSQL Page Results in XML Format



Example 16-13 Industry Standard Formats in `flight-list.xsl`

```
<!-- XSLT Stylesheet to transform ROWSET/ROW results into flight-list format
-->
<flight-list xmlns:xsl="http://www.w3.org/1999/XSL/Transform"
             xsl:version="1.0">
  <xsl:for-each select="ROWSET/ROW">
    <flight airline="{CARRIER}" number="{FLIGHTNUMBER}">
      <arrives><xsl:value-of select="DUE"/></arrives>
    </flight>
  </xsl:for-each>
</flight-list>
```

Example 16-14 Stylesheet Association in `flight-list.xsl`

```
<?xml version="1.0"?>
<?xml-stylesheet type="text/xsl" href="flight-list.xsl"?>
<xsql:query connection="demo" bind-params="City" xmlns:xsql="urn:oracle-xsql">
  SELECT Carrier, FlightNumber, Origin, TO_CHAR(ExpectedTime,'HH24:MI') AS Due
  FROM FlightSchedule
  WHERE TRUNC(ExpectedTime) = TRUNC(SYSDATE) AND Arrived = 'N'
  AND Destination = ? /* The ? is a bind variable being bound */
```

```
ORDER BY ExpectedTime /* to the value of the City parameter */
</xsql:query>
```

16.3.4 Transforming XML Datagrams into HTML for Display

To return XML data in HTML instead of an alternative XML format, use an appropriate XSLT stylesheet. For example, rather than producing elements such as `<flight-list>` and `<flight>`, you can write a stylesheet that produces HTML elements such as `<table>`, `<tr>`, and `<td>`.

The result of the dynamically queried data then looks like the HTML page shown in [Figure 16-7](#) (page 16-23). Instead of returning raw XML data, the XSQL page leverages server-side XSLT transformation to format the information as HTML for delivery to the browser.

Figure 16-7 Using an XSLT Stylesheet to Render HTML



Similar to the syntax of the `flight-list.xsl` stylesheet, the `flight-display.xsl` stylesheet shown in [Example 16-15](#) (page 16-24) looks like a template HTML page. It contains `<xsl:for-each>`, `<xsl:value-of>`, and attribute value templates such as `{DUE}` to plug in the dynamic values from the underlying `<ROWSET>` and `<ROW>` structured XML query results.

Note:

The stylesheet produces well-formed HTML. Each opening tag is properly closed (for example, `<td>...</td>`); empty tags use the XML empty element syntax `
` instead of just `
`.

You can achieve useful results quickly by combining the power of:

- Parameterized SQL statements to select information from Oracle Database
- Industry-standard XML as a portable, interim data exchange format
- XSLT to transform XML-based datagrams into any XML- or HTML-based format

Example 16-15 Query Results in flight-display.xsl

```
<!-- XSLT Stylesheet to transform ROWSET/ROW results into HTML -->
<html xmlns:xsl="http://www.w3.org/1999/XSL/Transform" xsl:version="1.0">
  <head><link rel="stylesheet" type="text/css" href="flights.css" /></head>
  <body>
    <center><table border="0">
      <tr><th>Flight</th><th>Arrives</th></tr>
      <xsl:for-each select="ROWSET/ROW">
        <tr>
          <td>
            <table border="0" cellspacing="0" cellpadding="4">
              <tr>
                <td></td>
                <td width="180">
                  <xsl:value-of select="CARRIER"/>
                  <xsl:text> </xsl:text>
                  <xsl:value-of select="FLIGHTNUMBER"/>
                </td>
              </tr>
            </table>
          </td>
          <td align="center"><xsl:value-of select="DUE"/></td>
        </tr>
      </xsl:for-each>
    </table></center>
  </body>
</html>
```

16.4 Using XSQL in Java Programs

Class `oracle.xml.xsql.XSQLRequest` lets you use the XSQL page processor in your Java programs.

To use the XSQL Java API, follow these basic steps:

1. Construct an instance of `XSQLRequest`, passing the XSQL page to be processed into the constructor as one of these components:
 - `String` containing a URL to the page
 - URL object for the page
 - In-memory `XMLDocument`
2. Invoke one of these methods on the object to process the page:
 - `process()` to write the result to a `PrintWriter` or `OutputStream`
 - `processToXML()` to return the result as an XML Document

To use the built-in XSQL connection manager, which implements JDBC connection pooling based on XSQL configuration file definitions, the XSQL page is all you must pass to the constructor. Optionally, you can pass in a custom implementation for the `XSQLConnectionFactory` interface as well.

The ability to pass the XSQL page as an in-memory `XMLDocument` object means that you can dynamically generate any valid XSQL page for processing. You can then pass the page to the XSQL engine for evaluation.

When processing a page, you may want to perform these additional tasks as part of the request:

- Pass a set of parameters to the request.

You accomplish this aim by passing any object that implements the `Dictionary` interface to the `process()` or `processToXML()` methods. Passing a `HashTable` containing the parameters is one popular approach.

- Set an XML document to be processed by the page as if it were the "posted XML" message body.

You can do this by using the `XSQLRequest.setPostedDocument()` method.

[Example 16-16](#) (page 16-25) shows how you can process a page by using `XSQLRequest`.

See Also:

[Using the XSQL Pages Publishing Framework: Advanced Topics](#) (page 17-1) to learn more about the XSQL Java API

Example 16-16 XSQLRequestSample Class

```
import oracle.xml.xsql.XSQLRequest;
import java.util.Hashtable;
import java.io.PrintWriter;
import java.net.URL;
public class XSQLRequestSample {
    public static void main( String[] args) throws Exception {
        // Construct the URL of the XSQL Page
        URL pageUrl = new URL("file:///C:/foo/bar.xsql");
        // Construct a new XSQL Page request
        XSQLRequest req = new XSQLRequest(pageUrl);
        // Set up a Hashtable of named parameters to pass to the request
        Hashtable params = new Hashtable(3);
        params.put("param1", "value1");
        params.put("param2", "value2");
        /* If needed, treat an existing, in-memory XMLDocument as if
        ** it were posted to the XSQL Page as part of the request
        req.setPostedDocument(myXMLDocument);
        **
        */
        // Process the page, passing the parameters and writing the output
        // to standard out.
        req.process(params, new PrintWriter(System.out),
                    new PrintWriter(System.err));
    }
}
```

16.5 XSQL Pages Tips and Techniques

Topics here provide information about using XSQL pages.

Topics:

- [XSQL Pages Limitations](#) (page 16-26)
- [Hints for Using the XSQL Servlet](#) (page 16-26)
- [Resolving Common XSQL Connection Errors](#) (page 16-30)
- [Security Considerations for XSQL Pages](#) (page 16-31)

16.5.1 XSQL Pages Limitations

Limitations are specified for XSQL pages.

HTTP parameters with multibyte names, such as a parameter whose name is in Kanji, are properly handled when they are inserted into your XSQL page with element `<xsql:include-request-params>` (page 32-16). An attempt to refer to a parameter with a multibyte name inside the query statement of an `<xsql:query>` (page 32-23) tag returns an empty string for the parameter value.

As a workaround, use a nonmultibyte parameter name. The parameter can still have a multibyte value that can be handled correctly.

16.5.2 Hints for Using the XSQL Servlet

Topics here provide hints for using the XSQL Servlet.

Topics:

- [Specifying a DTD While Transforming XSQL Output to a WML Document](#) (page 16-26)
- [Testing Conditions in XSQL Pages](#) (page 16-26)
- [Passing a Query Result to the WHERE Clause of Another Query](#) (page 16-27)
- [Handling Multivalued HTML Form Parameters](#) (page 16-27)
- [Invoking PL/SQL Wrapper Procedures to Generate XML Datagrams](#) (page 16-28)
- [Accessing Contents of Posted XML](#) (page 16-29)
- [Changing Database Connections Dynamically](#) (page 16-29)
- [Retrieving the Name of the Current XSQL Page](#) (page 16-30)

16.5.2.1 Specifying a DTD While Transforming XSQL Output to a WML Document

You can specify a DTD while transforming XSQL output to a Wireless Markup Language (WML) document for a wireless application. The technique is to use a built-in facility of the XSLT stylesheet called `<xsl:output>`. An example illustrates this.

```
<xsl:stylesheet xmlns:xsl="http://www.w3.org/1999/XSL/Transform">
  <xsl:output type="xml" doctype-system="your.dtd"/>
  <xsl:template match="/">
    <xsl:template>
      ...
    </xsl:template>
  </xsl:stylesheet>
```

The preceding stylesheet produces an XML result that includes this code, where `"your.dtd"` can be any valid absolute or relative URL:

```
<!DOCTYPE xxxx SYSTEM "your.dtd">
```

16.5.2.2 Testing Conditions in XSQL Pages

You can include if-then logic in your XSQL pages.

[Example 16-17](#) (page 16-27) shows a technique for executing a query based on a test of a parameter value.

See Also:

[XSQL Pages Reference](#) (page 32-1) to learn about the `<xsql:if-param>` (page 32-11) action

Example 16-17 Conditional Statements in XSQL Pages

```
<xsql:if-param name="security" equals="admin">
  <xsql:query>
    SELECT ....
  </xsql:query>
</xsql:when>
<xsql:if-param name="security" equals="user">
  <xsql:query>
    SELECT ....
  </xsql:query>
</xsql:if-param>
```

16.5.2.3 Passing a Query Result to the WHERE Clause of Another Query

If you have two queries in an XSQL page then you can use the value of a select list item of the first query in the second query by using page parameters.

Example 16-18 Passing Values Among SQL Queries

```
<page xmlns:xsql="urn:oracle-xsql" connection="demo">
  <!-- Value of page param "xxx" will be first column of first row -->
  <xsql:set-page-param name="xxx">
    SELECT one FROM table1 WHERE ...
  </xsql:set-page-param>
  <xsql:query bind-params="xxx">
    SELECT col3,col4 FROM table2
    WHERE col3 = ?
  </xsql:query>
</page>
```

16.5.2.4 Handling Multivalued HTML Form Parameters

In some situations, you might need to process multivalued HTML `<form>` parameters that are needed for `<input name="choices" type="checkbox">`. Use the parameter array notation on your parameter name (for example, `choices[]`) to refer to the array of values from the selected check boxes.

Assume that you have a multivalued parameter named `guy`. You can use the array parameter notation in an XSQL page as shown in [Example 16-19](#) (page 16-28).

Assume that you request this page is requested with this URL, which contains multiple parameters of the same name to produce a multivalued attribute:

```
http://yourserver.com/page.xsql?guy=Curly&guy=Larry&guy=Moe
```

The page returned looks like this:

```
<page>
  <guy-list>Curly,Larry,Moe</guy-list>
  <quoted-guys>'Curly','Larry','Moe'</quoted-guys>
  <guy>
    <value>Curly</value>
    <value>Larry</value>
    <value>Moe</value>
```

```
</guy>
</page>
```

You can also use the value of a multivalued page parameter in a SQL statement WHERE clause by using the code shown in [Example 16-20](#) (page 16-28).

Example 16-19 Handling Multivalued Parameters

```
<page xmlns:xsql="urn:oracle-xsql">
  <xsql:set-page-param name="guy-list" value="{@guy[]}"
    treat-list-as-array="yes"/>
  <xsql:set-page-param name="quoted-guys" value="{@guy[]}"
    treat-list-as-array="yes" quote-array-values="yes"/>
  <xsql:include-param name="guy-list"/>
  <xsql:include-param name="quoted-guys"/>
  <xsql:include-param name="guy[]"/>
</page>
```

Example 16-20 Using Multivalued Page Parameters in a SQL Statement

```
<page connection="demo" xmlns:xsql="urn:oracle-xsql">
  <xsql:set-page-param name="quoted-guys" value="{@guy[]}"
    treat-list-as-array="yes"
    quote-array-values="yes"/>

  <xsql:query>
    SELECT *
    FROM   sometable
    WHERE  name IN ({@quoted-guys})
  </xsql:query>
</page>
```

16.5.2.5 Invoking PL/SQL Wrapper Procedures to Generate XML Datagrams

The use of PL/SQL wrapper procedures to generate XML datagrams is described.

You cannot set parameter values by binding them in the position of OUT variables with `<xsql:dml>` (page 32-10). Only IN parameters are supported for binding. You can create a wrapper procedure, however, that constructs XML elements with the HTTP package. Your XSQL page can then invoke the wrapper procedure with `<xsql:include-owa>` (page 32-13).

[Example 16-21](#) (page 16-29) shows a PL/SQL procedure that accepts two IN parameters, multiplies them and puts the value in one OUT parameter, then adds them and puts the result in a second OUT parameter.

You can write the PL/SQL procedure in [Example 16-22](#) (page 16-29) to wrap the procedure in [Example 16-21](#) (page 16-29). The `addmultwrapper` procedure accepts the IN arguments that the `addmult` procedure preceding expects, and then encodes the OUT values as an XML datagram that you print to the Open Web Analytics (OWA) page buffer.

The XSQL page shown in [Example 16-23](#) (page 16-29) constructs an XML document by including a call to the PL/SQL wrapper procedure.

You can invoke `addmult.xsql` by entering a URL in a browser:

```
http://yourserver.com/addmult.xsql?arg1=30&arg2=45
```

The XML datagram returned by the servlet reflects the OUT values:

```
<page>
  <addmult><sum>75</sum><product>1350</product></addmult>
</page>
```

Example 16-21 addmult PL/SQL Procedure

```
CREATE OR REPLACE PROCEDURE addmult(arg1          NUMBER, arg2          NUMBER,
                                   sumval OUT NUMBER, prodval OUT NUMBER)
IS
BEGIN
    sumval := arg1 + arg2;
    prodval := arg1 * arg2;
END;
```

Example 16-22 addmultwrapper PL/SQL Procedure

```
CREATE OR REPLACE PROCEDURE addmultwrapper(arg1 NUMBER, arg2 NUMBER)
IS
    sumval NUMBER;
    prodval NUMBER;
    xml     VARCHAR2(2000);
BEGIN
    -- Call the procedure with OUT values
    addmult(arg1,arg2,sumval,prodval);
    -- Then produce XML that encodes the OUT values
    xml := '<addmult>' ||
          '<sum>' || sumval || '</sum>' ||
          '<product>' || prodval || '</product>' ||
          '</addmult>';
    -- Print the XML result to the OWA page buffer for return
    HTP.P(xml);
END;
```

Example 16-23 addmult.xsql

```
<page connection="demo" xmlns:xsql="urn:oracle-xsql">
  <xsql:include-owa bind-params="arg1 arg2">
    BEGIN addmultwrapper(?,?); END;
  </xsql:include-owa>
</page>
```

16.5.2.6 Accessing Contents of Posted XML

The XSQL page processor can access the contents of posted XML. Any XML document can be posted and handled by the feature that XSQL supports.

For example, an XSQL page can access the contents of an inbound SOAP message by using the `xpath="XPathExpression"` attribute in the `<xsql:set-page-param>` (page 32-30) action. Alternatively, custom action handlers can gain direct access to the SOAP message body by invoking `getPageRequest().getPostedDocument()`. To create the SOAP response body to return to the client, use an XSLT stylesheet or a custom serializer implementation to write the XML response in an appropriate SOAP-encoded format.

See Also:

The Airport SOAP demo for an example of using an XSQL page to implement a SOAP-based web service

16.5.2.7 Changing Database Connections Dynamically

You can choose database connections dynamically when invoking an XSQL page. For example, you might want to switch between a test database and a production

database. You can achieve this goal by including an XSQL parameter in the `connection` attribute of the XSQL page.

Define an attribute of the same name to serve as the default value for the connection name.

Assume that in your XSQL configuration file you define connections for database `testdb` and `proddb`. You then write an XSQL page with this `<xsql:query>` (page 32-23) element:

```
<xsql:query conn="testdb" connection="{@conn}" xmlns:xsql="urn:oracle-xsql">
  ...
</xsql:query>
```

If you request this page without any parameters, then the value of the `conn` parameter is `testdb`, so the page uses the connection named `testdb` defined in the XSQL configuration file. If you request the page with `conn=proddb`, then the page uses the connection named `proddb` instead.

16.5.2.8 Retrieving the Name of the Current XSQL Page

An XSQL page can access its own name in a generic way at run time to construct links to the current page.

You can use a helper method like the one shown in [Example 16-24](#) (page 16-30) to retrieve the name of the page inside a custom action handler.

Example 16-24 *Getting the Name of the Current XSQL Page*

```
private String curPageName(XSQLPageRequest req) {
    String thisPage = req.getSourceDocumentURI();
    int pos = thisPage.lastIndexOf('/');
    if (pos >=0) thisPage = thisPage.substring(pos+1);
    pos = thisPage.indexOf('?');
    if (pos >=0) thisPage = thisPage.substring(0,pos-1);
    return thisPage;
}
```

16.5.3 Resolving Common XSQL Connection Errors

Topics here include receiving unable-to-connect and no-posted-document errors.

Topics:

- [Receiving "Unable to Connect" Errors](#) (page 16-30)
- [Receiving "No Posted Document to Process" When Using HTTP POST](#) (page 16-31)

16.5.3.1 Receiving "Unable to Connect" Errors

Reasons are given for receiving errors saying that you cannot connect.

Suppose you are unable to connect to a database and you see errors similar to these when running the `helloworld.xsql` sample program:

```
Oracle XSQL Servlet Page Processor
XSQL-007: Cannot acquire a database connection to process page.
Connection refused(DESCRIPTION=(TMP=)(VSNNUM=135286784)(ERR=12505)
(ERROR_STACK=(ERROR=(CODE=12505)(EMFI=4))))
```

The preceding errors indicate that the XSQL servlet is attempting the JDBC connection based on the `<connectiondef>` information for the connection named `demo`, assuming you did not modify the `helloworld.xsql` demo page.

By default the `XSQLConfig.xml` file comes with the entry for the `demo` connection that looks like this (use the correct password):

```
<connection name="demo">
  <username>scott</username>
  <password>password</password>
  <dburl>jdbc:oracle:thin:@localhost:1521:ORCL</dburl>
  <driver>oracle.jdbc.driver.OracleDriver</driver>
</connection>
```

The error is probably due to one of these reasons:

- Your database is not on the `localhost` machine.
- Your database `SID` is not `ORCL`.
- Your TNS Listener Port is not `1521`.

16.5.3.2 Receiving "No Posted Document to Process" When Using HTTP POST

If you try to post XML information to an XSQL page for processing using `HTTP GET` instead of `HTTP POST`, then there is no posted document, and you get the "No posted document to process" error.

XML information posted to an XSQL page for processing must be sent by `HTTP POST`. This transfer can be effected by an HTML form or an XML document sent by `HTTP POST`.

16.5.4 Security Considerations for XSQL Pages

Best practices are covered for managing security in the XSQL servlet.

- [Installing Your XSQL Configuration File in a Safe Directory](#) (page 16-31)
- [Disabling Default Client Stylesheet Overrides](#) (page 16-31)
- [Protecting Against the Misuse of Substitution Parameters](#) (page 16-32)

16.5.4.1 Installing Your XSQL Configuration File in a Safe Directory

The `XSQLConfig.xml` configuration file contains sensitive database user name and password information. This file must not reside in any directory that maps to a virtual path of your web server, nor in any of its subdirectories.

The only required permissions for the configuration file are read permission granted to the UNIX account that owns the servlet engine. Failure to follow this recommendation could mean that a user of your site could browse the contents of your configuration file, thereby getting the passwords to database accounts.

16.5.4.2 Disabling Default Client Stylesheet Overrides

By default, the XSQL page processor lets you supply a stylesheet in a page request by passing a value for parameter `xml-stylesheet`. If you want the stylesheet referenced by the server-side XSQL page to be the only legal stylesheet, then include attribute `allow-client-style="no"` on the document element of your page.

You can also globally change the default setting in the `XSQLConfig.xml` file to disallow client stylesheet overrides. If you take either approach, then the only pages that allow client stylesheet overrides are those that include the `allow-client-style="yes"` attribute on their document element.

16.5.4.3 Protecting Against the Misuse of Substitution Parameters

Some precautions are described that help you avoid misuse of substitution variables.

Any product that supports the use of lexical substitution variables in a SQL query can cause a developer problems. Any time you deploy an XSQL page that allows part of all of a SQL statement to be substituted by a lexical parameter, you must ensure that you have taken appropriate precautions against misuse.

For example, one of the demonstrations that comes with XSQL Pages is the Adhoc Query Demo. It shows how you can supply the entire SQL statement of an `<xsql:query>` (page 32-23) action handler as a parameter. This technique is a powerful and beneficial tool when in the right hands, but if you deploy a similar page to your production system, then the user can execute any query that the database security privileges for the connection associated with the page allows. For example, the Adhoc Query Demo is set up to use a connection that maps to the `scott` account, so a user can query any data that `scott` would be allowed to query from SQL*Plus.

You can use these techniques to ensure that your pages are not abused:

- Ensure the database user account associated with the page has only the privileges for reading the tables and views you want your users to see.
- Use true bind variables instead of lexical bind variables when substituting single values in a `SELECT` statement. If you must parameterize syntactic parts of your SQL statement, then lexical parameters are the only way to proceed. Otherwise, use true bind variables so that any attempt to pass an invalid value generates an error instead of producing an unexpected result.

Using the XSQL Pages Publishing Framework: Advanced Topics

An explanation is given of how to use advanced features of the XSQL pages publishing framework.

For information about basic features, see [Using the XSQL Pages Publishing Framework](#) (page 16-1).

Topics:

- [Customizing the XSQL Configuration File Name](#) (page 17-1)
- [Controlling How Stylesheets Are Processed](#) (page 17-2)
- [Working with Array-Valued Parameters](#) (page 17-6)
- [Setting Error Parameters on Built-In Actions](#) (page 17-10)
- [Including XMLType Query Results in XSQL Pages](#) (page 17-12)
- [Handling Posted XML Content](#) (page 17-14)
- [Producing PDF Output with the FOP Serializer](#) (page 17-17)
- [Performing XSQL Customizations](#) (page 17-18)

17.1 Customizing the XSQL Configuration File Name

By default, the XSQL pages framework expects the configuration file to be named `XSQLConfig.xml`. When moving between development, test, and production environments, you can switch among different versions of a configuration file. To override the name of the configuration file read by the XSQL page processor, set system property `xsql.config`.

The simplest technique is to specify a Java Virtual Machine (JVM) command-line flag such as `-Dxsql.config=MyConfigFile.xml` by defining a servlet initialization parameter named `xsql.config`. Add an `<init-param>` element to your `web.xml` file as part of the `<servlet>` tag that defines the XSQL Servlet:

```
<servlet>
  <servlet-name>XSQL</servlet-name>
  <servlet-class>oracle.xml.xsql.XSQLServlet</servlet-class>
  <init-param>
    <param-name>xsql.config</param-name>
    <param-value>MyConfigFile.xml</param-value>
  <description>
    Please Use MyConfigFile.xml instead of XSQLConfig.xml
  </description>
```

```
</init-param>  
</servlet>
```

The servlet initialization parameter is applicable only to the servlet-based use of the XSQL engine. When using the `XSQLCommandLine` or `XSQLRequest` programmatic interfaces, use the `System` parameter instead.

Note:

The configuration file is always read from the CLASSPATH. For example, if you specify a custom configuration parameter file named `MyConfigFile.xml`, then the XSQL processor attempts to read the XML file as a resource from the CLASSPATH. In a servlet environment like Java Platform, Enterprise Edition (Java EE), you must place your `MyConfigFile.xml` in the `.\WEB-INF\classes` directory (or another top-level directory on the CLASSPATH). If both the servlet initialization parameter and the `System` parameter are provided, then the servlet initialization parameter value is used.

17.2 Controlling How Stylesheets Are Processed

Topics here include an overview of client stylesheets, controlling content type, assigning stylesheets dynamically, processing stylesheets in a client, and providing multiple stylesheets.

Topics:

- [Overriding Client Stylesheets](#) (page 17-2)
- [Controlling the Content Type of the Returned Document](#) (page 17-3)
- [Assigning the Stylesheet Dynamically](#) (page 17-3)
- [Processing XSLT Stylesheets in the Client](#) (page 17-4)
- [Providing Multiple Stylesheets](#) (page 17-5)

17.2.1 Overriding Client Stylesheets

If the current XSQL page being requested allows it, you can supply an Extensible Stylesheet Language Transformation (XSLT) stylesheet URL in the request. This technique lets you override the default stylesheet or apply a stylesheet where none is applied by default.

The client-initiated stylesheet URL is provided by supplying the `xml-stylesheet` parameter as part of the request. The valid values for this parameter are:

- Any relative URL interpreted relative to the XSQL page being processed.
- Any absolute URL that uses the HTTP protocol scheme, provided it references a trusted host as defined in the XSQL configuration file.
- The literal value `none`. Setting `xml-stylesheet=none` is useful during development to temporarily "short-circuit" the XSLT stylesheet processing to determine what XML datagram your stylesheet is seeing. Use this technique to determine why a stylesheet is not producing expected results.

You can allow client override of stylesheets for an XSQL page in these ways:

- Setting the `allow-client-style` configuration parameter to `no` in the XSQL configuration file
- Explicitly including an `allow-client-style="no"` attribute on the document element of any XSQL page

If client-override of stylesheets has been globally disabled by default in the XSQL configuration file, any page can still enable client-override explicitly by including an `allow-client-style="yes"` attribute on the document element of that page.

17.2.2 Controlling the Content Type of the Returned Document

Setting the content type of the data you serve lets a requesting client correctly interpret the data you return. If your stylesheet uses an `<xsl:output>` element then the XSQL processor infers the media type and the encoding of the returned document from the `media-type` and `encoding` attributes of `<xsl:output>`.

The stylesheet in [Example 17-1](#) (page 17-3) uses the `media-type="application/vnd.ms-excel"` attribute on `<xsl:output>`. This instruction transforms the results of an XSQL page containing a standard query of the `hr.employees` table into Microsoft Excel format.

The following XSQL page uses the stylesheet in [Example 17-1](#) (page 17-3):

```
<?xml version="1.0"?>
<?xml-stylesheet href="empToExcel.xsl" type="text/xsl"?>
<xsql:query connection="hr" xmlns:xsql="urn:oracle-xsql">
  SELECT  employee_id, email, salary
  FROM    employees
  ORDER BY salary DESC
</xsql:query>
```

Example 17-1 *empToExcel.xsl*

```
<?xml version="1.0"?>
<xsl:stylesheet version="1.0" xmlns:xsl="http://www.w3.org/1999/XSL/Transform">
  <xsl:output method="html" media-type="application/vnd.ms-excel"/>
  <xsl:template match="/">
    <html>
      <table>
        <tr><th>Id</th><th>Email</th><th>Salary</th></tr>
        <xsl:for-each select="ROWSET/ROW">
          <tr>
            <td><xsl:value-of select="EMPLOYEE_ID"/></td>
            <td><xsl:value-of select="EMAIL"/></td>
            <td><xsl:value-of select="SALARY"/></td>
          </tr>
        </xsl:for-each>
      </table>
    </html>
  </xsl:template>
</xsl:stylesheet>
```

17.2.3 Assigning the Stylesheet Dynamically

If you include an `<?xml-stylesheet?>` instruction at the top of your `.xsql` file, then the XSQL page processor considers it for use in transforming the resulting XML datagram.

Consider the `emp_test.xsql` page shown in [Example 17-2](#) (page 17-4).

The page in [Example 17-2](#) (page 17-4) uses the `emp.xsl` stylesheet to transform the results of the `employees` query in the server tier before returning the response to the requester. The processor accesses the stylesheet by the URL provided in the `href` pseudo-attribute on the `<?xml-stylesheet?>` processing instruction.

For example, to change XSLT stylesheets dynamically based on arguments passed to the XSQL servlet, you can use a lexical parameter in the `href` attribute of your `xml-stylesheet` processing instruction, as shown in this sample instruction:

```
<?xml-stylesheet type="text/xsl" href="{@filename}.xsl" ?>
```

You can then pass the value of the `filename` parameter as part of the URL request to XSQL servlet.

You can also use the `<xsql:set-page-param>` (page 32-30) element in an XSQL page to set the value of the parameter based on a SQL query. For example, the XSQL page in [Example 17-3](#) (page 17-4) selects the name of the stylesheet to use from a table by assigning the value of a page-private parameter.

Example 17-2 `emp_test.xsql`

```
<?xml version="1.0"?>
<?xml-stylesheet type="text/xsl" href="emp.xsl"?>
<page connection="demo" xmlns:xsql="urn:oracle-xsql">
  <xsql:query>
    SELECT *
    FROM   employees
    ORDER BY salary DESC
  </xsql:query>
</page>
```

Example 17-3 `emp_test_dynamic.xsql`

```
<?xml version="1.0"?>
<?xml-stylesheet type="text/xsl" href="{@sheet}.xsl"?>
<page connection="demo" xmlns:xsql="urn:oracle-xsql">
  <xsql:set-page-param bind-params="UserCookie" name="sheet">
    SELECT stylesheet_name
    FROM   user_prefs
    WHERE  username = ?
  </xsql:set-page-param>
  <xsql:query>
    SELECT *
    FROM   employees
    ORDER BY salary DESC
  </xsql:query>
</page>
```

17.2.4 Processing XSLT Stylesheets in the Client

How to process XSLT stylesheets in the client is described.

Some browsers support processing XSLT stylesheets in the client. These browsers recognize the stylesheet to be processed for an XML document by using an `<?xml-stylesheet?>` processing instruction. The use of `<?xml-stylesheet?>` for this purpose is part of the W3C Recommendation from June 29, 1999 entitled "Associating Stylesheets with XML Documents, Version 1.0".

By default, the XSQL pages processor performs XSLT transformations in the server. By adding `client="yes"` to your `<?xml-stylesheet?>` processing instruction in

your XSQL page, however, you can defer XSLT processing to the client. The processor serves the XML datagram "raw" with the current `<?xml-stylesheet?>` element at the top of the document.

17.2.5 Providing Multiple Stylesheets

You can include multiple `<?xml-stylesheet?>` processing instructions at the top of an XSQL page.

The instructions can contain an optional `media` pseudo-attribute. If specified, the processor case-insensitively compares the value of the `media` pseudo-attribute with the value of the User-Agent string in the HTTP header. If the value of the `media` pseudo-attribute matches part of the User-Agent string, then the processor selects the current `<?xml-stylesheet?>` instruction for use. Otherwise, the processor ignores the instruction and continues looking. The processor uses the first matching processing instruction in document order. An instruction *without* a `media` pseudo-attribute matches all user agents.

[Processing Instructions"?>](#) (page 17-6) shows multiple processing instructions at the top of an XSQL file. The processor uses `doyouxml-lynx.xml` for Lynx browsers, `doyouxml-ie.xml` for Internet Explorer 5.0 or 5.5 browsers, and `doyouxml.xml` for all others.

["?>](#) (page 17-5) summarizes the supported pseudo-attributes allowed on the `<?xml-stylesheet?>` processing instruction.

Table 17-1 Pseudo-Attributes for `<?xml-stylesheet ?>`

Attribute Name	Description
<code>type = "string"</code>	Indicates the Multipurpose Internet Mail Extensions (MIME) type of the associated stylesheet. For XSLT stylesheets, this attribute must be set to the string <code>text/xml</code> . This attribute may be present <i>or</i> absent when using the <code>serializer</code> attribute, depending on whether an XSLT stylesheet must execute before invoking the serializer, or not.
<code>href = "URL"</code>	Indicates the relative or absolute URL to the XSLT stylesheet to be used. If an absolute URL is supplied that uses the <code>http</code> protocol scheme, the IP address of the resource must be a trusted host listed in the XSQL configuration file (by default, named <code>XSQLConfig.xml</code>).
<code>media = "string"</code>	Performs a <i>case-insensitive</i> match on the User-Agent string from the HTTP header sent by the requesting device. This attribute is optional. The current <code><?xml-stylesheet?></code> processing instruction is used only if the User-Agent string contains the value of the <code>media</code> attribute; otherwise it is ignored.
<code>client = "boolean"</code>	Defers the processing of the associated XSLT stylesheet to the client if set to <code>yes</code> . The raw XML datagram is sent to the client with the current <code><?xml-stylesheet?></code> instruction at the top of the document. The default if not specified is to perform the transformation in the server.

Table 17-1 (Cont.) Pseudo-Attributes for <?xml-stylesheet ?>

Attribute Name	Description
<code>serializer = "string"</code>	<p>By default, the XSQL page processor uses:</p> <ul style="list-style-type: none"> XML Document Object Model (DOM) serializer if no XSLT stylesheet is used XSLT processor serializer if an XSLT stylesheet is used <p>Specifying this pseudo-attribute indicates that a custom serializer implementation must be used instead.</p> <p>Valid values are either the name of a custom serializer defined in the <code><serializerdefs></code> section of the XSQL configuration file or the string <code>java:fully.qualified.Classname</code>. If both an XSLT stylesheet and the <code>serializer</code> attribute are present, then the processor performs the XSLT transformation first, then invokes the custom serializer to render the final result to the <code>OutputStream</code> or <code>PrintWriter</code>.</p>

Example 17-4 Multiple <?xml-stylesheet ?> Processing Instructions

```
<?xml version="1.0"?>
<?xml-stylesheet type="text/xsl" media="lynx" href="doyouxml-lynx.xsl" ?>
<?xml-stylesheet type="text/xsl" media="msie 5" href="doyouxml-ie.xsl" ?>
<?xml-stylesheet type="text/xsl" href="doyouxml.xsl" ?>
<page xmlns:xsql="urn:oracle-xsql" connection="demo">
```

17.3 Working with Array-Valued Parameters

Topics here include using array values for parameters, including page or session parameters and parameters in SQL or PL/SQL code

Topics:

- [Supplying Values for Array-Valued Parameters](#) (page 17-6)
- [Setting Array-Valued Page or Session Parameters from Strings](#) (page 17-7)
- [Binding Array-Valued Parameters in SQL and PL/SQL Statements](#) (page 17-8)

17.3.1 Supplying Values for Array-Valued Parameters

Request parameters, session parameters, and page-private parameters can have arrays of strings as values. To treat to the value of a parameter as an array, add two empty square brackets to the end of its name.

For example, if an HTML form is posted with four occurrences of a input control named `productid`, then use the notation `productid[]` to refer to the array-valued `productid` parameter. If you refer to an array-valued parameter without using the array-brackets notation, then the XSQL processor uses the value of the first array entry.

Note:

The XSQL processor does not support use of numbers inside the array brackets. That is, you can refer to `productid` or `productid[]`, but not `productid[2]`.

Suppose that you refer to an array-valued parameter as a lexical substitution parameter inside an action handler attribute value or inside the content of an action handler element. The XSQL page processor converts its value to a comma-delimited list of non-null and nonempty strings in the order that they exist in the array.

[Example 17-5](#) (page 17-7) shows an XSQL page with an array-valued parameter.

You can invoke the XSQL command-line utility to supply multiple values for the `productid` parameter in `Page.xsql`:

```
xsql Page.xsql productid=111 productid=222 productid=333 productid=444
```

The preceding command sets the `productid[]` array-valued parameter to the value `{"111","222","333","444"}`. The XSQL page processor replaces the `{@productid[]}` expression in the query with the string `"111,222,333,444"`.

You can also pass multivalued parameters programmatically through the `XSQLRequest` application programming interface (API), which accepts a `java.util.Dictionary` of named parameters. You can use a `Hashtable` and invoke its `put(name, value)` method to add `String`-valued parameters to the request. To add multivalued parameters, put a value of type `String[]` instead of type `String`.

Note:

Only request parameters, page-private parameters, and session parameters can use string arrays. The `<xsql:set-stylesheet-param>` (page 32-34) and `<xsql:set-cookie>` (page 32-28) actions support only working with parameters as simple string values. To refer to a multivalued parameter in your XSLT stylesheet, use `<xsql:include-param>` (page 32-14) to include the multivalued parameter into your XSQL datapage, then use an XPath expression in the stylesheet to refer to the values from the datapage.

Example 17-5 Using an Array-Valued Parameter in an XSQL Page

```
<page xmlns:xsql="urn:oracle-xsql">
  <xsql:query>
    SELECT description
    FROM product
    WHERE productid in ( {@productid[]} ) /* Using lexical parameter */
  </xsql:query>
</page>
```

17.3.2 Setting Array-Valued Page or Session Parameters from Strings

You can set the value of a page-private parameter or a session parameter from strings.

You can set the value of a page-private parameter to a string-array value by using array brackets notation on the name:

```
<!-- param name contains array brackets -->
<xsql:set-page-param name="names[]" value="Tom Jane Joe"/>
```

You set the value similarly for session parameters, as shown in this example:

```
<xsql:set-session-param name="dates[]" value="12-APR-1962 15-JUL-1968"/>
```

By default, when the name of the parameter uses array brackets, the XSQL processor treats the value as a space-or-comma-delimited list and tokenizes it.

The resulting string array value contains these separate tokens. In the preceding examples, parameter `names[]` is the string array {"Tom", "Jane", "Joe"} and parameter `dates[]` is the string array {"12-APR-1962", "15-JUL-1968"}.

To handle strings that contain spaces, the tokenization algorithm first checks the string for the presence of commas. If at least one comma is found in the string, then commas are used as the token delimiter. For example, this action sets the value of the `names[]` parameter to the string array {"Tom Jones", "Jane York"}:

```
<!-- param name contains array brackets -->
<xsql:set-page-param name="names[]" value="Tom Jones,Jane York"/>
```

By default, when you set a parameter whose name does not end with the array-brackets, then the string-tokenization does not occur. Thus, this action sets the parameter `names` to the literal string "Tom Jones ,Jane York":

```
<!-- param name does NOT contain array brackets -->
<xsql:set-page-param name="names" value="Tom Jones,Jane York"/>
```

You can force the string to be tokenized by including the `treat-list-as-array="yes"` attribute on the `<xsql:set-page-param>` (page 32-30) or `<xsql:set-session-param>` (page 32-32) actions. When this attribute is set, the XSQL processor assigns a comma-delimited string of the tokenized values to the parameter. For example, this action sets the `names` parameter to the literal string "Tom , Jane , Joe":

```
<!-- param name does NOT contain array brackets -->
<xsql:set-page-param name="names" value="Tom Jane Joe"
  treat-list-as-array="yes"/>
```

When you are setting the value of a simple string-valued parameter and you are tokenizing the value with `treat-list-as-array="yes"`, you can include the `quote-array-values="yes"` attribute to surround the comma-delimited values with single quotation marks. Thus, this action assigns the literal string value "' Tom Jones ', 'Jane York ', 'Jimmy '" to the `names` parameter:

```
<!-- param name does NOT contain array brackets -->
<xsql:set-page-param name="names" value="Tom Jones,Jane York,Jimmy"
  treat-list-as-array="yes"
  quote-array-values="yes"/>
```

17.3.3 Binding Array-Valued Parameters in SQL and PL/SQL Statements

Where string-valued scalar bind variables are supported in an XSQL page, you can also bind array-valued parameters. Use the array parameter name, for example, `myparam[]`, in the list of parameter names that you supply for attribute `bind-params`. This technique lets you process array-valued parameters in SQL statements and PL/SQL procedures.

The XSQL processor binds array-valued parameters as a nested table object type named `XSQL_TABLE_OF_VARCHAR`. You must create this type in your current schema with this DDL statement:

```
CREATE TYPE xsql_table_of_varchar AS TABLE OF VARCHAR2(2000);
```

Although the type must have the name `xsql_table_of_varchar`, you can change the dimension of the `VARCHAR2` string, if necessary. You must make the dimension long enough for any string value you expect to handle in your array-valued string parameters.

Consider the PL/SQL function shown in [Example 17-6](#) (page 17-10).

The XSQL page in [Example 17-7](#) (page 17-10) shows how to bind two array-valued parameters in a SQL statement that uses `testTableFunction`.

Executing the XSQL page in [Example 17-7](#) (page 17-10) generates this datagram:

```
<page someNames="aa,bb,cc" someValues="11,22,33">
  <ROWSET>
    <ROW num="1">
      <EXAMPLE>aa=11:bb=22:cc=33</EXAMPLE>
    </ROW>
  </ROWSET>
</page>
```

This technique shows that the XSQL processor bound the array-valued `someNames[]` and `someValues[]` parameters as table collection types. It iterated over the values and concatenated them to produce the "aa=11:bb=22:cc=33" string value as the return value of the PL/SQL function.

You can mix any number of regular parameters and array-valued parameters in your bind-params string. Use the array-bracket notation for the parameters to be bound as arrays.

Note:

If you run the page in [Example 17-7](#) (page 17-10) but you have not created the `XSQL_TABLE_OF_VARCHAR` type as shown earlier, then you receive an error such as:

```
<page someNames="aa,bb,cc" someValues="11,22,33">
  <xsql-error code="17074" action="xsql:query">
    <statement>
      select testTableFunction(?,?) as example from dual
    </statement>
    <message>
      invalid name pattern: SCOTT.XSQL_TABLE_OF_VARCHAR
    </message>
  </xsql-error>
</page>
```

Because the XSQL processor binds array parameters as nested table collection types, you can use the `TABLE()` operator with the `CAST()` operator in SQL to treat the nested table bind variable value as a table of values. You can then query this table. This technique is especially useful in subqueries. The page in [Example 17-8](#) (page 17-10) uses an array-valued parameter containing employee IDs to restrict the rows queried from `hr.employees`.

The XSQL page in [Example 17-8](#) (page 17-10) generates a datagram such as:

```
<page>
  <ROWSET>
    <ROW num="1">
      <NAME>Alana Walsh</NAME>
      <SALARY>3100</SALARY>
    </ROW>
    <ROW num="2">
      <NAME>Kevin Feeny</NAME>
      <SALARY>3000</SALARY>
    </ROW>
```

```
</ROWSET>
</page>
```

Example 17-7 (page 17-10) and **Example 17-8** (page 17-10) show how to use bind-params with `<xsql:query>` (page 32-23), but these techniques work for `<xsql:dml>` (page 32-10), `<xsql:include-owa>` (page 32-13), `<xsql:ref-cursor-function>` (page 32-26), and other actions that accept SQL or PL/SQL statements.

PL/SQL index-by tables work with the OCI JDBC driver but not the JDBC thin driver. By using the nested table collection type `XSQL_TABLE_OF_VARCHAR`, you can use array-valued parameters with either driver. In this way you avoid losing the programming flexibility of working with array values in PL/SQL.

Example 17-6 testTableFunction

```
FUNCTION testTableFunction(p_name XSQL_TABLE_OF_VARCHAR,
                          p_value XSQL_TABLE_OF_VARCHAR)
RETURN VARCHAR2 IS
  lv_ret   VARCHAR2(4000);
  lv_numElts INTEGER;
BEGIN
  IF p_name IS NOT NULL THEN
    lv_numElts := p_name.COUNT;
    FOR j IN 1..lv_numElts LOOP
      IF (j > 1) THEN
        lv_ret := lv_ret||':';
      END IF;
      lv_ret := lv_ret||p_name(j)||'='||p_value(j);
    END LOOP;
  END IF;
  RETURN lv_ret;
END;
```

Example 17-7 XSQL Page with Array-Valued Parameters

```
<page xmlns:xsql="urn:oracle-xsql" connection="demo"
      someNames="aa,bb,cc" someValues="11,22,33">
  <xsql:query bind-params="someNames[] someValues[]">
    SELECT testTableFunction(?,?) AS example
    FROM dual
  </xsql:query>
</page>
```

Example 17-8 Using an Array-Valued Parameter to Restrict Rows

```
<page xmlns:xsql="urn:oracle-xsql" connection="hr">
  <xsql:set-page-param name="someEmployees[]" value="196,197"/>
  <xsql:query bind-params="someEmployees[]">
    SELECT first_name||' '||last_name AS name, salary
    FROM employees
    WHERE employee_id IN (
      SELECT * FROM TABLE(CAST( ? AS xsql_table_of_varchar))
    )
  </xsql:query>
</page>
```

17.4 Setting Error Parameters on Built-In Actions

You can set a page-private parameter on a built-in XSQL action when the action reports a nonfatal error.

The XSQL page processor determines whether an action encountered a nonfatal error during its execution. For example, an attempt to insert a row or invoke a stored procedure can fail with a database exception that gets included in your XSQL data page as an `<xsql-error>` element.

Use attribute `error-param` on the action to set a page-private parameter on a built-in XSQL action when the action reports a nonfatal error. For example, to set parameter `dml-error` when the statement inside action `<xsql:dml>` (page 32-10) encounters a database error, you can use the technique shown in [Example 17-9](#) (page 17-11).

If the execution of action `<xsql:dml>` encounters an error then the XSQL processor sets the page-private parameter `dml-error` to the string "Error". If the execution is successful then the XSQL processor does not assign a value to the error parameter. In [Example 17-9](#) (page 17-11), if the page-private parameter `dml-error` already exists then it retains its current value. If it does not exist then it continues not to exist.

Example 17-9 Setting an Error Parameter

```
<xsql:dml error-param="dml-error" bind-params="val">
  INSERT INTO yourtable(somecol)
    VALUES(?)
</xsql:dml>
```

17.4.1 Using Conditional Logic with Error Parameters

How to get conditional behavior in your XSQL page template is described.

By using the error parameter in combination with `<xsql:if-param>` (page 32-11), you can achieve conditional behavior in your XSQL page template. For example, assume that your connection definition sets the `AUTOCOMMIT` flag to `false` on the connection named `demo` in the XSQL configuration file. The XSQL page shown in [Example 17-10](#) (page 17-11) shows how you might roll back the changes made by a previous action if a subsequent action encounters an error.

If you have written custom action handlers, and if your custom actions invoke `reportMissingAttribute()`, `reportError()`, or `reportErrorIncludingStatement()` to report nonfatal action errors, then they automatically pick up this feature as well.

Example 17-10 Achieving Conditional Behavior with an Error Parameter

```
<!-- NOTE: Connection "demo" must not set to autocommit! -->
<page connection="demo" xmlns:xsql="urn:oracle-xsql">
  <xsql:dml error-param="dml-error" bind-params="val">
    INSERT INTO yourtable(somecol)
      VALUES(?)
  </xsql:dml>
  <!-- This second statement will commit if it succeeds -->
  <xsql:dml commit="yes" error-param="dml-error" bind-params="val2">
    INSERT INTO anothertable(anothercol)
      VALUES(?)
  </xsql:dml>
  <xsql:if-param name="dml-error" exists="yes">
    <xsql:dml>
      ROLLBACK
    </xsql:dml>
  </xsql:if-param>
</page>
```

17.4.2 Formatting XSQL Action Handler Errors

Errors raised by the processing of XSQL action elements are reported as XML elements in a uniform way. This fact enables XSLT stylesheets to detect their presence and optionally format them for presentation.

The action element in error is replaced in the page by this element:

```
<xsql-error action="xxx">
```

Depending on the error the `<xsql-error>` element contains:

- A nested `<message>` element
- A `<statement>` element with the offending SQL statement

[Example 17-11](#) (page 17-12) shows an XSLT stylesheet that uses this information to display error information on the screen.

Example 17-11 XSLT Stylesheet

```
<xsl:if test="//xsql-error">
  <table style="background:yellow">
    <xsl:for-each select="//xsql-error">
      <tr>
        <td><b>Action</b></td>
        <td><xsl:value-of select="@action"/></td>
      </tr>
      <tr valign="top">
        <td><b>Message</b></td>
        <td><xsl:value-of select="message"/></td>
      </tr>
    </xsl:for-each>
  </table>
</xsl:if>
```

17.5 Including XMLType Query Results in XSQL Pages

Oracle Database supports XMLType for storing and querying XML-based database content.

You can exploit database XML features to produce XML data for inclusion in your XSQL pages by using one of these techniques:

- `<xsql:query>` (page 32-23) handles any query including columns of type XMLType, but it handles XML markup in CLOB and VARCHAR2 columns as literal text.
- `<xsql:include-xml>` (page 32-17) parses and includes a single CLOB or string-based XML document retrieved from a query.

One difference between the preceding approaches is that `<xsql:include-xml>` parses the literal XML appearing in a CLOB or string value as needed to turn it into a tree of elements and attributes. In contrast, `<xsql:query>` leaves XML markup in CLOB or string-valued columns as literal text.

Another difference is that while `<xsql:query>` can handle query results of any number of columns and rows, `<xsql:include-xml>` works on a single column of a single row. Accordingly, when using `<xsql:include-xml>`, the SELECT statement inside it returns a single row containing a single column. The column can either be a

CLOB or a VARCHAR2 value containing a well-formed XML document. The XSQL engine parses the XML document and includes it in your XSQL page.

[Example 17-12](#) (page 17-13) uses nested `XmlAgg()` functions to aggregate the results of a dynamically-constructed XML document containing departments and nested employees. The functions aggregate the document into a single "result" document wrapped in a `<DepartmentList>` element.

In another example, suppose you have many `<Movie>` XML documents stored in a table of XMLType called `movies`. Each document might look like the one shown in [Example 17-13](#) (page 17-14).

You can use the built-in XPath query features to extract an aggregate list of all cast members who have received Oscar awards from any movie in the database.

[Example 17-14](#) (page 17-14) shows a sample query.

To include this query result of XMLType in your XSQL page, paste the query inside an `<xsql:query>` element. Make sure you include an alias for the query expression, as shown in [Example 17-15](#) (page 17-14).

You can use the combination of `XmlElement()` and `XmlAgg()` to make the database aggregate all of the XML fragments identified by the query into single, well-formed XML document. The functions work to produce a well-formed result like this:

```
<AwardedActors>
  <Actor>...</Actor>
  <Actress>...</Actress>
</AwardedActors>
```

You can use the standard XSQL bind variable capabilities in the middle of an XPath expression if you concatenate the bind variable into the expression. For example, to parameterize the value `Oscar` into a parameter named `award-from`, you can use an XSQL page like the one shown in [Example 17-16](#) (page 17-14).

Example 17-12 Aggregating a Dynamically-Constructed XML Document

```
<xsql:query connection="hr" xmlns:xsql="urn:oracle-xsql">
  SELECT XmlElement("DepartmentList",
    XmlAgg(
      XmlElement("Department",
        XmlAttributes(department_id AS "Id"),
        XmlForest(department_name AS "Name"),
        (SELECT XmlElement("Employees",
          XmlAgg(
            XmlElement("Employee",
              XmlAttributes(employee_id AS "Id"),
              XmlForest(first_name||' '||last_name AS "Name",
                salary AS "Salary",
                job_id AS "Job")
            )
          )
        )
      )
    )
  ) AS result
  FROM employees e
  WHERE e.department_id = d.department_id
</xsql:query>
```

Example 17-13 Movie XML Document

```
<Movie Title="The Talented Mr.Ripley" RunningTime="139" Rating="R">
  <Director>
    <First>Anthony</First>
    <Last>Minghella</Last>
  </Director>
  <Cast>
    <Actor Role="Tom Ripley">
      <First>Matt</First>
      <Last>Damon</Last>
    </Actor>
    <Actress Role="Marge Sherwood">
      <First>Gwyneth</First>
      <Last>Paltrow</Last>
    </Actress>
    <Actor Role="Dickie Greenleaf">
      <First>Jude</First>
      <Last>Law</Last>
      <Award From="BAFTA" Category="Best Supporting Actor"/>
    </Actor>
  </Cast>
</Movie>
```

Example 17-14 Using XPath to Extract an Aggregate List

```
SELECT XMLELEMENT("AwardedActors",
  XMLAGG(EXTRACT(VALUE(m),
    '/Movie/Cast/*[Award[@From="Oscar"]]'))))
FROM movies m
```

Example 17-15 Including an XMLType Query Result

```
<xsql:query connection="demo" xmlns:xsql="urn:oracle-xsql">
  SELECT XMLELEMENT("AwardedActors",
    XMLAGG(EXTRACT(VALUE(m),
      '/Movie/Cast/*[Award[@From="Oscar"]]')))) AS result
  FROM movies m
</xsql:query>
```

Example 17-16 Using XSQL Bind Variables in an XPath Expression

```
<xsql:query connection="orcl92" xmlns:xsql="urn:oracle-xsql"
  award-from="Oscar" bind-params="award-from">
  /* Using a bind variable in an XPath expression */
  SELECT XMLELEMENT("AwardedActors",
    XMLAGG(EXTRACT(VALUE(m),
      '/Movie/Cast/*[Award[@From="' || ? || '"]]')))) AS result
  FROM movies m
</xsql:query>
```

17.6 Handling Posted XML Content

In addition to simplifying the assembly and transformation of XML content, the XSQL pages framework helps you handle posted XML content.

Built-in actions provide these advantages:

- Simplify the handling of posted data from both XML document and HTML forms
- Enable data to be posted directly into a database table by using XSU

XSU can perform database inserts, updates, and deletes based on the content of an XML document in canonical form for a target table or view. For a specified table, the canonical XML form of its data is given by one row of XML output from a `SELECT *` query. When given an XML document in this form, XSU can automate the DML operation.

By combining XSU with XSLT, you can transform XML in any format into the canonical format expected by a given table. XSU can then perform DML on the resulting canonical XML.

The following built-in XSQL actions make it possible for you to exploit this capability from within your XSQL pages:

- [<xsql:insert-request>](#) (page 32-21)
Insert the optionally transformed XML document that was posted in the request into a table.
- [<xsql:update-request>](#) (page 32-36)
Update the optionally transformed XML document that was posted in the request into a table or view.
- [<xsql:delete-request>](#) (page 32-8)
Delete the optionally transformed XML document that was posted in the request from a table or view.
- [<xsql:insert-param>](#) (page 32-20)
Insert the optionally transformed XML document that was posted as the value of a request parameter into a table or view.

If you target a database view with your insert, then you can create `INSTEAD OF INSERT` triggers on the view to further automate the handling of the posted information. For example, an `INSTEAD OF INSERT` trigger on a view can use PL/SQL to check for the existence of a record and intelligently choose whether to do an `INSERT` or an `UPDATE` depending on the result of this check.

17.6.1 Understanding XML Posting Options

An overview is provided of XML posting options.

The XSQL pages framework can handle posted data in these scenarios:

- A client program sends an HTTP `POST` message that targets an XSQL page. The request body contains an XML document; the HTTP header reports a `ContentType` of `"text/xml"`.
In this case, `<xsql:insert-request>`, `<xsql:update-request>`, or `<xsql:delete-request>` can insert, update, or delete the content of the posted XML in the target table. If you transform the posted XML with XSLT, then the posted document is the source for the transformation.
- A client program sends an HTTP `GET` request for an XSQL page, one of whose parameters contains an XML document.
In this case, you can use the `<xsql:insert-param>` action to insert the content of the posted XML parameter value in the target table. If you transform the posted XML document with XSLT, then the XML document in the parameter value is the source document for this transformation.

- A browser submits an HTML form with `method="POST"` whose action targets an XSQL page. The request body of the HTTP POST message contains an encoded version of the form fields and values with a `ContentType` of `"application/x-www-form-urlencoded"`.

In this case, the request does not contain an XML document, but an encoded version of the form parameters. To make all three of these cases uniform, however, the XSQL page processor materializes on demand an XML document from the form parameters, session variables, and cookies contained in the request. The XSLT processor transforms this dynamically-materialized XML document into canonical form for DML by using `<xsql:insert>`, `<xsql:update-request>`, or `<xsql:delete-request>`.

When working with posted HTML forms, the dynamically materialized XML document has the form shown in [Example 17-17](#) (page 17-17).

If multiple parameters are posted with the same name, then the XSQL processor automatically creates multiple `<row>` elements to make subsequent processing easier. Assume that a request posts or includes these parameters and values:

- `id = 101`
- `name = Steve`
- `id = 102`
- `name = Sita`
- `operation = update`

The XSQL page processor creates a set of parameters as follows:

```
<request>
  <parameters>
    <row>
      <id>101</id>
      <name>Steve</name>
    </row>
    <row>
      <id>102</id>
      <name>Sita</name>
    </row>
    <operation>update</operation>
  </parameters>
  ...
</request>
```

You must provide an XSLT stylesheet that transforms this materialized XML document containing the request parameters into canonical format for your target table. Thus, you can build an XSQL page:

```
<!--
| ShowRequestDocument.xsql
| Show Materialized XML Document for an HTML Form
+-->
<xsql:include-request-params xmlns:xsql="urn:oracle-xsql"/>
```

With this page in place, you can temporarily modify your HTML form to post to the `ShowRequestDocument.xsql` page. In the browser you see the "raw" XML for the materialized XML request document, which you can save and use to develop the XSL transformation.

Example 17-17 XML Document Generated from HTML Form

```

<request>
  <parameters>
    <firstparamname>firstparamvalue</firstparamname>
    ...
    <lastparamname>lastparamvalue</lastparamname>
  </parameters>
  <session>
    <firstparamname>firstsessionparamvalue</firstparamname>
    ...
    <lastparamname>lastsessionparamvalue</lastparamname>
  </session>
  <cookies>
    <firstcookie>firstcookievalue</firstcookiename>
    ...
    <lastcookie>firstcookievalue</lastcookiename>
  </cookies>
</request>

```

17.7 Producing PDF Output with the FOP Serializer

Using the XSQL pages framework support for custom serializers, the `oracle.xml.xsql.serializers.XSQLFOPSerializer` class provides integration with the Apache FOP processor. The FOP processor renders a PDF document from an XML document containing XSL Formatting Objects.

As described in [Table 16-1](#) (page 16-8), the demo directory includes the `emptablefo.xsl` stylesheet and `emptable.xsql` page as illustrations. If you get an error trying to use the FOP serializer, then probably you do not have all of the required JAR files in the CLASSPATH. The `XSQLFOPSerializer` class resides in the separate `xml.jar` file, which must be included in the CLASSPATH to use the FOP integration. You must also add these additional Java archives to your CLASSPATH:

- `fop.jar`—from Apache, version 0.20.3 or later
- `batik.jar`—from the FOP distribution
- `avalon-framework-4.0.jar`—from FOP distribution
- `logkit-1.0.jar`—from FOP distribution

In case you want to customize the implementation, the source code for the FOP serializer provided in this release is shown in [Example 17-18](#) (page 17-17).

See Also:

<http://xml.apache.org/fop> to learn about the Formatting Objects Processor

Example 17-18 Source Code for FOP Serializer

```

package oracle.xml.xsql.serializers;
import org.w3c.dom.Document;
import org.apache.log.Logger;
import org.apache.log.Hierarchy;
import org.apache.fop.messaging.MessageHandler;
import org.apache.log.LogTarget;
import oracle.xml.xsql.XSQLPageRequest;

```

```
import oracle.xml.xsql.XSQLDocumentSerializer;
import org.apache.fop.apps.Driver;
import org.apache.log.output.NullOutputLogTarget;
/**
 * Tested with the FOP 0.20.3RC release from 19-Jan-2002
 */
public class XSQLFOPSerializer implements XSQLDocumentSerializer {
    private static final String PDFMIME = "application/pdf";
    public void serialize(Document doc, XSQLPageRequest env) throws Throwable {
        try {
            // First make sure we can load the driver
            Driver FOPDriver = new Driver();
            // Tell FOP not to spit out any messages by default.
            // You can modify this code to create your own FOP Serializer
            // that logs the output to one of many different logger targets
            // using the Apache LogKit API
            Logger logger=Hierarchy.getDefaultHierarchy().getLoggerFor("XSQLServlet");
            logger.setLogTargets(new LogTarget[]{new NullOutputLogTarget()});
            FOPDriver.setLogger(logger);
            // Some of FOP's messages appear to still use MessageHandler.
            MessageHandler.setOutputMethod(MessageHandler.NONE);
            // Then set the content type before getting the reader
            env.setContentType(PDFMIME);
            FOPDriver.setOutputStream(env.getOutputStream());
            FOPDriver.setRenderer(FOPDriver.RENDER_PDF); FOPDriver.render(doc);
        }
        catch (Exception e) {
            // Cannot write PDF output for the error anyway.
            // So maybe this stack trace will be useful info
            e.printStackTrace(System.err);
        }
    }
}
```

17.8 Performing XSQL Customizations

XSQL customization topics are presented.

Topics:

- [Writing Custom XSQL Action Handlers](#) (page 17-18)
- [Implementing Custom XSQL Serializers](#) (page 17-22)
- [Using a Custom XSQL Connection Manager for JDBC Data Sources](#) (page 17-25)
- [Writing Custom XSQL Connection Managers](#) (page 17-26)
- [Implementing a Custom XSQLErrorHandler](#) (page 17-27)
- [Providing a Custom XSQL Logger Implementation](#) (page 17-28)

17.8.1 Writing Custom XSQL Action Handlers

The XSQL pages engine processes an XSQL page by looking for action elements from the `xsql` namespace and invoking an appropriate action element handler class to process each action. The processor supports any action that implements the `XSQLActionHandler` interface. All of the built-in actions implement this interface.

When a task requires custom processing, and none of the built-in actions listed in [Table 32-2](#) (page 32-3) does exactly what you need, you can write your own actions.

The XSQL engine processes the actions in a page in the following way. For each action in the page, the engine performs these steps:

1. Constructs an instance of the action handler class using the default constructor
2. Initializes the handler instance with the action element object and the page processor context by invoking the method `init(Element actionElt, XSQLPageRequest context)`
3. Invokes the method that allows the handler to handle the action `handleAction(Node result)`

For built-in actions, the engine can map the XSQL action element name to the Java class that implements the handler of the action. [Table 32-2](#) (page 32-3) lists the built-in actions and their corresponding classes.

For user-defined actions, use this built-in action, replacing `fully.qualified.Classname` with the name of your class:

```
<xsql:action handler="fully.qualified.Classname" ... />
```

The `handler` attribute provides the fully qualified name of the Java class that implements the custom action handler.

17.8.1.1 Implementing the XSQLActionHandler Interface

To create a custom action handler, provide a class that implements

`oracle.xml.xsql.XSQLActionHandler` interface

`oracle.xml.xsql.XSQLActionHandler`. Most custom action handlers extend `oracle.xml.xsql.XSQLActionHandlerImpl`, which provides a default implementation of the `init()` method and offers useful helper methods.

When an action handler's `handleAction()` method is invoked by the XSQL pages processor, a DOM fragment is passed to the action implementation. The action handler appends any dynamically created XML content returned to the page to the root node.

The XSQL processor conceptually replaces the action element in the XSQL page with the content of this document fragment. It is legal for an action handler to append nothing to this fragment if it has no XML content to add to the page.

While writing your custom action handlers, some methods on the `XSQLActionHandlerImpl` class are helpful. [Table 17-2](#) (page 17-19) lists these methods.

Table 17-2 *Helpful Methods in the XSQLActionHandlerImpl Class*

Method Name	Description
<code>getActionElement</code>	Returns the current action element being handled.
<code>getActionElementContent</code>	Returns the text content of the current action element, with all lexical parameters substituted appropriately.

Table 17-2 (Cont.) Helpful Methods in the XSQLActionHandlerImpl Class

Method Name	Description
<code>getPageRequest</code>	<p>Returns the current XSQL pages processor context. Using this object you do this:</p> <ul style="list-style-type: none"> • <code>setPageParam()</code> Set a page parameter value. • <code>getPostedDocument()/setPostedDocument()</code> Get or set the posted XML document. • <code>translateURL()</code> Translate a relative URL to an absolute URL. • <code>getRequestObject()/setRequestObject()</code> Get or set objects in the page request context that can be shared across actions in a single page. • <code>getJDBCConnection()</code> Gets the JDBC connection in use by this page (possible null if no connection in use). • <code>getRequestType()</code> Detect whether you are running in the Servlet, Command Line, or Programmatic context. For example, if the request type is Servlet then you can cast the <code>XSQLPageRequest</code> object to the more specific <code>XSQLServletPageRequest</code> to access servlet-specific methods such as <code>getHttpServletRequest</code>, <code>getHttpServletResponse</code>, and <code>getServletContext</code>.
<code>getAttributeAllowingParam</code>	<p>Retrieves the attribute value from an element, resolving any XSQL lexical parameter references that might appear in value of the attribute. Typically this method is applied to the action element itself, but it is also useful for accessing attributes of subelements. To access an attribute value without allowing lexical parameters, use the standard <code>getAttribute()</code> method on the <code>DOM Element</code> interface.</p>
<code>appendSecondaryDocument</code>	<p>Appends the contents of an external XML document to the root of the action handler result content.</p>
<code>addResultElement</code>	<p>Simplifies appending a single element with text content to the root of the action handler result content.</p>
<code>firstColumnOfFirstRow</code>	<p>Returns the first column value of the first row of a SQL statement. Requires the current page to have a connection attribute on its document element, or an error is returned.</p>
<code>getBindVariableCount</code>	<p>Returns the number of tokens in the space-delimited list of <code>bind-params</code>. This number indicates how many bind variables are expected to be bound to parameters.</p>
<code>handleBindVariables</code>	<p>Manages the binding of JDBC bind variables that appear in a prepared statement with the parameter values specified in the <code>bind-params</code> attribute on the current action element. If the statement is already using several bind variables before invoking this method, you can pass the number of existing bind variable slots in use as well.</p>

Table 17-2 (Cont.) Helpful Methods in the XSQLActionHandlerImpl Class

Method Name	Description
<code>reportErrorIncludingStatement</code>	Reports an error. The error includes the offending (SQL) statement that caused the problem and optionally includes a numeric error code.
<code>reportFatalError</code>	Reports a fatal error.
<code>reportMissingAttribute</code>	Reports an error that a required action handler attribute is missing by using the <code><xsql-error></code> element.
<code>reportStatus</code>	Reports action handler status by using the <code><xsql-status></code> element.
<code>requiredConnectionProvided</code>	Checks whether a connection is available for this request and outputs an errorgram into the page if no connection is available.
<code>variableValue</code>	Returns the value of a lexical parameter, taking into account all scoping rules that might determine its default value.

[Example 17-19](#) (page 17-21) shows a custom action handler named `MyIncludeXSQLHandler` that leverages a built-in action handler. It uses arbitrary Java code to modify the XML fragment returned by this handler before appending its result to the XSQL page.

You might have to write custom action handlers that work differently based on whether the page is requested through the XSQL servlet, the XSQL command-line utility, or programmatically through the `XSQLRequest` class. You can invoke `getPageRequest()` in your action handler implementation to get a reference to the `XSQLPageRequest` interface for the current page request. By invoking `getRequestType()` on the `XSQLPageRequest` object, you can determine whether the request is coming from the Servlet, Command Line, or Programmatic routes. If the return value is `Servlet`, then you can access the HTTP servlet request, response, and servlet context objects as shown in [Example 17-20](#) (page 17-22).

Example 17-19 `MyIncludeXSQLHandler.java`

```
import oracle.xml.xsql.*;
import oracle.xml.xsql.actions.XSQLIncludeXSQLHandler;
import org.w3c.dom.*;
import java.sql.SQLException;
public class MyIncludeXSQLHandler extends XSQLActionHandlerImpl {
    XSQLActionHandler nestedHandler = null;
    public void init(XSQLPageRequest req, Element action) {
        super.init(req, action);
        // Create an instance of an XSQLIncludeXSQLHandler and init() the handler by
        // passing the current request/action. This assumes the XSQLIncludeXSQLHandler
        // will pick up its href="xxx.xsql" attribute from the current action element.
        nestedHandler = new XSQLIncludeXSQLHandler();
        nestedHandler.init(req,action);
    }
    public void handleAction(Node result) throws SQLException {
        DocumentFragment df=result.getOwnerDocument().createDocumentFragment();
        nestedHandler.handleAction(df);
        // Custom Java code here can work on the returned document fragment
    }
}
```

```

    // before appending the final, modified document to the result node.
    // For example, add an attribute to the first child.
    Element e = (Element)df.getFirstChild();
    if (e != null) {
        e.setAttribute("ExtraAttribute", "SomeValue");
    }
    result.appendChild(df);
}
}

```

Example 17-20 Testing for the Servlet Request

```

XSQLServletPageRequest xspr = (XSQLServletPageRequest)getPageRequest();
if (xspr.getRequestType().equals("Servlet")) {
    HttpServletRequest req = xspr.getHttpServletRequest();
    HttpServletResponse resp = xspr.getHttpServletResponse();
    ServletContext cont = xspr.getServletContext();
    // Do something here with req, resp, or cont. Note that writing to the response
    // directly from a handler produces unexpected results. All the servlet or your
    // custom Serializer to write to the servlet response output stream at the right
    // moment later when all action elements have been processed.
}

```

17.8.1.2 Using Multivalued Parameters in Custom XSQL Actions

`XSQLActionHandlerImpl` is the base class for custom XSQL actions.

It supports:

- Array-named lexical parameter substitution
- Array-named bind variables
- Simple-valued parameters

If your custom actions use methods such as `getAttributeAllowingParam()`, `getActionElementContent()`, or `handleBindVariables()` from this base class, you pick up multivalued parameter functionality for free in your custom actions.

Use the `getParameterValues()` method on the `XSQLPageRequest` interface to explicitly get a parameter value as a `String[]`. The helper method `variableValues()` in `XSQLActionHandlerImpl` enables you to use this functionality from within a custom action handler if you must do so programmatically.

17.8.2 Implementing Custom XSQL Serializers

You can implement a user-defined serializer class to control how the final XSQL datapage is serialized to a text or binary stream. A user-defined serializer must implement interface `oracle.xml.xsql.XSQLDocumentSerializer`.

Interface `oracle.xml.xsql.XSQLDocumentSerializer` contains this single method:

```
void serialize(org.w3c.dom.Document doc, XSQLPageRequest env) throws Throwable;
```

Only DOM-based serializers are supported. A custom serializer class is expected to perform these steps:

1. Set the content type of the serialized stream before writing any content to the output `PrintWriter` (or `OutputStream`).

Set the type by invoking `setContentType()` on the `XSQLPageRequest` passed to your serializer. When setting the content type, you can set a MIME type:

```
env.setContentType("text/html");
```

Alternatively, you can set a MIME type with an explicit output encoding character set:

```
env.setContentType("text/html;charset=Shift_JIS");
```

2. Invoke either `getWriter()` or `getOutputStream()` (but not both) on the `XSQLPageRequest` to get the appropriate `PrintWriter` or `OutputStream` for serializing the content.

The custom serializer in [Example 17-21](#) (page 17-23) shows a simple implementation that serializes an HTML document containing the name of the document element of the current XSQL data page.

Example 17-21 Custom Serializer

```
package oracle.xml.xsql.serializers;
import org.w3c.dom.Document;
import java.io.PrintWriter;
import oracle.xml.xsql.*;

public class XSQLSampleSerializer implements XSQLDocumentSerializer {
    public void serialize(Document doc, XSQLPageRequest env) throws Throwable {
        String encoding = env.getPageEncoding(); // Use same encoding as XSQL page
                                                // template. Set to specific
                                                // encoding if necessary

        String mimeType = "text/html"; // Set this to the appropriate content type
        // (1) Set content type using the setContentType on the XSQLPageRequest
        if (encoding != null && !encoding.equals("")) {
            env.setContentType(mimeType+";charset="+encoding);
        }
        else {
            env.setContentType(mimeType);
        }
        // (2) Get the output writer from the XSQLPageRequest
        PrintWriter e = env.getWriter();
        // (3) Serialize the document to the writer
        e.println("<html>Document element is <b>"+
            doc.getDocumentElement().getNodeName()+"</b></html>");
    }
}
```

17.8.2.1 Techniques for Using a Custom Serializer

There are two ways to use a custom serializer, depending on whether you must first perform an XSLT transformation before serializing.

To perform an XSLT transformation before using a custom serializer, add the `serializer="java:fully.qualified.ClassName"` in the `<?xml-stYLESHEET?>` processing instruction at the top of your page. The following examples shows this technique:

```
<?xml version="1.0?>
<?xml-stYLESHEET type="text/xsl" href="mystyle.xsl"
    serializer="java:my.pkg.MySerializer"?>
```

If you need only the custom serializer, omit the `type` and `href` attributes. The following example shows this technique:

```
<?xml version="1.0?>
<?xml-stylesheet serializer="java:my.pkg.MySerializer"?>
```

17.8.2.2 Assigning a Short Name to a Custom Serializer

You can assign a short name to your custom serializers in the `<serializerdefs>` section of the XSQL configuration file. You can then use the short name in the `serializer` attribute, to save typing. The short name is case-sensitive.

Assume that you have the information shown in [Example 17-22](#) (page 17-24) in your XSQL configuration file. You can use the short names "Sample" or "FOP" in a stylesheet instruction:

```
<?xml-stylesheet type="text/xsl" href="emp-to-xslfo.xsl" serializer="FOP"?>
<?xml-stylesheet serializer="Sample"?>
```

The `XSQLPageRequest` interface supports both a `getWriter()` and a `getOutputStream()` method. Custom serializers can invoke `getOutputStream()` to return an `OutputStream` instance into which binary data can be serialized. When you use the XSQL servlet, writing to this output stream writes binary information to the servlet output stream.

The serializer shown in [Example 17-23](#) (page 17-24) shows an example of writing a dynamic GIF image. In this example the GIF image is a static "ok" icon, but it shows the basic technique that a more sophisticated image serializer must use.

Using the XSQL command-line utility, the binary information is written to the target output file. Using the `XSQLRequest` API, two constructors exist that allow the caller to supply the target `OutputStream` to use for the results of page processing.

Your serializer must either invoke `getWriter()` for textual output or `getOutputStream()` for binary output but not both. Invoking both in the same request raises an error.

Example 17-22 Assigning Short Names to Custom Serializers

```
<XSQLConfig>
  <!--and so on. -->
  <serializerdefs>
    <serializer>
      <name>Sample</name>
      <class>oracle.xml.xsql.serializers.XSQLSampleSerializer</class>
    </serializer>
    <serializer>
      <name>FOP</name>
      <class>oracle.xml.xsql.serializers.XSQLFOPSerializer</class>
    </serializer>
  </serializerdefs>
</XSQLConfig>
```

Example 17-23 Writing a Dynamic GIF Image

```
package oracle.xml.xsql.serializers;
import org.w3c.dom.Document;
import java.io.*;
import oracle.xml.xsql.*;

public class XSQLSampleImageSerializer implements XSQLDocumentSerializer {
  // Byte array representing a small "ok" GIF image
  private static byte[] okGif =
    { (byte)0x47, (byte)0x49, (byte)0x46, (byte)0x38,
      (byte)0x39, (byte)0x61, (byte)0xB, (byte)0x0,
```

```

(byte)0x9, (byte)0x0, (byte)0xFFFFFFFF80, (byte)0x0,
(byte)0x0, (byte)0x0, (byte)0x0, (byte)0x0,
(byte)0xFFFFFFFF, (byte)0xFFFFFFFF, (byte)0xFFFFFFFF, (byte)0x2C,
(byte)0x0, (byte)0x0, (byte)0x0, (byte)0x0,
(byte)0xB, (byte)0x0, (byte)0x9, (byte)0x0,
(byte)0x0, (byte)0x2, (byte)0x14, (byte)0xFFFFFFFF8C,
(byte)0xF, (byte)0xFFFFFFFFA7, (byte)0xFFFFFFFFB8, (byte)0xFFFFFFFF9B,
(byte)0xA, (byte)0xFFFFFFFFA2, (byte)0x79, (byte)0xFFFFFFFFE9,
(byte)0xFFFFFFFF85, (byte)0x7A, (byte)0x27, (byte)0xFFFFFFFF93,
(byte)0x5A, (byte)0xFFFFFFFFE3, (byte)0xFFFFFFFFEC, (byte)0x75,
(byte)0x11, (byte)0xFFFFFFFF85, (byte)0x14, (byte)0x0,
(byte)0x3B};

public void serialize(Document doc, XSQLPageRequest env) throws Throwable {
    env.setContentType("image/gif");
    OutputStream os = env.getOutputStream();
    os.write(okGif, 0, okGif.length);
    os.flush();
}
}

```

17.8.3 Using a Custom XSQL Connection Manager for JDBC Data Sources

As an alternative to defining your named connections in the XSQL configuration file, you can use one of two `XSQLConnectionManager` implementations provided. These let you use your servlet container's JDBC data source implementation and related connection pooling features.

This XSQL pages framework provides this alternative connection manager implementations:

- `oracle.xml.xsql.XSQLDataSourceConnectionManager`

Consider using this connection manager if your servlet container's data source implementation does *not* use the Oracle JDBC driver. Features of the XSQL pages system such as `<xsql:ref-cursor-function>` and `<xsql:include-owa>` are not available when you do not use an Oracle JDBC driver.

- `oracle.xml.xsql.XSQLOracleDataSourceConnectionManager`

Consider using this connection manager when your data source implementation returns JDBC `PreparedStatement` and `CallableStatement` objects that implement the `oracle.jdbc.PreparedStatement` and `oracle.jdbc.CallableStatement` interfaces. The Oracle WebLogic Server has a data source implementation that performs this task.

When using either of the preceding alternative connection manager implementations, the value of the connection attribute in your XSQL page template is the Java Naming and Directory Interface (JNDI) name used to look up your desired data source. For example, the value of the connection attribute might look like:

- `jdbc/scottDS`
- `java:comp/env/jdbc/MyDataSource`

If you are not using the default XSQL pages connection manager, then needed connection pooling functionality must be provided by the alternative connection manager implementation. In the case of the preceding two options based on JDBC data sources, you must properly configure your servlet container to supply the connection

pooling. See your servlet container documentation for instructions on how to properly configure the data sources to offer pooled connections.

17.8.4 Writing Custom XSQL Connection Managers

You can provide a custom connection manager to replace the built-in connection management mechanism.

To provide a custom connection manager implementation, you must perform these steps:

1. Write a connection manager factory class that implements the `oracle.xml.xsql.XSQLConnectionFactory` interface.
2. Write a connection manager class that implements the `oracle.xml.xsql.XSQLConnectionManager` interface.
3. Change the name of the `XSQLConnectionFactory` class in your XSQL configuration file.

The XSQL servlet uses your connection management scheme instead of the XSQL pages default scheme.

You can set your custom connection manager factory as the default connection manager factory by providing the class name in the XSQL configuration file. Set the factory in this section:

```
<!--
| Set the name of the XSQL Connection Manager Factory
| implementation. The class must implement the
| oracle.xml.xsql.XSQLConnectionFactory interface.
| If unset, the default is to use the built-in connection
| manager implementation in
| oracle.xml.xsql.XSQLConnectionFactoryImpl
+-->
<connection-manager>
  <factory>oracle.xml.xsql.XSQLConnectionFactoryImpl</factory>
</connection-manager>
```

In addition to specifying the default connection manager factory, you can associate a custom connection factory with a `XSQLRequest` object by using APIs provided.

The responsibility of the `XSQLConnectionFactory` is to return an instance of an `XSQLConnectionManager` for use by the current request. In a multithreaded environment such as a servlet engine, the `XSQLConnectionManager` object must ensure that a single `XSQLConnection` instance is not used by two different threads. This aim is realized by marking the connection as in use for the time between the `getConnection()` and `releaseConnection()` method invocations. The default XSQL connection manager implementation automatically pools named connections and adheres to this thread-safe policy.

If your custom implementation of `XSQLConnectionManager` implements the optional `oracle.xml.xsql.XSQLConnectionManagerCleanup` interface, then your connection manager can clean up any resources it has allocated. For example, if your servlet container invokes the `destroy()` method on the `XSQLServlet` servlet, which can occur during online administration of the servlet for example, the connection manager has a chance to clean up resources as part of the servlet destruction process.

17.8.4.1 Accessing Authentication Information in a Custom Connection Manager

To use the HTTP authentication mechanism to get the user name and password to connect to the database, write a customized connection manager. You can then invoke a `getConnection()` method to get the needed information.

You can write a Java program that follows these steps:

1. Pass an instance of the `oracle.xml.xsql.XSQLPageRequest` interface to the `getConnection()` method.
2. Invoke `getRequestType()` to ensure that the request type is `Servlet`.
3. Cast the `XSQLPageRequest` object to an `XSQLServletPageRequest`.
4. Invoke `getHttpServletRequest()` on the result of the preceding step.
5. Get the authentication information from the `javax.servlet.http.HttpServletRequest` object returned by the previous invocation.

17.8.5 Implementing a Custom XSQLExceptionHandler

You can control how serious page processor errors such as an unavailable connection are reported to users by implementing interface `oracle.xml.xsql.XSQLExceptionHandler`.

The interface contains this single method signature:

```
public interface XSQLExceptionHandler {
    public void handleError( XSQLException err, XSQLPageRequest env);
}
```

You can provide a class that implements the `XSQLExceptionHandler` interface to customize how the XSQL pages processor writes error messages. The new `XSQLException` object encapsulates the error information and provides access to the error code, formatted error message, and so on.

[Example 17-24](#) (page 17-28) shows a sample implementation of `XSQLExceptionHandler`.

You can control which custom `XSQLExceptionHandler` implementation is used in these distinct ways:

- Define the name of a custom `XSQLExceptionHandler` implementation class in the XSQL configuration file. You must provide the fully qualified class name of your error handler class as the value of the `/XSQLConfig/processor/error-handler/class` entry.

If the XSQL processor can load this class, and if it correctly implements the `XSQLExceptionHandler` interface, then it uses this class as a singleton and replaces the default implementation globally wherever page processor errors are reported.

- Override the error writer on a per page basis by using the `errorHandler` (or `xsql:errorHandler`) attribute on the document element of the page. The attribute value is the fully qualified class name of a class that implements the `XSQLExceptionHandler` interface. This class reports the errors only for this page. The class is instantiated on each page request by the page engine.

You can use a combination of the preceding approaches if needed.

Example 17-24 myErrorHandler class

```

package example;
import oracle.xml.xsql.*;
import java.io.*;
public class myErrorHandler implements XSQLExceptionHandler {
    public void logError( XSQLException err, XSQLPageRequest env) {
        // Must set the content type before writing anything out
        env.setContentType("text/html");
        PrintWriter pw = env.getErrorWriter();
        pw.println("<H1>ERROR</H1><hr>" + err.getMessage());
    }
}

```

17.8.6 Providing a Custom XSQL Logger Implementation

You can optionally register custom code to handle the logging of the start and end of each XSQL page request. Your custom logger code must provide an implementation of interfaces `oracle.xml.xsql.XSQLLoggerFactory` and `oracle.xml.xsql.XSQLLogger`.

The `XSQLLoggerFactory` interface contains this single method:

```

public interface XSQLLoggerFactory {
    public XSQLLogger create( XSQLPageRequest env);
}

```

You can provide a class that implements the `XSQLLoggerFactory` interface to decide how `XSQLLogger` objects are created (or reused) for logging. The XSQL processor holds a reference to the `XSQLLogger` object returned by the factory for the duration of a page request. The processor uses it to log the start and end of each page request by invoking the `logRequestStart()` and `logRequestEnd()` methods.

The `XSQLLogger` interface is:

```

public interface XSQLLogger {
    public void logRequestStart(XSQLPageRequest env) ;
    public void logRequestEnd(XSQLPageRequest env);
}

```

The classes in [Example 17-25](#) (page 17-28) and [Example 17-26](#) (page 17-29) show a trivial implementation of a custom logger. The `XSQLLogger` implementation in [Example 17-25](#) (page 17-28) notes the time the page request started. It then logs the page request end by printing the name of the page request and the elapsed time to `System.out`.

The factory implementation is shown in [Example 17-26](#) (page 17-29).

To register a custom logger factory, edit the `XSQLConfig.xml` file and provide the name of your custom logger factory class as the content to the `/XSQLConfig/processor/logger/factory` element. [Example 17-27](#) (page 17-29) shows this technique.

By default, `<logger>` section is commented out. There is no default logger.

Example 17-25 SampleCustomLogger Class

```

package example;
import oracle.xml.xsql.*;
public class SampleCustomLogger implements XSQLLogger {
    long start = 0;
    public void logRequestStart(XSQLPageRequest env) {

```

```
        start = System.currentTimeMillis();
    }
    public void logRequestEnd(XSQLPageRequest env) {
        long secs = System.currentTimeMillis() - start;
        System.out.println("Request for " + env.getSourceDocumentURI()
            + " took "+ secs + "ms");
    }
}
```

Example 17-26 SampleCustomLoggerFactory Class

```
package example;
import oracle.xml.xsql.*;
public class SampleCustomLoggerFactory implements XSQLLoggerFactory {
    public XSQLLogger create(XSQLPageRequest env) {
        return new SampleCustomLogger();
    }
}
```

Example 17-27 Registering a Custom Logger Factory

```
<XSQLConfig>
:
  <processor>
:
    <logger>
      <factory>example.SampleCustomLoggerFactory</factory>
    </logger>
:
  </processor>
</XSQLConfig>
```

Part II

Oracle XML Developer's Kit for C

An explanation is given of how to use Oracle XML Developer's Kit (XDK) to develop C applications.

Topics:

- [Getting Started with Oracle XML Developer's Kit for C](#) (page 18-1)
- [Using the XSLT and XVM Processors for C](#) (page 19-1)
- [Using the XML Parser for C](#) (page 20-1)
- [Using Binary XML with C](#) (page 21-1)
- [Using the XML Schema Processor for C](#) (page 22-1)
- [Determining XML Differences Using C](#) (page 23-1)
- [Using SOAP with the Oracle XML Developer's Kit for C](#) (page 24-1)

Getting Started with Oracle XML Developer's Kit for C

An explanation is given of how to get started with Oracle XML Developer's Kit (XDK) for C.

Topics:

- [Installing XDK for C Components](#) (page 18-1)
- [Configuring the UNIX Environment for XDK for C Components](#) (page 18-2)
- [Configuring the Windows Environment for XDK C Components](#) (page 18-6)
- [Overview of the Unified C API](#) (page 18-12)
- [Globalization Support for the XDK for C Components](#) (page 18-13)

18.1 Installing XDK for C Components

XDK for C components are the building blocks for reading, manipulating, transforming, and validating Extensible Markup Language (XML). The XDK for C components are included with Oracle Database.

This chapter assumes that you have installed XDK with Oracle Database and also installed the demo programs on the Oracle Database Examples media. See [About Installing XDK](#) (page 1-17) for installation instructions and a description of the XDK directory structure.

The following set of examples shows the UNIX directory structure for the XDK demos and the libraries used by the XDK components. The subdirectories contain sample programs and data files for the XDK for C components.

[Example 18-1](#) (page 18-2) lists the main directories under the Oracle home directory for C.

The contents of each subdirectory under this main directory are listed individually.

The `bin` directory contains these components:

```
schema
xml
xmlcg
xsl
xvm
```

The `lib` directory contains these components:

```
libcore11.a
libcoresh11.so
libnls11.a
```

```
libunls11.a
libxml11.a
libxmlsh10.a
```

The `xdk` directory contains this demo subdirectory:

```
| demo/
| - c/
|   - dom/
|   - parser/
|   - sax/
|   - schema/
|   - webdav/
|   - xslt/
|   - xsltvml/
```

The `/xdk/demo/c` subdirectories contain sample programs and data files for XDK for C components. The chapters in [Oracle XML Developer's Kit for C](#) (page 1) explain how to use these programs to gain an understanding of the most important C features.

The `xdk` directory also contains this `include` subdirectory:

```
| include/
| oratypes.h
| oraxml.h
| oraxmlcg.h
| oraxsd.h
| xml.h
| xmlerr.h
| xmlotn.h
| xmlproc.h
| xmlsch.h
| xmlxptr.h
| xmlxsl.h
| xmlxvm.h
```

[Table 18-4](#) (page 18-5) in [Setting Up and Testing the XDK C Compile-Time Environment on UNIX](#) (page 18-5) describes the C header files.

See Also:

[Overview of XDK](#) (page 1-1) for a list of the XDK for C components

Example 18-1 Oracle XML Developer's Kit for C Libraries, Header Files, Utilities, and Demos

```
- $ORACLE_HOME
| - bin/
| - lib/
| - xdk/
```

18.2 Configuring the UNIX Environment for XDK for C Components

Topics here include component dependencies, environment variables, the runtime and compile-time environments, and the component version.

Topics:

- [XDK for C Component Dependencies on UNIX](#) (page 18-3)

- [Setting Up XDK for C Environment Variables on UNIX](#) (page 18-4)
- [Testing the XDK for C Runtime Environment on UNIX](#) (page 18-4)
- [Setting Up and Testing the XDK C Compile-Time Environment on UNIX](#) (page 18-5)
- [Verifying the XDK for C Component Version on UNIX](#) (page 18-6)

18.2.1 XDK for C Component Dependencies on UNIX

The C libraries described in this section are located in `$ORACLE_HOME/lib`.

XDK for C and C++ components are contained in this library:

```
libxml11.a
```

The following XDK components are contained in the library:

- XML parser, which checks an XML document for well-formedness, optionally validates it against a document type definition (DTD) or XML Schema, and supports Document Object Model (DOM) and Simple API for XML (SAX) interfaces for programmatic access
- Extensible Stylesheet Language Transformation (XSLT) processor, which transforms an XML document into another XML document
- XSLT compiler, which compiles XSLT stylesheets into byte code for use by the XSLT Virtual Machine (XSLT VM)
- XSLTVM, which is an XSLT transformation engine
- XML Schema processor, which validates XML files against an XML schema

[Table 18-1](#) (page 18-3) describes the Common Oracle Runtime Environment (CORE) and Globalization Support libraries on which XDK for C components (UNIX) depend.

Table 18-1 *Dependent Libraries of Oracle XML Developer's Kit for C Components on UNIX*

Component	Library	Description
CORE library	libcore11.a	Contains the C runtime functions that enable portability across platforms.
CORE Dynamic linking library	libcoresh11.so	C runtime library that supports dynamic linking on UNIX platforms.
Globalization Support common library	libnls11.a	Supports the 8-bit encoding of Unicode (UTF-8), 16-bit encoding of Unicode (UTF-16), and ISO-8859-1 character sets. This library depends on the environment to locate encoding and message files.
Globalization Support library for Unicode	libunls11.a	Supports the character sets described in <i>Oracle Database Globalization Support Guide</i> . This library depends on the environment to locate encoding and message files.

18.2.2 Setting Up XDK for C Environment Variables on UNIX

The UNIX environment variables required for use with XDK for C components is described.

Table 18-2 UNIX Environment Settings for Oracle XML Developer's Kit for C Components

Variable	Description	Setting
\$ORA_NLS10	Sets the location of the Globalization Support character-encoding definition files. The encoding files represent a subset of character sets available in Oracle Database.	Set to the location of the Globalization Support data files. Set the variable: setenv ORA_NLS10 \$ORACLE_HOME/nls/data
\$ORA_XML_MESG	Sets the location of the XML error message files. Files ending in .msb are machine-readable and required at run time. Files ending in .msg are human-readable and contain cause and action descriptions for each error.	Set to the path of the msg directory. For example: setenv ORA_XML_MESG \$ORACLE_HOME/xdk/msg
\$PATH	Sets the location of the XDK for C executables.	Set the PATH: setenv PATH \${PATH}:\${ORACLE_HOME}/bin

18.2.3 Testing the XDK for C Runtime Environment on UNIX

You can test XDK for C in your UNIX runtime environment by running a number of utilities.

These utilities are described in [Table 18-3](#) (page 18-4).

Table 18-3 Oracle XML Developer's Kit for C/C++ Utilities on UNIX

Executable	Directory	Description
schema	\$ORACLE_HOME/bin	C XML Schema validator See also Using the C XML Schema Processor Command-Line Utility (page 22-3)
xml	\$ORACLE_HOME/bin	C XML parser See also Using the C XML Parser Command-Line Utility (page 20-9)
xmlcg	\$ORACLE_HOME/bin	C++ class generator See also Using the XML C++ Class Generator Command-Line Utility (page 31-1)
xvm	\$ORACLE_HOME/bin	C XVM processor See also Using the XVM Processor Command-Line Utility (page 19-3)

Run these utilities with no options to display the usage help. Run the utilities with the -hh flag for complete usage information.

18.2.4 Setting Up and Testing the XDK C Compile-Time Environment on UNIX

How to set up and test the XDK C compile-time UNIX environment is described.

[Table 18-4](#) (page 18-5) describes the header files required for compilation of XDK for C components. These files are located in `$ORACLE_HOME/xdk/include`. Your runtime environment must be set up before you can compile your code.

Table 18-4 Header Files in the Oracle XML Developer's Kit for C Compile-Time Environment

Header File	Description
<code>oratypes.h</code>	Includes the private Oracle C data types.
<code>oraxml.h</code>	Includes the Oracle9i XML Open Reporting Application (ORA) data types and the public ORA APIs included in <code>libxml.a</code> (only for backward compatibility). Use <code>xml.h</code> instead.
<code>oraxmlcg.h</code>	Includes the C APIs for the C++ class generator (only for backward compatibility).
<code>oraxsd.h</code>	Includes the Oracle9i XML schema definition (XSD) validator data types and application programming interfaces (APIs)—only for backward compatibility.
<code>xml.h</code>	Handles the unified DOM APIs transparently, whether you use them through Oracle Call Interface (OCI) or standalone. It replaces <code>oraxml.h</code> , which is deprecated.
<code>xmlerr.h</code>	Includes the XML errors and their numbers.
<code>xmlotn.h</code>	Includes the other headers depending on whether you compile standalone or use OCI.
<code>xmlproc.h</code>	Includes the Oracle XML data types and XML public parser APIs in <code>libxml11.a</code> .
<code>xmlsch.h</code>	Includes the Oracle XSD validator public APIs.
<code>xmlptr.h</code>	Includes the XPointer data types and APIs, which are not currently documented or supported.
<code>xmlxsl.h</code>	Includes the XSLT processor data types and public APIs.
<code>xmlxvm.h</code>	Includes the XSLT compiler and VM data types and public APIs.

18.2.4.1 Testing the XDK for C Compile-Time Environment on UNIX

The simplest way to test XDK for C in your compile-time environment is to run the `make` utility on the sample programs, which are located on the Examples media rather than on the Oracle Database CD.

After installing the demos, they are located in `$ORACLE_HOME/xdk/demo/c`. A `README` in the same directory provides compilation instructions and usage notes.

Build and run the sample programs by executing these commands at the system prompt:

```
cd $ORACLE_HOME/xdk/demo/c
make
```

18.2.5 Verifying the XDK for C Component Version on UNIX

How to determine which version of XDK you have is explained.

To get the version of XDK you are working with, change to directory `$ORACLE_HOME/lib` and run this command:

```
strings libxml11.a | grep -i developers
```

18.3 Configuring the Windows Environment for XDK C Components

Topics here include component dependencies, setting environment variables, testing the runtime environment, setting up and testing the compile-time environment, and Visual C++ in Microsoft Visual Studio.

Topics:

- [XDK for C Component Dependencies on Windows](#) (page 18-6)
- [Setting Up XDK for C Environment Variables on Windows](#) (page 18-7)
- [Testing the XDK for C Runtime Environment on Windows](#) (page 18-7)
- [Setting Up and Testing the XDK for C Compile-Time Environment on Windows](#) (page 18-8)
- [Using the XDK for C Components and Visual C++ in Microsoft Visual Studio](#) (page 18-9)

18.3.1 XDK for C Component Dependencies on Windows

The C libraries described in this section are located in `%ORACLE_HOME%\lib`.

XDK for C components are contained in this library:

```
libxml11.dll
```

The following XDK components are contained in the library:

- XML parser
- XSLT processor
- XSLT compiler
- XSLT VM
- XML Schema processor

[Table 18-5](#) (page 18-7) describes the Oracle CORE and Globalization Support libraries on which XDK for C components (Windows) depend.

Table 18-5 *Dependent Libraries of Oracle XML Developer's Kit for C Components on Windows*

Component	Library	Description
CORE library	libcore11.dll	Contains the runtime functions that enable portability across platforms.
Globalization Support common library	libnls11.dll	Supports the UTF-8, UTF-16, and ISO-8859-1 character sets. This library depends on the environment to find encoding and message files.
Globalization Support library for Unicode	libunls11.dll	Supports the character sets described in <i>Oracle Database Globalization Support Guide</i> . This library depends on the environment to find encoding and message files.

18.3.2 Setting Up XDK for C Environment Variables on Windows

The Windows environment variables required for use with the XDK for C components are described.

Table 18-6 *Windows Environment Settings for Oracle XML Developer's Kit for C Components*

Variable	Description	Setting
%ORA_NLS10%	Sets the location of the Globalization Support character-encoding definition files. The encoding files represent a subset of character sets available in Oracle Database.	This variable must be set to the location of the Globalization Support data files. Set the variable: set ORA_NLS10=%ORACLE_HOME%\nls\data
%ORA_XML_MSG%	Sets the location of the XML error message files. Files ending in .msb are machine-readable and required at run time. Files ending in .msg are human-readable and contain cause and action descriptions for each error.	Set to the path of the msg directory. For example: set ORA_XML_MSG=%ORACLE_HOME%\xdk\msg
%PATH%	Sets the location of the XDK for C data definition languages (DLLs) and executables.	Set the PATH: path %path%;%ORACLE_HOME%\bin

18.3.3 Testing the XDK for C Runtime Environment on Windows

You can test XDK in your Microsoft Windows runtime environment by running a number of utilities.

These are described in [Table 18-7](#) (page 18-8).

Table 18-7 Oracle XML Developer's Kit for C/C++ Utilities on Windows

Executable	Directory	Description
schema.exe	%ORACLE_HOME%\bin	C XML Schema validator See also Using the C XML Schema Processor Command-Line Utility (page 22-3)
xml.exe	%ORACLE_HOME%\bin	C XML parser See also Using the C XML Parser Command-Line Utility (page 20-9)
xmlcg.exe	%ORACLE_HOME%\bin	C++ class generator See also Using the XML C++ Class Generator Command-Line Utility (page 31-1)
xvm.exe	%ORACLE_HOME%\bin	C XVM processor See also Using the XVM Processor Command-Line Utility (page 19-3)

Run these utilities with no options to display the usage help. Run the utilities with the `-hh` flag for complete usage information.

18.3.4 Setting Up and Testing the XDK for C Compile-Time Environment on Windows

You must set up your runtime environment before you can compile your code.

[Table 18-4](#) (page 18-5) in the section [Setting Up and Testing the XDK C Compile-Time Environment on UNIX](#) (page 18-5) describes the header files required for compilation of the C components on Windows. The relative file names are the same on both UNIX and Windows installations.

On Windows the header files are located in `%ORACLE_HOME%\xdk\include`.

18.3.4.1 Testing the XDK for C Compile-Time Environment on Windows

You can test XDK for C in your compile-time environment by compiling the demo programs.

These are located in `%ORACLE_HOME%\xdk\demo\c` after you install them from the Oracle Database Examples media. A `README` file in the same directory provides compilation instructions and usage notes. Before you compile the demo programs, edit the `Make.bat` files as described in [Editing the Make.bat Files on Windows](#) (page 18-8).

18.3.4.1.1 Editing the Make.bat Files on Windows

Each subfolder of folder `%ORACLE_HOME%\xdk\demo\c` contains a file `Make.bat`. Update the `Make.bat` file in each folder by adding the path of the libraries and the header files to the compile command. You need not edit the paths in section `:LINK` because `/libpath:%ORACLE_HOME%\lib` already points to the C libraries.

The section of a `Make.bat` file in [Example 18-2](#) (page 18-8) uses bold text to show the path that you must include.

Example 18-2 Editing an Oracle XML Developer's Kit for C Make.bat File on Windows

```
:COMPILE
set filename=%1
```

```

cl -c -Fo%filename%.obj %opt_flg% /DCRTAPI1=_cdecl /DCRTAPI2=_cdecl /nologo /Zl
/Gy /DWIN32 /D_WIN32 /DWIN_NT /DWIN32COMMON /D_DLL /D_MT /D_X86_1
/Doratext=OraText -I. -I..\..\..\include -I%ORACLE_HOME%\xdk\include %filename%.c
goto :EOF

:LINK
set filename=%1
link %link_dbg% /out:..\..\..\bin\%filename%.exe
/libpath:%ORACLE_HOME%\lib /libpath:..\..\..\lib
%filename%.obj oraxml10.lib user32.lib kernel32.lib msvcrt.lib ADVAPI32.lib
oldnames.lib winmm.lib

```

18.3.4.1.2 Setting the XDK for C Compiler Path on Windows

How to set the path for the `cl.exe` compiler on Microsoft Windows is described.

Demo file `make.bat` assumes that you are using the `cl.exe` compiler, which is freely available with the Microsoft .NET Framework Software Development Kit (SDK).

To set the path for the `cl.exe` compiler on Microsoft Windows, follow these steps:

1. In the **Start** menu, select **Settings** and then **Control Panel**.
2. Double-click **System**.
3. In the **System Properties** dialogue box, select the **Advanced** tab and click **Environment Variables**.
4. In **System variables**, select **Path** and click **Edit**.
5. Append the path of `cl.exe` to the `%PATH%` variable and click **OK**.

Build and run the sample programs by executing these commands at the system prompt:

```

cd %ORACLE_HOME%\xdk\demo\c
make

```

18.3.5 Using the XDK for C Components and Visual C++ in Microsoft Visual Studio

You can set up a project with a Visual C++ template and use it for the demos included in XDK.

18.3.5.1 Setting a Path for a Project in Visual C++ on Windows

Follow these steps to set the path for a project:

1. Open a project in Visual C++ and include the `*.c` files for your project.
2. Navigate to the **Project** menu and select **Properties**.
3. When Property Pages appear, expand **Configuration Properties** and select **VC++ Directories**.
4. Under **General** on the right side, select **Include Directories**.

Figure 18-1 The Property Pages

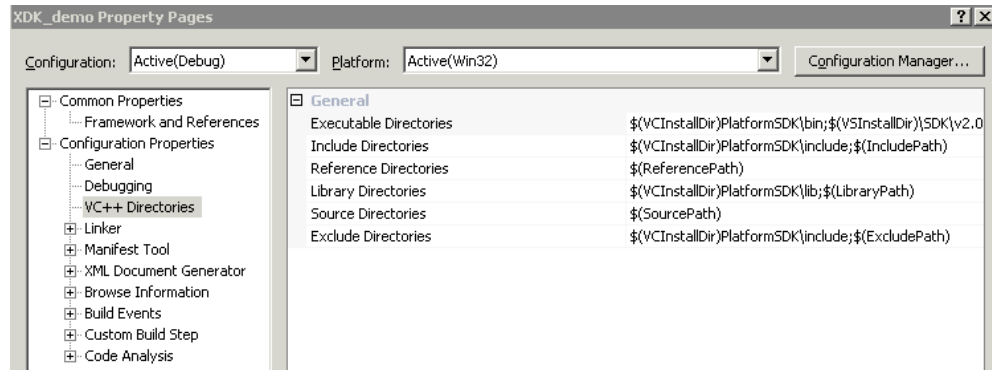

5. Click the arrow at the end of the line, and select the second line, which reads <Edit...>.
6. When the Include Directories window appears, click **New Line** from the tool bar and enter this include path, %ORACLE_HOME%\xdk\include, as shown in the example in [Figure 18-2](#) (page 18-10) and click **OK**.

Figure 18-2 Setting the Include Path in Visual C++

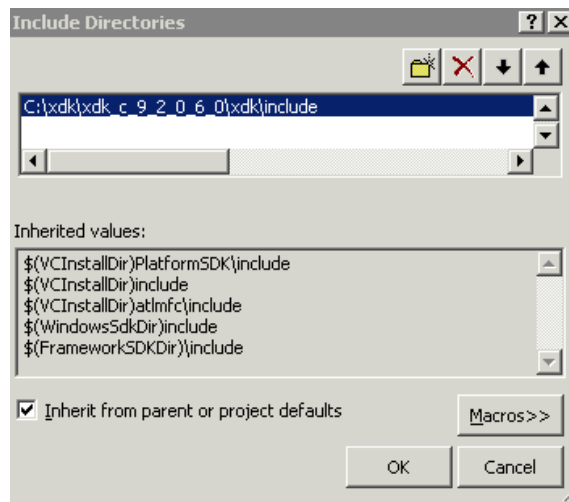

18.3.5.2 Setting the Library Path in Visual C++ on Windows

Follow these steps to set the library path for a project:

1. Open a project in Visual C++ and include the *.c files for your project.
2. Navigate to the **Project** menu and select **Properties**.
3. When Property Pages appear, expand **Configuration Properties** and select **VC++ Directories**.
4. Under **General** on the right side, select **Library Directories**.
5. Click the arrow at the end of the line, and select the second line which reads <Edit...>.

- When the Library Directories window appears, click **New Line** from the tool bar and enter this library path, `%ORACLE_HOME%\lib`, as shown in the example in [Figure 18-3](#) (page 18-11) and click **OK**.

Figure 18-3 Setting the Static Library Path in Visual C++

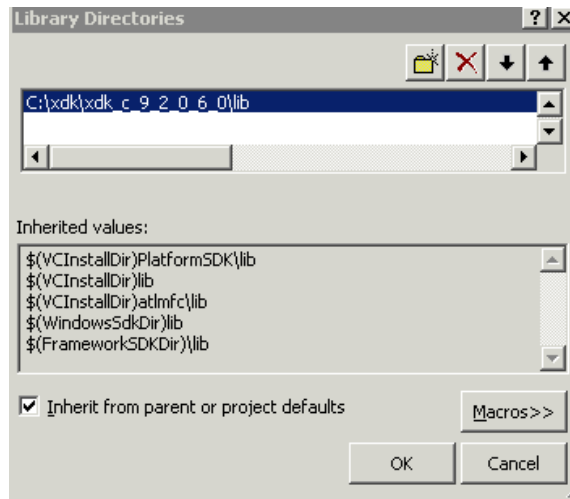

- After setting the paths for the static libraries in `%ORACLE_HOME%\lib`, navigate to the **Project** menu and select **Properties**.
- In the Properties Page, select and expand **Linker** under **Configuration Properties**, and select **Input**.
- Select **Additional Dependencies** and click the arrow at the end of the line. Select the second line which reads `<Edit...>`.
- Enter these additional dependencies: `oraxml9.lib`, `oraxmlg9.lib`, and `oraxsd9.lib` as shown in [Figure 18-4](#) (page 18-11) and click **OK**.

Figure 18-4 Setting the Names of the Libraries in Visual C++ Project

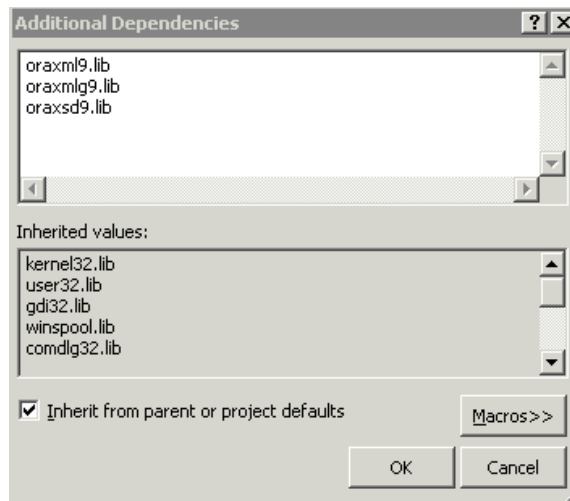

18.4 Overview of the Unified C API

The **unified C API** is a programming interface that unifies the functionality required by both XDK for C and Oracle XML DB. This API is used primarily by XSLT and XML Schema.

As shown in [Table 18-4](#) (page 18-5), the unified C API is declared in the `xml.h` header file. [Table 18-8](#) (page 18-12) summarizes the XDK for C APIs. See *Oracle Database XML C API Reference* for complete documentation.

Table 18-8 Summary of Oracle XML Developer's Kit for C APIs

Package	Purpose
Callback APIs	Define macros that declare functions (or function pointers) for XML callbacks.
DOM APIs	Parse and manipulate XML documents with DOM. The API follows the DOM 2.0 standard as closely as possible, although it changes some names when mapping from the objected-oriented DOM specification to the flat C namespace. For example, the overloaded <code>getName()</code> methods become <code>getAttribute()</code> .
Range APIs	Create and manipulate <code>Range</code> objects.
SAX APIs	Enable event-based XML parsing with SAX.
Schema APIs	Assemble multiple XML schema documents into a single schema that can be used to validate a specific instance document.
Traversal APIs	Enable document traversal and navigation of DOM trees.
XML APIs	Define an XML processor in terms of how it must read XML data and the information it must provide to the application.
XPath APIs	Process XPath-related types and interfaces.
XPointer APIs	Locate nodes in an XML document.
XSLT APIs	Perform XSL processing.
XSLTVM APIs	Implement a virtual machine that can run compiled XSLT code.

The API accomplishes the unification of the functions by conforming contexts. A top-level XML context (`xmlctx`) shares common information between cooperating XML components. This context defines information about:

- Data encoding
- Error message language
- Low-level allocation callbacks

An application needs this information before it can parse a document and provide programmatic access through DOM or SAX interfaces.

Both XDK for C and Oracle XML DB require different startup and tear-down functions for the top-level and service contexts. The initialization function takes implementation-specific arguments and returns a conforming context.

The unification is made possible by using conforming contexts. A conforming context means that the returned context must begin with a `xmlctx`; it may have any additional implementation-specific parts after the standard header.

After an application gets `xmlctx`, it uses unified DOM invocations, all of which take an `xmlctx` as the first argument.

18.5 Globalization Support for the XDK for C Components

The XDK for C parser supports over 300 IANA character sets.

These character sets include those listed in [Character Sets Supported by XDK for C](#) (page 33-6).

Considerations when working with character sets:

- Oracle recommends that you use Internet Assigned Numbers Authority (IANA) character set names for interoperability with other XML parsers.
- XML parsers are required only to support UTF-8 and UTF-16, so these character sets are preferable.
- The default input encoding ("incoding") is UTF-8. If an input document's encoding is not self-evident (by HTTP character set, Byte Order Mark (BOM), XMLDecl, and so on), then the default input encoding is assumed. Oracle recommends that you set the default encoding explicitly if using only single byte character sets such as US-ASCII or any of the ISO-8859 character sets because single-byte performance is fastest. The flag `XML_FLAG_FORCE_INCODING` specifies that the default input encoding is always applied to input documents, ignoring any BOM or XMLDecl. Nevertheless, a protocol declaration such as HTTP character set is always honored.
- Choose the data encoding for DOM and SAX ("outcoding") carefully. Single-byte encodings are the fastest, but can represent only a very limited set of characters. Next fastest is Unicode (UTF-16), and slowest are the multibyte encodings such as UTF-8. If input data cannot be converted to the outcoding without loss, then an error occurs. For maximum utility, use a Unicode-based outcoding because Unicode can represent any character. If outcoding is not specified, then it defaults to the incoding of the first document parsed.

Using the XSLT and XVM Processors for C

An explanation is given of how to use the Extensible Stylesheet Language Transformation (XSLT) and XSLT Virtual Machine (XVM) processors for C.

Topics:

- [XSLT XVM Processor](#) (page 19-1)
- [XSLT Processor for XDK for C](#) (page 19-3)
- [Using the Demo Files Included with the Software](#) (page 19-6)

Note:

Use the unified C application programming interface (API) for Oracle XML Developer's Kit (XDK) and Oracle XML DB applications. Older, nonunified C functions are deprecated and supported only for backward compatibility. They will be removed in a future release.

The unified C API is described in [Using the XML Parser for C](#) (page 20-1).

19.1 XSLT XVM Processor

The Oracle XVM package includes the XSLT compiler and the XVM. This package implements the XSLT language as specified in the World Wide Web Consortium (W3C) Recommendation of 16 November 1999.

Implementing the XSLT compiler and the XVM enables compilation of XSLT (Version 1.0) into bytecode format, which is executed by the virtual machine. XVM is the software implementation of a CPU designed to run compiled XSLT code. The virtual machine assumes a compiler compiling XSLT stylesheets to a sequence of bytecodes or machine instructions for the XSLT CPU. The bytecode program is a platform-independent sequence of 2-byte units. It can be stored, cached, and run on different XVMs. The XVM uses the bytecode programs to transform XML instance documents. This approach clearly separates compile-time from runtime computations and specifies a uniform way of exchanging data between instructions.

The benefits of this approach are:

- An XSLT stylesheet can be compiled, saved in a file, and reused often, even on different platforms.
- The XVM is significantly faster and uses less memory than other XSLT processors.
- The bytecodes are language independent. There is no difference between code generated from a C or C++ XSLT compiler.

19.1.1 XVM Usage Example

A typical scenario of using the package APIs is described.

1. Create and use an XML meta-context object.

```
xctx = XmlCreate(&err, ...);
```

2. Create and use an XSLT compiler object.

```
comp = XmlXvmCreateComp(xctx);
```

3. Compile an XSLT stylesheet or XPath expression and store or cache the resulting bytecode.

```
code = XmlXvmCompileFile(comp, xslFile, baseuri, flags, &err);
```

or

```
code = XmlXvmCompileDom (comp, xslDomdoc, flags, &err);
```

or

```
code = XmlXvmCompileXPath (comp, xpathexp, namespaces, &err);
```

4. Create and use an XVM object. The explicit stack size setting is needed when XVM terminates with a `Stack Overflow` message or when smaller memory footprints are required. See `XmlXvmCreate()`.

```
vm = XmlXvmCreate(xctx, "StringStack", 32, "NodeStack", 24, NULL);
```

5. Set the output (optional). Default is a stream.

```
err = XmlXvmSetOutputDom (vm, NULL);
```

or

```
err = XmlXvmSetOutputStream(vm, &xvm_stream);
```

or

```
err = XmlXvmSetOutputSax(vm, &xvm_callback, NULL);
```

6. Set a stylesheet bytecode to the XVM object. Can be repeated with other bytecode.

```
len = XmlXvmGetBytecodeLength(code, &err);  
err = XmlXvmSetBytecodeBuffer(vm, code, len);
```

or

```
err = XmlXvmSetBytecodeFile (vm, xslBytecodeFile);
```

7. Transform an instance XML document or evaluate a compiled XPath expression. Can be repeated with the same or other XML documents.

```
err = XmlXvmTransformFile(vm, xmlFile, baseuri);
```

or

```
err = XmlXvmTransformDom (vm, xmlDomdoc);
```

or

```
obj = (xvmobj*)XmlXvmEvaluateXPath (vm, code, 1, 1, node);
```

8. Get the output tree fragment (if DOM output is set at Step 5).

```
node = XmlXvmGetOutputDom (vm);
```

9. Delete the objects.

```
XmlXvmDestroy(vm);
XmlXvmDestroyComp(comp);
XmlDestroy(xctx);
```

19.1.2 Using the XVM Processor Command-Line Utility

The XVM processor is accessed from the command-line using command `xvm`.

```
xvm
```

Usage:

```
xvm options xslfile xmlfile
```

```
xvm options xpath xmlfile
```

Options:

```
-c      Compile xslfile. The bytecode is in "xmlfile.xvm".
-ct     Compile xslfile and transform xmlfile.
-t      Transform xmlfile using bytecode from xslfile.
-xc     Compile xpath. The bytecode is in "code.xvm".
-xct    Compile and evaluate xpath with xmlfile.
-xt     Evaluate XPath bytecode from xpath with xmlfile.
```

Examples:

```
xvm -ct db.xsl db.xml
xvm -t db.xvm db.xml
xvm -xct "doc/employee[15]/family" db.xml
```

19.1.3 Accessing the XVM Processor for C

Oracle XVM Processor for C is part of the standard installation of Oracle Database.

See Also:

- *Oracle Database XML C API Reference*, XSLTVM APIs for C
 - <http://www.oracle.com/technetwork/database-features/xdk/overview/index.html>
-
-

19.2 XSLT Processor for XDK for C

The Oracle XSL/XPath package implements the XSLT language as specified in the W3C Recommendation of 16 November 1999. The package includes the XSLT 1.0 processor and XPath 1.0 Processor. The Oracle implementation of the XSLT processor follows the common design approach of melding compiler and processor into one object.

See Also:

- <https://www.w3.org/TR/xslt/>
 - <http://www.w3.org/TR/xpath>
-

19.2.1 XSLT Processor Usage Example

A typical scenario of using the package APIs is presented.

1. Create and use an XML meta-context object.

```
xctx = XmlCreate(&err,...);
```

2. Parse the XSLT stylesheet.

```
xslDomdoc = XmlLoadDom(xctx, &err, "file", xslFile, "base_uri", baseuri, NULL);
```

3. Create an XSLT processor for the stylesheet

```
xslproc = XmlXslCreate (xctx, xslDomdoc, baseuri, &err);
```

4. Parse the instance XML document.

```
xmlDomdoc = XmlLoadDom(xctx, &err, "file", xmlFile, "base_uri", baseuri, NULL);
```

5. Set the output (optional). Default is Document Object Model (DOM).

```
err = XmlXslSetOutputStream(xslproc, &stream);
```

6. Transform the XML document. This step can be repeated with the same or other XML documents.

```
err = XmlXslProcess (xslproc, xmlDomdoc, FALSE);
```

7. Get the output (if DOM).

```
node = XmlXslGetOutput(xslproc);
```

8. Delete objects.

```
XmlXslDestroy(xslproc);  
XmlDestroy(xctx);
```

19.2.2 XPath Processor Usage Example

A typical scenario of using the package APIs is described.

Follow these steps:

1. Create and use an XML meta-context object.

```
xctx = XmlCreate(&err,...);
```

2. Parse the XML document or get the current node from already existing DOM.

```
node = XmlLoadDom(xctx, &err, "file", xmlFile, "base_uri", baseuri, NULL);
```

3. Create an XPath processor.

```
xpproc = XmlXPathCreateCtx(xctx, NULL, node, 0, NULL);
```

4. Parse the XPath expression.

```

    exp = XmlXPathParse (xptproc, xpathexpr, &err);
5. Evaluate the XPath expression.
    obj = XmlXPathEval(xptproc, exp, &err);
6. Delete the objects.
    XmlXPathDestroyCtx (xptproc);
    XmlDestroy(xctx);

```

19.2.3 Using the C XSLT Processor Command-Line Utility

You can call the C Oracle XSLT processor as an executable by invoking `bin/xsl`.

```

xsl [switches] stylesheet instance
or
xsl -f [switches] [document filespec]

```

If no stylesheet is provided, no output is generated. If there is a stylesheet, but no output file, output goes to `stdout`.

[Table 19-1](#) (page 19-5) lists the command line options.

Table 19-1 XSLT Processor for C: Command Line Options

Option	Description
<code>-B BaseUri</code>	Set the Base URI for XSLT processor: <code>BaseUri</code> of <code>http://pqr/xsl.txt</code> resolves <code>pqr.txt</code> to <code>http://pqr/pqr.txt</code>
<code>-e encoding</code>	Specify default input file encoding (<code>-ee</code> to force).
<code>-E encoding</code>	Specify DOM or Simple API for XML (SAX) encoding.
<code>-f</code>	File—interpret as filespec, not Universal Resource Identifier (URI).
<code>-G xptrexp</code>	Evaluates XPointer schema examples given in a file.
<code>-h</code>	Help—show this usage. (Use <code>-hh</code> for more options.)
<code>-hh</code>	Show complete options list.
<code>-i n</code>	Number of times to iterate the XSLT processing.
<code>-l language</code>	Language for error reporting.
<code>-o XSLoutfile</code>	Specifies output file of XSLT processor.

Table 19-1 (Cont.) XSLT Processor for C: Command Line Options

Option	Description
-v	Version—display parser version then exit.
-V <i>var value</i>	Test top-level variables in C XSLT.
-w	White Space—preserve all white space.
-W	Warning—stop parsing after a warning.

19.2.4 Accessing Oracle XSLT processor for C

Oracle XSLT processor for C is part of the standard installation of Oracle Database.

See Also:

- *Oracle Database XML C API Reference, XSLT APIs for C*
 - *Oracle Database XML C API Reference, XPath APIs for C*
 - <http://www.oracle.com/technetwork/database-features/xdk/overview/index.html>
-
-

19.3 Using the Demo Files Included with the Software

Directory `$ORACLE_HOME/xdk/demo/c/parser/` contains several XML applications that show how to use the XSLT for C.

Table 19-2 XSLT for C Demo Files

Sample File Name	Description
<code>XSLSample.c</code>	Source for <code>XSLSample</code> program.
<code>XSLSample.std</code>	Expected output from <code>XSLSample</code> .
<code>class.xml</code>	XML file that can be used with <code>XSLSample</code> .
<code>iden.xsl</code>	Stylesheet that can be used with <code>XSLSample</code> .
<code>cleo.xml</code>	XML version of Shakespeare's play.
<code>XVMSample.c</code>	Sample usage of XVM and compiler. It takes two file names as input—XML file and XSLT stylesheet file.
<code>XVMXPathSample.c</code>	Sample usage of XVM and compiler. It takes XML file name and XPath expression as input. Generates the result of the evaluated XPath expression.

Table 19-2 (Cont.) XSLT for C Demo Files

Sample File Name	Description
<code>XSLXPathSample.c</code>	Sample usage of XSL/XPath processor. It takes XML file name and XPath expression as input. Generates the result of the evaluated XPath expression.

19.3.1 Building the C Demo Programs for XSLT

Change directories to the demo directory and read the `README` file. That file explains how to build the sample programs according to your operating system.

Here is the usage of XSLT processor sample `XSLSample`, which takes two files as input, the XML file and the XSLT stylesheet:

```
XSLSample xmlfile xslss
```

Using the XML Parser for C

An explanation is given of how to use the Extensible Markup Language (XML) parser for C.

Topics:

- [Introduction to the XML Parser for C](#) (page 20-1)
- [Using the XML Parser API for C](#) (page 20-2)
- [Using the DOM API for C](#) (page 20-11)
- [Using orastream Functions](#) (page 20-13)
- [Using the SAX API for C](#) (page 20-16)
- [Using the XML Pull Parser for C](#) (page 20-16)
- [Using OCI and the XDK for C API](#) (page 20-21)

20.1 Introduction to the XML Parser for C

Topics here include prerequisites and standards for the XML parser for C.

Topics:

- [Prerequisites for Using the XML Parser for C](#) (page 20-1)
- [Standards and Specifications for the XML Parser for C](#) (page 20-2)

See Also:

[Introduction to XML Parsing for Java](#) (page 4-1) for a generic introduction to XML parsing with Document Object Model (DOM) and Simple API for XML (SAX). Much of the information in the introduction is language-independent and applies equally to C.

20.1.1 Prerequisites for Using the XML Parser for C

The Oracle XML parser for C reads an XML document and uses DOM or SAX application programming interfaces (APIs) to provide programmatic access to its content and structure. You can use the parser in validating or nonvalidating mode. A pull parser is also available.

This chapter assumes that you are familiar with these technologies:

- [Document Object Model \(DOM\)](#). DOM is an in-memory tree representation of the structure of an XML document.

- [Simple API for XML \(SAX\)](#). SAX is a standard for event-based XML parsing.
- [Using the XML Pull Parser for C](#) (page 20-16). Pull Parser uses XML events.
- [document type definition \(DTD\)](#). An XML DTD defines the legal structure of an XML document.
- [XML Schema](#). Like a DTD, an XML schema defines the legal structure of an XML document.
- [XML Namespaces](#). Namespaces are a mechanism for differentiating element and attribute names.

If you require a general introduction to the preceding technologies, consult the XML resources listed in [Related Documents](#) (page xxix).

20.1.2 Standards and Specifications for the XML Parser for C

XML 1.0 is a W3C Recommendation. The Oracle XML Developer's Kit (XDK) for C API provides full support for XML 1.0 (Second Edition).

You can find the specification for the Second Edition here:

<http://www.w3.org/TR/2000/REC-xml-20001006>

The DOM Level 1, Level 2, and Level 3 specifications are World Wide Web Consortium (W3C) Recommendations. The XDK for C API provides full support for DOM Level 1 and 2, but no support for Level 3. You can find links to the specifications for all three levels here:

<http://www.w3.org/DOM/DOMTR>

SAX is available in version 1.0, which is deprecated, and 2.0. SAX is not a W3C specification. The XDK for C API provides full support for both SAX 1.0 and 2.0. You can find the documentation for SAX here:

<http://www.saxproject.org>

XML Namespaces are a W3C Recommendation. You can find the specification here:

<http://www.w3.org/TR/REC-xml-names>

See Also:

[Oracle XML Developer's Kit Standards](#) (page 33-1) for a summary of the standards supported by XDK

20.2 Using the XML Parser API for C

Oracle XML parser for C checks if an XML document is well-formed, and optionally validates it against a DTD. Your application can access the parsed data through the DOM or SAX APIs.

20.2.1 Overview of the Parser API for C

The core of the XML parsing API are the XML, DOM, and SAX APIs.

[Table 20-1](#) (page 20-3) describes the interfaces for these APIs. See *Oracle Database XML C API Reference* for the complete API documentation.

Table 20-1 Interfaces for XML, DOM, and SAX APIs

Package	Interfaces	Function Name Convention
XML	<p>This package implements a single XML interface. The interface defines functions for these tasks:</p> <ul style="list-style-type: none"> • Creating and destroying contexts. A top-level XML context (<code>xmlctx</code>) shares common information between cooperating XML components. • Creating and parsing XML documents and DTDs. 	<p>Function names begin with the string <code>xml</code>.</p> <p>See <i>Oracle Database XML C API Reference</i> for API documentation.</p>
DOM	<p>This package provides programmatic access to parsed XML. The package implements these interfaces:</p> <ul style="list-style-type: none"> • <code>Attr</code> defines get and set functions for XML attributes. • <code>CharacterData</code> defines functions for manipulating character data. • <code>Document</code> defines functions for creating XML nodes, getting information about an XML document, and setting the DTD for a document. • <code>DocumentType</code> defines get functions for DTDs. • <code>Element</code> defines get and set functions for XML elements. • <code>Entity</code> defines get functions for XML entities. • <code>NamedNodeMap</code> defines get functions for named nodes. • <code>Node</code> defines get and set functions for XML nodes. • <code>NodeList</code> defines functions that free a node list and get a node from a list. • <code>Notation</code> defines functions that get the system and public ID from a node. • <code>ProcessingInstruction</code> defines get and set functions for processing instructions. • <code>Text</code> defines a function that splits a text node into two. 	<p>Function names begin with the string <code>xmlDom</code>.</p> <p>See <i>Oracle Database XML C API Reference</i> for API documentation.</p>
SAX	<p>This package provides programmatic access to parsed XML. The package implements the SAX interface, which defines functions that receive notifications for SAX events.</p>	<p>Function names begin with the string <code>xmlSax</code>.</p> <p>See <i>Oracle Database XML C API Reference</i> for API documentation.</p>
XML Pull Parser	<p>XML events is a representation of an XML document which is similar to SAX events in that the document is represented as a sequence of events like start tag, end tag, comment, and so on. The difference is that SAX events are driven by the parser (producer) and XML events are driven by the application (consumer).</p>	<p>Function names begin with the string <code>xmlEv</code>.</p> <p>See <i>Oracle Database XML C API Reference</i> for API documentation.</p>

20.2.1.1 XML Parser for C Data Types

The data types used in the XML parser for C are described.

See *Oracle Database XML C API Reference* for the complete list of data types for XDK for C.

Table 20-2 Data Types Used in the XML Parser for C

Data Type	Description
<code>oratext</code>	String pointer

Table 20-2 (Cont.) Data Types Used in the XML Parser for C

Data Type	Description
<code>xmlctx</code>	Master XML context
<code>xmlsaxcb</code>	SAX callback structure (SAX only)
<code>ub4</code>	32-bit (or larger) unsigned integer
<code>uword</code>	Native unsigned integer

20.2.1.2 XML Parser for C Defaults

The defaults for the XML parser for C are described.

These are the defaults:

- Character set encoding is 8-bit encoding of Unicode (UTF-8). If all your documents are ASCII, then setting the encoding to US-ASCII increases performance.
- The parser prints messages to `stderr` unless an error handler is provided.
- The parser checks inputs documents for well-formedness but not validity. You can set the property "validate" to validate the input.

Note:

Oracle recommends that you set the default encoding explicitly if using only single byte character sets (such as US-ASCII or any of the ISO-8859 character sets) for faster performance than is possible with multibyte character sets such as UTF-8.

- The parser conforms with the XML 1.0 specification when processing white space, that is, the parser reports all white space to the application but indicates which white space can be ignored. However, some applications may prefer to set the property "discard-white space," which discards all white space between an end-element tag and this start-element tag.

See Also:

- *Oracle Database XML C API Reference* for the DOM, SAX, pull parser, and callback APIs.
 - <http://www.oracle.com/technetwork/database-features/xdk/overview/index.html>
-
-

20.2.2 XML Parser for C Calling Sequence

The calling sequence for the XML parser for C is illustrated.

Figure 20-1 XML Parser for C Calling Sequence

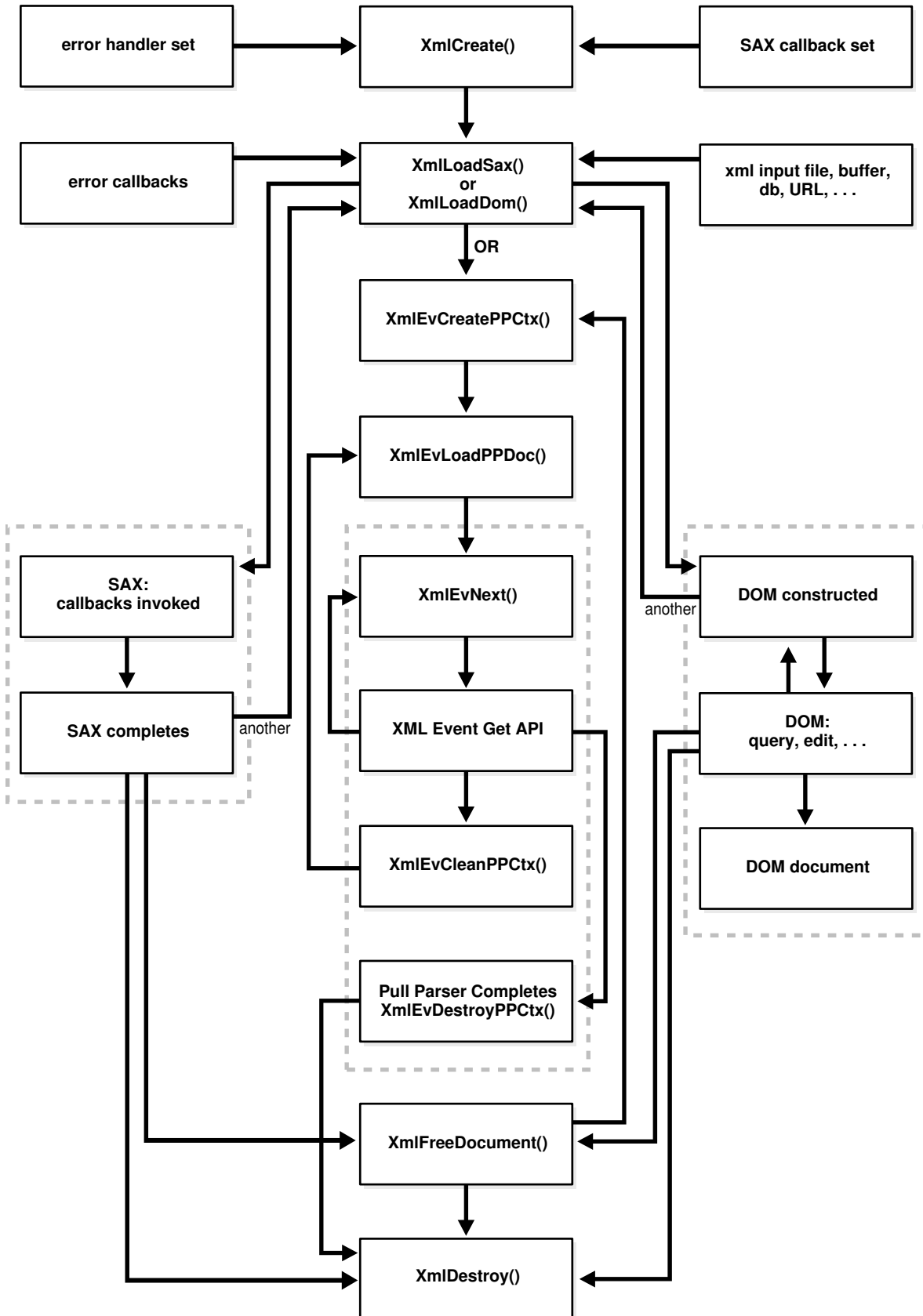

20.2.3 Using the XML Parser for C: Basic Process

The basic process for using the XML parser for C is described.

Perform these steps in your application:

1. Initialize the parsing process with the `XmlCreate()` function. The following sample code fragment is from `DOMNamespace.c`:

```
xmlctx      *xctx;
...
xctx = XmlCreate(&ecode, (oratext *) "namespace_xctx", NULL);
```

2. Parse the input item, which can be an XML document or string buffer.

If you are parsing with DOM, invoke the `XmlLoadDom()` function. The following sample code fragment is from `DOMNamespace.c`:

```
xmlDocNode *doc;
...
doc = XmlLoadDom(xctx, &ecode, "file", DOCUMENT,
                "validate", TRUE, "discard_whitespace", TRUE, NULL);
```

If you are parsing with SAX, invoke the `XmlLoadSax()` function. The following sample code fragment is from `SAXNamespace.c`:

```
xmlerr      ecode;
...
ecode = XmlLoadSax(xctx, &sax_callback, &sc, "file", DOCUMENT,
                 "validate", TRUE, "discard_whitespace", TRUE, NULL);
```

If you are using the pull parser, then include these steps to create the event context and load the document to parse:

```
evctx = XmlEvCreatePPCtx(xctx, &xerr, NULL);
XmlEvLoadPPDoc(xctx, evctx, "File", input_filenames[i], 0, NULL);
```

3. If you are using the DOM interface, then include these steps:
 - Use the `XmlLoadDom()` function to invoke `XmlDomGetDocElem()`. This step invokes other DOM functions, which are typically node or print functions that output the DOM document, as required. The following sample code fragment is from `DOMNamespace.c`:

```
printElements(xctx, XmlDomGetDocElem(xctx, doc));
```

- Invoke the `XmlFreeDocument()` function to clean up any data structures created during the parse process. The following sample code fragment is from `DOMNamespace.c`:

```
XmlFreeDocument(xctx, doc);
```

If you are using the SAX interface, then include these steps:

- Process the results of the invocation of `XmlLoadSax()` with a callback function, such as:

```
xmlsaxcb saxcb = {
    UserStartDocument, /* user's own callback functions */
    UserEndDocument,
    /* ... */
};
```

```
if (XmlLoadSax(xctx, &saxcb, NULL, "file", "some_file.xml", NULL) != 0)
    /* an error occurred */
```

- Register the callback functions. You can set any of the SAX callback functions to NULL if not needed.

If you are using the pull parser, iterate over the events using:

```
cur_event = XmlEvNext(evctx);
```

Use the Get APIs to get information about that event.

4. Use `XmlFreeDocument()` to clean up the memory and structures used during a parse. The program does not free memory allocated for parameters passed to the SAX callbacks or for nodes and data stored with the DOM parse tree until you invoke `XmlFreeDocument()` or `XmlDestroy()`. The following sample code fragment is from `DOMNamespace.c`:

```
XmlFreeDocument(xctx, doc);
```

Either return to Step 2 or proceed to the next step.

For the pull parser invoke `XmlEvCleanPPctx()` to release memory and structures used during the parse. The application can invoke `XmlEvLoadPPDoc()` again to parse another document. Or, it can invoke `XmlEvDestroyPPctx()` after which the pull parser context cannot be used again.

```
XmlEvCleanPPctx(xctx, evctx);
...
XmlEvDestroyPPctx(xctx, evctx);
```

5. Terminate the parsing process with `XmlDestroy()`. The following sample code fragment is from `DOMNamespace.c`:

```
(void) XmlDestroy(xctx);
```

If threads fork off somewhere in the sequence of invocations between initialization and termination, the application produces unpredictable behavior and results.

You can use the memory callback functions `XML_ALLOC_F` and `XML_FREE_F` for your own memory allocation. If you do, then specify both functions.

See Also:

[Using the XML Pull Parser for C](#) (page 20-16)

20.2.4 Running the XML Parser for C Demo Programs

The `$ORACLE_HOME/xdk/demo/c/` (UNIX) and `%ORACLE_HOME%\xdk\demo\c` (Windows) directories include several XML applications that show how to use the XML parser for C with the DOM and SAX interfaces.

[Table 20-3](#) (page 20-8) describes the demos.

The `make` utility compiles the source file `fileName.c` to produce the demo program `fileName.out`. The `fileName.std` is the expected output.

Table 20-3 C Parser Demos

Directory	Contents	Demos
dom	DOMNamespace. c DOMSample.c FullDom.c FullDom.xml NSEExample.xml Traverse.c XPointer.c class.xml cleo.xml pantry.xml	The following demo programs use the DOM API: <ul style="list-style-type: none"> • The DOMNamespace program uses Namespace extensions to the DOM API. It prints out all elements and attributes of NSEExample.xml along with full namespace information. • The DOMSample program uses DOM APIs to display an outline of <i>Cleopatra</i>, that is, the XML elements ACT and SCENE. The cleo.xml document contains the XML version of Shakespeare's <i>The Tragedy of Antony and Cleopatra</i>. • The FullDom program shows sample usage of the full DOM interface. It exercises all the invocations. The program accepts FullDom.xml, which shows the use of entities, as input. • The Traverse program shows the use of DOM iterators, tree walkers, and ranges. The program accepts the class.xml document, which describes a college Calculus course, as input. • The XPointer program shows the use of the XML Pointer Language by locating the children of the <pantry> element in pantry.xml.
sax	NSEExample.xml SAXNamespace. c SAXSample.c cleo.xml	The following demo programs use the SAX APIs: <ul style="list-style-type: none"> • The SAXNamespace program uses namespace extensions to the SAX API. It prints out all elements and attributes of NSEExample.xml along with full namespace information. • The SAXSample program uses SAX APIs to show all lines in the play <i>Cleopatra</i> containing a given word. If you do not specify a word, then it uses the word "death." The cleo.xml document contains the XML version of Shakespeare's <i>The Tragedy of Antony and Cleopatra</i>.

You can find documentation that describes how to compile and run the sample programs in the README in the same directory. The basic steps are:

1. Change into the \$ORACLE_HOME/xdk/demo/c directory (UNIX) or %ORACLE_HOME%\xdk\demo\c directory (Windows).
2. Make sure that your environment variables are set as described in [Setting Up XDK for C Environment Variables on UNIX](#) (page 18-4) and [Setting Up XDK for C Environment Variables on Windows](#) (page 18-7).
3. Run make (UNIX) or Make.bat (Windows) at the system prompt. The make utility changes into each demo subdirectory and runs make to do this:
 - a. Compiles the C source files with the cc utility. For example, the Makefile in the \$ORACLE_HOME/xdk/demo/c/dom directory includes these line:

```
$(CC) -o DOMSample $(INCLUDE) $@.c $(LIB)
```
 - b. Runs each demo program and redirects the output to a file. For example, the Makefile in the \$ORACLE_HOME/xdk/demo/c/dom directory includes this line:

```
./DOMSample > DOMSample.out
```
4. Compare the *.std files to the *.out files for each program. The *.std file contains the expected output for each program. For example, DOMSample.std contains the expected output from running DOMSample.

20.2.5 Using the C XML Parser Command-Line Utility

The `xml` utility, which is located in `$ORACLE_HOME/bin` (UNIX) or `%ORACLE_HOME%\bin` (Windows), is a command-line interface that parses XML documents. It checks for both well-formedness and validity.

To use `xml` ensure that your environment is set up as described in [Setting Up XDK for C Environment Variables on UNIX](#) (page 18-4) and [Setting Up XDK for C Environment Variables on Windows](#) (page 18-7).

Use this syntax on the command line to invoke `xml`. Use `xml.exe` for Windows:

```
xml [options] [document URI]
xml -f [options] [document filespec]
```

[Table 20-4](#) (page 20-9) describes the command-line options.

Table 20-4 C XML Parser Command-Line Options

Option	Description
-B BaseURI	Sets the base URI for the XSLT processor. The base URI of <code>http://pqr/xsl.txt</code> resolves <code>pqr.txt</code> to <code>http://pqr/pqr.txt</code> .
-c	Checks well-formedness, but performs no validation.
-e <i>encoding</i>	Specifies default input file encoding ("inencoding").
-E <i>encoding</i>	Specifies DOM/SAX encoding ("outencoding").
-f <i>file</i>	Interprets the file as filespec, not URI.
-G <i>xptr_exprs</i>	Evaluates XPointer scheme examples given in a file.
-h	Shows usage help and basic list of command-line options.
-hh	Shows complete list command-line options.
-i <i>n</i>	Specifies the number of times to iterate the XSLT processing.
-l <i>language</i>	Specifies the language for error reporting.
-n	Traverses the DOM and reports the number of elements, as shown in this sample output: <pre> ELEMENT 1 PCDATA 1 DOC 1 TOTAL 3 * 60 = 180</pre>
-o <i>XSLoutfile</i>	Specifies the output file of the XSLT processor.
-p	Prints the document/DTD structures after the parse. For example, the root element <code><greeting>hello</greeting></code> is printed as: <pre> +---ELEMENT greeting +---PCDATA "hello"</pre>

Table 20-4 (Cont.) C XML Parser Command-Line Options

Option	Description
-P	Prints the document from the root element. For example, the root element <code><greeting>hello</greeting></code> is printed as: <code><greeting>hello</greeting></code>
-PP	Prints from the root node (DOC) and includes the XML declaration.
-PE <i>encoding</i>	Specifies the encoding for -P or -PP output.
-PX	Includes the XML declaration in the output.
-s <i>stylesheet</i>	Specifies the XSLT stylesheet.
-v	Displays the XDK parser version, and then exits.
-V <i>var value</i>	Tests top-level variables in CXSLT.
-w	Preserves all white space.
-W	Stops parsing after a warning.
-x	Exercises the SAX interface and prints the document, as shown in this sample output: <pre>StartDocument XMLDECL version='1.0' encoding=FALSE <greeting> "hello" </greeting> EndDocument</pre>

20.2.5.1 Using the XML Parser Command-Line Utility: Example

You can test xml documents using the various XML files located in `$ORACLE_HOME/xdk/demo/c`.

[Example 20-1](#) (page 20-10) displays the contents of `NSEexample.xml`.

You can parse this file, count the number of elements, and display the DOM tree as shown in this example:

```
xml -np NSEexample.xml > xml.out
```

[Example 20-2](#) (page 20-11) shows the output.

Example 20-1 NSEexample.xml

```
<!DOCTYPE doc [
<!ELEMENT doc (child*)>
<!ATTLIST doc xmlns:nsprefix CDATA #IMPLIED>
<!ATTLIST doc xmlns CDATA #IMPLIED>
<!ATTLIST doc nsprefix:a1 CDATA #IMPLIED>
<!ELEMENT child (#PCDATA)>
]>
<doc nsprefix:a1 = "v1" xmlns="http://www.w3c.org"
```

```

xmlns:nsprefix="http://www.oracle.com">
<child>
This element inherits the default Namespace of doc.
</child>
</doc>

```

Example 20-2 xml.out

```

ELEMENT      2
PCDATA      1
  DOC       1
  DTD       1
ELEMDECL    2
ATTRDECL    3
  TOTAL    10 * 112 = 1120
+---ELEMENT doc [nsprefix:al='v1'*, xmlns='http://www.w3c.org'*, xmlns:nsprefix=
'http://www.oracle.com'*]
  +---ELEMENT child
    +---PCDATA "
This element inherits the default Namespace of doc.
"

```

20.3 Using the DOM API for C

Topics here include controlling encoding for XML documents, using NULL-terminated and length-encoded functions, and handling errors.

Topics:

- [Controlling the Data Encoding of XML Documents for the C API](#) (page 20-11)
- [Using NULL-Terminated and Length-Encoded C API Functions](#) (page 20-12)
- [Handling Errors with the C API](#) (page 20-13)

20.3.1 Controlling the Data Encoding of XML Documents for the C API

XML data occurs in many encodings. You can control the XML encoding in various ways.

- Specify a default encoding to assume for files that are not self-describing
- Specify the presentation encoding for DOM or SAX
- Re-encode when a DOM is serialized

Input XML data is always encoded. Some encodings are entirely self-describing, such as 16-bit encoding of Unicode (UTF-16), which requires a specific Byte Order Mark (BOM) before the start of the actual data. The `XMLDecl` or Multipurpose Internet Mail Extensions (MIME) header of the document can also specify an encoding. If the application cannot determine the specific encoding, then it applies the default input encoding. If you do not provide a default, then the application assumes UTF-8 on ASCII platforms and UTF-EBCDIC on EBCDIC platforms.

The API makes a provision for cases when the encoding data of the input document is corrupt. For example, suppose an ASCII document with an `XMLDecl` of `encoding=ascii` is blindly converted to EBCDIC. The new EBCDIC document contains (in EBCDIC) an `XMLDecl` that incorrectly claims the document is ASCII. The correct behavior for a program that is re-encoding XML data is to regenerate but not convert the `XMLDecl`. The `XMLDecl` is metadata, not data itself. This rule is often

ignored, however, which causes corrupt documents. To work around this problem, the API provides an additional flag that enables you to forcibly set the input encoding, thereby overcoming an incorrect `XMLDecl`.

The precedence rules for determining input encoding are:

1. Forced encoding as specified by the user

Note:

Forced encoding can cause a fatal error if there is a conflict. For example, the input document is UTF-16 and starts with a UTF-16 BOM, but the user specifies a forced UTF-8 encoding. In this case, the parser objects about the conflict.

2. Protocol specification (HTTP header, and so on)
3. `XMLDecl` specification
4. User's default input encoding
5. The default, which is UTF-8 on ASCII platforms or UTF-E on EBCDIC platforms

After the application has determined the input encoding, it can parse the document and present the data. You are allowed to choose the presentation encoding; the data is in that encoding regardless of the original input encoding.

When an application writes back a DOM in serialized form, it can choose at that time to re-encode the presentation data. Thus, you can place the serialized document in any encoding.

20.3.2 Using NULL-Terminated and Length-Encoded C API Functions

The native string representation in C is null-terminated. Thus, the primary DOM interface takes and returns null-terminated strings. When stored in table form, however, Oracle XML DB data is *not* null-terminated but *length-encoded*. Consequently, XDK provides an additional set of length-encoded APIs for the high-frequency cases to improve performance.

In particular, the DOM functions in [Table 20-5](#) (page 20-12) have dual APIs.

Table 20-5 NULL-Terminated and Length-Encoded C API Functions

NULL-Terminated API	Length-Encoded API
<code>XmlDomGetNodeName()</code>	<code>XmlDomGetNodeNameLen()</code>
<code>XmlDomGetNodeLocal()</code>	<code>XmlDomGetNodeLocalLen()</code>
<code>XmlDomGetNodeURI()</code>	<code>XmlDomGetNodeURILen()</code>
<code>XmlDomGetNodeValue()</code>	<code>XmlDomGetNodeValueLen()</code>
<code>XmlDomGetAttrName()</code>	<code>XmlDomGetAttrNameLen()</code>
<code>XmlDomGetAttrLocal()</code>	<code>XmlDomGetAttrLocalLen()</code>
<code>XmlDomGetAttrURI()</code>	<code>XmlDomGetAttrURILen()</code>

Table 20-5 (Cont.) NULL-Terminated and Length-Encoded C API Functions

NULL-Terminated API	Length-Encoded API
<code>XmlDomGetAttrValue()</code>	<code>XmlDomGetAttrValueLen()</code>

20.3.3 Handling Errors with the C API

The C API functions typically either return a numeric error code (0 for success, nonzero on failure), or pass back an error code through a variable. In all cases, the API stores error codes. Your application can retrieve the most recent error by invoking the `XmlDomGetLastError()` function.

By default, the functions output error messages to `stderr`. However, you can register an error message callback at initialization time. When an error occurs, the application invokes the registered callback and does not print an error.

20.4 Using orastream Functions

The orastream function API is an interface that enables you to stream large chunks of data out of a node instead of getting it all in one piece. Nodes of greater than 64 KB are thus accessible.

The orastream API represents a generic input or output stream. This interface is available to XDK users through `xml.h` and is defined by the `orastream` data structure and a set of functions that implement the interface. The creator of the stream passes a list of stream function addresses, along with a stream context to `OraStreamInit`. This function returns an instance of an `orastream` structure.

Several stream properties are specified at the time of initialization. If `read` or `write` is provided, the stream operates in byte mode using `OraStreamRead()` and `OraStreamWrite()`. If `read_char` or `write_char` is provided, the stream operates in character mode using `OraStreamReadChar()` and `OraStreamWriteChar()`. In character mode only complete characters are read or written and are never split over buffer boundaries.

A stream context is used to represent the state of the orastream and it persists for the lifetime of a stream.

Just like the input or output streams in Java, a source or a sink for the data is always specified. Output streams store the address of the external stream or object where they must populate the data. Similarly, input streams store the address of the object that is read.

Here are the orastream functions:

```
struct orastream;
typedef struct orastream orastream;
typedef ub4 oraerr; /* Error code: zero is success, non-zero is failure */

/* Initialize (Create) & Destroy (Terminate) stream object */

orastream *OraStreamInit(void *sctx, void *sid, oraerr *err, ...);
oraerr OraStreamTerm(orastream *stream);

/* Set or Change SID (streamID) for stream (returns old stream ID through osid)*/

oraerr OraStreamSid(orastream *stream, void *sid, void **osid);
```

```

/* Is a stream readable or writable? */

boolean   OraStreamReadable(orastream *stream);
boolean   OraStreamWritable(orastream *stream);

/* Open & Close stream */

oraerr    OraStreamOpen(orastream *stream, ubig_ora *length);
oraerr    OraStreamClose(orastream *stream);

/* Read | Write byte stream */

oraerr    OraStreamRead(orastream *stream, oratext *dest, ubig_ora size,
                      oratext **start, ubig_ora *nread, ubl *eoi);
oraerr    OraStreamWrite(orastream *stream, oratext *src, ubig_ora size,
                      ubig_ora *nwrote);

/* Read | Write char stream */

oraerr    OraStreamReadChar(orastream *stream, oratext *dest, ubig_ora size,
                      oratext **start, ubig_ora *nread, ubl *eoi);
oraerr    OraStreamWriteChar(orastream *stream, oratext *src, ubig_ora size,
                      ubig_ora *nwrote);

/* Return handles for stream */

orastreamhdl *OraStreamHandle(orastream *stream);

/* Returns status: if the stream object is currently opened or not */

boolean OraStreamIsOpen(orastream *stream);

```

The stream error codes are:

```

#define ORASTREAM_ERR_NULL_POINTER      1      /* NULL pointer given */
#define ORASTREAM_ERR_BAD_STREAM       2      /* invalid stream object */
#define ORASTREAM_ERR_WRONG_DIRECTION  3      /* tried wrong-direction I/O */
#define ORASTREAM_ERR_UNKNOWN_PROPERTY 4      /* unknown creation prop */
#define ORASTREAM_ERR_NO_DIRECTION     5      /* neither read nor write? */
#define ORASTREAM_ERR_BI_DIRECTION     6      /* both read any write? */
#define ORASTREAM_ERR_NOT_OPEN         7      /* stream not open */
#define ORASTREAM_ERR_WRONG_MODE       8      /* wrote byte/char mode */
/* --- Open errors --- */
#define ORASTREAM_ERR_CANT_OPEN        10     /* can't open stream */
/* --- Close errors --- */
#define ORASTREAM_ERR_CANT_CLOSE       20     /* can't close stream */

```

See Also:

Oracle Database XML C API Reference for reference information such as parameter definitions in the orastream API

Example 20-3 Using orastream Functions

```

int test_read()
{
    xmlctx *xctx = NULL;
    oratext *barray, *docName = "NSExample.xml";
    orastream* ostream = (orastream *) 0;
    xmlerr ecode = 0;

```

```

ub4 wcount = 0;
ubig_ora destsize, nread;
oraerr oerr = 0;
ubl eoi = 0;
nread = destsize = 1024;
if (!(xctx = XmlCreateNew(&ecode, (oratext *)"stream_xctx", NULL, wcount,
                        NULL)))
    {
        printf("Failed to create XML context, error %u\n", (unsigned)ecode);
        return -1;
    }

barray = XmlAlloc(xctx, sizeof(oratext) * destsize);

/* open function should be specified in order to read correctly. */
if (!(ostream = OraStreamInit(NULL, docName, (oraerr *)&ecode,
                              "open", fileopen,
                              "read", fileread,
                              NULL)))
    {
        printf("Failed to initialize OrsStream, error %u\n", (unsigned)ecode);
        return -1;
    }

/* check readable and writable */
if (OraStreamReadable(ostream))
    printf("ostream is readable\n");
else
    printf("ostream is not readable\n");

if (OraStreamWritable(ostream))
    printf("ostream is writable\n");
else
    printf("ostream is not writable\n");

if (oerr = OraStreamRead(ostream, barray, destsize, &barray, &nread, &eoi))
    {
        printf("Failed to read due to orastream was not open, error %u\n", oerr);
    }

/* open orastream */
OraStreamOpen(ostream, NULL);

/* read document */
OraStreamRead(ostream, barray, destsize, &barray, &nread, &eoi);

OraStreamTerm(ostream);

XmlDestroy(xctx);
return 0;
}
ORASTREAM_OPEN_F(fileopen, sctx, sid, hdl, length)
{
    FILE *fh = NULL;

    printf("Opening orastream %s...\n", (oratext *)sid);

    if (sid && ((fh = fopen(sid, "r")) != NULL))
        {
            printf("Opening orastream %s...\n", (oratext *)sid);
        }
}

```

```
else
{
    printf("Failed to open input file.\n");
    return -1;
}

/* store file handle generically, NULL means stdout */
hdl->ptr_orastreamhdl = fh;

return XMLERR_OK;
}

ORASTREAM_READ_F(fileread, sctx, sid, hdl,
                 dest, size, start, nread, eoi)
{
    FILE *fh = NULL;
    int i =0;
    printf("Reading orastream %s ...\n", (oratext *)sid);

    // read data from file to dest
    if ((fh = (FILE *) hdl->ptr_orastreamhdl) != NULL)
        *nread = fread(dest, 1, size, fh);
    printf("Read %d bytes from orastream...\n", (int) *nread);

    *eoi = (*nread < size);
    if (start)
        *start = dest;

    printf("printing document ...\n");
    for(i =0; i < *nread; i++)
        printf("%c", (char)dest[i]);
    printf("\nend ...\n");
    return ORAERR_OK;
}
```

20.5 Using the SAX API for C

To use SAX, initialize an `xmlsaxcb` structure with function pointers and pass it to `XmlLoadSax()`. You can also include a pointer to a user-defined context structure, which you pass to each SAX function.

See Also:

Oracle Database XML C API Reference for the SAX callback structure

20.6 Using the XML Pull Parser for C

The XML Pull Parser is an implementation of the XML Events interface. The XML Pull Parser and the SAX parser are similar, but using the Pull Parser, the application (consumer) drives the events, while in SAX, the parser (producer) drives the events.

Both the XML Pull Parser and SAX represent the document as a sequence of events, with start tags, end tags, and comments. XML Pull Parser gives control to the application by exposing a simple set of APIs and an underlying set of events. Methods such as `XmlEvNext` allow an application to ask for (or pull) the next event, rather than handling the event in a callback, as in SAX. Thus, the application has more procedural control over XML processing. Also, the application can decide to stop further processing, unlike a SAX application, which parses the entire document.

Topics:

- [Using Basic XML Pull Parsing Capabilities](#) (page 20-17)
- [Parsing Multiple XML Documents](#) (page 20-18)
- [ID Callback](#) (page 20-18)
- [Error Handling for the XML Pull Parser](#) (page 20-19)
- [Sample Pull Parser Application](#) (page 20-19)

20.6.1 Using Basic XML Pull Parsing Capabilities

The steps required to use the XML Pull Parser are described.

1. Invoke `XmlCreate` to initialize the XML meta-context.
2. Initialize the Pull Parser context by invoking the `XmlEvCreatePPCtx` function, which creates and returns the event context.

The `XmlEvCreatePPCtx` function supports all the properties supported by `XmlLoadDom` and `XmlLoadSax`, plus some additional ones.

The `XmlEvCreatePPCtx` and `XmlEvCreatePPCtxVA` functions are fully implemented.

3. Ensure that the event context is passed to all subsequent invocations of the Pull Parser.
4. Terminate the Pull Parser context by invoking the `XmlEvDestroyPPCtx` function, to clean up memory.
5. Destroy the XML meta-context by invoking the `XmlDestroyCtx` function.

20.6.1.1 XML Event Context

The XML event context structure is shown.

Example 20-4 XML Event Context

```
typedef struct {
    void *ctx_xmlvctx;           /* implementation specific context */
    xmlvdisp *disp_xmlvctx;     /* dispatch table */
    ub4 checkword_xmlvctx;     /* checkword for integrity check */
    ub4 flags_xmlvctx;         /* mode; default: expand_entity */
    struct xmlvctx *input_xmlvctx; /* input xmlvctx; chains the XML Event
                                context */
} xmlvctx;
```

20.6.1.2 About the XML Event Context

Each XML Pull Parser is allowed to create its own context and implement its own API functions.

- Dispatch Table

The dispatch table, `disp_xmlvctx`, contains one pointer for each API function, except for the `XmlEvCreatePPCtx`, `XmlEvCreatePPCtxVA`, `XmlEvDestroyPPCtx`, `XmlEvLoadPPDoc`, and `XmlEvCleanPPCtx` functions.

When the event context is created, the pointer `disp_xmlvctx` is initialized with the address of that static table.

- **Implementation-Specific Event Context**

The field `ctx_xmllevctx` must be initialized with the address of the context specific to this invocation of the particular implementation. The implementation-specific event context is of type `*void`, so that it can differ for different applications.

- **Input Event Context**

Each Pull Parser can specify an input event context, `xmllevctx`. This field enables the parser to chain multiple event producers. As a result, if a dispatch function is specified as `NULL` in a context, the application uses the next non-null dispatch function in the chain of input event contexts. The base `xmllevctx` must ensure that all dispatch function pointers are non-null.

20.6.2 Parsing Multiple XML Documents

After creating and initializing the XML Event Context, an application can parse multiple documents using repeated invocations of `XmlEvLoadPPDoc` and `XmlEvCleanPPCtx`.

The properties defined by the application during the XML Event Context creation cannot be changed for each invocation of the `XmlLoadPPDoc` function. To change the properties, destroy the event context and then re-create it.

After `XmlEvCleanPPCtx` cleans up the internal structure of the current parser, the event context can be reused to parse another document.

20.6.3 ID Callback

You can provide a callback to convert text-based names to 8-byte identifiers (IDs).

Callback Function Signature

```
typedef sb8 (*xmllev_id_cb_funcp)( void *ctx , ub1 type, ub1 *token, ub4 tok_len,
                                   sb8 nmspid, boolean isAttribute);
```

Return Value

sb8: an 8-byte ID.

Arguments

- `*ctx`: The implementation context.
- `type`: The type, which is indicated by this enumeration:

```
typedef enum
{
    XML_EVENT_ID_URI,
    XML_EVENT_ID_QNAME,
}xmllev_idtype;
```

- `*token` and `tok_len`: The actual text to be converted.
- `nmspid`: The namespace ID.
- `isAttribute`: A Boolean value indicating an attribute.

Internally, the `XmlEvGetTagId` and `XmlEvGetAttrID` APIs invoke this callback twice, once to fetch the namespace ID and once to fetch the actual ID of the tag or the attribute `Qname`.

The `XmlEvGetTagUriID` and `XmlEvGetAttrUriID` functions invoke this callback once to get the ID of the corresponding Universal Resource Identifier (URI).

If a callback is not supplied, an error `XML_ERR_EVENT_NOIDCBK` is returned when these APIs are used.

20.6.4 Error Handling for the XML Pull Parser

Error handling for the XML Pull Parser is described.

20.6.4.1 Parser Errors

Errors raised by the parser are described.

The XML Pull Parser returns the message `XML_EVENT_FATAL_ERROR` when it throws an error because the input document is malformed. Function `XmlEvGetError` is provided to get the error number and message.

During the `XmlEvCreatePPctx` operation, any error handler supplied by the application during `XmlCreate` is overridden. The application must invoke the `XmlErrSetHandler` function after the `XmlEvDestroyPPctx` operation to restore the original callback.

20.6.4.2 Programming Errors

To handle programmatic errors, XDK provides a callback that the application can supply when creating an event context. This callback is invoked when the application invokes an illegal API.

The callback signature is:

```
typedef void (* xmlev_err_cb_funcp)(xmlctx *xctx, xmlevctx *evctx,
                                   xmlevtype cur_event);
```

An example of an illegal API invocation is:

`XmlEvGetName` cannot be called for the `XML_EVENT_CHARACTERS` event.

20.6.5 Sample Pull Parser Application

A sample pull parser application, a document to be parsed, and a list of the events that the application generates from the document are presented.

[Example 20-5](#) (page 20-19) shows the sample application code.

[Example 20-6](#) (page 20-20) shows the sample document to be parsed.

[Example 20-7](#) (page 20-20) shows the sequence of events generated when the attribute events property is `FALSE` and the expand entities properties is `TRUE`.

Example 20-5 *Sample Pull Parser Application Example*

```
# include "xml.h"
# include "xmlev.h"
...
xmlctx *xctx;
xmlevctx *evctx;
if (!(xctx = XmlCreate(&xerr, (oratext *) "test")))
{
    printf("Failed to create XML context, error %u\n", (unsigned) xerr);
    return -1;
}
...
```

```

if(!(evctx = XmlEvCreatePPCtx(xctx, &xerr, NULL))
{
    printf("Failed to create EVENT context, error %u\n", (unsigned) xerr);
    return -1;
}
for(i = 0; i < numDocs; i++)
{
    if (xerr = XmlEvLoadPPDoc(xctx, evctx, "file", input_filenames[i], 0, NULL)
    {
        printf("Failed to load the document, error %u\n", (unsigned) xerr);
        return -1;
    }
    ...
    for(;;)
    {
        xmlevtype cur_event;
        cur_event = XmlEvNext(evctx);
        switch(cur_event)
        {
            case XML_EVENT_FATAL_ERROR:
                XmlEvGetError(evctx, (oratext **)&errmsg);
                printf("Error %s\n", errmsg);
            return;
            case XML_EVENT_START_ELEMENT:
                printf("<%s>", XmlEvGetName0(evctx));
                break;
            case XML_EVENT_END_DOCUMENT:
                printf("<%s>", XmlEvGetName0(evctx));
                return;
        }
    }
    XmlEvCleanPPCtx(xctx, evctx);
}
XmlEvDestroyPPCtx(xctx, evctx);
XmlDestroy(xctx);

```

Example 20-6 Sample Document to Parse

```

<!DOCTYPE doc [
<!ENTITY ent SYSTEM "file:attendees.txt">
<!ELEMENT doc ANY>
<!ELEMENT meeting (topic, date, publishAttendees)>
<!ELEMENT publishAttendees (#PCDATA)>
<!ELEMENT topic (#PCDATA)>
<!ELEMENT date (#PCDATA)>
]>
<!-- Begin Document -->
<doc>
  <!-- Info about the meeting -->
  <meeting>
    <topic>Group meeting</topic>
    <date>April 25, 2005</date>
    <publishAttendees>&ent;</publishAttendees>
  </meeting>
</doc>
<!-- End Document -->

```

Example 20-7 Events Generated by Parsing a Sample Document

```

XML_EVENT_START_DOCUMENT
XML_EVENT_START_DTD
XML_EVENT_PE_DECLARATION

```



```

XML_EVENT_ELEMENT_DECLARATION
XML_EVENT_ELEMENT_DECLARATION
XML_EVENT_ELEMENT_DECLARATION
XML_EVENT_ELEMENT_DECLARATION
XML_EVENT_ELEMENT_DECLARATION
XML_EVENT_END_DTD
XML_EVENT_COMMENT
XML_EVENT_START_ELEMENT
XML_EVENT_SPACE
XML_EVENT_COMMENT
XML_EVENT_SPACE
XML_EVENT_START_ELEMENT
XML_EVENT_START_ELEMENT
XML_EVENT_CHARACTERS
XML_EVENT_END_ELEMENT
XML_EVENT_START_ELEMENT
XML_EVENT_CHARACTERS
XML_EVENT_END_ELEMENT
XML_EVENT_START_ELEMENT
XML_EVENT_START_ENTITY
XML_EVENT_CHARACTERS
XML_EVENT_END_ENTITY
XML_EVENT_END_ELEMENT
XML_EVENT_END_ELEMENT
XML_EVENT_SPACE
XML_EVENT_END_ELEMENT
XML_EVENT_COMMENT
XML_EVENT_END_DOCUMENT

```

20.7 Using OCI and the XDK for C API

This section describes accessing XDK for C functions from Oracle Call Interface (OCI).

20.7.1 Using XMLType Functions and Descriptions

You can use the C API for XML with `XMLType` columns in the database. An Oracle Call Interface (OCI) program can access XML data stored in a table by initializing the values of OCI handles.

This applies to handles such as these:

- Environment handle
- Service handle
- Error handle
- Optional parameters

The program can pass these input values to the function `OCIxmldbInitXmlCtx()`, which returns an XML context. After the program invokes the C API, the function `OCIxmldbFreeXmlCtx()` frees the context.

Table 20-6 XMLType Functions

Function Name	Description
<code>XmlCreateDocument()</code>	Create empty XMLType instance
<code>XmlLoadDom()</code> and so on	Create from a source buffer

Table 20-6 (Cont.) XMLType Functions

Function Name	Description
<code>XmlXPathEvalExpr()</code> and family	Extract an XPath expression
<code>XmlXslProcess()</code> and family	Transform using an Extensible Stylesheet Language Transformation (XSLT) stylesheet
<code>XmlXPathEvalExpr()</code> and family	Check if an XPath exists
<code>XmlDomIsSchemaBased()</code>	Is document schema-based?
<code>XmlDomGetSchema()</code>	Get schema information
<code>XmlDomGetNodeURI()</code>	Get document namespace
<code>XmlSchemaValidate()</code>	Validate using schema
<code>Cast(void *) to (xmlDocNode *)</code>	Get DOM from XMLType
<code>Cast(xmlDocNode *) to (void *)</code>	Get XMLType from DOM

20.7.2 Initializing an XML Context for Oracle XML DB

An XML context is a required parameter in each C DOM API function. This opaque context encapsulates information pertaining to data encoding, error message language, and so on. The contents of this XML context are different for XDK applications and for Oracle XML DB applications.

Note:

Do not use an XML context for XDK in an Oracle XML DB application, or an XML context for Oracle XML DB in an XDK application.

For Oracle XML DB, the two OCI functions that initialize and free an XML context have these prototypes:

```
xmlctx *OCIXmlDbInitXmlCtx (OCIEnv *envhp, OCISvcCtx *svchp, OCIError *errhp,
    ocixmlDbparam *params, ub4 num_params);
```

```
void OCIXmlDbFreeXmlCtx (xmlctx *xctx);
```

See Also:

- *Oracle Call Interface Programmer's Guide* for reference material on the functions
 - *Oracle Call Interface Programmer's Guide* for a discussion about OCI support for XML
 - *Oracle Database XML C API Reference* for reference information on the DOM APIs
-
-

20.7.3 Creating XMLType Instances on the Client

You can construct new `XMLType` instances on the client by using the `XmlLoadDom()` invocations.

Follow these basic steps:

1. You must initialize the `xmlctx`, as showd in the example in [Using the DOM API for C](#) (page 20-11).
2. You can construct the XML data itself from these sources:
 - User buffer
 - Local file
 - URI

The return value from these is an `(xmlDocnode *)`, which you can use in the rest of the common C API.

3. You can cast the `(xmlDocnode *)` to a `(void *)` and directly provide it as the bind value if required.

You can construct empty `XMLType` instances by invoking `XmlCreateDocument()`. This function would be equivalent to an `OCIObjectNew()` for other types. You can operate on the `(xmlDocnode *)` returned by the preceding invocation and finally cast it to a `(void *)` if it must be provided as a bind value.

20.7.4 Operating on XML Data in the Database Server

You can operate on XML data in Oracle Database using OCI statements. You can bind and define `XMLType` values using `xmlDocnode` and use OCI statements to extract XML data from the database. You can use this data directly in C DOM functions or bind values directly to SQL statements.

20.7.5 Using OCI and the XDK for C API: Examples

Examples show how to use the DOM API to construct and save an XML schema-based document and to modify a database document.

[Example 20-8](#) (page 20-23) shows how to construct a schema-based document with the DOM API and save it to the database. You must include the header files `xml.h` and `ocixml.h`.

[Example 20-9](#) (page 20-25) shows how to get a document from the database and modify it with the DOM API.

Example 20-8 Constructing a Schema-Based Document with the DOM API

```
#include <xml.h>
#include <ocixml.h>
static oratext tlpxml_test_sch[] = "<TOP xmlns='example1.xsd'\n\
xmlns:xsi='http://www.w3.org/2001/XMLSchema-instance' \n\
xsi:schemaLocation='example1.xsd example1.xsd' />";

void example1()
{
    OCIEnv *envhp;
    OCIError *errhp;
```

```

OCISvcCtx *svchp;
OCIStmt *stmthp;
OCIDuration dur;
OCIType *xmltdo;

xmlDocNode *doc;
ocixmlDbParam params[1];
xmlNode *quux, *foo, *foo_data;
xmlerr      err;

/* Initialize envhp, svchp, errhp, dur, stmthp */
/* ..... */

/* Get an xml context */
params[0].name_ocixmlDbParam = XCTXINIT_OCIDUR;
params[0].value_ocixmlDbParam = &dur;
xctx = OCIXmlDbInitXmlCtx(envhp, svchp, errhp, params, 1);

/* Start processing */
printf("Supports XML 1.0: %s\n",
       XmlHasFeature(xctx, (oratext *) "xml", (oratext *) "1.0") ? "YES" : "NO");

/* Parsing a schema-based document */
if (!(doc = XmlLoadDom(xctx, &err, "buffer", tlpxml_test_sch,
                      "buffer_length", sizeof(tlpxml_test_sch)-1,
                      "validate", TRUE, NULL)))
{
    printf("Parse failed, code %d\n");
    return;
}

/* Create some elements and add them to the document */
top = XmlDomGetDocElem(xctx, doc);
quux = (xmlNode *) XmlDomCreateElem(xctx, doc, (oratext *) "QUUX");
foo = (xmlNode *) XmlDomCreateElem(xctx, doc, (oratext *) "FOO");
foo_data = (xmlNode *) XmlDomCreateText(xctx, doc, (oratext *) "foo's data");
foo_data = XmlDomAppendChild(xctx, (xmlNode *) foo, (xmlNode *) foo_data);
foo = XmlDomAppendChild(xctx, quux, foo);
quux = XmlDomAppendChild(xctx, top, quux);

XmlSaveDom(xctx, &err, top, "stdio", stdout, NULL);
XmlSaveDom(xctx, &err, doc, "stdio", stdout, NULL);

/* Insert the document to my_table */
ins_stmt = "insert into my_table values (:1)";

status = OCITypeByName(envhp, errhp, svchp, (const text *) "SYS",
                      (ub4) strlen((char *) "SYS"), (const text *) "XMLTYPE",
                      (ub4) strlen((char *) "XMLTYPE"), (CONST text *) 0,
                      (ub4) 0, dur, OCI_TYPEGET_HEADER,
                      (OCIType **) &xmltdo);

if (status == OCI_SUCCESS)
{
    exec_bind_xml(svchp, errhp, stmthp, (void *) doc, xmltdo, ins_stmt);
}

/* free xml ctx */
OCIXmlDbFreeXmlCtx(xctx);
}

```

```

/*-----*/
/* execute a sql statement which binds xml data */
/*-----*/
sword exec_bind_xml(svchp, errhp, stmthp, xml, xmltdo, sqlstmt)
OCISvcCtx *svchp;
OCIError *errhp;
OCIStmt *stmthp;
void *xml;
OCIType *xmltdo;
OraText *sqlstmt;
{
    OCIBind *bndhp1 = (OCIBind *) 0;
    OCIBind *bndhp2 = (OCIBind *) 0;
    sword status = 0;
    OCIInd ind = OCI_IND_NOTNULL;
    OCIInd *indp = &ind;

    if(status = OCIStmtPrepare(stmthp, errhp, (OraText *)sqlstmt,
        (ub4)strlen((char *)sqlstmt),
        (ub4) OCI_NTV_SYNTAX, (ub4) OCI_DEFAULT)) {
        return OCI_ERROR;
    }

    if(status = OCIBindByPos(stmthp, &bndhp1, errhp, (ub4) 1, (dvoid *) 0,
        (sb4) 0, SQLT_NTY, (dvoid *) 0, (ub2 *)0,
        (ub2 *)0, (ub4) 0, (ub4 *) 0, (ub4) OCI_DEFAULT)) {
        return OCI_ERROR;
    }

    if(status = OCIBindObject(bndhp1, errhp, (CONST OCIType *) xmltdo,
        (dvoid **) &xml, (ub4 *) 0, (dvoid **) &indp, (ub4 *) 0)) {
        return OCI_ERROR;
    }

    if(status = OCIStmtExecute(svchp, stmthp, errhp, (ub4) 1, (ub4) 0,
        (CONST OCISnapshot*) 0, (OCISnapshot*) 0, (ub4) OCI_DEFAULT)) {
        return OCI_ERROR;
    }

    return OCI_SUCCESS;
}

```

Example 20-9 Modifying a Database Document with the DOM API

```

#include <xml.h>
#include <ocixmlldb.h>
sword example2()
{
    OCIEnv *envhp;
    OCIError *errhp;
    OCISvcCtx *svchp;
    OCIStmt *stmthp;
    OCIDuration dur;
    OCIType *xmltdo;

    xmldocnode *doc;
    xmlnodelist *item_list; ub4 ilist_l;
    ocixmlldbparam params[1];
    text *sel_xml_stmt = (text *)"SELECT xml_col FROM my_table";
    ub4 xmlsize = 0;
    sword status = 0;

```

```

OCIDefine *defnp = (OCIDefine *) 0;

/* Initialize envhp, svchp, errhp, dur, stmthp */
/* ... */

/* Get an xml context */
params[0].name_ocixmlbparam = XCTXINIT_OCIDUR;
params[0].value_ocixmlbparam = &dur;
xctx = OCIXmlDbInitXmlCtx(envhp, svchp, errhp, params, 1);

/* Start processing */
if(status = OCITypeByName(envhp, errhp, svchp, (const text *) "SYS",
    (ub4) strlen((char *)"SYS"), (const text *) "XMLTYPE",
    (ub4) strlen((char *)"XMLTYPE"), (CONST text *) 0,
    (ub4) 0, dur, OCI_TYPEGET_HEADER,
    (OCIType **) xmltdo_p)) {
    return OCI_ERROR;
}

if(!(*xmltdo_p)) {
    printf("NULL tdo returned\n");
    return OCI_ERROR;
}

if(status = OCISmtPrepare(stmthp, errhp, (OraText *)selstmt,
    (ub4)strlen((char *)selstmt),
    (ub4) OCI_NTV_SYNTAX, (ub4) OCI_DEFAULT)) {
    return OCI_ERROR;
}

if(status = OCIDefineByPos(stmthp, &defnp, errhp, (ub4) 1, (dvoid *) 0,
    (sb4) 0, SQLT_NTY, (dvoid *) 0, (ub2 *)0,
    (ub2 *)0, (ub4) OCI_DEFAULT)) {
    return OCI_ERROR;
}

if(status = OCIDefineObject(defnp, errhp, (OCIType *) *xmltdo_p,
    (dvoid **) &doc,
    &xmlsize, (dvoid **) 0, (ub4 *) 0)) {
    return OCI_ERROR;
}

if(status = OCISmtExecute(svchp, stmthp, errhp, (ub4) 1, (ub4) 0,
    (CONST OCISnapshot*) 0, (OCISnapshot*) 0, (ub4) OCI_DEFAULT)) {
    return OCI_ERROR;
}

/* We have the doc. Now we can operate on it */
printf("Getting Item list...\n");

item_list = XmlDomGetElemsByTag(xctx, (xmlelemnode *) elem, (oratext *)"Item");
i1ist_l = XmlDomGetNodeListLength(xctx, item_list);
printf(" Item list length = %d \n", i1ist_l);

for (i = 0; i < i1ist_l; i++)
{
    elem = XmlDomGetNodeListItem(xctx, item_list, i);
    printf("Elem Name:%s\n", XmlDomGetNodeName(xctx, fragelem));
    XmlDomRemoveChild(xctx, fragelem);
}

```

```
    XmlSaveDom(xctx, &err, doc, "stdio", stdout, NULL);

    /* free xml ctx */
    OCIXmlDbFreeXmlCtx(xctx);

    return OCI_SUCCESS;
}
```

Using Binary XML with C

An explanation is given of how to use binary Extensible Markup Language (binary XML) with C.

Topics:

- [Introduction to Binary XML for C](#) (page 21-1)
- [Prerequisites for Using Binary XML with C](#) (page 21-1)
- [Binary XML Storage Format – C](#) (page 21-1)

21.1 Introduction to Binary XML for C

Client-side processing of Extensible Markup Language (XML) data can use either `XMLType` data stored in the database, including data in binary XML format, or transient data that is not in the database.

21.2 Prerequisites for Using Binary XML with C

This chapter assumes that you are familiar with the XML Parser for C, the basic concepts of binary XML, and the OCI (Oracle Call Interface). Only the OCI API can be used for programming in C with binary XML.

See Also:

- [Using the XML Parser for C](#) (page 20-1)
 - [Using Binary XML with Java](#) (page 5-1)
 - *Oracle XML DB Developer's Guide*
 - *Oracle Call Interface Programmer's Guide*
-

21.3 Binary XML Storage Format – C

Binary XML is an optimized format for XML. It includes encoding and decoding of XML documents, from text to binary and binary to text. Binary XML is XML Schema-aware, but it can also be used for XML data that is not based on an XML schema.

A binary XML processor is a component that processes and transforms binary XML format into text and XML text into binary XML format.

The mid-tier and client tiers can produce, consume, and process XML in binary XML format. The C application fetches data from Oracle XML DB Repository, performs updates on the XML using DOM, and stores it back in the database. Or an XML document is created or input on the client and XSLT, XQuery, and other utilities can

be used on it. Then the output XML is saved in Oracle XML DB. Further details of concepts and reference pages for OCI functions are described in the Oracle Call Interface Programmer's Guide.

Using the XML Schema Processor for C

An explanation is given of how to use the Extensible Markup Language (XML) schema processor for C.

Topics:

- [Oracle XML Schema Processor for C](#) (page 22-1)
- [Using the C XML Schema Processor Command-Line Utility](#) (page 22-3)
- [XML Schema Processor for C Usage Diagram](#) (page 22-3)
- [How to Run XML Schema for C Sample Programs](#) (page 22-4)
- [What Is the Streaming Validator?](#) (page 22-5)

Note:

Use the unified C application programming interface (API) for Oracle XML Developer's Kit (XDK) and Oracle XML DB applications. Older, nonunified C functions are deprecated and supported only for backward compatibility. They will be removed in a future release.

The unified C API is described in [Overview of the Unified C API](#) (page 18-12).

22.1 Oracle XML Schema Processor for C

The XML Schema processor for C is a companion component to the Extensible Markup Language (XML) parser for C that allows support for simple and complex data types in XML applications.

The XML Schema processor for C supports the World Wide Web Consortium (W3C) XML Schema Recommendation. This makes writing custom applications that process XML documents straightforward, and means that a standards-compliant XML Schema processor is part of XDK on every operating system where Oracle Database is ported.

The XML Schema processor enables validation of XML and retrieval of metadata. It can be called by itself or through the XML Parser for C.

See Also:

[XML Parsing for Java](#) (page 4-1), for more information about XML Schema and why you would want to use XML Schema.

22.1.1 Oracle XML Schema for C Features

The features of the Oracle XML Schema processor for C are described.

Features:

- Supports simple and complex types
- Built on XML parser for C
- Supports the W3C XML Schema Recommendation

See Also:

- *Oracle Database XML C API Reference* "Schema APIs for C"
 - `$ORACLE_HOME/xdk/demo/c/schema/` - sample code
-
-

22.1.2 Standards Conformance for Oracle XML Schema Processor for C

The standards to which the XML Schema Processor for C conforms are listed.

- W3C recommendation for Extensible Markup Language (XML) 1.0
- W3C recommendation for Document Object Model (DOM) Level 1.0
- W3C recommendation for Namespaces in XML
- W3C recommendation for XML Schema

22.1.3 XML Schema Processor for C: Supplied Software

The software supplied for the XML Schema Processor for C is described.

Table 22-1 XML Schema Processor for C: Supplied Files in \$ORACLE_HOME

Directory and Files	Description
<code>bin</code>	schema processor executable, <code>schema</code>
<code>lib</code>	XML/XSL/Schema & support libraries
<code>nls/data</code>	Globalization Support data files
<code>xdk/demo/c/schema</code>	example usage of the Schema processor
<code>xdk/include</code>	header files
<code>xdk/msg</code>	error message files
<code>xdk/readme.html</code>	introductory file

[Table 22-2](#) (page 22-3) lists the included libraries in directory `lib`.

Table 22-2 XML Schema Processor for C: Supplied Libraries

Included Library	Description
<code>libxml10.a</code>	XML parser, Extensible Stylesheet Language Transformation (XSLT) processor, XML Schema processor
<code>libcore10.a</code>	Common Oracle Runtime Environment (CORE) functions
<code>libnls10.a</code>	Globalization Support

22.2 Using the C XML Schema Processor Command-Line Utility

You can call XML Schema processor for C as an executable by invoking `bin/schema` in the install area.

The executable takes two arguments:

- XML instance document
- Optionally, a default schema

XML Schema processor for C can also be invoked by writing code using the supplied APIs. The code must be compiled using the headers in the `include` subdirectory and linked against the libraries in the `lib` subdirectory. See `Makefile` in the `xdk/demo/c/schema` subdirectory for details on how to build your program.

Error message files in different languages are provided in the `msg/` subdirectory.

22.3 XML Schema Processor for C Usage Diagram

The calling sequence for the XML Schema processor for C is presented.

[Figure 22-1](#) (page 22-4) illustrates the calling sequence, which is as follows:

1. The initialize call is invoked once at the beginning of a session; it returns a schema context which is used throughout the session.
2. Schema documents to be used in the session are loaded in advance.
3. The instance document to be validated is first parsed with the XML parser.
4. The top of the XML element subtree for the instance is then passed to the schema validate function.
5. If no explicit schema is defined in the instance document, any loaded schemas are used.
6. More documents can then be validated using the same schema context.
7. When the session is over, the Schema tear-down function is called, which releases all memory allocated for the loaded schemas.

Figure 22-1 XML Schema Processor for C Usage Diagram

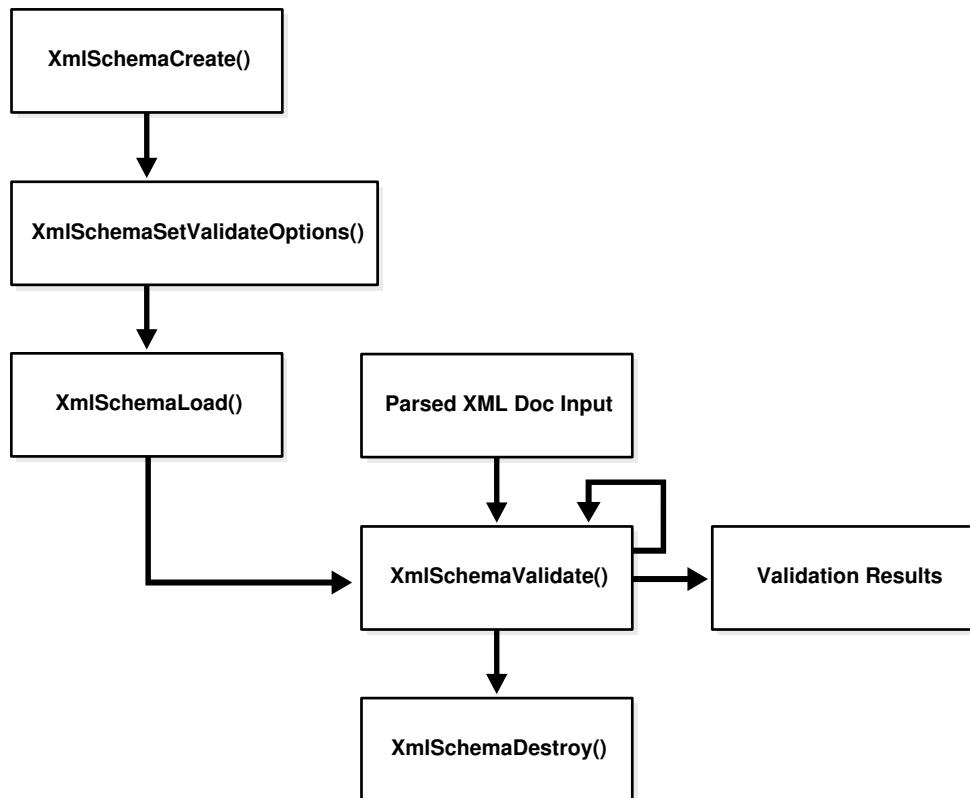

22.4 How to Run XML Schema for C Sample Programs

Directory `xdk/demo/c/schema` contains sample XML Schema applications that show how to use Oracle XML Schema processor with its API. These sample files are described here.

Table 22-3 XML Schema for C Samples Provided

Sample File	Description
<code>Makefile</code>	Makefile to build the sample programs and run them, verifying correct output.
<code>xsdtest.c</code>	Program which invokes the XML Schema for C API
<code>car. {xsd,xml,std}</code>	Sample schema, instance document, and expected output respectively, after running <code>xsdtest</code> on them.
<code>aq. {xsd,xml,std}</code>	Second sample schema, instance document, and expected output respectively, after running <code>xsdtest</code> on them.
<code>pub. {xsd,xml,std}</code>	Third sample schema, instance document, and expected output respectively, after running <code>xsdtest</code> on them.

To build the sample programs, run `make`.

To build the programs and run them, comparing the actual output to expected output:

```
make sure
```

22.5 What Is the Streaming Validator?

The streaming validator uses XML Events, which is a representation of an XML document that is similar to Simple API for XML (SAX) Events. XML events has a start tag, end tag, and comment. The producer drives the SAX events and the consumer drives the XML events.

The streaming validator shares software with the older schema validator and derives most functionality from it. Memory overhead is less than for the DOM representation used in the older validator. Only one pass is made over the document. The streaming validator was introduced in Oracle Database 11g Release 1 (11.1).

There are two modes of streaming validation:

- Transparent mode—events are returned to the application.
- Opaque mode—events are not returned to the application but an error indicating success or failure of the document validation process is returned.

Before document validation, the regular validation context must be created, and the relevant schema must be loaded using this context. Then XML event context for pull parser (or for another event producer) must be created. This event context is then given to the streaming validator, so that it can request events from the producer.

Passing in a schema DOM to the `XmlSchemaLoad` API is also supported.

22.5.1 Using Transparent Mode

Basic use of transparent mode is described.

An application starts by invoking `XmlEvCreateSVCtx()`. This invocation creates and returns an event context of type `xmlctx`, which must be passed on all subsequent invoking the streaming validator. The event context created must be terminated by invoking `XmlEvDestroyCtx()`.

After creation of the event context, the application repeatedly advances validation to the next event by invoking `XmlEvNext()`, which returns the type of the next event. Additional API interfaces allow the application to retrieve information relevant to the last event.

22.5.1.1 Error Handling in Transparent Mode

There is no notion of a valid event. Validity is the property of a document and not of the individual items and events of the document.

The errors are:

- `XML_EVENT_FATAL_ERROR`—When the producer of XML events reports this error, the streaming validator returns this event back to the application and stops the validation process.
- `XML_EVENT_ERROR`—The streaming validator returns this event to the application when a validation error occurs. The application can then invoke `XmlEvGetError()` to get more information about the error.

If the application does not receive any `XML_EVENT_ERROR` or `XML_EVENT_FATAL_ERROR` events, the document is valid. Therefore, the application must handle these events and not ignore them.

These errors are not cached and the associated information is not available for later retrieval.

22.5.1.2 Streaming Validator Example

A streaming validator example in transparent mode is presented.

Example 22-1 Streaming Validator in Transparent Mode

```
# include "xmlev.h"
...
xmlevctx *ppevctx, *svevctx;
xmlctx *xctx
xsdctx *sctx;

if (!(xctx = XmlCreate(&xerr, (oratext *) "test")))
    printf("Failed to create XML context, error %u\n",
          (unsigned) xerr);
...
if (!(sctx = XmlSchemaCreate(xctx, &xerr, NULL))
    printf("Failed to create schema context, error %u\n",
          (unsigned) xerr);
...
If (xerr = XmlSchemaLoad(sctx, "my_schema.xsd", NULL))
    printf("Failed to load schema, error %u\n",
          (unsigned) xerr);

if(!(ppevctx = XmlEvCreatePPCtx(xctx, &xerr, NULL)))
    printf("Failed to create EVENT context, error %u\n",
          (unsigned) xerr);

if(xerr = XmlEvLoadPPDoc(xctx, ppevctx, "file", "test.xml", 0, NULL))
    printf("Failed to load Document, error %u\n",
          (unsigned) xerr);

...
If(!(svevctx = XmlEvCreateSVCtx(xctx, sctx, ppevctx, &xerr)))
    printf("Failed to create SVcontext, error %u\n",
          (unsigned) xerr);
...
for(;;)
{
    xmlevtype cur_event;
    cur_event = XmlEvNext(svevctx);
    switch(cur_event)
    {
        case XML_EVENT_FATAL_ERROR:
            printf("FATAL ERROR");
            /* error processing goes here */
            return;
        case XML_EVENT_ERROR:
            XmlEvGetError(svevctx, oratext *msg);
            printf("Validation Failed, Error %s\n", msg);
            break;
        case XML_EVENT_START_ELEMENT:
            printf("<%s>", XmlEvGetName(svevctx));
            break;
        ...
        case XML_EVENT_END_DOCUMENT:
            printf("END DOCUMENT");
    }
}
```



```

        return;
    }
}
...
XmlEvDestroySVCtx(svevctx);
XmlSchemaDestroy(sctx);
XmlEvDestroyCtx(ppevctx);
XmlDestroyCtx(xctx);

```

22.5.2 Using Opaque Mode

In opaque mode, the streaming validator reads the instance document to be validated as a sequence of events from the producer, but it does not pass the events to the application (consumer). It returns `XMLERR_OK` on success and an error number on failure.

After the schema has been loaded and the XML events context has been initialized, an application can validate the document in this mode by invoking `XmlEvSchemaValidate()`. The signature of this function takes a pointer to the events context. The declaration is:

```

xmlerr XmlEvSchemaValidate(xmlctx *xctx, xsdctx *sctx, xmlevctx *evctx,
    oratext **errmsg);
/* Returns (xmlerr), the error code */

```

22.5.2.1 Error Handling in Opaque Mode

When the streaming validator encounters an error, `XmlEvSchemaValidate()` returns an error number. This could be because of a parse error or a validation error. The application can then use the existing `XmlEvGetError` APIs to get the error message.

The error message is parameterized and typically has all of the errors leading up to the point where the streaming validator terminated.

22.5.2.2 Example of Opaque Mode Application

An example of opaque mode application is presented.

Example 22-2 Example of Streaming Validator in Opaque Mode

```

#include "xmlev.h"
...
xmlevctx *ppevctx;
xmlctx *xctx;
xsdctx *sctx;
oratext **errmsg;
xmlerr xerr;

if (!(xctx = XmlCreate(&xerr, (oratext *) "test")))
    printf("Failed to create XML context, error %u\n", (unsigned) xerr);
...
if (!(sctx = XmlSchemaCreate(xctx, &xerr, NULL)))
    printf("Failed to create schema context, error %u\n", (unsigned) xerr);
...
if (xerr = XmlSchemaLoad(sctx, "my_schema.xsd", NULL))
    printf("Failed to load schema, error %u\n", (unsigned) xerr);

if (!(ppevctx = XmlEvCreatePPCtx(xctx, &xerr, NULL)))
    printf("Failed to create EVENT context, error %u\n", (unsigned) xerr);

```

```

if(xerr = XmlEvLoadPPDoc(xctx, ppevctx, "file", "test.xml", 0, NULL))
    printf("Failed to load Document, error %u\n", (unsigned) xerr);

if((xerr = XmlEvSchemaValidate(xctx, sctx, ppevctx, errmsg)))
{
    printf("Validation Failed, Error: %s\n", errmsg);
}
...
XmlSchemaDestroy(sctx);
XmlEvDestroyCtx(ppevctx);
XmlDestroyCtx(xctx);

```

22.5.3 Using Function XmlSchemaLoad() With an Existing DOM

Function `XmlSchemaLoad()` accepts two fixed arguments and a set of variable properties. The first argument is the schema context; the second is the URL location of the schema document.

Starting with Oracle Database 11g Release 1 (11.1), you can use property `schema_dom_callback` to provide access to the schema DOM given a URL. The property is a callback function provided by the application. If supplied, the schema load function uses this callback to access the DOM for the main schema and to access any included, imported, or redefined schemas.

The callback signature is as follows:

```

typedef xmlDocnode* (*xmlsch_dom_callback) (xmlctx *xctx, oratext *uri,
                                           xmlerr *xerr);

```

The callback accepts a URI (the schema load function passes in the URI of the document desired) and returns the document node. [Example 22-3](#) (page 22-8) illustrates this.

Example 22-3 *XmlSchemaLoad() Example*

```

# include "xmlev.h"
...
xmlctx *xctx;
xsdctx *sctx;
xmlDocnode *doc;

if (!(xctx = XmlCreate(&xerr, (oratext *) "test")))
    printf("Failed to create XML context, error %u\n", (unsigned) xerr);
...
if (!(sctx = XmlSchemaCreate(xctx, &xerr, NULL)))
    printf("Failed to create schema context, error %u\n", (unsigned) xerr);
...
If (xerr = XmlSchemaLoad(sctx, schema_uri, "schema_dom_callback", func1, NULL))
    printf("Failed to load schema, error %u\n", (unsigned) xerr);
...
XmlSchemaDestroy(sctx);
XmlDestroyCtx(xctx);

```

22.5.4 Validation Options

You can supply options to the validation process using `XmlSchemaSetValidateOptions()`.

For example:

```

XmlSchemaSetValidateOptions(scctx, "ignore_id_constraint", (boolean)TRUE, NULL);

```

The options are:

- `ignore_id_constraint` (existing before Oracle Database 11g Release 1 (11.1))
- `ignore_sch_location` (existing before Oracle Database 11g Release 1 (11.1))
- `ignore_par_val_rest` (existing before Oracle Database 11g Release 1 (11.1))
- `ignore_pattern_check`: When this property is `TRUE`, the streaming validator ignores pattern-facet checks. The default is `FALSE`.
- `no_events_for_defaults`: When this property is `TRUE`, the streaming validator does not return events for default values added to the instance document. *This option can be used only in the transparent case.*

Example 22-4 Example of Streaming Validator Using New Options

```
# include "xmlev.h"
...
xmlevctx *ppevctx;
xmlctx *xctx;
xsdctx *sctx;
xmlerr xerr;
orertext **errmsg;

if (!(xctx = XmlCreate(&xerr, (orertext *) "test"))
    printf("Failed to create XML context, error %u\n", (unsigned) xerr);
...
if (!(sctx = XmlSchemaCreate(xctx, &xerr, NULL))
    printf("Failed to create schema context, error %u\n", (unsigned) xerr);
...
if (xerr = XmlSchemaLoad(sctx, "my_schema.xsd", NULL))
    printf("Failed to load schema, error %u\n", (unsigned) xerr);
if (!(ppevctx = XmlEvCreatePPCtx(xctx, &xerr, "file", "test.xml", NULL))
    printf("Failed to create EVENT context, error %u\n", (unsigned) xerr);

if (xerr = XmlEvLoadPPDoc(xctx, ppevctx, "file", "test.xml", 0, NULL))
    printf("Failed to load Document, error %u\n", (unsigned) xerr);

XmlSchemaSetValidateOptions(sctx, "ignore_id_constraint", TRUE,
                             "ignore_pattern_facet", TRUE, NULL);
if ((xerr = XmlEvSchemaValidate(xctx, sctx, ppevctx, errmsg)))
{
    printf("Validation Failed, Error: %s\n", errmsg);
}
...
XmlSchemaDestroy(sctx);
XmlEvDestroyCtx(ppevctx);
XmlDestroyCtx(xctx);
```

Determining XML Differences Using C

An explanation is given of how to determine the differences between two Extensible Markup Language (XML) inputs and apply the differences as a patch to one of the XML documents.

Topics:

- [Overview of XMLDiff in C](#) (page 23-1)
- [Using XmlDiff](#) (page 23-2)
- [Using XmlPatch](#) (page 23-11)
- [Using XmlHash](#) (page 23-13)

23.1 Overview of XMLDiff in C

You can use Oracle `XmlDiff` to determine the differences between two similar XML documents. It generates an `Xdiff` instance document that indicates the differences. The `Xdiff` document is an XML document that conforms to an XML schema, the `Xdiff` schema.

You can then use `XmlPatch`, which takes the `Xdiff` instance document and applies the changes to other documents. You can use this process to apply the same changes to a large number of XML documents.

`XmlDiff` supports only the Document Object Model (DOM) application programming interface (API) for input and output.

`XmlPatch` also supports the DOM for the input and patch documents.

You can use `XmlDiff` and `XmlPatch` through a C API or a command-line tool. They are exposed by two structured query language (SQL) functions.

An `XmlHash` C API is provided to compute the hash value of an XML tree or subtree. If hash values of two trees or subtrees are equal, the trees are identical to a very high probability.

23.1.1 Process Flow for XMLDiff

The XMLDiff process flow is described.

1. The two input documents are compared by `XmlDiff`.
2. `XmlDiff` creates a `Xdiff` instance document.
3. The application can pass the `Xdiff` instance document to `XmlPatch`, if this is required.

4. `XmlPatch` can apply the differences captured from the comparison to other documents as specified by the application.

23.2 Using XmlDiff

`XmlDiff` compares the trees that represent two input documents, to determine their differences. Both input documents must use the same character-set encoding. The `Xdiff` (output) instance document has the same encoding as the data encoding (DOM encoding) of the input documents.

23.2.1 User Options for Comparison Optimization

There are two optimization options for comparison: global and local optimization.

- Global Optimization—Default

The whole document trees are compared.

- Local Optimization

Comparison is at the sibling level. Local optimization compares siblings under the corresponding parents from two trees.

Global optimization can take more time and space for large documents but always produces the smallest set of differences (the optimal difference). Local optimization is much faster, but may not produce the optimal difference.

23.2.2 User Option for Hashing

Hashing generally speeds up global optimization with a small possible loss in quality. Hashing improves the quality of the difference output, with local optimization. Using different hash levels may generate both local and global differences. You can specify the use of hashing for both local and global optimization.

To specify hashing, provide the `hashLevel` parameter. If `hashLevel` is greater than 1, then only the `DOMHash` values are used for comparing all subtrees at `depth >= hashLevel` of difference. If the hash values are equal, then the subtrees are presumed to be equal.

23.2.3 How XmlDiff Looks at Input Documents

How `XmlDiff` handles input documents is described.

`XmlDiff` ignores differences in the order of attributes while doing the comparison.

`XmlDiff` ignores `DocType` declarations. Files are not validated against the document type definition (DTD).

`XmlDiff` ignores any differences in the namespace prefixes if the namespace prefixes refer to the same namespace Universal Resource Identifier (URI). Otherwise, if two nodes have the same local name and content but differ in namespace URI, these differences are indicated.

Note:

`XmlDiff` operates on its input documents in a nonschema-based way. It does not operate on elements or attributes in a type-aware manner.

23.2.4 Using the XmlDiff Command-Line Utility

The command-line options for utility `XmlDiff` are described.

Table 23-1 *XmlDiff Command-Line Options for the C Language*

Option	Description
<code>-e encoding</code>	Specify default input-file encoding. If no encoding is specified in XML file, this encoding is assumed for input.
<code>-E encoding</code>	Specify output/data encoding. DOMs and the <code>xdiff</code> instance document are created in this encoding. Default is 8-bit encoding of Unicode (UTF-8).
<code>-h hashLevel</code>	Specify the hash level. 0 means none. If greater than 1, starting depth to use hashing for subtrees.
<code>-g</code>	Set global optimization (default).
<code>-l</code>	Set local optimization.
<code>-p</code>	Show this usage help.
<code>-u</code>	Disable update operation.

23.2.5 Sample Input Document

A sample input XML document is presented.

[Example 23-1](#) (page 23-3) is a sample XML document that you can use to explain updates resulting from using both `XmlDiff` and `XmlPatch`. It is followed by some hypothetical changes.

Assume that there is another file, `book2.xml`, that looks just like [Example 23-1](#) (page 23-3) except that it causes these actions:

- Deletes "The Eleventh Commandment", a `delete-node` operation.
- Changes the country code for the "C++ Primer" to US from USA, an `update-node` operation.
- Adds a description to "Emperor's New Mind", an `append-node` operation.
- Adds the edition to "Evening News", an `insert-node-before` operation.
- Updates the price of "Evening News", an `update-node` operation.

Example 23-1 *book1.xml*

```
<?xml version="1.0"?>
<booklist xmlns="http://booklist.oracle.com">
  <book>
    <title>Twelve Red Herrings</title>
    <author>Jeffrey Archer</author>
    <publisher>Harper Collins</publisher>
    <price>7.99</price>
  </book>
  <book>
```

```

<title language="English">The Eleventh Commandment</title>
<author>Jeffrey Archer</author>
<publisher>McGraw Hill</publisher>
<price>3.99</price>
</book>
<book>
<title language="English" country="USA">C++ Primer</title>
<author>Lippmann</author>
<publisher>Harper Collins</publisher>
<price>4.99</price>
</book>
<book>
<title>Emperor's New Mind</title>
<author>Roger Penrose</author>
<publisher>Oxford Publishing Company</publisher>
<price>15.9</price>
</book>
<book>
<title>Evening News</title>
<author>Arthur Hailey</author>
<publisher>MacMillan Publishers</publisher>
<price>9.99</price>
</book>
</booklist>

```

23.2.6 Sample Xdiff Instance Document

A sample Xdiff instance document is presented.

This section shows the Xdiff instance document produced by the comparison of these two XML files described in the previous section. The sections that follow explain the XML processing instructions and the operations on this document.

You can invoke XmlDiff:

```
> xmldiff book1.xml book2.xml
```

You can also examine the sample application for arguments and flags.

Example 23-2 Sample Xdiff Instance Document

```

<?xml version="1.0" encoding="UTF-8"?>
<xd:xdiff xsi:schemaLocation="http://xmlns.oracle.com/xdb/xdiff.xsd
xmlns:xd="http://xmlns.oracle.com/xdb/xdiff.xsd" xmlns:xsi="http://www.w3.org/2001/
XMLSchema-instance"
xmlns:oraxdfns_0="http://booklist.oracle.com">
  <?oracle-xmldiff operations-in-docorder="true" output-model="snapshot"
diff-algorithm="global"?>
    <xd:delete-node xd:node-type="element" xd:xpath="/oraxdfns_0
      :booklist[1]/oraxdfns_0:book[2]"/>
    <xd:update-node xd:node-type="attribute"
      xd:parent-xpath="/oraxdfns_0:booklist[1]/oraxdfns_0:book[3]/oraxdfns_0
        :title[1]" xd:attr-local="country">
      <xd:content>US</xd:content>
    </xd:update-node>
    <xd:append-node xd:node-type="element" xd:parent-xpath="/oraxdfns_0
      :booklist[1]/oraxdfns_0:book[4]">
      <xd:content>
        <oraxdfns_0:description> This is a classic </oraxdfns_0:description>
      </xd:content>
    </xd:append-node>
    <xd:insert-node-before xd:node-type="element" xd:xpath="/oraxdfns_0

```



```

        :booklist[1]/oraxdfns_0:book[5]/oraxdfns_0:author[1]">
<xd:content>
  <oraxdfns_0:edition>Hardcover</oraxdfns_0:edition>
</xd:content>
</xd:insert-node-before>
<xd:update-node xd:node-type="text" xd:xpath="/oraxdfns_0
  :booklist[1]/oraxdfns_0:book[5]/oraxdfns_0:price[1]/text()[1]">
  <xd:content>12.99</xd:content>
</xd:update-node>
</xd:xdiff>

```

23.2.7 Output Model and XML Processing Instructions

The `Xdiff` instance document uses some XML processing instructions (shown in bold in the previous section) that are used to represent certain aspects of the differencing process.

See [Xdiff Schema](#) (page 23-7). These instructions and related options are:

- `operations-in-docorder`: Options are `true` or `false`:
 - `true`—The `Xdiff` instance document refers to the nodes from the first document in the same order as in the document.
 - `false`—The `Xdiff` instance document does not refer to the nodes from the first document in the same order as in the document.

The output of global optimization meets the `operations-in-docorder` requirement, but local optimization does not.

- `output-model`: Options are:
 - `snapshot`—`XmlDiff` generates output in snapshot model and follows the UNIX *diff* model. Each operation uses `XPath` as if no operations have been applied to the input document. This is the default. `XmlPatch` can handle this model only if `operations-in-docorder` is set to `true` and the `XPaths` are simple. Simple `XPaths` require a child axis, no wild cards, and must use positional predicates, such as `/root[1]/child[2]/text()[2]`.
 - `current`—Each operation uses `XPath` as if all operations up to the previous one have been applied to the input document. Even though `XmlDiff` does not generate differences in the current model, `XmlPatch` can handle a hand-crafted `diff` document in the current model
- `diff-algorithm`: Options indicate which optimization generated the differences.
 - Global optimization
 - Local optimization

See Also:

[User Options for Comparison Optimization](#) (page 23-2).

23.2.8 Xdiff Operations

`XmlDiff` captures differences using operations indicated by the `Xdiff` instance document. The `XmlDiff` operations are described.

Table 23-2 Xdiff Operation Attributes

Attribute	Description
parent-path or xpath	Specifies the XPATH location of the parent node of the operand node or the XPATH location of node.
node-type	Specifies the type of the operand node.
content	Child element that specifies the new subtree or value appended or inserted.

The `xdiff` operations, presented in the `xdiff` instance document, are:

- `append-node`:
The `append-node` element specifies that a node of the given type is added as the last child of the given parent.
- `insert-node-before`:
The `insert-node-before` element specifies that a node of the given type is inserted before the given reference node.
- `delete-node`:
The `delete-node` element specifies that the node be deleted along with all its children. You can use this element to delete elements, comments, and so on.
- `update-node`:
The `update-node` element specifies that the value associated with the node with the given XPath expression is updated to the new value, which is specified. Content is the value for a text node. The value of an attribute is the value for an attribute node.
 - Update for Text Nodes:
 - Generation of update node operations can be turned off by the user.
 - The value of an attribute is the value for an attribute node.
 - `update-node` is generated for text nodes only by global optimization.
 - Update for Elements:
 - `XmlDiff` does not generate update operations for element nodes.

You can either manually modify the `xdiff` instance document to create an update operation that works with `XmlPatch`, or provide a totally hand-written `xdiff` instance document. All children of the element operated on by the update are deleted. Any new subtree specified under the `content` node is imported.

23.2.9 Format of Xdiff Instance Document

The output of `XmlDiff`, the `xdiff` instance document, is an XML document that conforms to the `xdiff` XML schema. The output document contains a sequence of operations describing the differences between the two input documents. If you apply the differences to the first document, you obtain the second document.

23.2.10 Xdiff Schema

An Xdiff XML schema, to which an Xdiff instance document (output) adheres, is presented.

Example 23-3 Xdiff Schema: *xdiff.xsd*

```
<schema targetNamespace="http://xmlns.oracle.com/xdb/xdiff.xsd"
  xmlns="http://www.w3.org/2001/XMLSchema"
  xmlns:xd="http://xmlns.oracle.com/xdb/xdiff.xsd"
  version="1.0" elementFormDefault="qualified"
  attributeFormDefault="qualified">
  <annotation>
    <documentation xml:lang="en">
      Defines the structure of XML documents that capture the difference
      between two XML documents. Changes that are not supported by Oracle
      XmlDiff may not be expressible in this schema.

      'oracle-xmldiff' PI in Xdiff document:

      We use 'oracle-xmldiff' PI to describe certain aspects of the diff.
      The PI denotes values for 'operations-in-docorder' and 'output-model'.
      The output of XmlDiff has the PI always. If the user hand-codes a diff doc
      then it must also have the PI in it as the first child of top level xdiff
      element, to be able to call XmlPatch.

      operations-in-docorder:
      Can be either 'true' or 'false'.
      If true, the operations in the diff document refer to the
      elements of the input doc in the same order as document order. Output of
      global algorithm meets this requirement while local does not.

      output-model:
      output models for representing the diff. Can be either 'Snapshot' or
      'Current'.

      Snapshot model:
      Each operation uses Xpaths as if no operations
      have been applied to the input document. (like UNIX diff)
      This is the model used in the output of XmlDiff. XmlPatch works with
      this (and the current model too).
      For XmlPatch to handle this model, "operations-in-docorder" must be
      true and the Xpaths must be simple. (see XmlDif C API documentation).

      Current model:
      Each operation uses Xpaths as if all operations till the previous one
      have been applied to the input document. Works with XmlPatch even if
      the 'operations-in-docorder' criterion is not met and the xpaths are
      not simple.
    </documentation>
  </annotation>
  <!-- Enumerate the supported node types -->
  <simpleType name="xdiff-nodetype">
    <restriction base="string">
      <enumeration value="element"/>
      <enumeration value="attribute"/>
      <enumeration value="text"/>
    </restriction>
  </simpleType>
</schema>
```

```

        <enumeration value="cdata" />
        <enumeration value="entity-reference" />
        <enumeration value="entity" />
        <enumeration value="processing-instruction" />
        <enumeration value="notation" />
        <enumeration value="comment" />
    </restriction>
</simpleType>

<element name="xdiff">
    <complexType>
        <choice minOccurs="0" maxOccurs="unbounded">
            <element name="append-node">
                <complexType>
                    <sequence>
                        <element name="content" type="anyType" />
                    </sequence>
                    <attribute name="node-type" type="xd:xdiff-nodetype" />
                    <attribute name="xpath" type="string" />
                    <attribute name="parent-xpath" type="string" />
                    <attribute name="attr-local" type="string" />
                    <attribute name="attr-nsuri" type="string" />
                </complexType>
            </element>

            <element name="insert-node-before">
                <complexType>
                    <sequence>
                        <element name="content" type="anyType" />
                    </sequence>
                    <attribute name="xpath" type="string" />
                    <attribute name="node-type" type="xd:xdiff-nodetype" />
                </complexType>
            </element>

            <element name="delete-node">
                <complexType>
                    <attribute name="node-type" type="xd:xdiff-nodetype" />
                    <attribute name="xpath" type="string" />
                    <attribute name="parent-xpath" type="string" />
                    <attribute name="attr-local" type="string" />
                    <attribute name="attr-nsuri" type="string" />
                </complexType>
            </element>

            <element name="update-node">
                <complexType>
                    <sequence>
                        <element name="content" type="anyType" />
                    </sequence>
                    <attribute name="node-type" type="xd:xdiff-nodetype" />
                    <attribute name="parent-xpath" type="string" />
                    <attribute name="xpath" type="string" />
                    <attribute name="attr-local" type="string" />
                    <attribute name="attr-nsuri" type="string" />
                </complexType>
            </element>

            <element name="rename-node">
                <complexType>
                    <sequence>
                        <element name="content" type="anyType" />
                    </sequence>
                </complexType>
            </element>
        </choice>
    </complexType>
</element>

```

```

        </sequence>
        <attribute name="xpath" type="string"/>
        <attribute name="node-type" type="xd:xdiff-nodetype"/>
    </complexType>
</element>
</choice>
<attribute name="xdiff-version" type="string"/>
</complexType>
</element>
</schema>

```

23.2.11 Using XMLDiff in an Application

In an application, `XmlDiff` takes the source types and locations of the input documents as arguments. The source type can be a URL, file, `orastream` and `stream` context pointers, `buffer`, and `buffer_length` pointers or the pointer to a DOM document element (`docelement`).

`XmlDiff` returns the document node for the DOM for the `Xdiff` instance document.

`XmlDiff` builds the DOM for the two documents, if they are not already provided as DOM, before performing a comparison.

See Also:

Oracle Database XML C API Reference for the C API for the flags that control the behavior of `XmlDiff`

Example 23-4 XMLDiff Application

```

# include <xmldf.h>
...
xmlctx      *xctx;
xmldocnode *doc1, *doc2, *doc3;
uword       hash_level;
oratext     *s, *inp1 = "book1.xml", *inp2="book2.xml";
xmlerr      err;
ub4         flags;

flags = 0; /* defaults : global algorithm */
hash_level = 0; /* no hashing */
/* create XML meta context */
if (!(xctx = XmlCreate(&err, (oratext *) "XmlDiff", NULL)))
{
    printf("Failed to create XML context, error %u\n",
(unsigned) err);
    err_exit("Exiting");
}
/* Load the two input files */
if (!(doc1 = XmlLoadDom(xctx, &err, "file", inp1, "discard_whitespace", TRUE,
    NULL)))
{
    printf("Parsing first file failed, error %u\n", (unsigned)err);
    err_exit((oratext *)"Exiting.");
}
if (!(doc2 = XmlLoadDom(xctx, &err, "file", inp2, "discard_whitespace", TRUE,
    NULL)))
{
    printf("Parsing second file failed, error %u\n", (unsigned)err);
}

```

```

    err_exit((oratest *)"Exiting.");
}

/* run XmlDiff on the DOM trees. */

doc3 = XmlDiff(xctx, &err, flags, XMLDF_SRCT_DOM, doc1, NULL, XMLDF_SRCT_DOM,
              doc2, NULL, hash_level, NULL);

if(!doc3)
    printf("XmlDiff Failed, error %u\n", (unsigned)err);
else
    {
    if(err != XMLERR_OK)
        printf("XmlDiff returned error %u\n", (unsigned)err);
    /* Now we have the DOM tree in doc3 which represent the Diff */
    ...
    }

XmlFreeDocument(xctx, doc1);
XmlFreeDocument(xctx, doc2);
XmlFreeDocument(xctx, doc3);
XmlDestroy(xctx);

```

23.2.12 Customized Output

A customized output builder stores differences in any format suitable to the application. You can create your own customized output builder, rather than using the default `Xdiff` instance document, which is generated by `XmlDiff` and that conforms to the `Xdiff` schema.

To create a customized output builder, you must provide a callback that can be called after `XmlDiff` determines the differences. The differences are passed to the callback as an array of `xmldfop`. The callback may be called multiple times as the differences are being generated.

Using a customized output builder may perform better than using the default, because it does not have to maintain the internal state necessary for `XPath` generation.

By default, `XmlDiff` captures the differences in XML conforming to the `Xdiff` schema. If necessary, plug in your own output builder. The differences are represented as an array `xmldfop`. You must write an output builder callback function. The function signature is:

```
xmlerr(*xdfobcb)(void *uctx, xmldfop *escript, ub4 escript_siz);
```

`uctx` is the user specific context.

`escript` is the array of size `escript_siz`:

```
diff[escript_siz]
```

`mctx` is the memory context.

Supply this memory context through properties to `XmlDiff()`. Use this memory context to allocate `escript`. You must later free `escript`.

Invoke the output builder callback after the differences have been found which happens even before the invocation of `XmlDiff()` returns. The output builder callback can be called multiple times.

Example 23-5 Customized XMLDiff Output

```

/* Sample useage: */
...
#include <orastruc.h> / * for 'oraprop' * /
...
static oraprop diff_props[] = {
    ORAPROP(XMLDF_PROPN_CUSTOM_OB, XMLDF_PROPI_CUSTOM_OB, POINTER),
    ORAPROP(XMLDF_PROPN_CUSTOM_OBMCX, XMLDF_PROPI_CUSTOM_OBMCX, POINTER),
    ORAPROP(XMLDF_PROPN_CUSTOM_OBUCX, XMLDF_PROPI_CUSTOM_OBUCX, POINTER),
    { NULL }
};
...
oramemctx *mymemctx;
...
xmlerr myob(void *uctx, xmldfop *escript, ub4 escript_siz)
{
    /* process diff which is available in escript * /

    /* free escript - the caller has to do this * /
    OraMemFree(mymemctx, escript);
}

main()
{
    ...
    myctx *myctx;

    diff_props[0].value_oraprop.p_oraprop_v = myob;
    diff_props[1].value_oraprop.p_oraprop_v = mymemctx;
    diff_props[2].value_oraprop.p_oraprop_v = myctx;
    XmlDiff(xctx, &err, 0, doc1, NULL, 0, doc2, NULL, 0, diff_props);
    ...
}

```

23.3 Using XmlPatch

XmlPatch takes an Xdiff instance document, generated by XmlDiff or created by another mechanism, and follows the instructions in the Xdiff instance document to modify other XML documents.

- [Using the XmlPatch Command-Line Utility](#) (page 23-11)
- [Using XmlPatch in an Application](#) (page 23-12)

23.3.1 Using the XmlPatch Command-Line Utility

Command-line options for utility XmlPatch are described.

Table 23-3 XmlPatch for C Command-Line Options

Option	Description
-e encoding	Specify default input-file encoding. If no encoding is specified in XML file, this encoding is assumed for input.
-E encoding	Specify output/data encoding. DOMs and patched document are created in this encoding. Default is UTF-8.
-i	Interpret file names as URLs.

Table 23-3 (Cont.) XmlPatch for C Command-Line Options

Option	Description
-h	Show this usage help.

23.3.2 Using XmlPatch in an Application

XmlPatch takes the source types and locations of the input document and the diff document as arguments. The source type can be a URL, file, orastream and stream context pointers, buffer and buffer_length pointers, or the pointer to a DOM document element (docelement).

See Also:

Oracle Database XML C API Reference for the C API for the flags that control the behavior of XmlPatch

The modes that were set by the Xdiff schema affect how XmlPatch works.

If the output-model is Snapshot, XmlPatch only works if operations-in-docorder is TRUE.

If the output-model is Current, it is not necessary that operations-in-docorder be set to TRUE.

Example 23-6 Sample Application for XmlPatch

```

...
#include <xmldf.h>
...
xmlctx      *xctx;
xmldocnode *doc1, *doc2;
oratext     *s;
oratext     *inp1 = "book1.xml"; /* input document */
oratext     *inp2 = "diff.xml", /* diff document */
xmlerr      err;

/* create XML meta context */
if (!(xctx = XmlCreate(&err, (oratext *) "XmlPatch", NULL)))
{
    printf("Failed to create XML context, error %u\n",
(unsigned) err);
    err_exit("Exiting");
}
/* Load the two input files */
if (!(doc1 = XmlLoadDom(xctx, &err, "file", inp1, "discard_whitespace", TRUE,
NULL)))
{
    printf("Parsing first file failed, error %u\n", (unsigned)err);
    err_exit((oratext *)"Exiting.");
}
if (!(doc2 = XmlLoadDom(xctx, &err, "file", inp2, "discard_whitespace", TRUE,
NULL)))
{
    printf("Parsing second file failed, error %u\n", (unsigned)err);
    err_exit((oratext *)"Exiting.");
}

```



```

/* call XmlPatch */
if(!XmlPatch(xctx, &err, 0, XMLDF_SRCT_DOM, doc1, NULL, XMLDF_SRCT_DOM,
             doc2, NULL, NULL));

    printf("XmlPatch Failed, error %u\n", (unsigned)err);
else
{
if(err != XMLERR_OK)
printf("XmlPatch returned error %u\n", (unsigned)err);
/* Now we have the patched document in doc1 */
...
}

XmlFreeDocument(xctx, doc1);
XmlFreeDocument(xctx, doc2);
XmlDestroy(xctx);

```

23.4 Using XmlHash

XmlHash computes a hash value for an XML tree. If the hash values of two trees are equal, it is probable that they are the same XML. You can use XmlHash to do a quick comparison to see if an XML tree is already in the database.

You can run XmlDiff again, if necessary, on any matches, to be absolutely certain there is a match. You can compute the hash value of the new document and query the database for it.

[Example 23-7](#) (page 23-13) shows a sample program that uses XmlHash.

Example 23-7 *XmlHash Program*

```

sword main(sword argc, char *argv[])
{
    xmlctx      *xctx;
    xmldfsrct   srct;
    oratext     *data_encoding, *input_encoding, *s, *inpl;
    ub1         flags;
    xmlerr      err;
    ub4         num_args;
    xmlhasht    digest;
    flags = 0; /* defaults */
    srct = XMLDF_SRCT_FILE;
    inpl = "somexml.xml";
    xctx = XmlCreate(&err, (oratext *) "XmlHash", NULL);

    if (!xctx)
    {
        /* handle error with creating xml context and exit */
        ...
    }

    /* run XmlHash */
    err = XmlHash(xctx, &digest, 0, srct, inpl, NULL, NULL);
    if(err)
        printf("XmlHash returned error:%d \n", err);
    else
        txdfha_pd(digest);

    XmlDestroy(xctx);

    return (sword )err;
}

```

```
    }

    /* print bytes in xml hash */
    static void txdhfa_pd(xmlhasht digest)
    {
        ub4 i;

        for(i = 0; i < digest.l_xmlhasht; i++)
            printf("%x ", digest.d_xmlhasht[i]);

        printf("\n");
    }
}
```

23.4.1 Invoking XmlDiff and XmlPatch

XmlDiff and XmlPatch can be called as command-line tools and from the C language. They are also available as SQL functions.

See Also:

- *Oracle Database SQL Language Reference* XMLDiff
 - *Oracle Database SQL Language Reference*, XMLPatch
-
-

Using SOAP with the Oracle XML Developer's Kit for C

An explanation is given of how to use Simple Object Access Protocol (SOAP) with the Oracle XML Developer's Kit (XDK) for C.

Topics:

- [Introduction to SOAP for C](#) (page 24-1)
- [SOAP C Functions](#) (page 24-5)
- [SOAP Example 1: Sending an XML Document](#) (page 24-7)
- [SOAP Example 2: A Response Asking for Clarification](#) (page 24-12)
- [SOAP Example 3: Using POST](#) (page 24-14)

See Also:

Oracle XML DB Developer's Guide

24.1 Introduction to SOAP for C

SOAP is an Extensible Markup Language (XML) protocol for exchanging structured and typed information between peers using HTTP and HTTPS in a distributed environment. Only HTTP 1.0 is supported in XDK for Oracle Database 10g release 2.

SOAP has three parts:

- The SOAP envelope which defines how to present what is in the message, who must process the message, and whether that processing is optional or mandatory.
- A set of serialization and deserialization rules for converting application data types to and from XML.
- A SOAP remote procedure call (RPC) that defines calls and responses.

Note:

RPC and serialization/deserialization are not supported in this release.

SOAP is operating system and language-independent because it is XML-based. This chapter presents the C implementation of the functions that read and write the SOAP message.

SOAP Version 1.2 is the definition of an XML-based message which is specified as an XML Infoset (an abstract data set, it could be XML 1.0) that gives a description of the message contents. Version 1.1 is also supported.

See Also:

W3C SOAP 1.2 specifications at:

- <http://www.w3.org/TR/soap12-part0/> for Primer
 - <http://www.w3.org/TR/soap12-part1/> for Messaging Framework
 - <http://www.w3.org/TR/soap12-part2/> for Adjuncts
-

24.1.1 SOAP Messaging Overview

SOAP is a lightweight protocol for sending and receiving requests and responses across the Internet. Because it is based on XML and transport protocols such as HTTP, it is not blocked by most firewalls. SOAP is independent of operating system, implementation language, and object model.

The power of SOAP is its ability to act as the glue between heterogeneous software components. For example, Visual Basic clients can invoke Common Object Request Broker Architecture (CORBA) services running on UNIX computers; Macintosh clients can invoke Perl objects running on Linux.

SOAP messages have these parts:

- An **envelope** that contains the message, defines how to process the message and who processes it, and whether processing is optional or mandatory. The `Envelope` element is required.
- A set of **encoding rules** that describe the data types for the application. These rules define a serialization mechanism that converts the application data types to and from XML.
- A **remote procedure call (RPC)** request and response convention. This required element is called a body element. The `Body` element contains a first subelement whose name is the name of a method. This method request element contains elements for each input and output parameter. The element names are the parameter names. RPC is not currently supported in this release.

SOAP is independent of any transport protocol. Nevertheless, SOAP used over HTTP for remote service invocation has emerged as a standard for delivering programmatic content over the Internet.

Besides being independent of transfer protocol, SOAP is also independent of operating system. In other words, SOAP enables programs to communicate even when they are written in different languages and run on different operating systems.

24.1.1.1 SOAP Message Format

Types of SOAP messages are described.

- Requests for a service, including input parameters
- Responses from the requested service, including return value and output parameters

- Optional fault elements containing error codes and information

In a SOAP message, the **payload** contains the XML-encoded data. The payload contains no processing information. In contrast, the message header may contain processing information.

24.1.1.1.1 SOAP Requests

SOAP requests are described.

In SOAP requests, the XML payload contains several elements that include:

- Root element
- Method element
- Header elements (optional)

[Example 24-1](#) (page 24-3) shows the format of a sample SOAP message request. A `GetLastTradePrice` SOAP request is sent to a `StockQuote` service. The request accepts a string parameter representing the company stock symbol and returns a float representing the stock price in the SOAP response.

Example 24-1 SOAP Request Message

```
POST /StockQuote HTTP/1.0
Host: www.stockquoteserver.com
Content-Type: application/soap+xml; charset="utf-8"
Content-Length: nnnn
SOAPAction: "Some-URI"

<SOAP-ENV:Envelope xmlns:SOAP-ENV="http://www.w3.org/2003/05/soap-envelope"
  SOAP-ENV:encodingStyle="http://www.w3.org/2003/05/soap-encoding/">
  <SOAP-ENV:Body>
    <m:GetLastTradePrice xmlns:m="Some-URI">
      <symbol>ORCL</symbol>
    </m:GetLastTradePrice>
  </SOAP-ENV:Body>
</SOAP-ENV:Envelope>
```

In [Example 24-1](#) (page 24-3), the XML document is the SOAP message. The `<SOAP-ENV:Envelope>` element is the top-level element of the XML document. The payload is represented by the method element `<m:GetLastTradePrice>`. XML namespaces distinguish SOAP identifiers from application-specific identifiers.

The first line of the header specifies that the request uses HTTP as the transport protocol:

```
POST /StockQuote HTTP/1.1
```

Because SOAP is independent of transport protocol, the rules governing XML payload format are independent of the use of HTTP for transport of the payload. This HTTP request points to the URI `/StockQuote`. Because the SOAP specification is silent on the issue of component activation, the code behind this URI determines how to activate the component and invoke the `GetLastTradePrice` method.

24.1.1.1.2 Example of a SOAP Response

An example of a SOAP response is presented.

[Example 24-2](#) (page 24-4) shows the format of the response to the request in [Example 24-1](#) (page 24-3). Element `<Price>` contains the stock price for ORCL requested by the first message.

The messages shown in [Example 24-1](#) (page 24-3) and [Example 24-2](#) (page 24-4) show two-way SOAP messaging, that is, a SOAP request that is answered by a SOAP response. A one-way SOAP message does not require a SOAP message in response.

Example 24-2 SOAP Response Message

```
HTTP/1.0 200 OK
Content-Type: application/soap+xml; charset="utf-8"
Content-Length: nnnn

<SOAP-ENV:Envelope xmlns:SOAP-ENV="http://www.w3.org/2003/05/soap-envelope"
  SOAP-ENV:encodingStyle="http://www.w3.org/2003/05/soap-encoding/">
  <SOAP-ENV:Body>
    <m:GetLastTradePriceResponse xmlns:m="Some-URI">
      <Price>13.5</Price>
    </m:GetLastTradePriceResponse>
  </SOAP-ENV:Body>
</SOAP-ENV:Envelope>
```

24.1.2 Using SOAP Clients

SOAP clients are user-written applications that generate XML documents. The documents make a request for a SOAP service and handle a SOAP response. The SOAP implementation in XDK handles requests from any client that sends a valid SOAP request.

The SOAP client application programming interface (API) has these features:

- Supports a synchronous invocation model for requests and responses
- Facilitates the writing of client applications to make SOAP requests
- Encapsulates the creation of the SOAP request and the details of sending the request over the underlying transport protocol
- Supports a pluggable transport, allowing the client to easily change the transport (available transports include HTTP and HTTPS, but only HTTP 1.0 is supported in this release)

A SOAP client must perform these steps to make a request and receive a response:

1. Gather all parameters that are needed to invoke a service.
2. Create a SOAP service request message, which is an XML message that is built according to the SOAP protocol. It contains all the values of all input parameters encoded in XML. This process is called **serialization**.
3. Submit the request to a SOAP server using a transport protocol that is supported by the SOAP server.
4. Receive a SOAP response message.
5. Determine the success or failure of the request by handling the SOAP Fault element.
6. Convert the returned parameter from XML to native data type. This process is called **deserialization**.
7. Use the result as needed.

24.1.3 Using SOAP Servers

The steps performed by a SOAP server when executing a SOAP service request are described.

1. The SOAP server receives the service request.
2. The server parses the XML request and then decides whether to execute or reject the message.
3. If the message is executed, then the server determines whether the requested service exists.
4. The server converts all input parameters from XML into data types that the service understands.
5. The server invokes the service.
6. The server converts the return parameter to XML and generates a SOAP response message.
7. The server sends the response message back to the caller.

24.2 SOAP C Functions

The SOAP C implementation uses the `xml.h` header. A context of type `xmlctx` must be created before a SOAP context can be created.

HTTP aspects of SOAP are hidden from the user. SOAP endpoints are specified as a couple (binding, endpoint) where binding is of type `xmlsoapbind` and the endpoint is a `(void *)` depending on the binding. Currently, only one binding is supported, `XMLSOAP_BIND_HTTP`. For HTTP binding, the endpoint is an `(Oratext *)` URL.

The SOAP layer creates and transports SOAP messages between endpoints, and decomposes received SOAP messages.

The C functions are declared in `xmlsoap.h`. Here is the beginning of that header file:

See Also:

Oracle Database XML C API Reference for the C SOAP APIs

Example 24-3 SOAP C Functions Defined in `xmlsoap.h`

```

FILE NAME
  xmlsoap.h - XML SOAP APIs

FILE DESCRIPTION
  XML SOAP Public APIs

PUBLIC FUNCTIONS
  XmlSoapCreateCtx          - Create and return a SOAP context
  XmlSoapDestroyCtx        - Destroy a SOAP context

  XmlSoapCreateConnection  - Create a SOAP connection object
  XmlSoapDestroyConnection - Destroy a SOAP connection object

  XmlSoapCall               - Send a SOAP message & wait for reply

```

```

    XmlSoapCreateMsg      - Create and return an empty SOAP message
    XmlSoapDestroyMsg    - Destroy a SOAP message created
                          w/XmlSoapCreateMsg

    XmlSoapGetEnvelope   - Return a SOAP message's envelope
    XmlSoapGetHeader     - Return a SOAP message's envelope header
    XmlSoapGetBody       - Return a SOAP message's envelope body

    XmlSoapAddHeaderElement - Adds an element to a SOAP header
    XmlSoapGetHeaderElement - Gets an element from a SOAP header

    XmlSoapAddBodyElement - Adds an element to a SOAP message body
    XmlSoapGetBodyElement - Gets an element from a SOAP message body

    XmlSoapSetMustUnderstand - Set mustUnderstand attr for SOAP hdr elem
    XmlSoapGetMustUnderstand - Get mustUnderstand attr from SOAP hdr elem

    XmlSoapSetRole       - Set role for SOAP header element
    XmlSoapGetRole       - Get role from SOAP header element

    XmlSoapSetRelay      - Set relay Header element property
    XmlSoapGetRelay      - Get relay Header element property

    XmlSoapSetFault      - Set Fault in SOAP message
    XmlSoapHasFault      - Does SOAP message have a Fault?
    XmlSoapGetFault      - Return Fault code, reason, and details

    XmlSoapAddFaultReason - Add additional Reason to Fault
    XmlSoapAddFaultSubDetail - Add additional child to Fault Detail
    XmlSoapGetReasonNum   - Get number of Reasons in Fault element
    XmlSoapGetReasonLang  - Get a lang of a reasons with a
                          particular iindex.

    XmlSoapError         - Get error message(s)

*/

#ifndef XMLSOAP_ORACLE
# define XMLSOAP_ORACLE

# ifndef XML_ORACLE
# include <xml.h>
# endif

/*-----
Package SOAP - Simple Object Access Protocol APIs

W3C: "SOAP is a lightweight protocol for exchange of information
in a decentralized, distributed environment. It is an XML based
protocol that consists of three parts: an envelope that defines a
framework for describing what is in a message and how to process
it, a set of encoding rules for expressing instances of
application-defined datatypes, and a convention for representing
remote procedure calls and responses."
Attachments are allowed only in Soap 1.1
In Soap 1.2 body may not have other elements if Fault is present.

Structure of a SOAP message:

[SOAP message (XML document)

```



```

    [SOAP envelope
      [SOAP header?
        element*
      ]
      [SOAP body
        (element* | Fault)?
      ]
    ]
  ]
  -----*/
  ...

```

24.3 SOAP Example 1: Sending an XML Document

An XML document is presented that shows a request to a travel company for a reservation on a plane flight from New York to Los Angeles for John Smith. A simple example creates the XML document, sends it, receives and decomposes a reply. There is some minimal error checking.

The `DEBUG` option is shown for correcting anomalies. The program may not work on all operating systems. To send this XML document, the first client C program follows these steps:

1. After declaring variables in `main()`, an XML context, `xctx`, is created using `XmlCreate()` and the context is then used to create a SOAP context, `ctx`, using `XmlSoapCreateCtx()`.
2. To construct the message, `XmlSoapCreateMsg()` is called and returns an empty SOAP message.
3. The header is constructed using `XmlSoapAddHeaderElement()`, `XmlSoapSetRole()`, `XmlSoapSetMustUnderstand()`, and `XmlDomAddTextElem()` to fill in the envelope with text.
4. The body elements are created by `XmlSoapAddBodyElement()`, `XmlDomCreateElemNS()`, and a series of invocations of `XmlDomAddTextElem()`. Then `XmlDomAppendChild()` completes the section of the body specifying the New York to Los Angeles flight.
5. The return flight is built in an analogous way. The lodging is added with another `XmlSoapAddBodyElement()` invocation.
6. The connection must be created next with `XmlSoapCreateConnection()`, specifying HTTP binding (the only binding available now) and an endpoint URL.
7. The function `XmlSoapCall()` sends the message over the defined connection with the SOAP server, and then waits for the reply.
8. The message reply is returned in the form of another SOAP message. This is done with `XmlSaveDom()` and `XmlSoapHasFault()` used with `XmlSoapGetFault()` to check for a fault and analyze the fault. The fault is parsed into its parts, which is output in this example.
9. If there was no fault returned, this is followed by `XmlSoapGetBody()` to return the envelope body. `XmlSaveDom()` completes the analysis of the returned message.

10. To clean up, use `XmlSoapDestroyMsg()` on the message and on the reply, `XmlDestroyCtx()` to destroy the SOAP context, and `XmlDestroy()` to destroy the XML context.

Example 24-4 Example 1 SOAP Message

```
<?xml version='1.0' ?>
<env:Envelope xmlns:env="http://www.w3.org/2003/05/soap-envelope">
  <env:Header>
    <m:reservation xmlns:m="http://travelcompany.example.org/reservation"
      env:role="http://www.w3.org/2003/05/soap-envelope/role/next"
      env:mustUnderstand="true">
      <m:reference>uuid:093a2da1-q345-739r-ba5d-pqff98fe8j7d</m:reference>
      <m:dateAndTime>2001-11-29T13:20:00.000-05:00</m:dateAndTime>
    </m:reservation>
    <n:passenger xmlns:n="http://mycompany.example.com/employees"
      env:role="http://www.w3.org/2003/05/soap-envelope/role/next"
      env:mustUnderstand="true">
      <n:name>John Smith</n:name>
    </n:passenger>
  </env:Header>
  <env:Body>
    <p:itinerary
      xmlns:p="http://travelcompany.example.org/reservation/travel">
      <p:departure>
        <p:departing>New York</p:departing>
        <p:arriving>Los Angeles</p:arriving>
        <p:departureDate>2001-12-14</p:departureDate>
        <p:departureTime>late afternoon</p:departureTime>
        <p:seatPreference>aisle</p:seatPreference>
      </p:departure>
      <p:return>
        <p:departing>Los Angeles</p:departing>
        <p:arriving>New York</p:arriving>
        <p:departureDate>2001-12-20</p:departureDate>
        <p:departureTime>mid-morning</p:departureTime>
        <p:seatPreference/>
      </p:return>
    </p:itinerary>
    <q:lodging
      xmlns:q="http://travelcompany.example.org/reservation/hotels">
      <q:preference>none</q:preference>
    </q:lodging>
  </env:Body>
</env:Envelope>
```

Example 24-5 Example 1 SOAP C Client

```
#ifndef S_ORACLE
# include <s.h>
#endif

#ifndef XML_ORACLE
# include <xml.h>
#endif

#ifndef XMLSOAP_ORACLE
# include <xmlsoap.h>
#endif

#define MY_URL "http://my_url.com"
```

```

/* static function declaration */
static xmlerr add_ns_decl(xmlsoapctx *ctx, xmlctx *xctx, xmlemnode *elem,
                          oratext *pfx, oratext *uri);

sb4 main( sword argc, char *argv[])
{
    xmlctx      *xctx;
    xmlerr      xerr;
    xmlsoapctx  *ctx;
    oratext     *url;
    xmlsoapcon  *con;

    xmldocnode *msg1, *reply, *msg2, *msg3;
    xmlemnode  *res, *pas, *pref, *itin, *departure, *ret, *lodging;
    xmlemnode  *departing, *arriving, *trans, *text, *charge, *card, *name;
    xmlemnode  *body, *header;
    boolean     has_fault;
    oratext     *code, *reason, *lang, *node, *role;
    xmlemnode  *detail;
    oratext *comp_uri   = "http://travelcompany.example.org/";
    oratext *mres_uri   = "http://travelcompany.example.org/reservation";
    oratext *trav_uri   = "http://travelcompany.example.org/reservation/travel";
    oratext *hotel_uri  = "http://travelcompany.example.org/reservation/hotels";
    oratext *npas_uri   = "http://mycompany.example.com/employees";

    oratext *tparty_uri = "http://thirdparty.example.org/transaction";
    oratext *estyle_uri = "http://example.com/encoding";
    oratext *soap_style_uri = "http://www.w3.org/2003/05/soap-encoding";
    oratext *estyle     = "env:encodingStyle";
    oratext *finance_uri = "http://mycompany.example.com/financial";

    if (!(xctx = XmlCreate(&xerr, (oratext *)"SOAP_test",NULL)))
    {
        printf("Failed to create XML context, error %u\n", (unsigned) xerr);
        return EX_FAIL;
    }
    /* Create SOAP context */
    if (!(ctx = XmlSoapCreateCtx(xctx, &xerr, (oratext *) "example", NULL)))
    {
        printf("Failed to create SOAP context, error %u\n", (unsigned) xerr);
        return EX_FAIL;
    }

    /* EXAMPLE 1 */
    /* construct message */
    if (!(msg1 = XmlSoapCreateMsg(ctx, &xerr)))
    {
        printf("Failed to create SOAP message, error %u\n", (unsigned) xerr);
        return xerr;
    }
    res = XmlSoapAddHeaderElement(ctx, msg1, "m:reservation", mres_uri, &xerr);
    xerr = XmlSoapSetRole(ctx, res, XMLSOAP_ROLE_NEXT);
    xerr = XmlSoapSetMustUnderstand(ctx, res, TRUE);
    (void) XmlDomAddTextElem(xctx, res, mres_uri, "m:reference",
                            "uuid:093a2dal-q345-739r-ba5d-pqff98fe8j7d");
    (void) XmlDomAddTextElem(xctx, res, mres_uri, "m:dateAndTime",
                            "2001-11-29T13:20:00.000-05:00");
}

```

```

pas = XmlSoapAddHeaderElement(ctx, msg1, "n:passenger", npas_uri, &xerr);
xerr = XmlSoapSetRole(ctx, pas, XMLSOAP_ROLE_NEXT);
xerr = XmlSoapSetMustUnderstand(ctx, pas, TRUE);
(void) XmlDomAddTextElem(xctx, pas, npas_uri, "n:name",
                        "John Smith");

/* Fill body */
/* Itinerary */
itin = XmlSoapAddBodyElement(ctx, msg1, "p:itinerary", trav_uri, &xerr);
/* Departure */
departure = XmlDomCreateElemNS(xctx, msg1, trav_uri, "p:departure");
(void) XmlDomAddTextElem(xctx, departure, trav_uri,
                        "p:departing", "New York");
(void) XmlDomAddTextElem(xctx, departure, trav_uri,
                        "p:arriving", "Los Angeles");
(void) XmlDomAddTextElem(xctx, departure, trav_uri,
                        "p:departureDate", "2001-12-14");
(void) XmlDomAddTextElem(xctx, departure, trav_uri,
                        "p:departureTime", "late afternoon");
(void) XmlDomAddTextElem(xctx, departure, trav_uri,
                        "p:seatPreference", "aisle");
XmlDomAppendChild(xctx, itin, departure);

/* Return */
ret = XmlDomCreateElemNS(xctx, msg1, trav_uri, "p:return");
(void) XmlDomAddTextElem(xctx, ret, trav_uri,
                        "p:departing", "Los Angeles");
(void) XmlDomAddTextElem(xctx, ret, trav_uri,
                        "p:arriving", "New York");
(void) XmlDomAddTextElem(xctx, ret, trav_uri,
                        "p:departureDate", "2001-12-20");
(void) XmlDomAddTextElem(xctx, ret, trav_uri,
                        "p:departureTime", "mid-morning");
pref = XmlDomCreateElemNS(xctx, msg1, trav_uri, "p:seatPreference");
(void) XmlDomAppendChild(xctx, ret, pref);
XmlDomAppendChild(xctx, itin, ret);

/* Lodging */
lodging = XmlSoapAddBodyElement(ctx, msg1, "q:lodging", hotel_uri, &xerr);
(void) XmlDomAddTextElem(xctx, lodging, hotel_uri,
                        "q:preference", "none");

#ifdef DEBUG
/* dump the message in debug mode */
printf("Message:\n");
XmlSaveDom(xctx, &xerr, msg1, "stdio", stdout, "indent_step", 1, NULL);
#endif

/* END OF EXAMPLE 1 */

/* create connection */
url = MY_URL;
if (!(con = XmlSoapCreateConnection(ctx, &xerr, XMLSOAP_BIND_HTTP,
                                   url, NULL, 0, NULL, 0,
                                   "XTest: baz", NULL)))
{
    printf("Failed to create SOAP connection, error %u\n", (unsigned) xerr);
    return xerr;
}

reply = XmlSoapCall(ctx, con, msg1, &xerr);
XmlSoapDestroyConnection(ctx, con);

```

```

    if (!reply)
    {
        printf("Call failed, no message returned.\n");
        return xerr;
    }

#ifdef DEBUG
    printf("Reply:\n");
    XmlSaveDom(xctx, &xerr, reply, "stdio", stdout, NULL);
#endif

    printf("\n=== Header:\n ");
    header = XmlSoapGetHeader(ctx, reply, &xerr);
    if (!header)
    {
        printf("NULL\n");
    }
    else
        XmlSaveDom(xctx, &xerr, header, "stdio", stdout, NULL);

/* check for fault */
has_fault = XmlSoapHasFault(ctx, reply, &xerr);
if(has_fault)
{
    lang = NULL;
    xerr = XmlSoapGetFault(ctx, reply, &code, &reason, &lang,
                          &node, &role, &detail);

    if (xerr)
    {
        printf("error getting Fault %d\n", xerr);
        return EX_FAIL;
    }
    if(code)
        printf("  Code -- %s\n", code);
    else
        printf("  NO Code\n");
    if(reason)
        printf("  Reason -- %s\n", reason);
    else
        printf("  NO Reason\n");
    if(lang)
        printf("  Lang -- %s\n", lang);
    else
        printf("  NO Lang\n");
    if(node)
        printf("  Node -- %s\n", node);
    else
        printf("  NO Node\n");
    if(role)
        printf("  Role -- %s\n", role);
    else
        printf("  NO Role\n");
    if(detail)
    {
        printf("  Detail\n");
        XmlSaveDom(xctx, &xerr, detail, "stdio", stdout, NULL);
        printf("\n");
    }
    else

```

```

        printf("    NO Detail\n");
    }
    else
    {
        body = XmlSoapGetBody(ctx, reply, &xerr);
        printf("==== Body:\n ");
        if (!body)
        {
            printf("NULL\n");
            return EX_FAIL;
        }
        XmlSaveDom(xctx, &xerr, body, "stdio", stdout, NULL);
    }
    (void) XmlSoapDestroyMsg(ctx, reply);
    (void) XmlSoapDestroyMsg(ctx, msg1);
    (void) XmlSoapDestroyCtx(ctx);
    XmlDestroy(xctx);
}

```

24.4 SOAP Example 2: A Response Asking for Clarification

A travel company wants to know which New York airport a traveller, John Smith, will depart from: JFK, EWR, or LGA. It sends a response message that asks for such clarification.

To send this XML document as a SOAP message, substitute this code block for the lines beginning with `/* EXAMPLE 1 */` and ending with `/* END OF EXAMPLE 1 */` in [Example 24-5](#) (page 24-8)

Example 24-6 Example 2 SOAP Message

```

<?xml version='1.0' ?>
<env:Envelope xmlns:env="http://www.w3.org/2003/05/soap-envelope">
  <env:Header>
    <m:reservation xmlns:m="http://travelcompany.example.org/reservation"
      env:role="http://www.w3.org/2003/05/soap-envelope/role/next"
      env:mustUnderstand="true">
      <m:reference>uuid:093a2da1-q345-739r-ba5d-pqff98fe8j7d</m:reference>
      <m:dateAndTime>2001-11-29T13:35:00.000-05:00</m:dateAndTime>
    </m:reservation>
    <n:passenger xmlns:n="http://mycompany.example.com/employees"
      env:role="http://www.w3.org/2003/05/soap-envelope/role/next"
      env:mustUnderstand="true">
      <n:name>John Smith</n:name>
    </n:passenger>
  </env:Header>
  <env:Body>
    <p:itineraryClarification
      xmlns:p="http://travelcompany.example.org/reservation/travel">
      <p:departure>
        <p:departing>
          <p:airportChoices>
            JFK LGA EWR
          </p:airportChoices>
        </p:departing>
      </p:departure>
      <p:return>
        <p:arriving>
          <p:airportChoices>
            JFK LGA EWR
          </p:airportChoices>
        </p:arriving>
      </p:return>
    </p:itineraryClarification>
  </env:Body>
</env:Envelope>

```

```

    </p:arriving>
  </p:return>
</p:itineraryClarification>
</env:Body>
</env:Envelope>

```

Example 24-7 Example 2 SOAP C Client

```

#define XMLSOAP_MAX_NAME      1024

/* we need this function for examples 2 and 3 */
static xmlerr add_ns_decl(xmlsoapctx *ctx, xmlctx *xctx, xmlelemnode *elem,
                        oratext *pfx, oratext *uri)
{
    oratext      *aq, aqbuf[XMLSOAP_MAX_NAME];
    xmldocnode  *doc;
    oratext      *xmlns = "xmlns:";

    /* if no room for "xmlns:usersprefix\0" then fail now */
    if ((strlen((char *)pfx) + strlen((char *)xmlns)) >
        sizeof(aqbuf))
        return EX_FAIL;
    (void) strcpy((char *)aqbuf, (char *)xmlns);
    strcat((char *)aqbuf, (char *)pfx);
    doc = XmlDomGetOwnerDocument(xctx, elem);
    aq = XmlDomSaveString(xctx, doc, aqbuf);
    XmlDomSetAttrNS(xctx, elem, uri, aq, uri);
    return XMLERR_OK;
}

/* EXAMPLE 2 */
/* construct message */
if (!(msg2 = XmlSoapCreateMsg(ctx, &xerr)))
{
    printf("Failed to create SOAP message, error %u\n", (unsigned) xerr);
    return xerr;
}
res = XmlSoapAddHeaderElement(ctx, msg2, "m:reservation", mres_uri, &xerr);
xerr = XmlSoapSetRole(ctx, res, XMLSOAP_ROLE_NEXT);
xerr = XmlSoapSetMustUnderstand(ctx, res, TRUE);
(void) XmlDomAddTextElem(xctx, res, mres_uri, "m:reference",
                        "uuid:093a2da1-q345-739r-ba5d-pqff98fe8j7d");
(void) XmlDomAddTextElem(xctx, res, mres_uri, "m:dateAndTime",
                        "2001-11-29T13:35:00.000-05:00");
pas = XmlSoapAddHeaderElement(ctx, msg2, "n:passenger", npas_uri, &xerr);
xerr = XmlSoapSetRole(ctx, pas, XMLSOAP_ROLE_NEXT);
xerr = XmlSoapSetMustUnderstand(ctx, pas, TRUE);
(void) XmlDomAddTextElem(xctx, pas, npas_uri, "n:name",
                        "John Smith");

/* Fill body */
/* Itinerary */
itin = XmlSoapAddBodyElement(ctx, msg2, "p:itineraryClarification",
                             trav_uri, &xerr);

/* Departure */
departure = XmlDomCreateElemNS(xctx, msg2, trav_uri, "p:departure");
departing = XmlDomCreateElem(xctx, msg2, "p:departing");
(void) XmlDomAddTextElem(xctx, departing, trav_uri,
                        "p:airportChoices", "JFK LGA EWR");
(void) XmlDomAppendChild(xctx, departure, departing);
XmlDomAppendChild(xctx, itin, departure);

```

```

/* Return */
ret = XmlDomCreateElemNS(xctx, msg2, trav_uri, "p:return");
arriving = XmlDomCreateElemNS(xctx, msg2, trav_uri, "p:arriving");
(void) XmlDomAddTextElem(xctx, arriving, trav_uri,
    "p:airportChoices", "JFK LGA EWR");
XmlDomAppendChild(xctx, ret, arriving);
XmlDomAppendChild(xctx, itin, ret);

#ifdef DEBUG
    XmlSaveDom(xctx, &xerr, msg2, "stdio", stdout, "indent_step", 1, NULL);
#endif

```

24.5 SOAP Example 3: Using POST

An example sends credit card information for John Smith as an XML document using method POST. `XmlSoapCall()` writes the HTTP header that precedes the XML message in the example.

The C Client includes this code block which is substituted like the second example in [Example 24-5](#) (page 24-8):

Example 24-8 Example 3 SOAP Message

```

POST /Reservations HTTP/1.0
Host: travelcompany.example.org
Content-Type: application/soap+xml; charset="utf-8"
Content-Length: nnnn

<?xml version='1.0' ?>
<env:Envelope xmlns:env="http://www.w3.org/2003/05/soap-envelope" >
  <env:Header>
    <t:transaction
      xmlns:t="http://thirdparty.example.org/transaction"
      env:encodingStyle="http://example.com/encoding"
      env:mustUnderstand="true" >5</t:transaction>
  </env:Header>
  <env:Body>
    <m:chargeReservation
      env:encodingStyle="http://www.w3.org/2003/05/soap-encoding"
      xmlns:m="http://travelcompany.example.org/">
      <m:reservation xmlns:m="http://travelcompany.example.org/reservation">
        <m:code>FT35ZBQ</m:code>
      </m:reservation>
      <o:creditCard xmlns:o="http://mycompany.example.com/financial">
        <n:name xmlns:n="http://mycompany.example.com/employees">
          John Smith
        </n:name>
        <o:number>123456789099999</o:number>
        <o:expiration>2005-02</o:expiration>
      </o:creditCard>
    </m:chargeReservation>
  </env:Body>
</env:Envelope>

```

Example 24-9 Example 3 SOAP C Client

```

#define XMLSOAP_MAX_NAME      1024

/* we need this function for examples 2 and 3 */
static xmlerr add_ns_decl(xmlsoapctx *ctx, xmlctx *xctx, xmlemnode *elem,
    oratext *pfx, oratext *uri)
{

```



```

oralex      *aq, aqbuf[XMLSOAP_MAX_NAME];
xmldocnode *doc;
oralex      *xmlns = "xmlns:";

/* if no room for "xmlns:usersprefix\0" then fail now */
if ((strlen((char *)pfx) + strlen((char *)xmlns) >
    sizeof(aqbuf))
    return EX_FAIL;
(void) strcpy((char *)aqbuf, (char *)xmlns);
strcat((char *)aqbuf, (char *)pfx);
doc = XmlDomGetOwnerDocument(xctx, elem);
aq = XmlDomSaveString(xctx, doc, aqbuf);
XmlDomSetAttrNS(xctx, elem, uri, aq, uri);
return XMLERR_OK;
}

/* EXAMPLE 3 */
if (!(msg3 = XmlSoapCreateMsg(ctx, &xerr)))
{
    printf("Failed to create SOAP message, error %u\n", (unsigned) xerr);
    return xerr;
}
trans = XmlSoapAddHeaderElement(ctx, msg3, "t:transaction", tparty_uri, &xerr);
xerr = XmlSoapSetMustUnderstand(ctx, trans, TRUE);
XmlDomSetAttr(xctx, trans, estyle, estyle_uri);
text = XmlDomCreateText(xctx, msg3, "5");
XmlDomAppendChild(xctx, trans, text);

/* Fill body */
/* Charge Reservation */
charge = XmlSoapAddBodyElement(ctx, msg3, "m:chargeReservation", comp_uri, &xerr);
XmlDomSetAttr(xctx, charge, estyle, soap_style_uri);
res = XmlDomCreateElemNS(xctx, msg3, mres_uri, "m:reservation");
if (add_ns_decl(ctx, xctx, res, "m", mres_uri))
    return EX_FAIL;
(void) XmlDomAddTextElem(xctx, res, mres_uri,
                        "m:code", "FT35ZBQ");
(void) XmlDomAppendChild(xctx, charge, res);

/* create card elem with namespace */
card = XmlDomCreateElemNS(xctx, msg3, finance_uri, "o:creditCard");
if (add_ns_decl(ctx, xctx, card, "o", finance_uri))
    return EX_FAIL;
name = XmlDomAddTextElem(xctx, card, npas_uri,
                        "n:name", "John Smith");
/* add namespace */
if (add_ns_decl(ctx, xctx, name, "n", npas_uri))
    return EX_FAIL;
(void) XmlDomAddTextElem(xctx, card, finance_uri,
                        "o:number", "123456789099999");
(void) XmlDomAddTextElem(xctx, card, finance_uri,
                        "o:expiration", "2005-02");
(void) XmlDomAppendChild(xctx, charge, card);

#ifdef DEBUG
    XmlSaveDom(xctx, &xerr, msg3, "stdio", stdout, "indent_step", 1, NULL);
#endif

```

Part III

Oracle XML Developer's Kit for C++

An explanation is given of how to use Oracle XML Developer's Kit (XDK) to develop C++ applications.

Topics:

- [Getting Started with Oracle XML Developer's Kit for C++](#) (page 25-1)
- [Overview of the Unified C++ Interfaces](#) (page 26-1)
- [Using the XML Parser for C++](#) (page 27-1)
- [Using the XSLT Processor for C++](#) (page 28-1)
- [Using the XML Schema Processor for C++](#) (page 29-1)
- [Using the XPath Processor for C++](#) (page 30-1)
- [Using the XML Class Generator for C++](#) (page 31-1)

Getting Started with Oracle XML Developer's Kit for C++

An explanation is given of how to get started with Oracle XML Developer's Kit (XDK) for C++. The C++ demo programs are on the Oracle Database Examples media.

Topics:

- [Installing the XDK for C++ Components](#) (page 25-1)
- [Configuring the UNIX Environment for XDK for C++ Components](#) (page 25-1)
- [Configuring the Windows Environment for XDK for C++ Components](#) (page 25-3)

25.1 Installing the XDK for C++ Components

The XDK for C++ components are included with Oracle Database.

See Also:

- [About Installing XDK](#) (page 1-17) for installation instructions
 - [Overview of XDK](#) (page 1-1) for a list of the XDK for C++ components
-

25.2 Configuring the UNIX Environment for XDK for C++ Components

Topics here include component dependencies, environment variables, the runtime and compile-time environments, and the component version.

Topics:

- [XDK for C++ Component Dependencies on UNIX](#) (page 25-1)
- [Setting Up XDK for C++ Environment Variables on UNIX](#) (page 25-2)
- [Testing the XDK for C++ Runtime Environment on UNIX](#) (page 25-2)
- [Setting Up and Testing the XDK for C++ Compile-Time Environment on UNIX](#) (page 25-2)
- [Verifying the XDK for C++ Component Version on UNIX](#) (page 25-3)

25.2.1 XDK for C++ Component Dependencies on UNIX

The C++ libraries described in this section are located in `$ORACLE_HOME/lib`.

The XDK for C and C++ components are contained in the library:

```
libxml11.a
```

In addition to the XDK for C components described in [XDK for C Component Dependencies on UNIX](#) (page 18-3), the library includes the XML class generator, which creates C++ source files based on an input document type definition (DTD) or XML Schema.

[Table 18-1](#) (page 18-3) in [XDK for C Component Dependencies on UNIX](#) (page 18-3) describes the Oracle CORE and Globalization Support libraries on which the XDK for C components (UNIX) depend. The library dependencies are the same for C and C++.

25.2.2 Setting Up XDK for C++ Environment Variables on UNIX

The UNIX environment variables required for use with the XDK components are the same for C and C++.

See [Table 18-2](#) (page 18-4) in [Setting Up XDK for C Environment Variables on UNIX](#) (page 18-4).

25.2.3 Testing the XDK for C++ Runtime Environment on UNIX

You can test your environment by running any of the XDK C utilities for UNIX. These utilities do not have C++ versions.

The C utilities described in [Table 18-3](#) (page 18-4) in [Testing the XDK for C Runtime Environment on UNIX](#) (page 18-4).

25.2.4 Setting Up and Testing the XDK for C++ Compile-Time Environment on UNIX

How to set up and test the XDK C++ compile-time UNIX environment is described.

Both the C and C++ header files are located in `$ORACLE_HOME/xdk/include`. [Table 25-1](#) (page 25-2) describes the C++ header files. [Table 18-4](#) (page 18-5) in [Setting Up and Testing the XDK C Compile-Time Environment on UNIX](#) (page 18-5) describes the C header files. Your runtime environment must be set up before you can compile your C++ code.

Table 25-1 Header Files in the XDK for C++ Compile-Time Environment

Header File	Description
<code>oraxml.hp</code> <code>p</code>	Includes the Oracle9i XML ORA data types and the public ORA application programming interfaces (APIs) included in <code>libxml.a</code> (only for backward compatibility).
<code>oraxmlcg.</code> <code>h</code>	Includes the C APIs for the C++ class generator (only for backward compatibility).
<code>oraxsd.hp</code> <code>p</code>	Includes the Oracle9i XML schema definition (XSD) validator data types and APIs (only for backward compatibility)
<code>xml.hpp</code>	Handles the Unified Document Object Model (DOM) APIs transparently, whether you use them through Oracle Call Interface (OCI) or standalone
<code>xmlotn.hp</code> <code>p</code>	Includes the common APIs, whether you compile standalone or use OCI and the Unified DOM

Table 25-1 (Cont.) Header Files in the XDK for C++ Compile-Time Environment

Header File	Description
<code>xmlctx.hp</code>	Includes the initialization and exception-handling public APIs
<code>p</code>	

25.2.4.1 Testing the XDK for C++ Compile-Time Environment on UNIX

The simplest way to test your compile-time environment is to run the `make` utility on the sample programs.

The demo programs are located on the Examples media rather than the Oracle Database CD. After installing these programs, they are located in `$ORACLE_HOME/xdk/demo/cpp`.

Build and run the sample programs by executing these commands at the system prompt:

```
cd $ORACLE_HOME/xdk/demo/cpp
make
```

25.2.5 Verifying the XDK for C++ Component Version on UNIX

How to determine which version of XDK you have is explained.

To get the version of XDK that you are using, change into `$ORACLE_HOME/lib` and run this command as the system prompt:

```
strings libxml10.a | grep -i developers
```

25.3 Configuring the Windows Environment for XDK for C++ Components

Topics here include component dependencies, environment variables, testing the runtime environment, setting up and testing the compile-time environment, and Visual C/C++.

Topics:

- [XDK for C++ Component Dependencies on Windows](#) (page 25-3)
- [Setting Up XDK for C++ Environment Variables on Windows](#) (page 25-4)
- [Testing the XDK for C++ Runtime Environment on Windows](#) (page 25-4)
- [Setting Up and Testing the XDK for C++ Compile-Time Environment on Windows](#) (page 25-4)
- [Using the XDK for C++ Components with Visual C/C++](#) (page 25-4)

25.3.1 XDK for C++ Component Dependencies on Windows

The C++ libraries described in this section are located in `%ORACLE_HOME%\lib`.

The XDK for C and C++ components are contained in this Windows library:

```
libxml10.dll
```

[Table 18-5](#) (page 18-7) in [XDK for C Component Dependencies on Windows](#) (page 18-6) describes the Oracle Common Oracle Runtime Environment (CORE) and

Globalization Support libraries on which the C components for Windows depend. The library dependencies are the same for C and C++.

25.3.2 Setting Up XDK for C++ Environment Variables on Windows

The Windows environment variables required for use with the XDK are the same for C and C++.

See [Table 18-6](#) (page 18-7) in [Setting Up XDK for C Environment Variables on Windows](#) (page 18-7).

25.3.3 Testing the XDK for C++ Runtime Environment on Windows

You can test your environment by running any of the XDK C utilities for UNIX. These utilities do not have C++ versions.

These utilities are described in [Table 18-7](#) (page 18-8) in [Testing the XDK for C Runtime Environment on Windows](#) (page 18-7).

25.3.4 Setting Up and Testing the XDK for C++ Compile-Time Environment on Windows

How to set up and test the XDK C++ compile-time Microsoft Windows environment is described.

[Table 25-1](#) (page 25-2) in the section [Setting Up and Testing the XDK for C++ Compile-Time Environment on UNIX](#) (page 25-2) describes the header files required for compilation of the C components on Windows. The relative file names are the same on both UNIX and Windows installations.

On Windows the header files are located in `%ORACLE_HOME%\xdk\include`. Your runtime environment must be set up before you can compile your code.

25.3.4.1 Testing the XDK for C++ Compile-Time Environment on Windows

You can test your compile-time environment by compiling the demo programs, which are located in `%ORACLE_HOME%\xdk\demo\cpp` if you have installed the Oracle Database Examples media.

The procedure for setting the C++ compiler path is identical to the procedure described in [Setting the XDK for C Compiler Path on Windows](#) (page 18-9). The procedure for editing the `Make.bat` files is identical to the procedure described in [Editing the Make.bat Files on Windows](#) (page 18-8).

25.3.5 Using the XDK for C++ Components with Visual C/C++

You can set up a project in Microsoft Visual C/C++ and use it for the demos included in XDK.

See [Using the XDK for C Components and Visual C++ in Microsoft Visual Studio](#) (page 18-9) for instructions.

Overview of the Unified C++ Interfaces

The unified C++ interfaces are described.

Topics:

- [What Is the Unified C++ API](#) (page 26-1)
- [Accessing the C++ Interface](#) (page 26-2)
- [OracleXML Namespace](#) (page 26-2)
- [Ctx Namespace](#) (page 26-2)
- [IO Namespace](#) (page 26-3)
- [Tools Package](#) (page 26-4)
- [Error Message Files](#) (page 26-4)

26.1 What Is the Unified C++ API?

Unified C++ application programming interfaces (APIs) for Extensible Markup Language (XML) tools represent a set of C++ interfaces for Oracle XML tools. All three kinds of C++ interfaces: abstract classes, templates, and implicit interfaces represented by generic template parameters, are used by the unified framework.

This unified approach provides a generic, interface-based framework that allows XML tools to be improved, updated, replaced, or added without affecting any interface-based user code, and minimally affecting application drivers and, possibly, application configuration.

Note:

Use the unified C++ API in `xml .hpp` for Oracle XML Developer's Kit (XDK) applications. The older, nonunified C++ API in `oraxml .hpp` is deprecated and supported only for backward compatibility. It will be removed in a future release.

The unified C++ API supports the World Wide Web Consortium (W3C) specification as closely as possible. However, Oracle cannot guarantee that the specification is fully supported by our implementation because the W3C specification does not cover C++ implementations.

26.2 Accessing the C++ Interface

The C++ interface is provided with Oracle Database. Sample files are located in `$ORACLE_HOME/xdk/demo/cpp.readme.html` in the root directory of the software archive contains release specific information including bug fixes and API additions.

26.3 OracleXML Namespace

`OracleXml` is the C++ namespace for all XML C++ interfaces. It contains common interfaces and namespaces for different XDK packages.

The following namespaces are included in namespace `OracleXML`:

- `Ctx`—namespace for TCtx related declarations
- `Dom`—namespace for Document Object Model (DOM) related declarations
- `Parser`—namespace for parser and schema validator declarations
- `IO`—namespace for input and output source declarations
- `Xsl`—namespace for Extensible Stylesheet Language Transformation (XSLT) related declarations
- `XPath` - namespace for XPath related declarations
- `Tools`—namespace for `Tools::Factory` related declarations

`OracleXml` is fully defined in the file `xml.hpp`. Another namespace, `XmlCtxNS`, visible to users, is defined in `xmlctx.hpp`. That namespace contains C++ definitions of data structures corresponding to C level definitions of the `xmlctx` context and related data structures. While there is no need for users to know details of that namespace, `xmlctx.hpp` must be included in most application main modules.

Multiple encodings are currently supported on the base of the `oratext` type that is currently supposed to be used by all implementations. All strings are represented as `oratext*`.

26.3.1 OracleXML Interfaces

`XMLException` interface—This is the root interface for all XML exceptions.

26.4 Ctx Namespace

The `Ctx` namespace contains data types and interfaces related to the TCtx interface.

26.4.1 OracleXML Data Types

OracleXML data types are described.

`encoding`—a particular supported encoding. The following kinds of encodings (or encoding names) are supported:

- `data_encoding`
- `default_input_encoding`
- `input_encoding`—overwrites the previous one
- `error_language`—gets overwritten by the language of the error handler, if specified

encodings—array of encodings.

26.4.2 Ctx Interfaces

Ctx interfaces `ErrorHandler`, `MemAllocator`, and `Tctx` are described.

ErrorHandler Interface — This is the root error handler class. It deals with local processing of errors, mainly from the underlying C implementation. In some implementations, it might throw `XmlException`. To accommodate the needs of all implementations, this behavior is not specified in its signature. However, it can create exception objects. The error handler is passed to the `Tctx` constructor when `Tctx` is initialized. Implementations of this interface are provided by the user.

MemAllocator Interface—This is a simple root interface to make the `Tctx` interface reasonably generic so that different allocator approaches can be used in the future. It is passed to the `Tctx` constructor when `Tctx` is initialized. It is a low level allocator that does not know the type of an object being allocated. The allocators with this interface can also be used directly. In this case the user is responsible for the explicit deallocation of objects (with `dealloc`).

If the `MemAllocator` interface is passed as a parameter to the `Tctx` constructor, it often makes sense to overwrite the operator `new`. In this case, all memory allocations in both C and C++ can be done by the same allocator.

Tctx Interface—This is an implicit interface to XML context implementations. It is primarily used for memory allocation, error (not exception) handling, and different encodings handling. The context interface is an implicit interface that is supposed to be used as type parameter. The name `Tctx` is used as a corresponding type parameter name. Its actual substitutions are instantiations of implementations parameterized (templated) by real context implementations. In the case of errors `XmlException` might be thrown. All constructors create and initialize context implementations. In a multithreaded environment a separate context implementation must be initialized for each thread.

26.5 IO Namespace

The IO namespace specifies interfaces for the different input and output options for all XML tools.

26.5.1 IO Data Types

Data type `InputSourceType` specifies the kinds of input sources that are supported.

- `ISRC_URI`—Input is to be read from the specified Universal Resource Identifier (URI).
- `ISRC_FILE`—Input is to be read from a file.
- `ISRC_BUFFER`—Input is to be read from a buffer.
- `ISRC_DOM`—Input is a DOM tree.
- `ISRC_CSTREAM`—Input is a C level stream.

26.5.2 IO Interfaces

The interfaces to inputs are described.

URISource—This is an interface to inputs from specified URIs.

`FileSource`—This is an interface to inputs from a file.

`BufferSource`—This is an interface to inputs from a buffer.

`DOMSource`—This is an interface to inputs from a DOM tree.

`CStreamSource`—This is an interface to inputs from a C level stream.

26.6 Tools Package

`Tools` is the package (subspace of `OracleXml`) for types and interfaces that are related to the creation and instantiation of Oracle XML tools.

26.6.1 Tools Interfaces

Interfaces for XML tools are described.

`FactoryException`—Specifies tools factory exceptions. It is derived from `XMLExceptions`.

`Factory`—XML tools factory. Hides implementations of all XML tools and provides methods to create objects representing these tools based on their identifier (ID) values.

26.7 Error Message Files

Error message files are provided in directory `$ORACLE_HOME/xdk/msg`. You can set environment variable `ORA_XML_MSG` to point to this directory, but this not required.

See Also:

Oracle Database XML C++ API Reference package Ctx APIs for C++

Using the XML Parser for C++

An explanation is given of how to use the Extensible Markup Language (XML) parser for C++.

Topics:

- [Introduction to Oracle XML Parser for C++](#) (page 27-1)
- [DOM Namespace](#) (page 27-2)
- [DOM Interfaces](#) (page 27-2)
- [Parser Namespace](#) (page 27-3)
- [Thread Safety for the XML Parser for C++](#) (page 27-4)
- [XML Parser for C++ Usage](#) (page 27-4)
- [XML Parser for C++ Default Behavior](#) (page 27-4)
- [C++ Sample Files](#) (page 27-5)

Note:

Use the unified C++ application programming interface (API) in `xml.hpp` for Oracle XML Developer's Kit (XDK) applications. The older, nonunified C++ API in `oraxml.hpp` is deprecated and supported only for backward compatibility. It will be removed in a future release.

27.1 Introduction to Oracle XML Parser for C++

Oracle XML parser for C++ determines whether an XML document is well-formed and optionally validates it against a document type definition (DTD) or Extensible Markup Language (XML) schema. The parser constructs an object tree that can be accessed through one of these two XML APIs:

- **Document Object Model (DOM):** Tree-based APIs. A tree-based API compiles an XML document into an internal tree structure, then allows an application to navigate that tree using the DOM, a standard tree-based API for XML and HTML documents.
- **Simple API for XML (SAX):** Event-based APIs. An event-based API reports parsing events (such as the start and end of elements) directly to the application through a user defined SAX even handler, and does not usually build an internal tree. The application implements handlers to deal with the different events, much like handling events in a graphical user interface.

Tree-based APIs are useful for a wide range of applications, but they often put a great strain on system resources, especially if the document is large (under very controlled circumstances, it is possible to construct the tree in a lazy fashion to avoid some of this problem). Furthermore, some applications must build their own, different data trees, and it is very inefficient to build a tree of parse nodes only to map it onto a new tree.

27.2 DOM Namespace

The DOM namespace is the namespace for DOM-related types and interfaces.

DOM interfaces are represented as generic references to different implementations of the DOM specification. They are parameterized by `Node` that supports various specializations and instantiations. Of them, the most important is `XmlNode` which corresponds to the current C implementation

These generic references do not have a NULL-like value. Any implementation must never create a reference with no state (like NULL). If it is necessary to signal that something has no state, the implementation must throw an exception.

Many methods might throw the `SYNTAX_ERR` exception, if the DOM tree is incorrectly formed, or they might throw `UNDEFINED_ERR`, when encountering incorrect parameters or unexpected NULL pointers. If these are the only errors that a particular method might throw, it is not reflected in the method signature.

Actual DOM trees do *not* depend on the context, `TCtx`. However, manipulations on DOM trees in the current, `xmlctx`-based implementation require access to the current context, `TCtx`. This is accomplished by passing the context pointer to the constructor of `DOMImplRef`. In multithreaded environment `DOMImplRef` is always created in the thread context and, so, has the pointer to the right context.

`DOMImplRef` provides a way to create DOM trees. `DomImplRef` is a reference to the actual `DOMImplementation` object that is created when a regular, noncopy constructor of `DomImplRef` is invoked. This works well in a multithreaded environment where DOM trees must be shared, and each thread has a separate `TCtx` associated with it. This works equally well in a single threaded environment.

`DOMString` is one encoding supported by Oracle implementations. The support of other encodings is an Oracle extension. The `oratext*` data type is used for all encodings. Interfaces represent DOM level 2 Core interfaces according to <http://www.w3.org/TR/DOM-Level-2-Core/core.html>. These C++ interfaces support the DOM specification as closely as possible. However, Oracle cannot guarantee that the specification is fully supported by our implementation because the World Wide Web Consortium (W3C) specification does not cover C++ binding.

27.2.1 DOM Data Types

`DOMNodeType` defines types of DOM nodes. `DomExceptionCode` defines exception codes returned by the DOM API.

27.2.2 DOM Interfaces

The DOM interfaces are described.

DOMException Interface—See exception `DOMException` in the W3C DOM documentation. DOM operations raise exceptions only in "exceptional" circumstances: when an operation is impossible to perform (either for logical reasons, because data is lost, or because the implementation has become unstable). The functionality of `XMLException` can be used for a wider range of exceptions.

NodeRef Interface—See interface `Node` in the W3C documentation.

`DocumentRef` Interface—See interface `Document` in the W3C documentation.

`DocumentFragmentRef` Interface—See interface `DocumentFragment` in the W3C documentation.

`ElementRef` Interface—See interface `Element` in the W3C documentation.

`AttrRef` Interface—See interface `Attr` in the W3C documentation.

`CharacterDataRef` Interface—See interface `CharacterData` in the W3C documentation.

`TextRef` Interface—See `Text` nodes in the W3C documentation.

`CDATASectionRef` Interface—See `CDATASection` nodes in the W3C documentation.

`CommentRef` Interface—See `Comment` nodes in the W3C documentation.

`ProcessingInstructionRef` Interface—See `PI` nodes in the W3C documentation.

`EntityRef` Interface—See `Entity` nodes in the W3C documentation.

`EntityReferenceRef` Interface—See `EntityReference` nodes in the W3C documentation.

`NotationRef` Interface—See `Notation` nodes in the W3C documentation.

`DocumentTypeRef` Interface—See `DTD` nodes in the W3C documentation.

`DOMImplRef` Interface—See interface `DOMImplementation` in the W3C DOM documentation. `DOMImplementation` is fundamental for manipulating DOM trees. Every DOM tree is attached to a particular DOM implementation object. Several DOM trees can be attached to the same DOM implementation object. Each DOM tree can be deleted and deallocated by deleting the document object. All DOM trees attached to a particular DOM implementation object are deleted when this object is deleted. The `DOMImplementation` object is not visible to the user directly. It is visible through the class `DOMImplRef`. This functionality is needed because of requirements for multithreaded environments.

`NodeListRef` Interface—Abstract implementation of node list. See interface `NodeList` in the W3C documentation.

`NamedNodeMapRef` Interface—Abstract implementation of a node map. See interface `NamedNodeMap` in the W3C documentation.

27.2.3 DOM Traversal and Range Data Types

`AcceptNodeCode` is the data type for values returned by node filters for iterators and tree walkers. `WhatToShowCode` is the data type for codes to filter nodes.

`RangeExceptionCode` is the data type for exceptions that can be thrown by interface `Range`. `CompareHowCode` is the data type for range comparisons.

27.2.4 DOM Traversal and Range Interfaces

The DOM 2 traversal and range interfaces are `NodeFilter`, `NodeIterator`, `TreeWalker`, `DocumentTraversal`, `RangeException`, `Range`, and `DocumentRange`.

27.3 Parser Namespace

Interfaces associated with the parser namespace are described.

`DOMParser` Interface—DOM parser root class.

`GParser` Interface—Root class for XML parsers.

`ParserException` Interface—Exception class for parser and validator.

`SAXHandler` Interface—Root class for current SAX handler implementations.

`SAXHandlerRoot` Interface—Root class for all SAX handlers.

`SAXParser` Interface—Root class for all SAX parsers.

`SchemaValidator` Interface—XML schema-aware validator.

27.3.1 GParser Interface

Interface `GParser` is the root class for all XML parser interfaces and implementations. It is not an abstract class; that is, it is not an interface. It is a real class that you can use to set and check parser parameters.

27.3.2 DOMParser Interface

Interface `DOMParser` is the DOM parser root abstract class or interface. In addition to parsing and checking that a document is well formed, it provides ways to validate a document against a document type definition (DTD) or an XML schema.

27.3.3 SAXParser Interface

Interface `SAXParser` is the root abstract class for all SAX parsers.

27.3.3.1 SAX Event Handlers

To use SAX, a SAX event handler class must be provided by the user and passed to the `SAXParser` in a `parse()` invocation or set before such invocation.

`SAXHandlerRoot` Interface—root class for all SAX handlers.

`SAXHandler` Interface—root class for current SAX handler implementations.

27.4 Thread Safety for the XML Parser for C++

If threads are forked in the midst of the `init`–`parse`–`term` sequence of invocations, unpredictable behavior or results can occur.

27.5 XML Parser for C++ Usage

Invoke `Tools::Factory` to create a parser and initialize the parsing process. The XML input can be kind of `InputSource` (see `IO` namespace). `DOMParser` invocation produces the DOM tree. `SAXParser` invocation produces SAX events. Invoking the parser destructor terminates the process.

27.6 XML Parser for C++ Default Behavior

The default behavior for the XML parser for C++ is described.

- Character set encoding is 8-bit encoding of Unicode (UTF-8). If all your documents are ASCII, you are encouraged to set the encoding to US-ASCII for better performance.
- Messages are printed to `stderr` unless `msghdlr` is specified.

- XML parser for C++ determines whether an XML document is well-formed and optionally validates it against a DTD. The parser constructs an object tree that can be accessed through a DOM interface or operates serially through a SAX interface.
- A parse tree which can be accessed by DOM APIs is built unless `saxcb` is set to use the SAX callback APIs. You can set any of the SAX callback functions to `NULL` if not needed.
- The default behavior for the parser is to check that the input is well-formed but not to check whether it is valid. The flag `XML_FLAG_VALIDATE` can be set to validate the input. The default behavior for white space processing is to be fully conformant with the XML 1.0 spec, that is, all white space is reported back to the application but it is indicated which white space is ignorable. However, some applications may prefer to set the `XML_FLAG_DISCARD_WHITESPACE` which discards all white space between an end-element tag and this start-element tag.

Note:

Oracle recommends that you set the default encoding explicitly if using only single-byte character sets (such as US-ASCII or any of the ISO-8859 character sets) for performance up to 25% faster than with multibyte character sets, such as UTF-8.

- In both of these cases, an event-based API provides a simpler, lower-level access to an XML document: you can parse documents much larger than your available system memory, and you can construct your own data structures using your callback event handlers.

27.7 C++ Sample Files

Directory `xdk/demo/cpp/parser/` contains several XML applications that show how to use the XML parser for C++ with the DOM and SAX interfaces.

Change directories to the sample directory (`$ORACLE_HOME/xdk/demo/cpp` on Solaris, for example) and read the `README` file. This document explains how to build the sample programs.

[Table 27-1](#) (page 27-5) lists the sample files in the directory. Each file `*Main.cpp` has a corresponding `*Gen.cpp` and `*Gen.hpp`.

Table 27-1 XML Parser for C++ Sample Files

Sample File Name	Description
<code>DOMSampleMain.cpp</code>	Sample usage of C++ interfaces of XML parser and DOM.
<code>FullDOMSampleMain.cpp</code>	Manually build DOM and then exercise.
<code>SAXSampleMain.cpp</code>	Source for SAXSample program.

See Also:

Oracle Database XML C++ API Reference for parser package APIs for C++

Using the XSLT Processor for C++

An explanation is given of how to use the Extensible Stylesheet Language Transformation (XSLT) processor for C++.

Topics:

- [Accessing XSLT for C++](#) (page 28-1)
- [XSL Namespace](#) (page 28-1)
- [XSLT for C++ DOM Interface Usage](#) (page 28-2)
- [Invoking XSLT for C++](#) (page 28-2)
- [Using the Sample Files Included with the Software](#) (page 28-3)

Note:

Use the unified C++ application programming interface (API) in `xml.hpp` for Oracle XML Developer's Kit (XDK) applications. The older, nonunified C++ API in `oraxml.hpp` is deprecated and supported only for backward compatibility. It will be removed in a future release.

28.1 Accessing XSLT for C++

Extensible Stylesheet Language Transformation (XSLT) for C++ is provided with Oracle Database.

Sample files are located at `xdk/demo/cpp/new`.

`readme.html` in the root directory of the software archive contains release specific information including bug fixes and API additions.

See Also:

[XSLT XVM Processor](#) (page 19-1)

28.2 XSL Namespace

This is the namespace for XSLT compilers and transformers.

28.2.1 XSL Interfaces

The XSL interfaces are described.

`XslException` Interface—Root interface for all XSLT-related exceptions.

Transformer Interface—Basic XSLT processor. You can use this interface to invoke all XSLT processors.

CompTransformer Interface—Extended XSLT processor. You can use this interface only with processors that create intermediate binary bytecode (currently only the XVM-based processor).

Compiler Interface—XSLT compiler. It is used for compilers that compile XSLT into binary bytecode.

See Also:

Oracle Database XML C++ API Reference package XSL APIs for C++

28.3 XSLT for C++ DOM Interface Usage

Basic usage of XSLT for C++ DOM is described.

There are two inputs to `XMLParser.xmlparse()`:

- The Extensible Markup Language (XML) document
- The XSLT stylesheet to be applied to the XML document

An XSLT processor is initiated by invoking the `tools` factory to create a particular XSLT transformer or compiler.

An XSLT stylesheet is supplied to a transformer by invoking `setXSL()` member functions.

An XML instance document is supplied as a parameter to the `transform` member functions.

The resultant document (XML, HTML, Vector Markup Language (VML), and so on) is typically sent to an application for further processing. It is sent as a Document Object Model (DOM) tree or as a sequence of Simple API for XML (SAX) events. SAX events are produced if a SAX event handler is provided by the user.

The application terminates the XSLT processors by invoking their destructors.

28.4 Invoking XSLT for C++

You can invoke XSLT for C++ by invoking the executable on the command line or by writing C++ code and using the supplied APIs.

28.4.1 Command-Line Usage

XSLT for C++ can be called as an executable by invoking `bin/xml`.

See Also:

[Table 20-4](#) (page 20-9)

28.4.2 Writing C++ Code to Use Supplied APIs

XSLT for C++ can be invoked by writing code to use the supplied APIs. The code must be compiled using the headers in directory `public` and linked against the libraries in

directory `lib`. See `Makefile` or `make.bat` in `xdk/demo/cpp/new` for full details of how to build your program.

28.5 Using the Sample Files Included with the Software

Directory `$ORACLE_HOME/xdk/demo/cpp/parser/` contains several XML applications that show how to use the XSLT for C++.

Table 28-1 XSLT for C++ Sample Files

Sample File Name	Description
<code>XSLSampleMain.cpp</code> <code>XSLSampleGen.cpp</code> <code>XSLSampleGen.hpp</code>	Sources for sample XSLT usage program. <code>XSLSample</code> takes two arguments, the XSLT stylesheet and the XML file. If you redirect <code>stdout</code> of this program to a file, you may have some output missing, depending on your environment.
<code>XVMSampleMain.cpp</code> <code>XVMSampleGen.cpp</code> <code>XVMSampleGen.hpp</code>	Sources for the sample XSLT Virtual Machine (XVM) usage program.

Using the XML Schema Processor for C++

An explanation is given of how to use the Extensible Markup Language (XML) schema processor for C++.

Topics:

- [Oracle XML Schema Processor for C++](#) (page 29-1)
- [XML Schema Processor API](#) (page 29-2)
- [Running the Provided XML Schema for C++ Sample Programs](#) (page 29-3)

Note:

Use the unified C++ application programming interface (API) in `xml.hpp` for Oracle XML Developer's Kit (XDK) applications. The older, nonunified C++ API in `oraxml.hpp` is deprecated and supported only for backward compatibility. It will be removed in a future release.

29.1 Oracle XML Schema Processor for C++

The XML Schema processor for C++ is a companion component to the Extensible Markup Language (XML) parser for C++ that allows support to simple and complex data types into XML applications.

The XML Schema processor for C++ supports the World Wide Web Consortium (W3C) XML Schema Recommendation. This makes writing custom applications that process XML documents straightforward, and means that a standards-compliant XML Schema processor is part of XDK on each operating system where Oracle Database is ported.

29.1.1 Oracle XML Schema for C++ Features

The features of the Oracle XML Schema processor for C++ are described.

These are the features:

- Supports simple and complex types
- Built upon the XML parser for C++
- Supports the W3C XML Schema Recommendation

The XML Schema processor for C++ class is `OracleXml::Parser::SchemaValidator`.

See Also:*Oracle Database XML C++ API Reference* schema validator interface

29.1.1.1 Online Documentation

Documentation for Oracle XML Schema processor for C++ is located in `/xdk/doc/cpp/schema` directory in your install area.

29.1.2 Standards Conformance for Oracle XML Schema Processor for C++

The standards to which the XML Schema Processor for C++ conforms are listed.

- W3C recommendation for Extensible Markup Language (XML) 1.0
- W3C recommendation for Document Object Model Level 1.0
- W3C recommendation for Namespaces in XML 1.0
- W3C recommendation for XML Schema 1.0

29.2 XML Schema Processor API

Interface `SchemaValidator` is an abstract template class to handle XML schema-based validation of XML documents.

29.2.1 Invoking XML Schema Processor for C++

The XML Schema processor for C++ can be called as an executable by invoking `bin/schema` in the install area. This takes the arguments:

- XML instance document
- Optionally, a default schema
- Optionally, the working directory

[Table 29-1](#) (page 29-2) lists the options (can be listed if the option is invalid or `-h` is the option):

Table 29-1 XML Schema Processor for C++ Command-Line Options

Option	Description
<code>-0</code>	Always exit with code 0 (success).
<code>-e <i>encoding</i></code>	Specify default input file encoding.
<code>-E <i>encoding</i></code>	Specify output/data/presentation encoding.
<code>-h</code>	Help. Prints these choices.
<code>-i</code>	Ignore provided schema.
<code>-o <i>num</i></code>	Validation option.
<code>-p</code>	Print document instance to <code>stdout</code> on success.

Table 29-1 (Cont.) XML Schema Processor for C++ Command-Line Options

Option	Description
-u	Force the Unicode path.
-v	Version—display version, then exit.

The XML Schema processor for C++ can also be invoked by writing code using the supplied APIs. The code must be compiled using the headers in the `include` subdirectory and linked against the libraries in the `lib` subdirectory. See `Makefile` or `Make.bat` in the `xdk/demo/cpp/schema` directory for details on how to build your program.

Error message files in different languages are provided in the `msg` subdirectory.

29.3 Running the Provided XML Schema for C++ Sample Programs

Directory `$ORACLE_HOME/xdk/demo/cpp/schema` contains a sample application that shows how to use Oracle XML Schema processor for C++ with its API.

[Table 29-2](#) (page 29-3) lists the sample files provided.

Table 29-2 XML Schema Processor for C++ Samples Provided

Sample File	Description
<code>Makefile</code>	Makefile to build the sample programs and run them, verifying correct output.
<code>xsdtest.cpp</code>	Trivial program which invokes the XML Schema for C++ API
<code>car.{xsd,xml,std}</code>	Sample schema, instance document, expected output respectively, after running <code>xsdtest</code> on them.
<code>aq.{xsd,xml,std}</code>	Second sample schema, instance document, expected output, respectively, after running <code>xsdtest</code> on them.
<code>pub.{xsd,xml,std}</code>	Third sample schema, instance document, expected output respectively, after running <code>xsdtest</code> on them.

To build the sample programs, run `make`.

To build the programs and run them, comparing the actual output to expected output:

```
make sure
```

Using the XPath Processor for C++

An explanation is given of how to use the XPath processor for C++.

Topics:

- [XPath Interfaces](#) (page 30-1)
- [Sample Programs](#) (page 30-1)

Note:

Use the unified C++ application programming interface (API) in `xml.hpp` for Oracle XML Developer's Kit (XDK) applications. The older, nonunified C++ API in `oraxml.hpp` is deprecated and supported only for backward compatibility. It will be removed in a future release.

30.1 XPath Interfaces

The XPath interfaces are described.

Processor Interface—basic XPath processor interface to which any XPath processor must conform.

CompProcessor Interface—extended XPath processor that adds an ability to use XPath expressions precompiled into an internal binary representation. In this release this interface represents Oracle virtual machine interface.

Compiler Interface—XPath compiler into binary representation.

NodeSetRef Interface—defines references to node sets when they are returned by the XPath expression evaluation.

XPathException Interface—exceptions for XPath compilers and processors.

XPathObject Interface—interface for XPath 1.0 objects.

30.2 Sample Programs

Sample programs are located in `xdk/demo/cpp/new`.

The programs `XslXPathSample` and `XvmXPathSample` have sources:

`XslXPathSampleGen.hpp`, `XslXPathSampleGen.cpp`, `XslXPathSampleMain.cpp`,
`XslXPathSampleForce.cpp`;

and `XvmXPathSampleGen.hpp`, `XvmXPathSampleGen.cpp`,
`XvmXPathSampleMain.cpp`, `XvmXPathSampleForce.cpp`.

See Also:

Oracle Database XML C++ API Reference package XPATH APIs for C++

Using the XML Class Generator for C++

Topics here explain how to use the Extensible Markup Language (XML) class generator for C++.

Topics:

- [Accessing the XML C++ Class Generator](#) (page 31-1)
- [Using the XML C++ Class Generator](#) (page 31-1)
- [Using the XML C++ Class Generator Command-Line Utility](#) (page 31-1)
- [Using the XML C++ Class Generator Examples](#) (page 31-2)

31.1 Accessing the XML C++ Class Generator

The XML C++ class generator is provided with Oracle Database.

31.2 Using the XML C++ Class Generator

The XML C++ class generator creates source files from an XML document type definition (DTD) or XML schema. It generates a class for each defined element. The classes are then used in a C++ program to construct XML documents that conform to the DTD or XML schema.

This is useful when an application wants to send an XML message to another application based on an agreed-upon DTD or XML Schema, or as the back end of a Web form to construct an XML document. Using these classes, C++ applications can construct, validate, and print XML documents that comply with the input.

The class generator works with the Oracle XML parser for C++, which parses the input and passes the parsed document to the class generator.

31.2.1 External DTD Parsing

The XML C++ class generator can also parse an external DTD directly without requiring a complete (dummy) document by using the Oracle XML parser for C++ routine `xmlparsedtd()`. The provided command-line program `xmlcg` has a `-d` option that is used to parse external DTDs.

31.3 Using the XML C++ Class Generator Command-Line Utility

The standalone class generator can be called as an executable by invoking `bin/xmlcg`.

You can invoke the C++ class generator from the command line:

```
xmlcg [options] input_file
```

Table 31-1 C++ Class Generator Options

Option	Description
<code>-d name</code>	Input is an external DTD or a DTD file. Generates <code>name.cpp</code> and <code>name.h</code> .
<code>-o directory</code>	Output directory for generated files (the default is the current directory).
<code>-e encoding</code>	Default input file encoding.
<code>-h</code>	Show this usage help.
<code>-v</code>	Show the class generator version validator options.
<code>-s name</code>	Input is an XML Schema file with the given name. Generates <code>name.cpp</code> and <code>name.h</code> .

`input_file` is the name of the parsed XML document with `<!DOCTYPE>` definitions, or parsed DTD, or an XML Schema document. The XML document must have an associated DTD.

The DTD input to the XML C++ class generator is an XML document containing a DTD, or it is an external DTD. The document body itself is ignored — only the DTD is relevant, though the document must conform to the DTD.

If invalid options were used, or no input was provided, a usage message is output.

Two source files are output, a `name.h` header file and a C++ file, `name.cpp`. These are named after the DTD file.

The output files are typically used to generate XML documents.

Constructors are provided for each class (element) that allow an object to be created in these ways:

- Initially empty, then adding the children or data after the initial creation
- Created with the initial full set of children or initial data

A method is provided for `#PCDATA` (and Mixed) elements to set the data and, when appropriate, set an element's attributes.

31.3.1 Input to the XML C++ Class Generator

The input is an XML document containing a DTD. The document body itself is ignored; only the DTD is relevant, though the dummy document must conform to the DTD. The underlying XML parser accepts only file names for the document and associated external entities.

31.4 Using the XML C++ Class Generator Examples

The demo XML C++ class generator files are described.

Table 31-2 XML C++ Class Generator Files

File Name	Description
CG.cpp	Sample program
CG.xml	XML file contains DTD and dummy document
CG.dtd	DTD file referenced by CG.xml
Make.bat on Windows Makefile on UNIX	Batch file (on Windows) or Make file (on UNIX) to generate classes and build the sample programs.
README	A readme file with these instructions

The `make.bat` batch file (on Windows) or `Makefile` (on UNIX) does the following:

- Generate classes based on `CG.xml` into `Sample.h` and `Sample.cpp`
- Compile the program `CG.cpp` (using `Sample.h`), and link this with the `Sample` object into an executable named `CG.exe` in the `...\\bin` (or `.../bin`) directory.

31.4.1 XML C++ Class Generator Example 1: XML — Input File to Class Generator, CG.xml

XML file `CG.xml` is presented. It is input to XML C++ class generator. It references the DTD file, `CG.dtd`.

```
<?xml version="1.0"?>
<!DOCTYPE Sample SYSTEM "CG.dtd">
<Sample>
  <B>Be!</B>
  <D attr="value"></D>
  <E>
    <F>Formula1</F>
    <F>Formula2</F>
  </E>
</Sample>
```

31.4.2 XML C++ Class Generator Example 2: DTD — Input File to Class Generator, CG.dtd

DTD file `CG.dtd` is presented. It is referenced by XML file `CG.xml`, which is input to XML C++ class generator.

```
<!ELEMENT Sample (A | (B, (C | (D, E))) | F)>
<!ELEMENT A (#PCDATA)>
<!ELEMENT B (#PCDATA | F)*>
<!ELEMENT C (#PCDATA)>
<!ELEMENT D (#PCDATA)>
<!ATTLIST D attr CDATA #REQUIRED>
<!ELEMENT E (F, F)>
<!ELEMENT F (#PCDATA)>
```

31.4.3 XML C++ Class Generator Example 3: CG Sample Program

Sample program `CG`, `CG.cpp`, is presented.

It does the following:

1. Initializes the XML parser.
2. Loads the DTD (by parsing the DTD-containing file—the dummy document part is ignored).
3. Creates some objects using the generated classes.
4. Invokes the validation function which verifies that the constructed classes match the DTD.
5. Writes the constructed document to `Sample.xml`.

```
////////////////////////////////////
// NAME          CG.cpp
// DESCRIPTION Demonstration program for C++ class generator usage
////////////////////////////////////

#ifndef ORAXMLDOM_ORACLE
# include <oraxml.h>
#endif

#include <fstream.h>

#include "Sample.h"

#define DTD_DOCUMENT "CG.xml"
#define OUT_DOCUMENT "Sample.xml"

int main()
{
    XMLParser parser;
    Document *doc;
    Sample *samp;
    B *b;
    D *d;
    E *e;
    F *f1, *f2;
    fstream *out;
    ub4 flags = XML_FLAG_VALIDATE;
    uword ecode;

    // Initialize XML parser
    cout << "Initializing XML parser...\n";
    if (ecode = parser.xmlinit())
    {
        cout << "Failed to initialize parser, code " << ecode << "\n";
        return 1;
    }

    // Parse the document containing a DTD; parsing just a DTD is not
    // possible yet, so the file must contain a valid document (which
    // is parsed but we're ignoring).
    cout << "Loading DTD from " << DTD_DOCUMENT << "... \n";
    if (ecode = parser.xmlparse((oralex *) DTD_DOCUMENT, (oralex *)0, flags))
    {
        cout << "Failed to parse DTD document " << DTD_DOCUMENT <<
            ", code " << ecode << "\n";
        return 2;
    }
}
```



```
// Fetch dummy document
cout << "Fetching dummy document...\n";
doc = parser.getDocument();

// Create the constituent parts of a Sample
cout << "Creating components...\n";
b = new B(doc, (String) "Be there or be square");
d = new D(doc, (String) "Dit dah");
d->setattr((String) "attribute value");
f1 = new F(doc, (String) "Formula1");
f2 = new F(doc, (String) "Formula2");
e = new E(doc, f1, f2);

// Create the Sample
cout << "Creating top-level element...\n";
samp = new Sample(doc, b, d, e);

// Validate the construct
cout << "Validating...\n";
if (ecode = parser.validate(samp))
{
    cout << "Validation failed, code " << ecode << "\n";
    return 3;
}

// Write out doc
cout << "Writing document to " << OUT_DOCUMENT << "\n";
if (!(out = new fstream(OUT_DOCUMENT, ios::out)))
{
    cout << "Failed to open output stream\n";
    return 4;
}
samp->print(out, 0);
out->close();

// Everything's OK
cout << "Success.\n";

// Shut down
parser.xmlterm();
return 0;
}

// end of CG.cpp
```

Part IV

Oracle XML Developer's Kit Reference

Reference information is presented for Oracle XML Developer's Kit (XDK).

Topics:

- [XSQL Pages Reference](#) (page 32-1)
- [Oracle XML Developer's Kit Standards](#) (page 33-1)
- [XDK for Java XML Error Messages](#) (page A-1)
- [XDK for Java TXU Error Messages](#) (page B-1)
- [XDK for Java XSU Error Messages](#) (page C-1)
- [Oracle XML Developer's Kit JavaBeans \(Deprecated\)](#) (page D-1)

XSQL Pages Reference

Reference information is presented for the XSQL pages framework.

[XSQL Configuration File Parameters](#) (page 32-3) describes settings in the XSQL configuration file. [Table 32-1](#) (page 32-1) lists the legal built-in actions for XSQL pages.

Table 32-1 Built-In XSQL Elements and Action Handler Classes

XSQL Action Element	Handler Class in oracle.xml.xsql.actions	Purpose
<xsql:action> (page 32-7)	XSQLExtensionActionHandler	Invoke a user-defined action handler, implemented in Java, for executing custom logic and including custom Extensible Markup Language (XML) data in your XSQL page.
<xsql:delete-request> (page 32-8)	XSQLDeleteRequestHandler	Delete an existing row in the database based on the posted XML document supplied in the request.
<xsql:dml> (page 32-10)	XSQLDMLHandler	Execute a structured query language (SQL) data manipulation language (DML) statement or a Procedural Language/Structured Query Language (PL/SQL) anonymous block.
<xsql:if-param> (page 32-11)	XSQLIfParamHandler	Conditionally include XML content or other XSQL actions.
<xsql:include-owa> (page 32-13)	XSQLIncludeOWAHandler	Include the results of a stored procedure that uses the Oracle Web Agent (OWA) packages in the database to generate XML.
<xsql:include-param> (page 32-14)	XSQLGetParameterHandler	Include a parameter and its value as an element in the XSQL page.
<xsql:include-posted-include-posted> (page 32-15)	XSQLIncludePostedXMLHandler	Include the XML document that has been posted in the request into the XSQL page.

Table 32-1 (Cont.) Built-In XSQL Elements and Action Handler Classes

XSQL Action Element	Handler Class in oracle.xml.xsql.actions	Purpose
<xsql:include-request-params> (page 32-16)	XSQLIncludeRequestHandler	Include all request parameters as XML elements in the XSQL page.
<xsql:include-xml> (page 32-17)	XSQLIncludeXMLHandler	Include arbitrary XML resources at any point in your page by relative or absolute URL.
<xsql:include-xsql> (page 32-18)	XSQLIncludeXSQLHandler	Include the results of one XSQL page at any point inside another.
<xsql:insert-param> (page 32-20)	XSQLInsertParameterHandler	Insert the XML document contained in the value of a single parameter.
<xsql:insert-request> (page 32-21)	XSQLInsertRequestHandler	Insert the XML document or HTML form posted in the request into a table or view.
<xsql:query> (page 32-23)	XSQLQueryHandler	Execute an arbitrary SQL statement and include its result in canonical XML format.
<xsql:ref-cursor-function> (page 32-26)	XSQLRefCursorFunctionHandler	Include the canonical XML representation of the result set of a cursor returned by a PL/SQL stored function.
<xsql:set-cookie> (page 32-28)	XSQLSetCookieHandler	Set an HTTP Cookie.
<xsql:set-page-param> (page 32-30)	XSQLSetPageParamHandler	Set an HTTP-Session level parameter. Set a page-level (local) parameter that can be referred to in subsequent SQL statements in the page.
<xsql:set-session-param> (page 32-32)	XSQLSetSessionParamHandler	Set an HTTP-Session level parameter.
<xsql:set-stylesheet-param> (page 32-34)	XSQLStylesheetParameterHandler	Set the value of a top-level Extensible Stylesheet Language Transformation (XSLT) parameter.
<xsql:update-request> (page 32-36)	XSQLUpdateRequestHandler	Update an existing row in the database based on the posted XML document supplied in the request.

32.1 XSQL Configuration File Parameters

You can use the XSQL configuration file to tune your XSQL pages environment. The available configuration settings are described.

Table 32-2 XSQL Configuration File Settings

Configuration Setting Name	Description
<code>XSQLConfig/servlet/output-buffer-size</code>	Sets the size in bytes of the buffered output stream. If the servlet engine already buffers I/O to the servlet output stream, you can set to 0 (the default) to avoid additional buffering. Any nonnegative integer is valid.
<code>XSQLConfig/servlet/suppress-mime-charset/media-type</code>	The XSQL servlet sets the HTTP <code>Content-Type</code> header to indicate the Multipurpose Internet Mail Extensions (MIME) type of the resource returned to the request. By default, the servlet includes the optional character set data in the MIME type. For a particular MIME type, you can suppress the inclusion of the character set data by including a <code><media-type></code> element, with the desired MIME type as its contents. You can list any number of <code><media-type></code> elements. Valid value is any string.
<code>XSQLConfig/processor/character-set-conversion/default-charset</code>	<p>Performs character set conversion by default on the value of HTTP parameters to compensate for the default character set used by most servlet engines. The default base character set used for conversion is the Java 8859_1, which corresponds to the Internet Assigned Numbers Authority (IANA) ISO-8859-1 set. If your servlet engine uses a different character set as its base, then you can specify this value here.</p> <p>To suppress character set conversion, specify the empty element <code><none/></code> as the content of the <code><default-charset></code> element instead of a character set name. This technique is useful if you are working with parameter values that are correctly representable with your servlet default character set. It eliminates overhead associated with performing the character set conversion.</p> <p>Valid values are any Java character set name or <code><none/></code>.</p>
<code>XSQLConfig/processor/reload-connections-on-error</code>	<p>Connection definitions are cached when the XSQL pages processor is initialized. Set to <code>yes</code> (default) to cause the processor to reread the <code>XSQLConfig.xml</code> file to reload connection definitions if an attempt is made to request a connection name that is not in the cached connection list. The <code>yes</code> setting is useful for adding new <code><connection></code> definitions to the file while the servlet is running. Set to <code>no</code> to avoid reloading the connection definition file when a connection name is not found in the in-memory cache. Valid values are <code>yes</code> and <code>no</code>.</p>
<code>XSQLConfig/processor/default-fetch-size</code>	<p>Sets the default value of the row fetch size for retrieving information from SQL queries. It takes effect only when you use the Oracle JDBC driver; otherwise the setting is ignored. This technique reduces network round trips to the database from the servlet engine running in a different tier.</p> <p>Default is 50. Valid value is any nonzero positive integer.</p>

Note: Setting name is a single line. It is displayed on two lines due to space constraints.

Table 32-2 (Cont.) XSQL Configuration File Settings

Configuration Setting Name	Description
<code>XSQLConfig/processor/page-cache-size</code>	Sets the size of the cache for XSQL page templates and so determines the maximum number of XSQL pages that are cached. Least recently used pages move out of the cache if you go above this number. Default is 25. Any nonzero positive integer is valid.
<code>XSQLConfig/processor/stylesheet-cache-size</code>	Sets the size of the cache for XSLT stylesheets and so determines the maximum number of XSQL pages that are cached. Least recently used pages move out of the cache if you go above this number. Default is 25. Any nonzero positive integer is valid.
<code>XSQLConfig/processor/stylesheet-pool/initial</code>	Each cached stylesheet is a pool of cached stylesheet instances to improve throughput. Sets the initial number of stylesheets to be allocated in each stylesheet pool. Default is 1. Valid value is any nonzero positive integer.
<code>XSQLConfig/processor/stylesheet-pool/increment</code>	Sets the number of stylesheets allocated when the stylesheet pool must grow due to increased load on the server. Default is 1. Valid value is any nonzero positive integer.
<code>XSQLConfig/processor/stylesheet-pool/timeout-seconds</code>	Sets the number of seconds of inactivity before a stylesheet instance in the pool is removed to free resources as the pool tries to shrink back to its initial size. Default is 60. Valid value is any nonzero positive integer.
<code>XSQLConfig/processor/connection-pool/initial</code>	Controls the initial number of Java Database Connectivity (JDBC) connections allocated in each connection pool. The XSQL pages processor's default connection manager implements connection pooling to improve throughput. Default is 2. Valid value is any nonzero positive integer.
<code>XSQLConfig/processor/connection-pool/increment</code>	Sets the number of connections allocated when the connection pool must grow due to increased load on the server. Default is 1. Valid value is any nonzero positive integer.
<code>XSQLConfig/processor/connection-pool/timeout-seconds</code>	Sets the number of seconds of inactivity before a JDBC connection in the pool is removed to free resources as the pool tries to shrink back to its initial size. Default is 60. Valid value is any nonzero positive integer.
<code>XSQLConfig/processor/connection-pool/dump-allowed</code>	Determines whether a diagnostic report of connection pool activity can be requested by passing the <code>dump-pool=y</code> parameter in the page request. Default is <code>no</code> . Valid value is <code>yes</code> or <code>no</code> .
<code>XSQLConfig/processor/connection-manager/factory</code>	Specifies the fully qualified Java class name of the XSQL connection manager factory implementation. If not specified, default is <code>XSQLConnectionFactoryImpl</code> . Valid value is any class name that implements the <code>XSQLConnectionFactory</code> interface.

Table 32-2 (Cont.) XSQL Configuration File Settings

Configuration Setting Name	Description
XSQLConfig/processor/owa/fetch-style	<p>Sets the default OWA Page Buffer fetch style used by the <code><xsql:include-owa></code> action. Valid values are <code>CLOB</code> (default) or <code>TABLE</code>.</p> <p>If set to <code>CLOB</code>, then the processor uses a temporary <code>CLOB</code> to retrieve the OWA page buffer. If set to <code>TABLE</code>, then the processor uses a more efficient approach that requires the Oracle Database user-defined type <code>XSQL_OWA_ARRAY</code>. Create this type with this data definition language (DDL) statement:</p> <pre>CREATE TYPE xsql_owa_array AS TABLE OF VARCHAR2(32767)</pre>
XSQLConfig/processor/timing/page	<p>Determines whether the XSQL page processor adds an <code>xsql-timing</code> attribute to the document element of the page whose value reports the elapsed number of milliseconds required to process the page.</p> <p>Valid values are <code>yes</code> or <code>no</code> (default).</p>
XSQLConfig/processor/timing/action	<p>Determines whether a the XSQL page processor adds comment to the page just before the action element whose contents reports the elapsed number of milliseconds required to process the action.</p> <p>Valid values are <code>yes</code> or <code>no</code> (default).</p>
XSQLConfig/processor/logger/factory	<p>Specifies the fully qualified Java class name of a custom XSQL logger factory implementation. If not set, then no logger is used.</p> <p>Valid value is any class name that implements the <code>XSQLLoggerFactory</code> interface.</p>
XSQLConfig/processor/error-handler/class	<p>Specifies the fully qualified Java class name of a custom XSQL error handler. The specified handler is the default error handler implementation. If not set, then the default error handler is used.</p> <p>Valid value is any class name that implements the <code>XSQLErrorHandler</code> interface.</p>
XSQLConfig/processor/xml-parsing/preserve-whitespace	<p>Determines whether the XSQL pages processor preserves white space when parsing XSQL pages and XSLT stylesheets.</p> <p>Valid values are <code>true</code> (default) or <code>false</code>. Changing the default to <code>false</code> can slightly speed up processing of XSQL pages and stylesheets because ignoring white space while parsing is faster than preserving it.</p>

Table 32-2 (Cont.) XSQL Configuration File Settings

Configuration Setting Name	Description
XSQLConfig/processor/security/stylesheet/ defaults/ allow-client-style Note: Setting name is a single line. It is displayed on two lines due to space constraints.	<p>Prevents client overriding of the stylesheet. Valid values are <code>yes</code> and <code>no</code>.</p> <p>During development it is sometimes useful to use the XSQL stylesheet override feature by providing a value for the <code>xml-stylesheet</code> parameter in the request. You can use the <code>xml-stylesheet=none</code> combination to temporarily disable the application of the stylesheet for debugging purposes.</p> <p>You can add the <code>allow-client-style="no"</code> attribute to the document element of each XSQL page to prohibit client overriding of the stylesheet in production applications. This setting can globally change the default behavior for <code>allow-client-style</code> in a single place.</p> <p>This setting specifies only <i>default</i> behavior. If the attribute value is explicitly specified on the document element for a given XSQL page, its value takes precedence over this global default.</p>
XSQLConfig/processor/security/stylesheet/ trusted-hosts/host Note: Setting name is a single line. It is displayed on two lines due to space constraints.	<p>Specifies that any absolute URL to an XSLT stylesheet must be from a trusted host whose name is listed in the configuration file. List any number of <code><host></code> elements inside the <code><trusted-hosts></code> element. The name of the local machine, <code>localhost</code>, and <code>127.0.0.1</code> are trusted hosts by default. Valid values are any host name or IP address.</p> <p>The XSLT processor supports Java extension functions. Typically, XSQL pages refer to XSLT stylesheets with relative URLs.</p>
XSQLConfig/http/proxyhost	<p>Sets the name of the HTTP proxy server to use when processing URLs with the HTTP protocol.</p> <p>Valid value is any host name or Internet Protocol (IP) address.</p>
XSQLConfig/http/proxyport	<p>Sets the port number of the HTTP proxy server to use when processing URLs with the HTTP protocol.</p> <p>Valid value is any nonzero integer.</p>
XSQLConfig/connectiondefs/connection	<p>Defines a short name and the JDBC details for a named connection used by the XSQL pages processor.</p> <p>You may supply any number of <code><connection></code> element children of <code><connectiondefs></code>. Each connection definition must supply a name attribute and may supply children elements <code><username></code>, <code><password></code>, <code><driver></code>, <code><dburl></code>, and <code><autocommit></code>.</p>
XSQLConfig/connectiondefs/connection/username	Defines the user name for the current connection.
XSQLConfig/connectiondefs/connection/password	Defines the password for the current connection.

Table 32-2 (Cont.) XSQL Configuration File Settings

Configuration Setting Name	Description
XSQLConfig/connectiondefs/connection/dburl	Defines the JDBC connection URL for the current connection.
XSQLConfig/connectiondefs/connection/driver	Specifies the fully qualified Java class name of the JDBC driver used for the current connection. If not specified, defaults to <code>oracle.jdbc.driver.OracleDriver</code> .
XSQLConfig/connectiondefs/connection/autocommit	Explicitly sets the Auto Commit flag for the current connection. If not specified, the connection uses the JDBC driver default setting for Auto Commit.
XSQLConfig/serializerdefs/serializer	Defines a named custom serializer implementation. You can supply any number of <serializer> element children of <serializerdefs>. Each must specify both a <name> and a <class> child element.
XSQLConfig/serializerdefs/serializer/name	Defines the name of the current custom serializer definition.
XSQLConfig/connectiondefs/connection/class	Specifies the fully qualified Java class name of the current custom serializer. The class must implement the <code>XSQLDocumentSerializer</code> interface.

32.2.1 <xsql:action>

Element <xsql:action> is described.

Purpose

Invokes a user-defined action handler, implemented in Java, for executing custom logic and including custom XML data in a XSQL page. The Java class invoked with this action must implement the `oracle.xml.xsql.XSQLActionHandler` interface.

Use <xsql:action> to perform tasks that are not handled by the built-in action handlers. Custom actions can supply arbitrary XML content to the data page and perform arbitrary processing.

Usage Notes

The XSQL page processor processes the actions in a page in this way:

1. Constructs an instance of the action handler class with the default constructor.
2. Initializes the handler instance with the action element object and the page processor context by invoking the method `init(Element actionElt, XSQLPageRequest context)`.
3. Invokes the method that allows the handler to handle the action `handleAction(Node result)`.

Syntax

The syntax for this action is as follows, where `handler` is a single, required attribute named whose value is the fully qualified Java class name of the invoked action, `yourpackage` is the Java package, and `YourCustomHandler` is the Java class:

```
<xsql:action handler="yourpackage.YourCustomHandler" />
```

Some action handlers expect text content or element content to appear inside the `<xsql:action>` element. In this case, use syntax such as:

```
<xsql:action handler="yourpackage.YourCustomHandler">
  Some_text
</xsql:action>
```

You can also use this syntax:

```
<xsql:action handler="yourpackage.YourCustomHandler">
  <some>
    <other/>
    <elements/>
    <here/>
  </some>
</xsql:action>
```

Attributes

The only required attribute is `handler`, but you can supply additional attributes to the handler. For example, if `yourpackage.YourCustomHandler` is expecting attributes named `param1` and `param2`, then use this syntax:

```
<xsql:action handler="yourpackage.YourCustomHandler" param1="xxx" param2="yyy">
```

Examples

The following example shows an XSQL page that invokes the `myactions.StockQuotes` Java class. It includes stock quotes from Google for any symbols passed in with the `symbol` parameter. If this parameter is not supplied, it supplies a default list.

Retrieving Stock Quotes

```
<?xml version="1.0"?>
<page xmlns:xsql="urn:oracle-xsql">
  <xsql:action handler="myactions.StockQuotes"
    symbols="{@symbol}"
    symbol="ORCL,SAP,MSFT,IBM" />
</page>
```

32.2.2 <xsql:delete-request>

Element `<xsql:delete-request>` is described.

Purpose

Accepts data posted from an XML document or HTML form and uses the [XML SQL Utility \(XSU\)](#) to delete the content of an XML document in canonical form from a target table or view.

By combining XSU with XSLT, you can transform XML into the canonical format expected by a given table. Afterward, you can use XSU to delete the resulting

canonical XML. For a specified database table, the canonical XML form is given by one row of XML output from a `SELECT * query` against the table.

Syntax

The syntax for this action is as follows, where *table_name* is the name of a table and *key* is a list of one or more columns to use as the unique key:

```
<xsql:delete-request table="table_name" key-columns="key" />
```

Attributes

[Table 32-3](#) (page 32-9) lists the optional attributes that you can use on the `<xsql:delete-request>` action. Required attributes are in bold

Table 32-3 Attributes for <xsql:delete-request>

Attribute Name	Description
table = "string"	Name of the table, view, or synonym to use for deleting the XML data.
key-columns = "string string ..."	Space-delimited or comma-delimited list of one or more column names. The processor uses the values of these names in the posted XML document to identify the existing rows to delete.
transform = "URL"	Relative or absolute URL of the XSLT transformation to use to transform the document to be deleted into canonical ROWSET/ROW format.
columns = "string"	Relative or absolute URL of the XSLT transformation to use to transform the document to be deleted into canonical ROWSET/ROW format.
commit = "boolean"	If set to <i>yes</i> (default), invokes <code>COMMIT</code> on the current connection after a successful execution of the deletion. Valid values are <i>yes</i> and <i>no</i> .
commit-batch-size = "integer"	If a positive, nonzero <i>integer</i> is specified, then after each batch of <i>integer</i> deleted records, the processor issues a <code>COMMIT</code> . The default batch size is zero (0) if not specified, which means that the processor does not commit interim batches.
date-format = "string"	Date format mask to use for interpreting date field values in XML being deleted. Valid values are those documented for the <code>java.text.SimpleDateFormat</code> class.
error-param = "string"	Name of a page-private parameter that must be set to the string <code>Error</code> if a nonfatal error occurs while processing this action. Valid value is any parameter name.

Examples

The following example specifies that the posted XML document is to be transformed with the `style.xsl` stylesheet and then deleted from the `departments` table. The `departments.department_id` column is the primary key for the deletion.

Deleting Rows

```
<?xml version="1.0"?>
<xsql:delete-request table="departments"          transform="style.xsl"
  connection="demo" key-columns="department_id" xmlns:xsql="urn:oracle-xsql"/>
```

32.2.3 <xsql:dml>

Element <xsql:dml> is described.

Purpose

Executes a DML or DDL statement or a PL/SQL block. Typically, you use this tag to include statements that would be executed or rolled back together.

This action requires a database connection provided as a `connection="connname"` attribute on the document element of the XSQL page in which it appears.

Usage Notes

You cannot set parameter values by binding them in the position of OUT variables with <xsql:dml>. Only IN parameters are supported for binding.

Syntax

The syntax for the action is as follows, where *DML_DDL_or_PLSQL* is a placeholder for a legal DML statement, DDL statement, or PL/SQL block:

```
<xsql:dml>  
  DML_DDL_or_PLSQL  
</xsql:dml>
```

Attributes

[Table 32-4](#) (page 32-10) lists the optional attributes that you can use on the <xsql:dml> action.

Table 32-4 Attributes for <xsql:dml>

Attribute Name	Description
<code>commit = "boolean"</code>	If set to <code>yes</code> , invokes <code>commit</code> on the current connection after a successful execution of the DML statement. Valid values are <code>yes</code> and <code>no</code> (default).
<code>bind-params = "string"</code>	Ordered, space-delimited list of one or more XSQL parameter names. The values of these parameters are used to bind to the JDBC bind variable in the appropriate sequential position in the SQL statement.
<code>error-param = "string"</code>	Name of a page-private parameter that must be set to the string 'Error' if a nonfatal error occurs while processing this action. Valid value is any parameter name.
<code>error-statement = "boolean"</code>	If set to <code>no</code> , suppresses the inclusion of the offending SQL statement in any <xsql-error> element generated. Valid values are <code>yes</code> (default) and <code>no</code> .

Examples

The following example inserts the user name stored in the `webuser` cookie into a `request_log` table. Using bind variables guards against SQL injection attacks.

Inserting a User Name into a Table

```
<xsql:dml connection="demo" bind-params="webuser"  
  xmlns:xsql="urn:oracle-xsql">
```

```

BEGIN
  INSERT INTO request_log(page,userid)
    VALUES( 'somepage.xsql', ? );
  COMMIT;
END;
</xsql:dml>

```

32.2.4 <xsql:if-param>

Element <xsql:if-param> is described.

Purpose

Enables you to include elements and actions nested inside if a specified condition is true. If the condition is true, then all nested XML content and actions are included in the page. If the condition is false, then none of the nested XML content or actions is included (and thus none of the nested actions is executed).

Specify which parameter value is evaluated by supplying the required name attribute. Simple parameter names and array-parameter names are supported.

Note:

If the parameter being tested does not exist, the test evaluates to false.

Syntax

The syntax for the action is this, where *some_name* is the value of the name attribute and *test_condition* is exactly one of the conditions listed in [Table 32-5](#) (page 32-12):

```

<xsql:if-param name="some_name" test_condition>
  element_or_action
</xsql:if-param>

```

Any XML content or XSQL action elements can be nested inside an <xsql:if-param>, including other <xsql:if-param> elements.

Attributes

In addition to the required name attribute, you must choose exactly one of the attributes listed in [Table 32-5](#) (page 32-12) to indicate how the parameter value (or values, in the array case) is tested. As with other XSQL actions, the attributes of the <xsql:if-param> action can contain lexical substitution parameter expressions such as {@paramName}.

Table 32-5 Attributes for <xsql:if-param>

Attribute Name	Description
<code>exists="yes_or_no"</code>	<p>If set to <code>exists="yes"</code>, then this condition tests whether the named parameter exists and has a nonempty value. For an array-valued parameter, it tests whether the array-parameter exists and has at least one nonempty element.</p> <p>If set to <code>exists="no"</code>, then this condition evaluates to true if the parameter does not exist, or if it exists but has an empty value. For an array-valued parameter, it evaluates to true if the parameter does not exist, or if all of the array elements are empty.</p>
<code>equals="stringValue"</code>	<p>This condition tests whether the named parameter equals the string value provided. By default the comparison is an exact string match. For a case-insensitive match, supply the additional <code>ignore-case="yes"</code> attribute as well.</p> <p>For an array-valued parameter, the condition tests whether any element in the array has the indicated value.</p>
<code>not-equals="stringValue"</code>	<p>This condition tests whether the named parameter does not equal the string value provided. By default the comparison is an exact string match. For an array-valued parameter, the condition evaluates to true if none of the elements in the array has the indicated value.</p>
<code>in-list = "comma-or-space-separated-list"</code>	<p>This condition tests whether the named parameter matches any of the strings in the provided list. By default the comparison is an exact string match. For a case-insensitive match, supply the additional <code>ignore-case="yes"</code> attribute as well.</p> <p>The value of the <code>in-list</code> parameter is tokenized into an array with commas as the delimiter if commas are detected in the string. Otherwise, it uses a space as the delimiter. For an array-valued parameter, the condition tests whether any element in the array matches an element in the list.</p>
<code>not-in-list = "comma-or-space-separated-list"</code>	<p>This tests whether the named parameter does not match any of the strings in the provided list. By default the comparison is an exact string match. For a case-insensitive match, supply the additional <code>ignore-case="yes"</code> attribute as well.</p> <p>The value of the <code>not-in-list</code> parameter is tokenized into an array with commas as the delimiter if commas are in the string. Otherwise, the processor uses a space as the delimiter. For an array-valued parameter, the condition tests whether none of the elements in the array matches an element in the list.</p>

Examples

To test whether two different conditions are true, you can use nested `<xsql:if-param>` elements as shown in the following example.

Testing Conditions

```
<?xml version="1.0"?>
<?xml-stylesheet type="text/xsl" href="style.xsl"?>
<page connection="demo" xmlns:xsql="urn:oracle-xsql">
<!--
```



```
| Set page parameter 'some_param' to value "some_value" if parameter 'a'
| exists, and if parameter 'b' has a value equal to "X"
+-->
  <xsql:if-param name="a" exists="yes">
    <xsql:if-param name="b" equals="X">
      <xsql:set-page-param name="some_param" value="some_value"/>
    </xsql:if-param>
  </xsql:if-param>
  <!-- ... -->
</page>
```

32.2.5 <xsql:include-owa>

Element <xsql:include-owa> is described.

Purpose

Includes XML content generated by a database stored procedure. This action requires a database connection to be provided by supplying a `connection="connname"` attribute on the document element of the XSQL page in which it appears.

The stored procedure uses the standard OWA packages (HTP and HTF) to "print" the XML tags into the server-side page buffer. Afterwards, the XSQL pages processor fetches, parses, and includes the dynamically-produced XML content in the data page. The stored procedure must generate a well-formed XML page or an appropriate error is displayed.

Usage Notes

You can create a wrapper procedure that constructs XML elements with the HTP package. Your XSQL page can invoke the wrapper procedure by using <xsql:include-owa>.

Syntax

The syntax for the action is as follows, where *PL/SQL_block* is a PL/SQL Block invoking a procedure that uses the HTP or HTF packages:

```
<xsql:include-owa>
  PL/SQL_block
</xsql:include-owa>
```

Attributes

[Table 32-6](#) (page 32-13) lists the optional attributes supported by this action.

Table 32-6 Attributes for <xsql:include-owa>

Attribute Name	Description
<code>bind-params = "string"</code>	Ordered, space-delimited list of one or more XSQL parameter names. The values of these parameters are used to bind to the JDBC bind variable in the appropriate sequential position in the SQL statement.
<code>error-param = "string"</code>	Name of a page-private parameter that must be set to the string 'Error' if a nonfatal error occurs while processing this action. Valid value is any parameter name.

Table 32-6 (Cont.) Attributes for <xsql:include-owa>

Attribute Name	Description
error-statement = "boolean"	If set to no, suppresses the inclusion of the offending SQL statement in any <xsql-error> element generated. Valid values are yes (default) and no.

Examples

Assume that you write a PL/SQL procedure called `UpdateStatus` that updates the status of a project. The procedure uses HTP to print an `<UpdateStatus>` datagram that contains the element `<Success/>` if no errors occur or one or more `<Error>` elements if errors occur.

The following example shows how you can invoke `UpdateStatus` from an XSQL page. The example uses SQL bind variable instead of lexical substitution to prevent the possibility of SQL injection attacks.

Including XML Content Created by a Stored Procedure

```
<xsql:include-owa connection="demo"
                 bind-params="project status"
                 xmlns:xsql="urn:oracle-xsql">
  UpdateStatus( ?,? );
</xsql:include-owa>
```

Assume that a user enters an invalid status number for a project into a web-based form. The form posts the input parameters to an XSQL page as shown in the following example. The XSQL processor returns this datagram, which an XSLT stylesheet could transform into an HTML error page:

```
<UpdateStatus>
  <Error Field="status">Status must be 1, 2, 3, or 4</Error>
</UpdateStatus>
```

32.2.6 <xsql:include-param>

Element `<xsql:include-param>` is described.

Purpose

Includes an XML representation of the name and value of a single parameter. This technique is useful if an associated XSLT stylesheet must refer to parameter values with XPath expressions.

Syntax

The syntax of the action is as follows, where *paramname* is the name of a parameter:

```
<xsql:include-param name="paramname" />
```

The required name attribute supplies the name of the parameter whose value you want to include.

Attributes

The name attribute is required; there are no optional attributes.

Examples

The following example uses XPATH to get the value of a parameter and represent it in XML.

Including an XML Representation of a Parameter Value

```

<?xml version="1.0"?>
<?xml-stylesheet type="text/xsl" href="style.xsl"?>
<page connection="demo" xmlns:xsql="urn:oracle-xsql"
      xmlns:p="http://www.companysite.com/products">
  <xsql:set-page-param name="productid"
    xpath="/p:Products/productid"/>
  <xsql:include-param name="productid"/>
</page>

```

The XML fragment included in the datagram is:

```
<productid>12345</productid>
```

You can use an array parameter name to indicate that the value is to be treated as an array, as shown in this example:

```
<xsql:include-param name="productid[]"/>
```

The XML fragment reflects all of the array values, as shown in this example:

```

<productid>
  <value>12345</value>
  <value>33455</value>
  <value>88199</value>
</productid>

```

In this array-parameter name scenario, if `productid` is a single-valued parameter, then the fragment looks identical to a one-element array, as shown in this example:

```

<productid>
  <value>12345</value>
</productid>

```

32.2.7 <xsql:include-posted-include-posted>

Element `<xsql:dml>` is described.

Purpose

Includes the posted XML document in the XSQL page. If the user posts an HTML form instead of an XML document, then the XML included is similar to that included by the `<xsql:include-request-params>` action.

Syntax

The syntax of the action is:

```
<xsql:include-posted-xml/>
```

Attributes

None.

Examples

The following example shows a sample XSQL page that includes a posted XML document.

Including Posted XML

```
<?xml version="1.0"?>
<?xml-stylesheet type="text/xsql" href="somepage.xsql"?>
<page connection="demo"
  xmlns:xsql="urn:oracle-xsql">
  <xsql:include-posted-xml/>
</page>
```

32.2.8 <xsql:include-request-params>

Element <xsql:include-request-params> is described.

Purpose

Includes an XML representation of all parameters in the request in the datagram. The action element is replaced in the page at page-request time with a tree of XML elements that represents the parameters available to the request.

This technique is useful if an associated XSLT stylesheet must refer to request parameter values with XPath expressions.

Usage Notes

When processing pages through the XSQL servlet, the XML included takes the form shown in the following example.

Including Request Parameters

```
<request>
  <parameters>
    <paramname>value1</paramname>
    <ParamName2>value2</ParamName2>
    ...
  </parameters>
  <session>
    <sessVarName>value1</sessVarName>
    ...
  </session>
  <cookies>
    <cookieName>value1</cookieName>
    ...
  </cookies>
</request>
```

When you use the XSQL command-line utility or the XSQLRequest class, the XML takes the form shown in the following example.

Including Request Parameters

```
<request>
  <parameters>
    <paramname>value1</paramname>
    <ParamName2>value2</ParamName2>
    ...
  </parameters>
</request>
```

The technique enables you to distinguish request parameters from session parameters or cookies because its value is a child element of <parameters>, <session>, or <cookies>.

Syntax

The syntax of the action is:

```
<xsql:include-request-params/>
```

Attributes

None.

Examples

The following example shows a sample XSQL page that includes all request parameters in the data page.

Including Request Parameters

```
<?xml version="1.0"?>
<?xml-stylesheet type="text/xsql" href="cookie_condition.xsl"?>
<page connection="demo" xmlns:xsql="urn:oracle-xsql">
  <xsql:include-request-params/>
</page>
```

The `cookie_condition.xsl` stylesheet chooses an output format based on whether the `siteuser` cookie is present. The following example shows a fragment of the stylesheet.

Testing for Conditions in a Stylesheet

```
<xsl:choose>
  <xsl:when test="/page/request/cookies/siteuser">
    ...
  </xsl:when>
  <xsl:otherwise>
    ...
  </xsl:otherwise>
</xsl:choose>
```

32.2.9 <xsql:include-xml>

Element <xsql:include-xml> is described.

Purpose

Includes the XML contents of a local, remote, or database-driven XML resource in your datagram. You can specify the resource by URL or SQL statement. The server can deliver a resource that is a static XML file or dynamically created XML from a programmatic resource such as a servlet or common gateway interface (CGI) program.

Syntax

The syntax for this action is as follows, where *URL* is a relative URL or an absolute, HTTP-based URL to retrieve XML from another web site:

```
<xsql:include-xml href="URL"/>
```

Alternatively, you can use this syntax, where *SQL_statement* is a SQL `SELECT` statement selecting a single row containing a single CLOB or VARCHAR2 column value:

```
<xsql:include-xml>
  SQL_statement
</xsql:include-xml>
```

The `href` attribute and SQL statement are mutually exclusive. If you provide one, then the other is not allowed.

Attributes

Table 32-7 (page 32-18) lists the attributes supported by this action. Required attributes are in bold.

Table 32-7 Attributes for <xsql:include-xml>

Attribute Name	Description
href="URL"	The absolute, relative, or parameterized URL of the XML resource to be included. The resource can be a static file dynamic source.
bind-params = "string"	Ordered, space-delimited list of one or more XSQL parameter names. The values for these names are used to bind to the JDBC bind variable in the appropriate sequential position in the SQL statement.
error-param = "string"	Name of a page-private parameter that must be set to the string 'Error' if a nonfatal error occurs while processing this action. Valid value is any parameter name.

Examples

The following example includes an XML document retrieved by a database query. The XML content is a CLOB-valued member field of a user-defined type. The XML included must come from a VARCHAR2 or CLOB column, not an XMLType.

Including an XML Document

```
<?xml version="1.0"?>
<xsql:include-xml bind-params="id" connection="demo"
  xmlns:xsql="urn:oracle-xsql">
  SELECT x.document.contents doc FROM xmldoc x
  WHERE x.docid = ?
</xsql:include-xml>
```

32.2.10 <xsql:include-xsql>

Element `<xsql:include-xsql>` is described.

Purpose

Includes the XML output of one XSQL page in another page. You can create a page that assembles the contents—optionally transformed—from other XSQL pages.

Usage Notes

If the aggregated page contains an `<?xml-stylesheet?>` processing instruction, then this stylesheet is applied before the result is aggregated. Thus, you can use `<xsql:include-xsql>` to chain XSLT stylesheets.

When one XSQL page aggregates another page by using `<xsql:include-xsql>`, all request-level parameters are visible to the nested page. For pages processed by the XSQL Servlet, the visible data includes session-level parameters and cookies. None of the page-private parameters of the aggregating page are visible to the nested page.

Syntax

The syntax for this action is as follows, where *XSQL_page* is a relative or absolute URL of an XSQL page to be included:

```
<xsql:include-xsql href="XSQL_page" />
```

Attributes

[Table 32-8](#) (page 32-19) lists the attributes supported by this action. Required attributes are in bold; all others are optional.

Table 32-8 Attributes for <xsql:include-xsql>

Attribute Name	Description
href="string"	Relative or absolute URL of XSQL page to be included.
error-param = "string"	Name of a page-private parameter that must be set to the string <code>Error</code> if a nonfatal error occurs while processing this action. Valid value is any parameter name.
reparse = "boolean"	Indicates whether output of the included XSQL page must be reparsed before it is included. Valid values are <code>no</code> (default) and <code>yes</code> . This attribute is useful if the included XSQL page selects the text of an XML document fragment that the including page wants to treat as elements.

Examples

The following example displays an XSQL page that lists discussion forum categories.

Categories.xsql

```
<?xml version="1.0"?>
<xsql:query connection="demo" xmlns:xsql="urn:oracle-xsql">
  SELECT name
  FROM categories
  ORDER BY name
</xsql:query>
```

The following example shows how you can include the results of the page in the previous `Categories.xsql` example into a page that lists the ten most recent topics in the current forum.

TopTenTopics.xsql

```
<?xml version="1.0"?>
<?xml-stylesheet type="text/xsl" href="style.xsl"?>
<top-ten-topics connection="demo" xmlns:xsql="urn:oracle-xsql">
  <topics>
    <xsql:query max-rows="10">
      SELECT subject
      FROM topics
      ORDER BY last_modified DESC
    </xsql:query>
  </topics>
  <categories>
    <xsql:include-xsql href="Categories.xsql"/>
  </categories>
</top-ten-topics>
```

You can also use `<xsql:include-xsql>` to apply an XSLT stylesheet to an included page. Assume that you write this XSLT stylesheets:

- `cats-as-html.xsl`, which renders the topics in HTML
- `cats-as-wml.xsl`, which renders the topics in WML

One approach for catering to two different types of devices is to create different XSQL pages for each device. The following example shows an XSQL page that aggregates `Categories.xsql` and applies the `cats-as-html.xsl` stylesheet.

HTMLCategories.xsql

```
<?xml version="1.0"?>
<!-- HTMLCategories.xsql -->
<?xml-stylesheet type="text/xsl" href="cats-as-html.xsl"?>
<xsql:include-xsql href="Categories.xsql" xmlns:xsql="urn:oracle-xsql"/>
```

The following example shows an XSQL page that aggregates `Categories.xsql` and applies the `cats-as-html.xsl` stylesheet for delivering to wireless devices.

WMLCategories.xsql

```
<?xml version="1.0"?>
<!-- WMLCategories.xsql -->
<?xml-stylesheet type="text/xsl" href="cats-as-wml.xsl"?>
<xsql:include-xsql href="Categories.xsql" xmlns:xsql="urn:oracle-xsql"/>
```

32.2.11 <xsql:insert-param>

Element `<xsql:insert-param>` is described.

Purpose

Inserts the value of a parameter into a table or view. Use this tag when the client is posting a well-formed XML document as text in an HTTP parameter or individual HTML form field.

By combining the [XML SQL Utility \(XSU\)](#) with XSLT, you can transform XML into the canonical format expected by a given table. Afterward, you can use XSU to insert the resulting canonical XML. For a specified database table, the canonical XML form is given by one row of XML output from a `SELECT *` query against the table.

Syntax

The syntax for this action is as follows, where `table_or_view_name` is a relative or absolute URL of an XSQL page to be included:

```
<xsql:insert-param table="table_or_view_name" name="string"/>
```

Attributes

Table 32-9 (page 32-21) lists the optional attributes that you can use on the <xsql:insert-param> action.

Table 32-9 Attributes for <xsql:insert-param>

Attribute Name	Description
<code>name="string"</code>	Name of the parameter whose value contains XML to be inserted.
<code>table="string"</code>	Name of the table, view, or synonym to use for inserting the XML data.
<code>transform = "URL"</code>	Relative or absolute URL of the XSLT transformation to use to transform the document to be inserted into canonical ROWSET/ROW format.
<code>columns = "string"</code>	Space-delimited or comma-delimited list of one or more column names whose values are inserted. If supplied, then only these columns are inserted. If not supplied, all columns are inserted, with NULL values for columns whose values do not appear in the XML document.
<code>commit = "boolean"</code>	If set to <code>yes</code> , invokes <code>commit</code> on the current connection after a successful execution of the insert. Valid values are <code>yes</code> (default) and <code>no</code> .
<code>commit-batch-size = "integer"</code>	If a positive, nonzero number <i>integer</i> is specified, then after each batch of <i>integer</i> inserted records, the XSQL processor issues a <code>COMMIT</code> . Default batch size is zero (0), which instructs the processor not to commit interim batches.
<code>date-format = "string"</code>	Date format mask to use for interpreting date field values in XML being inserted. Valid values are those for the <code>java.text.SimpleDateFormat</code> class.
<code>error-param = "string"</code>	Name of a page-private parameter that must be set to <code>Error</code> if a nonfatal error occurs while processing this action. Valid value is any parameter name.

Examples

The following example parses and transforms the contents of the HTML form parameter `xmlfield` for database insert.

Inserting XML Contained in an HTML Form Parameter

```
<?xml version="1.0"?>
<xsql:insert-param name="xmlfield" table="image_metadata_table"
transform="field-to-rowset.xsl" connection="demo" xmlns:xsql="urn:oracle-xsql"/>
```

32.2.12 <xsql:insert-request>

Element <xsql:insert-request> is described.

Purpose

Accepts data posted from an XML document or HTML form and uses the [XML SQL Utility \(XSU\)](#) to insert the content of an XML document in canonical form into a target table or view.

If an HTML Form has been posted, then the posted XML document is materialized from HTTP request parameters, cookies, and session variables. The XML document has this form:

```
<request>
<parameters>
  <param1>value1</param1>
  :
  </paramN>valueN</paramN>
</parameters>
:
</request>
```

By combining XSU with XSLT, you can transform XML into the canonical format expected by a given table. The XSQL engine uses XSU to insert the resulting canonical XML. For a specified database table, the canonical XML form is given by one row of XML output from a `SELECT *` query against the table.

Usage Notes

If you target a database view with an `INSERT`, then you can create `INSTEAD OF INSERT` triggers on the view to further automate the handling of the posted data. For example, an `INSTEAD OF INSERT` trigger on a view can use PL/SQL to check for the existence of a record and intelligently choose whether to do an `INSERT` or an `UPDATE` depending on the result.

Syntax

The syntax for this action is:

```
<xsql:insert-request table="table"/>
```

Attributes

[Table 32-10](#) (page 32-22) lists the optional attributes that you can use on the `<xsql:insert-request>` action.

Table 32-10 Attributes for <xsql:insert-request>

Attribute Name	Description
<code>table = "string"</code>	Name of the table, view, or synonym to use for inserting the XML data.
<code>transform = "URL"</code>	Relative or absolute URL of the XSLT transformation to use to transform the document to be inserted into canonical ROWSET/ROW format.
<code>columns = "string"</code>	Relative or absolute URL of the XSLT transformation to use to transform the document to be inserted into canonical ROWSET/ROW format.
<code>commit = "boolean"</code>	If set to <code>yes</code> (default), invokes <code>COMMIT</code> on the current connection after a successful execution of the insert. Valid values are <code>yes</code> and <code>no</code> .

Table 32-10 (Cont.) Attributes for <xsql:insert-request>

Attribute Name	Description
commit-batch-size = "integer"	If a positive, nonzero number <code>integer</code> is specified, then after each batch of integer inserted records, the processor issues a COMMIT. The default batch size is zero (0) if not specified, which means that the processor does not commit interim batches.
date-format = "string"	Date format mask to use for interpreting date field values in XML being inserted. Valid values are those documented for the <code>java.text.SimpleDateFormat</code> class.
error-param = "string"	Name of a page-private parameter that must be set to the string <code>Error</code> if a nonfatal error occurs while processing this action. Valid value is any parameter name.

Examples

The following example parses and transforms the contents of the posted XML document or HTML Form for insert.

Inserting XML Received in a Parameter

```
<?xml version="1.0"?>
<xsql:insert-request
  table="purchase_order"
  transform="purchseorder-to-rowset.xsl"
  connection="demo"
  xmlns:xsql="urn:oracle-xsql"/>
```

32.2.13 <xsql:query>

Element `<xsql:query>` is described.

Purpose

Executes a SQL select statement and includes a canonical XML representation of the query result set in the data page. This action requires a database connection to be provided by supplying a `connection="connname"` attribute on the document element of the XSQL page in which it appears.

Syntax

The syntax for the action is:

```
<xsql:query>
  SELECT_Statement
</xsql:query>
```

Any legal SQL select statement is permissible as a substitution for the `SELECT_Statement` placeholder. If the select statement produces no rows, then you can provide a fallback query by including a nested `<xsql:no-rows-query>` element:

```
<xsql:query>
  SELECT_Statement
  <xsql:no-rows-query>
```

```
        Fallback_SELECT_Statement
    </xsql:no-rows-query>
</xsql:query>
```

An <xsql:no-rows-query> element can *itself* contain nested <xsql:no-rows-query> elements to any level of nesting. The options available on the <xsql:no-rows-query> are identical to those legal on the <xsql:query> action element.

Attributes

The optional attributes listed in [Table 32-11](#) (page 32-24) can be supplied to control various aspects of the data retrieved and the XML produced by the <xsql:query> action.

Table 32-11 Attributes for <xsql:query>

Attribute Name	Description
bind-params = "string"	Ordered, space-delimited list of one or more XSQL parameter names. The values of these parameters are used to bind to the JDBC bind variable in the appropriate sequential position in the SQL statement.
date-format = "string"	Date format mask to use for formatted date column and attribute values in the XML that is queried. Valid values are the same values legal for the <code>java.text.SimpleDateFormat</code> class.
error-param = "string"	Name of a page-private parameter that must be set to the string 'Error' if a nonfatal error occurs while processing this action. Valid value is any parameter name.
error-statement = "boolean"	If set to <code>no</code> , suppresses the inclusion of the offending SQL statement in any <xsql-error> element generated. Valid values are <code>yes</code> (default) and <code>no</code> .
fetch-size = "integer"	Number of records to fetch in each round trip to the database. If not set, the default value is used as specified by the <code>/XSQLConfig/processor/default-fetch-size</code> configuration setting in <code>XSQLConfig.xml</code> .
id-attribute = "string"	XML attribute name to use instead of the default <code>num</code> for uniquely identifying each row in the result set. If the value is the empty string, then the row id attribute is suppressed.
id-attribute-column = "string"	Case-sensitive name of the column in the result set whose value must be used in each row as the value of the row id attribute. The default is to use the row count as the value of the row id attribute.
include-schema = "boolean"	If set to <code>yes</code> , includes an inline XML schema that describes the structure of the result set. Valid values are <code>yes</code> and <code>no</code> (default).
max-rows = "integer"	Maximum number of rows to fetch after optionally skipping the number of rows set by the <code>skip-rows</code> attribute. If not specified, the default is to fetch all rows.
null-indicator = "boolean"	Indicates whether to signal that a column's value is NULL by including the <code>NULL="Y"</code> attribute on the element for the column. By default, columns with NULL values are omitted from the output. Valid values are <code>yes</code> and <code>no</code> (default).

Table 32-11 (Cont.) Attributes for <xsql:query>

Attribute Name	Description
row-element = "string"	XML element name to use instead of the default <ROW> for the rowset of query results. Set to the empty string to suppress generating a containing <ROW> element for each row in the result set.
rowset-element = "string"	XML element name to use instead of the default <ROWSET> for the rowset of query results. Set to the empty string to suppress generating a containing <ROWSET> element.
skip-rows = "integer"	Number of rows to skip before fetching rows from the result set. Can be combined with max-rows for stateless paging through query results.
tag-case = "string"	Valid values are lower and upper. If not specified, the default is to use the case of column names as specified in the query as corresponding XML element names.

Examples

The following example shows a simple XSQL page.

Hello World

```
<?xml version="1.0"?>
<xsql:query connection="xmlbook" xmlns:xsql="urn:oracle-xsql">
  SELECT 'Hello, World!' AS text      FROM DUAL</xsql:query>
```

If you save the previous example as `hello.xsql` and execute it in a browser, the XSQL page processor returns this XML:

```
<?xml version = '1.0'?>
<ROWSET>
  <ROW num="1">
    <TEXT>Hello, World!</TEXT>
  </ROW>
</ROWSET>
```

By default, the XML produced by a query reflects the column structure of its result set, with element names matching the names of the columns. Columns in the result with this nested structure produce nested elements that reflect this structure:

- Object types
- Collection types
- CURSOR expressions

The result of a typical query containing different types of columns and returning one row might look like the following example.

Nested Structure Example

```
<ROWSET>
  <ROW id="1">
    <VARCHARCOL>Value</VARCHARCOL>
    <NUMBERCOL>12345</NUMBERCOL>
    <DATECOL>12/10/2001 10:13:22</DATECOL>
    <OBJECTCOL>
```

```
<ATTR1>Value</ATTR1>
<ATTR2>Value</ATTR2>
</OBJECTCOL>
<COLLECTIONCOL>
  <COLLECTIONCOL_ITEM>
    <ATTR1>Value</ATTR1>
    <ATTR2>Value</ATTR2>
  </COLLECTIONCOL_ITEM>
  <COLLECTIONCOL_ITEM>
    <ATTR1>Value</ATTR1>
    <ATTR2>Value</ATTR2>
  </COLLECTIONCOL_ITEM>
</COLLECTIONCOL>
<CURSORCOL>
  <CURSORCOL_ROW>
    <COL1>Value1</COL1>
    <COL2>Value2</COL2>
  </CURSORCOR_ROW>
</CURSORCOL>
</ROW>
</ROWSET>
```

A `<ROW>` element repeats for each row in the result set. Your query can use standard SQL column aliasing to rename the columns in the result, which effectively renames the XML elements that are produced. Column aliasing is *required* for columns whose names otherwise are illegal names for an XML element.

For example, an `<xsql:query>` action as shown in the following example produces an error because the default column name for the calculated expression is an illegal XML element name.

Query with Error

```
<?xml version="1.0"?>
<?xml-stylesheet type="text/xsl" href="style.xsl"?>
<xsql:query connection="demo" xmlns:xsql="urn:oracle-xsql">
  SELECT TO_CHAR(hire_date,'DD-MON')
  FROM employees
</xsql:query>
```

You can fix the problem by using column aliasing as shown in the following example.

Query with Column Aliasing

```
<?xml version="1.0"?>
<?xml-stylesheet type="text/xsl" href="style.xsl"?>
<xsql:query connection="demo" xmlns:xsql="urn:oracle-xsql">
  SELECT TO_CHAR(hire_date,'DD-MON') AS hiredate FROM employees
</xsql:query>
```

32.2.14 <xsql:ref-cursor-function>

Element `<xsql:ref-cursor-function>` is described.

Purpose

Executes an arbitrary stored function returning a REF CURSOR and includes the query result set in canonical XML format. This action requires a database connection to be provided by supplying a `connection="connname"` attribute on the document element of the XSQL page in which it appears.

Use this tag to invoke a stored procedure that determines what the query is and returns a cursor to the query. Used in this way, this tag also provides a weak level of security because it can hide the query from direct inspection.

Syntax

The syntax of the action is as follows, where `SCHEMA_NAME` represents an optional database schema name, `PACKAGE_NAME` represents an optional PL/SQL package name, and `FUNCTION_NAME` (required) specifies the name of a PL/SQL function:

```
<xsql:ref-cursor-function>
  [SCHEMA_NAME.][PACKAGE_NAME.]FUNCTION_NAME(args);
</xsql:ref-cursor-function>
```

Attributes

The optional attributes are the same as for the `<xsql:query>` action listed in [Table 32-11](#) (page 32-24) except that `fetch-size` is not available for `<xsql:ref-cursor-function>`.

Examples

By exploiting dynamic SQL in PL/SQL, a function can conditionally construct a dynamic query before a cursor handle to its result set is returned to the XSQL page processor. The return value of the function must be of type `REF CURSOR`. Consider the PL/SQL package shown in the following example.

DynCursor PL/SQL Package

```
CREATE OR REPLACE PACKAGE DynCursor IS
  TYPE ref_cursor IS REF CURSOR;
  FUNCTION DynamicQuery(id NUMBER) RETURN ref_cursor;
END;
CREATE OR REPLACE PACKAGE BODY DynCursor IS
  FUNCTION DynamicQuery(id NUMBER) RETURN ref_cursor IS
    the_cursor ref_cursor;
  BEGIN
    IF id = 1 THEN -- Conditionally return a dynamic query as a REF CURSOR
      OPEN the_cursor -- An employees Query
      FOR 'SELECT employee_id, email FROM employees';
    ELSE
      OPEN the_cursor -- A departments Query
      FOR 'SELECT department_name, department_id FROM departments';
    END IF;
    RETURN the_cursor;
  END;
END;
```

An `<xsql:ref-cursor-function>` can include the dynamic results of the `REF CURSOR` returned by this function as shown in the following example.

Executing a REF CURSOR Function

```
<?xml version="1.0"?>
<?xml-stylesheet type="text/xsl" href="style.xsl"?>
<xsql:ref-cursor-function connection="demo" xmlns:xsql="urn:oracle-xsql">
  DynCursor.DynamicQuery(1);
</xsql:ref-cursor-function>
```

32.2.15 <xsql:set-cookie>

Element `<xsql:set-cookie>` is described.

Purpose

Sets an HTTP cookie to a value. By default, the value remains for the lifetime of the current browser, but you can change its lifetime by supplying the optional `max-age` attribute. The value to be assigned to the cookie can be supplied by a combination of static text and other parameter values, or from the result of a SQL `SELECT` statement.

Because this feature is specific to the HTTP protocol, this action is effective only if the XSQL page in which it appears is processed by the XSQL servlet. If this action is encountered in an XSQL page processed by the XSQL command-line utility or the `XSQLRequest` programmatic application programming interface (API), then it does nothing.

Usage Notes

If you use the SQL statement option, then a single row is fetched from the result set and the parameter is assigned the value of the first column. This use requires a database connection to be provided by supplying a `connection="connname"` attribute on the document element of the XSQL page in which it appears.

If you must set several cookie values based on the results of a single SQL statement, then do not use the `name` attribute. Instead, you can use the `names` attribute and supply a space-or-comma-delimited list of one or more cookie names.

Syntax

The syntax for this action is as follows, where *paramname* is the name of a parameter:

```
<xsql:set-cookie name="paramname" value="value" />
```

Alternatively, you can use this syntax, where *SQL_statement* is a SQL `SELECT` statement and *paramname* is the name of a parameter:

```
<xsql:set-cookie name="paramname">  
  SQL_statement  
</xsql:set-cookie>
```

Either the `name` or the `names` attribute is required. The `value` attribute and the contained SQL statement are mutually exclusive. The number of columns in the select list must match the number of cookies being set or an error message results.

Attributes

[Table 32-12](#) (page 32-28) lists the attributes supported by this action. Attributes in bold are required; all others are optional.

Table 32-12 Attributes for <xsql:set-cookie>

Attribute Name	Description
name = "string"	Name of the cookie whose value you want to set. You must use <code>name</code> or <code>names</code> but not both.

Table 32-12 (Cont.) Attributes for <xsql:set-cookie>

Attribute Name	Description
<code>names = "string string ..."</code>	Space-or-comma-delimited list of the cookie names whose values you want to set. You must use name or names but not both.
<code>bind-params = "string"</code>	Ordered, space-delimited list of one or more XSQL parameter names. Values are used to bind to the JDBC bind variable in the appropriate sequential position in the SQL statement.
<code>domain = "string"</code>	Domain in which cookie value is valid and readable. If <code>domain</code> is not set explicitly, it defaults to the fully qualified host name (for example, <code>server.biz.com</code>) of the document creating the cookie.
<code>error-param = "string"</code>	Name of a page-private parameter that is set to the string 'Error' if a nonfatal error occurs while processing this action. Valid value is any parameter name.
<code>ignore-empty-value = "boolean"</code>	Indicates whether the cookie assignment is ignored if the value to which it is being assigned is an empty string. Valid values are <code>yes</code> and <code>no</code> (default).
<code>immediate = "boolean"</code>	Indicates whether the cookie assignment is immediately visible to the current page. Typically, cookies set in the current request are not visible until the browser sends them back to the server in a subsequent request. Valid values are <code>yes</code> and <code>no</code> (default).
<code>max-age = "integer"</code>	Sets the maximum age of the cookie in <i>seconds</i> . Default is to set the cookie to expire when users current browser session terminates.
<code>only-if-unset = "boolean"</code>	Indicates whether the cookie assignment occurs only when the cookie currently does not exists. Valid values are <code>yes</code> and <code>no</code> (default).
<code>path = "string"</code>	Relative URL path within domain in which cookie value is valid and readable. If <code>path</code> is not set explicitly, then it defaults to the URL path of the document creating the cookie.
<code>value = "string"</code>	Sets the value to assign to the cookie.

Examples

The following example sets the HTTP cookie to the value of the parameter named `choice`.

Setting a Cookie to a Parameter Value

```
<?xml version="1.0"?>
<xsql:set-cookie name="last_selection"
    value="{@choice}" xmlns:xsql="urn:oracle-xsql"/>
```

[Table 32-5](#) (page 32-12) sets the HTTP cookie to a value selected from the database.

Setting a Cookie to a Database-Generated Value

```
<?xml version="1.0"?>
<xsql:set-cookie name="shopping_cart_id" bind-params="user"
                connection="demo"          xmlns:xsql="urn:oracle-xsql">
    SELECT cartmgr.new_cart_id(UPPER(?)) FROM DUAL
</xsql:set-cookie>
```

[Table 32-6](#) (page 32-13) sets three cookies based on the result of a single SELECT statement.

Setting Three Cookies

```
<?xml version="1.0"?>
<xsql:set-cookie names="paramname1 paramname2 paramname3"
                connection="demo" xmlns:xsql="urn:oracle-xsql">
    SELECT expression_or_column1, expression_or_column2, expression_or_column3
    FROM table
    WHERE clause_identifying_a_single_row
</xsql:set-cookie>
```

32.2.16 <xsql:set-page-param>

Element `<xsql:set-page-param>` is described.

Purpose

Sets a page-private parameter to a value. The value can be supplied by a combination of static text and other parameter values, or alternatively from the result of a SQL SELECT statement.

Usage Notes

If you use the SQL statement option, then the program fetches a single row from the result set and assigns the parameter the value of the first column. This usage requires a database connection to be provided by supplying a `connection="connname"` attribute on the document element of the XSQL page in which it appears.

As an alternative to providing the `value` attribute, or a SQL statement, you can supply the `xpath` attribute to set the page-level parameter to the value of an XPath expression. The XPath expression is evaluated against an XML document or HTML form that has been posted to the XSQL pages processor. The value of the `xpath` attribute can be any valid XPath expression, optionally built using XSQL parameters as part of the attribute value like any other XSQL action element.

After a page-private parameter is set, subsequent action handlers can use this value as a lexical parameter, for example `{@po_id}`. Alternatively, action handlers can use this value as a SQL bind parameter value; they can reference its name in the `bind-params` attribute of any action handler that supports SQL operations.

If you must set multiple session parameter values based on the results of a single SQL statement, instead of using the `name` attribute, then you can use the `names` attribute. You can supply a list, delimited by spaces or commas, of one or more session parameter names.

Syntax

The syntax for this action is as follows, where *paramname* is the name of a parameter and *value* is a value:

```
<xsql:set-page-param name="paramname" value="value" />
```

Alternatively, you can use this syntax, where *SQL_statement* is a SQL SELECT statement and *paramname* is the name of a parameter:

```
<xsql:set-page-param nname="paramname">
  SQL_statement
</xsql:set-page-param>
```

Alternatively, you can use this syntax, where *paramname* is the name of a parameter and where *expression* is an XPath expression:

```
<xsql:set-page-param name="paramname" xpath="expression" />
```

Either the name or the names attribute is required. The value attribute and the contained SQL statement are mutually exclusive.

Attributes

[Table 32-13](#) (page 32-31) lists the attributes supported by this action. Attributes in bold are required; all others are optional.

Table 32-13 Attributes for <xsql:set-page-param>

Attribute Name	Description
name = <i>"string"</i>	Name of the page-private parameter whose value you want to set.
names = <i>"string string ..."</i>	Space-or-comma-delimited list of the page parameter names whose values you want to set. Either use the name or the names attribute, but not both.
bind-params = <i>"string"</i>	Ordered, space-delimited list of one or more XSQL parameter names. The values of these parameters are used to bind to the JDBC bind variable in the appropriate sequential position in the SQL statement.
error-param = <i>"string"</i>	Name of a page-private parameter that must be set to the string 'Error' if a nonfatal error occurs while processing this action. Valid value is any parameter name.
ignore-empty-value = <i>"boolean"</i>	Indicates whether the page-level parameter assignment is ignored if the value to which it is being assigned is an empty string. Valid values are yes and no (default).
quote-array-values = <i>"boolean"</i>	If the parameter name is a simple-valued parameter name (for example, myparam) and if <i>treat-list-as-array="yes"</i> is specified, then specifying <i>quote-array-values="yes"</i> surrounds each string token with single quotation marks before separating the values with commas. Valid values are yes and no (default).

Table 32-13 (Cont.) Attributes for <xsql:set-page-param>

Attribute Name	Description
<code>treat-list-as-array = "boolean"</code>	Indicates whether the string-value assigned to the parameter is tokenized into an array of separate values before assignment. If any comma is present in the string, then the comma is used for separating tokens. Otherwise, spaces are used. Valid values are yes and no. The default value is yes if the parameter name being set is an array parameter name (for example, <code>myparam[]</code>), and default is no if the parameter name being set is a simple-valued parameter name like <code>myparam</code> .
<code>value = "string"</code>	Sets the value to assign to the parameter.
<code>xpath = "XPathExpression"</code>	Sets the value of the parameter to an XPath expression evaluated against an XML document or HTML form that has been posted to the XSQL pages processor.

Examples

The following example sets multiple parameter values based on the results of a single SQL statement.

Setting Multiple Page Parameters

```
<?xml version="1.0"?>
<?xml-stylesheet type="text/xsl" href="style.xsl"?>
<xsql:set-page-param names="paramname1 paramname2 paramname3"
                    connection="demo" xmlns:xsql="urn:oracle-xsql">
  SELECT expression_or_column1, expression_or_column2, expression_or_column3
  FROM table
  WHERE clause_identifying_a_single_row
</xsql:set-page-param>
```

The following example sets the page-level parameter to a value selected from database and then uses it as the value of an `xsql:query` attribute.

Setting a Parameter to a Database-Generated Value

```
<?xml version="1.0"?>
<?xml-stylesheet type="text/xsl" href="style.xsl"?>
<page connection="demo" xmlns:xsql="urn:oracle-xsql">
  <xsql:set-page-param name="max-rows-pref">
    SELECT max_rows
    FROM user_profile
    WHERE userid = {@userid}
  </xsql:set-page-param>
  <xsql:query max-rows="{@max-rows-pref}">
    SELECT title, url
    FROM newsstory
    ORDER BY date_entered DESC
  </xsql:query>
</page>
```

32.2.17 <xsql:set-session-param>

Element `<xsql:set-session-param>` is described.

Purpose

Sets an HTTP session-level parameter to a value. The value of the session-level parameter remains for the lifetime HTTP session of the current browser user. The web server controls the session. The value can be supplied by a combination of static text and other parameter values, or from the result of a SQL `SELECT` statement.

Because this feature is specific to Java servlets, this action is effective only if the XSQL page in which it appears is processed by the XSQL servlet. If this action occurs in an XSQL page processed by the XSQL command-line utility or the XSQLRequest programmatic API, it does nothing.

Usage Notes

If you use the SQL statement option, the XSQL processor fetches a single row from the result set and assigns the parameter the value of the first column. This use requires a database connection to be provided by supplying a `connection="connname"` attribute on the document element of the XSQL page in which it appears.

To set several session parameter values based on the results of a single SQL statement, do not use the `name` attribute. Instead, use the `names` attribute and supply a space-or-comma-delimited list of one or more session parameter names.

Syntax

The syntax for this action is as follows, where *paramname* is the name of a parameter and where *value* is a value:

```
<xsql:set-session-param name="paramname" value="value" />
```

Alternatively, you can use this syntax, where *SQL_statement* is a SQL `SELECT` statement and *paramname* is the name of a parameter:

```
<xsql:set-session-param name="paramname">
  SQL_statement
</xsql:set-session-param>
```

Either the `name` or the `names` attribute is required. The `value` attribute and the contained SQL statement are mutually exclusive.

Attributes

[Table 32-14](#) (page 32-33) lists the optional attributes supported by this action. Attributes in bold are required; all others are optional.

Table 32-14 Attributes for <xsql:set-session-param>

Attribute Name	Description
name = " <i>string</i> "	Name of the session-level variable whose value you want to set. Either use the <code>name</code> or the <code>names</code> attribute, but not both.
names = " <i>string string ...</i> "	Space-or-comma-delimited list of the session parameter names whose values you want to set. Either use the <code>name</code> or the <code>names</code> attribute, but not both.
bind-params = " <i>string</i> "	Ordered, space-delimited list of one or more XSQL parameter names. The parameter values are used to bind to the JDBC bind variable in the appropriate sequential position in the SQL statement.

Table 32-14 (Cont.) Attributes for <xsql:set-session-param>

Attribute Name	Description
error-param = "string"	Name of a page-private parameter that is set to the string 'Error' if a nonfatal error occurs while processing this action. Valid value is any parameter name.
ignore-empty-value = "boolean"	Indicates whether the session-level parameter assignment is ignored if the value to which it is being assigned is an empty string. Valid values are yes and no (default).
only-if-unset = "boolean"	Indicates whether the session variable assignment occurs only when the session variable currently does not exist. Valid values are yes and no (default).
quote-array-values = "boolean"	If the parameter name is a simple-valued parameter name (for example, myparam) and if treat-list-as-array="yes" is specified, then specifying quote-array-values="yes" surrounds each string token with single quotation marks before separating the values with commas. Valid values are yes and no (default).
treat-list-as-array = "boolean"	Indicates whether the string-value assigned to the parameter is tokenized into an array of separate values before assignment. If any comma is present in the string, then the comma is used for separating tokens. Otherwise, spaces are used. Valid values are yes and no. The default value is yes if the parameter name being set is an array parameter name (for example, myparam[]), and default is no if the parameter name being set is a simple-valued parameter name like myparam.
value = "string"	Sets the value to assign to the parameter.

Examples

The following example sets multiple session parameter values based on the results of a single SELECT statement.

Setting Session Parameters

```
<?xml version="1.0"?>
<?xml-stylesheet type="text/xsl" href="style.xsl"?>
<page connection="demo" xmlns:xsql="urn:oracle-xsql">
  <xsql:set-session-param names="paramname1 paramname2 paramname3">
    SELECT expression_or_column1, expression_or_column2, expression_or_column3
    FROM table
    WHERE clause_identifying_a_single_row
  </xsql:set-session-param>
  <!-- ... -->
</page>
```

32.2.18 <xsql:set-stylesheet-param>

Element <xsql:set-stylesheet-param> is described.

Purpose

Sets a top-level XSLT stylesheet parameter to a value. The value can be supplied by a combination of static text and other parameter values, or from the result of a SQL

SELECT statement. The stylesheet parameter is set on any stylesheet used during the processing of the current page.

Usage Notes

If you use the SQL statement option, then a single row is fetched from the result set and the parameter is assigned the value of the first column. This use requires a database connection to be provided by supplying a `connection="connname"` attribute on the document element of the XSQL page in which it appears.

To set several stylesheet parameter values based on the results of a single SQL statement, do not use the `name` attribute. You can use the `names` attribute and supply a space-or-comma-delimited list of one or more stylesheet parameter names.

Syntax

The syntax for this action is as follows, where *paramname* is the name of a parameter and where *value* is a value:

```
<xsql:set-stylesheet-param name="paramname" value="value"/>
```

Alternatively, you can use this syntax, where *SQL_statement* is a SQL SELECT statement and *paramname* is the name of a parameter:

```
<xsql:set-stylesheet-param name="paramname">
  SQL_statement
</xsql:set-stylesheet-param>
```

Either the `name` or the `names` attribute is required. The `value` attribute and the contained SQL statement are mutually exclusive.

Attributes

[Table 32-15](#) (page 32-35) lists the optional attributes supported by this action. Attributes in bold are required; all others are optional.

Table 32-15 Attributes for <xsql:set-stylesheet-param>

Attribute Name	Description
name = "string"	Name of the top-level stylesheet parameter whose value you want to set.
names = "string string ..."	Space-or-comma-delimited list of the top-level stylesheet parameter names whose values you want to set. Use the <code>name</code> or the <code>names</code> attribute, but not both.
bind-params = "string"	Ordered, space-delimited list of one or more XSQL parameter names. Parameter values are used to bind to the JDBC bind variable in the appropriate sequential position in the SQL statement.
error-param = "string"	Name of a page-private parameter that must be set to the string 'Error' if a nonfatal error occurs while processing this action. Valid value is any parameter name.
ignore-empty-value = "boolean"	Indicates whether the stylesheet parameter assignment is to be ignored if the value to which it is being assigned is an empty string. Valid values are <code>yes</code> and <code>no</code> (default).

Table 32-15 (Cont.) Attributes for <xsql:set-stylesheet-param>

Attribute Name	Description
value = "string"	Sets the value to assign to the parameter.

Examples

The following example associates a stylesheet and uses the <xsql:set-stylesheet-param> action element to assign the value of the XSQL page parameter named p_table to the XSLT top-level stylesheet parameter named table.

Setting a Stylesheet Parameter

```
<?xml version="1.0"?>
<?xml-stylesheet type="text/xsl" href="style.xsl"?>
<page connname="xmlbook" connection="{@p_connname}">
  <xsql:query null-indicator="yes" xmlns:xsql="urn:oracle-xsql">
    <![CDATA[
      SELECT *
      FROM {@p_table}
      WHERE rownum < 2
    ]>
  </xsql:query>
  <xsql:set-stylesheet-param name="table" value="{@p_table}"
    xmlns:xsql="urn:oracle-xsql" />
</page>
```

32.2.19 <xsql:update-request>

Element <xsql:update-request> is described.

Purpose

Accepts data posted from an XML document or HTML form and uses the [XML SQL Utility \(XSU\)](#) to update the content of an XML document in canonical form from a target table or view.

By combining XSU with XSLT, you can transform XML into the canonical format expected by a given table. Afterward, you can use XSU to update the resulting canonical XML. For a specified database table, the canonical XML form is given by one row of XML output from a `SELECT *` query against the table.

Syntax

The syntax for this action is:

```
<xsql:update-request table="table_name"/>
```

Attributes

[Table 32-3](#) (page 32-9) lists the attributes that you can use on the <xsql:update-request> action. Required attributes are in bold.

Table 32-16 Attributes for <xsql:update-request>

Attribute Name	Description
<code>table = "string"</code>	Name of the table, view, or synonym to use for updating the XML data.
<code>key_columns = "string string ..."</code>	Space-delimited or comma-delimited list of one or more column names. The processor uses the values of these names in the posted XML document to identify the existing rows to update.
<code>transform = "URL"</code>	Relative or absolute URL of the XSLT transformation to use to transform the document to be updated into canonical ROWSET/ROW format.
<code>columns = "string"</code>	Relative or absolute URL of the XSLT transformation to use to transform the document to be updated into canonical ROWSET/ROW format.
<code>commit = "boolean"</code>	If set to <i>yes</i> (default), invokes <code>COMMIT</code> on the current connection after a successful execution of the update. Valid values are <i>yes</i> and <i>no</i> .
<code>commit-batch-size = "integer"</code>	If a positive, nonzero <i>integer</i> is specified, then after each batch of <i>integer</i> updated records, the processor issues a <code>COMMIT</code> . The default batch size is zero (0) if not specified, which means that the processor does not commit interim batches.
<code>date-format = "string"</code>	Date format mask to use for interpreting date field values in XML being updated. Valid values are those for the <code>java.text.SimpleDateFormat</code> class.
<code>error-param = "string"</code>	Name of a page-private parameter that must be set to <code>Error</code> if a nonfatal error occurs while processing this action. Valid value is any parameter name.

Examples

The following example parses and transforms the contents of the posted XML document or HTML Form for update.

Updating XML Received in a Parameter

```
<?xml version="1.0"?>
<xsql:update-request table="purchase_order" key-columns="department_id"
                    connection="demo" transform="doc-to-departments.xsl"
xmlns:xsql="urn:oracle-xsql"/>
```

<xsql:update-request>

Oracle XML Developer's Kit Standards

A description is given of the Oracle XML Developer's Kit (XDK) standards.

Topics:

- [XML Standards Supported by XDK](#) (page 33-1)
- [Character Sets Supported by XDK](#) (page 33-5)

33.1 XML Standards Supported by XDK

Topics here include XML and Java standards supported by XDK.

Topics:

- [Summary of XML Standards Supported by XDK](#) (page 33-1)
- [XML Standards for XDK for Java](#) (page 33-3)

33.1.1 Summary of XML Standards Supported by XDK

The XML standards supported by XDK components are described.

Table 33-1 Summary of XML Standards Supported by Oracle XML Developer's Kit

Standard	Java	C	C++	Specification URL
DOM 1.0	Full	Full	Full	http://www.w3.org/TR/DOM-Level-1
DOM 2.0 Core	Full	Full	Full	http://www.w3.org/TR/DOM-Level-2-Core
DOM 2.0 Events	Full	Full	Full	http://www.w3.org/TR/DOM-Level-2-Events
DOM 2.0 Transversal and Range	Full	Full	Full	http://www.w3.org/TR/DOM-Level-2-Traversal-Range
DOM 3.0 Core	Full	N/A	N/A	http://www.w3.org/TR/DOM-Level-3-Core
DOM 3.0 Load and Save	Partial ¹	None	None	http://www.w3.org/TR/2003/CR-DOM-Level-3-LS-20031107
DOM 3.0 Validation	Full ²	None	None	http://www.w3.org/TR/2003/CR-DOM-Level-3-Val-20030730
JAXP 1.1 (JSR Standard)	Full	N/A	N/A	http://www.oracle.com/technetwork/java/index.html
JAXP 1.2 (JSR Standard)	Full	N/A	N/A	http://www.oracle.com/technetwork/java/index.html

Table 33-1 (Cont.) Summary of XML Standards Supported by Oracle XML Developer's Kit

Standard	Java	C	C++	Specification URL
SAX 1.0	Full	Full	Full	http://www.saxproject.org
SAX 2.0 Core	Full	Full	Full	http://www.saxproject.org
SAX 2.0 Extension	Full	Full	Full	http://www.saxproject.org
XML 1.0 (Second Edition)	Full	Full	Full	http://www.w3.org/TR/REC-xml
XML Base	Only in XSLT	None	None	http://www.w3.org/TR/xmlbase
XML Namespaces 1.0	Full	Full	Full	http://www.w3.org/TR/REC-xml-names
XML Pipeline Definition Language 1.0 (Note)	Partial ³	None	None	http://www.w3.org/TR/xml-pipeline
XML Schema language 1.0	Full	Full ⁴	Full ⁴	http://www.w3.org/TR/xmlschema-0
XML Path Language (XPath) 1.0 (W3C Recommendation)	Full	Full	Full	http://www.w3.org/TR/xpath
XML Path Language (XPath) 2.0 (Second Edition, W3C Recommendation)	Full	None	None	https://www.w3.org/TR/xpath20/
XML Path Language (XPath) 3.0 (W3C Recommendation)	Full	None	None	https://www.w3.org/TR/xpath-30/
XQuery 1.0: An XML Query Language (Second Edition, W3C Recommendation)	Full	None	None	https://www.w3.org/TR/xquery/
XQuery 1.0 and XPath 2.0 Data Model (XDM) (Second Edition, W3C Recommendation)	Full	None	None	http://www.w3.org/TR/xpath-datamodel/
XQuery 1.0 and XPath 2.0 Functions and Operators (Second Edition, W3C Recommendation)	Full	None	None	https://www.w3.org/TR/xpath-functions/
XQuery 3.0: An XML Query Language (W3C Recommendation)	Full	None	None	https://www.w3.org/TR/xquery-30/
XQuery and XPath Data Model 3.0 (W3C Recommendation)	Full	None	None	https://www.w3.org/TR/xpath-datamodel-30/

Table 33-1 (Cont.) Summary of XML Standards Supported by Oracle XML Developer's Kit

Standard	Java	C	C++	Specification URL
XPath and XQuery Functions and Operators 3.0 (W3C Recommendation)	Full	None	None	https://www.w3.org/TR/xpath-functions-30/
XQuery Update Facility 1.0 (W3C Recommendation)	Full	None	None	https://www.w3.org/TR/xquery-update-10/
XQueryX 3.0 (W3C Recommendation)	Full	None	None	https://www.w3.org/TR/xqueryx-30/
JSR-000225 XQuery API for Java (XQJ) (Final Release)	Full	None	None	https://jcp.org/aboutJava/communityprocess/final/jsr225/index.html
XSLT 1.0	Full	Full	Full	http://www.w3.org/TR/xslt
XSLT 2.0 (W3C Recommendation, 23 January 2007)	Conformance as a basic XSLT processor ⁵	None	None	https://www.w3.org/TR/xslt20/#basic-conformance

¹ [DOM Level 3 Load and Save](#) (page 33-4) describes the relationship between DOM 3.0 Core and Load and Save.

² [DOM 3.0 Validation](#) (page 33-4) describes the relationship between DOM 3.0 Core and Validation.

³ [Pipeline Definition Language Standard for XDK for Java](#) (page 33-5) describes the parts of the standard that are not supported.

⁴ The Schema processor fully supports the functionality stated in the specification plus "XML Schema 1.0 Specification Errata" as published on <http://www.w3.org/2001/05/xmlschema-errata>.

⁵ See [XSLT Standard for XDK for Java](#) (page 33-4) for details

33.1.2 XML Standards for XDK for Java

Topics here include XDK standards for DOM, XSLT, JAXB, and Pipeline Definition Language.

Topics:

- [DOM Standard for XDK for Java](#) (page 33-3)
- [XSLT Standard for XDK for Java](#) (page 33-4)
- [JAXB Standard for XDK for Java](#) (page 33-5)
- [Pipeline Definition Language Standard for XDK for Java](#) (page 33-5)

33.1.2.1 DOM Standard for XDK for Java

The DOM APIs include support for candidate recommendations of DOM Level 3 Validation and DOM Level 3 Load and Save.

Note:

In Oracle Database 10g Release 2, XDK for Java implements the candidate recommendation versions of Document Object Model (DOM) Level 3.0 Load and Save and Validation specifications. Oracle plans to produce a release or patch set that will include an implementation of DOM Level 3.0 Load and Save and Validation recommendations. To conform with the recommendations, Oracle might be forced to make changes that are not backward compatible. During this period Oracle does not guarantee backward compatibility with our DOM Load and Save, and Validation implementation. After XDK for Java is updated to conform with the recommendations, standard Oracle policies for backward compatibility will apply to the Oracle DOM Load and Save, and Validation implementation.

33.1.2.1.1 DOM Level 3 Load and Save

The DOM Level 3 Load and Save module enables software developers to load and save Extensible Markup Language (XML) content inside conforming products.

The `charset-overrides-xml-encoding` configuration parameter is not supported by `LSParser`. Optional settings of these configuration parameters are not supported by `LSParser`:

- `disallow-doctype` (true)
- `ignore-unknown-character-denormalizations` (false)
- `namespaces` (false)
- `supported-media-types-only` (true)

The `discard-default-content` configuration parameter is not supported by `LSSerializer`. Optional settings of these configuration parameters are not supported by `LSSerializer`:

- `canonical-form` (true)
- `format-pretty-print` (true)
- `ignore-unknown-character-denormalizations` (false)
- `normalize-characters` (true)

33.1.2.1.2 DOM 3.0 Validation

DOM 3.0 validation lets users retrieve metadata definitions from XML schemas, query the validity of DOM operations, and validate the DOM documents or subtrees against an XML schema. Because validation is based on a schema, you must convert a document type definition (DTD) to a schema before using these functions.

33.1.2.2 XSLT Standard for XDK for Java

The XDK XSLT processor supports the current recommendations of XSLT 2.0, XPath 2.0, and the shared XPath/XQuery data model.

Oracle XML Development Kit (XDK) supports the XSLT 2.0 (W3C Recommendation, 23 January 2007) as a *basic XSLT processor*, with the following limitation: Support for `xsl:key` and `xsl:sort` behavior is at the XSLT 1.0 level.

See Also:

- <https://www.w3.org/TR/xslt20/#basic-conformance> for XSLT 2.0 basic conformance
 - <https://www.w3.org/TR/xslt> for XSLT 1.0
-

33.1.2.3 JAXB Standard for XDK for Java

Features not supported by the XDK implementation of the Java Architecture for XML Binding (JAXB) specification are described.

The XDK implementation of the Java Architecture for XML Binding (JAXB) specification does not support these features:

- Javadoc generation
- XML Schema component any and substitution groups

33.1.2.4 Pipeline Definition Language Standard for XDK for Java

Differences between the XML Pipeline processor and the W3C Note are presented.

The two differ as follows:

- The parser processes `DOMParserProcess` and `SAXParserProcess` are included in the XML pipeline (Section 1).
- Only the final target output is checked to see if it is up-to-date with the available pipeline inputs. The XML Pipeline processor does not determine whether the intermediate outputs of every process are up-to-date (Section 2.2).
- For the `select` attribute, anything in between double quotation marks ("...") is considered to be a string literal.
- The XML Pipeline processor throws an error if more that one process produces the same infoSet (Section 2.4.2.3).
- The `<document>` element is not supported (Section 2.4.2.8).

33.2 Character Sets Supported by XDK

The character sets supported by XDK for Java and XDK for C are described.

Topics:

- [Character Sets Supported by XDK for Java](#) (page 33-5)
- [Character Sets Supported by XDK for C](#) (page 33-6)

33.2.1 Character Sets Supported by XDK for Java

The character-set encodings supported by XDK for Java are described.

XML Schema processor for Java supports documents in these encodings:

- BIG
- EBCDIC-CP-*

- EUC-JP
- EUC-KR
- GB2312
- ISO-2022-JP
- ISO-2022-KR
- ISO-8859-1to -9
- ISO-10646-UCS-2
- ISO-10646-UCS-4
- KOI8-R
- Shift_JIS
- US-ASCII
- UTF-8
- UTF-16

33.2.2 Character Sets Supported by XDK for C

XDK for C supports over 300 Internet Assigned Numbers Authority (IANA) character sets.

These character sets include:

- UTF-8
- UTF-16
- UTF16-BE
- UTF16-LE
- US-ASCII
- ISO-10646-UCS-2
- ISO-8859-{1-9, 13-15}
- EUC-JP
- SHIFT_JIS
- BIG5
- GB2312
- GB_2312-80
- HZ-GB-2312
- KOI8-R
- KSC5601

- EUC-KR
- ISO-2022-CN
- ISO-2022-JP
- ISO-2022-KR
- WINDOWS-{1250-1258}
- EBCDIC-CP-
{US,CA,NL,WT,DK,NO,FI,SE,IT,ES,GB,FR,HE,BE,CH,ROECE,YU,IS,AR}
- IBM{037, 273, 277, 278, 280, 284, 285, 297, 420, 424, 437, 500, 775, 850, 852, 855, 857, 858, 860, 861, 863, 865, 866, 869, 870, 871, 1026, 01140, 01141, 01142, 01143, 01144, 01145, 01146, 01147,01148}

You can use any alias of the preceding character sets. In addition, you can use any character set specified in *Oracle Database Globalization Support Guide*, except for IW7IS960.

XDK for Java XML Error Messages

Error messages are listed for applications that use Oracle XML Developer's Kit (XDK) for Java during the execution of Extensible Markup Language (XML) interfaces.

Topics:

- [XML Parser Error Messages](#) (page A-1)
- [DOM Error Messages](#) (page A-12)
- [XSLT Error Messages](#) (page A-16)
- [XPath Error Messages](#) (page A-20)
- [XML Schema Validation Error Messages](#) (page A-25)
- [Schema Representation Constraint Error Messages](#) (page A-35)
- [Schema Component Constraint Error Messages](#) (page A-41)
- [XSQL Server Pages Error Messages](#) (page A-50)
- [XML Pipeline Error Messages](#) (page A-51)
- [JAXB Error Messages](#) (page A-53)

See Also:

<http://www.w3.org/TR/xquery/#id-errors> for the XQuery error messages

A.1 XML Parser Error Messages

Extensible Markup Language (XML) parser error messages are in the range XML-20000 through XML-20999.

XML-20003: missing token *string* at line *string*, column *string*

Cause: An expected token was not found in the input data.

Action: Check/update the input data to fix the syntax error.

XML-20004: missing keyword *string* at line *string*, column *string*

Cause: An expected keyword was not found in the input data.

Action: Check/update the input data to the correct keyword.

XML-20005: missing keyword *string* or *string* at line *string*, column *string*

Cause: An expected keyword was not found in the input data.

Action: Check/update the input data to the correct keyword.

XML-20006: unexpected text at line *string*, column *string*; expected EOF

Cause: More text was found after the end-tag of the root element.

Action: The end-tag of the root element can be followed only by comments, PI, or white space. Remove the extra text after the end-tag.

XML-20007: missing content model in element declaration at line *string*, column *string*

Cause: The element declaration was missing the required content model spec. See Production [45] in XML 1.0 2nd Edition.

Action: Add the required content spec to the element declaration.

XML-20008: missing element name in content model at line *string*, column *string*

Cause: The content model in the element declaration was invalid, the content particle requires an element name. See Production [48] in XML 1.0 2nd Edition.

Action: Add the element name to fix the content spec syntactically.

XML-20009: target name *string* of processing instruction at line *string*, column *string* is reserved

Cause: The target names "XML: xml", and so on are reserved for standardization in future versions of XML specification. See Production [17] in XML 1.0 2nd Edition.

Action: If the PI is meant to be XML declaration, make sure the declaration occurs at the very beginning of the file. Otherwise, change to name of the PI.

XML-20010: missing notation name in unparsed entity declaration at line *string*, column *string*

Cause: The notation name used in the unparsed entity declaration did not match the name in a declared notation. See Production [76] in XML 1.0 2nd Edition.

Action: Add the notation declaration to the DTD.

XML-20011: missing attribute type in attribute-list declaration at line *string*, column *string*

Cause: The attribute type was missing the attribute-list declaration. One of these types CDATA, ID, IDREF, IDREFS, ENTITY, ENTITIES, NMTOKEN, or NMTOKENS must be added. See Production [52], [53] in XML 1.0 2nd Edition.

Action: Check and correct attribute declaration.

XML-20012: missing white space at line *string*, column *string*

Cause: The required white space was missing.

Action: Add white space to fix the syntax error.

XML-20013: invalid character *string* in entity value at line *string*, column *string*

Cause: An invalid character was used in the entity value. Characters &, %, and either " or ' (based on the value delimiters) are invalid. See Production [9] in XML 1.0 2nd Edition.

Action: Use entity or character references instead of the characters. For example, & or & can be used instead of &.

XML-20014: -- not allowed in comment at line *string*, column *string*

Cause: A syntax error in comment due to the use of "--" See Production [15] in XML 1.0 2nd Edition.

Action: Fix the comment, and use -- only as part of end of comment -->

XML-20015:]> not allowed in text at line *string*, column *string*

Cause:]> is not allowed in text. It is used only as end marker for CDATA Section. See Production [14] in XML 1.0 2nd Edition.

Action: Fix the text content by using > or char ref for >.

XML-20016: white space not allowed before occurrence indicator at line *string*, column *string*

Cause: White space is not allowed in the contentspec before the occurrence indicator. For example, <!ELEMENT x (a,b) *> is not valid. See Production [47], [48] in XML 1.0 2nd Edition.

Action: Fix the contentspec by removing the extra space

XML-20017: occurrence indicator *string* not allowed in mixed-content at line *string*, column *string*

Cause: Occurrence is not allowed in mixed content declaration. For example, <!ELEMENT x (#PCDATA)?> is not valid. See Production [51] in XML 1.0 2nd Edition.

Action: Fix the syntax to remove the occurrence indicator.

XML-20018: content list not allowed inside mixed-content at line *string*, column *string*

Cause: Content list is not allowed in mixed-content declaration. For example, <!ELEMENT x (#PCDATA | (a,b))> is not valid. See Production [51] in XML 1.0 2nd Edition.

Action: Fix the syntax to remove the content list.

XML-20019: duplicate element *string* in mixed-content declaration at line *string*, column *string*

Cause: Duplicate element name was found in mixed-content declaration. For example, <!ELEMENT x (#PCDATA | a | a)> is not valid. See Production [51] in XML 1.0 2nd Edition

Action: Remove the duplicate element name.

XML-20020: root element *string* does not match the DOCTYPE name *string* at line *string*, column *string*

Cause: failed: The name in the document type declaration must match the element type of the root element. For example: `<?xml version="1.0"?> <!DOCTYPE greeting [<!ELEMENT greeting (#PCDATA)>]> <salutation>Hello!</salutation>`. The document's root element, `salutation`, does not match the root element declared in the DTD (`greeting`).

Action: Correct the document.

XML-20021: duplicate element declaration *string* at line *string*, column *string*

Cause: Element was declared twice in the DTD.

Action: Remove the duplicate declaration.

XML-20022: element *string* has multiple ID attributes at line *string*, column *string*

Cause: failed: No element type may have more than one ID attribute specified.

Action: Correct the document, by removing the duplicate ID attribute decl.

XML-20023: ID attribute *string* in element *string* must be #IMPLIED or #REQUIRED at line *string*, column *string*

Cause: failed: An ID attribute must have a declared default of #IMPLIED or #REQUIRED.

Action: Fix the attribute declaration.

XML-20024: missing required attribute *string* in element *string* at line *string*, column *string*

Cause: failed: If the default declaration is the keyword #REQUIRED, then the attribute must be specified for all elements of the type in the attribute-list declaration.

Action: Fix the input document by specifying the required attribute.

XML-20025: duplicate ID value: *string*

Cause: Values of type ID must match the Name production. A name must not appear more than once in an XML document as a value of this type; thus, ID values must uniquely identify the elements which bear them.

Action: Fix the input document by removing the duplicate ID value.

XML-20026: undefined ID value *string* in IDREF

Cause: failed "Values of type IDREF must match value of some ID attribute.

Action: Fix the document by adding an ID corresponding the to the IDREF, or removing the IDREF.

XML-20027: attribute *string* in element *string* has invalid enumeration value *string* at line *string*, column *string*

Cause: failed: Values of this type must match one of the Nmtoken tokens in the declaration.

Action: Fix the attribute value to match one of the enumerated values.

XML-20028: attribute *string* in element *string* has invalid value *string*, must be *string* at line *string*, column {5}

Cause: failed: If an attribute has a default value declared with the #FIXED keyword, instances of that attribute must match the default value.

Action: Update the attribute value to match the fixed default value.

XML-20029: attribute default must be REQUIRED, IMPLIED, or FIXED at line *string*, column *string*

Cause: The declared default value must meet the lexical constraints of the declared attribute type.

Action: Use one of REQUIRED, IMPLIED, or FIXED for attribute default decl.

XML-20030: invalid text in content of element *string* at line *string*, column *string*

Cause: The element does not allow text in content. An element is valid if there is a declaration matching element decl where the Name matches the element type, and one of these holds:

The declaration matches children and the sequence of child elements belongs to the language generated by the regular expression in the content model, with optional white space (characters matching the nonterminal S) between the start-tag and the first child element, between child elements, or between the last child element and the end-tag. A CDATA section containing only white space does not match the nonterminal S, and hence cannot appear in these positions.

Action: Fix the content by removing unexpected text.

XML-20031: invalid element *string* in content of element *string* at line *string*, column *string*

Cause: The element has invalid content. An element is valid if there is a declaration matching element decl where the Name matches the element type, and one of these holds:

1. The declaration matches children and the sequence of child elements belongs to the language generated by the regular expression in the content model, with optional white space (characters matching the nonterminal S) between the start-tag and the first child element, between child elements, or between the last child element and the end-tag. A CDATA section containing only white space does not match the nonterminal S, and hence cannot appear in these positions.
2. The declaration matches Mixed and the content consists of character data and child elements whose types match names in the content model.

Action: Fix the content by removing unexpected elements.

XML-20032: incomplete content in element *string* at line *string*, column *string*

Cause: The element has invalid content. An element is valid if there is a declaration matching element decl where the Name matches the element type, and one of these holds:

1. The declaration matches children and the sequence of child elements belongs to the language generated by the regular expression in the content model, with optional white space (characters matching the nonterminal S) between the start-tag and the first child element, between child elements, or between the last child

element and the end-tag. A CDATA section containing only white space does not match the nonterminal S, and hence cannot appear in these positions.

2. The declaration matches Mixed and the content consists of character data and child elements whose types match names in the content model.

Action: Fix the content by removing unexpected elements.

XML-20033: invalid replacement-text for entity *string* at line *string*, column *string*

Cause: Parameter-entity replacement text must be properly nested with markup declarations. That is to say, if either the first character or the last character of a markup declaration (markup decl above) is contained in the replacement text for a parameter-entity reference, both must be contained in the same replacement text.

Action: Fix the entity value.

XML-20034: end-element tag *string* does not match start-element tag *string* at line *string*, column *string*

Cause: The Name in an element's end-tag must match the element type in the start-tag.

Action: Fix the end-tag or start-tag to match the other.

XML-20035: duplicate attribute *string* in element *string* at line *string*, column *string*

Cause: No attribute name may appear more than once in the same start-tag or empty-element tag.

Action: Remove the duplicate attribute.

XML-20036: invalid character *string* in attribute value at line *string*, column *string*

Cause: An invalid character was used in the attribute value, the characters &, <, and either " or ' (based on the value delimiters) are invalid. See Production [10] in XML 1.0 2nd Edition.

Action: Use entity or character references instead of the characters. For example, & or & can be used instead of &.

XML-20037: invalid reference to external entity *string* in attribute *string* at line *string*, column *string*

Cause: Attribute values cannot contain direct or indirect entity references to external entities.

Action: Fix document to remove reference to external entity in attribute.

XML-20038: invalid reference to unparsed entity *string* in element *string* at line *string*, column *string*

Cause: An entity reference must not contain the name of an unparsed entity. Unparsed entities may be referenced only in attribute values declared to be of type ENTITY or ENTITIES.

Action: Fix document to remove reference to unparsed entity in content.

XML-20039: invalid attribute type *string* in attribute-list declaration at line *string*, column *string*

Cause: Invalid attribute type was used in the attribute-list declaration. One of these types CDATA, ID, IDREF, IDREFS, ENTITY, ENTITIES, NMTOKEN, or NMTOKENS must be added. See Production [52], [53] in XML 1.0 2nd Edition.

Action: Check and correct attribute declaration.

XML-20040: invalid character *string* in element content at line *string*, column *string*

Cause: Characters referred to using character references must match the production for Char.

Action: Fix the document by removing the invalid character or char-ref.

XML-20041: entity reference *string* refers to itself at line *string*, column *string*

Cause: A parsed entity must not contain a recursive reference to itself, either directly or indirectly.

Action: Fix the document.

XML-20042: invalid Nmtoken: *string*

Cause: Values of this type must match one of the Nmtoken tokens in the declaration, and must be valid Nmtoken"

Action: Fix the attribute value.

XML-20043: invalid character *string* in public identifier at line *string*, column *string*

Cause: Invalid character used in public identifier. See Production [12], [13] in XML 1.0 2nd Edition.

Action: Fix the public identifier.

XML-20044: undeclared namespace prefix *string* used at line *string*, column *string*

Cause: The prefix was not defined in any namespace declaration in scope.

Action: Add a namespace declaration to define the prefix.

XML-20045: attribute *string* in element *string* must be an unparsed entity at line *string*, column *string*

Cause: Values of type ENTITY must match the Name production, values of type ENTITIES must match Names; each Name must match the name of an unparsed entity declared in the DTD.

Action: Fix the attribute value to refer to an unparsed entity.

XML-20046: undeclared notation *string* used in unparsed entity *string* at line *string*, column *string*

Cause: Values of this type must match one of the notation names included in the declaration; all notation names in the declaration must be declared.

Action: Fix the notation name in the unparsed entity declaration.

XML-20047: missing element declaration *string*

Cause: The element declaration referred to by an attribute declaration was not found in the DTD.

Action: Fix the DTD by adding the element declaration.

XML-20048: duplicate entity declaration *string* at line *string*, column *string*

Cause: Warning regarding duplicate entity declaration.

Action: No action required.

XML-20049: invalid use of NDATA in parameter entity declaration at line *string*, column *string*

Cause: NDATA declaration was found in parameter entity declaration. It is allowed only in general unparsed entity declaration. See Production [72], [74] in XML 1.0 2nd Edition.

Action: Fix the entity declaration.

XML-20050: duplicate attribute declaration *string* at line *string*, column *string*

Cause: Warning regarding duplicate attribute declaration.

Action: No action required.

XML-20051: duplicate notation declaration *string* at line *string*, column *string*

Cause: Only one notation declaration can declare a given Name.

Action: Fix the document by removing the duplicate notation.

XML-20052: undeclared attribute *string* used at line *string*, column *string*

Cause: The attribute declaration was not found in the DTD.

Action: Fix the DTD by adding the attribute declaration.

XML-20053: undeclared element *string* used at line *string*, column *string*

Cause: The element declaration was not found in the DTD.

Action: Fix the DTD by adding the element declaration.

XML-20054: undeclared entity *string* used at line *string*, column *string*

Cause: The entity declaration was not found in the DTD.

Action: Fix the DTD by adding the element declaration.

XML-20055: invalid document returned by NodeFactory's createDocument

Cause: The document returned by `createDocument` function of `NodeFactory` was invalid, either it was null or instance of an unsupported class.

Action: Fix `NodeFactory` implementation to return an instance of `XMLDocument` or its subclass.

XML-20056: invalid SAX feature *string*

Cause: The SAX feature supplied was not a valid feature name.

Action: See the documentation for a valid list of features.

XML-20057: invalid value *string* passed for SAX feature *string*

Cause: The value supplied for the SAX feature was not valid.

Action: See the documentation for a valid list of features and their corresponding values.

XML-20058: invalid SAX property *string*

Cause: The SAX property supplied was not a valid property name.

Action: See the documentation for a valid list of properties.

XML-20059: invalid value passed for SAX property *string*

Cause: The value supplied for the SAX property was not valid.

Action: See the documentation for a valid list of properties and their corresponding values

XML-20060: Error occurred while opening URL *string*

Cause: An error occurred while opening the supplied URL.

Action: Verify the URL, and take appropriate action to allow data to be read.

XML-20061: invalid byte stream *string* in UTF8 encoded data

Cause: The input data contained bytes that are not valid with respect to UTF-8 encoding scheme.

Action: Fix the input data.

XML-20062: 5-byte UTF8 encoding not supported

Cause: The XML Parser does not support 5-byte UTF-8 encoding scheme. It is also possible that invalid UTF-8 characters were misinterpreted as 5-byte UTF-8 encoding.

Action: If the data contains invalid UTF-8 bytes, fix the input, otherwise if 5-byte UTF-8 supported is required, contact Oracle Support.

XML-20063: 6-byte UTF8 encoding not supported

Cause: The XML Parser does not support 6-byte UTF-8 encoding scheme. It is also possible that invalid UTF-8 characters were misinterpreted as 6-byte UTF-8 encoding.

Action: If the data contains invalid UTF-8 bytes, fix the input, otherwise if 6-byte UTF-8 supported is required, contact Oracle Support.

XML-20064: invalid XML character *string*

Cause: Invalid XML character was found in the input data.

Action: Fix the input data.

XML-20065: encoding *string* doesn't match encoding *string* in XML declaration

Cause: The encoding of the data (either by auto-detection or user supplied) didn't match the encoding specified in the XML declaration.

Action: Fix the XML declaration to match the encoding of the data.

XML-20066: encoding *string* not supported

Cause: The XML Parser does not support the specified encoding.

Action: If the support for the encoding is required, contact Oracle Support.

XML-20067: invalid `InputSource` returned by `EntityResolver`'s `resolveEntity`

Cause: An invalid instance of `InputSource` was returned by the `EntityResolver`. An `InputSource` can be invalid if the none of `Reader`, `InputStream`, and `SystemId` were initialized or if the `SystemId` was invalid.

Action: Fix the `EntityResolver` class to return a valid instance of `InputSource`.

XML-20100: Expected *string*.

XML-20101: Expected *string* or *string*.

XML-20102: Expected *string*, *string*, or *string*.

XML-20103: Illegal token in content model.

XML-20104: Could not find element with ID *string*.

XML-20105: ENTITY type Attribute value *string* does not match any unparsed Entity.

XML-20106: Could not find Notation *string*.

XML-20107: Could not find declaration for element *string*.

XML-20108: Start of root element expected.

XML-20109: PI with the name 'xml' can occur only in the beginning of the document.

XML-20110: #PCDATA expected in mixed-content declaration.

XML-20111: Element *string* repeated in mixed-content declaration.

XML-20112: Error opening external DTD *string*.

XML-20113: Unable to open input source (*string*).

XML-20114: Bad conditional section start syntax, expected '['.

XML-20115: Expected ']>' to end conditional section.

XML-20116: Entity *string* already defined, using the first definition.

XML-20117: NDATA not allowed in parameter entity declaration.

XML-20118: NDATA value required.

XML-20119: Entity Value should start with quote.

XML-20120: Entity value not well-formed.

XML-20121: End tag does not match start tag *string*.

XML-20122: '=' missing in attribute.

XML-20123: '>' Missing from end tag.

XML-20124: An attribute cannot appear more than once in the same start tag.

XML-20125: Attribute value should start with quote.

values.

XML-20142: Unknown attribute type.

XML-20143: Unrecognized text at end of attribute value.

XML-20144: FIXED type Attribute value not equal to the default value *string*.

XML-20145: Unexpected text in content of Element *string*.

XML-20146: Unexpected text in content of Element *string*, expected elements *string*.

XML-20147: Invalid element *string* in content of *string*, expected closing tag.

XML-20148: Invalid element *string* in content of *string*, expected elements *string*.

XML-20149: Element *string* used but not declared.

XML-20150: Element *string* not complete, expected elements *string*.

XML-20151: Entity *string* used but not declared.

XML-20170: Invalid UTF8 encoding.

XML-20171: Invalid XML character(*string*).

XML-20172: 5-byte UTF8 encoding not supported.

XML-20173: 6-byte UTF8 encoding not supported.

XML-20180: User Supplied NodeFactory returned a Null Pointer.

XML-20190: Whitespace required.

XML-20191: '>' required to end DTD.

XML-20192: Unexpected text in DTD.

XML-20193: Unexpected EOF.

XML-20194: Unable to write to output stream.

XML-20195: Encoding not supported in PrintWriter.

XML-20200: Expected *string* instead of *string*.

XML-20201: Expected *string* instead of *string*.

XML-20202: Expected *string* to be *string*.

XML-20205: Expected *string*.

XML-20206: Expected *string* or *string*.

Document Object Model (DOM) error messages are in the range XML-21000 through XML-21999.

XML-21000: invalid size *string* specified

Cause: An invalid size or count was passed to a DOM function.

Action: Correct the argument passed to a valid value.

XML-21001: invalid index *string* specified; must be between 0 and *string*

Cause: An invalid index was passed to a DOM function.

Action: Correct the argument passed to a valid value specified by the bounds in the error message

XML-21002: cannot add an ancestor as a child node

Cause: The DOM operation was trying to add an ancestor node as a child. This can lead to inconsistencies in the tree, so it is not allowed.

Action: Check the application to fix the usage.

XML-21003: node of type *string* cannot be added to node of type *string*

Cause: The DOM specification does not allow the parent-child combination used in the DOM operation.

Action: See the DOM specification to fix the usage.

XML-21004: document node can have only one *string* node as child

Cause: The XML well-formedness requires that the document node have only one element node as its child. The application tried adding a second element node.

Action: Fix usage in the application.

XML-21005: node of type *string* cannot be added to attribute list

Cause: The attribute list (instance of NamedNodeMap) can contain only attribute nodes.

Action: Fix usage of NamedNodeMap.

XML-21006: cannot add a node belonging to a different document

Cause: The node being added was created by a different document. The DOM specification does not allow use of nodes across documents.

Action: Use `importNode` or `adoptNode` to move a node from one document to another, before adding it.

XML-21007: invalid character *string* in name

Cause: The qualified or local name passed was invalid.

Action: Fix the name to contain only valid

XML-21008: cannot set value for node of type *string*

Cause: The node of the specified type cannot have value.

Action: Fix usage of DOM functions.

XML-21009: cannot modify descendants of entity or entity reference nodes

Cause: The descendants of entity or entity reference nodes are read-only nodes, and modification is not allowed.

Action: Fix usage of DOM functions.

XML-21010: cannot modify DTD's content

Cause: DTD and all its content is read-only and cannot be modified.

Action: Fix usage of DOM functions.

XML-21011: cannot remove attribute; not found in the current element

Cause: An attempt was made to remove an attribute that does not belong to the current element.

Action: Fix usage in application.

XML-21012: cannot remove or replace node; it is not a child of the current node

Cause: An attempt was made to remove a node that does not belong to the current node as a child.

Action: Fix usage in application.

XML-21013: parameter *string* not recognized

Cause: The DOM parameter was not recognized.

Action: See the documentation for a valid list of parameters.

XML-21014: value *string* of parameter *string* is not supported

Cause: The DOM parameter was not recognized.

Action: See the documentation for a valid list of parameters.

XML-21015: cannot add attribute belonging to another element

Cause: An attempt was made to add an attribute that belonged to another element.

Action: Fix usage in application.

XML-21016: invalid namespace *string* for prefix *string*

Cause: The namespace for xml, and xmlns prefixes is fixed, and usage must match these.

Action: Correct the namespace for the prefixes, namespaces are xml = <http://www.w3.org/XML/1998/namespace> xmlns = <http://www.w3.org/2000/xmlns/>

XML-21017: invalid qualified name: *string*

Cause: The qualified name passed to a DOM function was invalid.

Action: Fix the qualified name.

XML-21018: conflicting namespace declarations *string* and *string* for prefix *string*

Cause: The DOM tree has conflicting namespace declarations for the same prefix. Such a DOM tree cannot be serialized.

Action: Fix the DOM tree, before printing it.

XML-21019: *string* object is detached

Cause: The object was detached, no operations are supported on a detached object. The object can be a Range or iterator object

Action: Fix the usage in application.

XML-21020: bad boundary specified; cannot partially select a node of type *string*

Cause: The boundary specified in the range was invalid. The selection can be partial only for text nodes.

Action: Fix the usage in the application.

XML-21021: node of type *string* does not support range operation *string*

Cause: The range operation is not supported on the node type specified.

Action: See the DOM documentation for restrictions of node types for each range operation.

XML-21022: invalid event type: *string*

Cause: The event type passed was invalid.

Action: Fix usage in the application.

XML-21023: prefix not allowed on nodes of type *string*

Cause: The application tried to set prefix on a node on which prefix is not allowed

Action: Fix usage in the application.

XML-21024: import not allowed on nodes of type *string*

Cause: The application tried to import a node of type DOCUMENT or DOCUMENT FRAGMENT.

Action: Fix usage in the application.

XML-21025: rename not allowed on nodes of type *string*

Cause: The application tried to import a node of type other than ELEMENT or ATTRIBUTE.

Action: Fix usage in the application.

XML-21026: Unrepresentable character in node: *string*

Cause: A node contains an invalid character, eg. CDATA section contain a termination character.

Action: Set appropriate DOMConfiguration parameter.

XML-21027: Namespace normalization error in node: *string*

Cause: Namespace fixup cannot be performed on this node.

Action: Set namespace normalization to false.

XML-21997: function not supported on THICK DOM

Cause: A function on THICK (for example, XDB based) DOM which is not supported was called.

Action: See the XDK documentation for possible alternatives for functions not supported on THICK DOM.

XML-21998: system error occurred: *string*

Cause: Non-DOM related system errors occurred.

Action: Check with ORA error(s) embedded in the message and consult with developers for possible causes.

A.3 XSLT Error Messages

Extensible Stylesheet Language Transformation (XSLT) error messages are in the range XML-22000 through XML-22999.

- XML-22000: Error while parsing XSL file (*string*).
- XML-22001: XSL Stylesheet does not belong to XSLT namespace.
- XML-22002: Error while processing include XSL file (*string*).
- XML-22003: Unable to write to output stream (*string*).
- XML-22004: Error while parsing input XML document (*string*).
- XML-22005: Error while reading input XML stream (*string*).
- XML-22006: Error while reading input XML URL (*string*).
- XML-22007: Error while reading input XML reader (*string*).
- XML-22008: Namespace prefix *string* used but not declared.
- XML-22009: Attribute *string* not found in *string*.
- XML-22010: Element *string* not found in *string*.
- XML-22011: Cannot construct XML PI with content: *string*.
- XML-22012: Cannot construct XML comment with content: *string*.
- XML-22013: Error in expression: *string*.
- XML-22014: Expecting node-set before relative location path.
- XML-22015: Function *string* not found.
- XML-22016: Extension function namespace should start with *string*.
- XML-22017: Literal expected in *string* function. Found *string*.
- XML-22018: Parse Error in *string* function.
- XML-22019: Expected *string* instead of *string*.
- XML-22020: Error in extension function arguments.
- XML-22021: Error parsing external document: *string*.
- XML-22022: Error while testing predicates. Not a nodeset type.
- XML-22023: Literal Mismatch.
- XML-22024: Unknown multiply operator.
- XML-22025: Expression error: Empty string.
- XML-22026: Unknown expression at EOF: *string*.

of an *string* element.

XML-22049: Template *string* invoked but not defined.

XML-22050: Duplicate variable *string* definition.

XML-22051: only a literal or a reference to a variable or parameter is allowed in `id()` function when used as a pattern

XML-22052: no sort key named as: *string* was defined

XML-22053: cannot detect encoding in `unparsed-text()`, please specify

XML-22054: no such `xsl:function` with namespace: *string* and local name: *string* was defined

XML-22055: range expression can only accept `xs:integer` data type, but not *string*

XML-22056: exactly one of four group attributes must be present in `xsl:for-each-group`

XML-22057: *string* can only have *string* as children

XML-22058: wrong child of `xsl:function`

XML-22059: wrong child order of `xsl:function`

XML-22060: TERMINATE PROCESSING

XML-22061: terminate attribute in `<xsl:message>` can only be yes or no

XML-22062: *string* must have at least one *string* child

XML-22063: no definition for character-map with qname *string*

XML-22064: cannot define character-map with the same name *string* and the same import precedence

Cause: A required child was not found.

Action: After error `mesgfreeze` is over, throws an error (without the required child element, it can do nothing).

XML-22065: at least one *string* must be defined under *string*

Cause: A required child is missing.

Action: Without the required child, it can do nothing.

XML-22066: if select attribute is present, *string* instructions sequence-constructor must be empty

Cause: Attribute and sequence constructor `select` must be mutually exclusive for this instruction.

Action: None.

XML-22067: if use attribute is present, *string* instructions sequence-constructor must be empty

Cause: Attribute and sequence constructor `use` must be mutually exclusive for this instruction.

Action: None.

XML-22068: only primary sort key is allowed to have the stable attribute.

Cause: The secondary sort key has a stable attribute.

Action: None.

XML-22069: only *string* or *string* is allowed.

Cause: User typo.

Action: None.

XML-22101: DOMSource node as this type not supported.

XML-22103: DOMResult can not be this kind of node.

XML-22106: Invalid StreamSource - InputStream, Reader, and SystemId are null.

XML-22107: Invalid SAXSource - InputSource is null.

XML-22108: Invalid Source - URL format is incorrect.

XML-22109: Internal error while reporting SAX events.

XML-22110: Invalid StreamResult set in TransformerHandler.

XML-22111: Invalid Result set in TransformerHandler.

XML-22112: Namespace URI missing }.

XML-22113: Namespace URI should start with {.

XML-22117: URL format has problems (null or bad format or missing 'href' or missing '=').

XML-22121: Could not get associated stylesheet.

XML-22122: Invalid StreamResult - OutputStream, Writer, and SystemId are null.

XML-22900: An internal error condition occurred.

A.4 XPath Error Messages

XPath error messages are in the range XML-23000 through XML-23999.

XML-23002: internal xpath error

Cause: This was an error returned by the XPath/XQuery datamodel or XPath F&O.

Action: Check the XPath expression.

XML-23003: XPath 2.0 feature schema-element/schema-attribute not supported

Cause: This error was caused by using the kindtest schema-element or schema-attribute. These are not supported for this release.

Action: Remove usage of schema-element or schema-attribute kindtest

XML-23006: value does not match required type

Cause: During the evaluation phase, there was a type error as the value did not match a required type specified by the matching rules in XPath 2.0 `SequenceType` matching.

Action: Modify the stylesheet to reflect the correct type.

XML-23007: FOAR0001: division by zero

Cause: This was an XPath 2.0 F&O specification error.

Action: Check the XPath expression.

XML-23008: FOAR0002: numeric operation overflow/unflow

Cause: This was an XPath 2.0 F&O specification error.

Action: Check the XPath expression.

XML-23009: FOCA0001: Error in casting to decimal

Cause: This was an XPath 2.0 F&O specification error.

Action: Check the XPath expression.

XML-23010: FOCA0002: invalid lexical value

Cause: This was an XPath 2.0 F&O specification error.

Action: Check the XPath expression.

XML-23011: FOCA0003: input value too large for integer

Cause: This was an XPath 2.0 F&O specification error.

Action: Check the XPath expression.

XML-23012: FOCA0004: Error in casting to integer

Cause: This was an XPath 2.0 F&O specification error.

Action: Check the XPath expression.

XML-23013: FOCA0005: NaN supplied as float/double value

Cause: This was an XPath 2.0 F&O specification error.

Action: Check the XPath expression.

XML-23014: FOCH0001: invalid codepoint

Cause: This was an XPath 2.0 F&O specification error.

Action: Check the XPath expression.

XML-23015: FOCH0002: unsupported collation

Cause: This was an XPath 2.0 F&O specification error.

Action: Check the XPath expression.

XML-23016: FOCH0003: unsupported normalization form

Cause: This was an XPath 2.0 F&O specification error.

Action: Check the XPath expression.

XML-23017: FOCH0004: collation does not support collation units

Cause: This was an XPath 2.0 F&O specification error.

Action: Check the XPath expression.

XML-23018: FODC0001: no context document

Cause: This was an XPath 2.0 F&O specification error.

Action: Check the XPath expression.

XML-23019: FODC0002: Error retrieving resource

Cause: This was an XPath 2.0 F&O specification error.

Action: Check the XPath expression.

XML-23020: FODC0003: Error parsing contents of resource

Cause: This was an XPath 2.0 F&O specification error.

Action: Check the XPath expression.

XML-23021: FODC0004: invalid argument to fn:collection()

Cause: This was an XPath 2.0 F&O specification error.

Action: Check the XPath expression.

XML-23022: FODT0001: overflow in date/time arithmetic

Cause: This was an XPath 2.0 F&O specification error.

Action: Check the XPath expression.

XML-23023: FODT0002: overflow in duration arithmetic

Cause: This was an XPath 2.0 F&O specification error.

Action: Check the XPath expression.

XML-23024: FONC0001: undefined context item

Cause: This was an XPath 2.0 F&O specification error.

Action: Check the XPath expression.

XML-23025: FONS0002: default namespace is defined

Cause: This was an XPath 2.0 F&O specification error.

Action: Check the XPath expression.

XML-23026: FONS0003: no prefix defined for namespace

Cause: This was an XPath 2.0 F&O specification error.

Action: Check the XPath expression.

XML-23027: FONS0004: no namespace found for prefix

Cause: This was an XPath 2.0 F&O specification error.

Action: Check the XPath expression.

XML-23028: FONS0005: base URI not defined in the static context

Cause: This was an XPath 2.0 F&O specification error.

Action: Check the XPath expression.

XML-23029: FORG0001: invalid value for cast/constructor

Cause: This was an XPath 2.0 F&O specification error.

Action: Check the XPath expression.

XML-23030: FORG0002: invalid argument to fn:resolve-uri()

Cause: This was an XPath 2.0 F&O specification error.

Action: Check the XPath expression.

XML-23031: FORG0003: zero-or-one called with sequence containing more than one item

Cause: This was an XPath 2.0 F&O specification error.

Action: Check the XPath expression.

XML-23032: FORG0004: fn:one-or-more called with sequence containing no items

Cause: This was an XPath 2.0 F&O specification error.

Action: Check the XPath expression.

XML-23033: FORG0005: exactly-one called with sequence containing zero or more than one item

Cause: This was an XPath 2.0 F&O specification error.

Action: Check the XPath expression.

XML-23034: FORG0006: invalid argument type

Cause: This was an XPath 2.0 F&O specification error.

Action: Check the XPath expression.

XML-23035: FORG0007: invalid argument to aggregate function

Cause: This was an XPath 2.0 F&O specification error.

Action: Check the XPath expression.

XML-23036: FORG0008: both arguments to fn:dateTime have a specified timezone

Cause: This was an XPath 2.0 F&O specification error.

Action: Check the XPath expression.

XML-23037: FORG0009: base uri argument to fn:resolve-uri is not an absolute URI

Cause: This was an XPath 2.0 F&O specification error.

Action: Check the XPath expression.

XML-23038: FORX0001: invalid regular expression flags

Cause: This was an XPath 2.0 F&O specification error.

Action: Check the XPath expression.

XML-23039: FORX0002: invalid regular expression

Cause: This was an XPath 2.0 F&O specification error.

Action: Check the XPath expression.

XML-23040: FORX0003: regular expression matches zero-length string

Cause: This was an XPath 2.0 F&O specification error.

Action: Check the XPath expression.

XML-23041: FORX0004: invalid replacement string

Cause: This was an XPath 2.0 F&O specification error.

Action: Check the XPath expression.

XML-23042: FOTY0001: type error

Cause: This was an XPath 2.0 F&O specification error.

Action: Check the XPath expression.

XML-23043: FOTY0011: context item is not a node

Cause: This was an XPath 2.0 F&O specification error.

Action: Check the XPath expression.

XML-23044: FOTY0012: items not comparable

Cause: This was an XPath 2.0 F&O specification error.

Action: Check the XPath expression.

XML-23045: FOTY0013: type does not have equality defined

Cause: This was an XPath 2.0 F&O specification error.

Action: Check the XPath expression.

XML-23046: FOTY0014: type exception

Cause: This was an XPath 2.0 F&O specification error.

Action: Check the XPath expression.

XML-23047: FORT0001: invalid number of parameters

Cause: This was an XPath 2.0 F&O specification error.

Action: Check the XPath expression.

XML-23048: FOTY0002: type definition not found

Cause: This was an XPath 2.0 F&O specification error.

Action: Check the XPath expression.

XML-23049: FOTY0021: invalid node type

Cause: This was an XPath 2.0 F&O specification error.

Action: Check the XPath expression.

XML-23050: FOER0000: unidentified error

Cause: This was an XPath 2.0 F&O specification error.

Action: Check the XPath expression.

XML-23051: FODC0005: invalid argument to fn:doc

Cause: This was an XPath 2.0 F&O specification error.

Action: Check the XPath expression.

XML-23052: FODT0003: invalid timezone value

Cause: This was an XPath 2.0 F&O specification error.

Action: Check the XPath expression.

A.5 XML Schema Validation Error Messages

XML schema validation error messages are in the range XML-24000 through XML-24099.

XML-24000: internal error

Cause: An unexpected error occurred during processing.

Action: Report the error.

XML-24001: attribute *string* not expected at line *string*, column *string*

Cause: [cvc-assess-attr.1] The attribute were not expected for owner element.

Action: Add the attribute declaration to the type of the owner element.

XML-24002: can not find element declaration *string*.

Cause: [cvc-assess-elt.1.1.1.1]The element declaration required by processor for validation was absent.

Action: Add the element declaration to schema, or change the instance document to comply to schema.

XML-24003: context-determined element declaration *string* absent.

Cause: [cvc-assess-elt.1.1.1.2] The element declaration required by context was missing in schema.

Action: Add the element declaration to schema.

XML-24004: declaration for element *string* absent.

Cause: [cvc-assess-elt.1.1.1.3] The context-determined declaration was not skip and the declaration that matches the element could not be found in schema.

Action: Add the element declaration to schema or change the context-determined declaration to skip.

XML-24005: element *string* not assessed

Cause: [cvc-assess-elt.2]

XML-24006: element *string* laxly assessed

Cause: [cvc-assess-elt.2]

XML-24007: missing attribute declaration *string* in element *string*

Cause: [cvc-attribute.1] Attribute declaration was absent from element declaration.

Action: Add the attribute declaration to schema.

XML-24008: type absent for attribute *string*

Cause: [cvc-attribute.2] Missing type definition for the attribute declaration.

Action: Specify a data type for the attribute declaration.

XML-24009: invalid attribute value *string*

Cause: [cvc-attribute.3] Invalid attribute value with respect to its type.

Action: Correct the attribute value in instance.

XML-24010: attribute value *string* and fixed value *string* not match

Cause: [cvc-au] Attribute's normalized value was not the same as the fixed value declared.

Action: Change attribute value to the required value.

XML-24011: type of element *string* is abstract.

Cause: [cvc-complex-type.1] The type of this element was specified as abstract.

Action: Remove the abstract attribute from the type definition.

XML-24012: no children allowed for element *string* with empty content type

Cause: [cvc-complex-type.2.1] The content type was specified empty while the actual content was not.

Action: Make the content empty or modify the content type of this element.

XML-24013: element child *string* not allowed for simple content

Cause: [cvc-complex-type.2.2] Element was declared with simple content, but instance had element children.

Action: Use only character content for this element.

XML-24014: characters *string* not allowed for element-only content

Cause: [cvc-complex-type.2.3] Characters appeared in the content of element with element-only content.

Action: Use only element children for this element.

XML-24015: multiple ID attributes in element *string* at line *string*, column *string*

Cause: [cvc-complex-type.2.5] More than one attributes with type ID or its derivation matched attribute wildcard.

Action: Do not use more than one attributes with ID or ID derived type.

XML-24016: invalid string value *string* at line *string*, column *string*

Cause: [cvc-datatype-valid.1.2.2] Characters were not valid with respect to string type.

Action: Correct the value to satisfy the declared type.

XML-24017: invalid boolean value *string* at line *string*, column *string*

Cause: [cvc-datatype-valid.1.2.2] Characters were not valid with respect to boolean type.

Action: Correct the value to satisfy Boolean type, valid values are "0", "1", "true", and "false".

XML-24018: invalid decimal value *string* at line *string*, column *string*

Cause: [cvc-datatype-valid.1.2.2] Characters could not be parsed into a decimal value.

Action: Correct the data value to satisfy decimal type.

XML-24019: invalid float value *string* at line *string*, column *string*

Cause: [cvc-datatype-valid.1.2.2] Characters could not be parsed into a float value.

Action: Correct the value to satisfy string type

XML-24020: invalid double value *string* at line *string*, column *string*

Cause: [cvc-datatype-valid.1.2.2] Characters were not in valid double format as specified in IEEE 754-1985.

Action: Correct the value to satisfy double format.

XML-24021: invalid duration *string* at line *string*, column *string*

Cause: [cvc-datatype-valid.1.2.2] Characters were not in correct extended date time format defined in ISO 8601.

Action: Correct the value to satisfy format PnYnMnDTnHnMnS.

XML-24022: invalid date value *string* at line *string*, column *string*

Cause: [cvc-datatype-valid.1.2.2] Characters were not in valid calendar date format specified in ISO 8601.

Action: Correct the value to satisfy CCYY-MM-DD format.

XML-24023: invalid dateTime value *string* at line *string*, column *string*

Cause: [cvc-datatype-valid.1.2.2] Characters were not in valid combined data time format as specified in ISO 8601.

Action: Correct the value to satisfy format `CCYY-MM-DDThh:mm:ss` with optional time zone.

XML-24024: invalid time value *string* at line *string*, column *string*

Cause: [cvc-datatype-valid.1.2.2] Characters were not in valid time format as specified in ISO 8601.

Action: Correct the value to satisfy format `DDThh:mm:ss` with optional time zone.

XML-24025: invalid gYearMonth value *string* at line *string*, column *string*

Cause: [cvc-datatype-valid.1.2.2] Characters were not in valid right-truncated date format, as specified in ISO 8601.

Action: Correct the value to satisfy format `CCYY-MM`.

XML-24026: invalid gYear value *string* at line *string*, column *string*

Cause: [cvc-datatype-valid.1.2.2] Characters were not in valid right-truncated date format, as specified in ISO 8601.

Action: Correct the value to satisfy format `CCYY`.

XML-24027: invalid gMonthDay value *string* at line *string*, column *string*

Cause: [cvc-datatype-valid.1.2.2] Characters were not in valid left-truncated date format, as specified in ISO 8601.

Action: Correct the value to required format `--MM-DD`.

XML-24028: invalid gDay value *string* at line *string*, column *string*

Cause: [cvc-datatype-valid.1.2.2] Characters were not in valid left-truncated date format, as specified in ISO 8601.

Action: Correct the value to required format `---DD`.

XML-24029: invalid gMonth value *string* at line *string*, column *string*

Cause: [cvc-datatype-valid.1.2.2] Characters were not in valid left-and-right-truncated date format, as specified in ISO 8601.

Action: Correct the value to required format `--MM--`.

XML-24030: invalid hexBinary value *string* at line *string*, column *string*

Cause: [cvc-datatype-valid.1.2.2] Characters were not valid hex encoded binary.

Action: Correct the value to satisfy `hexBinary` type.

XML-24031: invalid base64Binary value *string* at line *string*, column *string*

Cause: [cvc-datatype-valid.1.2.2] Characters were not valid with respect to base64 encoding.

Action: Correct the value to satisfy base64 binary encoding.

XML-24032: invalid anyURI value *string* at line *string*, column *string*

Cause: [cvc-datatype-valid.1.2.2] Characters were not in valid format as specified in RFC 2396 and RFC 2732.

Action: Correct the value to satisfy anyURI type.

XML-24033: invalid QName value *string* at line *string*, column *string*

Cause: [cvc-datatype-valid.1.2.2] Characters were not in valid QName format.

Action: Correct the value to satisfy QName type.

XML-24034: invalid NOTATION value *string* at line *string*, column *string*

Cause: [cvc-datatype-valid.1.2.2] Characters were not valid value for NOTATION type.

Action: Correct the value to satisfy NOTATION type.

XML-24035: invalid normalizedString value *string* at line *string*, column *string*

Cause: [cvc-datatype-valid.1.2.2] Characters were not valid normalizedString value.

Action: Correct the value to satisfy normalizedString type.

XML-24036: invalid token value *string* at line *string*, column *string*

Cause: [cvc-datatype-valid.1.2.2] Characters were not valid value for token type.

Action: Correct the value to satisfy token type.

XML-24037: invalid language value *string* at line *string*, column *string*

Cause: [cvc-datatype-valid.1.2.2] Characters were not valid value for language type.

Action: Correct the value to satisfy language type.

XML-24038: invalid NMTOKEN value *string* at line *string*, column *string*

Cause: [cvc-datatype-valid.1.2.2] Characters were not valid value for NMTOKEN type.

Action: Correct the value to satisfy NMTOKEN type.

XML-24039: invalid NMTOKENS value *string* at line *string*, column *string*

Cause: [cvc-datatype-valid.1.2.2] Characters were not valid list of NMTOKEN type.

Action: Correct the value to satisfy NMTOKENS type.

XML-24040: invalid Name value *string* at line *string*, column *string*

Cause: [cvc-datatype-valid.1.2.2] Characters were not valid value for Name type.

Action: Correct the value to satisfy Name type.

XML-24041: invalid NCName value *string* at line *string*, column *string*

Cause: [cvc-datatype-valid.1.2.2] Characters were not valid value for NCName type.

Action: Correct the value to satisfy NCName type.

XML-24042: invalid ID value *string* at line *string*, column *string*

Cause: [cvc-datatype-valid.1.2.2] Characters were not valid value for ID type.

Action: Correct the value to satisfy ID type.

XML-24043: invalid IDREF value *string* at line *string*, column *string*

Cause: [cvc-datatype-valid.1.2.2] Characters were not valid value for IDREF type.

Action: Correct the value to satisfy IDREF type.

XML-24044: invalid ENTITY value *string* at line *string*, column *string*

Cause: [cvc-datatype-valid.1.2.2] Characters were not valid value for ENTITY type

Action: Correct the value to satisfy ENTITY type.

XML-24045: invalid ENTITIES value *string* at line *string*, column *string*

Cause: [cvc-datatype-valid.1.2.2] Characters were not valid list of ENTITY value.

Action: Correct the value to satisfy ENTITIES type.

XML-24046: invalid integer value *string* at line *string*, column *string*

Cause: [cvc-datatype-valid.1.2.2] Characters were not valid value for integer type.

Action: Correct the value to satisfy integer type.

XML-24047: invalid nonPositiveInteger value *string* at line *string*, column *string*

Cause: [cvc-datatype-valid.1.2.2] Characters were not valid value for nonPositiveInteger type.

Action: Correct the value to satisfy nonPositiveInteger type.

XML-24048: invalid negativeInteger value *string*

Cause: [cvc-datatype-valid.1.2.2] Characters were not valid value for negativeInteger type.

Action: Correct the value to satisfy negativeInteger type.

XML-24049: invalid long value *string* at line *string*, column *string*

Cause: [cvc-datatype-valid.1.2.2] Characters were not valid value for long type.

Action: Correct the value to satisfy long type.

XML-24050: invalid int value *string* at line *string*, column *string*

Cause: [cvc-datatype-valid.1.2.2] Characters were not valid value for int type.

Action: Correct the value to satisfy int type.

XML-24051: invalid short value *string* at line *string*, column *string*

Cause: [cvc-datatype-valid.1.2.2] Characters were not valid value for short type.

Action: Correct the value to satisfy short type.

XML-24052: invalid byte value *string* at line *string*, column *string*

Cause: [cvc-datatype-valid.1.2.2] Characters were not valid value for byte type.

Action: Correct the value to satisfy byte type.

XML-24053: invalid nonNegativeInteger value *string* at line *string*, column *string*

Cause: [cvc-datatype-valid.1.2.2] Characters were not valid value for nonNegativeInteger type.

Action: Correct the value to satisfy nonNegativeInteger type.

XML-24054: invalid unsignedLong value *string* at line *string*, column *string*

Cause: [cvc-datatype-valid.1.2.2] Characters were not valid value for unsignedlong type.

Action: Correct the value to satisfy unsignedlong type.

XML-24055: invalid unsignedInt value *string* at line *string*, column *string*

Cause: [cvc-datatype-valid.1.2.2] Characters were not valid value of unsignedInt type.

Action: Correct the value to satisfy unsignedInt type.

XML-24056: invalid unsignedShort value *string* at line *string*, column *string*

Cause: [cvc-datatype-valid.1.2.2] Characters were not valid value for unsignedShort type.

Action: Correct the value to satisfy unsignedShort type.

XML-24057: invalid unsignedByte value *string* at line *string*, column *string*

Cause: [cvc-datatype-valid.1.2.2] Characters were not valid value for unsignedByte type.

Action: Correct the value to satisfy unsignedByte type.

XML-24058: value *string* must be valid with respect to one member type

Cause: [cvc-datatype-valid.1.2.3] Characters were invalid with respect to any member type of union.

Action: Correct data value to satisfy at least one member type.

XML-24059: element *string* not expected at line *string*, column *string*

Cause: [cvc-elt.1]

XML-24060: element *string* abstract

Cause: [cvc-elt.2] Element declared abstract was used in instance document.

Action: Do not declare the element as abstract.

XML-24061: element *string* not nillable

Cause: [cvc-elt.3.1] There was an attribute `xsi:nil`, which was not allowed because the element declaration was not nillable.

Action: Remove `xsi:nil` attribute from the element.

XML-24062: no character or element children allowed for nil content *string*

Cause: [cvc-elt.3.2.1] Element was specified `nil` but had character or element children.

Action: Remove any element content or remove `nil` attribute.

XML-24063: nil element does not satisfy fixed value constraint

Cause: [cvc-elt.3.2.2] Element had an fixed value while the content in instance was empty.

Action: Remove `nil` attribute from element.

XML-24064: xsi:type not a QName at line *string*, column *string*

Cause: [cvc-elt.4.1] The value of attribute `xsi:type` was not a QName.

Action: Change the value to a valid QName that references a type.

XML-24065: xsi:type *string* not resolved to a type definition

Cause: [cvc-elt.4.2] The referenced type specified by `xsi:type` was absent.

Action: Correct the value of `xsi:type` so it points to a valid type definition.

XML-24066: local type *string* not validly derived from the type of element *string*

Cause: [cvc-elt.4.3] The type referenced by `xsi:type` was not derived from original type.

Action: Modify the reference type definition so that it satisfies the constraint, or use another type that is derived from the original type.

XML-24067: value *string* not in enumeration

Cause: [cvc-enumeration-valid] The value was not one in the enumeration constraint.

Action: Use valid value specified in enumeration.

XML-24068: invalid facet *string* for type *string*

Cause: [cvc-facet-valid] The given data value violates the constraining facet.

Action: Correct the data value.

XML-24069: too many fraction digits in value *string* at line *string*, column *string*

Cause: [cvc-fractionDigits-valid] The given number violated the `fractionDigits` constraining facet.

Action: Use fewer fraction digits.

XML-24070: missing ID definition for ID reference *string* at line *string*, column *string*

Cause: [cvc-id.1] There is no ID binding in the ID/IDREF table for validation root

Action: Define the ID for the ID reference

XML-24071: duplicate ID *string* at line *string*, column *string*

Cause: [cvc-id.2] Same ID was defined more than once.

Action: Eliminate duplicate ID attributes.

XML-24072: duplicate key sequence *string*

Cause: [cvc-identity-constraint] The document contained duplicate key sequence that violated uniqueness constraint.

Action: Correct the document to make key sequence unique, or modify XPath to avoid it.

XML-24073: target node set not equals to qualified node set for key *string*

Cause: [cvc-identity-constraint.4.2.1] There were empty key sequences in key constraint.

Action: Make sure every element in target node set has a nonempty key sequence.

XML-24074: element member *string* in key sequence is nillable

Cause: [cvc-identity-constraint.4.2.3] The element selected as a member in a key sequence was nillable, which is not allowed.

Action: Modify the schema to make corresponding element declaration not nillable.

XML-24075: missing key sequence for key reference *string*

Cause: [cvc-identity-constraint.4.3] A `keyref` referenced to empty key sequence.

Action: Make sure every key sequence for `keyref` is has a corresponding key sequence for referenced key.

XML-24076: incorrect length of value *string*

Cause: [cvc-length-valid] The length of the value was not the same as specified in length facet.

Action: Use data value with correct length.

XML-24077: value *string* greater than or equal to `maxExclusive`

Cause: [cvc-maxExclusive-valid] The data value was out of boundary specified in `maxExclusive` facet.

Action: Correct the data value.

XML-24078: value *string* greater than the `maxInclusive`

Cause: [cvc-maxInclusive-valid] The data value was out of boundary specified in `maxInclusive` facet.

Action: Correct the data value.

XML-24079: value length of *string* greater than `maxLength`

Cause: [cvc-maxLength-valid] The length of the data value was greater than `maxLength`.

Action: Make the data value's length smaller than `maxLength`.

XML-24080: value *string* smaller or equals to minExclusive

Cause: [cvc-minExclusive-valid] The data value was out of lower boundary of value range.

Action: Use data value that is greater to `minExclusive`.

XML-24081: value *string* smaller than minInclusive

Cause: [cvc-minInclusive-valid] The data value was too small.

Action: Use data value not smaller than the value of `minInclusive`.

XML-24082: value *string* shorter than minLength

Cause: [cvc-minLength-valid] The length of value was smaller than that specified in `minLength`.

Action: Use data value with length greater than or equals to `minLength`.

XML-24083: wildcard particle in the content of element *string* not done

Cause: [cvc-particle.1.1] The wildcard particle's `minOccurs` had not been met.

Action: Have more elements in the content that match the wildcard.

XML-24084: element particle *string* not done

Cause: [cvc-particle.1.2] The element particle's `minOccurs` had not been met.

Action: Have more elements that match the element declaration or members in its substitution group.

XML-24085: model group *string* in the content of element *string* not done

Cause: [cvc-particle.1.3] The model group particle's `minOccurs` had not been met.

Action: Have more elements in the content that match the model group.

XML-24086: invalid literal *string* with respect to pattern facet *string*

Cause: [cvc-pattern-valid] The literal did not match the pattern constraining facet.

Action: Correct the lexical data to match pattern facet.

XML-24087: undefined type *string*

Cause: [cvc-resolve-instance.1] Could not resolve the type reference to a type definition

Action: Add the type definition to schema

XML-24088: undeclared attribute *string*

Cause: [cvc-resolve-instance.2] Could not resolve attribute reference to an attribute declaration.

Action: Add the attribute declaration to schema.

XML-24089: undeclared element *string*

Cause: [cvc-resolve-instance.3] Could not resolve element reference to an element declaration

Action: Add the element declaration to schema.

XML-24090: undefined attribute group *string*

Cause: [cvc-resolve-instance.4] Could not resolve the attribute group reference to an attribute group definition.

Action: Define the attribute group definition in schema.

XML-24091: undefined model group *string*

Cause: [cvc-resolve-instance.5] Could not resolve the model group reference to a model group definition.

Action: Define the model group in schema.

XML-24092: undeclared notation *string*

Cause: [cvc-resolve-instance.6] Could not resolve the notation reference to a notation declaration.

Action: Add the notation declaration to schema.

XML-24093: too many digits in value *string* at line *string*, column *string*

Cause: [cvc-totalDigits-valid] The number of digits in numeric value was greater than the value of `totalDigits` facet.

Action: Use smaller numbers.

A.6 Schema Representation Constraint Error Messages

Schema representation constraint error messages are in the range XML-24100 through XML-24199.

XML-24100: element *string* must belong to XML Schema namespace

Cause: Element in XML Schema document did not have Schema namespace.

Action: Specify XML Schema namespace `http://www.w3.org/2001/XMLSchema`

XML-24101: can not build schema from location *string*

Cause: [schema_reference.2] Processor could not find schema from given schema location

Action: Fix the schema location

XML-24102: can not resolve schema by target namespace *string*

Cause: [schema_reference.3] Processor was unable to retrieve schema based on given namespace.

Action: Fix the schema namespace

XML-24103: invalid annotation representation at line *string*, column *string*

Cause: [src-annotation]

XML-24104: multiple annotations at line *string*, column *string*

Cause: [src-annotation] More than one annotation elements appeared in component.

Action: Remove extra annotation.

XML-24105: annotation must be the first element at line *string*, column *string*

Cause: [src-annotation] Annotation was not the first element in component.

Action: Move annotation to the beginning of component content.

XML-24106: attribute wildcard before attribute declaration at line *string*, column *string*

Cause: The attribute wildcard appeared before attribute declarations.

Action: Move attribute wildcard to the end of declaration.

XML-24107: multiple attribute wildcard

Cause: [src-attribute.1] More than one anyAttributes were declared.

Action: Remove extra attribute wildcards.

XML-24108: default *string* and fixed *string* both present

Cause: [src-attribute.1] Both default and fixed attributes were present in attribute declaration.

Action: Remove either default or fixed attribute.

XML-24109: default value *string* conflicts with attribute use *string*

Cause: [src-attribute.2] Both default and use were present, and value for use is not optional.

Action: Remove either default or use value.

XML-24110: missing name or ref attribute

Cause: [src-attribute.3.1] Neither name nor ref attribute was present in declaration.

Action: Add name or ref to the declaration.

XML-24111: both name and ref presented in attribute declaration

Cause: [src-attribute.3.1] Name and ref attribute were both present in attribute declaration.

Action: Add name or ref to the declaration.

XML-24112: ref conflicts with form, type, or simpleType child

Cause: [src-attribute.3.2] The attribute was a reference, and form, type or simpleType child were specified.

Action: Either change ref to name, or remove form; or remove type, or children, or both.

XML-24113: type attribute conflicts with simpleType child

Cause: [src-attribute.4] Both type attribute and simpleType child were present.

Action: Remove either type reference or type definition.

XML-24114: intersecton of attribute wildcard is not expressible

Cause: [src-attribute_group.2] Attriubes wildcards defined were not expressible with a wildcard.

Action: Remove inexpressible attribute wildcards.

XML-24115: circular attribute group reference *string*

Cause: [src-attribute_group.3] Attriubte group were circularly referenced outside redefine

Action: Remove circular reference

XML-24116: circular group reference *string*

Cause: group were circularly referenced outside redefine.

Action: Remove circular reference

XML-24117: base type *string* for complexContent is not complex type

Cause: [src-ct.1] Derived a complexType with complex content from simple type

Action: Change base type to complex type

XML-24118: simple content required in base type *string*

Cause: [src-ct.2] A complexType with simpleContent was derived from a complexType with complex content

Action: Change base type to simple type (if derivation is extension) or simpleContent complex type.

XML-24119: properties specified with element reference *string*

Cause: [src-element.2.2] Element reference also had complexType, simpleType, key, keyrefunique children or nillable, form, default, block, or type attribute.

Action: Remove conflict attributes or children.

XML-24120: simpleType and complexType can not both present in element declaration *string*

Cause: [src-element.3] Element declaration had both complexType, simpleType children.

Action: Remove either simpleType or complexType child.

XML-24121: imported namespace *string* must different from namespace *string*

Cause: [src-import.1.1] The namespace of import was the same as the target namespace of importing schema

Action: Change import to inclusion.

XML-24122: target namespace *string* required

Cause: [src-import.1.2] Imported namespace was specified but absent imported schema.

Action: Remove namespace attribute in element import, or add target namespace to the imported schema.

XML-24123: namespace *string* is different from expected targetNamespace *string*

Cause: [src-import.3.1] Specified namespace was different from actual targetNamespace imported.

Action: Correct the namespace attribute in import element.

XML-24124: targetNamespace *string* not expected in schema

Cause: [src-import.3.2] Specified a no-namespace schema, but actual schema had targetNamespace.

Action: Remove the imported schema's targetNamespace attribute

XML-24125: can not include schema from *string*

Cause: [src-include.1] Processor was unable to include a schema from given location.

Action: Check correctness of URL and URL resolver

XML-24126: included targetNamespace *string* must the same as *string*

Cause: [src-include.2.1] Tried to include a schema with different targetNamespace.

Action: Use import instead of include.

XML-24127: no-namespace schema can not include schema with target namespace *string*

Cause: [src-include.2.2] A schema without targetNamespace tried to include a schema with targetNamespace.

Action: Use import instead of include

XML-24128: itemType attribute conflicts with simpleType child

Cause: [src-list-itemType-or-simpleType] Both itemType attribute and simpleType child were present in list simple type declaration.

Action: Remove either itemType attribute or simpleType child.

XML-24129: prefix of QName *string* can not be resolved

Cause: [src-QName] Prefix of a QName was present, but did not map to any in-scope namespace.

Action: Declare a namespace corresponding to the prefix.

XML-24130: redefined schema has different namespace. line *string* column *string*

Cause: Redefined schema's targetNamespace was not the same as the targetNamespace of redefining schema.

Action: Correct the targetNamespace in redefined schema.

XML-24131: no-namespace schema can only redefine schema without targetNamespace

Cause: [src-redefine.3.2] A no-namespace schema tried to redefine a schema with namespace

Action: Remove the targetNamespace attribute from redefined schema.

XML-24132: type derivation *string* must be restriction

Cause: [src-redefine.5] A simpleType or complexType was present in redefine, but the derivation was not restriction.

Action: Change the type redefinition, make it a restriction.

XML-24132: type *string* must redefine itself at line *string*, column *string*

Cause: [src-redefine.5] A simpleType or complexType was present in redefine, but its base type was not itself.

Action: Change the base type to redefine itself.

XML-24133: group *string* can have only one self reference in redefinition

Cause: [src-redefine.6.1.1] A group was present in redefine and it had more than onereferences to itself in its content.

Action: Remove extra self references in the group redefinition.

XML-24134: self reference of group *string* must not have minOccurs or maxOccurs other than 1 in redefinition

Cause: [src-redefine.6.1.2] A minOccurs or maxOccurs with value other than 1 was specified in a group self reference in redefine.

Action: Remove the minOccurs or maxOccurs attribute.

XML-24135: redefined group *string* is not a restriction of its original group

Cause: [src-redefine.6.2.2] A group presented in redefine, without self reference but was not a valid restriction of its original group.

Action: Modify the content of the group, make it a valid restriction of its original.

XML-24236: attribute group *string* can have only one self reference in redefinition

Cause: [src-redefine.7.1] An attributeGroup was present in redefine and it had more than oneself references in its content.

Action: Remove extra self references.

XML-24136: redefined attribute group *string* must be a restriction of its original group

Cause: [src-redefine.7.2.2] An attributeGroup presented in redefine, without self reference but was not a valid restriction of its original.

Action: Modify the content of the attribute group, make it valid restriction of its original.

XML-24137: restriction must not have both base and simpleType child

Cause: [src-restriction-base-or-simpleType]

XML-24138: simple type restriction must have either base attribute or simpleType child

Cause: [src-simple-type.2] Both base and simpleType were absent in simple type restriction

Action: Add either base attribute or simpleType child.

XML-24139: neither itemType or simpleType child present for list

Cause: [src-simple-type.3] Missing itemType attribute or simpleType child in list definition.

Action: Add either itemType or simpleType child

XML-24140: itemType and simpleType child can not both be present in list type.

Cause: [src-simple-type.3] Both itemType attribute and simpleType child were present in list definition

Action: Remove either itemType or simpleType child.

XML-24141: circular union type is disallowed

Cause: [src-simple-type.4] Some member types in union type made references to the union type

Action: Remove the circular references

XML-24142: facet *string* can not be specified more than once

Cause: [src-single-facet-value] Same facet other than enumeration and pattern had been specified more than once, which is not allowed.

Action: Remove extra facets.

XML-24143: memberTypes and simpleType child can not both be absent in union

Cause: [src-union-memberTypes-or-simpleTypes] Both memberTypes and simpleType were absent for a union type.

Action: Either specify memberTypes or add simpleType children.

XML-24144: facets can only used for restriction

Cause: [st-restrict-facets] Derivation was not restriction while facet children were present.

Action: Remove facet children.

A.7 Schema Component Constraint Error Messages

Schema component constraint error messages are in the range XML-24200 through XML-24399.

XML-24201: duplicate attribute *string* declaration

Cause: [ag-props-correct.1] There were more than one attribute declarations with same namespace and name in attribute group definition.

Action: Remove duplicate attribute declarations.

XML-24202: more than one attributes with ID type not allowed

Cause: [ag-props-correct.2] There were more than one attribute declarations with type ID.

Action: Change to other types for such attribute declarations

XML-24203: invalid value constraint *string*

Cause: [a-props-correct.2] The fixed value or default value did not satisfy the attribute's type

Action: Use type valid default for fixed value.

XML-24204: value constraint *string* not allowed for ID type

Cause: [a-props-correct.3] Attribute with ID type had either fixed or default value constraint.

Action: Remove value constraint.

XML-24205: fixed value *string* does not match *string* in attribute declaration

Cause: [au-props-correct.2] Attribute reference specified a fixed value which is not the same as that in referenced declaration.

Action: Correct the fixed value to the same as specified in attribute declaration

XML-24206: value constraint must be fixed to match that in attribute declaration

Cause: [au-props-correct.2] Attribute reference specified a default value, while the referenced declaration had a fixed value.

Action: Remove default value from attribute reference.

XML-24207: invalid xpath expression *string*

Cause: [c-fields-xpaths.1] The value of xpath was not valid xpath expression as specified in XPath 1.0.

Action: Use correct xpath

XML-24208: invalid field xpath *string*

Cause: [c-fields-xpaths.2] The value of xpath did not satisfy field's restricted xpath syntax.

Action: Correct the xpath expression

XML-24209: maxOccurs in element *string* of All group must be 0 or 1

Cause: [cos-all-limited] Some elements in a All group had maxOccurs greater than one.

XML-24210: All group has to form a content type.

Cause: All group was contained in another model group

Action: Make all group at the top of a content type

XML-24211: All group has to form a content type.

Cause: [cos-applicable-facets] All group was contained in another model group

Action: Make all group at the top of a content type

XML-24212: type *string* does not allow facet *string*

Cause: [cos-applicable-facets] A facet not applicable to the simple type was used.

Action: Remove the facet.

XML-24213: wildcard intersection is not expressible

Cause: [cos-aw-intersect] Two wildcards in an attribute group had different negative namespaces

Action: Use only one wildcard with negative namespace

XML-24214: base type not allow *string* derivation

Cause: [cos-ct-derived-ok.1] Base type's final prevented the derivation.

Action: Remove the derivation method from the value of final in base type

XML-24215: complex type *string* is not a derivation of type *string*

Cause: [cos-ct-derived-ok.2] There was no derivation chain from base type to derived type.

Action: Fix the derivation chaining.

XML-24216: must specify a particle in extended content type

Cause: [cos-ct-extends.1.4.2.1] The content type of an extension of a complex type was empty

Action: Add particle to the content type of extension.

XML-24217: content type *string* conflicts with base type's content type *string*

Cause: [cos-ct-extends.1.4.2.2.2] Base type's content type was not empty and was not the same as the content type specified.

Action: Match the specified content type with that in base type.

XML-24218: inconsistent local element declarations *string*

Cause: More than one elements in the content had same name and namespace, but did not refer to the same type.

Action: Make type references the same for all elements equal in name and namespace

Comments: cos-element-consistent

XML-24219: element *string* is not valid substitutable for element *string*

Cause: [cos-equiv-derived-ok-rec]

XML-24220: itemType *string* can not be list

Cause: [cos-list-of-atomic] The itemType of a list type was itself a list.

Action: Use atomic or union type as the itemType of list.

XML-24221: cricular union *string* not allowed

Cause: [cos-no-circular-union] Union's name and namespace matched one of its memberType.

Action: Remove any circular references

XML-24222: ambiguous particles *string*

Cause: [cos-nanambig] particles in a content type violated UPA (Unique Particle Attrition) constraint.

Action: Make content type particle unambiguous.

XML-24223: invalid particle extension

Cause: [cos-particle-extend]

XML-24224: invalid particle restriction

Cause: [cos-particle-restrict]

XML-24225: simple type *string* does not allowed restriction

Cause: [cos-st-derived-ok] Derivation was restriction but restriction was in base type's final.

Action: Remove restriction from base type's final.

XML-24226: invalid derivation from base type *string*

Cause: [cos-st-derived-ok] The derivation violated the "type derivaton OK (simple)" constraint.

Action: Make the derivation satisfy the constraint.

XML-24227: atomic type can not restrict list *string*

Cause: [cos-st-restricts.1.1] base type is list,

XML-24228: base type can not be ur-type in restriction

Cause: [cos-st-restricts.1.1] Tried to directly restrict anySimpleType.

XML-24229: base type of list must be list or ur-type

Cause: [cos-st-restricts.2.3]

XML-24230: base type of union must be union or ur-type

Cause: [cos-st-restricts.3.3]

XML-24231: element default *string* requires mixed content to be emptiable

Cause: [cos-valide-default] Element had default constraint but its mixed content type was not emtible.

Action: Remove default value constraint.

XML-24232: element default *string* requires mixed content or simple content

Cause: [cos-valide-default] Element had default value constraint but its content type was element only or empty.

Action: Remove default value constraint.

XML-24233: element default *string* must be valid to its content type

Cause: [cos-valide-default] Element's default value constraint was invalid to its type.

Action: Correct the default value or remove it.

XML-24234: wrong field cardinality for keyref *string*

Cause: [c-props-correct] Number of fields were different between keyref and referenced key.

Action: Ensure that keyref and referenced key have same number of fields.

XML-24235: complex type can only extend simple type *string*

Cause: [ct-props-correct] Complex type was derived from simple type, but derivation was not extension.

Action: Change restriction to extension.

XML-24236: cricular type definition *string*

Cause: [ct-props-correct] Type was in its own derivation chain.

Action: Remove recursive derivation.

XML-24237: base type *string* must be complex type

Cause: [derivation-ok-restriction.1] Complex type was restricted from a simple type.

Action: Change the restriction from a complex type.

XML-24238: attribute *string* not allowed in base type

Cause: [derivation-ok-restriction.2] The attribute in restriction was not allowed for base type.

Action: Correct the restriction of attribute use.

XML-24239: required attribute *string* not in restriction

Cause: [derivation-ok-restriction.3] Restriction's attribute uses was not a subset of basetype's attribute uses.

Action: Correct the restriction of attribute uses.

XML-24240: no corresponding attribute wildcard in base type *string*

Cause: [derivation-ok-restriction.4] Restriction had an attribute wildcard that did not correspond to any attribute wildcard in base type.

Action: Correct the derivation.

XML-24241: base type *string* must have simple content or empty

Cause: [derivation-ok-restriction.5.1] Content type was simple, but the base type has complex content that is not mixed or not empty.

Action: Change the content type from simple to element only.

XML-24242: base type *string* must have empty content or empty

Cause: [derivation-ok-restriction.5.2] Content type was empty, but the base type had simple content or not empty complex content.

Action: Change the content type from simple to element only.

XML-24243: enumeration facet required for NOTATION

Cause: [enumeration-required-notation] NOTATION type was used without enumeration facet.

Action: Specify enumeration facet for NOTATION.

XML-24244: invalid value *string* in enumeration

Cause: [enumeration-valid-restriction] Some value in enumeration was not valid in respect to the type.

Action: Correct invalid values.

XML-24245: default value *string* is element type invalid

Cause: [e-props-correct.2] Default value was invalid in respect to the type of element.

Action: Correct the default value.

XML-24246: invalid substitutionGroup *string*, type invalid

Cause: [e-props-correct.3] The type of the element was not a validly derivation from the type of element's substitutionGroup.

Action: Correct the type or remove substitutionGroup.

XML-24247: ID type does not allow value constraint *string*

Cause: [e-props-correct.4] Type was ID or its derivation whild there was a value constraint.

Action: Remove value constraint.

XML-24248: fractionDigits *string*greater than totalDigits *string*

Cause: [fractionDigits-totalDigits] The value for fractionDigits was greater than totalDigits.

Action: Make fractionDigits smaller or equal to totalDigits.

XML-24249: length facet can not be specified with minLength or maxLength

Cause: [length-minLength-maxLength] Both length and either minLength or maxLength were specified.

Action: Remove length facet.

XML-24250: length *string* not the same as length in base type's

Cause: [length-valid-restriction] Specified a length that was not the same as the length in base type.

Action: Remove length facet.

XML-24251: maxExclusive greater than its original

Cause: [maxExclusive-valid-restriction] Restricted maxExclusive was greater than its original in base type.

XML-24252: minInclusive greater than or equal to maxExclusive

Cause: [maxInclusive-maxExclusive] Specified a minInclusive that was greater or equal to maxExclusive.

Action: Make minInclusive smaller than maxExclusive.

XML-24253: maxLength is greater than that in base type

Cause: [maxLength-valid-restriction] Specified a maxLength greater than original in base type.

Action: Sepcify a smaller maxLength to make it valid restriction.

XML-24254: circular group *string*disallowed

Cause: [mg-props-correct] Circular model group references.

Action: Remove circular references in model group definition.

XML-24256: minExclusive must be less than or equal to maxExclusive

Cause: [minExclusive-less-than-equals-to-maxExclusive] minExclusive was bigger than maxExclusive.

Action: Use smaller value for minExclusive.

XML-24257: minExclusive *string* must be less than maxInclusive

Cause: [minExclusive-less-than-maxInclusive] minExclusive specified was greater than or equal to maxInclusive.

Action: Specify smaller minExclusive.

XML-24258: invalid minExclusive *string*

Cause: [minExclusive-valid-restriction] Restriction's minExclusive was less than base type's minExclusive

Action: Specify greater value for minExclusive.

XML-24259: invalid minExclusive *string*

Cause: [minExclusive-valid-restriction] Restriction's minExclusive was less than base type's minInclusive

Action: Specify greater value for minExclusive

XML-24260: invalid minExclusive *string*

Cause: [minExclusive-valid-restriction] Restriction's minExclusive was greater than base type's maxInclusive

Action: Specify smaller value for minExclusive

XML-24261: invalid minExclusive *string*

Cause: [minExclusive-valid-restriction] Restriction's minExclusive was greater than or equals to base type's maxExclusive

Action: Specify smaller value for minExclusive.

XML-24262: minInclusive *string* must not be greater than maxInclusive

Cause: [minInclusive-less-than-equal-to-maxInclusive] Specified a minInclusive that was greater than maxInclusive

Action: Specify smaller value for minInclusive.

XML-24263: Can not specify both minInclusive and minExclusive

Cause: [minInclusive-minExclusive]] Restriction specified both minInclusive and minExclusive.

Action: Remove either minInclusive or minExclusive.

XML-24264: invalid minInclusive *string*

Cause: [minInclusive-valid-restriction] Restriction's minInclusive was less than or equal to minInclusive in base type.

Action: Use minInclusive larger than that of base type.

XML-24265: invalid minInclusive *string*

Cause: [minInclusive-valid-restriction] Restriction's minInclusive was less than minExclusive in base type.

Action: Use minInclusive larger than or equal to the minExclusive of base type.

XML-24267: invalid minInclusive *string*

Cause: [minInclusive-valid-restriction] Restriction's minInclusive was greater than maxInclusive in base type.

Action: Use minInclusive smaller than or equal to the maxInclusive of base type.

XML-24268: invalid minInclusive *string*

Cause: Restriction's minInclusive was greater than or equal to maxExclusive in base type.

Action: Use minInclusive smaller than the maxExclusive of base type.

Comments: minInclusive-valid-restriction

XML-24269: invalid minLength *string*

Cause: [minLength-less-than-equal-to-maxLength] minLength in restriction is greater than base type's maxLength.

Action: Make minLength within the length range of base type.

XML-24270: invalid minLength *string*

Cause: [minLength-valid-restriction] Value of minLength is smaller than that of base type in restriction.

Action: Use bigger value for minLength.

XML-24271: can not declare xmlns attribute

Cause: [no-xmlns] Declared an attribute with name xmlns.

Action: Remove such declaraton.

XML-24272: no xsi for targetNamespace

Cause: [no-xsi] The schema's target namespace matched <http://www.w3.org/2001/XMLSchema-instance>

Action: Use other target namespace.

XML-24272: minOccurs is greater than maxOccurs

Cause: [n-props-correct] The minOccurs of particle was greater than the maxOccurs.

Action: Use smaller value for minOccurs.

XML-24281: maxOccurs must greater than or equal to 1

Cause: [p-props-correct] The maxOccurs of particle was less than 1.

Action: Use greater value for maxOccurs.

XML-24282: incorrect Notation properties

Cause: [n-props-correct] The Notation declaration had incorrect properties.

Action: Fix Noation declaration.

XML-24283: particle's range is not valid restriction

Cause: [range-ok] Range of restriction was not within the range of parent particle.

XML-24284: sequence group is not valid derivation of choice group

Cause: Restriction did not satisfy constraint: Particle Derivation OK (Sequence:Choice -- MapAndSum)

Comments: rcase-MapAndSum

XML-24285: element *string* is not valid restriction of element *string*

Cause: [rcase-NameAndTypeOK] Restriction did not satisfy constraint: Particle Restriction OK

XML-24286: element *string* is not valid restriction of wildcard

Cause: [rcase-NSCompat] Restriction did not satisfy constraint: Particle Restriction OK

XML-24287: group is not valid restriction of wildcard

Cause: [rcase-NSRecurseCheckCardinality] Restriction did not satisfy constraint: Particle Restriction OK

XML-24288: group any is not valid restriction

Cause: [rcase-NSSubset] Restriction did not satisfy constraint: Particle Restriction OK(Any:Any -- NSSubset)

XML-24289: invalid restriction of all or sequence group

Cause: [rcase-Recurse] Restriction did not satisfy constraint: Particle Restriction OK(All:All, Sequence"Sequence:-- Recurse)

XML-24290: wildcard is not valid restriction

Cause: [rcase-RecurseLax] The wildcard was not validly restricted from another wildcard.

XML-24291: sequence is not a valid restriction of all

Cause: Restriction violated constraint: Particle Derivation OK (Sequence:All-- RecurseUnordered)

Action: Fix the restriction.

XML-24292: duplicate component definitions *string*

Cause: [sch-props-correct] There were two schema components with same name and namespace.

Action: Remove duplicate definitions.

XML-24293: Incorrect simple type definition properties

Cause: [st-props-correct]

XML-24294: wildcard is not a subset of its super

Cause: [w-props-correct] The namespace constraint was not a restriction of its super

Action: Correct namespace constraint.

XML-24295: totalDigits *string*is greater than *string* in base type

Cause: [totalDigits-valid-restriction] Restriction specified a totalDigits with value greater than that in base type.

Action: Use smaller value for totalDigits.

XML-24296: whiteSpace *string* can not restrict base type's *string*

Cause: [whiteSpace-valid-restriction] Restriction's whiteSpace was replace or preserve, and base had whiteSpace collapse, or restriction had replace while base had preserve.

Action: Eliminate conflict whiteSpace values.

XML-24297: circular substitution group *string*

Cause: Substitution group was circular.

Action: Remove the circular substitution group

A.8 XSQL Server Pages Error Messages

XSQL server error messages are in the range XML-25000 through XML-25999.

- XML-25001: Cannot locate requested XSQL file. Check the name.**
- XML-25002: Cannot acquire database connection from pool: *string***
- XML-25003: Failed to find config file *string* in CLASSPATH.**
- XML-25004: Could not acquire a database connection named: *string***
- XML-25005: XSQL page is not well-formed.**
- XML-25006: XSLT stylesheet is not well-formed: *string***
- XML-25007: Cannot acquire a database connection to process page.**
- XML-25008: Cannot find XSLT Stylesheet: *string***
- XML-25009: Missing arguments on command line**
- XML-25010: Error creating: *string*\nUsing standard output.**
- XML-25011: Error processing XSLT stylesheet: *string***
- XML-25012: Cannot Read XSQL Page**
- XML-25013: XSQL Page URI is null; check exact case of file name.**
- XML-25014: Resulting page is an empty document or had multiple document elements.**
- XML-25015: Error inserting XML Document**
- XML-25016: Error parsing posted XML Document**
- XML-25017: Unexpected Error Occurred**
- XML-25018: Unexpected Error Occurred processing stylesheet *string***
- XML-25019: Unexpected Error Occurred reading stylesheet *string***
- XML-25020: Config file *string* is not well-formed.**
- XML-25021: Serializer *string* is not defined in XSQL configuration file**
- XML-25022: Cannot load serializer class *string***
- XML-25023: Class *string* is not an XSQL Serializer**
- XML-25024: Attempted to get response Writer after getting OutputStream**
- XML-25025: Attempted to get response OutputStream after getting Writer**
- XML-25026: Stylesheet URL references an untrusted server**
- XML-25027: Failed to load *string* class for built-in xsql:*string* action.**

XML-30000: Error ignored in *string*: *string*

Cause: Error occurred while processes execution is ignored

Action: None required

XML-30001: Error occurred in execution of Process

Cause: Component being wrapped by pipeline process is causing error

Action: Fix input XML content

XML-30002: Only XML type(s) *string* allowed.

Comments: Must not occur normally

XML-30003: Error creating/writing to output *string*

Cause: Output URL provided might be invalid

XML-30004: Error creating base url *string*

Cause: URL provided as base URL is invalid

Action: Fix base URL provided

XML-30005: Error reading input *string*

Cause: Input URL provided might be invalid

XML-30006: Error in processing pipedoc Error element

XML-30007: Error converting output to xml type required by dependent process

XML-30008: A valid parameter target is required

Cause: Parameter with name target is missing or invalid

Action: Add parameter target pointing to the target output label

XML-30009: Error piping output to input

XML-30010: Process definition element *string* needs to be defined

Cause: Element `procdef` is missing

Action: Add process definition to `pipedoc`.

XML-30011: ContentHandler not available

Cause: The dependent process does not provide a valid `ContentHandler`

Action: Implement the `getContentHandler` API in your `Process`.

XML-30012: Pipeline components are not compatible

Cause: Component output and input don't match in terms of document/docfrag.

Action: Fix the `pipedoc` to use components which are compatible.

XML-30013: Process with output label *string* not found

Cause: Process whose output label matched target label is not available.

Action: Create a process in the `pipedoc`, where the output label matches the label of the target parameter.

XML-30014: Pipeline is not complete, missing output/outparam label called *string*

Cause: A dependent process output label has not been named correctly, or a dependent process is missing.

Action: Ensure that each dependent input has a corresponding output.

XML-30016: Unable to instantiate class

Cause: A process could not be created because there is an error in the process definition element associated with it.

Action: Correctly specify the class for a process definition.

XML-30017: Target is up-to-date, pipeline not executed

Cause: Either the target does not exist, or the pipeline inputs are more recent than the target.

Action: Use the `force` option to execute pipeline regardless of whether the target is up to date.

A.10 JAXB Error Messages

Java Architecture for XML Binding (JAXB) error messages are in the range XML-32000 through XML32999.

XML-32202: a problem was encountered because multiple `<schemaBindings>` were defined.

Cause: There was more than one instance of `<schemaBindings>` declaration in the annotation element of the `<schema>` element.

Action: Update the annotation to remove duplicate `<schemaBinding>` declaration.

XML-32203: a problem was encountered because multiple `<class>` name annotations were defined on node *string*.

Cause: There was more than one instance of `<class>` declaration in the annotation element of the node.

Action: Update the annotation to remove duplicate `<class>` declaration.

XML-32204: a problem was encountered because the name in `<class>` declaration contained a package name prefix *string* which was not allowed.

Cause: A failure occurred because the name attribute in the `<class>` declaration contained a package prefix.

Action: Update the `className` in the `<class>` declaration.

Comments: The package prefix is inherited from the current value of `package`.

XML-32205: a problem was encountered because the property customization was not specified correctly on node *string*.

Cause: A failure occurred because the property customization was not specified correctly.

Action: Update the `<property>` customization.

XML-32206: a problem was encountered because the javaType customization was not specified correctly on node *string*.

Cause: A failure occurred because the property customization was not specified correctly.

Action: Update the `<javaType>` customization.

XML-32207: a problem was encountered in declaring the baseType customization on the node *string*.

Cause: A failure occurred because the `<baseType>` customization was not specified correctly.

Action: Update the `<baseType>` customization.

XML-32208: a problem was encountered because multiple baseType customizations were declared on the node *string*.

Cause: A failure occurred because multiple `<baseType>` customizations were declared.

Action: Remove one of the `<baseType>` customization declaration.

XML-32209: a problem was encountered because multiple javaType customizations were declared on the node *string*.

Cause: A failure occurred because multiple `<javaType>` customizations were declared.

Action: Remove one of the `<javaType>` customization declaration.

XML-32210: a problem was encountered because invalid value was specified on customization of *string*.

Cause: A failure occurred because an invalid value was specified on the `globalBindings` customization declaration.

Action: Check and correct the `globalBindings` customization value.

XML-32211: a problem was encountered because incorrect `<schemaBindings>` customization was specified.

Cause: A failure occurred because an invalid value was specified on the `schemaBindings` customization.

Action: Check and correct the `schemaBindings` customization value.

XML-32212: the <class> customization did not support specifying the implementation class using implClass declaration. The implClass declaration specified on node *string* was ignored.

Cause: A warning occurred because the `implClass` customization declaration was not supported.

XML-32213: the <globalBindings> customization did not support specifying user specific class that implements `java.util.List`. The `collectionType` declaration was ignored.

Cause: A warning occurred because the user specific implementation class for `java.util.List` was not supported.

XDK for Java TXU Error Messages

Error messages are listed for applications that use Oracle XML Developer's Kit (XDK) for Java during the execution of TXU interfaces.

Topics:

- [DLF Error Messages](#) (page B-1)
- [TransX Informational Messages](#) (page B-3)
- [TransX Error Messages](#) (page B-3)
- [Assertion Error Messages](#) (page B-4)

See Also:

<http://www.w3.org/TR/xquery/#id-errors> for the XQuery error messages

B.1 DLF Error Messages

Data Loading Format (DLF) error messages are in the range TXU-0100 through TXU-0199.

TXU-0100: parameter *string* in query *string* not found

Cause: There is not a placeholder for the parameter in the query

Action: Supply a parameter whose id can be found as an associated placeholder in the associated query

TXU-0101: incompatible attributes *col* and *constant* coexist at *string* in query *string*

Cause: Attributes 'col' and 'constant' cannot coexist

Action: Remove either 'col' or 'constant' attribute

TXU-0102: node *string* not found

Cause: The document lacks an expected node

Action: Supply the missing node

TXU-0103: element *string* lacks content

Cause: The element has no data

Action: Supply content

TXU-0104: element *string* with SQL *string* lacks col or constant attribute

Cause: The element lacks a required attribute of 'col' or 'constant'

Action: Supply either 'col' or 'constant' attribute

TXU-0105: SQL exception *string* while processing SQL *string*

Cause: An error occurred during the SQL execution

Action: Resolve the error in the SQL statement

TXU-0106: no data for column *string* selected by SQL *string*

Cause: The SQL query returned no data

Action: Supply data or modify your query

TXU-0107: datatype *string* not supported

Cause: An attempt to process an unsupported data type was made

Action: Change the data type to a supported one

TXU-0108: missing maxsize attribute for column *string*

Cause: The size-unit attribute is specified but maxsize is not.

Action: Supply the maxsize attribute, too

TXU-0109: a text length of *string* for *string* exceeds the allowed maximum of *string*

Cause: The length of the text data is too long

Action: Shorten the data so it fits in the limit, or enlarge the maxsize attribute and ensure the database column is large enough

TXU-0110: undeclared column *string* in row *string*

Cause: A column in the data section is not declared in the columns section

Action: Modify the column name to a declared one

TXU-0111: lacking column data for *string* in row *string*

Cause: A column is declared but the data is missing.

Action: Supply the col element whose name attribute matches the column name

TXU-0112: undeclared query parameter *string* for column *string*

Cause: The query parameter refers to an undeclared column

Action: Specify a declared column

TXU-0113: incompatible attribute *string* with a query on column *string*

Cause: A column with a query cannot have the specified attribute

Action: Remove either the attribute or query

TXU-0114: DLF parse error (*string*) on line *string*, character *string* in *string*

Cause: The format is in error as reported

Action: Correct the erroneous part

TXU-0115: The specified date string *string* has an invalid format

Cause: The specified date string does not match the specified formatstring.

Action: Make sure the date string is in an appropriate date format

B.2 TransX Informational Messages

TransX informational messages are in the range TXU-0200 through TXU-0299.

TXU-0200: duplicate row at *string*

Cause: A duplicate row exists in the database

Action: This message appears on the DuplicateRowException to inform applications of existence of one or more duplicate rows already stored in the database

B.3 TransX Error Messages

TransX error messages are in the range TXU-0300 through TXU-0399.

TXU-0300: document *string* not found

Cause: The document could not be located

Action: Modify the document location or supply the document at the location

TXU-0301: file *string* could not be read

Cause: An I/O error happened when reading the file

Action: Resolve the I/O problem

TXU-0302: archive *string* not found

Cause: The archive file could not be located

Action: Ensure that the CLASSPATH includes TransX correctly and only once

TXU-0303: schema *string* not found in *string*

Cause: The schema definition of DLF could not be located

Action: Get an unbroken copy of a TransX archive

TXU-0304: archive path for *string* not found

Cause: The path for the archive could not be determined

Action: Ensure that the CLASSPATH includes TransX correctly and only once

TXU-0305: no database connection on *string* call for *string*

Cause: The operation was attempted without a database connection

Action: Open a connection first

TXU-0306: null tablename given; access denied

Cause: The table name is not provided

Action: Specify a table name

TXU-0307: lookup-keys could not be determined *string*

Cause: The data dictionary is corrupted

Action: Restore the data dictionary

TXU-0308: binary file *string* not found

Cause: The file name is invalid

Action: Supply a good file name

TXU-0309: a file size of *string* exceeds the allowed maximum of 2,000 bytes

Cause: The file is too large

Action: Reduce the file size

B.4 Assertion Error Messages

Assertion error messages are in the range TXU-0400 through TXU-0499.

TXU-0400: missing SQL statement element on *string*

Cause: An internal assertion was not successful

Action: Contact Oracle customer support

TXU-0401: missing node *string*

Cause: An internal assertion was not successful

Action: Contact Oracle customer support

TXU-0402: invalid flag *string*

Cause: An internal assertion was not successful

Action: Contact Oracle customer support

TXU-0403: internal error *string*

Cause: An internal assertion was not successful

Action: Contact Oracle customer support

TXU-0404: unexpected Exception *string*

Cause: An internal assertion was not successful

Action: Contact Oracle customer support

XDK for Java XSU Error Messages

Error messages are listed for applications that use Oracle XML Developer's Kit (XDK) for Java during the execution of the XML SQL Utility (XSU) interfaces.

Topics:

- [Generic Error Messages](#) (page C-1)
- [Query Error Messages](#) (page C-2)
- [DML Error Messages](#) (page C-3)

See Also:

<http://www.w3.org/TR/xquery/#id-errors> for the XQuery error messages

C.1 Generic Error Messages

Generic error messages are in the range XSUE-0000 through XSUE-0099.

XSUE-0000: Internal Error -- Exception Caught *string*

XSUE-0001: Internal Error -- *string*

XSUE-0002: *string* is not a scalar column. The row id attribute can only get values from scalar columns.

XSUE-0003: *string* is not a valid column name.

XSUE-0004: This object has been closed. If you would like the object not to be closed implicitly between calls, see the *string* method.

XSUE-0005: The row-set enclosing tag and the row enclosing tag are both omitted; consequently, the result can consist of at most one row which contains exactly one column which is not marked to be an XML attribute.

XSUE-0006: The row enclosing tag or the row-set enclosing tag is omitted; consequently to get a well formed XML document, the result can only consist of

a single row with multiple columns or multiple rows with exactly one column which is not marked to be an XML attribute.

XSUE-0007: Parsing of the sqlname failed -- invalid arguments.

XSUE-0008: Character *string* is not allowed in an XML tag name.

XSUE-0009: this method is not supported by *string* class. Please use *string* instead.

XSUE-0010: The number of bind names does not equal the number of bind values.

XSUE-0011: The number of bind values does not match the number of binds in the SQL statement.

XSUE-0012: Bind name identifier *string* does not exist in the sql query.

XSUE-0013: The bind identifier has to be of non-zero length.

XSUE-0014: Root node supplied is null.

XSUE-0015: Invalid LOB locator specified.

XSUE-0016: File *string* does not exist.

XSUE-0017: Can not create oracle.sql.STRUCT object of a type other than oracle.sql.STRUCT (i.e. ADT).

XSUE-0018: Null is not a valid DocumentHandler.

XSUE-0019: Null and empty string are not valid namespace aliases.

XSUE-0020: to use this method you will have to override it in your subclass.

XSUE-0021: You are using an old version of the gss library; thus, sql-xml name escaping is not supported.

XSUE-0022: cannot create XMLType object from opaque base type: *string*

C.2 Query Error Messages

Query error messages are in the range XSUE-0100 through XSUE-0199.

XSUE-0100: Invalid context handle specified.

XSUE-0101: In the FIRST row of the resultset there is a nested cursor whose parent cursor is empty; when this condition occurs we are unable to generate a dtd.

XSUE-0102: *string* is not a valid IANA encoding.

XSUE-0103: The resultset is a "TYPE_FORWARD_ONLY" (non-scrollable); consequently, xsu can not reposition the read point. Furthermore, since the result set has been passed to the xsu by the caller, the xsu can not recreate the resultset.

XSUE-0104: input character is invalid for well-formed XML: *string*

C.3 DML Error Messages

Data manipulation language (DML) error messages are in the range XSUE-0200 through XSUE-0299.

XSUE-0200: The XML element tag *string* does not match the name of any of the columns/attributes of the target database object.

XSUE-0201: NULL is an invalid column name.

XSUE-0202: Column *string*, specified to be a key column, does not exist in table *string*.

XSUE-0203: Column *string*, specified as column to be updated, does not exist in the table *string*.

XSUE-0204: Invalid REF element - *string* - attribute *string* missing.

XSUE-0206: Must specify key values before calling update routine. Use the *string* function.

XSUE-0207: UpdateXML: No columns to update. The XML document must contain some non-key columns to update.

XSUE-0208: The key column array must be non empty.

XSUE-0209: The key column array must be non empty.

XSUE-0210: No rows to modify -- the row enclosing tag missing. Specify the correct row enclosing tag.

XSUE-0211: *string* encountered during processing ROW element *string* in the XML document.

XSUE-0212: *string* XML rows were successfully processed.

XSUE-0213: All prior XML row changes were rolled back.

Oracle XML Developer's Kit JavaBeans (Deprecated)

A description is given of Oracle XML Developer's Kit (XDK) JavaBeans, which is deprecated.

Note:

The XDK JavaBeans, described in this appendix, and the corresponding XDK Java application programming interface (API) packages and classes are deprecated in Oracle Database 12c Release 1 (12.1). These components are still supported in Oracle Database 12c Release 1 (12.1), but Oracle recommends not using them in new applications. This functionality is deprecated with no replacement.

Topics:

- [Introduction to XDK JavaBeans](#) (page D-1)
- [Using XDK JavaBeans: Overview](#) (page D-5)
- [Processing XML with XDK JavaBeans](#) (page D-21)

See Also:

Oracle Database XML Java API Reference for more information about the deprecated XDK Java APIs

D.1 Introduction to XDK JavaBeans

XDK JavaBeans are a set of Extensible Markup Language (XML) components that you can use in Java applications and applets.

Topics:

- [Prerequisites for Using XDK JavaBeans](#) (page D-1)
- [Standards and Specifications for XDK JavaBeans](#) (page D-2)
- [XDK JavaBeans Features](#) (page D-2)

D.1.1 Prerequisites for Using XDK JavaBeans

Prerequisites for using XDK JavaBeans are described.

This appendix assumes that you are familiar with these technologies:

- [JavaBeans](#). JavaBeans components, or Beans, are reusable software components that can be manipulated visually in a builder tool.
- [Java Database Connectivity \(JDBC\)](#). Database connectivity is included with the XDK JavaBeans. The beans can connect directly to a JDBC-enabled database to retrieve and store XML and Extensible Stylesheet Language (XSL) files.
- [Document Object Model \(DOM\)](#). DOM is an in-memory tree representation of the structure of an XML document.
- [Simple API for XML \(SAX\)](#). SAX is a standard for event-based XML parsing.
- [XML Schema language](#). See [Using the XML Schema Processor for Java](#) (page 9-1) for an overview and links to suggested reading.

D.1.2 Standards and Specifications for XDK JavaBeans

XDK JavaBeans require version 1.2 or later of XDK, and they can be used with any version of JDK 1.2 or above. The XDK JavaBeans conform with the Sun JavaBeans specification, and include the required `BeanInfo` class that extends `java.beans.SimpleBeanInfo`.

The JavaBeans 1.01 specification, which describes JavaBeans as present in JDK 1.1, is available here: <http://www.oracle.com/technetwork/java/index.html>

The additions for the Java 2 platform to the JavaBeans core specification provide developers with standard means to create more sophisticated JavaBeans components. The JavaBeans specifications for Java 2 are also available here: <http://www.oracle.com/technetwork/java/index.html>

See Also:

[Oracle XML Developer's Kit Standards](#) (page 33-1) for a summary of the standards supported by XDK

D.1.3 XDK JavaBeans Features

XDK JavaBeans facilitate the addition of graphical user interfaces (GUIs) to XML applications. Bean encapsulation includes documentation and descriptors that you can access directly from Java integrated development environments (IDEs) such as Oracle JDeveloper.

XDK includes these beans:

- [DOMBuilder](#) (page D-3)
- [XSLTransformer](#) (page D-3)
- [DBAccess](#) (page D-3)
- [XMLDBAccess](#) (page D-4)
- [XMLDiff](#) (page D-4)
- [XMLCompress](#) (page D-5)
- [XSDValidator](#) (page D-5)

D.1.3.1 DOMBuilder

The `oracle.xml.async.DOMBuilder` bean constructs a DOM tree from an XML document. The `DOMBuilder` JavaBean encapsulates the XML parser for class `DOMParser` with a bean interface and supports asynchronous parsing. By registering a listener, Java programs can initiate parsing of large or multiple documents and immediately return control to the caller.

A main benefit of this bean is increased efficiency when parsing multiple files, especially if the files are large. `DOMBuilder` can also provide asynchronous parsing in a background thread in interactive visual applications. Without asynchronous parsing, the GUI is useless until the document to be parsed. With `DOMBuilder`, the application invokes the `parse` method and then resumes control. The application can display a progress bar, allow the user to cancel the parse, and so forth.

See Also:

[Using the DOMBuilder JavaBean: Basic Process](#) (page D-6)

D.1.3.2 XSLTransformer

The `oracle.xml.async.XSLTransformer` JavaBean supports asynchronous transformation. It accepts an XML document, applies an Extensible Stylesheet Language Transformation (XSLT) stylesheet, and creates an output file. It lets you transform an XML document to almost any text-based format, including XML, HTML, and data definition language (DDL).

This bean can also be used as the basis of a server-side application or servlet to render an XML document, such as an XML representation of a query result, into HTML for display in a browser.

The main benefit of the `XSLTransformer` bean is that it can transform multiple files in parallel. Like `DOMBuilder`, you can also use it in visual applications to avoid long periods of time when the GUI is nonresponsive. By implementing the `XSLTransformerListener` interface, the invoking application receives notification when the transformation completes.

See Also:

[Using the XSLTransformer JavaBean: Basic Process](#) (page D-8)

D.1.3.3 DBAccess

The `oracle.xml.dbaccess.DBAccess` bean maintains character large object (CLOB) tables that contain multiple XML and text documents.

You can use it to store and retrieve XML documents in the database, but not to process them within the database. Java applications that use the `DBAccess` bean connect to the database through JDBC. XML documents stored in CLOB tables that are not of type `XMLType` do not have their entities expanded.

The `DBAccess` bean enables you to do perform these tasks:

- Create and delete tables of type CLOB.

- Query the contents of CLOB tables.
- Perform INSERT, UPDATE, and DELETE operations on XML documents stored in CLOB tables.

D.1.3.4 XMLDBAccess

The `oracle.xml.xmldbaccess.XMLDBAccess` bean extends the `DBAccess` bean to support XML documents stored in `XMLType` tables. The class provides methods to list, delete, or retrieve `XMLType` instances and their tables. For example, the `getXMLXPathTextData()` method retrieves the value of an XPath expression from an XML document.

`DBAccess` JavaBean maintains `XMLType` tables that can hold multiple XML and text documents. Each XML or text document is stored as a row in the table. The table is created with this structured query language (SQL) statement:

```
CREATE TABLE (FILENAME CHAR( ) UNIQUE,  
              FILEDATA SYS.XMLType);
```

The `FILENAME` field holds a unique string used as a key to retrieve, update, or delete the row. Document text is stored in the `FILEDATA` field.

The `XMLDBAccess` bean performs these tasks:

- Creates and deletes `XMLType` tables
- Lists the contents of an `XMLType` column
- Performs INSERT, UPDATE, and DELETE operations on XML documents stored in `XMLType` tables

See Also:

[Using the XMLDBAccess JavaBean: Basic Process](#) (page D-9)

D.1.3.5 XMLDiff

When comparing XML documents, it is usually unhelpful to compare them character by character. Most XML comparisons are concerned with differences in structure and significant textual content, not differences in white space.

The `oracle.xml.differ.XMLDiff` bean performs these tasks:

- Constructs and compares the DOM trees for two input XML documents and indicates whether the documents are different.
- Provides a graphical display of the differences between two XML files. Specifically, you can refer to node insert, delete, modify, or move.
- Generates an XSLT stylesheet that can convert one of the input XML documents into the other document.

The `XMLDiff` bean is especially useful in pipeline applications. For example, an application could update an XML document, compare it with a previous version of the document, and store the XSLT stylesheet that shows the differences between them.

See Also:

- [Using the XML Pipeline Processor for Java](#) (page 11-1)
 - [Using the XMLDiff JavaBean: Basic Process](#) (page D-11)
-

D.1.3.6 XMLCompress

The Oracle XML parser includes a compressor that can serialize XML document objects as binary streams.

This is explained in [Compressing and Decompressing XML](#) (page 4-49). Although a useful tool, compression with XML parser has these disadvantages:

- When XML data is deserialized, it must be reparsed.
- The encapsulation of XML data in tags greatly increase its size.

The `oracle.xml.xmlcomp.XMLCompress` bean is an encapsulation of the XML compression functionality. It provides these advantages when serializing and deserializing XML:

- It encapsulates the method that serializes the DOM, which produces a stream.
- XML processors can regenerate the DOM from the compressed stream without reparsing the XML.

The bean supports compression and decompression of input XML parsed by `DOMParser` or `SAXParser`. DOM compression supports inputs of type `XMLType`, `CLOB`, and `BLOB`.

To use different parsing options, parse the document before input and then pass the `XMLDocument` object to the compressor bean. The compression factor is a rough value based on the file size of the input XML file and the compressed file. The limitation of the compression factor method is that it can be used only when the compression is performed with `java.io.File` objects as parameters.

D.1.3.7 XSDValidator

The `oracle.xml.schemavalidator.XSDValidator` bean encapsulates the `XSDValidator` class and adds capabilities for validating a DOM tree.

A useful feature of this bean concerns validation errors. If the application throws a validation error, method `getStackList()` returns a list of DOM tree paths that lead to the invalid node. Nodes with errors are returned in a vector of stack trees in which the top element of the stack represents the root node. You can get child nodes by pulling them from the stack. To use `getStackList()` you must use instantiate the `java.util.Vector` and `java.util.Stack` classes.

D.2 Using XDK JavaBeans: Overview

Topics here include basic use of JavaBeans and running the demo programs.

Topics:

- [Using XDK JavaBeans: Basic Process](#) (page D-6)
- [Running XDK JavaBean Demo Programs](#) (page D-12)

D.2.1 Using XDK JavaBeans: Basic Process

The program flow of Java applications that use the more useful beans is described. These include `DOMBuilder`, `XSLTransformer`, `XMLDBAccess`, and `XMLDiff`.

- [Using the DOMBuilder JavaBean: Basic Process](#) (page D-6)
- [Using the XSLTransformer JavaBean: Basic Process](#) (page D-8)
- [Using the XMLDBAccess JavaBean: Basic Process](#) (page D-9)
- [Using the XMLDiff JavaBean: Basic Process](#) (page D-11)

D.2.1.1 Using the DOMBuilder JavaBean: Basic Process

Class `DOMBuilder` implements an XML 1.0 parser according to the World Wide Web Consortium (W3C) recommendation. It parses an XML document and builds a DOM tree. The parsing is done in a separate thread. Interface `DOMBuilderListener` must be used for notification when the tree is built.

When developing applications that use this bean, you must import these subpackages:

- `oracle.xml.async`, which provides asynchronous Java beans for DOM building
- `oracle.xml.parser.v2`, which provides APIs for SAX, DOM, and XSLT

Subpackage `oracle.xml.parser.v2` is described in [XML Parsing for Java](#) (page 4-1). The most important DOM-related classes and interfaces in the `javax.xml.async` package are described in [Table D-1](#) (page D-6).

Table D-1 *javax.xml.async DOM-Related Classes and Interfaces*

Class/Interface	Description
<code>DOMBuilder</code> class	Encapsulates an XML parser to parse an XML document and build a DOM tree. The parsing is done in a separate thread. The <code>DOMBuilderListener</code> interface must be used for notification when the tree is built.
<code>DOMBuilderEvent</code> class	Instantiates the event object that <code>DOMBuilder</code> uses to notify all registered listeners about parse events.
<code>DOMBuilderListener</code> interface	Must be implemented so that the program can receive notifications about events during the asynchronous parsing. The class implementing this interface must be added to the <code>DOMBuilder</code> with the <code>addDOMBuilderListener()</code> method.
<code>DOMBuildErrorEvent</code> class	Defines the error event that is sent when parse exception occurs.
<code>DOMBuildErrorListener</code> interface	Must be implemented so that the program can receive notifications when errors are found during parsing. The class implementing this interface must be added to the <code>DOMBuilder</code> with the <code>addDOMBuildErrorListener()</code> method.

[Figure D-1](#) (page D-7) depicts the basic process of an application that uses the `DOMBuilder` JavaBean.

Figure D-1 *DOMBuilder JavaBean Usage*

Figure D-1 (page D-7) shows these stages of XML processing:

1. Parse the input XML document. The program can receive the XML document as a file, string buffer, or URL.
2. Add the `DOMBuilder` listener. The program invokes the method `DOMBuilder.addDOMBuilderListener(DOMBuilderListener)`.
3. Parse the XML document. The program invokes the `DOMBuilder.parse()` method.
4. Optionally, process the parsed result further.
5. Invoke the listener when the program receives an asynchronous call. The listener, which must implement the `DOMBuilderListener` interface, is called by invoking the `DOMBuilderOver()` method.

The available `DOMBuilderListener` methods are:

- `domBuilderError(DOMBuilderEvent)`, which is called when parse errors occur.
- `domBuilderOver(DOMBuilderEvent)`, which is called when parsing completes.

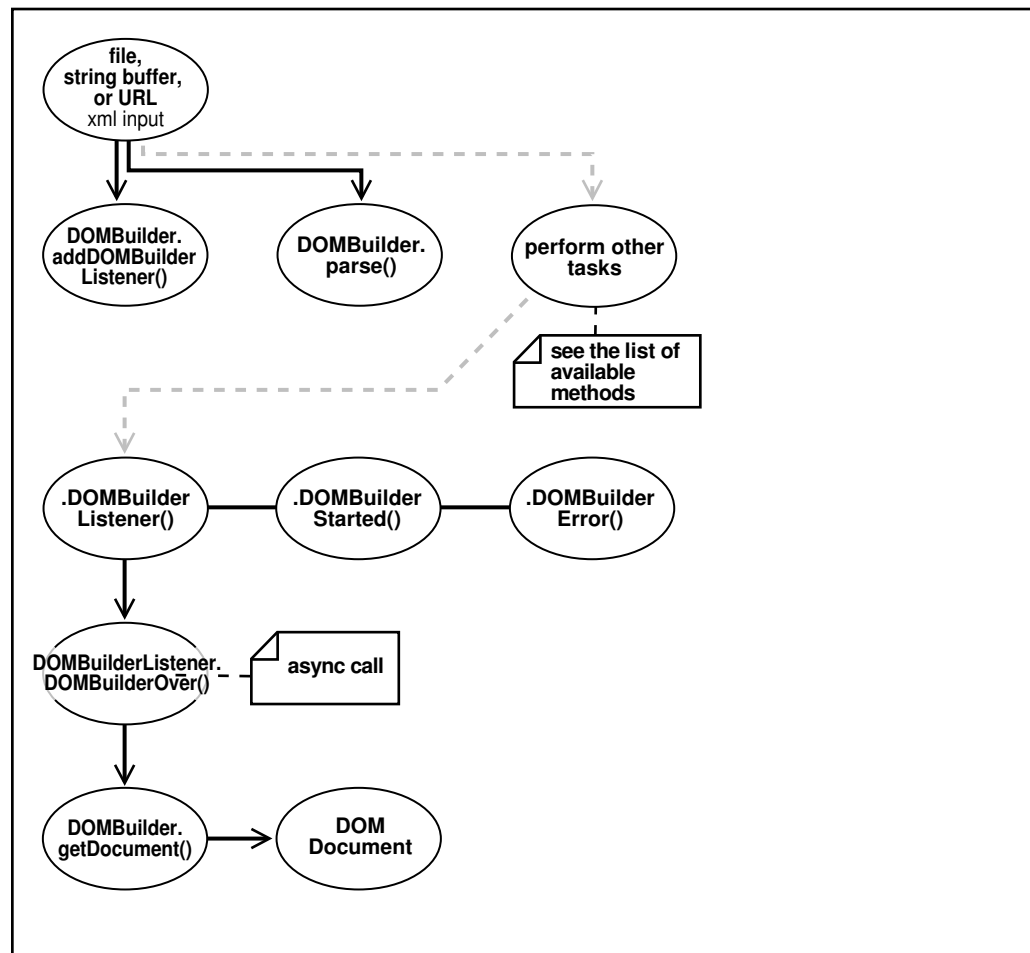
- `domBuilderStarted(DOMBuilderEvent)`, which is called when parsing begins.
6. Fetch the DOM. Invoke the `DOMBuilder.getDocument()` method to fetch the resulting DOM document and output it.

D.2.1.2 Using the XSLTransformer JavaBean: Basic Process

The `XSLTransformer` bean encapsulates the Java XML parser XSLT processing engine with a bean interface and extends its functionality to permit asynchronous transformation. By registering a listener, your Java application can transform large and successive documents by having the control returned immediately to the caller.

When developing applications that use this bean, you must import these subpackages:

- `oracle.xml.async`, which provides asynchronous Java beans for XSL transformations
- `oracle.xml.parser.v2`, which provides APIs for XML parsing SAX, DOM, and XSLT

The `oracle.xml.parser.v2` subpackage is described in detail in [XML Parsing for Java](#) (page 4-1). The most important XSL-related classes and interfaces in the `javax.xml.async` package are described in [Table D-2](#) (page D-8).

Table D-2 *javax.xml.async XSL-Related Classes and Interfaces*

Class/Interface	Description
<code>XSLTransformer</code> class	Applies XSL transformation in a background thread.
<code>XSLTransformerEvent</code> class	Represents the event object used by <code>XSLTransformer</code> to notify XSL transformation events to all of its registered listeners.
<code>XSLTransformerListener</code> interface	Must be implemented so that the program can receive notifications about events during asynchronous transformation. The class implementing this interface must be added to the <code>XSLTransformer</code> with the <code>addXSLTransformerListener()</code> method.
<code>XSLTransformerErrorEvent</code> class	Instantiates the error event object that <code>XSLTransformer</code> uses to notify all registered listeners about transformation error events.
<code>XSLTransformerErrorListener</code> interface	Must be implemented so that the program can receive notifications about error events during the asynchronous transformation. The class implementing this interface must be added to the <code>XSLTransformer</code> using <code>addXSLTransformerListener()</code> method.

[Figure D-2](#) (page D-9) shows `XSLTransformer` bean usage.

Figure D-2 XSLTransformer JavaBean Usage

Figure D-2 (page D-9) goes through these stages:

1. Input an XSLT stylesheet and XML instance document.
2. Add an XSLT listener. The program invokes the `XSLTransformer.addXSLTransformerListener()` method.
3. Apply the stylesheets. The `XSLTransformer.processXSL()` method initiates the XSL transformation in the background.
4. Optionally, perform further processing with the XSLTransformer bean.
5. Invoke the XSLT listener when the program receives an asynchronous call. The listener, which must implement the XSLTransformerListener interface, is called by invoking the `xslTransformerOver()` method.
6. Fetch the result of the transformation. Invoke the `XSLTransformer.getResult()` method to return the XML document fragment for the resulting document.
7. Output the XML document fragment.

D.2.1.3 Using the XMLDBAccess JavaBean: Basic Process

Basic use of the XMLDBAccess bean is described.

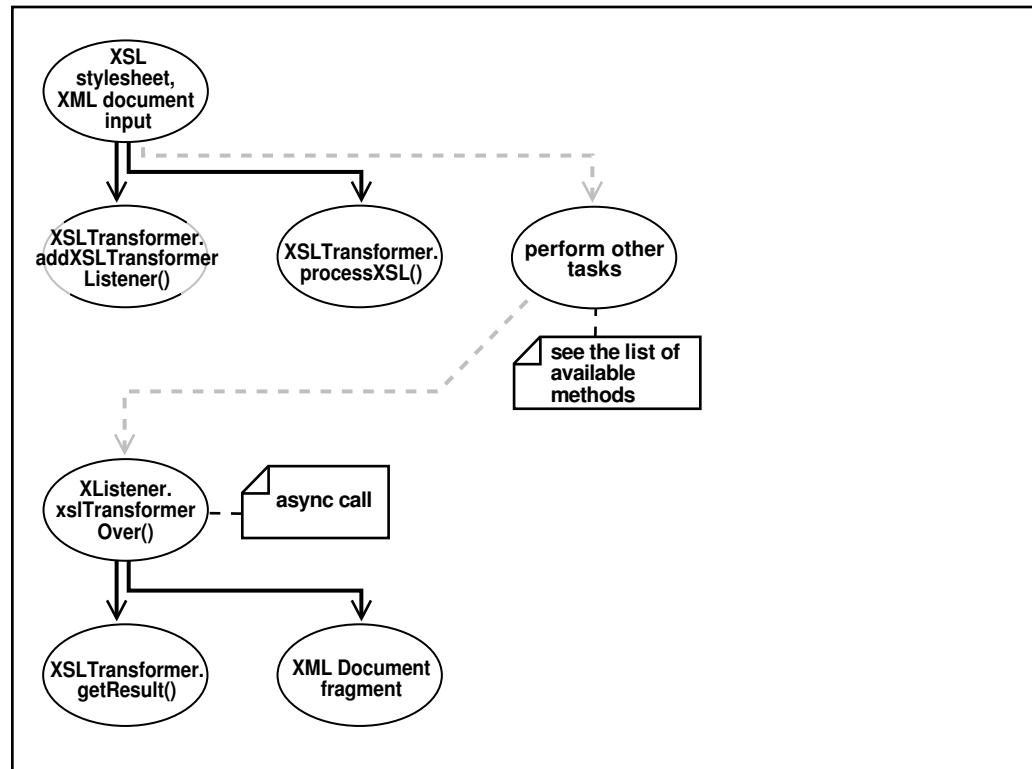
When developing applications that use the XMLDBAccess bean, you must use these subpackages:

- `oracle.xml.xmldbaccess`, which includes the XMLDBAccess bean

- `oracle.xml.parser.v2`, which provides APIs for XML parsing SAX, DOM, and XSLT

The `oracle.xml.parser.v2` subpackage is described in detail in [XML Parsing for Java](#) (page 4-1). Some of the more important methods in the `XMLDBAccess` class are described in [Table D-3](#) (page D-10).

Table D-3 XMLDBAccess Methods

Class/Interface	Description
<code>createXMLTypeTable()</code>	Creates an <code>XMLType</code> table.
<code>insertXMLTypeData()</code>	Inserts a text file as a row in an <code>XMLType</code> table.
<code>replaceXMLTypeData()</code>	Replaces a text file as a row in an <code>XMLType</code> table.
<code>getXMLTypeTableNames()</code>	Retrieves all XML tables with names starting with a specified string.
<code>getXMLTypeData()</code>	Retrieves text file from an <code>XMLType</code> table.
<code>getXMLTypeXPathTextData()</code>	Retrieves the text data based on the XPath expression from an <code>XMLType</code> table.

[Figure D-3](#) (page D-10) shows typical `XMLDBAccess` bean usage. It shows how the `DBAccess` bean maintains and manipulates XML documents stored in `XMLTypes`.

Figure D-3 XMLDBAccess JavaBean Usage

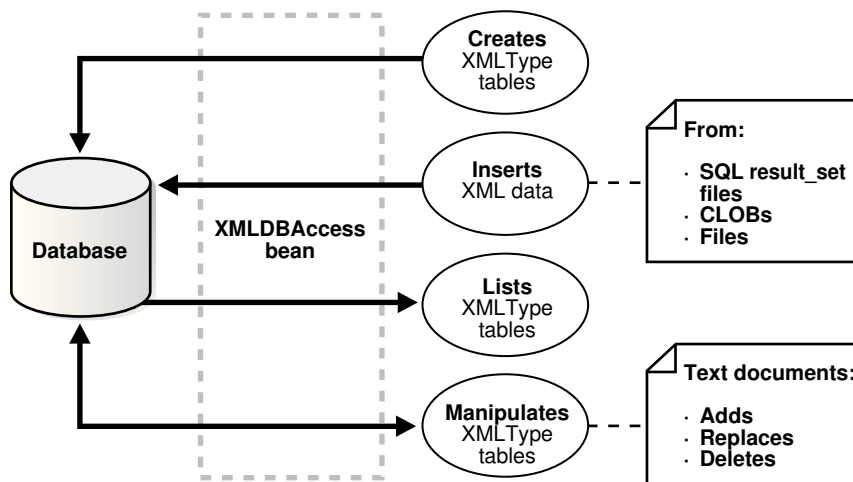

For example, an `XMLDBAccess` program could process XML documents in these stages:

1. Create an `XMLType` table. Invoke `createXMLTypeTable()` by passing it database connection information and a table name.
2. List the `XMLType` tables. Invoke `getXMLTypeTableNames()` by passing it database connection information and an empty string.
3. Load XML data into the table. Invoke `replaceXMLTypeData()` by passing it database connection information, the table name, the XML file name, and a string containing the XML.

4. Retrieve the XML data into a `String`. Invoke `getXMLTypeData()` by passing it the connection information, the table name, and the XML file name.
5. Retrieve XML data based on an XPath expression. Invoke `getXMLXPathTextData()` by passing it the connection information, the table name, the XML file name, and the XPath expression.
6. Close the connection.

D.2.1.4 Using the XMLDiff JavaBean: Basic Process

Basic use of the `XMLDiff` bean is described.

When developing applications that use the `XMLDiff` bean, you typically use these subpackages:

- `oracle.xml.xmldiff`, which includes the `XMLDiff` bean
- `oracle.xml.parser.v2`, which provides APIs for XML parsing SAX, DOM, and XSLT
- `oracle.xml.async`, which provides asynchronous Java beans for DOM building

Subpackage `oracle.xml.parser.v2` is described in detail in [XML Parsing for Java](#) (page 4-1). Some important methods in class `XMLDiff` are described in [Table D-4](#) (page D-11).

Table D-4 XMLDiff Methods

Class/Interface	Description
<code>diff()</code>	Determines the differences between two input XML files or two <code>XMLDocument</code> objects.
<code>generateXSL()</code>	Generates an XSL file that represents the differences between the input two XML files. The first XML file can be transformed into the second XML file with the generated stylesheet. If the XML files are the same, then the XSL generated can transform the first XML file into the second XML file, where the first and second files are equivalent. Related methods are <code>generateXSLDoc()</code> and <code>generateXSLFile()</code> .
<code>setFiles()</code>	Sets the XML files to be compared.
<code>getDocument1()</code>	Gets the document root as an <code>XMLDocument</code> object of the first XML tree. <code>getDocument2()</code> is the equivalent method for the second tree.
<code>getDiffPanel()</code>	Gets the text panel as <code>JTextPane</code> object that visually shows the diffs in the first XML file. <code>getDiffPanel2()</code> is the equivalent method for the second file.

[Figure D-4](#) (page D-12) shows typical `XMLDiff` bean usage. It shows how `XMLDiff` bean compares and displays the differences between input XML documents.

Figure D-4 XMLDiff JavaBean Usage

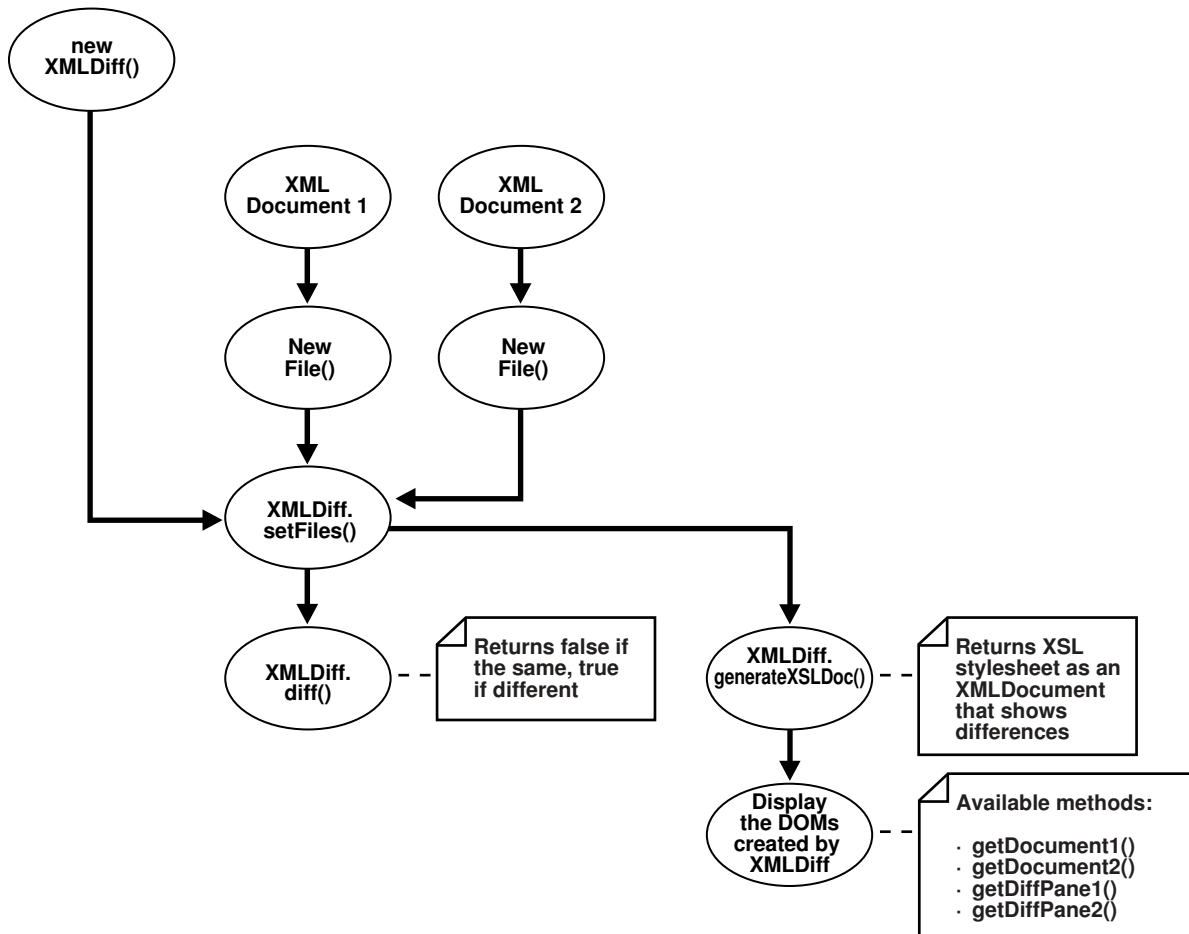

For example, an XMLDiff program could process XML documents in these stages:

1. Create an XMLDiff object.
2. Set the files to be compared. Create File objects for the input files and pass references to the objects to XMLDiff.setFiles().
3. Compare the documents. The diff() method returns false if the XML files are the same and true if they are different.
4. Respond depending on the whether the input XML documents are the same or different. For example, if they are the same, invoke JOptionPane.showMessageDialog() to print a message.
5. Generate an XSLT stylesheet that shows the differences between the input XML documents. For example, generateXSLDoc() generates an XSL stylesheet as an XMLDocument.
6. Display the DOM trees created by XMLDiff.

D.2.2 Running XDK JavaBean Demo Programs

Demo programs for XDK SJavaBeans are included in directory \$ORACLE_HOME/xdk/demo/java/transviewer.

The demos show the use of the XDK beans described in [XDK JavaBeans Features](#) (page D-2), and also some visual beans that are now deprecated. The beans used in the demos are:

- XSLTransformer
- DOMBuilder
- DBAccess
- XMLDBAccess
- XMLDiff
- XMLCompress
- XSDValidator
- oracle.xml.srcviewer.XMLSourceView (deprecated)
- oracle.xml.treeviewer.XMLTreeView (deprecated)
- oracle.xml.transformer.XMLTransformPanel (deprecated)
- oracle.xml.dbviewer.DBViewer (deprecated)

Although the visual beans are deprecated, they remain useful as educational tools. Consequently, the deprecated beans are included in `$ORACLE_HOME/lib/xmldemo.jar`. The nondeprecated beans are included in `$ORACLE_HOME/lib/xml.jar`.

[Table D-5](#) (page D-13) lists the sample programs provided in the demo directory. The first column of the table indicates which sample program use deprecated beans.

Table D-5 JavaBean Sample Java Source Files

Sample	File Name	Description
sample1 (depreca d)	XMLTransformPanelSample. java	A visual application that uses the XMLTransformPanel, DOMBuilder, and XSLTransformer beans. This bean applies XSL transformations to XML documents and shows the result. See also Running sample1 (page D-17)
sample2 (depreca d)	ViewSample.java	A sample visual application that uses the XMLSourceView and XMLTreeView beans. It visualizes XML document files. See also Running sample2 (page D-17)
sample3	AsyncTransformSample.jav a	A nonvisual application that uses the XSLTransformer and DOMBuilder beans. It applies the XSLT stylesheet specified in <code>doc.xsl</code> on all <code>.xml</code> files in the current directory. It writes the results to files with the extension <code>.log</code> . See also Running sample3 (page D-18)
sample4 (depreca d)	DBViewSample.java	A visual application that uses the DBViewer bean to implement a simple application that handles insurance claims. See also Running sample4 (page D-18)

Table D-5 (Cont.) JavaBean Sample Java Source Files

Sample	File Name	Description
sample4 (deprecated)	<code>DBViewClaims.java</code>	This <code>JFrame</code> subclass is instantiated in the <code>DBViewFrame</code> class, which is in turn instantiated in the <code>DBViewSample</code> program.
sample4 (deprecated)	<code>DBViewFrame.java</code>	This <code>JFrame</code> subclass is instantiated in the <code>DBViewSample</code> program.
sample5	<code>XMLDBAccessSample.java</code>	A nonvisual application for the <code>XMLDBAccess</code> bean. This program demonstrates how to use the <code>XMLDBAccess</code> bean APIs to store and retrieve XML documents in <code>XMLType</code> tables. To use <code>XMLType</code> , you need Oracle Database and <code>xdb.jar</code> . The program accepts values for <code>HOSTNAME</code> , <code>PORT</code> , <code>SID</code> , <code>USERID</code> , and <code>PASSWORD</code> . The program creates tables in the database and loads data from file <code>booklist.xml</code> . The program writes output to <code>xmldbaccess.log</code> . See also Running sample5 (page D-18)
sample6 (deprecated)	<code>XMLDiffSample.java</code>	A visual application that uses the <code>XMLDiff</code> bean to find differences between two XML files and generate an XSLT stylesheet. You can use this stylesheet to transform the first input XML into the second input XML file. See also Running sample6 (page D-19)
sample6 (deprecated)	<code>XMLDiffFrame.java</code>	A class that implements the <code>ActionListener</code> interface. This class is used by the <code>XMLDiffSample</code> program.
sample6 (deprecated)	<code>XMLDiffSrcView.java</code>	A <code>JPanel</code> subclass used by the <code>XMLDiffSample</code> program.
sample7 (deprecated)	<code>compviewer.java</code>	A visual application that uses the <code>XMLCompress</code> bean to compress XML. The XML input can be an XML file or XML data obtained through a SQL query. The application enables you to decompress the compressed stream and view the resulting DOM tree. See also Running sample7 (page D-20)
sample7 (deprecated)	<code>compstreamdata.java</code>	A simple class that pipes information from the GUI to the bean. This class is used in <code>dbpanel.java</code> , <code>filepanel.java</code> , and <code>xmlcompressutil.java</code> .
sample7 (deprecated)	<code>dbpanel.java</code>	A <code>JPanel</code> subclass used in <code>xmlcompressutil.java</code> .

Table D-5 (Cont.) JavaBean Sample Java Source Files

Sample	File Name	Description
sample7 (deprecated)	filepanel.java	A JPanel subclass used in xmlcompressutil.java.
sample7 (deprecated)	xmlcompressutil.java	A JPanel subclass used in compviewer.java.
sample8 (deprecated)	XMLSchemaTreeViewer.java	A visual application that uses the Treeviewer, sourceviewer, and XSDValidator beans. The application accepts an XML instance document and an XML schema document as inputs. The application parses both the documents and validates the instance document against the schema. If the document is invalid, then the nodes where the errors occurred are highlighted and an error message is shown in a tool tip. See also Running sample8 (page D-20)
sample8 (deprecated)	TreeViewerValidate.java	A JPanel subclass that displays a parsed XML instance document as a tree. This class is used by the XMLSchemaTreeViewer.java program.
sample9 (deprecated)	XMLSrcViewer.java	A visual application that uses the sourceviewer and XSDValidator beans. The demo takes an XML file as input. You can select the validation mode: document type definition (DTD), XML schema, or no validation. The program validates the XML data file against the DTD or schema and displays it with syntax highlighting. It also logs validation errors. For schema validation it also highlights the error nodes appropriately. External and internal DTDs can be viewed. See also Running sample9 (page D-20)
sample9 (deprecated)	XMLSrcViewPanel.java	A class that shows how to use the XMLSourceView and DTDSrcView objects. This class is used by the XMLSrcViewer.java program. Each XMLSourceView object is set as a Component of a JPanel by invoking <code>goButton_actionPerformed()</code> . The XML file to be viewed is parsed and the resulting XML document is set in the XMLSourceView object by invoking <code>makeSrcPane()</code> . The highlighting and DTD display properties are specified at this time. For performing schema validation, build the schema object by invoking <code>makeSchemaValPane()</code> . You can check for errors and display the source code accordingly with different highlights. You can retrieve a list of schema validation errors from the XMLSourceView by invoking <code>dumpErrors()</code> .

Table D-5 (Cont.) JavaBean Sample Java Source Files

Sample	File Name	Description
sample10	XSDValidatorSample.java	An application that shows how to use the XSDValidator bean. It accepts an XML file and an XML schema file as input. The program displays errors occurring during validation, including line numbers. See also Running sample10 (page D-20)

[Table D-6](#) (page D-16) describes additional files that are used by the demo programs.

Table D-6 JavaBean Sample Files

File Name	Description
XMLDiffData1.txt	An XML document used by the XMLDiffSample.java program. By default the 2 XML files XMLDiffData1.txt and XMLDiffData2.txt are compared and the output XSLT is stored as XMLDiffSample.xsl.
XMLDiffData2.txt	An XML document used by the XMLDiffSample.java program. By default the 2 XML files XMLDiffData1.txt and XMLDiffData2.txt are compared and the output XSLT is stored as XMLDiffSample.xsl.
booklist.xml	An XML document for use by XMLDBAccessSample.java.
claim.sql	An XML document used by ViewSample.java and XMLDBAccessSample.java.
doc.xml	An XML document for use by AsyncTransformSample.java.
doc.xsl	An XSLT stylesheet for use by AsyncTransformSample.java.
emptable.xsl	An XSLT stylesheet for use by AsyncTransformSample.java, ViewSample.java, or XMLTransformPanelSample.java.
note_in_dtd.xml	A sample XML document for use in XMLSrcViewer.java. You can use this file in DTD validation mode to view an internal DTD with validation errors. An internal DTD can be optionally displayed along with the XML data.
purchaseorder.xml	An XML document used by the XSDValidatorSample.java program. The instance document purchaseorder.xml does not conform to the XML schema defined in purchaseorder.xsd, which causes the program to display the errors.
purchaseorder.xsd	An XML schema document used by the XSDValidatorSample.java program. The instance document purchaseorder.xml does not conform to the XML schema defined in purchaseorder.xsd, which causes the program to display the errors.

Documentation for how to compile and run the sample programs is located in the README in the same directory. The basic steps are:

1. Change into the \$ORACLE_HOME/xdk/demo/java/transviewer directory (UNIX) or %ORACLE_HOME%\xdk\demo\java\transviewer directory (Windows).
2. Make sure that your environment variables are set as described in [Setting Up the XDK for Java Environment](#) (page 3-5). The beans require Java Development Kit

(JDK) 1.2 or later. The `DBViewer` and `DBTransformPanel` beans require JDK 1.2.2 when rendering HTML. Prior versions of the JDK may not render HTML in the result buffer properly.

3. Edit the `Makefile` (UNIX) or `Make.bat` (Windows) for your environment. In particular,;
 - Change the `JDKPATH` in the `Makefile` to point to your JDK path.
 - Change `PATHSEP` to the appropriate path separator for your operating system.
 - Change the `HOSTNAME`, `PORT`, `SID`, `USERID`, and `PASSWORD` parameters so that you can connect to the database through the JDBC thin driver. These parameters are used in `sample4` and `sample5`.
4. Run `make` (UNIX) or `Make.bat` (Windows) at the system prompt to generate the class files.
5. Run `gmake` to run the demos:

```
gmake sample1
gmake sample2
gmake sample3
gmake sample4
gmake sample5
gmake sample6
gmake sample7
gmake sample8
gmake sample9
gmake sample10
```

D.2.2.1 Running sample1

`Sample1` is the program that uses the `XMLTransViewer` bean.

You can run the program manually:

```
java XMLTransformPanelSample
```

You can use the program to import and export XML files from Oracle Database, store XSL transformation files in the database, and apply stylesheets to XML interactively. To use the database connectivity feature in this program, you must know the network name of the computer where the database runs, the port (usually 1521), and the name of the Oracle instance (usually `orcl`). You also need an account with `CREATE TABLE` privileges. If you have installed the sample schemas, then you can use the account `hr`. You can use the `XMLTransViewer` program to apply stylesheet transformation to XML files and display the result. The program displays a panel with tabs on the top and the bottom. You can use the first two top tabs to switch between the XML buffer and the XSLT buffer. The third tab performs XSL transformation on the XML buffer and displays the result. You can use the first two tabs on the bottom to load and save data from Oracle Database and from the file system. The remaining bottom tabs switch the display of the current content to tree view, XML source, edit mode and, in case of the result view after the transformation, HTML.

D.2.2.2 Running sample2

`Sample2` is a GUI-based demo for the `XMLSourceView` and `XMLTreeView` beans, which are deprecated. The `ViewSample` program displays the `booklist.xml` file in separate source and tree views.

You can run the program manually:

```
java ViewSample
```

D.2.2.3 Running sample3

Sample3 is a nonvisual demo for the asynchronous `DOMBuilder` and `XSLTransformer` beans. The `AsyncTransformSample` program applies the `doc.xsl` XSLT stylesheet to all `*.xml` files in the current directory. The program writes output to files with the extension `.log`.

You can run the program manually:

```
java AsyncTransformSample
```

D.2.2.4 Running sample4

Sample4 is a visual demo for the `DBViewer` bean, which is deprecated.

It runs in these stages:

1. It starts SQL*Plus, connects to the database with the `USERID` and `PASSWORD` specified in the `Makefile`, and runs the `claim.sql` script. This script creates several tables, views, and types for use by the `DBViewSample` demo program.
2. It runs the `DBViewSample` program:

```
java -classpath "$(MAKE_CLASSPATH)" DBViewSample
```

JDBC connection information is hard-coded in the `DBViewClaims.java` source file, which implements a class used by the demo. Specifically, the program assumes the values for `USERID`, `PASSWORD`, and so forth set in the `Makefile`. If your configuration is different, navigate to line 92 in `DBViewClaims.java` and modify `setUsername()`, `setPassword()`, and so forth with values that reflect your Oracle Database configuration.

D.2.2.5 Running sample5

Sample5 is a nonvisual demo for the `XMLDBAccess` bean. It uses the `XMLType` objects to store XML documents inside the database. The following program connects to the database with the Java thin client, creates `XMLType` tables, and loads the data from `booklist.xml`.

To run the program you must specify these pieces of information as command-line arguments:

- Host name (for example, `myhost`)
- Port number (for example, `1521`)
- SID of the database (for example, `ORCL`)
- Database account in which the tables are created (for example, `hr`)
- Password for the database account (for example, `hr`)

For example, you can run the program:

```
java XMLDBAccessSample myhost 1521 ORCL hr hr
```

The following text shows sample output from `dbaccess.log`:

```

Demo for createXMLTypeTables():
Table +'testxmltype' successfully created.

Demo for listXMLTypeTables():
tablenamename=TESTXMLTYPE

Demo for replaceXMLTypeData() (similar to insert):
XML Data from +'booklist.xml' successfully replaced in table 'testxmltype'.

Demo for getXMLTypeData():
XMLType data fetched:
<?xml version="1.0"?>
<booklist>
  <book isbn="1234-123456-1234">
    <title>C Programming Language</title>
    <author>Kernighan and Ritchie</author>
    <publisher>EEE</publisher>
    <price>7.99</price>
  </book>
  ...
  <book isbn="1230-23498-2349879">
    <title>Emperor's New Mind</title>
    <author>Roger Penrose</author>
    <publisher>Oxford Publishing Company</publisher>
    <price>15.99</price>
  </book>
</booklist>

Demo for getXMLTypeXPathTextData():
Data fetched using XPath exp '/booklist/book[3]':
<book isbn="2137-598354-65978">
  <title>Twelve Red Herrings</title>
  <author>Jeffrey Archer</author>
  <publisher>Harper Collins</publisher>
  <price>12.95</price>
</book>

```

D.2.2.6 Running sample6

The `sample6` program is a visual demo for the `XMLDiff` bean.

The `XMLDiffSample` class invokes a GUI that enables you to choose the input data files from the **File** menu by selecting **Compare XML Files**. The **Transform** menu enables you to apply the generated XSLT generated to the first input XML. Select **Save As** in the **File** menu to save the output XML file, which is the same as the second input file. By default, the program compares `XMLDiffData1.txt` to `XMLDiffData2.txt` and stores the XSLT output as `XMLDiffSample.xsl`.

You can run the program manually:

```
java -mx50m XMLDiffSample XMLDiffData1.txt XMLDiffData2.txt
```

If the input XML files use a DTD that accesses a URL outside a firewall, then modify `XMLDiffSample.java` to include the proxy server settings before the `setFiles()` invocation. For example, modify the program as follows:

```

/* Set proxy to access dtd through firewall */
Properties p = System.getProperties();
p.put("proxyHost", "www.proxyservername.com");
p.put("proxyPort", "80");
p.put("proxySet", "true");
/* You will also have to import java.util.*; */

```

D.2.2.7 Running sample7

The `sample7` visual demo shows the use of the `XMLCompress` bean. Class `compviewer` invokes a GUI that lets the user compress and uncompress XML files and data obtained from the database. The loading options let the user retrieve the data from a file system or a database.

This application does not support loading and saving compressed data from the database. The compression factor indicates a rough estimate by which the XML data is reduced.

You can run the program manually:

```
java compviewer
```

D.2.2.8 Running sample8

The `sample8` demo uses the `XMLTreeView` bean. The `XMLSchemaTreeView` program lets a user view an `XMLDocument` in a tree format. The user can input an XML-schema document and validate an instance document against the schema. If the document is invalid, invalid nodes are highlighted with an error message.

Also, the program displays a log of all the line information in a separate panel, which enables the user to edit the instance document and reevaluated. Test the program with sample files `purchaseorder.xml` and `purchaseorder.xsd`. The instance document `purchaseorder.xml` does not conform to the schema defined in `purchaseorder.xsd`.

You can run the program manually:

```
java XMLSchemaTreeView
```

D.2.2.9 Running sample9

The `sample9` demo uses the `SourceViewer` bean. The `XMLSrcViewer` program lets you view an XML document or a DTD, with syntax highlighting. You can validate the document against an input XML schema or DTD. The DTD can be internal or external.

If the validation is successful, then you can view the instance document and XML schema or DTD in the **Source View** pane. If errors were encountered during schema validation, then an error log with line numbers is available in the **Error** pane. The **Source View** pane shows the XML document with error nodes highlighted. You can use sample files `purchaseorder.xml` and `purchaseorder.xsd` for testing XML schema validation with errors. You can use `note_in_dtd.xml` with DTD validation mode to view an internal DTD with validation errors. You can run the program manually:

```
java XMLSrcViewer
```

D.2.2.10 Running sample10

The `sample10` demo shows the use of the `XSDValidator` bean.

The `XSDValidatorSample` program's two input arguments are an XML document and its associated XML schema. The program displays errors occurring during validation, including line numbers.

The following program uses `purchaseorder.xsd` to validate the contents of `purchaseorder.xml`:

```
java XSDValidatorSample purchaseorder.xml purchaseorder.xsd
```

The XML document fails (intentionally) to validate against the schema. The program displays these errors:

```
Sample purchaseorder.xml purchaseorder.xsd
<Line 2, Column 41>: XML-24523: (Error) Invalid value 'abc' for attribute:
'orderDate'
#document->purchaseOrder
<Line 7, Column 27>: XML-24525: (Error) Invalid text 'CA' in element: 'state'
#document->purchaseOrder->shipTo->state->#text
<Line 8, Column 25>: XML-24525: (Error) Invalid text 'sd' in element: 'zip'
#document->purchaseOrder->shipTo->zip->#text
<Line 14, Column 27>: XML-24525: (Error) Invalid text 'PA' in element: 'state'
#document->purchaseOrder->billTo->state->#text
<Line 17, Column 22>: XML-24534: (Error) Element 'coment' not expected.
#document->purchaseOrder->coment
<Line 29, Column 31>: XML-24534: (Error) Element 'shipDae' not expected.
#document->purchaseOrder->items->item->shipDae
```

D.3 Processing XML with XDK JavaBeans

Topics here include processing XML documents asynchronously using the `DOMBuilder` and `XSLTransformer` beans, and comparing XML documents using the `XmlDiff` bean.

Topics:

- [Processing XML Asynchronously with the DOMBuilder and XSLTransformer Beans](#) (page D-21)
- [Comparing XML Documents with the XMLDiff JavaBean](#) (page D-26)

D.3.1 Processing XML Asynchronously with the DOMBuilder and XSLTransformer Beans

You can use XDK JavaBeans to perform asynchronous XML processing.

This is explained in [XSLTransformer](#) (page D-3).

The `AsyncTransformSample.java` program shows how to use the `DOMBuilder` and `XSLTransformer` beans. The program implements these methods:

- `runDOMBuilders()`
- `runXSLTransformer()`
- `saveResult()`
- `makeXSLDocument()`
- `createURL()`
- `init()`
- `exitWithError()`
- `asyncTransform()`

The basic architecture of the program is:

1. The program declares and initializes the fields used by the class. The input XSLT stylesheet is hard-coded in the program as `doc.xml`. The class defines these fields:

```
String      basedir = new String (".");
OutputStream errors = System.err;
Vector      xmlfiles = new Vector();
int         numXMLDocs = 1;
String      xslFile = new String ("doc.xsl");
URL         xslURL;
XMLDocument xsldoc
```

2. The `main()` method invokes the `init()` method to perform the initial setup. This method lists the files in the current directory, and if it finds files that end in the extension `.xml`, it adds them to a `Vector` object. The implementation for the `init()` method is:

```
boolean init () throws Exception
{
    File    directory = new File (basedir);
    String[] dirfiles = directory.list();
    for (int j = 0; j < dirfiles.length; j++)
    {
        String dirfile = dirfiles[j];

        if (!dirfile.endsWith(".xml"))
            continue;

        xmlfiles.addElement(dirfile);
    }

    if (xmlfiles.isEmpty()) {
        System.out.println("No files in directory were selected for processing");
        return false;
    }
    numXMLDocs = xmlfiles.size();

    return true;
}
```

3. The `main()` method instantiates `AsyncTransformSample`:
4. The `main()` method invokes the `asyncTransform()` method. The `asyncTransform()` method performs these main tasks:

- a. Invokes `makeXSLDocument()` to parse the input XSLT stylesheet.
- b. Invokes `runDOMBuilders()` to initiate parsing of the instance documents, that is, the documents to be transformed, and then transforms them.

After initiating the XML processing, the program resumes control and waits while the processing occurs in the background. When the last request completes, the method exits.

The following code shows the implementation of the `asyncTransform()` method:

```
void asyncTransform () throws Exception
{
    System.err.println (numXMLDocs +
```



```

        " XML documents will be transformed" +
        " using XSLT stylesheet specified in " + xslFile +
        " with " + numXMLDocs + " threads");

    makeXSLDocument ();
    runDOMBuilders ();

    // wait for the last request to complete
    while (rm.activeFound())
        Thread.sleep(100);
}

```

D.3.1.1 Parsing the Input XSLT Stylesheet

Parsing an XSLT stylesheet is described.

Method `makeXSLDocument()` performs a simple DOM parse of a stylesheet. It does not use asynchronous parsing. The technique is the same as that described in [Performing Basic DOM Parsing](#) (page 4-18).

The method follows these steps:

1. Create a new `DOMParser()` object. The following code fragment from `DOMSample.java` shows this technique:

```
DOMParser parser = new DOMParser();
```

2. Configure the parser. The following code fragment specifies that white space must be preserved:

```
parser.setPreserveWhitespace(true);
```

3. Create a URL object from the input stylesheet. The following code fragment invokes the `createURL()` helper method to accomplish this task:

```
xslURL = createURL (xslFile);
```

4. Parse the input XSLT stylesheet. The following statement shows this technique:

```
parser.parse (xslURL);
```

5. Get a handle to the root of the in-memory DOM tree. You can use the `XMLDocument` object to access every part of the parsed XML document. The following statement shows this technique:

```
xslDoc = parser.getDocument();
```

D.3.1.2 Processing the XML Documents Asynchronously

Method `runDOMBuilders()` shows how you can use the `DOMBuilder` and `XSLTransformer` beans to perform asynchronous processing. The parsing and transforming of the XML data occurs in the background.

The method follows these steps:

1. Create a resource manager to manage the input XML documents. The program creates a `for` loop and gets the XML documents. The following code fragment shows this technique:

```

rm = new ResourceManager (numXMLDocs);
for (int i = 0; i < numXMLDocs; i++)
{
    rm.getResource();
}

```

```
    ...  
}
```

2. Instantiate the DOM builder bean for each input XML document. For example:

```
DOMBuilder builder = new DOMBuilder(i);
```

3. Create a URL object from the XML file name. For example:

```
DOMBuilder builder = new DOMBuilder(i);  
URL xmlURL = createURL(basedir + "/" + (String)xmlfiles.elementAt(i));  
if (xmlURL == null)  
    exitWithError("File " + (String)xmlfiles.elementAt(i) + " not found");
```

4. Configure the DOM builder. The following code fragment specifies the preservation of white space and sets the base URL for the document:

```
builder.setPreserveWhitespace(true);  
builder.setBaseURL (createURL(basedir + "/"));
```

5. Add the listener for the DOM builder. The program adds the listener by invoking `addDOMBuilderListener()`.

The class instantiated to create the listener must implement the `DOMBuilderListener` interface. The program provides a do-nothing implementation for `domBuilderStarted()` and `domBuilderError()`, but must provide a substantive implementation for `domBuilderOver()`, which is the method called when the parse of the XML document completes. The method invokes `runXSLTransformer()`, which is the method that transforms the XML. See [Transforming the XML with the XSLTransformer Bean](#) (page D-25) for an explanation of this method.

The following code fragment shows how to add the listener:

```
builder.addDOMBuilderListener  
(  
    new DOMBuilderListener()  
    {  
        public void domBuilderStarted(DOMBuilderEvent p0) {}  
        public void domBuilderError(DOMBuilderEvent p0) {}  
        public synchronized void domBuilderOver(DOMBuilderEvent p0)  
        {  
            DOMBuilder bld = (DOMBuilder)p0.getSource();  
            runXSLTransformer (bld.getDocument(), bld.getId());  
        }  
    }  
);
```

6. Add the error listener for the DOM builder. The program adds the listener by invoking `addDOMBuilderErrorListener()`.

The class instantiated to create the listener must implement the `DOMBuilderErrorListener` interface. The following code fragment show the implementation:

```
builder.addDOMBuilderErrorListener  
(  
    new DOMBuilderErrorListener()  
    {  
        public void domBuilderErrorCalled(DOMBuilderErrorEvent p0)  
        {  
            int id = ((DOMBuilder)p0.getSource()).getId();
```

```

        exitWithError("Error occurred while parsing " +
            xmlfiles.elementAt(id) + ": " +
            p0.getException().getMessage());
    }
}
);

```

7. Parse the document. The following statement shows this technique:

```

builder.parse (xmlURL);
System.err.println("Parsing file " + xmlfiles.elementAt(i));

```

D.3.1.2.1 Transforming the XML with the XSLTransformer Bean

When a DOM parse completes, the DOM listener receives notification. Method `domBuilderOver()` implements response behavior for this event. The program passes the DOM to method `runXSLTransformer()`, which initiates XSL transformation.

The method follows these steps:

1. Instantiate the `XSLTransformer` bean. This object performs the XSLT processing. The following statement shows this technique:

```

XSLTransformer processor = new XSLTransformer (id);

```

2. Create a new stylesheet object. For example:

```

XSLStylesheet xsl = new XSLStylesheet (xslDoc, xslURL);

```

3. Configure the XSLT processor. For example, this statement sets the processor to show warnings and configures the error output stream:

```

processor.showWarnings (true);
processor.setErrorStream (errors);

```

4. Add the listener for the XSLT processor. The program adds the listener by invoking `addXSLTransformerListener()`.

The class instantiated to create the listener must implement the `XSLTransformerListener` interface. The program provides a do-nothing implementation for `xslTransformerStarted()` and `xslTransformerError()`, but must provide a substantive implementation for `xslTransformerOver()`, which is the method called when the parse of the XML document completes. The method invokes `saveResult()`, which prints the transformation result to a file.

The following code fragment shows how to add the listener:

```

processor.addXSLTransformerListener
(
    new XSLTransformerListener()
    {
        public void xslTransformerStarted (XSLTransformerEvent p0) {}
        public void xslTransformerError(XSLTransformerEvent p0) {}
        public void xslTransformerOver (XSLTransformerEvent p0)
        {
            XSLTransformer trans = (XSLTransformer)p0.getSource();
            saveResult (trans.getResult(), trans.getId());
        }
    }
);

```

5. Add the error listener for the XSLT processor. The program adds the listener by invoking `addXSLTransformerErrorListener()`.

The class instantiated to create the listener must implement the `XSLTransformerErrorListener` interface. The following code fragment shows the implementation:

```
processor.addXSLTransformerErrorListener
(
    new XSLTransformerErrorListener()
    {
        public void xslTransformerErrorCalled(XSLTransformerErrorEvent p0)
        {
            int i = ((XSLTransformer)p0.getSource()).getId();
            exitWithError("Error occurred while processing " +
                xmlfiles.elementAt(i) + ": " +
                p0.getException().getMessage());
        }
    }
);
```

6. Transform the XML document with the XSLT stylesheet. The following statement shows this technique:

```
processor.processXSL (xsl, xml);
```

D.3.2 Comparing XML Documents with the XMLDiff JavaBean

You can use XDK JavaBeans to compare the structure and significant content of XML documents.

This is explained in [XMLDiff](#) (page D-4),

The `XMLDiffSample.java` program shows how to use the `XMLDiff` bean. The program implements these methods:

- `showDiffs()`
- `doXSLTransform()`
- `createUrl()`

The basic architecture of the program is:

1. The program declares and initializes the fields used by the class. One field is of type `XMLDiffFrame`, which is the class implemented in the `XMLDiffFrame.java` demo. The class defines these fields:

```
protected XMLDocument doc1; /* DOM tree for first file */
protected XMLDocument doc2; /* DOM tree for second file */
protected static XMLDiffFrame diffFrame; /* GUI frame */
protected static XMLDiffSample dfxApp; /* XMLDiff sample application */
protected static XMLDiff xmlDiff; /* XML diff object */
protected static XMLDocument xslDoc; /* parsed xsl file */
protected static String outFile = new String("XMLDiffSample.xml"); /* output
                                                                    xsl file name */
```

2. The `main()` method creates an `XMLDiffSample` object:

```
dfxApp = new XMLDiffSample();
```

3. The `main()` method adds and initializes a `JFrame` to display the output of the comparison. The following code shows this technique:

```
diffFrame = new XMLDiffFrame(dfxApp);
diffFrame.addTransformMenu();
```

4. The `main()` method instantiates the `XMLDiff` bean. The following code shows this technique:

```
xmlDiff = new XMLDiff();
```

5. The `main()` method invokes the `showDiffs()` method. This method performs these tasks:

- a. Invokes `XMLDiff.diff()` to compare the input XML documents.
- b. Generates and displays an XSLT stylesheet that can transform one input document into the other document.

The following code fragment shows the `showDiffs()` method invocation:

```
if (args.length == 3)
    outFile = args[2];
if (args.length >= 2)
    dfxApp.showDiffs(new File(args[0]), new File(args[1]));
diffFrame.setVisible(true);
```

D.3.2.1 Comparing the XML Files and Generating a Stylesheet

Method `showDiffs()` shows the use of the `XMLDiff` bean.

The method follows these steps:

1. Set the files for the `XMLDiff` processor. The following statement shows this technique:

```
xmlDiff.setFiles(file1, file2);
```

2. Compare the files. The `diff()` method returns a boolean value that indicates whether the input documents have identical structure and content. If they are equivalent, then the method prints a message to the `JFrame` implemented by the `XMLDiffFrame` class. The following code fragment shows this technique:

```
if(!xmlDiff.diff())
{
    JOptionPane.showMessageDialog
    (
        diffFrame,
        "Files are equivalent in XML representation",
        "XMLDiffSample Message",
        JOptionPane.PLAIN_MESSAGE
    );
}
```

3. Generate a DOM for the XSLT stylesheet that shows the differences between the two documents. The following code fragment shows this technique:

```
xslDoc = xmlDiff.generateXSLDoc();
```

4. Display the documents in the `JFrame` implemented by `XMLDiffFrame`. `XMLDiffFrame` instantiates the `XMLSourceView` bean, which is deprecated. The method follows these steps:

- a. Create the source pane for the input documents. Pass the DOM handles of the two documents to the `diffFrame` object to make the source pane:

```
diffFrame.makeSrcPane(xmlDiff.getDocument1(), xmlDiff.getDocument2());
```

- b. Create the pane that shows the differences between the documents. Pass references to the text panes to `diffFrame`:

```
diffFrame.makeDiffSrcPane(new XMLDiffSrcView(xmlDiff.getDiffPane1()),  
                           new XMLDiffSrcView(xmlDiff.getDiffPane2()));
```

- c. Create the pane for the XSLT stylesheet. Pass the DOM of the stylesheet:

```
diffFrame.makeXslPane(xslDoc, "Diff XSL Script");  
diffFrame.makeXslTabbedPane();
```

Glossary

attribute

A property of an element that consists of a name and a value separated by an equal sign and contained within the start-tags after the element name.

In this example, `<Price units='USD'>5</Price>`, `units` is the attribute and `USD` is its value, which must be in single or double quotation marks. Attributes can reside in the document or document type definition (DTD). Elements may have many attributes but their retrieval order is not defined.

binary XML

An Extensible Markup Language (XML) representation that uses a compact, XML schema-aware format.

callback

A programmatic technique in which one process starts another and then continues. The second process then invokes the first as a result of an action, value, or other event. This technique is used in most programs that have a user interface to allow continuous interaction.

cartridge

A stored program in Java or Procedural Language/Structured Query Language (PL/SQL) that adds the necessary functionality for the database to understand and manipulate a new data type.

Cartridges interface through the Extensibility Framework within the Oracle XML Developer's Kit (XDK) implementation of the Java Architecture for XML Binding (JAXB) specification version 8 or later. Oracle Text is such a cartridge, adding support for reading, writing, and searching text documents stored within the database.

See also [Oracle Text](#).

Cascading Style Sheets (CSS)

See [CSS](#).

CDATA

Character data. Text in a document that must not be parsed is included within a CDATA section. This allows for the inclusion of characters that would otherwise have

special functions, such as `&`, `<`, and `>`. CDATA sections can be used in the content of an element or in attributes.

character data (CDATA)

See [CDATA](#).

child element

An element that is wholly contained within another, which is referred to as its parent element. For example `<Parent><Child></Child></Parent>` shows a child element nested within its parent element.

See also [parent element](#).

class generator

A class generator accepts an input file and creates a set of output classes that have corresponding functionality. For the XML class generator, the input file is a DTD or XML schema, and the output is a series of classes that can be used to create conforming XML documents.

CLASSPATH

The operating system environment variable that the Java virtual machine (JVM) uses to find the classes required to run applications.

Common Oracle Runtime Environment (CORE)

See [CORE](#).

CORE

Common Oracle Runtime Environment. The library of functions written in C that enables developers to create code that can be easily ported to virtually any platform and operating system.

CSS

Cascading Style Sheets. A simple mechanism for adding style (fonts, colors, spacing, and so on) to web documents.

data definition language (DDL)

See [DDL](#).

datagram

A text fragment, possibly in XML format, that is returned to the requester embedded in an HTML page from a SQL query processed by the XSQL servlet.

DDL

Data definition language. Statements that define or change a data structure.

DOCTYPE

The term used as the tag name designating the DTD or its reference within an XML document. For example, `<!DOCTYPE person SYSTEM "person.dtd">` declares the root element name as `person` and an external DTD as `person.dtd` in the file system. Internal DTDs are declared within the DOCTYPE declaration.

Document Object Model (DOM)

See [DOM](#).

document type definition (DTD)

See [DTD](#).

DOM

Document Object Model. An in-memory, tree-based object representation of an XML document that enables programmatic access to its elements and attributes.

The Document Object Model (DOM) object and its interface is a World Wide Web Consortium (W3C) recommendation that specifies the DOM of an XML document, including the application programming interfaces (APIs) for programmatic access. DOM views the parsed document as a tree of objects.

DTD

Document type definition. A set of rules that defines the valid structure of an XML document. DTDs are text files that derive their format from SGML. A DTD can be included in an XML document by using the DOCTYPE element or by using an external file through a DOCTYPE reference.

See Also:

- [XML](#)
 - [SGML](#)
 - [WML](#)
-
-

element

The basic logical unit of an XML document that can serve as a container for other elements, such as children, data, attributes, and their values. Elements are identified by start-tags, such as `<name>`, and end-tags, such as `</name>`, or for empty elements, `<name/>`.

empty element

An element without text content or child elements. It can contain only attributes and their values. Empty elements are of the form `<name/>` or `<name></name>`, where there is no space between the tags.

entity

A string of characters that can represent either another string of characters or special characters that are not part of the document character set. Entities and the text that is substituted for them by the parser are declared in the DTD.

epilog

The closing part of an XML document. The epilog is optional.

Extensible Markup Language (XML)

See [XML](#).

Extensible Stylesheet Language (XSL)

See [XSL](#).

Extensible Stylesheet Language Formatting Objects (XSL-FO)

See [XSL-FO](#).

Extensible Stylesheet Language Transformations (XSLT)

See [XSLT](#).

FOP

Formatting Objects Processor: a print formatter driven by XSL-FO. FOP is a Java application that reads a formatting object tree and renders the resulting pages. The supported output are PDF, PCL, PS, SVG, XML (area tree representation), print, AWT, MIF, and TXT. The primary output target is PDF.

Formatting Objects Processor (FOP)

See [FOP](#).

HTTP

Hypertext Transport Protocol. The set of rules for exchanging files on the World Wide Web. Relative to the TCP/IP suite of protocols, HTTP is an application protocol.

HTTPS

Hypertext Transport Protocol, Secure. The use of Secure Sockets Layer (SSL) as a sublayer under the regular HTTP application layer.

Hypertext Transport Protocol (HTTP)

See [HTTP](#).

Hypertext Transport Protocol, Secure (HTTPS)

See [HTTPS](#).

IDE

Integrated Development Environment. A set of programs designed to aid in the development of software run from a user interface. Oracle JDeveloper is an IDE for Java development that includes an editor, a compiler, a debugger, a syntax checker, and a help system.

infoset

XML Information Set, an abstract data set consisting of several information items. It has at least one information item: the document node, but the infoset is not necessarily valid XML.

The W3C recommendation is at <http://www.w3.org/TR/xml-infoset/>.

instance document

An XML document validated against an XML schema. If the instance document conforms to the rules of the schema, it is said to be valid.

instantiate

A term used in object-based languages, such as Java and C++, to refer to the creation of an object of a specific class.

Integrated Development Environment (IDE)

See [IDE](#).

Java EE

Java Platform, Enterprise Edition. The Java platform that defines multitier enterprise computing.

Java

A high-level programming language where applications run in a virtual machine known as a Java Virtual Machine (JVM). The JVM is responsible for all interfaces to the operating system. This architecture lets developers create Java applications that can run on any operating system or platform that has a JVM.

See Also:

[JVM](#).

Java Platform, Enterprise Edition (Java EE)

See [Java EE](#).

Java API for XML Processing (JAXP)

See [JAXP](#)

Java Architecture for XML Binding (JAXB)

See [JAXB](#).

Java Database Connectivity (JDBC)

See [JDBC](#).

Java Developer's Kit (JDK)

See [JDK](#).

Java Naming and Directory Interface (JNDI)

See [JNDI](#).

Java Specification Request (JSR)

See [JSR](#).

Java Virtual Machine (JVM)

See [JVM](#).

JavaBeans

An independent program module that runs within a Java Virtual Machine (JVM). It is typically used to create user interfaces on a client.

See Also:

[JVM](#)

JAXB

Java Architecture for XML Binding. An API and tools that map to and from XML documents and Java objects. JAXB is a JSR-31 recommendation.

JAXP

Java API for XML Processing. A programming tool that enables applications to parse and transform XML documents using an API that is independent of a particular XML processor implementation.

JDBC

Java Database Connectivity. The programming API that enables Java applications to access a database through SQL. JDBC drivers are written in Java for platform independence, but are specific to each database.

JDK

Java Developer's Kit. The collection of Java classes, runtime, compiler, debugger, and usually source code for a version of Java that makes up a Java development environment. JDKs are designated by versions.

JNDI

Java Naming and Directory Interface. A programming interface for connecting Java programs to naming and directory services such as DNS, LDAP, and NDS.

JSR

Java Specification Request. A recommendation of the Java Community Process organization (JCP), such as JAXB and XQJ.

JVM

Java Virtual Machine. The Java interpreter that converts the compiled Java bytecode into the machine language of the platform and runs it. JVMs can run on a client, in a browser, in a middle tier, on an intranet, on an application server, or on a database server.

listener

A separate application process that monitors the input process.

marshalling

The process of traversing a Java content tree and writing an XML document that reflects the content of the tree. It is the inverse of unmarshalling.

See also [unmarshalling](#).

node

In XML, the term used to denote each addressable entity in a DOM tree.

notation attribute declaration

In XML, the declaration of a content type that is not part of those understood by the parser. These types include audio, video, and other multimedia.

OASIS

Organization for the Advancement of Structured Information Standards. An organization whose members are chartered with promoting public information standards through conferences, seminars, exhibits, and other educational events. XML and SGML are standards that OASIS is actively promoting.

See Also:

- [SGML](#)
 - [XML](#)
-

Oracle JDeveloper

Oracle JDeveloper is a Java IDE that enables application, applet, and servlet development and includes an editor, compiler, debugger, syntax checker, help system, integrated UML class modeler, and more. It supports XML-based development by including the XDK for Java components in its editor.

Oracle Text

An Oracle tool that provides full-text indexing of documents and the capability to do SQL queries over documents, along with XPath-like searching.

Oracle WebLogic Server

A product that integrates all the core services and features required for building, deploying, and managing high-performance, n-tier, transaction-oriented web applications within an open standards framework.

XDK

Oracle XML Developer's Kit. The set of libraries, components, and utilities that provide software developers with the standards-based functionality to XML-enable their applications. In the Java components of XDK, the kit contains an XML parser, an XSLT processor, the XML class generator, the JavaBeans, and the XSQL servlet.

Oracle XML DB

A high-performance XML storage and retrieval technology provided with Oracle Database. It is based on the W3C XML data model.

Oracle XML Developer's Kit (XDK)

See [XDK](#).

ORACLE_HOME

The operating system environment variable that identifies the location for the installation of Oracle components.

Organization for the Advancement of Structured Information Standards (OASIS)

See [OASIS](#).

parent element

An element that surrounds another element, which is referred to as its child element. For example, `<Parent><Child></Child></Parent>` shows a parent element wrapping its child element.

See Also:

[child element](#)

parsed character data (PCDATA)

See [PCDATA](#).

path name

The name of a resource that reflects its location in the repository hierarchy.

A path name is composed of a root element (the first /), element separators (/), and various subelements (or path elements). A path element can be composed of any character in the database character set except the slash (/) or the backslash (\). These characters have a special meaning for Oracle XML DB. The slash is the default name separator in a path name; the backslash can be used to escape characters.

PCDATA

Parsed character data. The element content consisting of text that must be parsed but is not part of a tag or nonparsed data.

See also [tag](#).

prolog

The opening part of an XML document containing the XML declaration and any DTD or other declarations needed to process the document. The prolog is optional.

repository

The set of database objects, in any schema, that are mapped to path names. There is one root to the repository (/), which contains a set of resources, each with a path name.

See Also:

[path name](#)

resource

An object in the repository hierarchy.

resource name

The name of a resource within its parent folder. Resource names must be unique (potentially subject to case-insensitivity) within a folder. Resource names are always in the UTF-8 character set (NVARCHAR2).

result set

The output of a SQL query consisting of one or more rows of data.

root element

The element that encloses all the other elements in an XML document and is between the optional prolog and epilog. An XML document is permitted to have only one root element.

See Also:

- [prolog](#)
 - [epilog](#)
-

SAX

Simple API for XML. An XML standard interface provided by XML parsers and used by event-based applications.

schema

The definition of the structure and data types within a database. It can also refer to an XML document that supports the XML Schema W3C recommendation.

servlet

A Java application that runs in a server, typically a web server or an application server, and performs processing on that server. Servlets are the Java equivalent to CGI scripts.

SGML

Standard Generalized Markup Language. An ISO standard for defining the format of a text document implemented using markup and DTDs.

Simple API for XML (SAX)

See [SAX](#).

Simple Object Access Protocol (SOAP)

See [SOAP](#).

SOAP

Simple Object Access Protocol. An XML-based protocol for exchanging information in a decentralized, distributed environment.

SQL

Structured Query Language. The standard language used to access and process data in a relational database.

SQL/XML

An ANSI specification for representing XML in SQL. Oracle SQL includes SQL/XML functions that query XML: ANSI/ISO/IEC 9075-14:2011, Information technology—Database languages—SQL—Part 14: XML-Related Specifications (SQL/XML).

Standard Generalized Markup Language (SGML)

See [SGML](#).

StAX

Streaming API for XML.

Streaming API for XML (StAX)

See [StAX](#).

Structured Query Language (SQL)

See [SQL](#).

stylesheet

An XML document that consists of XSL processing instructions used by an XSLT processor to transform or format an input XML document into an output XML document.

tag

A single piece of XML markup that delimits the start or end of an element. Tags start with `<` and end with `>`. XML includes start-tags (`<name>`), end-tags (`</name>`), and empty tags (`<name />`), where *name* is the tag name.

TransX Utility

A Java API that simplifies the loading of translated seed data and messages into a database.

Uniform Resource Identifier (URI)

See [URI](#).

Uniform Resource Locator (URL)

See [URL](#).

unmarshalling

The process of reading an XML document and constructing a tree of Java content objects. Each content object corresponds directly to an instance in the input document of the corresponding schema component.

See also [marshalling](#).

URI

Uniform Resource Identifier. The address syntax that is used to create URLs and XPath's.

URL

Uniform Resource Locator. The address that defines the location and route to a file on the Internet. URLs are used by browsers to navigate the World Wide Web and consist of a protocol prefix, port number, domain name, directory and subdirectory names, and a file name.

valid

The term used to refer to an XML document when its structure and element content is consistent with that declared in its associated DTD or XML schema.

W3C

World Wide Web Consortium. An international industry consortium started in 1994 to develop standards for the World Wide Web. The W3C Web site is located at <http://www.w3c.org>.

See also [WWW](#).

well-formed

An XML document that conforms to the syntax of the XML version declared in its XML declaration. This includes having a single root element and properly nested tags.

Wireless Markup Language (WML)

See [WML](#).

WML

Wireless Markup Language. A tag-based markup language developed for the small display size, reduced memory, and limited processing power of cell phones and other devices that implement the Wireless Application Protocol (WAP) specification. WML documents are XML documents that validate against the WML DTD.

See also [DTD](#).

Working Group (WG)

A W3C committee that is made up of industry members who implement the recommendation process in specific Internet technology areas.

World Wide Web (WWW)

See [WWW](#).

See also [W3C](#).

World Wide Web Consortium (W3C)

See [W3C](#).

See also [WWW](#).

WWW

World Wide Web. A worldwide hypertext system that uses the Internet and the HTTP protocol.

See also [W3C](#).

XDM

The W3C XQuery 1.0 and XPath 2.0 Data Model. A query data model that supports the most XQuery features. The main exceptions are the query prolog, element and attribute constructors, full FLWOR syntax, and the typeswitch expression.

XLink

XML Linking Language. It consists of rules that govern the use of hyperlinks in XML documents. The rules are defined by the XML Linking Group, under the W3C recommendation process. This is one of the three languages (XLink, XPointer, and XPath) that XML supports to manage document presentation and hyperlinks.

See Also:

- [XPath](#)
 - [XPointer](#)
-
-

XML

Extensible Markup Language. An open standard for describing data developed by the World Wide Web Consortium (W3C) using a subset of the SGML syntax and designed for Internet use.

See Also:

- [SGML](#)
 - [W3C](#)
-
-

XML Base

A W3C recommendation that describes the use of the `xml:base` attribute, which can be inserted in an XML document to specify a base URI other than the base URI of the document or external entity. The URIs in the document are resolved by the given base.

XML Information Set

See [infoset](#).

XML Linking Language (XLink)

See [XLink](#).

XML Namespaces

Related element names or attributes within an XML document. Namespace syntax and usage are defined by a W3C recommendation. For example, element `<xsl:apply-templates/>` is identified as part of the XSL namespace. Namespaces are declared in an XML document or a DTD before they are used, using this attribute syntax:
`xmlns:xsl="http://www.w3.org/TR/WD-xsl"`.

XML parser

A software program that receives an XML document and determines whether it is well-formed and, optionally, valid. The Oracle XML parser supports both SAX and DOM interfaces.

See Also:

[well-formed](#)

XML Path Language (XPath)

See [XPath](#).

XML Pipeline Definition Language

A W3C recommendation that enables you to describe the processing relations between XML resources.

XML Pointer Language (XPointer)

See [XPointer](#).

XML processor

A software program that reads an XML document and processes it, that is, performs actions on the document based on a set of rules. Validity checkers and XML editors are examples of processors.

XML Query (XQuery)

See [XQuery](#).

XML schema

A document written in the XML Schema language.

XML Schema

See [XML Schema language](#).

XML Schema Definition

Equivalent to XML Schema language.

XML Schema language

The XML Schema language, also called XML Schema, is a W3C recommendation for the use of simple data types and complex structures within an XML document. It addresses areas currently lacking in DTDs, including the definition and validation of data types.

XML Schema processor

A software program that automatically ensures the validity of XML documents and data used in e-business applications, including online exchanges. It adds simple and complex data types to XML documents, and replaces DTD functionality with an XML schema definition XML document.

XMLSchema-instance namespace

The namespace declaration attribute used to identify an instance document as a member of the class defined by a particular XML schema. You must declare the XMLSchema-instance namespace by adding a namespace declaration to the root element of the instance document. For example: `xmlns:xsi=http://www.w3.org/2001/XMLSchema-instance`.

XML SQL Utility (XSU)

See [XSU](#).

XMLType

An Oracle data type that stores XML data using object-relational columns or a binary format within a table or view.

XMLType views

A mechanism provided by Oracle XML DB to wrap existing relational and object-relational data in XML format. This is especially useful if, for example, your legacy data is not in XML but you must migrate it to an XML format.

XPath

XML Path Language. The open standard syntax for addressing elements within a document used by XSL and XPointer. XPath is a W3C recommendation. It specifies the data model and grammar for navigating an XML document used by XSLT, XLink, and XML Query.

See Also:

- [XLink](#)
 - [XPointer](#)
 - [XQuery](#)
-
-

XPointer

XML Pointer Language. The term and W3C recommendation to describe a reference to an XML document fragment. An XPointer can be used at the end of an XPath-formatted URI. It specifies the identification of individual entities or fragments within an XML document using XPath navigation.

See Also:

- [XLink](#)
 - [XPath](#)
-

XQJ

XQuery API for Java.

XQ SX

XQuery Scripting Extension.

XQuery

XML Query. The ongoing effort of W3C to create a standard for the language and syntax to query XML documents.

XQueryX

XML Syntax for XQuery. XQueryX is an XML representation of an XQuery. See JSR 225.

XQUF

XQuery Update Facility.

XQVM

Oracle XQuery Virtual Machine.

XSL

Extensible Stylesheet Language. The language used within stylesheets to transform or render XML documents. Two W3C recommendations cover XSL stylesheets: XSL Transformations (XSLT) and XSL Formatting Objects (XSL-FO).

- XSLT is a language for transforming one XML document into another.
- XSL-FO is an XML vocabulary for specifying the presentation of an XML document.

An XSL stylesheet specifies the presentation of a class of XML documents by describing how an instance of the class is transformed into an XML document that uses the formatting vocabulary.

See Also:

- [XSLT](#)
 - [XSL-FO](#)
-

XSL-FO

XSL Formatting Objects. Also known as Extensible Stylesheet Language Formatting Objects, and XSLFO. The W3C standard specification that defines an XML vocabulary for specifying formatting semantics.

See Also:

[FOP](#).

XSL Formatting Objects (XSL-FO)

See [XSL-FO](#).

XSL Transformations (XSLT)

See [XSLT](#).

XSLT

Extensible Stylesheet Language Transformations. Also known as XSL-T. The XSL W3C standard specification that defines a transformation language to convert one XML document into another.

XSLT Virtual Machine (XVM)

Also XSLT VM. See [XVM](#).

XSLTVM

Also XSLT VM. See [XVM](#).

XSQL pages

XML pages that contain instructions for the XSQL servlet.

XSQL pages publishing framework

See [XSQL servlet](#).

XSQL servlet

A Java-based servlet that can dynamically generate XML documents from one or more SQL queries and optionally transform the documents in the server with an XSLT stylesheet.

XSU

XML SQL Utility. An Oracle utility that can generate an XML document (string or DOM) when given a SQL query or a JDBC `ResultSet` object. XSU can also extract the data from an XML document, and then insert, update, or delete rows in a database table.

XVM

XSLT Virtual Machine. Also known as XSLTVM and XSLT VM. The Oracle XSLT Virtual Machine is the software implementation of a CPU designed to run compiled XSLT code. The virtual machine concept assumes a compiler compiling XSLT stylesheets to a program of bytecodes, or machine instructions for the XSLT CPU.

Symbols

.NET, [1-17](#)

B

binary XML

C, [21-1](#)

decoding, [5-5](#)

encoding, [5-4](#)

Java, [5-1](#)

models for using, [5-2](#)

saving text as, [4-23](#)

storage format, [5-1](#)

terminology, [5-2](#)

using Java, [5-6](#)

vocabulary management, [5-5](#)

binary XML decoder, [5-8](#)

binary XML encoder, [5-7](#)

Built-in Action Handler, [17-22](#)

Built-in Action Handler, XSQL, [17-22](#)

C

C API, [18-12](#)

C compile-time environment on UNIX

setting up, [18-5](#)

C components

demos, [18-1](#), [19-7](#), [20-7](#), [22-4](#)

directory structure, [18-1](#)

globalization support, [18-13](#)

installation, [18-1](#)

runtime environment on Windows, [18-7](#)

samples, [18-1](#), [19-7](#), [20-7](#), [22-4](#)

setting up Windows environment, [18-6](#)

setting up Windows environment variables, [18-7](#)

with Visual C/C++ on Windows, [18-9](#)

C environment variables on UNIX, [18-4](#)

C libraries

contents, [18-3](#)

C runtime environment on UNIX, [18-4](#)

C++ class generator, [1-6](#)

C++ interface, [26-2](#)

Class Generator

XML C++, [31-1](#)

CLASSPATH

XSQL Pages, [16-6](#)

CLASSPATH environment variable

for XQJ, [8-2](#)

command-line interface

oraxml, [4-15](#), [10-9](#)

Connection Definitions, [16-7](#)

context, creating one in XSU PL/SQL API, [13-40](#)

custom connection manager, [17-27](#)

custom entity resolver

example, [7-3](#)

D

Data Provider for .NET, [1-17](#)

data variables into XML, [4-53](#)

DB Access JavaBean, [D-3](#)

DBMS_XMLQuery

getXMLClob, [13-6](#)

DBMS_XMLQuery(), [13-6](#)

DBMS_XMLSave, [13-7](#)

DBMS_XMLSave(), [13-7](#)

decoding binary XML, [5-5](#)

Default SQL to XML Mapping, [13-41](#)

demos

C components, [18-1](#), [19-7](#), [20-7](#), [22-4](#)

directory structure

C, [18-1](#)

document creation Java APIs, [2-4](#)

DOM

creating in Java, [4-1](#)

specifications, [33-3](#)

DOMBuilder Bean, [D-3](#)

DTDs

external, [4-54](#)

E

encoding binary XML, [5-4](#)

entity resolver

other entity types, [7-13](#)

entity resolver framework, [7-2](#)
error messages
 DLF, [B-1](#)
 DML, [C-3](#)
 DOM, [A-12](#)
 generic, [C-1](#)
 JAXB, [A-53](#)
 query, [C-2](#)
 schema component constraint, [A-41](#)
 schema representation constraint, [A-35](#)
 TransX, [B-3](#)
 XML parser, [A-1](#)
 XML pipeline, [A-51](#)
 XML schema validation, [A-25](#)
 XPath, [A-20](#)
 XSL transformation, [A-16](#)
 XSQL server pages, [A-50](#)
examples of document creation in Java, [2-4](#)
external storage
 example, [7-17](#)

F

FileReader not for system files, [4-57](#)
FOP
 serializer, [16-8](#)
 serializer to produce PDF, [17-17](#)

G

generated XML
 customizing, [13-44](#)
generating XML
 using DBMS_XMLQuery, [13-6](#)
 using XSU command line, getXML, [13-18](#)
getXML, [13-18](#)
getXMLClob, [13-6](#)
globalization support
 for the C components, [18-13](#)

H

HTML Form Parameters, [16-27](#)
HTTP Parameters, [16-26](#)
HTTP POST method, [16-31](#)

I

informational messages
 TransX, [B-3](#)
insert, XSU, [13-47](#)
installation
 C components, [18-1](#)
invalid characters, [4-60](#)

J

JAR files, DTDs, [4-54](#)
Java classes deprecated, [2-2](#)
Java components
 creating a DOM, [4-1](#)
 environment in Windows, [3-7](#)
 installation, [3-1](#)
 parsing, [4-1](#)
Java diff operations
 append-node, [12-4](#)
 delete-node, [12-6](#)
 examples, [12-7](#)
 insert-node-before, [12-5](#)
Java diff output schema
 xdiff.xsd, [12-10](#)
Java Specification Request
 225, [8-1](#), [8-7](#)
Java XML diffing library, [12-1](#)
JAXB
 class generator, [1-6](#)
 compared with JAXP, [10-1](#), [10-4](#)
 features not supported, [10-11](#)
 marshalling and unmarshalling, [10-1](#)
 validating, [10-1](#)
 what is, [10-4](#)
JAXP
 compared with JAXB, [10-1](#)
JAXP (Java API for XML Processing), [4-44](#)
JCR 1.0 standard, [4-2](#)
JDBC driver, [13-3](#)
JSR 170 standard, [4-2](#)
JSR-225, [8-1](#), [8-7](#)

M

make.bat file
 editing on Window for C environment, [18-8](#)
mapping
 primer, XSU, [13-41](#)
messages
 assertion, [B-4](#)
Microsoft .NET, [1-17](#)

N

no rows exception, [13-32](#)

O

OCI and the XDK for C, [20-21](#)
OCI examples, [20-23](#)
Oracle JDeveloper, [1-15](#)
Oracle JVM, [4-12](#)
Oracle XML Developer's Kit components, [1-1](#)
Oracle XML Developer's Kit version
 using C, [18-6](#)

Oracle XML Developer's Kit version (*continued*)

using C++, [25-3](#)

using Java, [3-9](#)

oracle.xml.diff package, [12-1](#)

OracleXml namespace, [26-2](#)

orastream functions, [20-13](#)

oraxml, [4-15](#), [10-9](#)

oraxsl

command-line interfaces, [6-6](#)

Out Variable, using xsql

dml, [16-28](#)

P

Package Classes, [2-2](#)

Parser for Java

constructor extension functions, [6-13](#)

oraxsl, [6-6](#)

return value extension function, [6-13](#)

static and nonstatic methods, [6-12](#)

supported database, [4-12](#)

using DTDs, [4-54](#)

Parser for Java, overview, [4-12](#)

PDF results using FOP, [16-8](#)

Pipeline Definition Language, [11-1](#)

PL/SQL

generating XML with DBMS_XMLQuery, [13-6](#)

S

samples

C components, [18-1](#), [19-7](#), [20-7](#), [22-4](#)

security, XSQL Pages, [16-31](#)

select

with XSU, [13-47](#)

servlet, XSQL, [16-1](#), [17-1](#)

SOAP

C clients, [24-4](#)

C examples, [24-7](#)

C Functions, [24-5](#)

for C, [24-1](#)

server, [24-5](#)

what is, [24-2](#)

static context

default initial values, [7-30](#)

storing XML in the database, [13-7](#)

streaming evaluation

example, [7-15](#)

streaming validator

opaque mode, [22-7](#)

transparent mode, [22-5](#)

string data, [4-60](#)

T

text node normalization, [12-2](#)

TransX Utility, [14-1](#)

U

Unicode in a system file, [4-57](#)

unified C API for XDK and Oracle XML DB, [18-12](#)

unified Java API, [2-1](#)

Unified Java API, [2-1](#)

Unified Java API new objects and methods, [2-4](#)

UNIX environment for C components

configuring, [18-2](#)

update, XSU, [13-47](#)

updating queries, [7-19](#)

updating query

example, [7-19](#)

UTF-16 Encoding, [4-59](#)

UTF-8 output, [4-58](#)

V

validation

auto validation mode, [4-9](#)

DTD validating Mode, [4-9](#)

partial validation mode, [4-9](#)

schema validation, [4-9](#)

schema validation mode, [4-9](#)

Visual C/C++, [18-9](#)

Visual Studio, [18-9](#)

W

Windows

C components

with Visual C/C++, [18-9](#)

C libraries, [18-6](#)

editing make.bat file, [18-8](#)

setting up C environment variables, [18-7](#)

Windows environment for C components

setting up, [18-6](#)

WML Document, [16-26](#)

X

Xdiff instance document, [23-4](#)

Xdiff schema, [23-7](#)

xdiff.xsd, [12-10](#)

XDK

JAR files for XQJ, [7-1](#)

XDK components, [1-1](#)

XDK version

using C, [18-6](#)

using C++, [25-3](#)

using Java, [3-9](#)

XML Base, [33-1](#)

XML C++ Class Generator, [31-1](#)

XML DB

JAR files for XQJ, [8-2](#)

XML diffing methods

Java, [12-1](#)

- XML documents
 - generating from C, [1-12](#)
 - generating from C++, [1-13](#)
 - generating from Java, [1-11](#)
- XML equal methods
 - Java, [12-1, 12-10](#)
- XML hash methods
 - Java, [12-1, 12-10](#)
- XML input documents
 - comparing and contrasting, [12-3](#)
- XML namespace prefixes
 - ignoring differences, [12-2](#)
- XML Namespaces 1.0, [33-1](#)
- XML output in UTF-8, [4-58](#)
- XML parser
 - oraxml command-line interface, [4-15, 10-9](#)
- XML parser for C
 - sample programs, [19-7, 20-7](#)
- XML pull parser
 - example, [20-19](#)
- XML Pull Parser error handling, [20-19](#)
- XML Pull Parser for C, [20-16](#)
- XML Schema
 - explained, [9-3](#)
 - processor for Java
 - how to run the sample program, [6-4, 9-10, 10-7, 11-8, 14-6](#)
- XML schema for C
 - sample programs, [22-4](#)
- XML SQL Utility (XSU)
 - advanced techniques, exception handling (PL/SQL), [13-40](#)
 - connecting with OCI* JDBC driver, [13-3](#)
 - customizing generated XML, [13-44](#)
 - DBMS_XMLQuery, [13-6](#)
 - DBMS_XMLSave(), [13-7](#)
 - dependencies and installation, [13-3](#)
 - explained, [13-3](#)
 - getXML command line, [13-18](#)
 - getXMLClob, [13-6](#)
 - inserts, [13-47](#)
 - mapping primer, [13-41](#)
 - selects, [13-47](#)
 - updates, [13-47](#)
- XML Syntax for XQuery (XQueryX), [7-29](#)
- xmlcg usage, [31-1](#)
- XMLCompress JavaBean, [D-5](#)
- XMLDBAccess JavaBean, [D-4](#)
- XmlDiff
 - command-line options for C, [23-3](#)
- XMLDiff
 - example in C, [23-9](#)
- XMLDiff in C, [23-1](#)
- XMLDiff JavaBean, [D-4](#)
- XMLGEN (obsolete) See DBMS_XMLQUERY and DBMS_XMLSAVE, [13-3](#)
- XmlHash
 - example in C, [23-13](#)
- XmlNode.selectNodes() method, [4-52](#)
- XmlPatch
 - command-line options for C, [23-11](#)
- XQJ
 - entity resolver framework, [7-2](#)
 - updating queries, [7-19](#)
 - XQuery API for Java, [7-1](#)
 - XQuery Update Facility, [7-19](#)
- XQJ implementation-defined items
 - support in XDK, [7-30](#)
- XQuery API for Java, [7-1](#)
- XQuery API for Java (XQJ), [7-29, 8-1](#)
- XQuery implementation-defined items
 - support in XDK, [7-30](#)
- XQuery language, [7-29](#)
- XQuery optional features
 - support in XDK, [7-30](#)
- XQuery processor for Java
 - standards and specifications, [7-29](#)
 - streaming evaluation, [7-15](#)
 - using external storage, [7-17](#)
- XQuery Update Facility, [7-19, 7-29](#)
- XQuery Update Facility implementation-defined items
 - support in XDK, [7-30](#)
- XQueryX, [7-29](#)
- XSL Transformation (XSLT) Processor, [1-5](#)
- XSL Transformation (XSLT) Processor for Java, [6-3, 11-4, 14-3](#)
- XSL Transformations Specifications, [33-4](#)
- XSLT
 - XSLTransformer bean, [D-8](#)
- XSLT compiler, [19-1](#)
- XSLT processor, [19-3](#)
- XSLT Processor for Java
 - hints for using, [6-15](#)
- XSLTransformer JavaBean, [D-3](#)
- XSLValidator JavaBean, [D-5](#)
- XSQL
 - action handler errors, [17-12](#)
 - advanced topics, [17-1](#)
 - built-in action handler elements, [17-22](#)
 - connection, [16-29](#)
 - current page name, [16-30](#)
 - errors, [16-30](#)
 - setting up demos, [16-11](#)
 - SOAP support, [16-29](#)
 - stylesheets, [17-2](#)
 - two queries, [16-27](#)
- XSQL action elements
 - ((lt))xsql((colon))action((gt)), [32-7](#)
 - ((lt))xsql((colon))delete-request((gt)), [32-8](#)
 - ((lt))xsql((colon))dml((gt)), [32-10](#)
 - ((lt))xsql((colon))if-param((gt)), [32-11](#)
 - ((lt))xsql((colon))include-owa((gt)), [32-13](#)
 - ((lt))xsql((colon))include-param((gt)), [32-14](#)

XSQL action elements (*continued*)

- `<<lt>>xsql((colon))include-posted-xml((gt))`, [32-15](#)
- `<<lt>>xsql((colon))include-request-params((gt))`,
[32-16](#)
- `<<lt>>xsql((colon))include-xml((gt))`, [32-17](#)
- `<<lt>>xsql((colon))include-xsql((gt))`, [32-18](#)
- `<<lt>>xsql((colon))insert-param((gt))`, [32-20](#)
- `<<lt>>xsql((colon))insert-request((gt))`, [32-21](#)
- `<<lt>>xsql((colon))query((gt))`, [32-23](#)
- `<<lt>>xsql((colon))ref-cursor-function((gt))`, [32-26](#)
- `<<lt>>xsql((colon))set-cookie((gt))`, [32-28](#)
- `<<lt>>xsql((colon))set-page-param((gt))`, [32-30](#)
- `<<lt>>xsql((colon))set-session-param((gt))`, [32-32](#)
- `<<lt>>xsql((colon))set-stylesheet-param((gt))`, [32-34](#)
- `<<lt>>xsql((colon))update-request((gt))`, [32-36](#)

XSQL Pages security, [16-31](#)

XSQL servlet

hints, [16-26](#)

XSQL Servlet examples, [16-8](#)

XSU

generating XML, [13-18](#)

mapping primer, [13-41](#)

usage guidelines, [13-41](#)

XSU (XML SQL Utility), [1-7](#)

XSU usage techniques, [13-41](#)

XVM

XSLT compiler, [19-3](#)

XVM (XSLT Virtual Machine) processor, [19-1](#)

