

Oracle® Database

Backup and Recovery User's Guide

12c Release 2 (12.2)

E49782-07

May 2017

Oracle Database Backup and Recovery User's Guide, 12c Release 2 (12.2)

E49782-07

Copyright © 2003, 2017, Oracle and/or its affiliates. All rights reserved.

Primary Author: Padmaja Potineni

Contributors: K. Weill, L. Ashdown, T. Bednar, A. Beldalker, T. Chien, M. Dilman, S. Fogel, R. Guzman, S. Haisley, W. Hu, A. Hwang, A. Joshi, V. Krishnaswamy, J. W. Lee, V. Moore, M. Olagappan, V. Panteleenko, S. Ranganathan, F. Sanchez, V. Srihari, M. Susairaj, M. Stewart, S. Wertheimer, W. Yang, R. Zijlstra

This software and related documentation are provided under a license agreement containing restrictions on use and disclosure and are protected by intellectual property laws. Except as expressly permitted in your license agreement or allowed by law, you may not use, copy, reproduce, translate, broadcast, modify, license, transmit, distribute, exhibit, perform, publish, or display any part, in any form, or by any means. Reverse engineering, disassembly, or decompilation of this software, unless required by law for interoperability, is prohibited.

The information contained herein is subject to change without notice and is not warranted to be error-free. If you find any errors, please report them to us in writing.

If this is software or related documentation that is delivered to the U.S. Government or anyone licensing it on behalf of the U.S. Government, then the following notice is applicable:

U.S. GOVERNMENT END USERS: Oracle programs, including any operating system, integrated software, any programs installed on the hardware, and/or documentation, delivered to U.S. Government end users are "commercial computer software" pursuant to the applicable Federal Acquisition Regulation and agency-specific supplemental regulations. As such, use, duplication, disclosure, modification, and adaptation of the programs, including any operating system, integrated software, any programs installed on the hardware, and/or documentation, shall be subject to license terms and license restrictions applicable to the programs. No other rights are granted to the U.S. Government.

This software or hardware is developed for general use in a variety of information management applications. It is not developed or intended for use in any inherently dangerous applications, including applications that may create a risk of personal injury. If you use this software or hardware in dangerous applications, then you shall be responsible to take all appropriate fail-safe, backup, redundancy, and other measures to ensure its safe use. Oracle Corporation and its affiliates disclaim any liability for any damages caused by use of this software or hardware in dangerous applications.

Oracle and Java are registered trademarks of Oracle and/or its affiliates. Other names may be trademarks of their respective owners.

Intel and Intel Xeon are trademarks or registered trademarks of Intel Corporation. All SPARC trademarks are used under license and are trademarks or registered trademarks of SPARC International, Inc. AMD, Opteron, the AMD logo, and the AMD Opteron logo are trademarks or registered trademarks of Advanced Micro Devices. UNIX is a registered trademark of The Open Group.

This software or hardware and documentation may provide access to or information about content, products, and services from third parties. Oracle Corporation and its affiliates are not responsible for and expressly disclaim all warranties of any kind with respect to third-party content, products, and services unless otherwise set forth in an applicable agreement between you and Oracle. Oracle Corporation and its affiliates will not be responsible for any loss, costs, or damages incurred due to your access to or use of third-party content, products, or services, except as set forth in an applicable agreement between you and Oracle.

Contents

Preface	xxv
Audience	xxv
Documentation Accessibility	xxv
Related Documentation	xxvi
Conventions	xxvi
Changes in This Release for Backup and Recovery User's Guide	xxvii
Changes in Oracle Database 12c Release 2 (12.2.0.1)	xxvii
Changes in Oracle Database 12c Release 1 (12.1.0.2)	xxix
New Features	xxix
Changes in Oracle Database 12c Release 1 (12.1.0.1)	xxx
New Features	xxx
Part I Overview of Backup and Recovery	
1 Introduction to Backup and Recovery	
1.1 Purpose of Backup and Recovery	1-1
1.1.1 About Data Protection	1-2
1.1.2 About Failures that Require Database Recovery	1-3
1.1.3 About Data Archival	1-4
1.1.4 About Data Transfer	1-4
1.2 Oracle Backup and Recovery Solutions	1-4
1.3 Comparison of Oracle Backup Techniques	1-5
1.4 About Oracle Flashback Technology	1-7
1.4.1 Logical Flashback Features	1-7
1.4.2 Flashback Database	1-8
1.5 About Data Recovery Advisor	1-9
1.6 RMAN and Oracle Enterprise Manager Cloud Control	1-9
1.6.1 About Oracle Enterprise Manager Cloud Control	1-10
1.6.2 Accessing the Database Home Page Using Cloud Control	1-10
1.6.3 Performing Backup and Recovery Tasks with Cloud Control	1-11

1.7	About Zero Data Loss Recovery Appliance.....	1-11
1.7.1	Using RMAN with Recovery Appliance.....	1-12
1.8	Backup and Recovery Documentation Roadmap	1-12
1.8.1	Recovery Manager Documentation Roadmap	1-13
1.8.2	User-Managed Backup and Recovery Documentation Roadmap	1-14

2 Getting Started with RMAN

2.1	Overview of the RMAN Environment	2-1
2.2	Starting RMAN and Connecting to a Database: Quick Start.....	2-2
2.3	Showing the Default RMAN Configuration	2-3
2.4	Backing Up a Database: Quick Start	2-4
2.4.1	About Typical RMAN Backup Options	2-5
2.4.2	Backing Up a Database in ARCHIVELOG Mode	2-5
2.4.3	Backing Up a Database in NOARCHIVELOG Mode	2-6
2.4.4	Making Incremental Backups: Quick Start	2-7
2.4.5	Making Incrementally Updated Backups	2-8
2.4.6	Validating Database Files and Backups: Quick Start	2-9
2.4.7	Scripting RMAN Operations	2-9
2.5	Reporting on RMAN Operations: Quick Start	2-10
2.5.1	Listing Backups: Quick Start.....	2-10
2.5.2	Reporting on Database Files and Backups: Quick Start	2-11
2.6	Maintaining RMAN Backups.....	2-12
2.6.1	Cross-checking Backups: Quick Start.....	2-12
2.6.2	Deleting Obsolete Backups: Quick Start	2-13
2.7	Diagnosing and Repairing Failures with Data Recovery Advisor: Quick Start.....	2-13
2.7.1	Listing Failures and Determining Repair Options	2-14
2.7.2	Repairing Failures: Quick Start	2-15
2.8	Rewinding a Database with Flashback Database: Quick Start.....	2-15
2.9	Restoring and Recovering Database Files: Quick Start	2-16
2.9.1	Preparing to Restore and Recover Database Files: Quick Start	2-17
2.9.2	Recovering the Whole Database: Quick Start.....	2-18
2.9.3	Recovering Tablespaces: Quick Start.....	2-18
2.9.4	Recovering Individual Data Blocks: Quick Start	2-19

Part II Starting and Configuring RMAN and Flashback Database

3 Recovery Manager Architecture

3.1	About the RMAN Environment	3-1
3.2	About RMAN Command-Line Client	3-3
3.3	About RMAN Channels.....	3-3
3.3.1	About RMAN Channels and Devices.....	3-4
3.3.2	About RMAN Automatic and Manual Channels	3-4
3.4	About the RMAN Repository	3-5

3.5	About Media Management Using RMAN	3-6
3.5.1	About RMAN Interaction with a Media Manager	3-6
3.5.2	About RMAN and Oracle Secure Backup	3-7
3.5.3	About the Backup Solutions Program.....	3-7
3.6	About the Fast Recovery Area	3-7
3.7	About RMAN in a Data Guard Environment	3-8
3.7.1	About RMAN Configuration in a Data Guard Environment	3-8
3.7.2	About RMAN File Management in a Data Guard Environment	3-9
3.8	About RMAN in a Recovery Appliance Environment.....	3-10
3.8.1	Creating RMAN Backups to Recovery Appliance	3-10
4	Starting and Interacting with the RMAN Client	
4.1	Starting and Exiting RMAN	4-1
4.2	Making Database Connections with RMAN	4-2
4.2.1	About RMAN Database Connection Types.....	4-2
4.2.2	About Authentication for RMAN Database Connections.....	4-2
4.2.3	Making Database Connections from the RMAN Prompt	4-5
4.2.4	Making RMAN Database Connections from the Operating System Command Line	4-6
4.2.5	Making RMAN Connections to a CDB	4-7
4.2.6	Making RMAN Database Connections Within Command Files.....	4-10
4.2.7	Connecting RMAN to an Auxiliary Database.....	4-10
4.2.8	Diagnosing RMAN Connection Problems.....	4-11
4.3	Specifying the Location of RMAN Output	4-12
4.4	Setting Globalization Support Environment Variables for RMAN.....	4-12
4.5	Entering RMAN Commands.....	4-13
4.5.1	Entering RMAN Commands at the RMAN Prompt	4-13
4.5.2	Using Command Files with RMAN	4-13
4.5.3	Entering Comments in RMAN Command Files.....	4-14
4.5.4	Using Substitution Variables in Command Files.....	4-14
4.5.5	Checking RMAN Syntax	4-16
4.6	Using the RMAN Pipe Interface	4-18
4.6.1	Executing Multiple RMAN Commands in Succession Through a Pipe: Example ...	4-19
4.6.2	Executing RMAN Commands in a Single Job Through a Pipe: Example.....	4-19
5	Configuring the RMAN Environment	
5.1	About Configuring the Environment for RMAN Backups	5-1
5.1.1	Showing and Clearing Persistent RMAN Configurations	5-2
5.1.2	Configuring the Default Device for Backups: Disk or SBT	5-3
5.1.3	Configuring the Default Type for Backups: Backup Sets or Copies	5-4
5.1.4	Configuring Channels.....	5-5
5.1.5	Configuring Control File and Server Parameter File Autobackups.....	5-8
5.2	Configuring RMAN to Make Backups to a Media Manager.....	5-10

5.2.1	Prerequisites for Using a Media Manager with RMAN	5-11
5.2.2	Determining the Location of the Media Management Library.....	5-11
5.2.3	Configuring Media Management Software for RMAN Backups.....	5-12
5.2.4	Testing Whether the Media Manager Library Is Integrated Correctly.....	5-13
5.2.5	Configuring SBT Channels for Use with a Media Manager	5-15
5.3	Configuring RMAN to Make Backups to Recovery Appliance	5-16
5.3.1	Prerequisites for Using Recovery Appliance	5-17
5.3.2	Steps to Configure RMAN for Backups to Recovery Appliance.....	5-17
5.3.3	Determining the Location of the Recovery Appliance Backup Module	5-18
5.3.4	Specifying Recovery Appliance Configuration Settings for RMAN Backups	5-18
5.4	Configuring the Fast Recovery Area.....	5-19
5.4.1	Overview of Files in the Fast Recovery Area	5-19
5.4.2	Enabling the Fast Recovery Area	5-21
5.4.3	Disabling the Fast Recovery Area	5-26
5.4.4	Configuring Locations for Control Files and Redo Logs.....	5-27
5.4.5	Configuring RMAN File Creation in the Fast Recovery Area	5-28
5.5	Configuring the Backup Retention Policy.....	5-29
5.5.1	Configuring a Redundancy-Based Retention Policy.....	5-30
5.5.2	Configuring a Recovery Window-Based Retention Policy	5-30
5.5.3	Disabling the Retention Policy	5-31
5.6	Backup Optimization and the CONFIGURE command	5-31
5.6.1	Overview of Backup Optimization.....	5-31
5.6.2	Effect of Retention Policies on Backup Optimization for SBT Backups	5-33
5.6.3	Configuring Backup Optimization	5-35
5.7	Configuring an Archived Redo Log Deletion Policy.....	5-35
5.7.1	About Archived Redo Log Deletion Policies	5-36
5.7.2	Enabling an Archived Redo Log Deletion Policy	5-37
5.8	Configuring RMAN in a Data Guard Environment.....	5-37

6 Configuring the RMAN Environment: Advanced Topics

6.1	Configuring Advanced Channel Options	6-1
6.1.1	About Channel Control Options	6-1
6.1.2	Configuring Specific Channel Parameters.....	6-2
6.2	Configuring Advanced Backup Options.....	6-4
6.2.1	Configuring the Maximum Size of Backup Sets	6-4
6.2.2	Configuring the Maximum Size of Backup Pieces	6-5
6.2.3	Configuring Backup Duplexing	6-5
6.2.4	Configuring Tablespaces for Exclusion from Whole Database Backups	6-6
6.2.5	Configuring Compression Options	6-7
6.2.6	Configuring Backup Encryption	6-9
6.3	Configuring Auxiliary Instance Data File Names.....	6-13
6.4	Configuring the Snapshot Control File Location	6-14
6.4.1	Viewing the Configured Location of the Snapshot Control File	6-14

6.4.2	Setting the Location of the Snapshot Control File	6-15
6.5	Configuring RMAN for Use with a Shared Server	6-15
6.6	Enabling Lost Write Detection.....	6-16

7 Using Flashback Database and Restore Points

7.1	Overview of Flashback Database, Restore Points and Guaranteed Restore Points	7-1
7.1.1	About Flashback Database.....	7-2
7.1.2	About Flashback Database Window	7-3
7.1.3	Limitations of Flashback Database	7-3
7.1.4	About Normal Restore Points.....	7-4
7.1.5	About Guaranteed Restore Points	7-5
7.1.6	Overview of Restore Points in a Multitenant Environment.....	7-6
7.2	About Logging for Flashback Database and Guaranteed Restore Points	7-8
7.2.1	Guaranteed Restore Points and Fast Recovery Area Space Usage	7-8
7.2.2	About Logging for Guaranteed Restore Points with Flashback Logging Disabled ..	7-10
7.2.3	About Logging for Flashback Database with Guaranteed Restore Points Defined ..	7-10
7.3	Prerequisites for Flashback Database and Restore Points	7-10
7.4	Using Normal and Guaranteed Restore Points	7-11
7.4.1	Creating Normal and Guaranteed Restore Points in non-CDBs	7-11
7.4.2	Creating CDB Restore Points.....	7-12
7.4.3	Creating PDB Restore Points	7-13
7.4.4	Listing Restore Points Using the LIST Command.....	7-14
7.4.5	Listing Restore Points Using the V\$RESTORE_POINT View	7-15
7.4.6	Dropping Restore Points	7-16
7.5	Using Flashback Database.....	7-17
7.5.1	Enabling Flashback Database	7-17
7.5.2	Disabling Flashback Database Logging	7-18
7.5.3	Configuring the Environment for Optimal Flashback Database Performance	7-19
7.5.4	Monitoring the Effect of Flashback Database on Performance.....	7-19
7.5.5	About Flashback Writer (RVWR) Behavior with I/O Errors	7-20

Part III Backing Up and Archiving Data

8 RMAN Backup Concepts

8.1	About Consistent and Inconsistent RMAN Backups	8-1
8.1.1	About Consistent RMAN Backups	8-2
8.1.2	About Inconsistent RMAN Backups	8-2
8.2	About Online Backups and Backup Mode.....	8-2
8.3	About Backup Sets.....	8-3
8.3.1	About Backup Sets and Backup Pieces	8-4
8.3.2	About RMAN Block Compression for Backup Sets	8-4
8.3.3	About Binary Compression for RMAN Backup Sets	8-5
8.3.4	About RMAN Backup Undo Optimization.....	8-6

8.3.5	About Encryption for RMAN Backup Sets	8-6
8.3.6	About File Names for RMAN Backup Pieces.....	8-6
8.3.7	About Number and Size of RMAN Backup Pieces	8-7
8.3.8	About Number and Size of RMAN Backup Sets	8-7
8.3.9	About Multiplexed RMAN Backup Sets.....	8-8
8.3.10	About RMAN Proxy Copies	8-10
8.4	About RMAN Image Copies	8-10
8.4.1	About RMAN-Created Image Copies	8-10
8.4.2	About User-Managed Image Copies	8-11
8.5	About Sparse Backups	8-12
8.6	About Multiple Copies of RMAN Backups	8-13
8.6.1	About Duplexed Backup Sets	8-13
8.6.2	About Backups of RMAN Backups	8-14
8.7	About RMAN Control File and Server Parameter File Autobackups.....	8-15
8.7.1	When RMAN Performs Control File Autobackups	8-16
8.7.2	How RMAN Performs Control File Autobackups	8-16
8.8	About RMAN Incremental Backups	8-17
8.8.1	About Multilevel Incremental Backups	8-17
8.8.2	About Block Change Tracking.....	8-20
8.8.3	About the Incremental Backup Algorithm	8-20
8.8.4	About Recovery with Incremental Backups.....	8-21
8.8.5	About the Incremental-Forever Backup Strategy for Recovery Appliance	8-21
8.9	About Backup Retention Policies	8-22
8.9.1	About the Recovery Window	8-23
8.9.2	About Backup Redundancy.....	8-25
8.9.3	About Batch Deletes of Obsolete Backups.....	8-25
8.9.4	About Backup Retention Policy and Fast Recovery Area Deletion Rules	8-26

9 Backing Up the Database

9.1	Overview of RMAN Backups	9-1
9.1.1	Purpose of RMAN Backups	9-1
9.1.2	Basic Concepts of RMAN Backups	9-2
9.2	Specifying Backup Output Options	9-2
9.2.1	Specifying the Device Type for an RMAN Backup	9-3
9.2.2	Specifying Backup Set or Copy for an RMAN Backup to Disk	9-3
9.2.3	Specifying a Format for RMAN Backups.....	9-4
9.2.4	Specifying Tags for an RMAN Backup	9-5
9.2.5	Making Compressed Backups	9-7
9.2.6	Specifying Multisection Incremental Backups	9-8
9.2.7	Making Multisection Backups Using Image Copies	9-9
9.3	Backing Up Database Files with RMAN	9-10
9.3.1	Backing Up a Whole Database with RMAN	9-10
9.3.2	Backing Up Tablespaces and Data Files with RMAN.....	9-11

9.3.3	Backing Up Control Files with RMAN	9-12
9.3.4	Backing Up Server Parameter Files with RMAN	9-14
9.3.5	Backing Up a Database in NOARCHIVELOG Mode	9-15
9.4	Backing Up CDBs and PDBs	9-15
9.4.1	About Backing Up CDBs and PDBs.....	9-16
9.4.2	Backing Up a Whole CDB	9-16
9.4.3	Backing Up the Root with RMAN	9-17
9.4.4	Backing Up the Root with Oracle Enterprise Manager Cloud Control.....	9-17
9.4.5	Backing Up PDBs with RMAN.....	9-18
9.4.6	Backing Up PDBs with Oracle Enterprise Manager Cloud Control	9-18
9.4.7	Backing Up Tablespaces and Data Files in a PDB	9-19
9.5	Backing Up Application Containers	9-20
9.5.1	About Backing Up Application Containers.....	9-20
9.5.2	Backing Up the Application Root	9-21
9.5.3	Backing Up the Application Root and its Application PDBs.....	9-21
9.5.4	Backing Up Application PDBs.....	9-22
9.6	Backing Up Sparse Databases with RMAN	9-22
9.6.1	Backing Up a Sparse Database with RMAN	9-23
9.6.2	Backing Up Sparse Tablespaces and Data Files with RMAN	9-24
9.6.3	Backing Up a Sparse CDB with RMAN	9-25
9.6.4	Backing Up a Sparse PDB with RMAN.....	9-26
9.7	Backing Up Archived Redo Logs with RMAN	9-27
9.7.1	About Backups of Archived Redo Logs for non-CDBs.....	9-27
9.7.2	About Backup of Archived Redo Logs in CDBs.....	9-29
9.7.3	Backing Up Archived Redo Log Files in non-CDBs.....	9-29
9.7.4	Backing Up Only Archived Redo Logs That Need Backups in non-CDBs.....	9-30
9.7.5	Backing Up Archived Redo Logs in CDBs	9-31
9.7.6	Deleting Archived Redo Logs After Backups in non-CDBs.....	9-32
9.7.7	Deleting Archived Redo Logs After Backups in CDBs.....	9-33
9.8	Making and Updating RMAN Incremental Backups.....	9-33
9.8.1	Purpose of RMAN Incremental Backups.....	9-33
9.8.2	Planning an Incremental Backup Strategy.....	9-34
9.8.3	Making Incremental Backups	9-35
9.8.4	Incrementally Updating Backups	9-36
9.8.5	Using Block Change Tracking to Improve Incremental Backup Performance	9-40
9.9	Making Database Backups for Long-Term Storage	9-44
9.9.1	Purpose of Archival Backups	9-44
9.9.2	Basic Concepts of Archival Backups.....	9-45
9.9.3	Making an Archival Backup for Long-Term Storage.....	9-46
9.9.4	Making a Temporary Archival Backup.....	9-47
9.10	Backing Up RMAN Backups.....	9-48
9.10.1	About Backups of RMAN Backups	9-48
9.10.2	Backing Up Backup Sets with RMAN.....	9-50

9.10.3 Backing Up Image Copy Backups with RMAN.....	9-51
---	------

10 Backing Up the Database: Advanced Topics

10.1 Limiting the Size of RMAN Backup Sets.....	10-1
10.1.1 About Backup Set Size.....	10-2
10.1.2 Limiting the Size of Backup Sets with BACKUP ... MAXSETSIZE.....	10-2
10.1.3 Dividing the Backup of a Large Data File into Sections.....	10-3
10.2 Using Backup Optimization to Skip Files.....	10-4
10.2.1 Optimizing a Daily Archived Log Backup to a Single Tape: Scenario.....	10-4
10.2.2 Optimizing a Daily Archived Log Backup to Multiple Media Families: Scenario ..	10-5
10.2.3 Creating a Weekly Secondary Backup of Archived Logs: Example.....	10-5
10.3 Skipping Offline, Read-Only, and Inaccessible Files.....	10-7
10.4 Duplexing Backup Sets.....	10-7
10.4.1 Duplexing Backup Sets with CONFIGURE BACKUP COPIES.....	10-8
10.4.2 Duplexing Backup Sets with BACKUP ... COPIES.....	10-9
10.5 Making Split Mirror Backups with RMAN.....	10-9
10.6 Encrypting RMAN Backups.....	10-11
10.6.1 About RMAN Backup Encryption Settings.....	10-11
10.6.2 Making Transparent-Mode Encrypted Backups.....	10-12
10.6.3 Making Password-Mode Encrypted Backups.....	10-12
10.6.4 Making Dual-Mode Encrypted Backups.....	10-13
10.7 Restarting RMAN Backups.....	10-13
10.7.1 About Restartable Backups.....	10-14
10.7.2 Restarting a Backup After It Partially Completes.....	10-14
10.8 Managing Backup Windows.....	10-15
10.8.1 About Backup Windows.....	10-15
10.8.2 Specifying a Backup Duration.....	10-15
10.8.3 Permitting Partial Backups in a Backup Window.....	10-16
10.8.4 Minimizing Backup Load and Duration.....	10-16

Part IV Managing RMAN Backups

11 Reporting on RMAN Operations

11.1 Overview of RMAN Reporting.....	11-1
11.1.1 Purpose of RMAN Reporting.....	11-1
11.1.2 Basic Concepts of RMAN Reporting.....	11-1
11.1.3 Reporting in a Data Guard Environment.....	11-3
11.2 Listing Backups and Recovery-Related Objects.....	11-3
11.2.1 About the LIST Command.....	11-4
11.2.2 Listing All Backups and Copies.....	11-6
11.2.3 Listing Selected Backups and Copies.....	11-8
11.2.4 Listing Database Incarnations.....	11-9
11.3 Reporting on Backups and Database Schema.....	11-10

11.3.1	About Reports of RMAN Backups.....	11-10
11.3.2	Reporting on Files Needing a Backup Under a Retention Policy	11-11
11.3.3	Reporting on Data Files Affected by Unrecoverable Operations.....	11-13
11.3.4	Reporting on Obsolete Backups	11-13
11.3.5	Reporting on the Database Schema	11-14
11.4	Reporting in CDBs and PDBs.....	11-15
11.4.1	Reporting in CDBs.....	11-16
11.4.2	Reporting in PDBs	11-16
11.5	Using V\$ Views to Query Backup Metadata	11-17
11.5.1	Querying Details of Past and Current RMAN Jobs.....	11-17
11.5.2	Determining the Encryption Status of Backup Pieces.....	11-19
11.6	Querying Recovery Catalog Views	11-20
11.6.1	About Recovery Catalog Views	11-20
11.6.2	Querying Catalog Views for the Target DB_KEY or DBID Values.....	11-21
11.6.3	Querying RC_BACKUP_FILES	11-23

12 Maintaining RMAN Backups and Repository Records

12.1	Overview of RMAN Backup and Repository Maintenance	12-1
12.1.1	Purpose of Backup and Repository Maintenance.....	12-1
12.1.2	Basic Concepts of Backup and Repository Maintenance.....	12-2
12.2	Maintaining the Control File Repository.....	12-4
12.2.1	About Control File Records	12-4
12.2.2	Preventing the Loss of Control File Records	12-5
12.2.3	Protecting the Control File	12-6
12.3	Maintaining the Fast Recovery Area.....	12-7
12.3.1	Deletion Rules for the Fast Recovery Area.....	12-7
12.3.2	Monitoring Fast Recovery Area Space Usage	12-8
12.3.3	Managing Space for Flashback Logs in the Fast Recovery Area	12-9
12.3.4	Responding to a Full Fast Recovery Area.....	12-9
12.3.5	Changing the Fast Recovery Area to a New Location	12-10
12.3.6	Disabling the Fast Recovery Area	12-11
12.3.7	Responding to an Instance Crash During File Creation	12-11
12.4	Updating the RMAN Repository.....	12-11
12.4.1	Crosschecking the RMAN Repository	12-11
12.4.2	Changing the Repository Status of Backups and Copies	12-14
12.4.3	Adding Backup Records to the RMAN Repository	12-17
12.4.4	Removing Records from the RMAN Repository	12-20
12.5	Deleting RMAN Backups and Archived Redo Logs	12-20
12.5.1	Overview of Deleting RMAN Backups.....	12-21
12.5.2	Deleting All Backups and Copies	12-23
12.5.3	Deleting Specified Backups and Copies.....	12-24
12.5.4	Deleting Expired RMAN Backups and Copies.....	12-25
12.5.5	Deleting Obsolete RMAN Backups Based on Retention Policies.....	12-26

12.5.6	Deleting Backups of Dropped PDBs.....	12-26
12.6	Dropping a Database.....	12-27

13 Managing a Recovery Catalog

13.1	Overview of the RMAN Recovery Catalog.....	13-1
13.1.1	Purpose of the RMAN Recovery Catalog.....	13-1
13.1.2	Basic Concepts for the RMAN Recovery Catalog.....	13-2
13.1.3	Basic Steps of Managing a Recovery Catalog.....	13-4
13.2	Creating a Recovery Catalog.....	13-5
13.2.1	Configuring the Recovery Catalog Database.....	13-5
13.2.2	Creating the Recovery Catalog Schema Owner.....	13-7
13.2.3	Executing the CREATE CATALOG Command.....	13-7
13.3	Registering a Database in the Recovery Catalog.....	13-8
13.3.1	About Registration of a Database in the Recovery Catalog.....	13-8
13.3.2	Registering a Database with the REGISTER DATABASE Command.....	13-9
13.4	Cataloging Backups in the Recovery Catalog.....	13-10
13.5	Creating and Managing Virtual Private Catalogs.....	13-11
13.5.1	Overview of Virtual Private Catalogs.....	13-11
13.5.2	About Using the VPD Model for Virtual Private Catalogs.....	13-12
13.5.3	Creating Virtual Private Catalogs.....	13-13
13.5.4	Registering a Database with a Virtual Private Catalog.....	13-15
13.5.5	Revoking Privileges from a Virtual Private Catalog Owner.....	13-15
13.5.6	Dropping a Virtual Private Catalog.....	13-16
13.5.7	Upgrading Virtual Private Catalogs.....	13-16
13.6	Protecting the Recovery Catalog.....	13-17
13.6.1	Backing Up the Recovery Catalog.....	13-17
13.6.2	Recovering the Recovery Catalog.....	13-19
13.7	Managing Stored Scripts.....	13-20
13.7.1	About Stored Scripts.....	13-20
13.7.2	Creating Stored Scripts.....	13-21
13.7.3	Replacing Stored Scripts.....	13-22
13.7.4	Executing Stored Scripts.....	13-22
13.7.5	Creating and Executing Dynamic Stored Scripts.....	13-23
13.7.6	Printing Stored Scripts.....	13-24
13.7.7	Listing Stored Script Names.....	13-25
13.7.8	Deleting Stored Scripts.....	13-26
13.7.9	Executing a Stored Script at RMAN Startup.....	13-26
13.8	Maintaining a Recovery Catalog.....	13-26
13.8.1	About Recovery Catalog Maintenance.....	13-27
13.8.2	Resynchronizing the Recovery Catalog.....	13-27
13.8.3	Updating the Recovery Catalog After Changing a DB_UNIQUE_NAME.....	13-31
13.8.4	Unregistering a Target Database from the Recovery Catalog.....	13-32
13.8.5	Resetting the Database Incarnation in the Recovery Catalog.....	13-35

13.8.6	Upgrading the Recovery Catalog.....	13-36
13.8.7	Importing and Moving a Recovery Catalog.....	13-39
13.9	Dropping a Recovery Catalog.....	13-42

Part V Diagnosing and Responding to Failures

14 RMAN Data Repair Concepts

14.1	Overview of RMAN Data Repair	14-1
14.1.1	About Problems Requiring Data Repair	14-1
14.1.2	About RMAN Data Repair Techniques	14-1
14.2	About RMAN Restore Operations	14-3
14.2.1	About RMAN Backup Selection.....	14-4
14.2.2	About RMAN Restore Failover	14-4
14.2.3	About RMAN Restore of Encrypted Backups.....	14-5
14.2.4	About RMAN Restore Operations and ASM	14-5
14.2.5	About RMAN Restore Optimization.....	14-6
14.3	About RMAN Media Recovery	14-6
14.3.1	About Selection of Incremental Backups and Archived Redo Logs	14-7
14.3.2	About Database Incarnations	14-7

15 Diagnosing and Repairing Failures with Data Recovery Advisor

15.1	Overview of Data Recovery Advisor	15-1
15.1.1	Purpose of Data Recovery Advisor	15-1
15.1.2	Basic Concepts of Data Recovery Advisor	15-2
15.1.3	Basic Steps of Diagnosing and Repairing Failures	15-6
15.1.4	Diagnosing and Repairing Failures in CDBs.....	15-7
15.2	Listing Failures.....	15-8
15.2.1	Listing All Failures	15-8
15.2.2	Listing a Subset of Failures	15-9
15.3	Checking for Block Corruptions by Validating the Database	15-9
15.4	Determining Repair Options.....	15-11
15.4.1	Determining Repair Options for All Failures.....	15-12
15.4.2	Determining Repair Options for a Subset of Failures	15-13
15.5	Repairing Failures.....	15-14
15.5.1	About Repairing Failures	15-14
15.5.2	Repairing a Failure	15-15
15.6	Changing Failure Status and Priority	15-16

16 Validating Database Files and Backups

16.1	Overview of RMAN Validation.....	16-1
16.1.1	Purpose of RMAN Validation	16-1
16.1.2	Basic Concepts of RMAN Validation	16-1
16.2	Checking for Block Corruption with the VALIDATE Command	16-4

16.3	Validating Database Files with BACKUP VALIDATE	16-6
16.4	Validating Backups Before Restoring Them	16-7
16.5	Validating CDBs and PDBs	16-8
16.5.1	Validating a Whole CDB	16-9
16.5.2	Validating PDBs.....	16-9

17 Performing Complete Database Recovery

17.1	Overview of Complete Database Recovery	17-1
17.1.1	Purpose of Complete Database Recovery	17-1
17.1.2	Scope of This Chapter	17-1
17.1.3	About Real-Time Redo Transport for Recovery Appliance	17-2
17.2	Preparing for Complete Database Recovery	17-3
17.2.1	Identifying the Database Files to Restore or Recover	17-3
17.2.2	Determining the DBID of the Database.....	17-6
17.2.3	Previewing Backups Used in Restore Operations.....	17-7
17.2.4	Validating Backups Before Restoring Them.....	17-9
17.2.5	Restoring Archived Redo Logs Needed for Recovery.....	17-9
17.2.6	Providing the Password Required to Decrypt Encrypted Backups.....	17-11
17.3	Performing Complete Database Recovery	17-12
17.3.1	About Complete Database Recovery.....	17-12
17.3.2	Performing Complete Recovery of the Whole Database	17-13
17.3.3	Performing Complete Recovery of a Tablespace.....	17-16
17.3.4	Performing Complete Recovery After Switching to a Copy	17-18
17.4	Performing Complete Recovery of CDBs.....	17-20
17.4.1	Performing Complete Recovery of a Whole CDB	17-21
17.4.2	Performing Complete Recovery of the Root	17-22
17.4.3	Performing Complete Recovery of PDBs with RMAN.....	17-23
17.4.4	Performing Complete Recovery of PDBs with Cloud Control.....	17-25
17.4.5	Performing Complete Recovery of Tablespaces or Data Files in a PDB with RMAN	17-26
17.4.6	Performing Complete Recovery of Tablespaces in a PDB with Cloud Control.....	17-28
17.4.7	Performing Complete Recovering of CDBs After Switching to a Copy.....	17-29
17.5	Performing Complete Recovery of Application Containers	17-29
17.5.1	Performing Complete Recovery of the Application Root	17-29
17.5.2	Performing Complete Recovery of the Application Root and Application PDBs.	17-31
17.5.3	Performing Complete Recovery of Application PDBs.....	17-31
17.6	Performing Complete Recovery of Sparse Databases with RMAN	17-32
17.6.1	Performing Complete Recovery of a Sparse Database	17-33
17.6.2	Performing Complete Recovery of a Sparse CDB	17-33
17.6.3	Performing Recovery of a Sparse PDB with RMAN.....	17-34

18 Performing Flashback and Database Point-in-Time Recovery

18.1	Overview of Oracle Flashback Technology and Database Point-in-Time Recovery	18-1
------	---	------

18.1.1	Purpose of Flashback and Database Point-in-Time Recovery	18-1
18.1.2	Basic Concepts of Point-in-Time Recovery and Flashback Features	18-1
18.1.3	Basic Concepts of Performing Flashback Database for CDBs and PDBs	18-4
18.2	Rewinding a Table with Flashback Table	18-7
18.2.1	Prerequisites for Flashback Table	18-7
18.2.2	Performing a Flashback Table Operation	18-8
18.3	Rewinding a DROP TABLE Operation with Flashback Drop	18-10
18.3.1	About Flashback Drop	18-11
18.3.2	Prerequisites of Flashback Drop	18-11
18.3.3	Performing a Flashback Drop Operation	18-12
18.4	Rewinding a Database with Flashback Database	18-15
18.4.1	Prerequisites of Flashback Database	18-15
18.4.2	Performing a Flashback Database Operation	18-16
18.4.3	Performing a Flashback Database Operation for a Whole CDB	18-19
18.4.4	Performing a Flashback Database Operation for PDBs	18-22
18.4.5	Monitoring Flashback Database	18-24
18.5	Performing Database Point-in-Time Recovery	18-25
18.5.1	Prerequisites of Database Point-in-Time Recovery	18-25
18.5.2	Performing Database Point-in-Time Recovery	18-25
18.5.3	Performing Point-in-Time Recovery of CDBs and PDBs	18-28
18.5.4	Performing Point-in-Time Recovery of Application PDBs	18-32
18.5.5	Performing Point-in-Time Recovery of Sparse Databases	18-33
18.6	Flashback and Database Point-in-Time Recovery Scenarios	18-34
18.6.1	Rewinding an OPEN RESETLOGS Operation with Flashback Database	18-35
18.6.2	Rewinding the Database to an SCN in an Abandoned Incarnation Branch	18-36
18.6.3	Recovering the Database to an Ancestor Incarnation	18-38
19	Performing Block Media Recovery	
19.1	Overview of Block Media Recovery	19-1
19.1.1	Purpose of Block Media Recovery	19-1
19.1.2	Basic Concepts of Block Media Recovery	19-2
19.2	Prerequisites for Block Media Recovery	19-4
19.3	Recovering Individual Blocks	19-5
19.3.1	Recovering Individual Blocks Using the RECOVER...BLOCK Command	19-5
19.3.2	Example: Recovering Individual Blocks Using the Data Recovery Advisor	19-6
19.4	Recovering All Blocks in V\$DATABASE_BLOCK_CORRUPTION	19-8
20	Performing RMAN Recovery: Advanced Scenarios	
20.1	Recovering a NOARCHIVELOG Database with Incremental Backups	20-1
20.2	Restoring the Server Parameter File	20-2
20.2.1	Restoring the Server Parameter File from a Control File Autobackup	20-3
20.2.2	Creating an Initialization Parameter File with RMAN	20-4
20.3	Performing Recovery with a Backup Control File	20-4

20.3.1	About Recovery with a Backup Control File.....	20-5
20.3.2	Performing Recovery with a Backup Control File and No Recovery Catalog	20-7
20.4	Performing Disaster Recovery	20-9
20.4.1	Prerequisites of Disaster Recovery	20-9
20.4.2	Recovering the Database After a Disaster	20-10
20.5	Restoring a Database on a New Host	20-12
20.5.1	Preparing to Restore a Database on a New Host.....	20-12
20.5.2	Restoring Disk Backups to a New Host.....	20-13
20.5.3	Testing the Restore of a Database on a New Host.....	20-14
20.6	Restoring Backups Created Using Older Versions of RMAN.....	20-18
20.7	Restoring and Recovering Files Over the Network.....	20-21
20.7.1	About Restoring Files Over the Network	20-22
20.7.2	About Recovering Files Over the Network	20-22
20.7.3	Scenarios for Restoring and Recovering Files Over the Network.....	20-22
20.7.4	Restoring Data Files Over the Network.....	20-23
20.7.5	Rolling Forward a Physical Standby Database Using the RECOVER Command .	20-23

21 Performing RMAN Tablespace Point-in-Time Recovery (TSPITR)

21.1	Overview of RMAN TSPITR.....	21-1
21.1.1	Purpose of RMAN TSPITR	21-1
21.1.2	Basic Concepts of RMAN TSPITR.....	21-2
21.2	TSPITR Restrictions, Special Cases, and Limitations	21-5
21.2.1	Limitations of TSPITR.....	21-5
21.2.2	About Special Considerations When Not Using a Recovery Catalog	21-6
21.3	Planning and Preparing for TSPITR	21-6
21.3.1	Selecting the Right Target Time for TSPITR.....	21-7
21.3.2	Determining the Recovery Set	21-7
21.3.3	Identifying and Preserving Objects That Are Lost After TSPITR	21-8
21.4	Performing Fully Automated RMAN TSPITR	21-9
21.5	Overriding Defaults for RMAN TSPITR with an RMAN-Managed Auxiliary Database	21-11
21.5.1	Renaming TSPITR Recovery Set Data Files with SET NEWNAME	21-12
21.5.2	Naming TSPITR Auxiliary Set Data Files	21-12
21.5.3	Using Image Copies for Faster RMAN TSPITR Performance	21-16
21.5.4	Customizing Initialization Parameters for the Automatic Auxiliary Database in TSPITR.....	21-18
21.6	Performing RMAN TSPITR Using Your Own Auxiliary Database	21-21
21.6.1	Preparing Your Own Auxiliary Database for RMAN TSPITR	21-21
21.6.2	Preparing RMAN Commands for TSPITR with Your Own Auxiliary Database ..	21-24
21.6.3	Executing TSPITR with Your Own Auxiliary Database.....	21-25
21.6.4	Performing TSPITR with Your Own Auxiliary Database: Scenario	21-26
21.7	Troubleshooting RMAN TSPITR.....	21-27
21.7.1	Troubleshooting File Name Conflicts During TSPITR	21-28

21.7.2 Troubleshooting the Identification of Tablespaces with Undo Segments During TSPITR.....	21-28
21.7.3 Troubleshooting the Restart of a Manual Auxiliary Database After TSPITR Failure	21-28

22 Recovering Tables and Table Partitions

22.1 Overview of Recovering Tables and Table Partitions	22-1
22.1.1 Purpose of Recovering Tables and Table Partitions from RMAN Backups	22-2
22.1.2 RMAN Backups Required to Recover Tables and Table Partitions.....	22-2
22.1.3 Basic Concepts of Recovering Tables and Table Partitions from RMAN Backups .	22-2
22.1.4 Limitations of Recovering Tables and Table Partitions from RMAN Backups.....	22-6
22.2 Preparing to Recover Tables and Table Partitions.....	22-7
22.2.1 Prerequisites for Recovering Tables and Table Partitions from RMAN Backups ...	22-7
22.2.2 Determining the Point-in-time to Which Tables and Table Partitions Must be Recovered.....	22-8
22.3 Recovering Tables and Table Partitions	22-8
22.4 Recovering Tables and Table Partitions in PDBs	22-9
22.5 Examples: Recovering Tables and Table Partitions From RMAN Backups.....	22-10
22.5.1 Example: Recovering Tables to a Specified Point in Time	22-10
22.5.2 Example: Recovering Table Partitions to a Specified Log Sequence Number	22-11
22.5.3 Example: Recovering a Table into a New Schema	22-12

Part VI Tuning and Troubleshooting

23 Tuning RMAN Performance

23.1 Purpose of RMAN Performance Tuning.....	23-1
23.2 Basic Concepts of RMAN Performance Tuning.....	23-1
23.2.1 Read Phase.....	23-3
23.2.2 Copy Phase.....	23-6
23.2.3 Write Phase for System Backup Tape (SBT)	23-7
23.2.4 Write Phase for Disk	23-10
23.3 Using V\$ Views to Diagnose RMAN Performance Problems.....	23-11
23.3.1 Monitoring RMAN Job Progress with V\$SESSION_LONGOPS.....	23-11
23.3.2 Identifying Bottlenecks with V\$BACKUP_SYNC_IO and V\$BACKUP_ASYNC_IO	23-13
23.4 Tuning RMAN Backup Performance.....	23-15
23.4.1 Removing the RATE Parameter from Channel Settings.....	23-15
23.4.2 Setting DBWR_IO_SLAVES to Simulate Asynchronous I/O.....	23-15
23.4.3 Setting LARGE_POOL_SIZE to Resolve Shared Memory Issues	23-16
23.4.4 Tuning the Read, Write, and Copy Phases.....	23-17

24 Troubleshooting RMAN Operations

24.1 Interpreting RMAN Message Output.....	24-1
--	------

24.1.1	Identifying Types of RMAN Message Output.....	24-1
24.1.2	Recognizing RMAN Error Message Stacks	24-2
24.1.3	Identifying RMAN Error Codes.....	24-2
24.1.4	Interpreting RMAN Error Stacks	24-6
24.1.5	Identifying RMAN Return Codes.....	24-8
24.2	Using V\$ Views for RMAN Troubleshooting.....	24-8
24.2.1	Monitoring RMAN Interaction with the Media Manager.....	24-9
24.2.2	Correlating Server Sessions with RMAN Channels.....	24-10
24.3	Testing the Media Management API.....	24-12
24.3.1	Obtaining the sbttest Utility.....	24-13
24.3.2	Obtaining Online Documentation for the sbttest Utility	24-13
24.3.3	Using the sbttest Utility	24-13
24.4	Terminating an RMAN Command	24-14
24.4.1	Terminating the Session with ALTER SYSTEM KILL SESSION.....	24-15
24.4.2	Terminating the Session at the Operating System Level.....	24-15
24.4.3	Terminating an RMAN Session That Is Not Responding in the Media Manager .	24-15

Part VII Transferring Data with RMAN

25 Duplicating Databases

25.1	Overview of RMAN Database Duplication	25-1
25.1.1	Purpose of Database Duplication.....	25-2
25.1.2	Basic Concepts of Database Duplication.....	25-2
25.1.3	Types of Database Duplication	25-5
25.1.4	How RMAN Duplicates a Database	25-12
25.1.5	Contents of a Duplicate Database	25-13
25.1.6	About the Destination Host for Database Duplication.....	25-14
25.1.7	About Duplicate Database File Names	25-14
25.1.8	About Duplicating a Database to a Past Point-in-Time.....	25-14
25.1.9	Prerequisites for Duplicating a Database.....	25-15
25.2	Planning to Duplicate a Database	25-15
25.2.1	Choosing a Duplication Technique	25-15
25.2.2	Choosing a Strategy for Naming Duplicate Database Files	25-16
25.2.3	Installing the Oracle Database Software on the Destination Host.....	25-20
25.2.4	Deciding the State of the Duplicate Database	25-20
25.2.5	Making Backups Accessible to the Duplicate Instance.....	25-20
25.3	Preparing the Auxiliary Instance.....	25-23
25.3.1	Creating Directories for the Duplicate Database	25-23
25.3.2	Creating an Initialization Parameter File for the Auxiliary Instance.....	25-23
25.3.3	Creating a Password File for the Auxiliary Instance.....	25-26
25.3.4	Establishing Oracle Net Connectivity Between the Source Database and Auxiliary Instance.....	25-27
25.3.5	Starting the Auxiliary Instance.....	25-28

25.3.6	Making the Oracle Keystore Available to the Destination Host	25-28
25.4	Duplicating a Database	25-29
25.4.1	Duplicating the Whole Database.....	25-30
25.4.2	Duplicating a Subset of the Source Database Tablespaces.....	25-31
25.4.3	Duplicating an Oracle RAC Database	25-32
25.4.4	Duplicating Sparse Databases	25-33
25.4.5	Configuring RMAN Channels for Use in Duplication	25-34
25.4.6	Placing the Source Database in the Proper State	25-36
25.4.7	Starting RMAN and Connecting to Databases	25-36
25.4.8	Using the DUPLICATE Command to Duplicate Databases	25-38
25.5	Duplicating CDBs and PDBs.....	25-38
25.5.1	Duplicating CDBs.....	25-39
25.5.2	Duplicating Sparse CDBs	25-40
25.5.3	Duplicating PDBs	25-41
25.5.4	Duplicating Sparse PDBs.....	25-43
25.5.5	Duplicating Tablespaces Within a PDB	25-44
25.6	Restarting DUPLICATE After a Failure	25-44
25.7	Examples: Duplicating Databases	25-45
25.7.1	Example: Duplicating a Database to a Remote ASM Host Using Active Database Duplication with Backup Sets.....	25-46
25.7.2	Example: Duplicating a Database to a Remote Host Using Active Database Duplication with Image Copies.....	25-48
25.7.3	Example: Duplicating a Database to a Remote Host by Using Backup-based Duplication without a Target Connection or Recovery Catalog	25-49
25.7.4	Example: Duplicating a Database to a Remote Host by Using Backup-Based Duplication with a Recovery Catalog.....	25-51
25.7.5	Example: Duplicating a Database to a Remote Host by Using Backup-based Duplication with a Target Connection	25-53
25.7.6	Example: Performing Backup-based Duplication Using Encrypted Backups	25-55
25.8	Example: Script to Duplicate a Database Using Backup-based Duplication	25-58

26 Duplicating Databases: Advanced Topics

26.1	Specifying Alternative Names for Duplicate Database Files	26-1
26.1.1	Specifying Non-OMF or Non-ASM Alternative Names for Duplicate Database Files	26-1
26.1.2	Specifying OMF or ASM Alternative Names for Duplicate Database Files	26-5
26.2	Making Disk Backups Accessible Without Shared Disk.....	26-10

27 Creating Transportable Tablespace Sets

27.1	Overview of Creating Transportable Tablespace Sets	27-1
27.1.1	Purpose of Creating Transportable Tablespace Sets	27-1
27.1.2	Basic Concepts of Transportable Tablespace Sets	27-2
27.1.3	Basic Steps of Creating Transportable Tablespace Sets	27-4

27.2	Customizing Initialization Parameters for the Auxiliary Instance.....	27-5
27.2.1	About Setting Initialization Parameters for the RMAN Auxiliary Instance.....	27-5
27.2.2	Setting the Location of the Auxiliary Instance Parameter File	27-6
27.3	Creating a Transportable Tablespace Set	27-7
27.4	Troubleshooting the Creation of Transportable Tablespace Sets	27-8
27.5	Transportable Tablespace Set Scenarios.....	27-8
27.5.1	Creating a Transportable Tablespace Set at a Specified Time or SCN	27-8
27.5.2	Specifying Locations for Data Pump Files.....	27-9
27.5.3	Specifying Auxiliary File Locations with Transportable Tablespaces.....	27-10

28 Transporting Data Across Platforms

28.1	About Cross-Platform Data Transport	28-1
28.1.1	Purpose of Cross-Platform Data Transport.....	28-2
28.1.2	Methods of Transporting Data Across Platforms.....	28-2
28.1.3	Platforms that Support Cross-Platform Data Transport.....	28-3
28.2	Overview of Cross-Platform Data Transport Using Image Copies.....	28-3
28.2.1	Overview of Tablespace and Data File Conversion Using Image Copies	28-3
28.2.2	Overview of Database Conversion Using Image Copies	28-4
28.3	Performing Cross-Platform Tablespace Conversion with Image Copies.....	28-5
28.4	Performing Cross-Platform Data File Conversion with Image Copies.....	28-7
28.4.1	About Renaming Output Files During RMAN Cross-Platform Data File Conversion.....	28-7
28.4.2	Performing Tablespace Transportation on the Destination Host Using RMAN CONVERT DATAFILE	28-8
28.5	Performing Cross-Platform Database Conversion with Image Copies	28-10
28.5.1	Checking the Database Before Cross-Platform Database Conversion	28-10
28.5.2	Converting Data Files on the Source Host When Transporting a Database.....	28-13
28.5.3	Converting Data Files on the Destination Host When Transporting a Database ..	28-16
28.6	Overview of Cross-Platform Data Transport Using Backup Sets	28-19
28.6.1	Basic Terms Used in Cross-Platform Data Transport Using Backup Sets	28-22
28.6.2	About Backing Up Data on the Source Database for Cross-Platform Data Transport.....	28-23
28.6.3	About the Data Pump Export Dump File Used for Cross-Platform Tablespace Transport.....	28-23
28.6.4	About Restoring Data on the Destination Host During Cross-Platform Data Transport.....	28-24
28.6.5	About Selecting Objects to Be Restored from Cross-Platform Backups.....	28-25
28.6.6	About Names and Locations for Restored Objects on the Destination Database..	28-25
28.6.7	About Importing the Data Pump Export Dump File Created During Cross- Platform Tablespace Transport.....	28-26
28.7	Performing Cross-Platform Database Transport with Backup Sets	28-26
28.7.1	Steps to Transport a Database to a Different Platform Using Backup Sets	28-27
28.8	Performing Cross-Platform Transport of Read-Only Tablespaces Using Backup Sets	28-29

28.8.1	Steps to Transport Read-Only Tablespaces to a Different Platform Using Backup Sets	28-30
28.9	Overview of Cross-Platform Transport of Tablespaces Using Inconsistent Backups	28-32
28.10	Performing Cross-Platform Transport of Tablespaces Using Inconsistent Backups	28-33
28.10.1	Steps to Transport Inconsistent Tablespaces to a Different Platform	28-35
28.10.2	Example: Performing Cross-Platform Inconsistent Tablespace Transport Using Backup Sets	28-37
28.11	Performing Cross-Platform Transport of Data Files Over the Network	28-41
28.12	Performing Cross-Platform Data Transport in CDBs and PDBs	28-41
28.12.1	About Cross-Platform Transport of PDBs	28-42
28.12.2	Performing Cross-Platform Transport of a Whole CDB.....	28-42
28.12.3	Performing Cross-Platform Transport of a Closed PDB.....	28-43
28.12.4	Performing Cross-Platform Transport of a PDB Using Inconsistent Backups	28-45
28.12.5	Performing Cross-Platform Transport of Tablespaces in a PDB	28-47

Part VIII Performing User-Managed Backup and Recovery

29 Making User-Managed Database Backups

29.1	Querying V\$ Views to Obtain Backup Information	29-1
29.1.1	Listing Database Files Before a Backup.....	29-1
29.1.2	Determining Data File Status for Online Tablespace Backups	29-2
29.2	Making User-Managed Backups of the Whole Database	29-3
29.3	Making User-Managed Backups of CDBs and PDBs	29-4
29.4	Making User-Managed Backups of Tablespaces and Data Files	29-5
29.4.1	Making User-Managed Backups of Offline Tablespaces and Data Files	29-5
29.4.2	Making User-Managed Backups of Online Tablespaces and Data Files.....	29-6
29.5	Making User-Managed Backups of Tablespaces in CDBs	29-13
29.5.1	Making User-Managed Backups of Offline Tablespaces and Data Files in CDBs.	29-13
29.5.2	Making User-Managed Backups of Online Tablespaces in CDBs and PDBs	29-14
29.6	Making User-Managed Backups of the Control File	29-14
29.6.1	Backing Up the Control File to a Binary File.....	29-14
29.6.2	Backing Up the Control File to a Trace File	29-15
29.7	Making User-Managed Backups of Archived Redo Logs	29-15
29.8	Making User-Managed Backups in SUSPEND Mode.....	29-16
29.8.1	About the Suspend/Resume Feature	29-16
29.8.2	Making Backups in a Suspended Database.....	29-17
29.9	Making User-Managed Backups to Raw Devices	29-18
29.9.1	Backing Up to Raw Devices on Linux and UNIX.....	29-18
29.9.2	Backing Up to Raw Devices on Windows	29-20
29.10	Making Backups with Third-Party Snapshot Technologies	29-22
29.11	Verifying User-Managed Data File Backups	29-23
29.11.1	Testing the Restoration of Data File Backups.....	29-23
29.11.2	Running the DBVERIFY Utility.....	29-23

30 Performing User-Managed Database Flashback and Recovery

30.1	Performing Flashback Database with SQL*Plus	30-1
30.1.1	Performing Flashback Database of non-CDBs with SQL*Plus	30-2
30.1.2	Performing Flashback Database of CDBs with SQL*Plus	30-3
30.1.3	Performing Flashback Database of PDBs with SQL*Plus.....	30-4
30.2	Overview of User-Managed Media Recovery	30-5
30.2.1	About User-Managed Restore and Recovery	30-5
30.2.2	Automatic Recovery with the RECOVER Command	30-7
30.2.3	Recovery When Archived Logs Are in the Default Location	30-8
30.2.4	Recovery When Archived Logs Are in a Nondefault Location.....	30-9
30.2.5	Recovery Using Storage Snapshot Optimization.....	30-10
30.2.6	Recovery Cancellation During User-Managed Recovery.....	30-11
30.2.7	Parallel Media Recovery.....	30-11
30.3	Performing Complete Database Recovery Using SQL*Plus.....	30-12
30.3.1	Performing Closed Database Recovery.....	30-12
30.3.2	Performing Open Database Recovery	30-16
30.3.3	Performing Crash and Instance Recovery of CDBs.....	30-19
30.4	Performing Incomplete Database Recovery	30-20
30.4.1	Performing Cancel-Based Incomplete Recovery	30-21
30.4.2	Performing Time-Based or Change-Based Incomplete Recovery	30-23
30.5	Recovering a Database in NOARCHIVELOG Mode.....	30-24
30.6	Troubleshooting Media Recovery	30-25
30.6.1	About User-Managed Media Recovery Problems.....	30-25
30.6.2	Investigating the Media Recovery Problem: Phase 1	30-28
30.6.3	Trying to Fix the Recovery Problem Without Corrupting Blocks: Phase 2	30-28
30.6.4	Deciding Whether to Allow Recovery to Mark as Corrupt Blocks: Phase 3.....	30-30
30.6.5	Allowing Recovery to Corrupt Blocks: Phase 4.....	30-31
30.6.6	Performing Trial Recovery.....	30-32

31 Performing User-Managed Recovery: Advanced Scenarios

31.1	Responding to the Loss of a Subset of the Current Control Files	31-1
31.1.1	Copying a Multiplexed Control File to a Default Location.....	31-1
31.1.2	Copying a Multiplexed Control File to a Nondefault Location	31-2
31.2	Recovering After the Loss of All Current Control Files.....	31-2
31.2.1	Recovering with a Backup Control File in the Default Location	31-4
31.2.2	Recovering with a Backup Control File in a Nondefault Location	31-5
31.2.3	Recovering Through an Added Data File with a Backup Control File	31-6
31.2.4	Recovering Read-Only Tablespaces with a Backup Control File.....	31-7
31.3	Re-Creating a Control File	31-7
31.3.1	Recovering Through a RESETLOGS with a Created Control File	31-9
31.3.2	Recovery of Read-Only Files with a Re-Created Control File	31-10
31.4	Re-Creating Data Files When Backups Are Unavailable.....	31-10

31.5	Recovering NOLOGGING Tables and Indexes	31-11
31.6	Recovering Transportable Tablespaces	31-12
31.7	Recovering After the Loss of Online Redo Log Files.....	31-13
31.7.1	Recovering After Losing a Member of a Multiplexed Online Redo Log Group....	31-13
31.7.2	Recovering After Losing All Members of an Online Redo Log Group	31-14
31.8	Recovering from a Dropped Table Without Using Flashback Features	31-18
31.9	Dropping a Database with SQL*Plus.....	31-19

Glossary

Index

Preface

This preface contains the following topics:

- [Audience](#) (page xxv)
- [Documentation Accessibility](#) (page xxv)
- [Related Documentation](#) (page xxvi)
- [Conventions](#) (page xxvi)

Audience

Backup and Recovery User's Guide is intended for database administrators who perform the following tasks:

- Back up, restore, and recover Oracle databases
- Perform maintenance on backups of database files
- Transfer data between a file system and Oracle Automatic Storage Management or between platforms when installing Oracle Database

To use this document, you must know the following:

- Relational database concepts and basic database administration as described in *Oracle Database Concepts* and the *Oracle Database Administrator's Guide*
- The operating system environment under which you run the database

Documentation Accessibility

For information about Oracle's commitment to accessibility, visit the Oracle Accessibility Program website at <http://www.oracle.com/pls/topic/lookup?ctx=acc&id=docacc>.

Access to Oracle Support

Oracle customers that have purchased support have access to electronic support through My Oracle Support. For information, visit <http://www.oracle.com/pls/topic/lookup?ctx=acc&id=info> or visit <http://www.oracle.com/pls/topic/lookup?ctx=acc&id=trs> if you are hearing impaired.

Related Documentation

For more information about backup and recovery, see these Oracle resources:

- *Oracle Database Backup and Recovery Reference*
- *Oracle Database Utilities*
- *Oracle Automatic Storage Management Administrator's Guide*

You can access information about the Backup Solutions Program (BSP) at

<http://www.oracle.com/technetwork/database/features/availability/bsp-088814.html>

Many books in the documentation set use the sample schemas of the seed database, which is installed by default when you install Oracle Database. Refer to *Oracle Database Sample Schemas* for information about how these schemas were created and how you can use them yourself.

Conventions

The following text conventions are used in this document:

Convention	Meaning
boldface	Boldface type indicates graphical user interface elements associated with an action, or terms defined in text or the glossary.
<i>italic</i>	Italic type indicates book titles, emphasis, or placeholder variables for which you supply particular values.
monospace	Monospace type indicates commands within a paragraph, URLs, code in examples, text that appears on the screen, or text that you enter.

Changes in This Release for Backup and Recovery User's Guide

This preface contains:

- [Changes in Oracle Database 12c Release 2 \(12.2.0.1\)](#) (page xxvii)
- [Changes in Oracle Database 12c Release 1 \(12.1.0.2\)](#) (page xxix)
- [Changes in Oracle Database 12c Release 1 \(12.1.0.1\)](#) (page xxx)

Changes in Oracle Database 12c Release 2 (12.2.0.1)

The following are changes in the *Oracle Database Backup and Recovery User's Guide* for Oracle Database 12c Release 2 (12.2.0.1).

New Features

- Support for restore points in PDBs

You can create a PDB restore point, which is a restore point that is specific to a single [pluggable database \(PDB\)](#). Creating a PDB restore point for a particular PDB ensures that there are no name conflicts with restore points defined for other PDBs in the [multitenant container database \(CDB\)](#).

See Also:

- [Overview of Restore Points in a Multitenant Environment](#) (page 7-6)
 - [Creating CDB Restore Points](#) (page 7-12)
 - [Creating PDB Restore Points](#) (page 7-13)
 - [Listing Restore Points Using the V\\$RESTORE_POINT View](#) (page 7-15)
-
-

- Flashback Database support for PDBs

You can perform a Flashback Database operation for a single PDB without impacting other PDBs in the [multitenant container database \(CDB\)](#). This enables you to rewind only the specified PDB, instead of the entire CDB, to a previous point in time. A Flashback Database operation on a particular PDB does not impact other PDBs in the CDB.

In Oracle Database 12c Release 1 (12.1), to perform a flashback database operation for a CDB across PDB point-in-time recovery (PITR), you had to make all data files in the PDB for which PITR was performed offline. This restriction is now removed. You can perform a flashback database operation on a CDB across PDB PITR or PDB flashback with `COMPATIBLE` set to 12.2 or higher.

See Also:

- [Basic Concepts of Performing Flashback Database for CDBs and PDBs](#) (page 18-4)
 - [Performing a Flashback Database Operation for a Whole CDB](#) (page 18-19)
 - [Performing a Flashback Database Operation for PDBs](#) (page 18-22)
 - [Performing Flashback Database with SQL*Plus](#) (page 30-1)
-
-

- Enhancements to recovering tables and table partitions

Before performing table recovery, RMAN checks if there is sufficient space on the target host to create the auxiliary instance that is used during recovery. You can also recover tables and table partitions into a schema that is different from the source schema in which they originally existed.

See Also:

- [Steps Performed By RMAN to Recover Tables and Table Partitions](#) (page 22-3)
 - [About Recovering Tables and Partitions Into a New Schema](#) (page 22-6)
 - [Example: Recovering a Table into a New Schema](#) (page 22-12)
-
-

- Enhancements to cross-platform transport

You can perform cross-platform transport of a PDB into a new CDB. Encrypted tablespaces can be transported across platforms. You can also restore and recover files across platforms and over the network.

See Also:

- [Performing Cross-Platform Transport of a Closed PDB](#) (page 28-43)
 - [Performing Cross-Platform Transport of a PDB Using Inconsistent Backups](#) (page 28-45)
 - [Steps to Transport Read-Only Tablespaces to a Different Platform Using Backup Sets](#) (page 28-30)
 - [Steps to Transport Inconsistent Tablespaces to a Different Platform](#) (page 28-35)
 - [Performing Cross-Platform Transport of Data Files Over the Network](#) (page 28-41)
-
-

- Enhancements to database duplication

You can use the `DUPLICATE` command to create an Oracle Data Guard far sync instance.

See [Duplicating the Whole Database](#) (page 25-30).

- Backup and recovery support for application containers

You can use RMAN to perform backup, complete recovery, and point-in-time recovery of application containers. This includes the application root and one or more application PDBs.

See Also:

- [Backing Up Application Containers](#) (page 9-20)
 - [Performing Complete Recovery of Application Containers](#) (page 17-29)
 - [Performing Point-in-Time Recovery of Application PDBs](#) (page 18-32)
-
-

- Backup and Recovery of Sparse Databases

RMAN enables you to perform backup, recovery, and backup-based duplication for sparse databases with the `COMPATIBLE` initialization parameter set to 12.2 or higher. You can also backup and recover individual sparse data files, tablespaces, CDBs, and PDBs.

See Also::

- [About Sparse Backups](#) (page 8-12)
 - [Backing Up Sparse Databases with RMAN](#) (page 9-22)
 - [Performing Complete Recovery of Sparse Databases](#) (page 17-32)
 - [Performing Point-in-Time Recovery of Sparse Databases](#) (page 18-33)
 - [Duplicating Sparse Databases](#) (page 25-33)
-
-

Changes in Oracle Database 12c Release 1 (12.1.0.2)

The following are changes in *Backup and Recovery User's Guide* for Oracle Database 12c Release 1 (12.1.0.2).

New Features

The following are the new features in this release:

- Oracle Virtual Private Database (VPD) for RMAN virtual private catalog

The RMAN recovery catalog is created and managed using VPD. This provides better performance and scalability when a large number of virtual private catalogs are created.

See Also:

["Creating and Managing Virtual Private Catalogs \(page 13-11\)"](#)

Changes in Oracle Database 12c Release 1 (12.1.0.1)

The following are changes in *Backup and Recovery User's Guide* for Oracle Database 12c Release 1 (12.1.0.1).

New Features

The following are new features in this release:

- Support for multitenant container databases and pluggable databases
RMAN provides backup and recovery of multitenant container databases (CDBs), which are introduced in Oracle Database 12c Release 1 (12.1). This support includes backup and point-in-time recovery of specified pluggable databases (PDBs).

See:

- ["Backing Up CDBs and PDBs \(page 9-15\)"](#)
 - ["Performing Point-in-Time Recovery of CDBs and PDBs \(page 18-28\)"](#)
 - ["Performing Crash and Instance Recovery of CDBs \(page 30-19\)"](#)
-
-

- SYSBACKUP Privilege

The SYSBACKUP administrative privilege encompasses the permissions required for backup and recovery, including the ability to connect to a closed database. System administrators can grant SYSBACKUP instead of SYSDBA to users who perform backup and recovery, thus reducing the proliferation of the SYSDBA privilege. In contrast to SYSDBA, SYSBACKUP does not include data access privileges such as `SELECT ANY TABLE`.

See:

["Making Database Connections with RMAN \(page 4-2\)"](#)

- Storage Snapshot Optimization

Storage Snapshot Optimization enables you to use third-party technologies to take a storage snapshot of your database without putting the database in BACKUP mode. You can then use the snapshot to recover all or part of the database.

See:

- ["Making Backups with Third-Party Snapshot Technologies \(page 29-22\)"](#)
 - ["Recovery Using Storage Snapshot Optimization \(page 30-10\)"](#)
-
-

- SQL Interface Improvements

You can now issue most SQL commands in RMAN without preceding the command with the SQL keyword. For a few commands that exist in both RMAN and SQL and have very different uses, you can specify the SQL keyword to eliminate ambiguity. You no longer need to enclose the SQL command in quotes, which greatly simplifies the syntax when the SQL command itself requires quotation marks. The SQL ALTER command replaces the RMAN command.

The new RMAN DESCRIBE command provides the functionality of the SQL*Plus DESCRIBE command.

See:

Oracle Database Backup and Recovery Reference

- Multisection Backup Improvements

RMAN provides multisection backup support for incremental backups and image copies. Wherever possible, unused block compression and Block Change Tracking are used in conjunction with multisection incremental backups. This improves backup and restore performance.

See:

- ["Specifying Multisection Incremental Backups \(page 9-8\)"](#)
 - ["Making Multisection Backups Using Image Copies \(page 9-9\)"](#)
-
-

- Restoring and Recovering Files Over a Network

You can now restore or recover a database, data files, tablespaces, or control files by using backup sets from a physical standby database. RMAN transfers the backup sets, over the network, to the destination host. This is useful in a Data Guard environment when you want to synchronize the standby and primary databases.

See:

["Restoring and Recovering Files Over the Network \(page 20-21\)"](#)

- Active Database Duplication Improvements

RMAN can now perform active database duplication using backup sets. When sufficient auxiliary channels are allocated, the auxiliary instance connects to the target instance and retrieves the backup sets over the network, thus reducing the processing load on the target instance. Unused block compression can be used during the duplication process, thus reducing the size of backups transported over the network. You can specify the binary compression level to be used. You can also encrypt backups and use multisection backups while performing active database duplication.

See:

["About Active Database Duplication with RMAN \(page 25-9\)"](#)

- Cross-Platform Backup and Restore Improvements

You can transport data across platforms by using full and incremental backup sets. Incremental backups can reduce overall application downtime during cross-platform data migration.

See:

[Transporting Data Across Platforms \(page 28-1\)](#)

- Recovering Tables and Table Partitions from RMAN Backups

RMAN can recover tables and table partitions to a specified point in time from previously-created RMAN backups.

See:

[Recovering Tables and Table Partitions from RMAN Backups \(page 22-1\)](#)

- Unified auditing and RMAN

Unified auditing consolidates all the Oracle Database audit records into one single audit trail. To use unified auditing, you must first upgrade your database to Oracle Database 12c Release 1 (12.1) and then migrate your database to use unified auditing.

See:

- *Oracle Database Upgrade Guide* for details about migrating your database to use unified auditing
 - *Oracle Database Security Guide* for details about how to locate RMAN unified auditing information
-
-

- DUPLICATE enhancements

You can specify that the duplicate database must not be opened using RESETLOGS after it is created. You may prefer not to open the duplicate database if you want to change the initialization parameters of the duplicate database or if opening the duplicate database may start services in the duplicate database that will conflict with the source database.

See:

["Specifying the State of the Duplicate Database \(page 25-20\)"](#)

Part I

Overview of Backup and Recovery

The chapters in this part introduce backup and recovery and explain how to devise a backup and recovery strategy:

- [Introduction to Backup and Recovery](#) (page 1-1)
- [Getting Started with RMAN](#) (page 2-1)

Introduction to Backup and Recovery

This chapter explains Oracle Database backup and recovery and summarizes the Oracle solutions. This chapter contains the following topics:

- [Purpose of Backup and Recovery](#) (page 1-1)
- [Oracle Backup and Recovery Solutions](#) (page 1-4)
- [About Oracle Flashback Technology](#) (page 1-7)
- [About Data Recovery Advisor](#) (page 1-9)
- [RMAN and Oracle Enterprise Manager Cloud Control](#) (page 1-9)
- [About Zero Data Loss Recovery Appliance](#) (page 1-11)
- [Backup and Recovery Documentation Roadmap](#) (page 1-12)

Note:

To get started with Recovery Manager (RMAN) right away, proceed to [Getting Started with RMAN](#) (page 2-1).

1.1 Purpose of Backup and Recovery

As a backup administrator, your principal duty is to devise, implement, and manage a backup and recovery strategy.

In general, the purpose of a [backup and recovery](#) strategy is to protect the database against data loss and reconstruct the database after data loss. Typically, backup administration tasks include the following:

- Planning and testing responses to different kinds of failures
- Configuring the database environment for backup and recovery
- Setting up a backup schedule
- Monitoring the backup and recovery environment
- Troubleshooting backup problems
- Recovering from data loss if the need arises

As a backup administrator, you may also be asked to perform other duties that are related to backup and recovery:

- Data archival, which involves creating a database copy for long-term storage

- Data transfer, which involves moving data from one database or one host to another

The purpose of this manual is to explain how to perform the preceding tasks.

1.1.1 About Data Protection

As a backup administrator, your primary job is making and monitoring backups for data protection.

A [backup](#) is a copy of data of a database that you can use to reconstruct data. A backup can be either a [physical backup](#) or a [logical backup](#).

Physical backups are copies of the physical files used in storing and recovering a database. These files include data files, control files, and archived redo logs. Ultimately, every physical backup is a copy of files that store database information to another location, whether on disk or on offline storage media such as tape.

Logical backups contain logical data such as tables and stored procedures. You can use Oracle Data Pump to export logical data to binary files, which you can later import into the database. The Data Pump command-line clients `expdp` and `impdp` use the `DBMS_DATAPUMP` and `DBMS_METADATA` PL/SQL packages.

Physical backups are the foundation of any sound backup and recovery strategy. Logical backups are a useful supplement to physical backups in many circumstances but are not sufficient protection against data loss without physical backups.

Unless otherwise specified, the term **backup** as used in the backup and recovery documentation refers to a physical backup. Backing up a database is the act of making a physical backup. The focus in the backup and recovery documentation set is almost exclusively on physical backups.

Most of this manual focuses on RMAN-based backup and recovery. The most noteworthy are the following:

- Incremental backups

An [incremental backup](#) stores only blocks changed since a previous backup. Thus, they provide more compact backups and faster recovery, thereby reducing the need to apply redo during [data file media recovery](#). If you enable [block change tracking](#), then you can improve performance by avoiding full scans of every input data file. You use the `BACKUP INCREMENTAL` command to perform incremental backups.
- Block media recovery

You can repair a data file with only a small number of corrupt data blocks without taking it offline or restoring it from backup. You use the `RECOVER BLOCK` command to perform [block media recovery](#).
- Binary compression

A [binary compression](#) mechanism integrated into Oracle Database reduces the size of backups.
- Encrypted backups

RMAN uses [backup encryption](#) capabilities integrated into Oracle Database to store backup sets in an encrypted format. To create encrypted backups on disk, the database must use the Advanced Security Option. To create encrypted backups directly on tape, RMAN must use the Oracle Secure Backup SBT interface, but does not require the Advanced Security Option.

- Automated database duplication

Easily create a copy of your database, supporting various storage configurations, including direct duplication between ASM databases.

- Cross-platform data conversion

Whether you use RMAN or user-managed methods, you can supplement physical backups with logical backups of schema objects made with Data Pump Export utility. You can later use Data Pump Import to re-create data after restore and recovery. Logical backups are mostly beyond the scope of the backup and recovery documentation.

See Also:

- [Backing Up the Database](#) (page 9-1)
 - [Performing User-Managed Backup and Recovery](#) (page 1)
-
-

1.1.2 About Failures that Require Database Recovery

Although several problems can halt the normal operation of an Oracle Database or affect database I/O operations, not all of them require DBA intervention.

The following problems typically require DBA intervention and data recovery: [media failure](#), user errors, and application errors. Other failures may require DBA intervention without causing data loss or requiring recovery from backup. For example, you may need to restart the database after an instance failure or allocate more disk space after statement failure because of a full data file.

Media Failures

A media failure is a physical problem with a disk that causes a failure of a read from or write to a disk file that is required to run the database. Any database file can be vulnerable to a media failure. The appropriate recovery technique following a media failure depends on the files affected and the types of backup available.

One particularly important aspect of backup and recovery is developing a [disaster recovery](#) strategy to protect against catastrophic data loss, for example, the loss of an entire database host.

User Errors

User errors occur when, either due to an error in application logic or a manual mistake, data in a database is changed or deleted incorrectly. User errors are estimated to be the greatest single cause of database downtime.

Data loss due to user error can be either localized or widespread. An example of localized damage is deleting the wrong person from the employees table. This type of damage requires surgical detection and repair. An example of widespread damage is a batch job that deletes the company orders for the current month. In this case, drastic action is required to avoid an extensive database downtime.

While user training and careful management of privileges can prevent most user errors, your backup strategy determines how gracefully you recover the lost data when user error does cause data loss.

Application Errors

Sometimes a software malfunction can corrupt data blocks. In a [physical corruption](#), which is also called a media corruption, the database does not recognize the block at all: the [checksum](#) is invalid, the block contains all zeros, or the header and footer of the block do not match. If the corruption is not extensive, then you can often repair it easily with [block media recovery](#).

See Also:

Oracle Database Utilities to learn how to use Data Pump

1.1.3 About Data Archival

Data archival, although related to data protection, serves a different purpose. An archival backup is exempted from the normal backup and recovery strategy. These backups are typically archived onto separate storage media and retained for long periods.

For example, you may need to preserve a copy of a database as it existed at the end of a business quarter. This backup is not part of the disaster recovery strategy. The media to which these backups are written are often unavailable after the backup is complete. You may send the tape into fire storage or ship a portable hard drive to a testing facility. RMAN provides a convenient way to create a backup and exempt it from your [backup retention policy](#). This type of backup is known as an [archival backup](#).

See Also:

[Making Database Backups for Long-Term Storage](#) (page 9-44)

1.1.4 About Data Transfer

RMAN backups can be used to transport databases and tablespaces across different platforms.

In some situations you may need to take a backup of a database or database component and move it to another location. For example, you can use Recovery Manager (RMAN) to create a database copy, create a tablespace copy that can be imported into another database, or move an entire database from one platform to another. These tasks are not strictly speaking part of a backup and recovery strategy, but they do require the use of database backups, and so may be included in the duties of a backup administrator.

See Also:

The chapters in [Transferring Data with RMAN](#) (page 1)

1.2 Oracle Backup and Recovery Solutions

Oracle provides multiple solutions for performing backup and recovery.

The following solutions are available when implementing a backup and recovery strategy:

- [Recovery Manager \(RMAN\)](#)
Recovery Manager is fully integrated with the Oracle Database to perform a range of backup and recovery activities, including maintaining an [RMAN repository](#) of historical data about backups. You can access RMAN through the command line or through Oracle Enterprise Manager.
- [Oracle Enterprise Manager Cloud Control](#)
Oracle Enterprise Manager Cloud Control (Cloud Control) provides a graphical front end and scheduling facilities for RMAN. You enter job parameters, specify a job schedule, and Cloud Control runs RMAN to conduct the backup and recovery operations.
- [Zero Data Loss Recovery Appliance \(Recovery Appliance\)](#)
Recovery Appliance is a cloud-scale Engineered System that provides data protection for all Oracle Databases in the enterprise. Integrated with RMAN and Cloud Control, the Recovery Appliance provides a single repository for backups of multiple databases as described in "[About Zero Data Loss Recovery Appliance \(page 1-11\)](#)".
- User-managed backup and recovery
In this solution, you perform backup and recovery with a mixture of host operating system commands and SQL*Plus recovery commands. You are responsible for determining all aspects of when and how backups and recovery are done.

These solutions are supported by Oracle and are fully documented, but RMAN is the preferred solution for database backup and recovery. RMAN provides a common interface for backup tasks across different host operating systems, and offers several backup techniques not available through user-managed methods.

See Also:

"[RMAN and Oracle Enterprise Manager Cloud Control \(page 1-9\)](#)"

1.3 Comparison of Oracle Backup Techniques

You can use multiple techniques to create backups of the Oracle Database. This section compares the Recovery Manager (RMAN), user-managed backups, and Data Pump techniques.

[Table 1-1](#) (page 1-5) summarizes the features of the different backup techniques.

Table 1-1 Feature Comparison of Backup Techniques

Feature	Recovery Manager	User-Managed	Data Pump Export
Closed database backups	Supported. Requires instance to be mounted.	Supported.	Not supported.

Table 1-1 (Cont.) Feature Comparison of Backup Techniques

Feature	Recovery Manager	User-Managed	Data Pump Export
Open database backups	Supported. No need to use BEGIN/END BACKUP statements.	Supported. Must use BEGIN/END BACKUP statements.	Requires rollback or undo segments to generate consistent backups.
Incremental backups	Supported.	Not supported.	Not supported.
Corrupt block detection	Supported. Identifies corrupt blocks and logs in V \$DATABASE_BLOCK_CORRUPTION.	Not supported.	Supported. Identifies corrupt blocks in the export log.
Automatic specification of files to include in a backup	Supported. Establishes the name and locations of all files to be backed up (whole database, tablespaces, data files, control files, and so on).	Not supported. Files to be backed up must be located and copied manually.	Not applicable.
Backup repository	Supported. Backups are recorded in the control file, which is the main repository of RMAN metadata. Additionally, you can store this metadata in a recovery catalog , which is a schema in a different database.	Not supported. DBA must keep own records of backups.	Not supported.
Backups to a media manager	Supported. Interfaces with a media management software . RMAN also supports proxy copy, a feature that enables a media manager to manage completely the transfer of data between disk and backup media.	Supported. Backup to tape is manual or controlled by a media manager.	Not supported.
Backup of initialization parameter file	Supported.	Supported.	Not supported.
Backup of password and networking files	Not supported.	Supported.	Not supported.
Platform-independent language for backups	Supported.	Not supported.	Supported.

1.4 About Oracle Flashback Technology

Oracle Flashback technology provides a set of features that complements your physical backup and recovery strategy.

[Oracle Flashback Technology](#) provides an additional layer of data protection. Specifically, you can use the various features of Oracle Flashback to view past states of data and rewind your database without restoring backups or performing [point-in-time recovery](#). In general, flashback features are more efficient and less disruptive than media recovery in most situations in which they apply.

Oracle Flashback Technology enables you to use the following functionality:

- [Logical Flashback Features](#) (page 1-7)
- [Flashback Database](#) (page 1-8)

1.4.1 Logical Flashback Features

The logical-level flashback features of Oracle Database do not depend on RMAN and are available whether or not RMAN is part of your backup strategy.

Most of the flashback features of Oracle operate at the logical level, enabling you to view and manipulate database objects. Except for Oracle Flashback Drop, the logical flashback features rely on **undo data**, which are records of the effects of each database update and the values overwritten in the update.

Oracle Database includes the following logical flashback features:

- **Oracle Flashback Query**
You can specify a target time and run queries against a database, viewing results as they would appear at the target time. To recover from an unwanted change like an update to a table, you could choose a target time before the error and run a query to retrieve the contents of the lost rows. *Oracle Database Development Guide* explains how to use this feature.
- **Oracle Flashback Version Query**
You can view all versions of all rows that ever existed in one or more tables in a specified time interval. You can also retrieve metadata about the differing versions of the rows, including start and end time, operation, and transaction ID of the transaction that created the version. You can use this feature to recover lost data values and to audit changes to the tables queried. *Oracle Database Development Guide* explains how to use this feature.
- **Oracle Flashback Transaction Query**
You can view changes made by a single transaction, or by all the transactions during a specific time period. *Oracle Database Development Guide* explains how to use this feature.
- **Oracle Flashback Transaction**
You can reverse a transaction. Oracle Database determines the dependencies between transactions and in effect creates a compensating transaction that reverses the unwanted changes. The database rewinds to a state as if the transaction, and any transactions that could be dependent on it, had never happened. *Oracle Database Development Guide* explains how to use this feature.

- Oracle Flashback Table
You can recover a table or set of tables to a specified point in time earlier without taking any part of the database offline. In many cases, Flashback Table eliminates the need to perform more complicated point-in-time recovery operations. Flashback Table restores tables while automatically maintaining associated attributes such as current indexes, triggers, and constraints, and in this way enabling you to avoid finding and restoring database-specific properties. "[Rewinding a Table with Flashback Table](#) (page 18-7)" explains how to use this feature.
- Oracle Flashback Drop
You can reverse the effects of a `DROP TABLE` statement. "[Rewinding a DROP TABLE Operation with Flashback Drop](#) (page 18-10)" explains how to use this feature.

A [flashback data archive](#) enables you to use some logical flashback features to access data from far back in the past. A flashback data archive consists of one or more tablespaces or parts of tablespaces. When you create a flashback data archive, you specify the name, retention period, and tablespace. You can also specify a default flashback data archive. The database automatically purges old historical data the day after the retention period expires.

You can turn flashback archiving on and off for individual tables. By default, flashback archiving is turned off for every table.

See Also:

- [Performing Flashback and Database Point-in-Time Recovery](#) (page 18-1) to learn how to perform Flashback Table and Flashback Drop
 - *Oracle Database Development Guide* for more information on the logical flashback features
-
-

1.4.2 Flashback Database

Flashback Database enables you to revert an Oracle Database to a previous point in time.

At the physical level, [Oracle Flashback Database](#) provides a more efficient data protection alternative to [database point-in-time recovery \(DBPITR\)](#). If the current data files have unwanted changes, then you can use the RMAN command `FLASHBACK DATABASE` to revert the data files to their contents at a past time. The end product is much like the result of a DBPITR, but is generally much faster because it does not require restoring data files from backup and requires less redo than media recovery.

Flashback Database uses [flashback logs](#) to access past versions of data blocks and some information from archived redo logs. Flashback Database requires that you configure a [fast recovery area](#) for a database because the flashback logs can only be stored there. Flashback logging is not enabled by default. Space used for flashback logs is managed automatically by the database and balanced against space required for other files in the fast recovery area.

Oracle Database also supports restore points along with Flashback Database and backup and recovery. A [restore point](#) is an alias corresponding to a [system change number \(SCN\)](#). You can create a restore point at any time if you anticipate needing to return part or all of a database to its contents at that time. A [guaranteed restore point](#)

ensures that you can use Flashback Database to return a database to the time of the restore point.

See Also:

["Rewinding a Database with Flashback Database" \(page 18-15\)](#) to learn how to perform Flashback Database with the `FLASHBACK DATABASE` command

1.5 About Data Recovery Advisor

The Data Recovery Advisor provides a single point of entry for Oracle backup and recovery solutions. It is a tool that automatically diagnoses persistent data failures, presents appropriate repair options, and executes repairs at your request.

You can use the [Data Recovery Advisor](#) through Oracle Enterprise Manager or through the RMAN command-line client.

A database failure usually manifests itself as a set of symptoms: error messages, alerts, trace files and dumps, and failed data integrity checks. Data Recovery Advisor automatically diagnoses and informs you of these failures. For Data Recovery Advisor, a **failure** is a persistent data corruption that can be directly mapped to a set of repair actions. Each failure has a status of open or closed. Each failure also has a priority of critical, high, or low.

Failures are detected by data integrity checks, which are diagnostic procedures executed to assess the health of the database or its components. If a [data integrity check](#) reveals a failure, then Data Recovery Advisor automatically assesses the effect of a set of failures and maps it to a set of repair options. Usually, Data Recovery Advisor presents both automated and manual repair options.

Data Recovery Advisor determines the best automated repair option and its effect on the database. The [repair option](#) may include repairs such as data file restore and recovery, media recovery, Flashback Database, and so on. Before presenting an automated repair option, Data Recovery Advisor validates it for the specific environment and the availability of media components required to complete the proposed repair.

If you choose an automated repair option, then RMAN coordinates sessions on the Oracle Database to perform the [repair](#) for you. The Data Recovery Advisor tool verifies the repair success and closes the appropriate failures.

See Also:

[Diagnosing and Repairing Failures with Data Recovery Advisor](#) (page 15-1), to learn how to use Data Recovery Advisor

1.6 RMAN and Oracle Enterprise Manager Cloud Control

RMAN functionality can also be accessed using Oracle Enterprise Manager Cloud Control.

This section contains:

- [About Oracle Enterprise Manager Cloud Control](#) (page 1-10)
- [Accessing the Database Home Page Using Cloud Control](#) (page 1-10)

- [Performing Backup and Recovery Tasks with Cloud Control](#) (page 1-11)

1.6.1 About Oracle Enterprise Manager Cloud Control

Oracle Enterprise Manager Cloud Control (Cloud Control) is a browser-based management interface for Oracle Database.

Cloud Control provides a graphical front end and scheduling facilities for RMAN. You enter job parameters, specify a job schedule, and Cloud Control runs RMAN at the designated time or designated repeat interval to conduct the backup and recovery operations. Cloud Control provides access to RMAN through a set of wizards. These wizards lead you through a variety of recovery procedures based on an analysis of your database, your available backups, and your data recovery objectives.

By using Cloud Control, you can perform the simpler restore and recovery scenarios outlined in this documentation. You can also use more sophisticated restore and recovery techniques such as point-in-time recovery and Oracle Flashback operations, which allow for efficient repair of media failures and user errors. Using Cloud Control is often simpler than the RMAN command-line client.

To use Cloud Control, you start by accessing the Database Home page as described in [Accessing the Database Home Page Using Cloud Control](#) (page 1-10).

[Performing Backup and Recovery Tasks with Cloud Control](#) (page 1-11) describes how to use Cloud Control for backup and recovery.

1.6.2 Accessing the Database Home Page Using Cloud Control

The Database Home page is the main database management page in Oracle Enterprise Manager Cloud Control (Cloud Control).

After you log in to Cloud Control, you go to the Database Home page for the target database for backup and recovery tasks.

To access the Database Home page in Cloud Control:

1. Start Cloud Control.

The URL for accessing Cloud Control has the following syntax:

```
http://hostname.domain:portnumber/em
```

Obtain the URL from your Oracle Enterprise Manager administrator or your database administrator.

2. On the Welcome page, enter your Cloud Control user name and password, and then click **Login**.
3. From the **Targets** menu, select **Databases**.
4. On the Databases page, if not already selected, select **Search List** to display a list of the available target databases.
5. Select the target database that you want to modify by clicking the database name.
The home page for the target database appears. The first time that you interact with the database (for example, by selecting from the menu options), the Database Login page appears.
6. On the login page for the target database, log in as a user with the appropriate privileges. For example, to log in as user SYS with the SYSDBA privilege:

- **User Name:** Enter SYS.
- **Password:** Enter the SYS user's password.
- **Connect As:** From the list, select **Sysdba Role**.

1.6.3 Performing Backup and Recovery Tasks with Cloud Control

You can perform a variety of both simple and advanced backup and recovery tasks with Oracle Enterprise Manager Cloud Control (Cloud Control).

To perform backup and recovery tasks with Cloud Control:

1. Access the Database Home page for the target database as described in [Accessing the Database Home Page Using Cloud Control](#) (page 1-10).
2. From the Availability menu, select **Backup and Recovery**, and then select an option.

1.7 About Zero Data Loss Recovery Appliance

Zero Data Loss Recovery Appliance (Recovery Appliance) is a cloud-scale Engineered System that is designed to protect all the Oracle Databases in your enterprise. It achieves significant efficiencies in performance and manageability of backups by offloading most Oracle Database backup and restore processing to a centralized Recovery Appliance.

Recovery Appliance stores and manages backups of multiple databases on a unified disk pool, using an incremental-forever backup strategy described in "[About the Incremental-Forever Backup Strategy for Recovery Appliance](#) (page 8-21)". It continually compresses, deduplicates, and validates backups at the Oracle block level, while quickly creating full virtual backups on demand.

See Also:

Zero Data Loss Recovery Appliance Protected Database Configuration Guide for information about the advantages of Recovery Appliance

Multiple client databases—known as protected databases—share a single, centrally-managed Recovery Appliance catalog that resides on the Recovery Appliance. All protected databases that send backups to Recovery Appliance must use this catalog. Virtual private catalog technology enforces separation of duties among the protected database DBAs and the Recovery Appliance administrator.

Real-time redo transport minimizes the window of potential data loss that exists between successive archived log backups. Redo data from the protected database is written directly to the recovery appliance as it is generated.

Recovery Appliance is integrated with Cloud Control and RMAN. An accompanying media management library is used for communication between RMAN and Recovery Appliance. Cloud Control enables administrators to centrally manage and monitor the data protection of all protected databases in the enterprise.

Oracle Secure Backup, the tape management component of Recovery Appliance, is preinstalled on Recovery Appliance. For disaster recovery, Recovery Appliance can replicate backups to other Recovery Appliances. A single Recovery Appliance can

service multiple protected databases of different versions and from different platforms.

See Also:

- *Zero Data Loss Recovery Appliance Administrator's Guide*
 - *Zero Data Loss Recovery Appliance Protected Database Configuration Guide*
-
-

1.7.1 Using RMAN with Recovery Appliance

You can use most RMAN commands to back up to and recover from Zero Data Loss Recovery Appliance (Recovery Appliance).

To make backups to Recovery Appliance, you must first set the required configuration parameters and allocate one or more SBT channels.

See Also:

- [About RMAN in a Recovery Appliance Environment](#) (page 3-10)
 - [About Real-Time Redo Transport for Recovery Appliance](#) (page 17-2)
 - [About the Incremental-Forever Backup Strategy for Recovery Appliance](#) (page 8-21)
 - [Configuring RMAN to Make Backups to Recovery Appliance](#) (page 5-16)
 - *Zero Data Loss Recovery Appliance Protected Databases Configuration Guide* for information about RMAN commands with modified behavior in Recovery Appliance
-
-

1.8 Backup and Recovery Documentation Roadmap

The backup and recovery documentation roadmap is divided into two main paths: RMAN and user-managed backup and recovery. Optional paths are shown as splitting off and then rejoining each main path.

[Figure 1-1](#) (page 1-13) illustrates the recommended way to navigate the backup and recovery documentation. You can either implement your backup and recovery strategy with RMAN, which is recommended, or with user-managed tools.

Figure 1-1 Backup and Recovery Documentation Roadmap

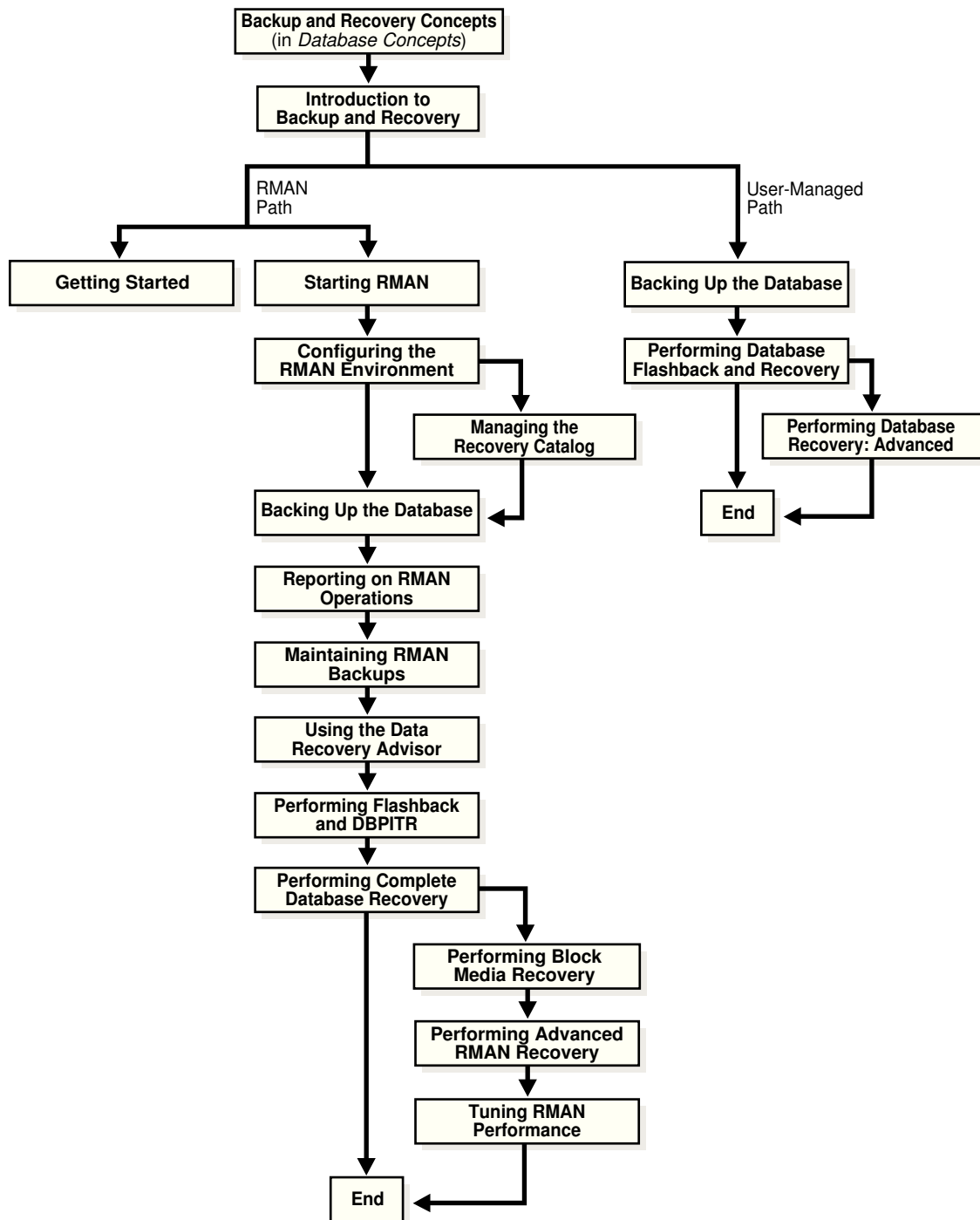

If you are new to Oracle Database and want to learn about backup recovery, then the best entry point is the discussion of basic backup and recovery principles in *Oracle Database Concepts*.

1.8.1 Recovery Manager Documentation Roadmap

This section provides a roadmap for navigating the backup and recovery documentation when using RMAN as your principal backup and recovery solution.

Begin by reading "[Getting Started with RMAN](#) (page 2-1)". This brief chapter, which explains the most basic RMAN techniques, may be adequate for your purposes. For a more comprehensive explanation of how to implement a backup and recovery strategy with RMAN, read the chapters in the following order (optional chapters are not listed):

1. Read [Starting and Interacting with the RMAN Client](#) (page 4-1).
This chapter explains how to start the RMAN client and connect to databases.
2. Read [Configuring the RMAN Environment](#) (page 5-1).
This chapter explains how to perform basic tasks such as configuring a [fast recovery area](#), [backup retention policy](#), and [archived redo log deletion policy](#).
3. Read [Backing Up the Database](#) (page 9-1).
This chapter explains how to implement a basic backup strategy.
4. Read [Reporting on RMAN Operations](#) (page 11-1).
This chapter explains how to monitor RMAN backup and recovery operations. Specifically, the chapter explains how to use the reporting commands (`LIST`, `REPORT`, and `SHOW`) and the relevant V\$ and recovery catalog views.
5. Read [Maintaining RMAN Backups and Repository Records](#) (page 12-1).
This chapter explains how to verify the existence of backups, change the repository status of backups, delete backups, and perform other maintenance tasks.
6. Read [Diagnosing and Repairing Failures with Data Recovery Advisor](#) (page 15-1).
This chapter explains how to use the Data Recovery Advisor tool. You can use it to list failures, obtain advice about to respond to these failures, and in some cases automatically repair the failures.
7. Read [Performing Flashback and Database Point-in-Time Recovery](#) (page 18-1).
This chapter explains how to use the `FLASHBACK DATABASE` command and perform point-in-time recovery with the `RECOVER DATABASE` command.
8. Read [Performing Complete Database Recovery](#) (page 17-1).
This chapter explains how to recover individual tablespaces or the database.

1.8.2 User-Managed Backup and Recovery Documentation Roadmap

This section provides a roadmap for navigating the backup and recovery documentation when you do *not* use RMAN as your principal backup and recovery solution.

In this case, you must use third-party tools to make your backups and SQL or SQL*Plus commands to perform recovery. Read the chapters in the following order:

1. Read [Making User-Managed Database Backups](#) (page 29-1).
This chapter explains how to make backups with third-party tools.
2. Read [Performing User-Managed Database Flashback and Recovery](#) (page 30-1).

This chapter explains how to use the SQL statement `FLASHBACK DATABASE` and to perform recovery with the SQL*Plus `RECOVER` command.

3. Read [Performing User-Managed Recovery: Advanced Scenarios](#) (page 31-1).

This chapter explains various recovery scenarios.

Getting Started with RMAN

This chapter is intended for new users who want to start using RMAN right away without first reading the more detailed chapters in this book. This chapter provides the briefest possible digest of the most important RMAN concepts and tasks. It is not a substitute for the rest of the backup and recovery documentation set.

This chapter contains the following topics:

- [Overview of the RMAN Environment](#) (page 2-1)
- [Starting RMAN and Connecting to a Database](#) (page 2-2)
- [Showing the Default RMAN Configuration](#) (page 2-3)
- [Backing Up a Database](#) (page 2-4)
- [Reporting on RMAN Operations](#) (page 2-10)
- [Maintaining RMAN Backups](#) (page 2-12)
- [Diagnosing and Repairing Failures with Data Recovery Advisor](#) (page 2-13)
- [Rewinding a Database with Flashback Database](#) (page 2-15)
- [Restoring and Recovering Database Files](#) (page 2-16)

2.1 Overview of the RMAN Environment

Recovery Manager (RMAN) is an Oracle Database client that performs backup and recovery tasks on your databases and automates administration of your backup strategies. It greatly simplifies backing up, restoring, and recovering database files.

The RMAN environment consists of the utilities and databases that play a role in backing up your data. At a minimum, the environment for RMAN must include the following components:

- [A target database](#)

An Oracle Database to which RMAN is connected with the `TARGET` keyword. A target database is a database on which RMAN is performing backup and recovery operations. RMAN always maintains metadata about its operations on a database in the control file of the database. The RMAN metadata is known as the [RMAN repository](#).
- [The RMAN client](#)

An Oracle Database executable that interprets commands, directs server sessions to execute those commands, and records its activity in the target database control file. The RMAN executable is automatically installed with the database and is

typically located in the same directory as the other database executables. For example, the RMAN client on Linux is located in `$ORACLE_HOME/bin`.

Some environments use the following optional components:

- A [fast recovery area](#)
A disk location in which the database can store and manage files related to backup and recovery. You set the fast recovery area location and size with the `DB_RECOVERY_FILE_DEST` and `DB_RECOVERY_FILE_DEST_SIZE` initialization parameters.
- A [media management software](#)
An application required for RMAN to interact with sequential media devices such as tape libraries. A media manager controls these devices during backup and recovery, managing the loading, labeling, and unloading of media. Media management devices are sometimes called **SBT** (system backup to tape) devices.
- A [recovery catalog](#)
A separate database schema used to record RMAN activity against one or more target databases. A recovery catalog preserves RMAN repository metadata if the control file is lost, making it much easier to restore and recover following the loss of the control file. The database may overwrite older records in the control file, but RMAN maintains records forever in the catalog unless the records are deleted by the user.

This chapter explains how to use RMAN in the most basic configuration, which is *without* a recovery catalog or media manager.

See Also:

- [Recovery Manager Architecture](#) (page 3-1) for a more detailed overview of the RMAN environment
 - *Oracle Database Backup and Recovery Reference* for BACKUP command syntax and semantics
-
-

2.2 Starting RMAN and Connecting to a Database: Quick Start

Before you perform any operations using RMAN, you must connect to a target database.

The RMAN client is started by issuing the `rman` command at the command prompt of your operating system. RMAN displays a prompt for your commands as shown in the following example:

```
% rman
RMAN>
```

RMAN connections to a database are specified and authenticated in the same way as SQL*Plus connections to a database. The only difference is that RMAN connections to a target or auxiliary database require either the `SYSDBA` or `SYSBACKUP` privilege. Any user can be granted this privilege.

Caution:

Good security practice requires that you not enter passwords in plain text on the command line. Enter passwords in RMAN only when requested by an RMAN prompt. See *Oracle Database Security Guide* to learn about password protection.

You can connect to a database with command-line options or by using the `CONNECT TARGET` command. The following example starts RMAN and then connects to a target database through Oracle Net as user `sbu`, which is created with the `SYSBACKUP` privilege. RMAN prompts for a password.

```
% rman
RMAN> CONNECT TARGET "sbu@prod AS SYSBACKUP"

target database Password: password
connected to target database: PROD (DBID=39525561)
```

When using the [multitenant architecture](#), you can connect to the `root` or to a specified [pluggable database \(PDB\)](#) as described in "[Making RMAN Connections to a CDB \(page 4-7\)](#)".

To quit the RMAN client, enter `EXIT` at the RMAN prompt:

```
RMAN> EXIT
```

Syntax of Common RMAN Command-line Options

```
RMAN
[ TARGET connectStringSpec
| { CATALOG connectStringSpec }
| LOG ['] filename ['] [ APPEND ]
.
.
.
]...

connectStringSpec::=
['] [userid] [/ [password]] [net_service_name] [']
```

The following example appends the output from an [RMAN session](#) to a text file at `/tmp/msglog.log`

```
% rman TARGET / LOG /tmp/msglog.log APPEND
```

See Also:

[Starting and Interacting with the RMAN Client](#) (page 4-1), to learn more about starting and using the RMAN client

2.3 Showing the Default RMAN Configuration

The RMAN backup and recovery environment is preconfigured for each target database. The configuration is persistent and applies to all subsequent operations on this target database, even if you exit and restart RMAN.

RMAN configuration settings can specify backup devices, set up connections to those devices (known as [channels](#)), set policies affecting backup strategy, and more.

To show the current configuration for a database:

1. Start RMAN and connect to a target database as described in "[Starting RMAN and Connecting to a Database](#) (page 2-2)".
2. Run the `SHOW ALL` command.

For example, enter the command at the RMAN prompt as follows:

```
RMAN> SHOW ALL;
```

The output lists the `CONFIGURE` commands to re-create this configuration.

See Also:

[Configuring the RMAN Environment](#) (page 5-1), and [Configuring the RMAN Environment: Advanced Topics](#) (page 6-1), to learn how to configure the RMAN environment

2.4 Backing Up a Database: Quick Start

Use the `BACKUP` command to back up files. RMAN backs up data to the configured default device for the type of backup requested.

By default, RMAN creates backups on disk. If a fast recovery area is enabled, and if you do not specify the `FORMAT` parameter (see [Table 2-1](#) (page 2-5)), then RMAN creates backups in the recovery area and automatically gives them unique names.

By default, RMAN creates backup sets rather than image copies. A [backup set](#) consists of one or more backup pieces, which are physical files written in a format that only RMAN can access. A [multiplexed backup set](#) contains the blocks from multiple input files. RMAN can write backup sets to disk or tape.

If you specify `BACKUP AS COPY`, then RMAN copies each file as an [image copy](#), which is a bit-for-bit copy of a database file created on disk. Image copies are identical to copies created with operating system commands like `cp` on Linux or `COPY` on Windows, but are recorded in the RMAN repository and so are usable by RMAN. You can use RMAN to make image copies while the database is open.

The following sections describe backing up databases in different modes:

- [About Typical RMAN Backup Options](#) (page 2-5)
- [Backing Up a Database in ARCHIVELOG Mode](#) (page 2-5)
- [Backing Up a Database in NOARCHIVELOG Mode](#) (page 2-6)
- [Making Incremental Backups](#) (page 2-7)
- [Making Incrementally Updated Backups](#) (page 2-8)
- [Scripting RMAN Operations](#) (page 2-9)

See Also:

- [RMAN Backup Concepts](#) (page 8-1), to learn concepts relating to RMAN backups
- [Backing Up the Database](#) (page 9-1), to learn how to back up database files with RMAN
- *Oracle Database Backup and Recovery Reference* for BACKUP command syntax and semantics

2.4.1 About Typical RMAN Backup Options

The BACKUP command includes a host of options, parameters, and clauses that control backup output.

[Table 2-1](#) (page 2-5) lists some typical backup options.

Table 2-1 Common Backup Options

Option	Description	Example
FORMAT	Specifies a location and name for backup pieces and copies. You must use substitution variables to generate unique file names. The most common substitution variable is %U, which generates a unique name. Others include %d for the DB_NAME, %t for the backup set time stamp, %s for the backup set number, and %p for the backup piece number.	<pre>BACKUP FORMAT 'AL_ %d/%t/%s/%p' ARCHIVELOG LIKE 'arc_dest%';</pre>
TAG	Specifies a user-defined string as a label for the backup. If you do not specify a tag, then RMAN assigns a default tag with the date and time. Tags are always stored in the RMAN repository in uppercase.	<pre>BACKUP TAG 'weekly_full_db_bkup ' DATABASE MAXSETSIZE 10M;</pre>

See Also:

- "[Specifying Backup Output Options](#) (page 9-2)"
- *Oracle Database Backup and Recovery Reference* for information about the format options

2.4.2 Backing Up a Database in ARCHIVELOG Mode

If a database runs in ARCHIVELOG mode, then you can back up the database while it is open.

A backup is called an [inconsistent backup](#) if it contains changes after its checkpoint. If you have the archived redo logs needed to recover the backup, open database backups are as effective for data protection as consistent backups.

To back up the database and archived redo logs while the database is open:

1. Start RMAN and connect to a target database as described in "[Starting RMAN and Connecting to a Database](#) (page 2-2)".
2. Run the `BACKUP DATABASE` command.

For example, enter the following command at the RMAN prompt to back up the database and all archived redo log files to the default backup device:

```
RMAN> BACKUP DATABASE PLUS ARCHIVELOG;
```

2.4.3 Backing Up a Database in NOARCHIVELOG Mode

If a database runs in NOARCHIVELOG mode, then the only valid database backup is a consistent backup.

For the backup to be consistent, the database must be mounted after a consistent shutdown. Recovery is not specifically required after restoring the backup, but you would lose any transactions made after the backup. You can recover with archived logs from a [consistent backup](#) to minimize data loss.

To make a consistent database backup:

1. Start RMAN and connect to a target database as described in "[Starting RMAN and Connecting to a Database](#) (page 2-2)".
2. Shut down the database consistently and then mount it.

For example, enter the following commands to *guarantee* that the database is in a consistent state for a backup:

```
RMAN> SHUTDOWN IMMEDIATE;  
RMAN> STARTUP FORCE DBA;  
RMAN> SHUTDOWN IMMEDIATE;  
RMAN> STARTUP MOUNT;
```

3. Run the `BACKUP DATABASE` command.

For example, enter the following command at the RMAN prompt to back up the database to the default backup device:

```
RMAN> BACKUP DATABASE;
```

The following variation of the command creates image copy backups of all data files in the database:

```
RMAN> BACKUP AS COPY DATABASE;
```

4. Open the database and resume normal operations.

The following command opens the database:

```
RMAN> ALTER DATABASE OPEN;
```

2.4.4 Making Incremental Backups: Quick Start

Incremental backups capture block-level changes to a database made after a previous incremental backup.

If you specify `BACKUP INCREMENTAL`, then RMAN creates an [incremental backup](#) of a database. Incremental backups are generally smaller and faster to make than full database backups. Recovery with incremental backups is faster than using redo logs alone.

The starting point for an incremental backup strategy is a [level 0 incremental backup](#), which backs up all blocks in the database. An incremental backup at level 0 is identical in content to a [full backup](#), however, unlike a full backup the level 0 backup is considered a part of the incremental backup strategy.

A level 1 incremental backup contains only blocks changed after a previous incremental backup. If no level 0 backup exists in either the current or parent database [incarnation](#) when you run a level 1 backup, then RMAN makes a level 0 backup automatically.

Note:

You cannot make incremental backups when a `NOARCHIVELOG` database is open, although you can make incremental backups when the database is mounted after a consistent shutdown.

A level 1 backup can be a [cumulative incremental backup](#), which includes all blocks changed since the most recent level 0 backup, or a [differential incremental backup](#), which includes only blocks changed since the most recent incremental backup. Incremental backups are differential by default.

During a restore operation, RMAN will first restore a level 0 backup, then automatically apply incremental backups and redo logs as needed. This will re-apply the changes that were made to the database since the start of the backup.

To make incremental backups of the database:

1. Start RMAN and connect to a target database as described in "[Starting RMAN and Connecting to a Database](#) (page 2-2)".
2. Run the `BACKUP INCREMENTAL` command.

The following example creates a level 0 incremental backup to serve as a base for an incremental backup strategy:

```
BACKUP INCREMENTAL LEVEL 0 DATABASE;
```

The following example creates a level 1 cumulative incremental backup:

```
BACKUP INCREMENTAL LEVEL 1 CUMULATIVE DATABASE;
```

The following example creates a level 1 differential incremental backup:

```
BACKUP INCREMENTAL LEVEL 1 DATABASE;
```

See Also:

"[About RMAN Incremental Backups](#) (page 8-17)" for a more detailed conceptual overview of incremental backups and "[Making and Updating RMAN Incremental Backups](#) (page 9-33)"

2.4.5 Making Incrementally Updated Backups

Incrementally updated backups enable you to implement an efficient incremental forever backup strategy.

The RMAN [incrementally updated backup](#) feature has the following main features:

- The strategy requires a level 0 data file copy as a base. This copy has either a system-defined or user-defined tag.
- Periodically, level 1 differential backups are created with the same tag as the level 0 data file copy. The `BACKUP FOR RECOVER OF COPY` command specifies that an incremental backup contains *only* blocks changed since the most recent incremental backup with the same tag.
- Periodically, the incremental backups are applied to the level 0 data file copy. Because the data file copy has been updated with more recent changes, it now requires less media recovery.

[Table 2-2](#) (page 2-8) explains which options to use with `FOR RECOVER OF COPY` to implement an incrementally updated backup strategy.

Table 2-2 FOR RECOVER OF COPY Options

BACKUP Option	Description	Example
FOR RECOVER OF COPY WITH TAG 'tag_name'	Use TAG to identify the tag of the data file copy serving as basis for the backup strategy. RMAN automatically assigns the same tag to every level 1 backup of this copy. If no level 0 data file copy with the specified tag exists in either the current or parent database incarnation , then RMAN creates a level 0 data file copy with the specified tag.	<pre> BACKUP INCREMENTAL LEVEL 1 FOR RECOVER OF COPY WITH TAG 'incr_update' DATABASE;</pre>
FOR RECOVER OF COPY DATAFILECOPY FORMAT 'format'	Specifies where RMAN creates the data file copy if a copy does not exist. If you add a new data file to the database, then you do not need to change your script, because RMAN automatically creates the level 0 copy required by the incremental backup routine.	<pre> BACKUP INCREMENTAL LEVEL 1 FOR RECOVER OF COPY DATAFILECOPY FORMAT '/disk2/df1.cpy' DATABASE;</pre>

To implement an incrementally updated backup strategy:

1. Start RMAN and connect to a target database as described in "[Starting RMAN and Connecting to a Database](#) (page 2-2)".
2. Run the `RECOVER COPY` and `BACKUP INCREMENTAL` commands.

The following script, run on a regular basis, is all that is required to implement a strategy based on incrementally updated backups.

```
RECOVER COPY OF DATABASE
  WITH TAG 'incr_update';
BACKUP
  INCREMENTAL LEVEL 1
  FOR RECOVER OF COPY WITH TAG 'incr_update'
  DATABASE;
```

See Also:

["Incrementally Updating Backups \(page 9-36\)"](#)

2.4.6 Validating Database Files and Backups: Quick Start

RMAN validation checks a backup to determine whether it can be restored. Validation also checks for corrupt blocks and missing files.

Use the `VALIDATE` command to confirm that all database files exist, are in their correct location, and are free of physical corruption. The `CHECK LOGICAL` option also checks for logical block corruption.

To validate database files:

1. Start RMAN and connect to a target database as described in "[Starting RMAN and Connecting to a Database \(page 2-2\)](#)".
2. Run the `BACKUP VALIDATE . . .` command for the desired files.

For example, enter the following commands to validate all database files and archived redo log files for physical and logical corruption:

```
BACKUP VALIDATE CHECK LOGICAL
  DATABASE ARCHIVELOG ALL;
```

You can also use the `VALIDATE` command to check individual data blocks, as shown in the following example:

```
VALIDATE DATAFILE 4 BLOCK 10 TO 13;
```

You can also validate backup sets, as shown in the following example:

```
VALIDATE BACKUPSET 3;
```

You specify backup sets by primary key, which is shown in the output of the `LIST BACKUP` command.

See Also:

- [Validating Database Files and Backups \(page 16-1\)](#)
 - *Oracle Database Backup and Recovery Reference* for `VALIDATE` command syntax and semantics
-
-

2.4.7 Scripting RMAN Operations

RMAN supports the use of command files to manage recurring tasks such as weekly backups.

A [command file](#) is a client-side text file containing RMAN commands, exactly as you enter them at the RMAN prompt. You can use any file extension.

Stored scripts are an alternative to command files that allow scripts to be available to any RMAN client that can connect to the target database and its recovery catalog.

To create and run a command file:

1. Use a text editor to create a command file.

For example, create a command file with the following contents:

```
# my_command_file.txt
CONNECT TARGET /
BACKUP DATABASE PLUS ARCHIVELOG;
LIST BACKUP;
EXIT;
```

2. Start RMAN and then execute the contents of a command file by running the @ command at the RMAN prompt:

```
@/my_dir/my_command_file.txt # runs specified command file
```

You can also start RMAN with a command file to run, as shown here:

```
% rman @/my_dir/my_command_file.txt
```

See Also:

- ["Using Command Files with RMAN" \(page 4-13\)](#) to learn more about command files
 - ["Using Substitution Variables in Command Files" \(page 4-14\)](#) to learn how to use substitution variables in command files and pass parameters at run time
-
-

2.5 Reporting on RMAN Operations: Quick Start

RMAN can use the information stored in the RMAN repository to generate reports on backup activities.

Use the RMAN `LIST` and `REPORT` commands for reporting on backup operations. Use the `SHOW ALL` command to display the current RMAN configuration. In addition, RMAN provides a comprehensive set of views for generating custom reports.

This section contains the following topics:

- [Listing Backups](#) (page 2-10)
- [Reporting on Database Files and Backups](#) (page 2-11)

2.5.1 Listing Backups: Quick Start

The `LIST BACKUP` and `LIST COPY` commands display information about backups and data file copies listed in the repository.

For backups, you can control the format of `LIST` output with the options in [Table 2-3](#) (page 2-11) and [Table 2-4](#) (page 2-11).

Table 2-3 LIST Options for Backups

Option	Example	Explanation
BY BACKUP	LIST BACKUP OF DATABASE BY BACKUP	Organizes the output by backup set. This is the default mode of presentation.
BY FILE	LIST BACKUP BY FILE	Lists the backups according to which file was backed up.
SUMMARY	LIST BACKUP SUMMARY	Displays summary output.

For both backups and copies you have additional options shown in [Table 2-4](#) (page 2-11).

Table 2-4 Additional LIST Options

Option	Example	Explanation
EXPIRED	LIST EXPIRED COPY	Lists backups that are recorded in the RMAN repository but that were not present at the expected location on disk or tape during the last CROSSCHECK command. An expired backup may have been deleted by an operating system utility.
RECOVERABLE	LIST BACKUP RECOVERABLE	Lists data file backups or copies that have status AVAILABLE in the RMAN repository and that can be restored and recovered.

To list backups and copies:

1. Start RMAN and connect to a target database as described in "[Starting RMAN and Connecting to a Database](#) (page 2-2)".
2. Run the LIST command at the RMAN prompt.

You can display specific objects, as in the following examples:

```
LIST BACKUP OF DATABASE;
LIST COPY OF DATAFILE 1, 2;
LIST BACKUP OF ARCHIVELOG FROM SEQUENCE 10;
LIST BACKUPSET OF DATAFILE 1;
```

See Also:

- "[Listing Backups and Recovery-Related Objects](#) (page 11-3)" to learn more about the LIST command
 - *Oracle Database Backup and Recovery Reference* for LIST command syntax
-

2.5.2 Reporting on Database Files and Backups: Quick Start

The REPORT command performs more complex reporting analysis than the LIST command.

[Table 2-5](#) (page 2-12) displays some of the main options of the REPORT command.

Table 2-5 REPORT Options

Option	Example	Explanation
NEED BACKUP	REPORT NEED BACKUP DATABASE	Shows which files need backing up under current retention policy. Use optional REDUNDANCY and RECOVERY WINDOW parameters to specify different criteria.
OBSOLETE	REPORT OBSOLETE	Lists backups that are obsolete under the configured backup retention policy . Use the optional REDUNDANCY and RECOVERY WINDOW parameters to override the default.
SCHEMA	REPORT SCHEMA	Reports the tablespaces and data files in the database at the current time (default) or a different time.
UNRECOVERABLE	REPORT UNRECOVERABLE	Lists all data files for which an unrecoverable operation has been performed against an object in the data file since the last backup of the data file.

To generate reports of database files and backups:

1. Start RMAN and connect to a target database as described in "[Starting RMAN and Connecting to a Database](#) (page 2-2)".
2. Run the REPORT command at the RMAN prompt.

The following example reports backups that are obsolete according to the currently configured backup retention policy:

```
REPORT OBSOLETE;
```

The following example reports the data files and temp files in the database:

```
REPORT SCHEMA;
```

See Also:

"[Reporting on Backups and Database Schema](#) (page 11-10)" to learn how to use the REPORT command for RMAN reporting

2.6 Maintaining RMAN Backups

RMAN repository metadata is always stored in the control file of the target database. The RMAN maintenance commands use this metadata when managing backups.

This section contains the following topics:

- [Cross-checking Backups](#) (page 2-12)
- [Deleting Obsolete Backups](#) (page 2-13)

2.6.1 Cross-checking Backups: Quick Start

Use the CROSSCHECK command to synchronize the logical records of RMAN backups and copies with the files on storage media.

If a backup is on disk, then CROSSCHECK determines whether the header of the file is valid. If a backup is on tape, then RMAN queries the RMAN repository for the names and locations of the backup pieces. It is a good idea to crosscheck backups and copies before deleting them.

To crosscheck all backups and copies on disk:

1. Start RMAN and connect to a target database as described in "[Starting RMAN and Connecting to a Database](#) (page 2-2)".
2. Run the CROSSCHECK command, as shown in the following example:

```
CROSSCHECK BACKUP;  
CROSSCHECK COPY;
```

See Also:

"[Crosschecking the RMAN Repository](#) (page 12-11)" to learn how to crosscheck RMAN backups

2.6.2 Deleting Obsolete Backups: Quick Start

The DELETE command removes RMAN backups and copies from disk and tape, updates the status of the files to DELETED in the control file repository, and removes the records from the recovery catalog (if you use a catalog).

If you run RMAN interactively, and if you do not specify the NOPROMPT option, then DELETE displays a list of files and prompts for confirmation before deleting any file in the list. The DELETE OBSOLETE command is particularly useful because RMAN deletes backups and data file copies recorded in the RMAN repository that are obsolete, that is, no longer needed. You can use options on the DELETE command to specify what is obsolete or use the configured [backup retention policy](#).

To delete obsolete backups and copies:

1. Start RMAN and connect to a target database as described in "[Starting RMAN and Connecting to a Database](#) (page 2-2)".
2. Run the DELETE OBSOLETE command, as shown in the following example:

```
DELETE OBSOLETE;
```

See Also:

"[Deleting RMAN Backups and Archived Redo Logs](#) (page 12-20)" to learn how to use the DELETE command

2.7 Diagnosing and Repairing Failures with Data Recovery Advisor: Quick Start

Data Recovery Advisor is an Oracle Database tool that provides an infrastructure for diagnosing persistent data failures, presenting repair options to the user, and executes repairs at the user's request.

This section contains the following topics:

- [Listing Failures and Determining Repair Options](#) (page 2-14)
- [Repairing Failures](#) (page 2-15)

See Also:

["Overview of Data Recovery Advisor](#) (page 15-1)"

2.7.1 Listing Failures and Determining Repair Options

A failure is a persistent data corruption detected by the Health Monitor. Examples include physical and logical data block corruptions and missing data files.

Each failure has a [failure priority](#) and [failure status](#). The priority can be CRITICAL, HIGH, or LOW. The status can be OPEN or CLOSED.

You can run the LIST FAILURE command to show all known failures. If failures exist, then run the ADVISE FAILURE command in the same session to determine repair options. The ADVISE FAILURE output shows both manual and automated repair options. First try to fix the problem manually. If you cannot fix the problem manually, then review the automated repair section.

An automated [repair option](#) describes a server-managed repair for one or more failures. Repairs are consolidated when possible so that a single repair can fix multiple failures. The repair option indicates which repair is performed and whether data is lost by performing the repair operation.

See Also:

["Listing Failures](#) (page 15-8)" and ["Determining Repair Options](#) (page 15-11)"

[Listing Failures and Determining Repair Options](#) (page 2-14) illustrates the commands to list failures and determine repair options. The output indicates the file name of a repair script containing RMAN commands. If you do not want to use Data Recovery Advisor to repair the failure automatically, then you can use the script as the basis of your own recovery strategy.

Example 2-1 LIST FAILURE and ADVISE FAILURE

```

RMAN> LIST FAILURE;

Database Role: PRIMARY
List of Database Failures
=====

Failure ID Priority Status      Time Detected Summary
-----
142          HIGH      OPEN      23-APR-13  One or more non-system datafiles are missing
101          HIGH      OPEN      23-APR-13  Datafile 1: '/disk1/oradata/prod/system01.dbf'
                                     contains one or more corrupt blocks

RMAN> ADVISE FAILURE;

Database Role: PRIMARY
List of Database Failures
=====

Failure ID Priority Status      Time Detected Summary
-----
142          HIGH      OPEN      23-APR-13  One or more non-system datafiles are missing
    
```



```

101          HIGH      OPEN      23-APR-13      Datafile 1: '/disk1/oradata/prod/system01.dbf'
                                     contains one or more corrupt blocks

```

```

analyzing automatic repair options; this may take some time
using channel ORA_DISK_1
analyzing automatic repair options complete

```

```

Mandatory Manual Actions
=====
no manual actions available

```

```

Optional Manual Actions
=====
1. If file /disk1/oradata/prod/users01.dbf was unintentionally renamed or moved, restore it

```

```

Automated Repair Options
=====
Option Repair Description
-----
1          Restore and recover datafile 28; Perform block media recovery of
          block 56416 in file 1
          Strategy: The repair includes complete media recovery with no data loss
          Repair script: /disk1/oracle/log/diag/rdbms/prod/prod/hm/reco_660500184.hm

```

2.7.2 Repairing Failures: Quick Start

Use the `RMAN REPAIR FAILURE` command to repair failures that were detected.

After running `LIST FAILURE` and `ADVISE FAILURE` in an [RMAN session](#), you can run `REPAIR FAILURE` to execute a repair option. If you execute `REPAIR FAILURE` with no other command options, then RMAN uses the first repair option of the most recent `ADVISE FAILURE` command in the current session. Alternatively, specify the repair option number obtained from the most recent `ADVISE FAILURE` command. The following example illustrates how to repair the failures identified in [Example 2-1](#) (page 2-14).

```
RMAN> REPAIR FAILURE;
```

By default, `REPAIR FAILURE` prompts for confirmation before it begins executing. After executing a repair, Data Recovery Advisor reevaluates all existing failures on the possibility that they may also have been fixed. Data Recovery Advisor always verifies that failures are still relevant and automatically closes fixed failures. If a repair fails to complete because of an error, then the error triggers a new assessment and re-evaluation of existing failures and repairs.

See Also:

["Repairing Failures" \(page 15-14\)](#)

2.8 Rewinding a Database with Flashback Database: Quick Start

You can use the Oracle Flashback Database to rewind the whole database to a past time. Unlike media recovery, you do not need to restore data files to return the database to a past state.

To use the `RMAN FLASHBACK DATABASE` command, your database must have been previously configured to generate [flashback logs](#). This configuration task is described in ["About Flashback Database" \(page 7-2\)](#). Flashback Database works by rewinding changes to the data files that exist at the moment that you run the command. You cannot use the flashback database to repair media failures or missing data files.

The database must be mounted when you issue `FLASHBACK DATABASE`. You can flashback to any time within the [flashback database window](#). If you have previously created a [restore point](#), that is a convenience, but not required.

To rewind a database with Flashback Database:

1. Start RMAN and connect to a target database as described in "[Starting RMAN and Connecting to a Database](#) (page 2-2)".
2. Ensure that the database is in a mounted state.

The following commands shut down and then mount the database:

```
SHUTDOWN IMMEDIATE;  
STARTUP MOUNT;
```

3. Run the `FLASHBACK DATABASE` command.

The following examples illustrate different forms of the command:

```
FLASHBACK DATABASE TO SCN 861150;
```

```
FLASHBACK DATABASE  
  TO RESTORE POINT BEFORE_CHANGES;
```

```
FLASHBACK DATABASE  
  TO TIMESTAMP TO_DATE('04-DEC-2009 03:30:00', 'DD-MON-YYYY HH24:MI:SS');
```

4. After performing the Flashback Database, open the database read-only in SQL*Plus and run some queries to verify the database contents.

Open the database read-only as follows:

```
ALTER DATABASE OPEN READ ONLY;
```

5. If satisfied with the results, then issue the following sequence of commands to shut down and then open the database:

```
SHUTDOWN IMMEDIATE;  
STARTUP MOUNT;  
ALTER DATABASE OPEN RESETLOGS;
```

See Also:

["Rewinding a Database with Flashback Database \(page 18-15\)"](#)

2.9 Restoring and Recovering Database Files: Quick Start

Use the `RESTORE` and `RECOVER` commands for RMAN restore and recovery of physical database files.

Restoring data files is retrieving them from backups as needed for a recovery operation. Media recovery is the application of changes from redo logs and incremental backups to a restored data file to bring the data file forward to a desired SCN or point in time.

This section contains the following topics:

- [Preparing to Restore and Recover Database Files](#) (page 2-17)

- [Recovering the Whole Database](#) (page 2-18)
- [Recovering Tablespaces](#) (page 2-18)
- [Recovering Individual Data Blocks](#) (page 2-19)

See Also:

[Performing Complete Database Recovery](#) (page 17-1)

2.9.1 Preparing to Restore and Recover Database Files: Quick Start

To recover the database because a media failure damages database files, then first ensure that you have the necessary backups.

You can use the `RESTORE . . . PREVIEW` command to report, but not restore, the backups that RMAN can use to restore to the specified time. RMAN queries the metadata and does not actually read the backup files. The database can be open when you run this command.

To preview a database restore and recovery:

1. Start RMAN and connect to the target database as described in "[Starting RMAN and Connecting to a Database](#) (page 2-2)".
2. Optionally, list the current tablespaces and data files, as shown in the following command:

```
RMAN> REPORT SCHEMA;
```

3. Run the `RESTORE DATABASE` command with the `PREVIEW` option.

The following command specifies `SUMMARY` so that the backup metadata is not displayed in verbose mode (sample output included):

```
RMAN> RESTORE DATABASE PREVIEW SUMMARY;
```

```
Starting restore at 21-MAY-13
allocated channel: ORA_DISK_1
channel ORA_DISK_1: SID=80 device type=DISK

List of Backups
=====
Key          TY LV S Device Type Completion Time #Pieces #Copies Compressed Tag
-----
11           B F A DISK          18-MAY-13         1       2       NO      TAG20070518T181114
13           B F A DISK          18-MAY-13         1       2       NO      TAG20070518T181114
using channel ORA_DISK_1
```

```
List of Archived Log Copies for database with db_unique_name PROD
=====
```

```
Key          Thrd Seq      S Low Time
-----
47           1    18      A 18-MAY-13
Name: /disk1/oracle/dbs/db1r_60ffa882_1_18_0622902157.arc
```

```
Media recovery start SCN is 586534
Recovery must be done beyond SCN 587194 to clear datafile fuzziness
validation succeeded for backup piece
Finished restore at 21-MAY-13
```

2.9.2 Recovering the Whole Database: Quick Start

Use the `RESTORE DATABASE` and `RECOVER DATABASE` commands to recover the whole database.

You must have previously made backups of all needed files. This scenario assumes that you can restore all data files to their original locations. If the original locations are inaccessible, then use the `SET NEWNAME` command as described in "[About Restoring Data Files to a Nondefault Location](#) (page 17-12)".

To recover the whole database:

1. Prepare for recovery as explained in "[Preparing to Restore and Recover Database Files](#) (page 2-17)".
2. Place the database in a mounted state.

The following example terminates the database instance (if it is started) and mounts the database:

```
RMAN> STARTUP FORCE MOUNT;
```

3. Restore the database.

The following example uses the preconfigured disk channel to restore the database:

```
RMAN> RESTORE DATABASE;
```

4. Recover the database, as shown in the following example:

```
RMAN> RECOVER DATABASE;
```

5. Open the database, as shown in the following example:

```
RMAN> ALTER DATABASE OPEN;
```

2.9.3 Recovering Tablespaces: Quick Start

Use the `RESTORE TABLESPACE` and `RECOVER TABLESPACE` commands on individual tablespaces when the database is open. In this case, you must take the tablespace that needs recovery offline, restore and then recover the tablespace, and bring the recovered tablespace online.

If you cannot restore a data file to its original location, then use the `RMAN SET NEWNAME` command within a `RUN` block to specify the new file name and location. Afterward, use a `SWITCH DATAFILE ALL` command, which is equivalent to using the SQL statement `ALTER DATABASE RENAME FILE`, to update the control file to reflect the new names for all data files for which a `SET NEWNAME` has been issued in the `RUN` command.

Unlike user-managed media recovery, you do *not* place an online tablespace in [backup mode](#). RMAN does not require extra logging or backup mode because it knows the format of data blocks.

To recover an individual tablespace when the database is open:

1. Prepare for recovery as explained in "[Preparing to Restore and Recover Database Files](#) (page 2-17)".

2. Take the tablespace to be recovered offline.

The following example takes the USERS tablespace offline:

```
RMAN> ALTER TABLESPACE users OFFLINE;
```

3. Restore and recover the tablespace.

The following RUN command, which you execute at the RMAN prompt, sets a new name for the data file in the USERS tablespace:

```
RUN
{
  SET NEWNAME FOR DATAFILE '/disk1/oradata/prod/users01.dbf'
  TO '/disk2/users01.dbf';
  RESTORE TABLESPACE users;
  SWITCH DATAFILE ALL; # update control file with new file names
  RECOVER TABLESPACE users;
}
```

4. Bring the tablespace online, as shown in the following example:

```
RMAN> ALTER TABLESPACE users ONLINE;
```

You can also use `RESTORE DATAFILE` and `RECOVER DATAFILE` for recovery at the data file level.

See Also:

- ["Performing Complete Recovery of a Tablespace \(page 17-16\)"](#)
 - ["About Online Backups and Backup Mode \(page 8-2\)"](#)
-
-

2.9.4 Recovering Individual Data Blocks: Quick Start

RMAN can recover individual corrupted data file blocks.

When RMAN performs a complete scan of a file for a backup, any corrupted blocks are listed in `V$DATABASE_BLOCK_CORRUPTION`. Corruption is usually reported in alert logs, trace files, or results of SQL queries.

To recover data blocks:

1. Start RMAN and connect to the target database as described in "[Starting RMAN and Connecting to a Database \(page 2-2\)](#)".
2. Obtain the block numbers of the corrupted blocks if you do not have this information.

```
RMAN> SELECT NAME, VALUE FROM V$DIAG_INFO;
```

3. Run the `RECOVER` command to repair the blocks.

The following RMAN command recovers all corrupted blocks:

```
RMAN> RECOVER CORRUPTION LIST;
```

You can also recover individual blocks, as shown in the following example:

```
RMAN> RECOVER DATAFILE 1 BLOCK 233, 235 DATAFILE 2 BLOCK 100 TO 200;
```

See Also:

[Performing Block Media Recovery](#) (page 19-1)

Part II

Starting and Configuring RMAN and Flashback Database

The chapters in this part explain the basic components of the RMAN environment and how to configure it. This part contains the following chapters:

- [Recovery Manager Architecture](#) (page 3-1)
- [Starting and Interacting with the RMAN Client](#) (page 4-1)
- [Configuring the RMAN Environment](#) (page 5-1)
- [Configuring the RMAN Environment: Advanced Topics](#) (page 6-1)
- [Using Flashback Database and Restore Points](#) (page 7-1)

Recovery Manager Architecture

This chapter describes the Recovery Manager (RMAN) interface and the basic components of the RMAN environment. This chapter contains the following topics:

- [About the RMAN Environment](#) (page 3-1)
- [About RMAN Command-Line Client](#) (page 3-3)
- [About RMAN Channels](#) (page 3-3)
- [About the RMAN Repository](#) (page 3-5)
- [About Media Management Using RMAN](#) (page 3-6)
- [About the Fast Recovery Area](#) (page 3-7)
- [About RMAN in a Data Guard Environment](#) (page 3-8)
- [About RMAN in a Recovery Appliance Environment](#) (page 3-10)

3.1 About the RMAN Environment

The Recovery Manager environment consists of the various applications and databases that play a role in a backup and recovery strategy.

[Table 3-1](#) (page 3-1) lists some components in a typical RMAN environment.

Table 3-1 Components of the RMAN Environment

Component	Description
RMAN client	The client application that manages backup and recovery operations for a target database. The RMAN client can use Oracle Net to connect to a target database, so it can be located on any host that is connected to the target host through Oracle Net.
target database	A database containing the control files, data files, and optional archived redo logs that RMAN backs up or restores. RMAN uses the target database control file to gather metadata about the target database and to store information about its own operations. The work of backup and recovery is performed by server sessions running on the target database.

Table 3-1 (Cont.) Components of the RMAN Environment

Component	Description
recovery catalog database	A database containing a recovery catalog , which contains metadata that RMAN uses to perform backup and recovery. You can create one recovery catalog that contains the RMAN metadata for multiple target databases. Unless you are using RMAN with a physical standby database , a recovery catalog is optional when using RMAN because RMAN stores its metadata in the control file of each target database.
recovery catalog schema	The user within the recovery catalog database that owns the metadata tables maintained by RMAN. RMAN periodically propagates metadata from the target database control file into the recovery catalog.
physical standby database	A copy of the primary database that is updated with redo generated by the primary database. You can fail over to the standby database if the primary database becomes inaccessible. RMAN can create, back up, or recover a standby database. Backups that you make at a physical standby database are usable at the primary database or another physical standby database for the same production database. The recovery catalog is required when you use RMAN to back up a physical standby database. Note: A logical standby database is treated as a separate database by RMAN because it has a different DBID from its primary database. See Also: <i>Oracle Data Guard Concepts and Administration</i> to learn how to use RMAN in a Data Guard environment
fast recovery area	A disk location that you can use to store recovery-related files such as control file and online redo log copies, archived redo logs, flashback logs , and RMAN backups. Oracle Database and RMAN manage the files in the fast recovery area automatically.
media management software	A vendor-specific application that enables RMAN to back up to a storage system such as tape
media management catalog	A vendor-specific repository of metadata about a media management application
Oracle Enterprise Manager	A browser-based interface to the database, including backup and recovery through RMAN

The only required components in an RMAN environment are a target database and RMAN client, but most real-world configurations are more complicated. For example, you use an RMAN client connecting to multiple media managers and multiple target databases, all accessed through Enterprise Manager.

[Figure 3-1](#) (page 3-3) illustrates components in a possible RMAN environment. The figure shows that the primary database, standby database, and recovery catalog databases all reside on different computers. The primary and standby database hosts use a locally attached tape drive. The RMAN client and Enterprise Manager console run on a separate computer.

Figure 3-1 Sample RMAN Environment

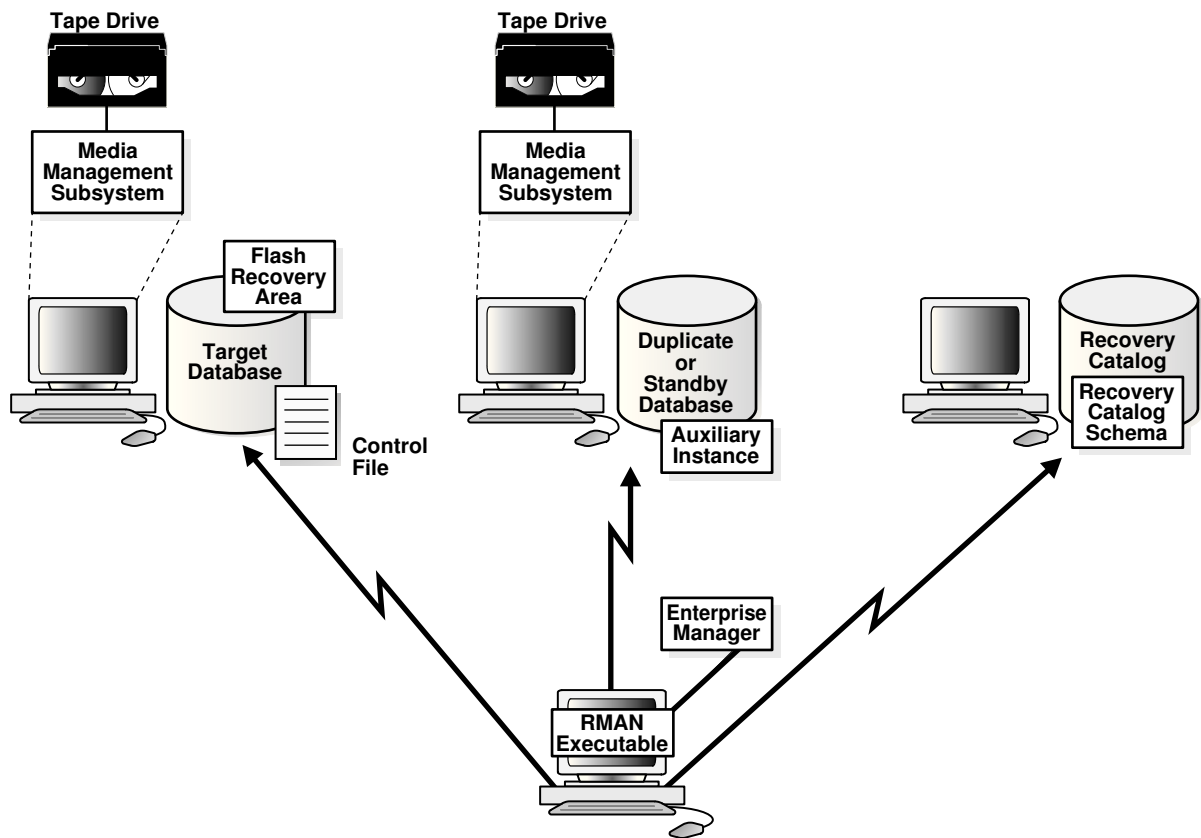
**See Also:**

Oracle Database Net Services Administrator's Guide to learn about Oracle Net

3.2 About RMAN Command-Line Client

Use the RMAN command-line client to enter commands that you can use to manage all aspects of backup and recovery operations.

RMAN uses a command language interpreter that can execute commands in interactive or batch mode.

3.3 About RMAN Channels

An RMAN channel represents one stream of data to a device, and corresponds to one database server session. During a backup or restore operation, the channel reads data from the input device, processes it, and writes it to the output device.

The RMAN client directs database server sessions to perform all backup and recovery tasks. What constitutes a session depends on the operating system. For example, on Linux, a server session corresponds to a server process, whereas on Windows it corresponds to a thread within the database service. The RMAN client itself does not perform backup, restore, or recovery operations.

Most RMAN commands are executed by channels, which must be either configured to persist across RMAN sessions, or manually allocated in each [RMAN session](#). As illustrated in [Figure 3-2](#) (page 3-4), a channel establishes a connection from the

RMAN client to a target or auxiliary database instance by starting a server session on the instance.

Figure 3-2 Channel Allocation

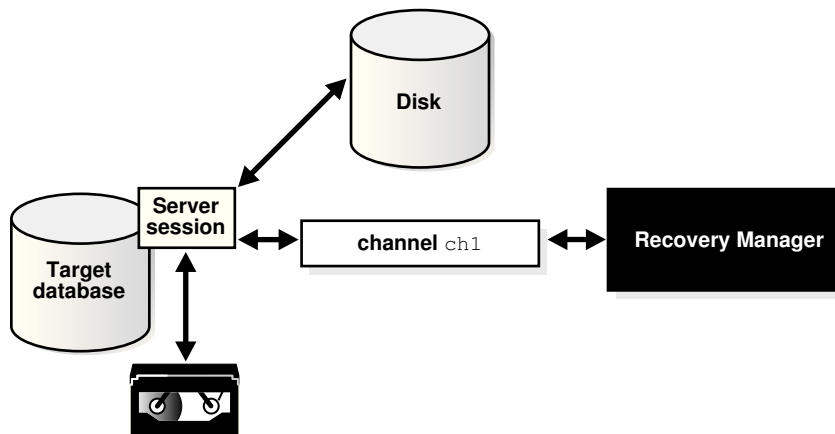

See Also:

["Basic Concepts of RMAN Performance Tuning \(page 23-1\) for a low-level description of how channels work"](#)

3.3.1 About RMAN Channels and Devices

The RMAN-supported device types are DISK and SBT (system backup to tape).

An [SBT](#) device is controlled by a third-party [media management software](#). Typically, SBT devices are tape libraries and tape drives.

If you use a DISK channel for a backup, then the channel creates the backup on disk in the file name space of the target database instance creating the backup. You can make a backup on any device that can store a data file. RMAN does not call a media manager when making DISK backups.

To create backups on non-disk media, you must use media management software such as Oracle Secure Backup and allocate channels supported by this software. RMAN contacts the media manager whenever the channel type allocated is not DISK. How and when the SBT channels cause the media manager to allocate resources is vendor-specific. Some media managers allocate resources when you issue the command; others do not allocate resources until you open a file for reading or writing.

See Also:

["Configuring the Default Device for Backups: Disk or SBT \(page 5-3\)"](#)

3.3.2 About RMAN Automatic and Manual Channels

RMAN can use automatic channels or manual channels for backup and recover operations.

You can use the `CONFIGURE CHANNEL` command to configure channels for use with disk or tape across RMAN sessions. This technique is known as [automatic channel](#)

allocation. RMAN comes preconfigured with one DISK channel that you can use for backups to disk.

When you run a command that can use automatic channels, RMAN automatically allocates the channels with the options that you specified in the CONFIGURE command. For the BACKUP command, RMAN allocates only the type of channel required to back up to the specified media. For the RESTORE command and [RMAN maintenance commands](#), RMAN allocates all necessary channels for the device types required to execute the command. RMAN determines the names for automatic channels.

You can also manually allocate channels. Each manually allocated channel uses a separate connection to the database. When you manually allocate a channel, you give it a user-defined name such as dev1 or ch2.

The number of channels available for use with a device when you run a command determines whether RMAN reads from or writes to this device in parallel while performing the command. When the work is done in parallel, the backup of the files is done by multiple channels. Each channel may back up multiple files, but unless a [multisection backup](#) is performed, no file is backed up by more than one channel.

See Also:

- *Oracle Database Backup and Recovery Reference* for ALLOCATE CHANNEL syntax
 - *Oracle Database Backup and Recovery Reference* on ALLOCATE CHANNEL FOR MAINTENANCE
 - "[Configuring Channels for Disk](#) (page 5-5)" and "[Configuring SBT Channels for Use with a Media Manager](#) (page 5-15)"
-
-

3.4 About the RMAN Repository

The RMAN repository is a collection of metadata about the target databases that RMAN uses for backup, recovery, and maintenance.

RMAN always stores its metadata in the control file. The version of this metadata in the control file is the authoritative record of RMAN backups of your database. This is one reason why protecting your control file is an important part of your backup strategy. RMAN can conduct all necessary backup and recovery operations using just the control file to store the [RMAN repository](#) information, and maintains all records necessary to meet your configured retention policy.

You can also create a [recovery catalog](#), which is a repository of RMAN metadata stored in an Oracle Database schema. The control file has limited space for records of backup activities, whereas a recovery catalog can store a much longer history. You can simplify backup and recovery administration by creating a single recovery catalog that contains the RMAN metadata for all of your databases.

The owner of a recovery catalog can grant or revoke restricted access to the catalog to other database users. Each restricted user has full read/write access to his own metadata, which is called a [virtual private catalog](#). When one or more virtual private catalogs exist in a database, the database contains just one set of catalog tables. These tables are owned by the base recovery catalog owner. The owner of the base recovery catalog controls which databases each virtual private catalog user can access.

Some RMAN features only function when you use a recovery catalog. For example, you can create a [stored script](#) in the recovery catalog and use this script to execute RMAN jobs. Other RMAN commands are specifically related to managing the recovery catalog and so are not available (and not needed) if RMAN is not connected to a recovery catalog.

The recovery catalog is maintained solely by RMAN. A target database instance never accesses the catalog directly. RMAN propagates information about the database structure, archived redo logs, backup sets, and data file copies into the recovery catalog from the target database control file after any operation that updates the repository, and also before certain operations.

See Also:

[Maintaining RMAN Backups and Repository Records](#) (page 12-1) and [Managing a Recovery Catalog](#) (page 13-1)

3.5 About Media Management Using RMAN

The Oracle Media Management Layer (MML) API lets third-party vendors build media management software that works with RMAN to allow backups to sequential media devices such as tape drives.

Media management software handles loading, unloading, and labeling of sequential media such as tapes. You must install [media management software](#) to use RMAN with sequential media devices.

When backing up or restoring, the RMAN client connects to a target database instance and directs the instance to send requests to its media manager. No direct communication occurs between the RMAN client and the media manager.

This section contains the following topics:

- [About RMAN Interaction with a Media Manager](#) (page 3-6)
- [About RMAN and Oracle Secure Backup](#) (page 3-7)
- [About the Backup Solutions Program](#) (page 3-7)

3.5.1 About RMAN Interaction with a Media Manager

Before performing backup or restore to a media manager, you must allocate one or more channels to handle the communication with the media manager. You can also configure default channels for the media manager. The default channels are used for all backup and recovery tasks that employ the media manager and for which you have not explicitly allocated channels.

RMAN does not issue specific commands to load, label, or unload tapes. When backing up, RMAN gives the media manager a stream of bytes and associates a unique name with this stream. When RMAN must restore the backup, it asks the media manager to retrieve the byte stream. All details of how and where that stream is stored are handled entirely by the media manager. For example, the media manager labels and keeps track of the tape and names of files on each tape, and automatically loads and unloads tapes, or signals an operator to do so.

Some media managers support [proxy copy](#) functionality, in which they handle the entire data movement between data files and the backup devices. These products may use technologies such as high-speed connections between storage and media

subsystems to reduce the load on the primary database server. RMAN provides a list of files requiring backup or restore to the media manager, which in turn makes all decisions regarding how and when to move the data.

See Also:

["Configuring SBT Channels for Use with a Media Manager \(page 5-15\)"](#)

3.5.2 About RMAN and Oracle Secure Backup

Oracle Secure Backup is a media manager that provides reliable and secure data protection through file system backup to tape. All major tape drives and tape libraries in SAN, Gigabit Ethernet, and SCSI environments are supported.

Although [Oracle Secure Backup](#) has no specialized knowledge of database backup and recovery algorithms, it can serve as a media management layer for RMAN through the SBT interface. In this capacity, Oracle Secure Backup provides the same services for RMAN as other supported third-party SBT libraries. Oracle Secure Backup has some features, however, that are not available in other media managers.

See Also:

Oracle Secure Backup Administrator's Guide to learn how to use Oracle Secure Backup

3.5.3 About the Backup Solutions Program

The Oracle Backup Solutions Program (BSP), part of the Oracle PartnerNetwork, is a group of media manager vendors whose products are compliant with Oracle's MML specification. Several products may be available for your platform from media management vendors.

For more information, contact your Oracle representative for a list of available products, contact individual vendors to ask them if they participate, or access the Backup Solutions Program website at:

<http://www.oracle.com/technetwork/database/features/availability/bsp-088814.html>

Oracle does not certify media manager vendors for compatibility with RMAN. Questions about availability, version compatibility, and functionality can only be answered by the media manager vendor, not Oracle.

3.6 About the Fast Recovery Area

The fast recovery area is an optional disk location that can be used to store recovery-related files.

The components that create different backup and recovery-related files have no knowledge of each other or of the size of the file systems where they store their data. With automatic disk-based backup and recovery, you can create a [fast recovery area](#) (also called the **recovery area**), which automates management of backup-related files.

A fast recovery area minimizes the need to manually manage disk space for backup-related files and balance the use of space among the different types of files. In this

way, a fast recovery area simplifies the ongoing administration of your database. Oracle recommends that you enable a recovery area to simplify backup management.

When you create a recovery area, you choose a location on disk and set an upper bound for storage space. You also set a [backup retention policy](#) that governs how long backup files are needed for recovery. The database manages the storage used for backups, archived redo logs, and other recovery-related files for the database within this space. Files no longer needed are eligible for deletion when RMAN must reclaim space for new files.

See Also:

"[Configuring the Fast Recovery Area](#) (page 5-19)" to learn about the fast recovery area and how to configure it

3.7 About RMAN in a Data Guard Environment

Data Guard maintains standby databases as transactionally consistent copies of production database. A standby database can be either a physical standby database or a logical standby database.

A database in a Data Guard environment is uniquely identified by the `DB_UNIQUE_NAME` parameter in the initialization parameter file. For RMAN to work correctly in a Data Guard environment, the `DB_UNIQUE_NAME` must be unique across all the databases with the same DBID.

When using RMAN in a Data Guard environment, a recovery catalog is required. The recovery catalog can store the metadata for all primary and standby databases.

This section contains the following topics:

- [About RMAN Configuration in a Data Guard Environment](#) (page 3-8)
- [About RMAN File Management in a Data Guard Environment](#) (page 3-9)

See Also:

Oracle Data Guard Concepts and Administration to learn how to use RMAN in a Data Guard environment

3.7.1 About RMAN Configuration in a Data Guard Environment

To simplify ongoing use of RMAN for backup and recovery, you can set some persistent configuration settings for each primary and physical standby database in a Data Guard environment. These settings control many aspects of RMAN behavior. For example, you can configure the backup retention policy, default destinations for backups to tape or disk, or default backup device type.

You can use the `CONFIGURE` command with the `FOR DB_UNIQUE_NAME` clause to create a persistent configuration for a database in a Data Guard environment without connecting to the standby database or primary database as `TARGET`. For example, you connect RMAN to the recovery catalog, run the `SET DBID` command, and then can create a configuration for a physical standby database before its creation so that the RMAN configuration applies when the database is created.

RMAN updates the control file of the database when connected to it as `TARGET` during a recovery catalog [resynchronization](#). If you use `FOR DB_UNIQUE_NAME` for a database without being connected as `TARGET` to this database, however, then RMAN changes configurations in the recovery catalog only.

See Also:

["Configuring RMAN in a Data Guard Environment \(page 5-37\)"](#)

3.7.2 About RMAN File Management in a Data Guard Environment

RMAN uses a recovery catalog to track file names for all database files in a Data Guard environment.

The catalog also records where the online redo log files, standby redo log files, temp files, archived redo log files, backup sets, and image copies are created.

3.7.2.1 About Interchangeability of Backups in a Data Guard Environment

RMAN commands use the recovery catalog metadata to function transparently across different physical databases in the Data Guard environment. For example, you can back up a tablespace on a physical standby database and restore and recover it on the primary database. Similarly, you can back up a tablespace on a primary database and restore and recover it on a physical standby database.

Backups of standby control files and nonstandby control files are interchangeable. For example, you can restore a standby control file on a primary database and a primary control file on a physical standby database. This interchangeability means that you can offload control file backups to one database in a Data Guard environment. RMAN automatically updates the file names for database files during restore and recovery at the databases.

Note:

Backups of logical standby databases are not usable at the primary database.

3.7.2.2 About Association of Backups in a Data Guard Environment

The recovery catalog tracks the files in the Data Guard environment by associating every database file or backup file with a `DB_UNIQUE_NAME`. The database that creates a file is associated with the file.

For example, if RMAN backs up the database with the unique name of `standby1`, then `standby1` is associated with this backup. A backup remains associated with the database that created it unless you use the `CHANGE . . . RESET DB_UNIQUE_NAME` command to associate the backup with a different database.

3.7.2.3 About Accessibility of Backups in a Data Guard Environment

The accessibility of a backup is different from its association. In a Data Guard environment, the recovery catalog considers disk backups as accessible only to the database with which they are associated, whereas tape backups created on one database are accessible to all databases.

If a backup file is not associated with any database, then the row describing it in the recovery catalog view shows `null` for the `SITE_KEY` column. By default, RMAN

associates a file whose `SITE_KEY` is null with the database to which they are connected as `TARGET`.

RMAN commands such as `BACKUP`, `RESTORE`, and `CROSSCHECK` work on any accessible backup. For example, for a `RECOVER COPY` operation, RMAN considers only image copies that are associated with the database as eligible to be recovered. RMAN considers the incremental backups on disk and tape as eligible to recover the image copies. In a database recovery, RMAN considers only the disk backups associated with the database and all files on tape as eligible to be restored.

To illustrate the differences in backup accessibility, assume that databases `prod` and `standby1` reside on different hosts. RMAN backs up data file 1 on `prod` to `/prnhost/disk1/df1.dbf` on the production host and also to tape. RMAN backs up data file 1 on `standby1` to `/sbyhost/disk2/df1.dbf` on the standby host and also to tape. If RMAN is connected to database `prod`, then you cannot use RMAN commands to perform operations with the `/sbyhost/disk2/df1.dbf` backup located on the standby host. However, RMAN does consider the tape backup made on `standby1` as eligible to be restored.

Note:

You can transfer a backup from a standby host to a primary host or vice versa, connect as `TARGET` to the database on this host, and then use the `CATALOG` command to catalog the backup. After a file is cataloged by the target database, the file is associated with the target database.

See Also:

- *Oracle Data Guard Concepts and Administration* to learn how to perform RMAN backup and recovery in a Data Guard environment
 - "[About Maintenance Commands in a Data Guard Environment](#) (page 12-2)"
 - [Managing a Recovery Catalog](#) (page 13-1) to learn how to manage a recovery catalog in a Data Guard environment
 - *Oracle Database Backup and Recovery Reference* for `CONFIGURE` syntax
-
-

3.8 About RMAN in a Recovery Appliance Environment

RMAN is fully-integrated with [Zero Data Loss Recovery Appliance \(Recovery Appliance\)](#) and RMAN commands can be used to back up protected databases to Recovery Appliance.

See Also:

[Creating RMAN Backups to Recovery Appliance](#) (page 3-10)

3.8.1 Creating RMAN Backups to Recovery Appliance

Recovery Appliance provides a centralized remote repository for backups of all target databases in the enterprise. Backups and backup metadata for all target databases is

managed by a central recovery catalog (the Recovery Appliance catalog) on Recovery Appliance.

Before you use Recovery Appliance to manage backups of your target database, you must perform some configuration steps both on the Recovery Appliance and on the target database.

To back up a target database to Recovery Appliance:

1. Ensure that the target database meets the requirements for protected databases in Recovery Appliance environments.

See Also:

Zero Data Loss Recovery Appliance Administrator's Guide for information about the supported Oracle Database releases

2. Install the Recovery Appliance backup module on the target database. This backup module is a shared library that is used by the target database to transfer backups to Recovery Appliance.

See Also:

Zero Data Loss Recovery Appliance Protected Database Configuration Guide for the steps to install the Recovery Appliance backup module

3. Enroll the target database as a protected database with the Recovery Appliance.

This step includes creating a protection policy, configuring a Recovery Appliance database user that will be used by protected databases to authenticate with Recovery Appliance, and registering the protected database with the Recovery Appliance catalog.

See Also:

- *Zero Data Loss Recovery Appliance Administrator's Guide* for the enrolment steps on the Recovery Appliance
 - *Zero Data Loss Recovery Appliance Protected Database Configuration Guide* for the enrolment steps on the protected database
-
-

4. (Optional) Configure backup and recovery settings for the target database. These settings will be used when you perform backup and recovery operations with Recovery Appliance.

The `CONFIGURE` command is used to configure backup and recovery settings for protected databases.

See Also:

- [Configuring the RMAN Environment](#) (page 5-1)
 - *Zero Data Loss Recovery Appliance Protected Database Configuration Guide* for information about configuring settings in a Recovery Appliance environment
-
-

5. Start RMAN and connect as TARGET to the protected database and as CATALOG to the Recovery Appliance catalog.

The connection to the target database must be as a user with the SYSDBA or SYSBACKUP privilege. The connection to the Recovery Appliance is as the Recovery Appliance user that has privileges required to perform backup and recovery operations for the protected database.

See Also:

Zero Data Loss Recovery Appliance Protected Database Configuration Guide for information about creating connections using RMAN

6. Allocate one or more RMAN SBT channels that point to the Recovery Appliance backup module. These channels are used to transfer data to the Recovery Appliance.
-
-

See Also:

["Configuring RMAN to Make Backups to Recovery Appliance](#) (page 5-16)"

7. Back up the target database to Recovery Appliance. You use the regular RMAN commands to back up the database to Recovery Appliance.
-
-

See Also:

Zero Data Loss Recovery Appliance Protected Database Configuration Guide for the steps to back up protected databases

Starting and Interacting with the RMAN Client

This chapter explains how to start the RMAN command-line interface and make database connections. This chapter contains the following topics:

- [Starting and Exiting RMAN](#) (page 4-1)
- [Making Database Connections with RMAN](#) (page 4-2)
- [Specifying the Location of RMAN Output](#) (page 4-12)
- [Setting Globalization Support Environment Variables for RMAN](#) (page 4-12)
- [Entering RMAN Commands](#) (page 4-13)
- [Using the RMAN Pipe Interface](#) (page 4-18)

4.1 Starting and Exiting RMAN

The RMAN executable is automatically installed with the database and is typically located in the same directory as the other database executables. For example, the RMAN client on Linux is located in `$ORACLE_HOME/bin`.

You have the following basic options for starting RMAN:

- Start the RMAN executable at the operating system command line without specifying any connection options, as in the following example:

```
% rman
```

See "[Making Database Connections from the RMAN Prompt](#) (page 4-5)".

- Start the RMAN executable at the operating system command line, as in the following examples:

```
% rman TARGET /  
% rman TARGET sbu@prod NOCATALOG
```

See "[Making RMAN Database Connections from the Operating System Command Line](#) (page 4-6)".

To quit RMAN and terminate the program, enter `EXIT` or `QUIT` at the RMAN prompt:

```
RMAN> EXIT
```

See Also:

Oracle Database Backup and Recovery Reference for RMAN command-line syntax

4.2 Making Database Connections with RMAN

You can create database connections from the RMAN client or the operating system command line. These database connection can be authenticated using a password file or with operating system authentication.

This section contains the following topics:

- [About RMAN Database Connection Types](#) (page 4-2)
- [About Authentication for RMAN Database Connections](#) (page 4-2)
- [Making Database Connections from the RMAN Prompt](#) (page 4-5)
- [Making RMAN Database Connections from the Operating System Command Line](#) (page 4-6)
- [Connecting RMAN to an Auxiliary Database](#) (page 4-10)
- [Making RMAN Connections to a CDB](#) (page 4-7)
- [Making RMAN Database Connections Within Command Files](#) (page 4-10)
- [Diagnosing RMAN Connection Problems](#) (page 4-11)

4.2.1 About RMAN Database Connection Types

To perform useful work, the RMAN client must connect to a database.

[Table 4-1](#) (page 4-2) describes the types of database connections that you can make with RMAN.

Table 4-1 Overview of RMAN Database Connections

Type of Database Connection	Keyword	Description
target database	TARGET	A database to be backed up or recovered by RMAN
recovery catalog database	CATALOG	A database that provides an optional backup store for the RMAN repository in addition to the control file.
auxiliary instance or auxiliary database	AUXILIAR Y	A physical standby database , or a database instance created for performing a specific task such as creating a duplicate database , transporting tablespaces, or performing tablespace point-in-time recovery (TSPITR) . For many tasks that use an auxiliary database, RMAN creates an automatic auxiliary instance for use during the task, connects to it, performs the task, and then destroys it when the task is completed. You do not give any explicit command to connect to automatic auxiliary instances.

4.2.2 About Authentication for RMAN Database Connections

Users connecting with RMAN to a target or auxiliary database require either the SYSDBA or SYSBACKUP system privilege.

These privileges are not required when connecting to the recovery catalog. You must grant the `RECOVERY_CATALOG_OWNER` role to the catalog schema owner. Users can also connect to the recovery catalog using the VPC credentials that have been created by the recovery catalog owner.

The same authentication options that are available with SQL*Plus are available with RMAN. The most common ways to authenticate with the target and auxiliary databases are:

- Operating system authentication

The prerequisites for connecting using operating system authentication are described in "[Authentication Using the Operating System](#) (page 4-3)".

- Password file authentication

The prerequisites for connecting using password file authentication are described in "[Authentication Using a Password File](#) (page 4-4)".

Neither of these methods requires the database to be open. Operating system authentication is used only to connect locally. Password file authentication can be used to connect locally or remotely.

See Also:

- *Oracle Database Administrator's Guide* to learn about database connection options when using SQL*Plus
 - *Oracle Database Security Guide* for details about the `SYSDBA` and `SYSBACKUP` system privileges
-
-

4.2.2.1 Authentication Using the Operating System

RMAN connections to a target or auxiliary database can be made using operating system authentication.

The following are the prerequisites for connecting to a database using operating system authentication (OS authentication):

- You must set the `ORACLE_SID` environment variable, specifying the system identifier (SID) for the database.

For example, to set the SID to `prod` in some UNIX shells, you enter:

```
% ORACLE_SID=prod; export ORACLE_SID
```

- You must be a member of the `OSDBA` operating system group to connect with the `SYSDBA` privilege or the `OSBACKUPDBA` operating system group to connect with the `SYSBACKUP` privilege.

On UNIX and Linux, the `OSDBA` group is typically named `dba`, and the `OSBACKUPDBA` group is typically named `backupdba`. These names are assigned during database installation.

The following examples illustrate how to connect to a target database with operating system authentication.

See Also:

Oracle Database Administrator's Guide for a discussion of operating system groups

Example 4-1 OS Authentication with the SYSDBA Privilege - Explicit

```
% rman target '/' as sysdba''
```

Example 4-2 OS Authentication with the SYSBACKUP Privilege - Explicit

```
% rman target '/' as sysbackup''
```

Example 4-3 OS Authentication with the SYSDBA Privilege - Implicit

```
rman target /
```

If neither AS SYSBACKUP nor AS SYSDBA is specified in the connection string, then the default used is AS SYSDBA.

4.2.2.2 Authentication Using a Password File

Use a password file for either local or remote access. If a database uses a password file to authenticate administrative users, then RMAN can connect using a password.

The database must use a [password file](#) for you to connect remotely using a net service name.

Caution:

Good security practice requires that passwords not be entered in plain text on the command line. Enter passwords in RMAN only when requested by an RMAN prompt. See *Oracle Database Security Guide* to learn about password protection.

The database creates an entry in the password file when you grant the SYSDBA or SYSBACKUP privilege to a user. You can then connect to the target or auxiliary database as this user even if the database is not open.

To support connecting through the password file with the SYSBACKUP privilege, the password file must be created in or upgraded to the format for Oracle Database 12c Release 1 (12.1) or later.

If neither AS SYSBACKUP nor AS SYSDBA is specified in the connection string, then the default used is AS SYSDBA. In this case, no enclosing quotes are required.

See Also:

Oracle Database Administrator's Guide to learn about password files

Example 4-4 Password File Authentication as SYSDBA - Explicit

In this example, the sdba user has been granted the SYSDBA privilege:

```
% rman target 'sdba@prod1 as sysdba''
```



```
target database Password: password
connected to target database: PRODL (DBID=39525561)
```

Example 4-5 Password File Authentication as SYSBACKUP - Explicit

In this example, the sbu user is granted the SYSBACKUP privilege in the target database:

```
% rman target "sbu@prodl as sysbackup"

target database Password: password
connected to target database: PRODL (DBID=39525561)
```

Example 4-6 Password File Authentication as SYSDBA - Implicit

```
% rman target sbu@prodl

target database Password: password
connected to target database: PRODL (DBID=39525561)
```

4.2.3 Making Database Connections from the RMAN Prompt

If you start RMAN without a connect string on the operating system command line, then you must issue a `CONNECT TARGET` command at the RMAN prompt to connect to a target database.

To make a database connection from the RMAN prompt:

1. On the operating system command line, start the RMAN client without making a database connection.

```
% rman
RMAN>
```

2. At the RMAN prompt, enter one or more `CONNECT` commands.

Example 4-7 Connecting With OS Authentication - Implicit

```
RMAN> connect target /
```

Because no system privilege is specified, `ASSYSDBA` is assumed.

Example 4-8 Connecting with OS Authentication - Explicit

```
RMAN> connect target "/ as sysdba"
```

When including a system privilege, the enclosing quotation marks (single or double) are required.

Example 4-9 Connecting with Password File Authentication

```
RMAN> connect target "sbu@prod AS SYSBACKUP"

target database Password: password
connected to target database: PROD (DBID=39525561)
```

Example 4-10 Connecting to Target and a Recovery Catalog

In this example, the target connection uses operating system authentication, and the recovery catalog database connection uses a net service name and password file authentication. The recovery catalog owner is user `rco`. RMAN prompts for the password of the recovery catalog user.

```

RMAN> connect target /
RMAN> connect catalog rco@catdb

recovery catalog database Password: password
connected to recovery catalog database
    
```

See Also:

Oracle Database Backup and Recovery Reference to learn about the `CONNECT` command

4.2.4 Making RMAN Database Connections from the Operating System Command Line

To connect to a target database from the operating system command line, enter the `rman` command followed by the connection information. You can begin executing commands after the RMAN prompt is displayed.

Use the `CATALOG` keyword to connect to a recovery catalog. You can also start RMAN without specifying `NOCATALOG` or `CATALOG`. If you do not specify `NOCATALOG` on the command line, and if you do not specify `CONNECT CATALOG` after RMAN has started, then RMAN defaults to `NOCATALOG` mode the first time that you run a command that requires the use of the RMAN repository.

Note:

After you have executed a command that uses the RMAN repository in `NOCATALOG` mode, you must exit and restart RMAN to be able to connect to a recovery catalog.

If you connect to the target database on the operating system command line, then you can begin executing commands after the RMAN prompt is displayed.

Example 4-11 Connecting to a Target Database from the System Prompt

This example illustrates a connection to a target database that uses operating system authentication. The `NOCATALOG` option indicates that a recovery catalog is not used in the session.

```

% rman TARGET / NOCATALOG

connected to target database: PROD (DBID=39525561)
using target database control file instead of recovery catalog

RMAN>
    
```

Example 4-12 Connecting to a Target Database from the System Prompt by Using Net Service Names

This example illustrates a connection to a target database that uses a net service name and password file authentication. RMAN prompts for the password.

```

% rman TARGET sbu@prod NOCATALOG

target database Password: password
connected to target database: PROD (DBID=39525561)

RMAN>
    
```

Example 4-13 Connecting to Target and a Recovery Catalog from the System Prompt

This example illustrates a connection that uses Oracle Net authentication for the target and recovery catalog databases. In both cases RMAN prompts for a password.

```
% rman TARGET sbu@prod CATALOG rco@catdb

target database Password: password
connected to target database: PROD (DBID=39525561)
recovery catalog database Password: password
connected to recovery catalog database

RMAN>
```

4.2.5 Making RMAN Connections to a CDB

You can connect the RMAN client to multitenant container databases (CDBs) and pluggable databases (PDBs).

This section contains the following topics:

- [About Performing Operations on CDBs and PDBs](#) (page 4-7)
- [Restrictions When Connected to a PDB](#) (page 4-8)
- [Connecting as Target to the Root](#) (page 4-8)
- [Connecting as Target to a PDB](#) (page 4-9)

4.2.5.1 About Performing Operations on CDBs and PDBs

You can perform RMAN operations on a whole CDB, the root only, or one or more PDBs.

Make RMAN connections to CDBs according to the following rules:

- To perform operations on the whole CDB (for example, to back up the whole CDB) you connect as target to the root.
- To perform operations on the root only (for example, to back up the root) you connect as target to the root.
- To perform operations on a single PDB, you can connect as target either to the root or directly to the PDB.
 - If you connect to the root, you must use the `PLUGGABLE DATABASE` syntax in your RMAN commands. For example, to back up a PDB, you use the `BACKUP PLUGGABLE DATABASE` command.
 - If instead you connect directly to a PDB, you can use the same commands that you would use when connecting to a [non-CDB](#). For example, to back up a PDB, you would use the `BACKUP DATABASE` command.
- To perform operations on two or more PDBs with a single command, you connect as target to the root.

For example, to back up both the `sales` and `hr` PDBs, you connect to the root and submit the following command:

```
BACKUP PLUGGABLE DATABASE sales, hr;
```

Note:

If you connect as target to a CDB with operating system authentication, you are connected to the root.

4.2.5.2 Restrictions When Connected to a PDB

Certain restrictions apply when you connect directly to a pluggable database (PDB):

The following operations are not available when you connect as target directly to a PDB:

- Back up archived logs
- Delete archived logs
- Delete archived log backups
- Restore archived logs (RMAN does restore archived logs when required during media recovery.)
- Point-in-time recovery (PITR) when using shared undo mode
- TSPITR
- Table recovery
- Duplicate database
- Flashback operations when using shared undo mode
- Running Data Recovery Advisor
- Report/delete obsolete
- Register database
- Import catalog
- Reset database
- Configuring the RMAN environment (using the `CONFIGURE` command)

Note:

When you connect as `TARGET` to a PDB, you cannot connect to a recovery catalog.

4.2.5.3 Connecting as Target to the Root

There are several ways to connect as target to the root.

The three most common ways are as follows:

- Connecting locally as a common user, as shown in [Example 4-14](#) (page 4-9)
- Connecting with operating system authentication, as shown in [Example 4-15](#) (page 4-9)

- Connecting as a common user through Oracle Net Services, using a net service name, as shown in [Example 4-16](#) (page 4-9)

In all cases, you must connect as a user with the SYSDBA or SYSBACKUP privilege.

Example 4-14 Connecting Locally to the Root

This example connects locally to the root using the SYS user, which is a common user. The connection is established using the SYSDBA privilege.

```
rman target sys

target database Password: password
connected to target database: CDB (DBID=659628168)
```

Example 4-15 Connecting to the Root with Operating System Authentication

This example connects locally to the root using operating system authentication. The connection is established as the SYS user with SYSDBA privilege.

```
rman target /

connected to target database: CDB (DBID=659628168)
```

Example 4-16 Connecting to the Root with a Net Service Name

This example assumes that there is a sales net service name that resolves to a database service for the root, and that there is a common user named c##bkuser that has the SYSBACKUP privilege.

```
rman target c##bkuser@sales

target database Password: password
connected to target database: CDB (DBID=659628168)
```

4.2.5.4 Connecting as Target to a PDB

You can connect to a PDB either from the RMAN prompt or the operating system command line.

To connect as target to a PDB, you must:

- Connect with a net service name that resolves to a database service for that PDB.
- Connect as a [local user](#) or [common user](#) with the SYSDBA privilege.

Example 4-17 Connecting As Target to a PDB

This example illustrates a connection to a PDB. It assumes the following

- You want to perform RMAN operations on a PDB named hrpdb.
- The net service name hrpdb resolves to a database service for the hrpdb PDB.
- The local user hrbkup was created in the hrpdb PDB and granted the SYSDBA privilege.

```
rman target hrbkup@hrpdb

target database Password: password
connected to target database: CDB (DBID=659628168)
```

4.2.6 Making RMAN Database Connections Within Command Files

You can make a database connection by creating an RMAN command file containing a `CONNECT` command..

If you create an RMAN command file that uses a `CONNECT` command with database level credentials (user name and password), then anyone with read access to this file can learn the password. There is no secure way to incorporate a `CONNECT` string with a password into a command file.

If you create an RMAN command file that uses a `CONNECT` command, then RMAN does not echo the connect string when you run the command file with the `@` command. This behavior prevents connect strings from appearing in any log files that contain RMAN output. For example, suppose that you create a command file `listbkup.rman` as follows:

```
cat > listbkup.rman << EOF
CONNECT TARGET /
LIST BACKUP;
EOF
```

You execute this script by running RMAN with the `@` command line option as follows:

```
% rman @listbkup.rman
```

When the command file executes, RMAN replaces the connection string with an asterisk, as shown in the following output:

```
RMAN> CONNECT TARGET *
2> LIST BACKUP;
3>
connected to target database: RDBMS (DBID=771530996)

using target database control file instead of recovery catalog

List of Backup Sets
=====
. . .
```

4.2.7 Connecting RMAN to an Auxiliary Database

To use the `DUPLICATE` command, you must connect to an auxiliary instance. Performing tablespace point-in-time recovery (TSPITR) may also require a connection to an auxiliary instance.

The form of an auxiliary connection is identical to a target database connection, except that you use the `AUXILIARY` keyword instead of the `TARGET` keyword.

Note:

When you use the `DUPLICATE . . . FROM ACTIVE DATABASE` command, a net service name is required. See "[Creating an Initialization Parameter File for the Auxiliary Instance](#) (page 25-23)" for more details.

See Also:

- [Duplicating a Database](#) (page 25-1) for more details on using the DUPLICATE command
- [Performing RMAN Tablespace Point-in-Time Recovery \(TSPITR\)](#) (page 21-1) for more details on performing TSPITR

Example 4-18 Connecting to Target and Auxiliary Databases from the RMAN Prompt

This example illustrates a connection to a target database using operating system authentication, and the auxiliary database connection uses a net service name and password file authentication.

```
% rman
RMAN> CONNECT TARGET /
RMAN> CONNECT AUXILIARY sbu@aux

auxiliary database Password: password
connected to auxiliary database: AUX (DBID=30472568)
```

Example 4-19 Connecting to Target and Auxiliary Databases from the System Prompt

This example illustrates a connection to a target database and an auxiliary database from the system prompt. The target connection uses operating system authentication and the auxiliary connection uses a net service name and password file authentication.

```
% rman target / auxiliary sbu@aux

auxiliary database Password: password
connected to auxiliary database: AUX (DBID=30472568)
```

4.2.8 Diagnosing RMAN Connection Problems

When you are diagnosing errors that RMAN encounters in connecting to the target, catalog and auxiliary databases, consider using SQL*Plus to connect to the databases directly. This action can reveal underlying problems with the connection information or the databases.

This section contains the following topics:

- [Diagnosing Target and Auxiliary Database Connection Problems](#) (page 4-11)
- [Diagnosing Recovery Catalog Connection Problems](#) (page 4-12)

4.2.8.1 Diagnosing Target and Auxiliary Database Connection Problems

RMAN connects to target and auxiliary databases using the SYSDBA or SYSBACKUP privilege. Thus, when you use SQL*Plus to diagnose connection problems to the target or auxiliary databases, request a SYSDBA or SYSBACKUP connection to reproduce RMAN behavior.

For example, suppose that the following RMAN command encountered connection errors:

```
RMAN> CONNECT TARGET /
```

You reproduce the preceding connection attempt with the SQL*Plus command as follows:

```
SQL> CONNECT / AS SYSBACKUP
```

4.2.8.2 Diagnosing Recovery Catalog Connection Problems

Use SQL*Plus to diagnose recovery catalog connection problems.

When RMAN connects to the recovery catalog database, it does not use the `SYSDBA` or `SYSBACKUP` privilege. When you use SQL*Plus to diagnose connection problems to the recovery catalog database, you must enter the database connect string exactly as it was entered into RMAN. Do not specify `AS SYSBACKUP` or `AS SYSDBA`.

4.3 Specifying the Location of RMAN Output

By default, RMAN writes command output to standard output. To redirect output to a log file, enter the `LOG` parameter on the command line when you start RMAN.

The following example writes RMAN command output to the file `rman.log`:

```
% rman LOG /tmp/rman.log
```

In this case, RMAN displays command input but does not display the RMAN output. The easiest way to send RMAN output both to a log file and to standard output is to use the Linux `tee` command or its equivalent. For example, the following technique enables both input and output to be visible in the RMAN command-line interface:

```
% rman | tee rman.log
RMAN>
```

See Also:

Oracle Database Backup and Recovery Reference to learn about RMAN command-line options

4.4 Setting Globalization Support Environment Variables for RMAN

Before invoking RMAN, it may be useful to set the `NLS_DATE_FORMAT` and `NLS_LANG` environment variables. These variables determine the format used for the time parameters in RMAN commands such as `RESTORE`, `RECOVER`, and `REPORT`.

The following example shows typical language and date format settings:

```
NLS_LANG=american
NLS_DATE_FORMAT='Mon DD YYYY HH24:MI:SS'
```

If you are going to use RMAN to connect to an unmounted database and mount the database later while RMAN is still connected, then set the `NLS_LANG` environment variable so that it also specifies the character set used by the database.

A database that is not mounted assumes the default character set, which is `US7ASCII`. If your character set is different from the default, then RMAN returns errors after the database is mounted. For example, if the character set is `WE8DEC`, then to avoid errors, you can set the `NLS_LANG` variable as follows:

```
NLS_LANG=american_america.we8dec
```

For the environment variable `NLS_DATE_FORMAT` to be applied and override the defaults set for the server in the server initialization file, the environment variable `NLS_LANG` must also be set.

See Also:

- *Oracle Database Reference* for more information about the `NLS_LANG` and `NLS_DATE_FORMAT` parameters
 - *Oracle Database Globalization Support Guide*
-

4.5 Entering RMAN Commands

You can enter RMAN commands either directly from the RMAN prompt or read them in from a text file.

This section contains the following topics:

- [Entering RMAN Commands at the RMAN Prompt](#) (page 4-13)
- [Using Command Files with RMAN](#) (page 4-13)
- [Entering Comments in RMAN Command Files](#) (page 4-14)
- [Using Substitution Variables in Command Files](#) (page 4-14)
- [Checking RMAN Syntax](#) (page 4-16)

4.5.1 Entering RMAN Commands at the RMAN Prompt

When the RMAN client is ready for your commands, it displays the command prompt

The following is an example of the RMAN command prompt:

```
RMAN>
```

Enter commands for RMAN to execute. For example:

```
RMAN> CONNECT TARGET  
RMAN> BACKUP DATABASE;
```

Most RMAN commands take several parameters and must end with a semicolon. Some commands, such as `STARTUP`, `SHUTDOWN`, and `CONNECT`, can be used with or without a semicolon.

When you enter a line of text that is not a complete command, RMAN prompts for continuation input with a line number. For example:

```
RMAN> BACKUP DATABASE  
2> INCLUDE CURRENT  
3> CONTROLFILE  
4> ;
```

4.5.2 Using Command Files with RMAN

For repetitive tasks, you can create a text file containing RMAN commands, and start the RMAN client with the `@` argument, followed by a file name.

For example, create a text file `cmdfile1` in the current directory containing one line of text as shown here:

```
BACKUP DATABASE PLUS ARCHIVELOG;
```

You can run this command file from the command line as shown in this example, and the command contained in it is executed:

```
% rman TARGET / @cmdfile1
```

After the command completes, RMAN exits.

You can also use the `@` command at the RMAN command prompt to execute the contents of a command file during an [RMAN session](#). RMAN reads the file and executes the commands in it. For example:

```
RMAN> @cmdfile1
```

After the command file contents have been executed, RMAN displays the following message:

```
RMAN> **end-of-file**
```

Unlike the case where a command file is executed from the operating system command line, RMAN does not exit.

See Also:

Oracle Database Backup and Recovery Reference for RMAN command-line syntax

4.5.3 Entering Comments in RMAN Command Files

The comment character in RMAN is a pound sign (`#`). All text from the pound sign to the end of the line is ignored.

For example, the contents of the following command file back up the database and archived redo log files and include comments:

```
# Command file name: mybackup.rman
# The following command backs up the database
BACKUP DATABASE;
# The following command backs up the archived redo logs
BACKUP ARCHIVELOG ALL;
```

The following example shows how you can break a single RMAN command across multiple lines:

```
RMAN> BACKUP # this is a comment
2> SPFILE;
```

4.5.4 Using Substitution Variables in Command Files

When running a command file, you can specify one or more values in a `USING` clause for use in substitution variables in a command file. In this way, you can make your command files dynamic.

As in SQL*Plus, `&1` indicates where to place the first value, `&2` where to place the second value, and so on. The substitution variable syntax is `&integer` followed by an optional period, for example, `&1.3`. The optional period is part of the variable and replaced with the value, thus enabling the substitution text to be immediately

followed by another integer. For example, if you pass the value `mybackup` to a command file containing the variable `&1 . 3`, then the result of the substitution is `mybackup3`.

The following procedure explains how to create and use a dynamic shell script that calls a command file containing substitution variables.

To create and use a dynamic shell script:

1. Create an RMAN command file that uses substitution variables.

The following example shows the contents of a command file named `quarterly_backup.cmd`, which is run every quarter. The script uses substitution variables for the name of the tape set, for a string in the `FORMAT` specification, and for the name of the restore point to be created.

```
# quarterly_backup.cmd
CONNECT TARGET /
RUN
{
  ALLOCATE CHANNEL c1
    DEVICE TYPE sbt
    PARMS 'ENV=(OB_MEDIA_FAMILY=&1)';
  BACKUP DATABASE
    TAG &2
    FORMAT '/disk2/bck/&1%U.bck'
    KEEP FOREVER
    RESTORE POINT &3;
}
EXIT;
```

2. Create a shell script that you can use to run the RMAN command file created in the previous step.

The following example creates a shell script named `runbackup.sh`. The example creates shell variables for the format and restore point name and accepts the values for these variables as command-line arguments to the script.

```
#!/bin/tcsh
# name: runbackup.sh
# usage: use the tag name and number of copies as arguments
set media_family = $argv[1]
set format = $argv[2]set restore_point = $argv[3]
rman @'/disk1/scripts/quarterly_backup.cmd' USING $media_family $format
$restore_point
```

3. Execute the shell script created in the previous step, specifying the desired arguments on the command line.

The following example runs the `runbackup.sh` shell script and passes it `archival_backup` as the media family name, `bck0906` as the format string, and `FY06Q3` as the restore point name.

```
% runbackup.sh archival_backup bck0906 FY06Q3
```

See Also:

Oracle Database Backup and Recovery Reference for @ syntax

4.5.5 Checking RMAN Syntax

You can test RMAN commands for syntactic correctness without executing them. Use the command-line argument `CHECKSYNTAX` to start the RMAN client in a mode in which it only parses the commands that you enter and returns an `RMAN-00558` error for commands that are not legal RMAN syntax.

You can check the syntax of RMAN commands either at the command line or in command files.

See Also:

Oracle Database Backup and Recovery Reference to learn about the `CHECKSYNTAX` command-line option

4.5.5.1 Checking RMAN Syntax at the Command Line

You can check the syntax of RMAN commands interactively without actually executing the commands.

To check RMAN syntax at the command line:

1. Start RMAN with the `CHECKSYNTAX` parameter:

```
% rman CHECKSYNTAX
```

2. Enter the RMAN commands to be tested.

The following example shows a sample interactive session, with user-entered text in bold.

```
RMAN> run [ backup database; ]
```

```
RMAN-00571: =====
RMAN-00569: ===== ERROR MESSAGE STACK FOLLOWS =====
RMAN-00571: =====
RMAN-00558: error encountered while parsing input commands
RMAN-01006: error signaled during parse
  RMAN-02001: unrecognized punctuation symbol "["
```

```
RMAN> run { backup database; }
```

The command has no syntax errors

```
RMAN>
```

4.5.5.2 Checking RMAN Syntax in Command Files

To test commands in a command file, start RMAN with the `CHECKSYNTAX` parameter and use the `@` command to name the command file to be passed.

To test commands in a command file:

1. Use a text editor to create a command file.

Assume that you create the `/tmp/goodcmdfile` with the following contents:

```
# command file with legal syntax
RESTORE DATABASE;
RECOVER DATABASE;
```

Assume that you create another command file, `/tmp/badcmdfile`, with the following contents:

```
# command file with bad syntax commands
RESTORE DATABASE
RECOVER DATABASE
```

2. Run the command file from the RMAN prompt in the following format, where `filename` is the name of the command file:

```
% rman CHECKSYNTAX @filename
```

Example 4-20 Checking the Syntax of a Command File with Correct Syntax

This example shows the output when you run `/tmp/goodcmdfile` with `CHECKSYNTAX`:

```
RMAN> # command file with legal syntax
2> restore database;
3> recover database;
4>
The cmdfile has no syntax errors
```

Recovery Manager complete.

Example 4-21 Checking the Syntax of a Command File with Bad Syntax

This example shows the output when you run `/tmp/badcmdfile` with `CHECKSYNTAX`:

```
RMAN> #command file with syntax error
2> restore database
3> recover
RMAN-00571: =====
RMAN-00569: ===== ERROR MESSAGE STACK FOLLOWS=====
RMAN-00571: =====
RMAN-00558: error encountered while parsing input commands
RMAN-01005: syntax error: found "recover": expecting one of: "archivelog,
channel, check, controlfile, clone, database, datafile, device,
from, force, high, (, preview, ;, skip, spfile, standby, tablespace,
until, validate"
RMAN-01007: at line 3 column 1 file: /tmp/badcmdfile
```

Example 4-22 Checking the Syntax of a Command File that Contains Substitution Variables

You make your command files dynamic by including substitution variables. When you check the syntax of a command file that contains substitution variables, RMAN prompts you to enter values. This example illustrates what happens if you enter invalid values when checking the syntax of a dynamic command file. The text in bold indicates text entered at the prompt.

```
RMAN> CONNECT TARGET *
2> BACKUP TAG
Enter value for 1: mybackup
abc COPIES
Enter value for 2: mybackup
abc
```

```

RMAN-00571: =====
RMAN-00569: ===== ERROR MESSAGE STACK FOLLOWS =====
RMAN-00571: =====
RMAN-00558: error encountered while parsing input commands
RMAN-01009: syntax error: found "identifier": expecting one of: "integer"
RMAN-01008: the bad identifier was: mybackup
RMAN-01007: at line 2 column 25 file: /tmp/whole_db.cmd

```

RMAN indicates a syntax error because the string `mybackup` is not a valid argument for `COPIES`.

4.6 Using the RMAN Pipe Interface

The RMAN pipe interface is an alternative method for issuing commands to RMAN and receiving the output from those commands. Using this interface, it is possible to write a portable programmatic interface to RMAN.

With the pipe interface, RMAN obtains commands and sends output by using the `DBMS_PIPE` PL/SQL package instead of the operating system shell. The pipe interface is invoked by using the `PIPE` command-line parameter for the RMAN client. RMAN uses two private pipes: one for receiving commands and the other for sending output. The names of the pipes are derived from the value of the `PIPE` parameter. For example, you can invoke RMAN with the following command:

```
% rman PIPE abc TARGET /
```

RMAN opens the two pipes in the target database: `ORA$RMAN_ABC_IN`, which RMAN uses to receive user commands, and `ORA$RMAN_ABC_OUT`, which RMAN uses to send all output back to RMAN. All messages on both the input and output pipes are of type `VARCHAR2`.

RMAN does not permit the pipe interface to be used with public pipes, because they are a potential security problem. With a public pipe, any user who knows the name of the pipe can send commands to RMAN and intercept its output.

If the pipes are not initialized, then RMAN creates them as private pipes. If you want to put commands on the input pipe before starting RMAN, you must first create the pipe by calling `DBMS_PIPE.CREATE_PIPE`. Whenever a pipe is not explicitly created as a private pipe, the first access to the pipe automatically creates it as a public pipe, and RMAN returns an error if it is told to use a public pipe.

Note:

If multiple RMAN sessions can run against the target database, then you must use unique pipe names for each [RMAN session](#). The `DBMS_PIPE.UNIQUE_SESSION_NAME` function is one method that you can use to generate unique pipe names.

This section contains the following topics:

- [Executing Multiple RMAN Commands in Succession Through a Pipe: Example](#) (page 4-19)
- [Executing RMAN Commands in a Single Job Through a Pipe: Example](#) (page 4-19)

4.6.1 Executing Multiple RMAN Commands in Succession Through a Pipe: Example

This example assumes that the application controlling RMAN wants to run multiple commands in succession. After each command is sent down the pipe and executed and the output returned, RMAN pauses and waits for the next command.

To execute RMAN commands through a pipe:

1. Start RMAN by connecting to a target database (required) and specifying the `PIPE` option. For example, enter:

```
% rman PIPE abc TARGET /
```

You can also specify the `TIMEOUT` option, which forces RMAN to exit automatically if it does not receive any input from the input pipe in the specified number of seconds. For example, enter:

```
% rman PIPE abc TARGET / TIMEOUT 60
```

2. Connect to the target database and put the desired commands on the input pipe by using `DBMS_PIPE.PACK_MESSAGE` and `DBMS_PIPE.SEND_MESSAGE`. In pipe mode, RMAN issues message `RMAN-00572` when it is ready to accept input instead of displaying the standard RMAN prompt.
3. Read the RMAN output from the output pipe by using `DBMS_PIPE.RECEIVE_MESSAGE` and `DBMS_PIPE.UNPACK_MESSAGE`.
4. Repeat Steps 2 and 3 to execute further commands with the same RMAN instance that was started in Step 1.
5. If you used the `TIMEOUT` option when starting RMAN, then RMAN terminates automatically after not receiving any input for the specified length of time. To force RMAN to terminate immediately, send the `EXIT` command.

4.6.2 Executing RMAN Commands in a Single Job Through a Pipe: Example

This example assumes that the application controlling RMAN wants to run one or more commands as a single job. After running the commands that are on the pipe, RMAN exits.

To execute RMAN commands in a single job through a pipe:

1. After connecting to the target database, create a pipe (if it does not already exist under the name `ORA$RMAN_pipe_IN`).
2. Put the desired commands on the input pipe. In pipe mode, RMAN issues message `RMAN-00572` when it is ready to accept input instead of displaying the standard RMAN prompt.
3. Start RMAN with the `PIPE` option, and specify `TIMEOUT 0`. For example, enter:

```
% rman PIPE abc TARGET / TIMEOUT 0
```

4. RMAN reads the commands that were put on the pipe and executes them by using `DBMS_PIPE.PACK_MESSAGE` and `DBMS_PIPE.SEND_MESSAGE`. When it has exhausted the input pipe, RMAN exits immediately.

5. Read RMAN output from the output pipe by using
`DBMS_PIPE.RECEIVE_MESSAGE` and `DBMS_PIPE.UNPACK_MESSAGE`.

See Also:

Oracle Database PL/SQL Packages and Types Reference for documentation on the `DBMS_PIPE` package

Configuring the RMAN Environment

This chapter explains the most basic tasks involved in configuring RMAN. This chapter contains the following topics:

- [About Configuring the Environment for RMAN Backups](#) (page 5-1)
- [Configuring RMAN to Make Backups to a Media Manager](#) (page 5-10)
- [Configuring RMAN to Make Backups to Recovery Appliance](#) (page 5-16)
- [Configuring the Fast Recovery Area](#) (page 5-19)
- [Configuring the Backup Retention Policy](#) (page 5-29)
- [Backup Optimization and the CONFIGURE command](#) (page 5-31)
- [Configuring an Archived Redo Log Deletion Policy](#) (page 5-35)
- [Configuring RMAN in a Data Guard Environment](#) (page 5-37)

See Also:

- [Configuring the RMAN Environment: Advanced Topics](#) (page 6-1) to learn about configuration options not covered in this chapter, including backup compression and encryption
 - Appendix C in the *Oracle Database Backup and Recovery Reference* for information about configuring RMAN for the Oracle Secure Backup (OSB) Cloud Module.
-

5.1 About Configuring the Environment for RMAN Backups

RMAN provides sensible defaults for most parameters required to perform basic backup and recovery. You can modify the value of default parameters or override these values for a particular session.

When implementing an RMAN-based backup strategy, you can use RMAN more effectively if you understand the most common configurations.

To simplify ongoing use of RMAN, you can set several persistent configuration settings for each target database. These settings control many aspects of RMAN behavior. For example, you can configure the backup retention policy, default destinations for backups, default backup device type, and so on. You can use the `SHOW` and `CONFIGURE` commands to view and change RMAN configurations.

This section explains what an RMAN configuration is and how you can use the `CONFIGURE` command to change RMAN default behavior for your backup and

recovery environment. This section also introduces the major settings available to you and their more common values.

Note:

If you plan to back up to tape, refer to [Configuring RMAN to Make Backups to a Media Manager](#) (page 5-10).

See Also:

Oracle Database Backup and Recovery Reference for CONFIGURE syntax

5.1.1 Showing and Clearing Persistent RMAN Configurations

You can use the SHOW command to display the current value of RMAN configured settings for the target database. You can also view whether these commands are currently set to their default values.

To view or change your CONFIGURE command settings:

1. Start RMAN and connect to a target database and a recovery catalog (if used).
2. Run the RMAN SHOW command.

For example, run SHOW ALL as shown in the following example (sample output included). The output includes both parameters that you have changed and those that are set to the default. The configuration is displayed as the series of RMAN commands required to re-create the configuration. You can save the output in a text file and use this command file to re-create the configuration on the same or a different database.

```
SHOW ALL;
```

```
RMAN configuration parameters for database with db_unique_name PROD1 are:
CONFIGURE RETENTION POLICY TO RECOVERY WINDOW OF 3 DAYS;
CONFIGURE BACKUP OPTIMIZATION ON;
CONFIGURE DEFAULT DEVICE TYPE TO DISK; # default
CONFIGURE CONTROLFILE AUTOBACKUP ON; # default
CONFIGURE CONTROLFILE AUTOBACKUP FORMAT FOR DEVICE TYPE SBT_TAPE TO '%F'; #
default
CONFIGURE CONTROLFILE AUTOBACKUP FORMAT FOR DEVICE TYPE DISK TO '%F'; # default
CONFIGURE DEVICE TYPE 'SBT_TAPE' PARALLELISM 2 BACKUP TYPE TO COMPRESSED
BACKUPSET;
CONFIGURE DEVICE TYPE DISK PARALLELISM 1 BACKUP TYPE TO BACKUPSET; # default
CONFIGURE DATAFILE BACKUP COPIES FOR DEVICE TYPE SBT_TAPE TO 1; # default
CONFIGURE DATAFILE BACKUP COPIES FOR DEVICE TYPE DISK TO 1; # default
CONFIGURE ARCHIVELOG BACKUP COPIES FOR DEVICE TYPE SBT_TAPE TO 1; # default
CONFIGURE ARCHIVELOG BACKUP COPIES FOR DEVICE TYPE DISK TO 1; # default
CONFIGURE CHANNEL DEVICE TYPE 'SBT_TAPE' PARMS 'ENV=(OB_DEVICE=tape1)';
CONFIGURE MAXSETSIZE TO UNLIMITED; # default
CONFIGURE ENCRYPTION FOR DATABASE OFF; # default
CONFIGURE ENCRYPTION ALGORITHM 'AES128'; # default
CONFIGURE COMPRESSION ALGORITHM 'BASIC' AS OF RELEASE 'DEFAULT' OPTIMIZE FOR LOAD
TRUE ; # default
CONFIGURE RMAN OUTPUT TO KEEP FOR 7 DAYS; # default
CONFIGURE ARCHIVELOG DELETION POLICY TO NONE; # default
CONFIGURE SNAPSHOT CONTROLFILE NAME TO '/disk1/oracle/dbs/snapcf_ev.f'; # default
```

You can also use the `SHOW` command with the name of a particular configuration. For example, you can view the retention policy and default device type as follows:

```
SHOW RETENTION POLICY;
SHOW DEFAULT DEVICE TYPE;
```

3. Optionally, use the `CONFIGURE . . . CLEAR` command to return any configuration to its default value, as shown in the following examples:

```
CONFIGURE BACKUP OPTIMIZATION CLEAR;
CONFIGURE RETENTION POLICY CLEAR;
CONFIGURE CONTROLFILE AUTOBACKUP FORMAT FOR DEVICE TYPE DISK CLEAR;
```

See Also:

Oracle Database Backup and Recovery Reference for `SHOW` syntax

5.1.2 Configuring the Default Device for Backups: Disk or SBT

Backups for which no destination device type is specified are directed to the configured default device. RMAN is preconfigured to use disk as the default device type. No additional configuration is necessary.

You may need to change the default device type from disk to tape, or change it back from tape to disk. [Table 5-1](#) (page 5-3) shows the commands that configure the default device.

Table 5-1 *Commands to Configure the Default Device Type*

Command	Explanation
<code>CONFIGURE DEFAULT DEVICE TYPE TO DISK</code>	<p>Specifies that backups go to disk by default.</p> <p>If a recovery area is enabled, then the backup location defaults to the fast recovery area. Otherwise, the backup location defaults to an operating system-specific directory on disk.</p> <p>When backing up to disk, the logical block size of the database file must be an even multiple of the physical block size of the destination device. For example, a device of type DISK with a block size of 2 kilobytes can only be used as a destination for backups of database files with logical block sizes of 2 KB, 4 KB, 6 KB, and so on. Most disk drives have physical block sizes of 512 bytes, so this limitation rarely affects backup to disk drives. Nevertheless, you can encounter this limitation when backing up to a writable DVD or a device that has a larger physical block size.</p>
<code>CONFIGURE DEFAULT DEVICE TYPE TO sbt</code>	<p>Specifies that backups go to tape by default.</p> <p>"Configuring RMAN to Make Backups to a Media Manager (page 5-10)" explains how to set up RMAN for use with a media manager. When RMAN can communicate with the media manager, you can configure RMAN to make backups to tape and specify SBT as the default device type.</p>

You can always override the default device by using the `DEVICE TYPE` clause of the `BACKUP` command, as shown in the following examples:

```
BACKUP DEVICE TYPE sbt DATABASE;  
BACKUP DEVICE TYPE DISK DATABASE;
```

To change the configured default device type:

1. Start RMAN and connect to a target database and a recovery catalog (if used).
2. Run the `SHOW ALL` command to show the currently configured default device.
3. Run the `CONFIGURE DEFAULT DEVICE TYPE` command, specifying either `TO DISK` or `TO sbt`.

See Also:

Oracle Database Backup and Recovery Reference for more details on using the `BACKUP` command with the `DEVICE TYPE` clause

5.1.3 Configuring the Default Type for Backups: Backup Sets or Copies

The `BACKUP` command can create either backup sets or image copies. For disk, you can configure RMAN to create either backup sets or image copies as its default backup type with the `CONFIGURE DEVICE TYPE DISK BACKUP TYPE TO` command.

Note:

Because RMAN can write an [image copy](#) only to disk, the backup type for tape can only be a backup set.

The default backup type for disk is an uncompressed [backup set](#).

RMAN can create backup sets using [binary compression](#). You can configure RMAN to use compressed backup sets by default on a device type by specifying the `COMPRESSED` option in the `BACKUP TYPE TO . . . BACKUPSET` clause. To disable compression, use the `CONFIGURE DEVICE TYPE` command with arguments specifying your other desired settings, but omit the `COMPRESSED` keyword.

To configure the default type of backup:

1. Start RMAN and connect to a target database and a recovery catalog (if used).
2. Configure backup sets or image copies as the default backup type.

The following examples configure the backup type for disk backups to copies and backup sets:

```
CONFIGURE DEVICE TYPE DISK BACKUP TYPE TO COPY; # image copies  
CONFIGURE DEVICE TYPE DISK BACKUP TYPE TO BACKUPSET; # uncompressed
```

The following examples configure compression for backup sets:

```
CONFIGURE DEVICE TYPE DISK BACKUP TYPE TO COMPRESSED BACKUPSET;  
CONFIGURE DEVICE TYPE sbt BACKUP TYPE TO COMPRESSED BACKUPSET;
```

See Also:

- [About Backup Sets](#) (page 8-3)
 - [Making Compressed Backups](#) (page 9-7)
-
-

5.1.4 Configuring Channels

An RMAN channel is a connection to a database server session. RMAN uses channels to perform most tasks.

This section contains the following topics:

- [About Channel Configuration](#) (page 5-5)
- [Configuring Channels for Disk](#) (page 5-5)
- [Configuring Parallel Channels for Disk and SBT Devices](#) (page 5-6)
- [Manually Overriding Configured Channels](#) (page 5-7)

5.1.4.1 About Channel Configuration

Use the `CONFIGURE CHANNEL` command to configure options for disk or SBT channels. You can configure generic channel settings for a device type, that is, a template that is used for any channels created based on configured settings for that device.

Note:

This section explains configuration of disk channels. To learn how to configure channels for tape, see [Configuring SBT Channels for Use with a Media Manager](#) (page 5-15).

`CONFIGURE CHANNEL` takes the same options used to specify one-time options with the `ALLOCATE CHANNEL` command.

If you use `CONFIGURE CHANNEL` to specify generic channel settings for a device, any previous settings are discarded, even if the settings are not in conflict. For example, after the second `CONFIGURE CHANNEL` command, which specifies only the `FORMAT` for configured disk channels, the `MAXPIECESIZE` for the disk channel is returned to its default value:

```
CONFIGURE CHANNEL DEVICE TYPE DISK MAXPIECESIZE 2G;
CONFIGURE CHANNEL DEVICE TYPE DISK FORMAT /tmp/%U;
```

5.1.4.2 Configuring Channels for Disk

By default, RMAN allocates one disk channel for all operations. You can specify different options for this channel, for example, a new default location for backups.

Example 5-1 Configuring a Nondefault Backup Location

This example configures RMAN to write disk backups to the `/disk1` directory and specifies a nondefault format for the relative file name.

```
CONFIGURE CHANNEL DEVICE TYPE DISK FORMAT '/disk1/ora_df%t_s%s_s%p';
```

RMAN automatically replaces the format specifier %t with a four byte time stamp, %s with the backup set number, and %p with the backup piece number.

Note:

When you configure an explicit format for disk channels, RMAN does not create backups by default in the [fast recovery area](#). In this case, you lose the disk space management capabilities of the fast recovery area.

Example 5-2 Configuring an ASM Disk Location

This example demonstrates how to configure an ASM disk location.

```
CONFIGURE CHANNEL DEVICE TYPE DISK FORMAT '+dgroup1';
```

See Also:

[Backing Up Database Files with RMAN](#) (page 9-10) to learn how to make backups

5.1.4.3 Configuring Parallel Channels for Disk and SBT Devices

The number of channels available for a device type when you run a command determines whether RMAN reads or writes in parallel. As a rule, the number of channels used in executing a command should match the number of devices accessed.

For tape backups, allocate one channel for each tape drive. For disk backups, allocate one channel for each physical disk, unless you can optimize the backup for your disk subsystem architecture with multiple channels. Failing to allocate the right number of channels adversely affects RMAN performance during I/O operations.

You can configure [channel parallelism](#) settings, [binary compression](#) for backup sets, and other options for an [SBT](#) device with `CONFIGURE DEVICE TYPE sbt`. You set the configuration for the device type independently of the channel configuration.

Example 5-3 Configuring Parallelism for an SBT Device

This example changes the SBT device (sample output included) so that RMAN can back up to a media manager using two tape drives in parallel. Each configured SBT channel backs up approximately half the total data.

```
RMAN> CONFIGURE DEVICE TYPE sbt PARALLELISM 2;

old RMAN configuration parameters:
CONFIGURE DEVICE TYPE 'SBT_TAPE' BACKUP TYPE TO COMPRESSED BACKUPSET PARALLELISM 1;
new RMAN configuration parameters:
CONFIGURE DEVICE TYPE 'SBT_TAPE' PARALLELISM 2 BACKUP TYPE TO COMPRESSED BACKUPSET;
new RMAN configuration parameters are successfully stored
```

Example 5-4 Configuring the Backup Type for an SBT Device

This example changes the default backup type for the SBT device to an uncompressed backup set (sample output included).

The `CONFIGURE DEVICE TYPE` commands used in this example only affect parallelism and backup type and do not affect the values of settings not specified. In [Example 5-3](#) (page 5-6), the default backup type of compressed backup set was not

changed by changing the parallelism setting. In this example, the ability to use multiple tape drives in parallel is not affected by changing the default backup type.

```

RMAN> CONFIGURE DEVICE TYPE sbt BACKUP TYPE TO BACKUPSET;
old RMAN configuration parameters:
CONFIGURE DEVICE TYPE 'SBT_TAPE' PARALLELISM 2 BACKUP TYPE TO COMPRESSED BACKUPSET;
new RMAN configuration parameters:
CONFIGURE DEVICE TYPE 'SBT_TAPE' BACKUP TYPE TO BACKUPSET PARALLELISM 2;
new RMAN configuration parameters are successfully stored

```

See Also:

- [Specifying Multiple Formats for Disk Backups](#) (page 9-5) to learn how to make disk backups in parallel
 - *Oracle Database Backup and Recovery Reference* for reference material on the CHANNEL parameter of the BACKUP command
 - *Oracle Real Application Clusters Administration and Deployment Guide* for information about taking advantage of parallel operations in an Oracle Real Application Clusters (Oracle RAC) configuration
-
-

5.1.4.4 Manually Overriding Configured Channels

If you manually allocate a channel during a job, then RMAN disregards any configured channel settings.

To manually override configured channels:

- Assume that the default device type is SBT. Run the following command to override the default configuration.

```

RUN
{
  ALLOCATE CHANNEL c1 DEVICE TYPE DISK;
  BACKUP TABLESPACE users;
}

```

In this case, RMAN uses only the disk channel that you manually allocated within the RUN command, overriding any defaults set by using CONFIGURE DEVICE TYPE, CONFIGURE DEFAULT DEVICE, or CONFIGURE CHANNEL settings.

See Also:

- [About RMAN Channels](#) (page 3-3) to learn about configured and allocated channels
 - *Oracle Database Backup and Recovery Reference* for ALLOCATE CHANNEL syntax
 - *Oracle Database Backup and Recovery Reference* for CONFIGURE syntax
-
-

5.1.5 Configuring Control File and Server Parameter File Autobackups

You can configure RMAN to automatically back up the control file and server parameter file. The autobackup occurs whenever a backup record is added.

If the database runs in ARCHIVELOG mode, then an autobackup is also taken whenever the database structure metadata in the control file changes. A [control file autobackup](#) enables RMAN to recover the database even if the current control file, recovery catalog, and server parameter file are lost.

Because the file name for the autobackup follows a well-known format, RMAN can search for it without access to a repository and then restore the server parameter file. After you have started the instance with the restored server parameter file, RMAN can restore the control file from an autobackup. After you mount the control file, the RMAN repository is available, and RMAN can restore the data files and find the archived redo logs.

To enable the autobackup feature:

```
CONFIGURE CONTROLFILE AUTOBACKUP ON;
```

To disable the autobackup feature:

```
CONFIGURE CONTROLFILE AUTOBACKUP OFF;
```

By default, control file autobackups are turned on for CDBs and standalone databases that have the COMPATIBLE initialization parameter set to 12.2 or higher.

See Also:

- [About RMAN Control File and Server Parameter File Autobackups](#) (page 8-15)
 - *Oracle Database Backup and Recovery Reference* for CONFIGURE syntax
-
-

5.1.5.1 Configuring the Control File Autobackup Format

By default, the format of the autobackup file for all configured devices is the substitution variable %F in the FORMAT clause.

The %F variable format translates into *c-YYYYMMDD-QQ*, with the placeholders defined as follows:

- *YYYYMMDD* stands for the DBID.
- *YYYYMMDD* is a time stamp of the day the backup is generated.
- *QQ* is the hexadecimal sequence that starts with 00 and has a maximum of FF.

To change the default format for the autobackup file:

- Use the following command, where *deviceSpecifier* is any valid device type, and *'string'* must contain the substitution variable %F (and no other substitution variables) and is a valid handle for the specified device:

```
CONFIGURE CONTROLFILE AUTOBACKUP FORMAT  
FOR DEVICE TYPE deviceSpecifier TO 'string';
```

For example, you can run the following command to specify a nondefault file name for the control file autobackup. In the file name, ? stands for ORACLE_HOME.

```
CONFIGURE CONTROLFILE AUTOBACKUP FORMAT
FOR DEVICE TYPE DISK TO '?/oradata/cf_%F';
```

The following example configures the autobackup to write to an Automatic Storage Management disk group:

```
CONFIGURE CONTROLFILE AUTOBACKUP FORMAT
FOR DEVICE TYPE DISK TO '+dgroup1/%F';
```

Note:

The valid formats for control file autobackups are: %D, %I, %M, %Y, %F, %T, %d, and %n. If you use formats other than these, you may not be able to restore the control file autobackup.

To clear control file autobackup formats for a device:

- Use the following commands:

```
CONFIGURE CONTROLFILE AUTOBACKUP FORMAT FOR DEVICE TYPE DISK CLEAR;
CONFIGURE CONTROLFILE AUTOBACKUP FORMAT FOR DEVICE TYPE sbt CLEAR;
```

If you have set up a [fast recovery area](#) for the database, then you can direct control file autobackups to the fast recovery area by clearing the control file autobackup format for disk.

Note:

All files in the fast recovery area are maintained by Oracle Database and associated file names are maintained in the Oracle Managed Files (OMF) format.

5.1.5.2 Overriding the Configured Control File Autobackup Format

The SET CONTROLFILE AUTOBACKUP FORMAT command, which you can specify either within a RUN command or at the RMAN prompt, overrides the configured autobackup format in the current session only.

The order of precedence is:

1. SET CONTROLFILE AUTOBACKUP FORMAT (within a RUN block)
2. SET CONTROLFILE AUTOBACKUP FORMAT (at RMAN prompt)
3. CONFIGURE CONTROLFILE AUTOBACKUP FORMAT

The following example shows how the two forms of SET CONTROLFILE AUTOBACKUP FORMAT interact:

```
SET CONTROLFILE AUTOBACKUP FORMAT FOR DEVICE TYPE DISK TO 'controlfile_%F';
BACKUP AS COPY DATABASE;
RUN
{
  SET CONTROLFILE AUTOBACKUP FORMAT FOR DEVICE TYPE DISK TO '/tmp/%F.bck';
  BACKUP AS BACKUPSET
```

```
    DEVICE TYPE DISK
    DATABASE;
}
```

The first `SET CONTROLFILE AUTOBACKUP FORMAT` controls the name of the control file autobackup until the RMAN client exits, overriding any configured control file autobackup format. The `SET CONTROLFILE AUTOBACKUP FORMAT` in the `RUN` block overrides the `SET CONTROLFILE AUTOBACKUP FORMAT` outside the `RUN` block for the duration of the `RUN` block.

5.2 Configuring RMAN to Make Backups to a Media Manager

On most platforms, to back up to and restore from sequential media such as tape you must integrate a media management software with your Oracle database. You can use Oracle Secure Backup, which supports both database and file system backups to tape, as your media manager.

Note:

You can also use a third-party media manager. This section describes the generic steps for configuring RMAN for use with a third-party media manager. The actual steps depend on the media management product that you install and the platform on which you run the database. If you opt to use RMAN with a media manager other than Oracle Secure Backup, then you must obtain all product-specific information from the vendor.

To configure RMAN for use with a media manager:

1. Ensure that the prerequisites for using a media manager are met as described in "[Prerequisites for Using a Media Manager with RMAN](#) (page 5-11)"
2. Determine the location of the media management library used to communicate with the sequential media as described in "[Determining the Location of the Media Management Library](#) (page 5-11)"
3. Configure the media management software as described in "[Configuring Media Management Software for RMAN Backups](#) (page 5-12)"
4. Check if RMAN can create backups using the media manager as described in "[Testing Whether the Media Manager Library Is Integrated Correctly](#) (page 5-13)"
5. Configure an RMAN channel that can be used as a default for all tape backups as described in "[Configuring SBT Channels for Use with a Media Manager](#) (page 5-15)"

See Also:

- [About Media Management Using RMAN](#) (page 3-6) for an overview of media management software and its implications for RMAN
 - *Oracle Secure Backup Administrator's Guide* to learn how to set up RMAN for use specifically with Oracle Secure Backup
-
-

5.2.1 Prerequisites for Using a Media Manager with RMAN

Before you can begin using RMAN with a third-party media manager, you must install the media manager and ensure that RMAN can communicate with it. Refer to the media management vendor's software documentation for instructions.

In general, you begin by installing and configuring the media management software on the target host or production network. Ensure that you can make non-RMAN backups of the operating system files on the target database host. This step makes later troubleshooting much easier by confirming that the basic integration of the media manager with the target host has been successful. Refer to your media management documentation to learn how to back up files to the media manager without using RMAN.

Then, obtain and install the third-party media management module for integration with the database server. This module contains the [media management library](#) that the Oracle database loads and uses when accessing the media manager. It is generally a third-party product that must be purchased separately. Contact your media management vendor for details.

5.2.2 Determining the Location of the Media Management Library

Before attempting to use RMAN with a media manager, determine the location of the media management library.

When allocating or configuring a [channel](#) for RMAN to use to communicate with a media manager, you must specify the `SBT_LIBRARY` parameter in an `ALLOCATE CHANNEL` or `CONFIGURE CHANNEL` command. The `SBT_LIBRARY` parameter specifies the path to the library.

When RMAN allocates channels to communicate with a media manager, it attempts to load the library indicated by the `SBT_LIBRARY` parameter. If you do not provide a value for the `SBT_LIBRARY` parameter in an allocated or preconfigured channel, then RMAN looks in a platform-specific and secured default location.

On Linux and UNIX, the SBT library is loaded from:

```
/opt/oracle/extapi/[32,64]/{SBT}/{VENDOR}/{VERSION}/libobk.so
```

The SBT library file name extension name varies according to platform:

- `.so`, `.sl` on HP-UX,
- `.a` on AIX,

On Windows, the SBT library is loaded from:

```
%SYSTEM_DRIVE%\oracle\extapi\[32,64]\{SBT}\{VENDOR}\{VERSION}\orasbt.dll
```

If RMAN cannot use the secured default location or if you are using Oracle Database 11g or earlier, then RMAN loads the SBT library from the location designated by the environment variables `PATH` or `LIBPATH`.

In some cases, your organization may have security or regulatory compliance requirements that prohibit the use of environment variables `PATH` or `LIBPATH` to designate a library directory. To disable this behavior, set the `PARMS` string to `SBT_SECURE=1`.

Note:

The default media management library file is *not* part of the standard database installation. It is present only if you install third-party media management software.

See Also:

Your operating system-specific database documentation and the documentation supplied by your media vendor for instructions on how to achieve media manager integration on your platform

Example: Configuring the Media Management Library Location

The following example shows the channel syntax, where *pathname* is the absolute file name of the library:

```
CONFIGURE CHANNEL DEVICE TYPE sbt
PARMS 'SBT_LIBRARY=pathname' ;
```

5.2.3 Configuring Media Management Software for RMAN Backups

After installing the media management software, perform the configuration required by your vendor so that the software can accept RMAN backups.

Depending on the type of media management software that you installed, you may have to define media pools, configure users and classes, and so on. Consult your media management vendor documentation for the appropriate RMAN settings. The `PARMS` parameter sends instructions to the media manager. If `PARMS` values are needed for the `ALLOCATE CHANNEL` or the `CONFIGURE CHANNEL` command, or if a `FORMAT` string is recommended for the `BACKUP` or `CONFIGURE` command, then refer to the vendor documentation for this information.

Example 5-5 *PARMS* Setting for Oracle Secure Backup

This example shows a `PARMS` setting for Oracle Secure Backup. This `PARMS` settings instructs the media manager to back up to a family of tapes called `datafile_mf`. The `PARMS` settings are always vendor-specific.

```
CONFIGURE CHANNEL DEVICE TYPE 'SBT_TAPE'
PARMS 'ENV=(OB_MEDIA_FAMILY=datafile_mf)';
```

See Also:

- *Oracle Database Backup and Recovery Reference* for `ALLOCATE CHANNEL` syntax
 - *Oracle Database Backup and Recovery Reference* for channel control options
 - *Oracle Secure Backup Reference* for RMAN-specific parameter settings for Oracle Secure Backup
-
-

5.2.4 Testing Whether the Media Manager Library Is Integrated Correctly

After you have confirmed that the database server can load the media management library, test to ensure that RMAN can back up to the media manager.

You can perform the following tasks:

- [Testing ALLOCATE CHANNEL on the Media Manager](#) (page 5-13)
- [Testing Backup and Restore Operations on the Media Manager](#) (page 5-14)

5.2.4.1 Testing ALLOCATE CHANNEL on the Media Manager

The `ALLOCATE CHANNEL` command is used to perform a basic test of RMAN communication with the media manager.

To test channel allocation on the media manager:

1. Start RMAN and connect to a target database and a recovery catalog (if used).
2. Run the `ALLOCATE CHANNEL` command with the `PARMS` required by your media management software.

The following `RUN` command shows sample vendor-specific `PARMS` settings:

```
RUN
{
  ALLOCATE CHANNEL c1 DEVICE TYPE sbt
  PARMS 'SBT_LIBRARY=/mydir/lib/libobk.so,
  ENV=(OB_DEVICE=drive1,OB_MEDIA_FAMILY=datafile_mf)';
}
```

3. Examine the RMAN output.

If you do not receive an error message, then the database successfully loaded the media management library. If you receive the `ORA-27211` error, the media management library could not be loaded:

```
RMAN-00571: =====
RMAN-00569: ===== ERROR MESSAGE STACK FOLLOWS =====
RMAN-00571: =====
RMAN-03009: failure of allocate command on c1 channel at 11/30/2007 13:57:18
ORA-19554: error allocating device, device type: SBT_TAPE, device name:
ORA-27211: Failed to load Media Management Library
Additional information: 25
```

In this case, check the media management installation to ensure that the library is correctly installed, and recheck the value for the `SBT_LIBRARY` parameter as described in [Determining the Location of the Media Management Library](#) (page 5-11).

If the database cannot locate a media management library in the location specified by the `SBT_LIBRARY` parameter or the default location, then RMAN issues an `ORA-27211` error and exits.

Whenever channel allocation fails, the database writes a trace file to the `trace` subdirectory in the [Automatic Diagnostic Repository \(ADR\)](#) home directory. The following shows sample output:

```
SKGFQ OSD: Error in function sbtinit on line 2278
SKGFQ OSD: Look for SBT Trace messages in file /oracle/rdbms/log/sbtio.log
SBT Initialize failed for /oracle/lib/libobk.so
```

See Also:

Oracle Database Administrator's Guide to learn how to use the Automatic Diagnostic Repository to monitor database operations

5.2.4.2 Testing Backup and Restore Operations on the Media Manager

After testing a channel allocation on the media manager, create and restore a test backup.

Use the `BACKUP` and `RESTORE` commands to perform backup and recovery operations on the media manager. If the backup and restore operations succeed, then you are ready to use the media manager with RMAN.

Possible reasons for failures include the following cases:

- The backup hangs.
A hanging backup usually indicates that the media manager is waiting to mount a tape. Check if there are any media manager jobs in tape mount request mode and fix the problem. Ensure that the steps in [Configuring RMAN to Make Backups to a Media Manager](#) (page 5-10) are correctly done.

- The backup fails with `ORA-27211: Failed to load Media Management Library`.

This error indicates that the media management software is not correctly configured. Ensure that the steps in [Configuring RMAN to Make Backups to a Media Manager](#) (page 5-10) are correctly done. Also, ensure that you have the `PARMS` and `FORMAT` strings required by your media management software.

See Also:

[Testing the Media Management API](#) (page 24-12) and [Troubleshooting RMAN Operations](#) (page 24-1)

Example 5-6 Backing Up the Server Parameter File to Tape

You can use the command in this example (substituting the channel settings required by your media management vendor) to test whether a backup can be created on the media manager. If your database does not use a server parameter file, then back up the current control file instead.

```
RUN
{
  ALLOCATE CHANNEL c1 DEVICE TYPE sbt
  PARMS 'SBT_LIBRARY=/mydir/lib/libobk.so,
  ENV=(OB_DEVICE=drive1,OB_MEDIA_FAMILY=datafile_mf)';
  BACKUP SPFILE;
  # If your database does not use a server parameter file, use:
  # BACKUP CURRENT CONTROLFILE;
}
```

Example 5-7 Restoring the Server Parameter File from Tape

This example restores the backup created in [Example 5-6](#) (page 5-14) to a temporary directory. If the backup to the media manager succeeds, then attempt to restore the server parameter file as an initialization parameter file.

```

RUN
{
  ALLOCATE CHANNEL c1 DEVICE TYPE sbt
  PARMS 'SBT_LIBRARY=/mydir/lib/libobk.so,
  ENV=(OB_DEVICE=drive1,OB_MEDIA_FAMILY=datafile_mf)';
  RESTORE SPFILE TO PFILE '/tmp/test_restore.f';
  # If your database does not use a server parameter file, use:
  # RESTORE CURRENT CONTROLFILE TO '/tmp/test_restore.f';
}

```

5.2.5 Configuring SBT Channels for Use with a Media Manager

Configuring SBT channels creates a persistent setting that is the default used for backup and recovery operations with a media manager.

Note:

- [Configuring Advanced Channel Options](#) (page 6-1)
- [About Media Manager Backup Piece Names](#) (page 5-15)
- [Configuring Automatic SBT Channels](#) (page 5-16)

5.2.5.1 About Media Manager Backup Piece Names

A backup piece name is determined by the `FORMAT` string specified in the `BACKUP` command, `CONFIGURE CHANNEL` command, or `ALLOCATE CHANNEL` command.

The media manager considers the backup piece name as the name of the backup file, so every backup piece must have a unique name in the [media management catalog](#). You can use the substitution variables in a `FORMAT` parameter to generate unique backup piece names. For example, `%d` specifies the name of the database, whereas `%t` specifies the backup time stamp. For most purposes, you can use `%U`, in which case RMAN automatically generates a unique file name. The backup piece name `12i1nk47_1_1` is an example. If you do not specify the `FORMAT` parameter, then RMAN automatically generates a unique file name with the `%U` substitution variable.

Your media manager may impose restrictions on file names and sizes. In this case, you may need more control over the naming of backup pieces so that they obey media manager restrictions. For example, some media managers only support a 14-character backup piece name, and some require special `FORMAT` strings. The unique names generated by the `%U` substitution variable do not exceed 14 characters.

Some media managers may have limits on the maximum size of files that they can back up or restore. You must ensure that RMAN does not produce backup sets larger than those limits. To limit backup piece sizes, use the parameter `MAXPIECESIZE`, which you can set in the `CONFIGURE CHANNEL` and `ALLOCATE CHANNEL` commands.

See Also:

- *Oracle Database Backup and Recovery Reference*
- [About Number and Size of RMAN Backup Pieces](#) (page 8-7) to learn how to set MAXPIECESIZE
- *Oracle Database Backup and Recovery Reference* for the complete list of variables allowable in format strings with the BACKUP command
- Your media management documentation to determine the string character limit for the media manager

5.2.5.2 Configuring Automatic SBT Channels

The easiest technique for backing up to a media manager is to configure automatic SBT channels

As explained in "[Configuring the Default Device for Backups: Disk or SBT](#) (page 5-3)", you can use a tape device as your default backup destination.

To configure channels for use with a media manager:

1. Configure a generic SBT channel.

In the configuration, enter all parameters that you tested in "[Testing Backup and Restore Operations on the Media Manager](#) (page 5-14)". The following example configures vendor-specific channel parameters and sets the default device:

```
CONFIGURE CHANNEL DEVICE TYPE sbt
  PARMS 'ENV=(OB_RESOURCE_WAIT_TIME=1minute,OB_DEVICE=tape1)';
```

2. Configure the default device type to SBT, as shown in the following command:

```
CONFIGURE DEFAULT DEVICE TYPE TO sbt;
```

If you use multiple tape devices, then you must specify the channel parallelism as described in "[Configuring Parallel Channels for Disk and SBT Devices](#) (page 5-6)". The following configuration enables you to back up to two tape drives in parallel:

```
CONFIGURE DEVICE TYPE sbt PARALLELISM 2;
```

Optionally, check your channel configuration by running the following command:

```
SHOW CHANNEL FOR DEVICE TYPE sbt;
```

3. Make a test backup to tape.

The following command backs up the server parameter file to tape:

```
BACKUP SPFILE;
```

4. List your backups to ensure that the test backup went to the media manager:

```
LIST BACKUP OF SPFILE;
```

5.3 Configuring RMAN to Make Backups to Recovery Appliance

RMAN commands can be used to back up target databases to Zero Data Loss Recovery Appliance (Recovery Appliance). Certain configuration steps are required to

use the Recovery Appliance as a centralized repository for the target database backups.

To configure RMAN to create backups to Recovery Appliance:

1. Ensure that the prerequisites described in "[Prerequisites for Using Recovery Appliance](#) (page 5-17)" are met.
2. Complete the steps listed in "[Steps to Configure RMAN for Backups to Recovery Appliance](#) (page 5-17)".

See Also:

Zero Data Loss Recovery Appliance Protected Database Configuration Guide

5.3.1 Prerequisites for Using Recovery Appliance

Before you can use RMAN to back up a target database to Zero Data Loss Recovery Appliance (Recovery Appliance), you must install the Recovery Appliance backup module in the Oracle home of the target database.

The backup module can be installed in the default location or a user-specified location. Installing the Recovery Appliance backup module creates the shared library used to transfer backups to the Recovery Appliance and the Oracle wallet containing credentials used to authenticate the target database with Recovery Appliance.

See Also:

Zero Data Loss Recovery Appliance Protected Database Configuration Guide for information about installing the Recovery Appliance backup module

5.3.2 Steps to Configure RMAN for Backups to Recovery Appliance

RMAN configuration is required before you can back up Oracle databases to Zero Data Loss Recovery Appliance (Recovery Appliance).

1. Determine the location of the Recovery Appliance backup module as described in "[Determining the Location of the Recovery Appliance Backup Module](#) (page 5-18)".
2. Specify Recovery Appliance configuration parameters that must be used by RMAN to create backups to Recovery Appliance as described in "[Specifying Recovery Appliance Configuration Settings for RMAN Backups](#) (page 5-18)".
3. Allocate one or more RMAN channels that will be used by RMAN to backup the database to Recovery Appliance.

You must specify the `SBT_LIBRARY` and the `ENV` parameters while using Recovery Appliance. `SBT_LIBRARY` provides the location of the Recovery Appliance backup module and `ENV` provides the configuration parameters.

Instead of allocating RMAN channels, you can also configure an RMAN SBT channel that will be used to back up to Recovery Appliance. In this case, the channel configuration is persistent and the settings are applicable until they are reset (using `CONFIGURE` command) or overridden for a particular operation using an `ALLOCATE` statement.

See Also:

- [Example 5-8](#) (page 5-18) and [Example 5-9](#) (page 5-19) for examples on configuring RMAN for Recovery Appliance.
 - *Zero Data Loss Recovery Appliance Protected Database Configuration Guide* for information about allocating RMAN channels
-

5.3.3 Determining the Location of the Recovery Appliance Backup Module

Before using RMAN to back up target databases to Zero Data Loss Recovery Appliance (Recovery Appliance), you need to determine the location of the Recovery Appliance backup module on the target database host. This location is used while configuring or allocating RMAN channels for Recovery Appliance.

The `SBT_LIBRARY` parameter in the `CONFIGURE` or `ALLOCATE` command specifies the location of the Recovery Appliance backup module. When RMAN attempts to back up to Recovery Appliance, it loads the shared library indicated by the `SBT_LIBRARY` parameter.

You can specify an absolute path name or a file name for the `SBT_LIBRARY` parameter. If you specify a file name, then RMAN searches for the file in an operating system-specific location. By default, the Recovery Appliance backup module is located in `$ORACLE_HOME/lib/libra.so` on UNIX/Linux and in `%ORACLE_HOME\database\lib\libra.sso` on Windows.

Example 5-8 Specifying the Recovery Appliance Backup Module Location During Channel Configuration

The following command configures an RMAN SBT channel by specifying the absolute path name of the Recovery Appliance backup module on Linux:

```
CONFIGURE CHANNEL DEVICE TYPE sbt PARAMS 'SBT_LIBRARY=/u01/oracle/lib/libra.so';
```

5.3.4 Specifying Recovery Appliance Configuration Settings for RMAN Backups

The client configuration file, stored on the protected database, contains the configuration settings that are used by the Zero Data Loss Recovery Appliance (Recovery Appliance) backup module to communicate with the Recovery Appliance. This file is created automatically when the Recovery Appliance backup module is installed.

The client configuration file must contain the location of the Oracle wallet that stores credentials required to authenticate the target database with Recovery Appliance. Other optional settings may be included.

When using Recovery Appliance, you can include the client configuration settings in an RMAN command. Use the `ENV` parameter of the `RMAN CONFIGURE CHANNEL` or `ALLOCATE CHANNEL` command to directly specify client configuration parameters for Recovery Appliance.

See Also:

Zero Data Loss Recovery Appliance Protected Database Configuration Guide

Example 5-9 Specifying Recovery Appliance Client Configuration Settings

The following command specifies the Recovery Appliance client configuration settings directly as part of the `CONFIGURE CHANNEL` command:

```
CONFIGURE CHANNEL DEVICE TYPE 'SBT_TAPE' PARAMS 'SBT_LIBRARY= libra.so,
ENV=(BA_WALLET=location=file:/home/oracle/product/12.1.0/dbhome_1/wallet
credential_alias=ra-scan:1521/zdlra5:dedicated)';
```

In this example, `ra-scan` is the SCAN of the Recovery Appliance and `zdlra5` is the service name of the Recovery Appliance metadata database.

5.4 Configuring the Fast Recovery Area

The fast recovery area feature enables you to set up a disk area where the database can create and manage a variety of files related to backup and recovery. Use of the fast recovery area is strongly recommended. Consider configuring a fast recovery area as a first step in implementing a backup strategy.

This section outlines the functions of the fast recovery area, identifies the files stored there, explains the rules for file management, and introduces the most important configuration options. This section contains the following topics:

- [Overview of Files in the Fast Recovery Area](#) (page 5-19)
- [Enabling the Fast Recovery Area](#) (page 5-21)
- [Disabling the Fast Recovery Area](#) (page 5-26)
- [Configuring Locations for Control Files and Redo Logs](#) (page 5-27)
- [Configuring RMAN File Creation in the Fast Recovery Area](#) (page 5-28)

See Also:

["Maintaining the Fast Recovery Area](#) (page 12-7)"

5.4.1 Overview of Files in the Fast Recovery Area

The fast recovery area can contain control files, online redo logs, archived redo logs, flashback logs, and RMAN backups.

Files in the recovery area are *permanent* or *transient*. Permanent files are active files used by the database instance. All files that are not permanent are transient. In general, Oracle Database eventually deletes transient files after they become obsolete under the [backup retention policy](#) or have been backed up to tape.

The fast recovery area is an Oracle Database managed space that can be used to hold RMAN disk backups, control file autobackups and archived redo log files. The files placed in this location are maintained by Oracle Database and the generated file names are maintained in Oracle Managed Files (OMF) format.

"[Table 5-2](#) (page 5-20)" describes the files in the recovery area, the classification of each file as permanent or temporary, and how database availability is affected.

Table 5-2 Files in the Fast Recovery Area

Files	Type	Database Behavior When Fast Recovery Area Is Inaccessible
Multiplexed copies of the current control file	Permanent	The instance fails if the database cannot write to a multiplexed copy of the control file stored in the fast recovery area. Failure occurs even if accessible multiplexed copies are located outside the recovery area. See Also: " Configuring Control File Locations (page 5-27)" to learn how to configure control files in the recovery area
Online redo log files	Permanent	Instance availability is not affected if a mirrored copy of the online redo log exists in an accessible location outside the fast recovery area. Otherwise, the instance fails. See Also: " Configuring Online Redo Log Locations (page 5-27)" to learn how to configure online redo logs in the recovery area
Archived redo log files	Transient	Instance availability is not affected if the log is archived to an accessible location outside the fast recovery area. Otherwise, the database eventually halts because it cannot archive the online redo logs. See Also: " Configuring Archived Redo Log Locations (page 5-28)" to learn how to configure archived redo logs in the recovery area
Foreign archived redo log files	Transient	Instance availability is not affected. Note: Foreign archived redo logs are received by a logical standby database for a LogMiner session. Unlike a normal archived log, a foreign archived redo log is associated with a different DBID. For this reason, it cannot be backed up or restored on a logical standby database.
Image copies of data files and control files	Transient	Instance availability is not affected.
Backup pieces	Transient	Instance availability is not affected.
Flashback logs	Transient	Instance availability is not affected if guaranteed restore points are not defined. In this case, the database automatically disables Flashback Database, writes a message to the alert log, and continues with database processing. If guaranteed restore points are configured, the instance fails because of interdependencies on the flashback logs. The Oracle Flashback Database feature, which provides a convenient alternative to database point-in-time recovery (DBPITR) , generates flashback logs . These logs are transient files and must be stored in the fast recovery area. Unlike other transient files, flashback logs cannot be backed up to other media. If the fast recovery area has insufficient space to store flashback logs and meet other backup retention requirements, then the recovery area may delete flashback logs. See Also: " Enabling Flashback Database (page 7-17)" to learn how to enable flashback logging

If you are on a Windows platform, then you can use the [Volume Shadow Copy Service \(VSS\)](#) with the [Oracle VSS writer](#). In this case, the fast recovery area automates management of files that are backed up in a VSS snapshot and deletes them as needed.

See Also:

- [Performing Flashback and Database Point-in-Time Recovery](#) (page 18-1)
 - *Oracle Database Platform Guide for Microsoft Windows* to learn about making backups in a VSS environment
-
-

5.4.1.1 Fast Recovery Area with Oracle Managed Files and Automatic Storage Management

The fast recovery area can be used with Oracle Managed Files (OMF) and Automatic Storage Management (ASM)

Because the fast recovery area is built on top of OMF, it can be stored anywhere that Oracle Managed Files can. You can also use the recovery area with ASM.

Even if you choose not to set up the fast recovery area in ASM storage, you can still use Oracle Managed Files to manage your backup files in an ASM disk group. However, you lose a major benefit of the fast recovery area: the automatic deletion of files no longer needed to meet your recoverability goals as space is needed for more recent backups. Nevertheless, the other automatic features of OMF still function.

When you store backups, using OMF on top of ASM without using a fast recovery area is supported but discouraged. It is awkward to directly manipulate files under ASM.

5.4.1.2 How Oracle Manages Disk Space in the Fast Recovery Area

Space in the fast recovery area is balanced among backups and archived logs that must be kept according to the retention policy, and other files that may be subject to deletion.

Oracle Database does not delete eligible files from the fast recovery area until the space must be reclaimed for some other purpose. Files recently moved to tape are often still available on disk for use in recovery. The recovery area can thus serve as a cache for tape. When the fast recovery area is full, Oracle Database automatically deletes eligible files to reclaim space in the recovery area as needed.

See Also:

- [Deletion Rules for the Fast Recovery Area](#) (page 12-7)
 - [Responding to a Full Fast Recovery Area](#) (page 12-9)
-
-

5.4.2 Enabling the Fast Recovery Area

You enable the fast recovery area by setting two initialization parameters. These parameters enable the fast recovery area with or without having to shut down and restart the database instance.

You set the size of the fast recovery area with the parameter `DB_RECOVERY_FILE_DEST_SIZE` first, and then you set the physical location of the flash recovery files with the parameter `DB_RECOVERY_FILE_DEST`.

[Table 5-3](#) (page 5-22) discusses both the mandatory and optional parameters for enabling the fast recovery area.

In an Oracle Real Application Clusters (Oracle RAC) database, all instances must have the same values for these initialization parameters. The location must be on a cluster file system, ASM, or a shared directory.

Table 5-3 Initialization Parameters for the Fast Recovery Area

Initialization Parameter	Required	Description
<code>DB_RECOVERY_FILE_DEST_SIZE</code>	Yes	<p>Specifies the disk quota, which is maximum storage in bytes of data to be used by the recovery area for this database. You must set this parameter <i>before</i> <code>DB_RECOVERY_FILE_DEST</code>.</p> <p>The <code>DB_RECOVERY_FILE_DEST_SIZE</code> setting does not include the following kinds of disk overhead:</p> <ul style="list-style-type: none"> Block 0 or the operating system block header of each Oracle Database file is not included. <ul style="list-style-type: none"> Allow an extra 10% for this data when computing the actual disk usage required for the fast recovery area. <code>DB_RECOVERY_FILE_DEST_SIZE</code> does not indicate the real size occupied on disk when the underlying file system is mirrored, compressed, or affected by overhead not known to Oracle Database. <ul style="list-style-type: none"> For example, if the recovery area is on a two-way mirrored ASM disk group, each file of x bytes occupies $2x$ bytes on the ASM disk group. In this case, set <code>DB_RECOVERY_FILE_DEST_SIZE</code> to no more than half the size of the disks for the ASM disk group. Likewise, when using a three-way mirrored ASM disk group, <code>DB_RECOVERY_FILE_DEST_SIZE</code> must be no more than one third the size of the disks in the disk group, and so on.
<code>DB_RECOVERY_FILE_DEST</code>	Yes	<p>Specifies the recovery area location, which can be a file system directory or ASM disk group, but not a raw disk. The location must be large enough for the disk quota.</p>

Table 5-3 (Cont.) Initialization Parameters for the Fast Recovery Area

Initialization Parameter	Required	Description
DB_FLASHBACK_RETENTION_TARGET	No	<p>Specifies the upper limit (in minutes) on how far back in time the database may be flashed back. This parameter is required only for Flashback Database.</p> <p>This parameter indirectly determines how much flashback log data is kept in the recovery area. The size of flashback logs generated by the database can vary considerably depending on the database workload. If more blocks are affected by database updates during a given interval, then more disk space is used by the flashback log data generated for that interval.</p>

See Also:

- *Oracle Database SQL Language Reference* for ALTER SYSTEM syntax
- *Oracle Database Administrator's Guide* for details on setting and changing database initialization parameters

5.4.2.1 Considerations When Setting the Size of the Fast Recovery Area

The larger the fast recovery area is, the more useful it becomes. Ideally, the fast recovery area is large enough to contain the control files, online redo logs, archived redo logs, and flashback logs. It should be able to contain a copy of all data files in the database and the incremental backups used by your chosen backup strategy.

If providing this much space is impractical, then it is best to create an area large enough to keep a backup of the most important tablespaces and all the archived logs not yet on tape. At an absolute minimum, the fast recovery area must be large enough to contain the archived redo logs not yet on tape. If the recovery area has insufficient space to store new flashback logs and meet other backup retention requirements, then to make room, the recovery area may delete older flashback logs.

Formulas for estimating a useful fast recovery area size depend on whether:

- Your database has a small or large number of data blocks that change frequently
- You store backups only on disk, or on disk and tape
- You use a redundancy-based [backup retention policy](#), or a recovery window-based retention policy
- You plan to use Flashback Database or a [guaranteed restore point](#) as alternatives to [point-in-time recovery](#) in response to logical errors

If you plan to enable flashback logging, then the volume of flashback log generation is approximately the same order of magnitude as redo log generation. For example, if you intend to set DB_FLASHBACK_RETENTION_TARGET to 24 hours, and if the database generates 20 gigabytes of redo in a day, then a general rule of thumb is to allow 20 GB to 30 GB of disk space for the flashback logs. The same rule applies to

guaranteed restore points when flashback logging is enabled. For example, if the database generates 20 GB of redo every day, and if the guaranteed restore point is kept for a day, then plan to allocate 20 to 30 GB.

Suppose that you want to determine the size of a fast recovery area when the backup retention policy is set to `REDUNDANCY 1` and you intend to follow Oracle's suggested strategy of using an [incremental forever](#). In this example, you use the following formula to estimate the disk quota, where n is the interval in days between incremental updates and y is the delay in applying the foreign archived redo logs on a logical standby database:

```
Disk Quota =
Size of a copy of database +
Size of an incremental backup +
Size of (n+1) days of archived redo logs +
Size of (y+1) days of foreign archived redo logs (for logical standby) +
Size of control file +
Size of an online redo log member * number of log groups +
Size of flashback logs (based on DB_FLASHBACK_RETENTION_TARGET value)
```

5.4.2.2 Considerations When Setting the Location of the Fast Recovery Area

Place the fast recovery area on a separate disk from the [database area](#), where the database maintains active database files such as data files, control files, and online redo logs. Keeping the fast recovery area on the same disk as the database area exposes you to loss of both your live database files and backups if a media failure occurs.

Oracle recommends that `DB_RECOVERY_FILE_DEST` be set to a different value from `DB_CREATE_FILE_DEST` or any of the `DB_CREATE_ONLINE_LOG_DEST_n` initialization parameters. The database writes a warning to the alert log if `DB_RECOVERY_FILE_DEST` equals these parameters.

Multiple databases can have the same value for `DB_RECOVERY_FILE_DEST`, but one of the following must be true:

- No two databases for which the `DB_UNIQUE_NAME` initialization parameters are specified have the same value for `DB_UNIQUE_NAME`.
- For those databases where no `DB_UNIQUE_NAME` is provided, no two databases have the same value for `DB_NAME`.

When databases share a single recovery area in this way, the location should be large enough to hold the files for all databases. Add the values for `DB_RECOVERY_FILE_DEST_SIZE` for the databases, then allow for overhead such as mirroring or compression.

5.4.2.3 Setting the Fast Recovery Area Location and Initial Size

Use database initialization parameters to set the location and size of the fast recovery area.

[Table 5-3](#) (page 5-22) lists the initialization parameters that you must set to enable the fast recovery area. This section explains how to specify a location for the recovery area and set its initial size.

To determine the optimum size for the fast recovery area and set the recovery area location:

1. If you plan to use flashback logging or guaranteed restore points, then query V\$ARCHIVED_LOG to determine how much redo the database generates in the time to which you intend to set DB_FLASHBACK_RETENTION_TARGET.
2. Set the recovery area size.

If you plan to use flashback logging or guaranteed restore points, then ensure that the size value obtained from Step 1 (page 5-25) is incorporated into the setting. Set the DB_RECOVERY_FILE_DEST_SIZE initialization parameter by any of the following means:

- Shut down the database and set the DB_RECOVERY_FILE_DEST_SIZE parameter in the initialization parameter file of the database, as shown in the following example:

```
DB_RECOVERY_FILE_DEST_SIZE = 10G
```

- Specify the parameter with the SQL statement ALTER SYSTEM SET when the database is open, as shown in the following examples:

```
ALTER SYSTEM SET
  DB_RECOVERY_FILE_DEST_SIZE = 10G
  SCOPE=BOTH SID='*';
```

Note:

The DB_RECOVERY_FILE_DEST_SIZE and DB_RECOVERY_FILE_DEST settings must be persistent across database startup and shutdown. If a server parameter file is used, then setting SCOPE=BOTH results in the settings being persistent. However, if a server parameter file is not used, then the changes made by the ALTER SYSTEM command are not persistent. You must also add these parameters to the initialization parameter file.

- Use the Database Configuration Assistant to set the size.
3. Set the recovery area location.

Set the initialization parameters by any of the following means:

- Set DB_RECOVERY_FILE_DEST in the parameter file of the database, as shown in the following example:

```
DB_RECOVERY_FILE_DEST = '/u01/oradata/rcv_area'
```

- Specify DB_RECOVERY_FILE_DEST with the SQL statement ALTER SYSTEM SET when the database is open.

The following example sets the fast recovery area to an Automatic Storage Management (ASM) disk group named disk1:

```
ALTER SYSTEM SET
  DB_RECOVERY_FILE_DEST = '+disk1'
  SCOPE=BOTH SID='*';
```

The following example sets the fast recovery area to the file system directory /disk1/fast_recovery_area:

```
ALTER SYSTEM SET
  DB_RECOVERY_FILE_DEST = '/disk1/fast_recovery_area'
  SCOPE = BOTH SID = '*';
```

- Use the Database Configuration Assistant to set the location.

If you do *not* plan to use flashback logging, then open the database (if it is closed) and do not complete the rest of the steps in this procedure.

4. If flashback logging is enabled, then run the database under a normal workload for the time period specified by `DB_FLASHBACK_RETENTION_TARGET`.

In this way, the database can generate a representative sample of flashback logs.

5. Query the `V$FLASHBACK_DATABASE_LOG` view as follows:

```
SELECT ESTIMATED_FLASHBACK_SIZE
FROM   V$FLASHBACK_DATABASE_LOG;
```

The result is an estimate of the disk space needed to meet the current flashback retention target, based on the database workload since Flashback Database was enabled.

6. If necessary, adjust the flashback log space requirement based on the actual size of flashback logs generated during the time period specified by `DB_FLASHBACK_RETENTION_TARGET`.

See Also:

["Managing Space for Flashback Logs in the Fast Recovery Area \(page 12-9\)"](#)

5.4.3 Disabling the Fast Recovery Area

You can use the `ALTER SYSTEM` command to disable the fast recovery area.

If you have enabled Flashback Database or use the fast recovery area for archive logs, then take the appropriate steps from those that follow below. Otherwise, skip to Step 3:

1. If Flashback Database is enabled, then disable it before you disable the fast recovery area.

```
ALTER DATABASE FLASHBACK OFF;
```

2. If you are using the fast recovery area for archive logs, then set the initialization parameter `LOG_ARCHIVE_DEST_1` to use a non-fast recovery area location.

For example, to change the fast recovery area for `LOG_ARCHIVE_DEST_1` to a non-fast recovery area location, use the command `ALTER SYSTEM SET`:

```
LOG_ARCHIVE_DEST_1='LOCATION=USE_DB_RECOVERY_FILE_DEST'

ALTER SYSTEM SET LOG_ARCHIVE_DEST_1='LOCATION=/ORACLE/DBS/';
```

3. Disable the fast recovery area initialization parameter.

```
ALTER SYSTEM SET DB_RECOVERY_FILE_DEST='';
```

5.4.4 Configuring Locations for Control Files and Redo Logs

Use initialization parameters to configure the default locations for control files and redo logs.

See Also:

- [Overview of Files in the Fast Recovery Area](#) (page 5-19)
 - [Configuring Online Redo Log Locations](#) (page 5-27)
 - [Configuring Control File Locations](#) (page 5-27)
 - [Configuring Archived Redo Log Locations](#) (page 5-28)
-
-

5.4.4.1 Configuring Online Redo Log Locations

The initialization parameters that determine where online redo log files are created are `DB_CREATE_ONLINE_LOG_DEST_n`, `DB_RECOVERY_FILE_DEST`, and `DB_CREATE_FILE_DEST`.

The following SQL statements can create online redo logs in the fast recovery area:

- `CREATE DATABASE`
- `ALTER DATABASE ADD LOGFILE`
- `ALTER DATABASE ADD STANDBY LOGFILE`
- `ALTER DATABASE OPEN RESETLOGS`

The default size of an online log created in the fast recovery area is 100 megabytes. The log member file names are automatically generated by the database.

See Also:

Description of the `LOGFILE` clause of the `CREATE DATABASE` statement in *Oracle Database SQL Language Reference* for details of the effect of combinations of the initialization parameters on online redo log creation

5.4.4.2 Configuring Control File Locations

The initialization parameters `CONTROL_FILES`, `DB_CREATE_ONLINE_LOG_DEST_n`, `DB_RECOVERY_FILE_DEST`, and `DB_CREATE_FILE_DEST` all interact to determine the location where the database control files are created.

If the database creates an Oracle managed control file, and if the database uses a server parameter file, then the database sets the `CONTROL_FILES` initialization parameter in the server parameter file. If the database uses a client-side initialization parameter file, then you must set the `CONTROL_FILES` initialization parameter manually in the initialization parameter file.

See Also:

The "Semantics" section of the description of `CREATE CONTROLFILE` in *Oracle Database SQL Language Reference* for a full description of how these parameters interact

5.4.4.3 Configuring Archived Redo Log Locations

Oracle recommends that you use the fast recovery area as an archiving location because the archived logs are automatically managed by the database.

The generated file names for the archived logs in the fast recovery area are for Oracle-managed files and are not determined by the parameter `LOG_ARCHIVE_FORMAT`. Whatever archiving scheme you choose, it is always advisable to create multiple copies of archived redo logs.

You have the following basic options for archiving redo logs, listed from most to least recommended:

1. Enable archiving to the fast recovery area *only* and use disk mirroring to create the redundancy needed to protect the archived redo logs.

If `DB_RECOVERY_FILE_DEST` is specified and no `LOG_ARCHIVE_DEST_n` is specified, then `LOG_ARCHIVE_DEST_10` is implicitly set to the recovery area. You can override this behavior by setting `LOG_ARCHIVE_DEST_10` to an empty string.

2. Enable archiving to the fast recovery area and set other `LOG_ARCHIVE_DEST_n` initialization parameter to locations outside the fast recovery area.

If a fast recovery area is configured, then you can add the fast recovery area as an archiving destination by setting any `LOG_ARCHIVE_DEST_n` parameter to `LOCATION=USE_DB_RECOVERY_FILE_DEST`.

3. Set `LOG_ARCHIVE_DEST_n` initialization parameters to archive *only* to non-fast recovery area locations.

If you use the fast recovery area, then you cannot use the `LOG_ARCHIVE_DEST` and `LOG_ARCHIVE_DUPLEX_DEST` initialization parameters. Using either of these parameters prevents you from starting the instance. Instead, set the `LOG_ARCHIVE_DEST_n` parameters. After your database is using `LOG_ARCHIVE_DEST_n`, you can configure a recovery area.

Note also that if you enable archiving but do not set any value for `LOG_ARCHIVE_DEST`, `LOG_ARCHIVE_DEST_n`, or `DB_RECOVERY_FILE_DEST`, then the redo logs are archived to a default location that is platform-specific. For example, on Solaris the default is `*/dbs`.

See Also:

Oracle Database Reference for details on the semantics of the `LOG_ARCHIVE_DEST_n` parameters

5.4.5 Configuring RMAN File Creation in the Fast Recovery Area

Certain RMAN commands or implicit actions (such as control file autobackups) can create files in the fast recovery area.

This section explains how to control whether a command creates files in the fast recovery area or in another destination. The commands are:

- `BACKUP`

If you do not specify the `FORMAT` clause for disk backups, then RMAN creates backup pieces and image copies in the fast recovery area, with names in Oracle Managed Files (OMF) format. If a fast recovery area is enabled, and if you *do* specify `FORMAT` on `BACKUP` or a channel, then RMAN creates the backup in a platform-specific location rather than in the recovery area.

- `Control File Autobackup`

RMAN can create control file autobackups in the fast recovery area. Use the RMAN command `CONFIGURE CONTROLFILE AUTOBACKUP FORMAT FOR DEVICE TYPE DISK CLEAR` to clear any configured format option for the control file autobackup location on disk. RMAN creates control file autobackups in the fast recovery area when no other destination is configured.

- `RESTORE ARCHIVELOG`

Explicitly or implicitly set a `LOG_ARCHIVE_DEST_n` parameter to `LOCATION=USE_DB_RECOVERY_FILE_DEST`. If you do not specify `SET ARCHIVELOG DESTINATION` to override this behavior, then RMAN restores archived redo log files to the fast recovery area.

- `RECOVER DATABASE` or `RECOVER TABLESPACE`, `RECOVER . . . BLOCK`, and `FLASHBACK DATABASE`

These commands restore archived redo log files from backup for use during media recovery, as required by the command. RMAN restores any redo log files needed during these operations to the fast recovery area and deletes them after they are applied during media recovery.

To direct the restored archived logs to the fast recovery area, set a `LOG_ARCHIVE_DEST_n` parameter to `LOCATION = USE_DB_RECOVERY_FILE_DEST`. Verify that you are not using `SET ARCHIVELOG DESTINATION` to direct restored logs to some other destination.

5.5 Configuring the Backup Retention Policy

The backup retention policy specifies which backups must be retained to meet your data recovery requirements.

This policy can be based on a [recovery window](#) or [redundancy](#). Use the `CONFIGURE RETENTION POLICY` command to specify the retention policy.

This section contains the following topics:

- [Configuring a Redundancy-Based Retention Policy](#) (page 5-30)
- [Configuring a Recovery Window-Based Retention Policy](#) (page 5-30)
- [Disabling the Retention Policy](#) (page 5-31)

See Also:

- [About Backup Retention Policies](#) (page 8-22)
 - *Oracle Database Backup and Recovery Reference* for CONFIGURE syntax
-

5.5.1 Configuring a Redundancy-Based Retention Policy

The REDUNDANCY parameter of the CONFIGURE RETENTION POLICY command specifies how many full or level 0 backups of each data file and control file that RMAN keeps. The default retention policy is REDUNDANCY 1.

If the number of full or level 0 backups for a specific data file or control file exceeds the REDUNDANCY setting, then RMAN considers the extra backups as obsolete. As you produce more backups, RMAN keeps track of which ones to retain and which are obsolete. RMAN retains all archived logs and incremental backups that are needed to recover the nonobsolete backups.

Assume that you make a full backup of data file 7 on Monday, Tuesday, Wednesday, and Thursday. You now have four full backups of this data file. If REDUNDANCY is 2, then the Monday and Tuesday backups are obsolete. If you make another backup on Friday, then the Wednesday backup of data file 7 becomes obsolete.

Assume a different case in which REDUNDANCY is 1. You run a level 0 database backup at noon on Monday, a level 1 cumulative backup at noon on Tuesday and Wednesday, and a level 0 backup at noon on Thursday. Immediately after each daily backup you run the command DELETE OBSOLETE. The Wednesday DELETE command does not remove the Tuesday level 1 backup because this backup is not redundant: the Tuesday level 1 backup could be used to recover the Monday level 0 backup to a time between noon on Tuesday and noon on Wednesday. However, the DELETE command on Thursday removes the previous level 0 and level 1 backups.

Run the CONFIGURE RETENTION POLICY command at the RMAN prompt, as in the following example:

```
CONFIGURE RETENTION POLICY TO REDUNDANCY 3;
```

See Also:

[Deleting Obsolete RMAN Backups Based on Retention Policies](#) (page 12-26)

5.5.2 Configuring a Recovery Window-Based Retention Policy

The RECOVERY WINDOW parameter of the CONFIGURE command specifies the number of days between the current time and the earliest point of recoverability.

RMAN does not consider any full or [level 0 incremental backup](#) as obsolete if it falls within the recovery window. Additionally, RMAN retains all archived logs and level 1 incremental backups that are needed to recover to a random point within the window. Use the CONFIGURE RETENTION POLICY command at the RMAN prompt to configure a recovery window-based retention policy.

The following example ensures that you can recover the database to any point within the last week:

```
CONFIGURE RETENTION POLICY TO RECOVERY WINDOW OF 7 DAYS;
```

RMAN does not automatically delete backups rendered obsolete by the recovery window. Instead, RMAN shows them as `OBSOLETE` in the `REPORT OBSOLETE` output and in the `OBSOLETE` column of `V$BACKUP_FILES`. RMAN deletes obsolete files if you run the `DELETE OBSOLETE` command.

See Also:

[Deleting Obsolete RMAN Backups Based on Retention Policies](#) (page 12-26)

5.5.3 Disabling the Retention Policy

When you disable the retention policy, RMAN does not consider any backup as obsolete.

To disable the retention policy, run this command:

```
CONFIGURE RETENTION POLICY TO NONE;
```

Configuring the retention policy to `NONE` is different from clearing it. Clearing returns the default setting of `REDUNDANCY 1`, whereas `NONE` disables it.

If you disable the retention policy and run `REPORT OBSOLETE` or `DELETE OBSOLETE` commands without passing a retention policy option to the command, then RMAN issues an error because no retention policy exists to determine which backups are obsolete.

Caution:

If you are using a fast recovery area, then do not run your database with the retention policy disabled. If files are never considered obsolete, then a file can only be deleted from the fast recovery area if it has been backed up to some other disk location or to a tertiary storage device such as tape. This action is likely to use all of the space in your recovery area, which interferes with the normal operation of your database. See "[How Oracle Manages Disk Space in the Fast Recovery Area](#) (page 5-21)"

5.6 Backup Optimization and the CONFIGURE command

Run the RMAN `CONFIGURE` command to enable and disable backup optimization. Backup optimization skips the backup of files in certain circumstances if the identical file or an identical version of the file has been backed up.

This section contains the following topics:

- [Overview of Backup Optimization](#) (page 5-31)
- [Effect of Retention Policies on Backup Optimization for SBT Backups](#) (page 5-33)
- [Configuring Backup Optimization](#) (page 5-35)

5.6.1 Overview of Backup Optimization

When you enable backup optimization, the `BACKUP` command skips backing up files when the identical file has been backed up to the specified device type.

Table 5-4 (page 5-32) describes criteria that RMAN uses to determine whether a file is identical to a file that it already backed up.

Table 5-4 Criteria to Determine an Identical File

Type of File	Criteria to Determine an Identical File
Data file	The data file must have the same DBID , checkpoint SCN , creation SCN, and RESETLOGS SCN and time as a data file in a backup. The data file must be offline-normal, read-only, or closed normally.
Archived log	Same DBID, thread, sequence number, and RESETLOGS SCN and time
Backup set	Same DBID, backup set record ID, and stamp

If RMAN determines that a file is identical and it has been backed up, then it is a candidate to be skipped. RMAN must do further checking to determine whether to skip the file, however, because both the retention policy and the backup duplexing feature are factors in the algorithm that determines whether RMAN has sufficient backups on the specified device type.

RMAN uses backup optimization when the following conditions are true:

- The `CONFIGURE BACKUP OPTIMIZATION ON` command has been run to enable backup optimization.
- You run `BACKUP DATABASE`, `BACKUP ARCHIVELOG` with `ALL` or `LIKE` options, or `BACKUP BACKUPSET ALL`, `BACKUP RECOVERY AREA`, `BACKUP RECOVERY FILES`, or `BACKUP DATAFILECOPY`.

Note:

When `TO DESTINATION` is used with `BACKUP RECOVERY AREA` or `BACKUP RECOVERY FILES`, RMAN only skips backups of files that have identical backups in the `TO DESTINATION` location that you provide.

- Only one type of channel is allocated, do not mix disk and [SBT](#) channels in the same backup command.

Note:

In [backup undo optimization](#), RMAN excludes undo changes (that are not needed for recovery of a backup) for transactions that have been committed. You can enable and disable backup optimization, but backup undo optimization is built-in behavior.

For example, assume that you have configured backup optimization. These commands back up to tape the database, all archived logs, and all backup sets:

```
BACKUP DEVICE TYPE sbt DATABASE PLUS ARCHIVELOG;
BACKUP DEVICE TYPE sbt BACKUPSET ALL;
```

If no backed-up file has changed since the last backup, then RMAN does not back up the files again. RMAN also does not signal an error if it skips all files specified in the command because the files have already been backed up.

You can override optimization at any time by specifying the `FORCE` option on the `BACKUP` command. For example, you can run:

```
BACKUP DATABASE FORCE;
BACKUP ARCHIVELOG ALL FORCE;
```

See Also:

The `CONFIGURE` entry in *Oracle Database Backup and Recovery Reference* for a complete description of the backup optimization rules

5.6.2 Effect of Retention Policies on Backup Optimization for SBT Backups

Backup optimization is not always applied when backing up to SBT devices.

The exceptions to normal backup optimization behavior for recovery window-based and redundancy-based retention policies are described in the following sections.

- [About Backup Optimization for SBT Backups with Recovery Window Retention Policy](#) (page 5-33)
- [About Backup Optimization for SBT Backups With Redundancy Retention Policy](#) (page 5-34)
- [Configuring Backup Optimization](#) (page 5-35)

Note:

Use caution when enabling backup optimization if you use a media manager with its own internal expiration policy. Run the `CROSSCHECK` command periodically to synchronize the RMAN repository with the media manager. Otherwise, RMAN may skip backups due to optimization without recognizing that the media manager has discarded backups stored on tape.

5.6.2.1 About Backup Optimization for SBT Backups with Recovery Window Retention Policy

Suppose that backup optimization is enabled, and a recovery window [backup retention policy](#) is in effect. In this case, when performing SBT backups RMAN always backs up data files whose most recent backup is older than the [recovery window](#).

For example, assume the following scenario:

- Today is February 21.
- The recovery window is 7 days.
- The most recent backup of tablespace `tools` to tape is January 3.
- Tablespace `tools` is read-only.

On February 21, when you issue a command to back up tablespace `tools` to tape, RMAN backs it up even though it did not change after the January 3 backup (because

it is read-only). RMAN makes the backup because no backup of the tablespace exists within the 7-day recovery window.

This behavior enables the media manager to expire old tapes. Otherwise, the media manager is forced to keep the January 3 backup of tablespace `TOOLS` indefinitely. By making a more recent backup of tablespace `tools` on February 21, RMAN enables the media manager to expire the tape containing the January 3 backup.

5.6.2.2 About Backup Optimization for SBT Backups With Redundancy Retention Policy

Assume that you configure a retention policy for redundancy. In this case, RMAN only skips backups of offline or read-only data files to SBT when there are $r + 1$ backups of the files, where r is set in `CONFIGURE RETENTION POLICY TO REDUNDANCY r` .

For example, assume that you enable backup optimization and set the following retention policy:

```
CONFIGURE DEFAULT DEVICE TYPE TO sbt;
CONFIGURE BACKUP OPTIMIZATION ON;
CONFIGURE RETENTION POLICY TO REDUNDANCY 2;
```

With these settings, RMAN only skips backups when three identical files are backed up. Also assume that you have never backed up the `users` tablespace, which is read/write, and that you perform the actions described in [Table 5-5](#) (page 5-34) over the course of the week.

Table 5-5 Effect of Redundancy Setting on Backup Optimization

Day	Action	Result	Redundant Backup
Monday	Take <code>users</code> offline normal.		
Tuesday	<code>BACKUP DATABASE</code>	The <code>users</code> tablespace is backed up.	
Wednesday	<code>BACKUP DATABASE</code>	The <code>users</code> tablespace is backed up.	
Thursday	<code>BACKUP DATABASE</code>	The <code>users</code> tablespace is backed up.	Tuesday backup
Friday	<code>BACKUP DATABASE</code>	The <code>users</code> tablespace is <i>not</i> backed up.	Tuesday backup
Saturday	<code>BACKUP DATABASE</code>	The <code>users</code> tablespace is <i>not</i> backed up.	Tuesday backup
Sunday	<code>DELETE OBSOLETE</code>	The Tuesday backup is deleted.	
Monday	<code>BACKUP DATABASE</code>	The <code>users</code> tablespace is backed up.	Wednesday backup

The backups on Tuesday, Wednesday, and Thursday back up the offline `users` tablespace to satisfy the condition that three backups must exist (one more than

redundancy setting). The Friday and Saturday backups do not back up the `users` tablespace because of backup optimization. The Tuesday backup of `users` is obsolete beginning on Thursday.

On Sunday, you delete all obsolete backups, which removes the Tuesday backup of `users`. The Tuesday backup is obsolete because of the retention policy setting. The whole database backup on Monday then backs up the `users` tablespace to satisfy the condition that three backups must exist (one more than redundancy setting). In this way, you can recycle your tapes over time.

See Also:

["Backup Optimization and the CONFIGURE command \(page 5-31\)"](#)

5.6.3 Configuring Backup Optimization

By default, backup optimization is configured to `OFF`. You can use the `SHOW BACKUP OPTIMIZATION` command to view the current settings of backup optimization.

To configure backup optimization:

1. Start RMAN and connect to a target database and a recovery catalog (if used).
2. Run the `SHOW BACKUP OPTIMIZATION` command to determine whether optimization is currently enabled.

For example, enter the following command:

```
SHOW BACKUP OPTIMIZATION;
```

Sample output for `SHOW BACKUP OPTIMIZATION` follows:

```
RMAN configuration parameters for database with db_unique_name PROD1 are:  
CONFIGURE BACKUP OPTIMIZATION OFF;
```

3. Enable backup optimization by running the following command:

```
CONFIGURE BACKUP OPTIMIZATION ON;
```

See Also:

["Using Backup Optimization to Skip Files \(page 10-4\)"](#) for examples of how to optimize RMAN backups

5.7 Configuring an Archived Redo Log Deletion Policy

You can use RMAN to create a persistent configuration that governs when archived redo logs are eligible for deletion from disk.

This section contains the following topics:

- [About Archived Redo Log Deletion Policies \(page 5-36\)](#)
- [Enabling an Archived Redo Log Deletion Policy \(page 5-37\)](#)

5.7.1 About Archived Redo Log Deletion Policies

You can use the `CONFIGURE ARCHIVELOG DELETION POLICY` command to specify when archived redo logs are eligible for deletion.

This deletion policy applies to all archiving destinations, including the [fast recovery area](#).

Archived redo logs can be deleted automatically by the database or by user-initiated RMAN commands. Only logs in the fast recovery area can be deleted automatically by the database. For archived redo log files in the fast recovery area, the database retains them as long as possible and automatically deletes eligible logs when additional disk space is required. You can manually delete eligible logs from any location, whether inside or outside the fast recovery area, when you issue `BACKUP . . . DELETE INPUT` or `DELETE ARCHIVELOG` commands.

5.7.1.1 When the Archived Redo Log Deletion Policy Is Disabled

By default, there is no archived redo log deletion policy and this is why the archive redo log policy is set to the `NONE` clause.

In this particular case, the fast recovery area considers archived redo log files in the recovery area as eligible for deletion if they have been backed up at least once to disk or SBT or the logs are obsolete according to the backup retention policy. The backup retention policy considers logs obsolete only if the logs are not needed by a guaranteed restore point and the logs are not needed by Oracle Flashback Database. Archived redo logs are needed by Flashback Database if the logs were created later than `SYSDATE - 'DB_FLASHBACK_RETENTION_TARGET'`.

See Also:

- The `CONFIGURE ARCHIVELOG DELETION POLICY` entry in *Oracle Database Backup and Recovery Reference* for detailed information about policy options
 - *Oracle Data Guard Concepts and Administration* to learn how to configure an archived log deletion policy in a Data Guard environment
-
-

5.7.1.2 When the Archived Redo Log Deletion Policy Is Enabled

You can use the `CONFIGURE ARCHIVELOG DELETION POLICY BACKED UP integer TIMES TO DEVICE TYPE` command to enable an archived log deletion policy. This configuration specifies that archived logs are eligible for deletion only when the specified number of archived log backups exist on the specified device type.

If the deletion policy is configured with the `BACKED UP integer TIMES` clause, then a `BACKUP ARCHIVELOG` command copies the logs unless *integer* backups exist on the specified device type. If *integer* backups of the logs exist, then the `BACKUP ARCHIVELOG` command skips the logs. In this way, the archived log deletion policy functions as a default `NOT BACKED UP integer TIMES` clause on the `BACKUP ARCHIVELOG` command. You can override the deletion policy by specifying the `FORCE` option on the `BACKUP` command.

The archived log deletion policy also has options specific to a Data Guard environment. For example, if you specify the `APPLIED ON STANDBY` clause, then RMAN can delete logs after they have been applied at all mandatory remote

destinations. If you specify `SHIPPED TO STANDBY`, then RMAN can delete logs when they have been transferred to all mandatory standby destinations.

See Also:

- The `CONFIGURE ARCHIVELOG DELETION POLICY` entry in *Oracle Database Backup and Recovery Reference* for detailed information about policy options
 - *Oracle Data Guard Concepts and Administration* to learn how to configure an archived log deletion policy in a Data Guard environment
-
-

5.7.2 Enabling an Archived Redo Log Deletion Policy

By default the archived redo log deletion policy is set to `NONE`.

To enable an archived redo log deletion policy:

1. Start RMAN and connect to a target database and a recovery catalog (if used).
2. Run the `CONFIGURE ARCHIVELOG DELETION POLICY` command with the desired options.

The following example specifies that archived redo logs are eligible to be deleted from the fast recovery area and all local archiving destinations when logs have been backed up at least twice to tape:

```
CONFIGURE ARCHIVELOG DELETION POLICY
  TO BACKED UP 2 TIMES TO SBT;
```

See Also:

- [Deleting Archived Redo Logs After Backups in non-CDBs](#) (page 9-32)
 - *Oracle Data Guard Concepts and Administration* to learn how to manage archived redo logs in a Data Guard environment
 - *Oracle Database Backup and Recovery Reference* for a complete explanation of the `CONFIGURE ARCHIVELOG DELETION POLICY` command and the conditions under which archived logs are eligible for deletion
-
-

5.8 Configuring RMAN in a Data Guard Environment

If you use RMAN in a Data Guard environment, then you can use the `CONFIGURE` command to register and configure settings for the physical databases in this environment.

RMAN uses the `DB_UNIQUE_NAME` initialization parameter to distinguish one database from another. Thus, it is critical that you maintain the uniqueness of the `DB_UNIQUE_NAME` in the Data Guard environment.

RMAN must be connected to a recovery catalog when you create or alter a configuration for a database in the Data Guard environment. If you use the `SET DBID` command to set the `DBID` in the [RMAN session](#), then you can configure a standby database even when RMAN is not connected as `TARGET` to a database in the Data

Guard environment. You can even create a configuration for a standby database that has not yet been created.

You can use the following forms of the `CONFIGURE` command:

- `CONFIGURE DB_UNIQUE_NAME` defines a connection to a [physical standby database](#) and implicitly registers the new database.

New standby databases are also automatically registered when RMAN connects as `TARGET` to a standby database for the first time.

- `CONFIGURE FOR DB_UNIQUE_NAME` configures settings for a database in the Data Guard environment.

For example, you can configure channels, default devices, and so on for a specified database or for all databases in the environment. You can use `SHOW ALL FOR DB_UNIQUE_NAME` to show the configuration for a specific standby database or `SHOW ALL FOR DB_UNIQUE_NAME ALL` to show configurations for all known databases.

A Data Guard environment involves many considerations that are only relevant for Data Guard. For example, you can configure an [archived redo log deletion policy](#) based on whether archived logs are transferred to or applied on a standby database.

See Also:

- *Oracle Data Guard Concepts and Administration* to learn how to configure the RMAN environment for use with a standby database
 - *Oracle Database Backup and Recovery Reference* for a complete explanation of the `CONFIGURE ARCHIVELOG DELETION POLICY` command and the conditions under which archived logs are eligible for deletion
-
-

Configuring the RMAN Environment: Advanced Topics

This chapter describes how to perform setup and configuration tasks. This chapter contains the following topics:

- [Configuring Advanced Channel Options](#) (page 6-1)
- [Configuring Advanced Backup Options](#) (page 6-4)
- [Configuring Auxiliary Instance Data File Names](#) (page 6-13)
- [Configuring the Snapshot Control File Location](#) (page 6-14)
- [Configuring RMAN for Use with a Shared Server](#) (page 6-15)
- [Enabling Lost Write Detection](#) (page 6-16)

6.1 Configuring Advanced Channel Options

The `CONFIGURE CHANNEL` command is used to configure RMAN channel options.

This section contains the following topics about advanced channel option:

- [About Channel Control Options](#) (page 6-1)
- [Configuring Specific Channel Parameters](#) (page 6-2)

See Also:

- [About RMAN Channels](#) (page 3-3) for a conceptual overview of configured and allocated channels
 - [Configuring Channels](#) (page 5-5) the basics for configuring channels
 - *Oracle Database Backup and Recovery Reference* for `CONFIGURE` syntax
-

6.1.1 About Channel Control Options

Whether you allocate channels manually or use automatic channel allocation, you can use channel commands and options to control behavior.

[Table 6-1](#) (page 6-2) summarizes the ways in which you can control channel behavior. Unless noted, all channel parameters are supported in both `CONFIGURE CHANNEL` and `ALLOCATE CHANNEL` commands.

Table 6-1 Channel Control Options

Type of Channel Control	Commands
Limit I/O bandwidth consumption	Use the RATE channel parameter to act as a throttling mechanism for backups.
Limit backup sets and pieces	Use the MAXPIECESIZE channel parameter to set limits on the size of backup pieces. You can also use the MAXSETSIZE parameter on the BACKUP and CONFIGURE commands to set a limit for the size of backup sets.
Vendor-specific instructions	Use the PARMS channel parameter to specify vendor-specific information for a media management software . You can also use the SEND command to send vendor-specific commands to a media manager.
Channel parallel backup and restore operations	Use CONFIGURE DEVICE TYPE . . . PARALLELISM for persistent channel parallelism or multiple ALLOCATE CHANNEL commands for job-level parallelism.
Connection settings for database instances	Specify which instance performs an operation with the CONNECT channel parameter.

See Also:

- *Oracle Database Backup and Recovery Reference* for ALLOCATE CHANNEL syntax
- *Oracle Database Backup and Recovery Reference* for CONFIGURE syntax

6.1.2 Configuring Specific Channel Parameters

In addition to configuring parameters that apply to all channels of a particular type, you can also use the CONFIGURE command to configure parameters that apply to one specific channel.

Configure specific channels by number when it is necessary to control the parameters set for each channel separately. This technique is necessary in the following situations:

- When running an Oracle Real Application Clusters (Oracle RAC) database in which individual nodes do not have access to the full set of backups. Each channel must be configured with a node-specific connect string so that all backups are accessible by at least one channel.
- When using a media manager that requires different PARMS settings on each channel.

To configure specific channel parameters:

- Run the CONFIGURE CHANNEL *n* command (where *n* is a positive integer less than 255) to configure a specific channel.

When manually numbering channels, you must specify one or more channel options (for example, MAXPIECESIZE or FORMAT) for each channel. When you

use that specific numbered channel in a backup, the configured settings for that channel are used instead of the configured generic channel settings.

See Also:

Oracle Real Application Clusters Administration and Deployment Guide to learn about RMAN backups in an Oracle RAC environment

6.1.2.1 Configuring Specific Channels: Examples

Example 6-1 Configuring Channel Parallelism for Disk Devices

This example sends disk backups to two different disks. Configure disk channels as follows:

```
CONFIGURE DEFAULT DEVICE TYPE TO disk;          # backup goes to disk
CONFIGURE DEVICE TYPE disk PARALLELISM 2;      # two channels used in parallel
CONFIGURE CHANNEL 1 DEVICE TYPE DISK FORMAT '/disk1/%U' # 1st channel to disk1
CONFIGURE CHANNEL 2 DEVICE TYPE DISK FORMAT '/disk2/%U' # 2nd channel to disk2
BACKUP DATABASE; # backup - first channel goes to disk1 and second to disk2
```

Example 6-2 Configuring Channel Parallelism for Tape Devices

This example configures channels to create parallel database backups. You have two tape drives and want each drive to use tapes from a different tape media family. The backup data is divided between the two tape devices. Each configured channel backs up approximately half the total data.

```
CONFIGURE DEFAULT DEVICE TYPE TO sbt;          # backup goes to sbt
CONFIGURE DEVICE TYPE sbt PARALLELISM 2;      # two sbt channels allocated by default
# Configure channel 1 to pool named first_pool
CONFIGURE CHANNEL 1 DEVICE TYPE sbt
  PARMS 'ENV=(OB_MEDIA_FAMILY=first_pool)';
# configure channel 2 to pool named second_pool
CONFIGURE CHANNEL 2 DEVICE TYPE sbt
  PARMS 'ENV=(OB_MEDIA_FAMILY=second_pool)';
BACKUP DATABASE; # first stream goes to 'first_pool' and second to 'second_pool'
```

6.1.2.2 Relationship Between CONFIGURE CHANNEL and Parallelism Setting

The PARALLELISM setting is not constrained by the number of specifically configured channels.

For example, if you back up to 20 different tape devices, then you can configure 20 different SBT channels, each with a manually assigned number (from 1 to 20) and each with a different set of channel options. In such a situation, you can set PARALLELISM to any value up to the number of devices, in this instance 20.

RMAN always numbers parallel channels starting with 1 and ending with the PARALLELISM setting. For example, if the default device is SBT and parallelism is set to 3, then RMAN names the channels as follows:

```
ORA_SBT_TAPE_1
ORA_SBT_TAPE_2
ORA_SBT_TAPE_3
```

RMAN always uses the name `ORA_SBT_TAPE_n` even if you configure `DEVICE TYPE sbt` (not the synonymous `sbt_tape`). RMAN always allocates the number of channels specified in PARALLELISM, using specifically configured channels if you have configured them and generic channels if you have not. If you configure specific

channels with numbers higher than the parallelism setting, then this setting prevents RMAN from using them.

See Also:

[About RMAN Channels](#) (page 3-3) to learn about channels

6.2 Configuring Advanced Backup Options

Backup options enable you to control aspects such as backup size, backup compression, and backup encryption.

"[About Configuring the Environment for RMAN Backups](#) (page 5-1)" explains the basics for configuring RMAN to make backups. This section explains more advanced configuration options. This section contains the following topics:

- [Configuring the Maximum Size of Backup Sets](#) (page 6-4)
- [Configuring the Maximum Size of Backup Pieces](#) (page 6-5)
- [Configuring Backup Duplexing](#) (page 6-5)
- [Configuring Tablespaces for Exclusion from Whole Database Backups](#) (page 6-6)
- [Configuring Compression Options](#) (page 6-7)
- [Configuring Backup Encryption](#) (page 6-9)

6.2.1 Configuring the Maximum Size of Backup Sets

The `CONFIGURE MAXSETSIZE` command limits the size of backup sets created on a channel. This `CONFIGURE` setting applies to any channel, whether manually allocated or configured, when the `BACKUP` command is used to create backup sets. The default value is given in bytes and is rounded down to the lowest kilobyte value.

In tape backups, it is possible for a [multiplexed backup set](#) to span multiple tapes, which means that blocks from each data file in the backup set are written to multiple tapes. If one tape of a multivolume backup set fails, then you lose the data on all the tapes rather than just one. If a backup is not a [multisection backup](#), then a backup set always includes a whole data file rather than a partial data file. You can use `MAXSETSIZE` to specify that each backup set fits on one tape rather than spanning multiple tapes.

The value set by the `CONFIGURE MAXSETSIZE` command is a default for the given channel. You can override the configured `MAXSETSIZE` value by specifying a `MAXSETSIZE` option for an individual `BACKUP` command.

Assume that you issue the following commands at the RMAN prompt:

```
CONFIGURE DEFAULT DEVICE TYPE TO sbt;
CONFIGURE CHANNEL DEVICE TYPE sbt PARMS 'ENV=(OB_MEDIA_FAMILY=first_pool)';
CONFIGURE MAXSETSIZE TO 7500K;
BACKUP TABLESPACE users;
BACKUP TABLESPACE tools MAXSETSIZE 5G;
```

The results are as follows:

- The backup of the `users` tablespace uses the configured [SBT](#) channel and the configured default `MAXSETSIZE` setting of 7500K.
- The backup of the `tools` tablespace uses the `MAXSETSIZE` setting of 5G specified in the `BACKUP` command.

See Also:

- [Limiting the Size of Backup Sets with BACKUP ... MAXSETSIZE](#) (page 10-2)
 - *Oracle Database Backup and Recovery Reference* for `BACKUP` syntax
-
-

6.2.2 Configuring the Maximum Size of Backup Pieces

Backup piece size is an issue when it exceeds the maximum file size permitted by the file system or media management software. You can use the `MAXPIECESIZE` parameter of the `CONFIGURE CHANNEL` or `ALLOCATE CHANNEL` command to limit the size of backup pieces.

For example, to limit the backup piece size to 2 gigabytes or less, you can configure the automatic `DISK` channel as follows and then run `BACKUP DATABASE`:

```
CONFIGURE CHANNEL DEVICE TYPE DISK MAXPIECESIZE 2G;
BACKUP DATABASE;
```

Note:

In version 2.0 of the media management API, media management vendors can specify the maximum size of a backup piece that can be written to their media manager. `RMAN` respects this limit regardless of the settings that you configure for `MAXPIECESIZE`.

See Also:

Oracle Database Backup and Recovery Reference to learn about the `CONFIGURE CHANNEL ... MAXPIECESIZE` command

6.2.3 Configuring Backup Duplexing

Use the `CONFIGURE ... BACKUP COPIES` command to specify how many copies of each backup piece are created on the specified device type for the specified type of file. This type of backup is known as a duplexed backup set.

`RMAN` can duplex backups to either disk or tape, but cannot duplex backups to tape and disk simultaneously. When backing up to tape, ensure that the number of copies does not exceed the number of available tape devices. The `CONFIGURE` settings for duplexing only affect backups of data files, control files, and archived logs into backup sets, and do not affect image copies.

Note:

A [control file autobackup](#) is *never* duplexed.

By default, `CONFIGURE . . . BACKUP COPIES` is set to 1 for each device type.

The following examples show possible duplexing configurations:

```
# Makes 2 disk copies of each data file and control file backup set
# (autobackups excluded)
CONFIGURE DATAFILE BACKUP COPIES FOR DEVICE TYPE DISK TO 2;
# Makes 3 copies of every archived redo log backup to tape
CONFIGURE ARCHIVELOG BACKUP COPIES FOR DEVICE TYPE sbt TO 3;
```

To return a `BACKUP COPIES` configuration to its default value, run the same `CONFIGURE` command with the `CLEAR` option, as in the following example:

```
CONFIGURE DATAFILE BACKUP COPIES FOR DEVICE TYPE sbt CLEAR;
```

Note:

If you do not want to create a persistent copies configuration, then you can specify copies with the `BACKUP COPIES` and the `SET BACKUP COPIES` commands.

See Also:

- [About Multiple Copies of RMAN Backups](#) (page 8-13) for an overview of duplexed backups
 - [Duplexing Backup Sets](#) (page 10-7) to learn how to create duplexed backups
 - *Oracle Database Backup and Recovery Reference* for `BACKUP` syntax
 - *Oracle Database Backup and Recovery Reference* for `CONFIGURE` syntax
 - *Oracle Database Backup and Recovery Reference* for `SET` syntax
-

6.2.4 Configuring Tablespaces for Exclusion from Whole Database Backups

Sometimes you may want to omit a specified tablespace from part of the regular backup schedule. Use the `CONFIGURE` command to configure tablespace exclusion.

Here are some possible scenarios to consider:

- A tablespace is easy to rebuild, so it is more cost-effective to rebuild it than back it up every day.
- A tablespace contains temporary or test data that you do not need to back up.
- A tablespace does not change often and therefore should be backed up on a different schedule from other backups.

You can run `CONFIGURE EXCLUDE FOR TABLESPACE` to exclude the specified tablespace from the `BACKUP DATABASE` command. The exclusion condition applies to any data files that you add to this tablespace in the future.

For example, you can exclude testing tablespaces `cwmlite` and `example` from whole database backups as follows:

```
CONFIGURE EXCLUDE FOR TABLESPACE cwmlite;
CONFIGURE EXCLUDE FOR TABLESPACE example;
```

If you run the following command, then RMAN backs up all tablespaces in the database except `cwmlite` and `example`:

```
BACKUP DATABASE;
```

You can still back up the configured tablespaces by explicitly specifying them in a `BACKUP` command or by specifying the `NOEXCLUDE` option on a `BACKUP DATABASE` command. For example, you can enter one of the following commands:

```
BACKUP DATABASE NOEXCLUDE; #backs up database, including cwmlite and example
BACKUP TABLESPACE cwmlite, example; # backs up only cwmlite and example
```

You can disable the exclusion feature for `cwmlite` and `example` as follows:

```
CONFIGURE EXCLUDE FOR TABLESPACE cwmlite CLEAR;
CONFIGURE EXCLUDE FOR TABLESPACE example CLEAR;
```

RMAN includes these tablespaces in future whole database backups.

See Also:

- *Oracle Database Backup and Recovery Reference* for `BACKUP` and `CONFIGURE` syntax
-

6.2.5 Configuring Compression Options

RMAN supports precompression processing and binary compression of backup sets. The `CONFIGURE COMPRESSION ALGORITHM` command enables you to configure compression options.

This following topics contain additional information about compression:

- [About RMAN Precompression Block Processing](#) (page 6-7)
- [About RMAN Supported Compression Levels](#) (page 6-8)

6.2.5.1 About RMAN Precompression Block Processing

Better backup compression ratios are achieved by consolidating the free space in each data block, and setting that free space to binary zeroes. This precompression processing stage has the most benefit for data blocks that have been the subject of many deletes and inserts operations. Conversely, it has no effect on data blocks that are still in their initial loaded state.

The `OPTIMIZE FOR LOAD` option controls precompression processing. By specifying the default, `OPTIMIZE FOR LOAD TRUE`, you ensure that RMAN optimizes CPU usage and avoids precompression block processing. By specifying `OPTIMIZE FOR LOAD FALSE`, RMAN uses additional CPU resources to perform precompression block processing.

See Also:

- *Oracle Database Backup and Recovery Reference* for CONFIGURE and SET syntax

6.2.5.2 About RMAN Supported Compression Levels

Oracle Database provides two categories of compression algorithms: a default compression algorithm and a group of compression algorithms available with the Oracle Advanced Compression option.

The default algorithm is a standard feature of Oracle Database while the Oracle Advanced Compression option is a separately purchased option.

See Also:

- [About RMAN Default Compression](#) (page 6-8)
- [About Oracle Advanced Compression Option](#) (page 6-8)

6.2.5.2.1 About RMAN Default Compression

Use the CONFIGURE command to configure the default compression algorithm, which does not require the Oracle Advanced Compression option.

Example 6-3 Configuring Basic Compression for Backup

The following example configures basic compression for RMAN backups..

```
CONFIGURE COMPRESSION ALGORITHM 'BASIC' ;
```

6.2.5.2.2 About Oracle Advanced Compression Option

If you have enabled the Oracle Advanced Compression option, you can choose from the compression levels listed in the following table.

Compression Level	Performance Benefits and Trade-Offs
HIGH	Best suited for backups over slower networks where the limiting factor is network speed.
MEDIUM	Recommended for most environments. Good combination of compression ratios and speed.
LOW	Least effect on backup throughput.

The compression ratio generally increases from low to high, with a trade-off of potentially consuming more CPU resources.

Because the performance of the various compression levels depends on the nature of the data in the database, network configuration, system resources and the type of computer system and its capabilities, Oracle cannot document universally applicable performance statistics. Which level is best for your environment depends on how balanced your system is regarding bandwidth into the CPU and the actual speed of the CPU. It is highly recommended that you run tests with the different compression levels on the data in your environment. Choosing a compression level based on your environment, network traffic characteristics (workload), and data set is the only way

to ensure that the backup set compression level can satisfy your organization's performance requirements and applicable service level agreements.

Note:

Restoring a compressed backup is performed inline, and does not require decompression.

See Also:

- See *Oracle Database Licensing Information* for more information about the Oracle Advanced Compression option.
 - If you are backing up to tape and your tape device performs its own compression, then do not use both RMAN backup set compression and the media manager vendor's compression. See the discussion of tuning RMAN's tape backup performance in [Tuning RMAN Performance](#) (page 23-1).
-

6.2.6 Configuring Backup Encryption

For improved security, you can configure backup encryption for RMAN backup sets. Encrypted backups cannot be read if they are obtained by unauthorized users.

This section contains the following topics:

- [About Backup Encryption](#) (page 6-9)
- [Configuring RMAN Backup Encryption Modes](#) (page 6-12)
- [Configuring the Backup Encryption Algorithm](#) (page 6-13)

6.2.6.1 About Backup Encryption

The `V$RMAN_ENCRYPTION_ALGORITHMS` view contains a list of encryption algorithms supported by RMAN. If no encryption algorithm is specified, then the default encryption algorithm is 128-bit Advanced Encryption Standard (AES).

RMAN encryption requires the `COMPATIBLE` initialization parameter at a target database to be at least 10.2.0.

The [Oracle Secure Backup media management software](#) is the only supported interface for making encrypted RMAN backups directly to tape. RMAN issues an `ORA-19919` error if you attempt to create encrypted RMAN backups using a media manager other than Oracle Secure Backup.

When you use the `BACKUP BACKUPSET` command with encrypted backup sets, the backup sets are backed up in encrypted form. Because `BACKUP BACKUPSET` copies an already-encrypted backup set to disk or tape, no decryption key is needed during `BACKUP BACKUPSET`. The data is never decrypted during any part of the operation. The `BACKUP BACKUPSET` command can neither encrypt nor decrypt backup sets.

Encrypted backups are decrypted automatically during restore and recovery, if the required decryption keys are available. Each backup set gets a separate key. The key is stored in encrypted form in the backup piece. The backup is decrypted with keys obtained by a user-supplied password or the Oracle software keystore.

RMAN Encryption Modes

RMAN offers the following encryption modes:

- **Transparent encryption**
This is the default mode and uses the Oracle software keystore. A keystore is a password-protected container used to store a Transparent Data Encryption (TDE) key. In previous releases, this container was referred to as a wallet.
- **Password encryption**
This mode uses only password protection. You must provide a password when creating and restoring encrypted backups.
- **Dual mode encryption**
This mode requires either the keystore or a password.

Note:

Keystore-based encryption is more secure than password-based encryption because no passwords are involved. Use password-based encryption only when it is absolutely necessary because your backups must be transportable.

See Also:

- [Transparent Encryption of Backups](#) (page 6-10)
 - [Password Encryption of Backups](#) (page 6-11)
 - [Dual Mode Encryption of Backups](#) (page 6-12)
 - *Oracle Database Advanced Security Guide* for details about configuring the Oracle keystore
-
-

6.2.6.1.1 Transparent Encryption of Backups

Transparent encryption can create and restore encrypted backups with no DBA intervention, if the required Oracle key management infrastructure is available.

Transparent encryption is best suited for day-to-day backup operations, where backups are restored to the same database from which they were created. Transparent encryption is the default for RMAN encryption.

When you use transparent encryption, you must first configure an Oracle software keystore for each database. Transparent backup encryption supports both the auto-login software keystore and password-based software keystore. When you use the auto-login software keystore, encrypted backup operations can be performed at any time, because the auto-login keystore is always open. When you use the password-based software keystore, the keystore must be opened before you can perform backup encryption.

Caution:

If you use an auto-login keystore, do not back it up along with your encrypted backup data, because users can read the encrypted backups if they obtain both the backups and the autologin keystore. It is safe to back up the Oracle keystore because that form of the keystore cannot be used without the keystore password.

After the Oracle keystore is configured, encrypted backups can be created and restored with no further DBA intervention. If some columns in the database are encrypted with Transparent Data Encryption (TDE) column encryption, and if those columns are backed up using backup encryption, then those columns are encrypted a second time during the backup. When the backup sets are decrypted during a restore operation, the encrypted columns are returned to their original encrypted form.

Because the Oracle key management infrastructure archives all previous master keys in the Oracle keystore, changing or resetting the current database master key does not affect your ability to restore encrypted backups performed with an older master key. You can reset the database master key at any time. RMAN can restore all encrypted backups that were ever created by this database.

Caution:

If you lose your Oracle keystore, then you are unable to restore any transparently encrypted backups.

Note:

Oracle Database Advanced Security Guide for information about configuring an Oracle software keystore

6.2.6.1.2 Password Encryption of Backups

Password encryption requires that the DBA provide a password when creating and restoring encrypted backups. Restoring a password-encrypted backup requires the same password that was used to create the backup.

Password encryption is useful for backups that are restored at remote locations, but which must remain secure in transit. Password encryption cannot be persistently configured. You do not need to configure an Oracle keystore if password encryption is used exclusively.

Caution:

If you forget or lose the password that you used to encrypt a password-encrypted backup, then you are unable to restore the backup.

To use password encryption, use the `SET ENCRYPTION ON IDENTIFIED BY password ONLY` command in your RMAN scripts.

6.2.6.1.3 Dual Mode Encryption of Backups

Dual-mode encrypted backups can be restored either transparently or by specifying a password.

Dual-mode encrypted backups are useful when you create backups that are normally restored on-site using the Oracle keystore, but which occasionally must be restored offsite, where the Oracle keystore is not available.

When restoring a dual-mode encrypted backup, you can use either the Oracle keystore or a password for decryption.

Caution:

If you forget or lose the password that you used to encrypt a dual-mode encrypted backup and you also lose your Oracle keystore, then you are unable to restore the backup.

To create dual-mode encrypted backup sets, specify the `SET ENCRYPTION ON IDENTIFIED BY password` command in your RMAN scripts.

6.2.6.2 Configuring RMAN Backup Encryption Modes

You can use the `CONFIGURE` command to persistently configure transparent encryption of backups.

You can use the command to specify the following:

- Whether to use transparent encryptions for backups of all database files
- Whether to use transparent encryptions for backups of specific tablespaces
- Which algorithm to use for encrypting backups

You can also use the `SET ENCRYPTION` command to perform the following actions:

- Override the encryption settings specified by the `CONFIGURE ENCRYPTION` command. For example, you can use `SET ENCRYPTION OFF` to create an unencrypted backup, even though a database is configured for encrypted backups.
- Set a password for backup encryption, persisting until the RMAN client exits. Because of the sensitive nature of passwords, RMAN does not permit configuration of passwords that persist across RMAN sessions.

Using or not using persistent configuration settings controls whether archived redo log backups are encrypted. Backup sets containing archived redo log files are encrypted if any of the following are true:

- `SET ENCRYPTION ON` is in effect when the archive log backup is being created.
- Encryption is configured for backups of the whole database or at least one tablespace.

This behavior ensures that the redo associated with any encrypted backup of a data file is also encrypted.

To configure the environment so that all RMAN backups are encrypted:

1. Set up the Oracle keystore as explained in *Oracle Database Advanced Security Guide*.
2. Issue the following RMAN command:

```
CONFIGURE ENCRYPTION FOR DATABASE ON;
```

At this stage, all RMAN backup sets created by this database use transparent encryption by default.

You can explicitly override the persistent encryption configuration for an [RMAN session](#) with the following command:

```
SET ENCRYPTION ON;
```

The encryption setting remains in effect until you issue the `SET ENCRYPTION OFF` command during an RMAN session, or change the persistent setting again with the following command:

```
CONFIGURE ENCRYPTION FOR DATABASE OFF;
```

6.2.6.3 Configuring the Backup Encryption Algorithm

You can use the `CONFIGURE` command to persistently configure the default algorithm to use for encryption when writing backup sets.

Possible values are listed in `V$RMAN_ENCRYPTION_ALGORITHMS`. The default algorithm is AES 128-bit.

To configure the default backup encryption algorithm:

1. Start RMAN and connect to a target database and a recovery catalog (if used).
2. Ensure that the target database is mounted or open.
3. Execute the `CONFIGURE ENCRYPTION ALGORITHM` command, specifying a valid value from `V$RMAN_ENCRYPTION_ALGORITHMS.ALGORITHM_NAME`.

The following example configures the algorithm to AES 256-bit encryption:

```
CONFIGURE ENCRYPTION ALGORITHM TO 'AES256';
```

6.3 Configuring Auxiliary Instance Data File Names

You may want to set the names of data files in the auxiliary instance when performing operations such as data file tablespace point-in-time recovery (TSPITR) or data transfer with RMAN. You set these names before starting the TSPITR or database duplication.

The command is as follows, where *datafileSpec* identifies some data file by its original name or data file number, and *filename* is the new path for the specified file:

```
CONFIGURE AUXNAME FOR datafileSpec TO 'filename';
```

For example, you might configure a new auxiliary name for data file 2 as follows:

```
CONFIGURE AUXNAME FOR DATAFILE 2 TO '/newdisk/datafiles/df2.df';
```

As with other settings, the `CONFIGURE` command setting persists across RMAN sessions until cleared with `CONFIGURE . . . CLEAR`, as shown in the following example:

```
CONFIGURE AUXNAME FOR DATAFILE 2 CLEAR;
```

If you are performing TSPITR or running the `DUPLICATE` command, then by using `CONFIGURE AUXNAME` you can preconfigure the file names for use on the auxiliary database without manually specifying the auxiliary file names during the procedure.

When renaming files with the `DUPLICATE` command, `CONFIGURE AUXNAME` is an alternative to `SET NEWNAME` command. The difference is that after you set the `AUXNAME` the first time, you do not need to reset the file name when you issue another `DUPLICATE` command; the `AUXNAME` setting remains in effect until you issue `CONFIGURE AUXNAME . . . CLEAR`. In contrast, you must reissue the `SET NEWNAME` command every time you rename files.

See Also:

- [Performing RMAN Tablespace Point-in-Time Recovery \(TSPITR\)](#) (page 21-1) for more details on using `CONFIGURE AUXNAME` for TSPITR
 - [Duplicating Databases](#) (page 25-1) for more details on using `CONFIGURE AUXNAME` in performing database duplication
-

6.4 Configuring the Snapshot Control File Location

When RMAN needs a read-consistent version of the control file, it creates a temporary snapshot control file. RMAN needs a snapshot control file when resynchronizing with the recovery catalog or when making a backup of the current control file.

The default location for the snapshot control file is platform-specific and depends on the Oracle home of each target database. For example, the default file name on some Linux platforms is `$ORACLE_HOME/dbs/snapcf_@.f`. If a [fast recovery area](#) is configured for a target database, then the default location for the snapshot control file is *not* the fast recovery area.

This section contains the following topics:

- [Viewing the Configured Location of the Snapshot Control File](#) (page 6-14)
- [Setting the Location of the Snapshot Control File](#) (page 6-15)

6.4.1 Viewing the Configured Location of the Snapshot Control File

You can see the current snapshot location by running the `SHOW` command.

This example shows a snapshot location that is determined by the default rule:

```
RMAN> SHOW SNAPSHOT CONTROLFILE NAME;  
CONFIGURE SNAPSHOT CONTROLFILE NAME TO '/oracle/dbs/snapcf_trgt.f'; # default
```

This example shows a snapshot control file that has a nondefault file name:

```
RMAN> SHOW SNAPSHOT CONTROLFILE NAME;  
CONFIGURE SNAPSHOT CONTROLFILE NAME TO '/oracle/oradata/trgt/snap_trgt.ctl';
```

6.4.2 Setting the Location of the Snapshot Control File

Use the `CONFIGURE SNAPSHOT CONTROLFILE NAME TO 'filepath'` command to change the name and path of the snapshot control file. Subsequent snapshot control files that RMAN creates use the specified name and path.

In an Oracle Real Application Clusters (Oracle RAC) environment, the snapshot control file location must be on shared storage—that is, storage that is accessible to all Oracle RAC instances.

For example, start RMAN, connect to the target database, and then enter:

```
CONFIGURE SNAPSHOT CONTROLFILE NAME TO '/oracle/oradata/trgt/snap_trgt.ctl';
```

You can also set the snapshot control file name to a [raw device](#).

To reset the snapshot control file location to the default, run the `CONFIGURE SNAPSHOT CONTROLFILE NAME CLEAR` command.

See Also:

- [Resynchronizing the Recovery Catalog](#) (page 13-27)
 - *Oracle Real Application Clusters Administration and Deployment Guide* for details about handling snapshot control files in Oracle RAC configurations
-
-

6.5 Configuring RMAN for Use with a Shared Server

RMAN cannot connect to a target database through a shared server dispatcher. RMAN requires a dedicated server process.

If your target database is configured for a shared server, then you must modify your Oracle Net configuration to provide dedicated server processes for RMAN connections.

To ensure that RMAN does not connect to a dispatcher when a target database is configured for a shared server, the net service name used by RMAN must include `(SERVER=DEDICATED)` in the `CONNECT_DATA` attribute of the connect string.

Oracle Net configuration varies greatly from system to system. The following procedure illustrates only one method. This scenario assumes that the following service name in `tnsnames.ora` file connects to a target database using the shared server architecture, where `inst1` is a value of the `SERVICE_NAMES` initialization parameter:

```
inst1_shs =
  (DESCRIPTION=
    (ADDRESS=(PROTOCOL=tcp)(HOST=inst1_host)(port=1521))
    (CONNECT_DATA=(SERVICE_NAME=inst1)(SERVER=shared))
  )
```

To use RMAN with a shared server:

1. Create a net service name in the `tnsnames.ora` file that connects to the nonshared SID. For example, enter:

```

inst1_ded =
  (DESCRIPTION=
    (ADDRESS=(PROTOCOL=tcp)(HOST=inst1_host)(port=1521))
    (CONNECT_DATA=(SERVICE_NAME=inst1)(SERVER=dedicated))
  )

```

2. Start SQL*Plus and then connect using both the shared server and dedicated server service names to confirm the mode of each session.

For example, connect with SYSBACKUP or SYSDBA privilege to `inst1_ded` and then execute the following SELECT statement (sample output included):

```

SQL> SELECT SERVER
      2 FROM   V$SESSION
      3 WHERE  SID = (SELECT DISTINCT SID FROM V$MYSTAT);

```

```

SERVER
-----
DEDICATED
1 row selected.

```

To connect to a shared server session, connect with SYSBACKUP or SYSDBA privilege to `inst1_shs` and then execute the following SELECT statement (sample output included):

```

SQL> SELECT SERVER
      2 FROM   V$SESSION
      3 WHERE  SID = (SELECT DISTINCT SID FROM V$MYSTAT);

```

```

SERVER
-----
SHARED
1 row selected.

```

3. Start RMAN and connect to the target database using the dedicated service name. Optionally, connect to a recovery catalog.

See Also:

Your platform-specific Oracle documentation and the *Oracle Database Net Services Reference* for a complete description of Oracle Net connect string syntax

6.6 Enabling Lost Write Detection

A data block lost write occurs when an I/O subsystem acknowledges the completion of the block write, but the write did not occur in the persistent storage. On a subsequent block read, the I/O subsystem returns the stale version of the data block, which might be used to update other blocks of the database, thereby corrupting it.

You can set the `DB_LOST_WRITE_PROTECT` initialization parameter to `TYPICAL` or `FULL` so that a database records buffer cache block reads in the redo log. The default setting is `NONE`. When the parameter is set to `TYPICAL`, the instance logs buffer cache reads for read/write tablespaces in the redo log, but not read-only tablespaces. When set to `FULL`, the instance also records reads for read-only tablespaces. The performance overhead for `TYPICAL` mode is approximately 5 to 10% and potentially higher for `FULL` mode.

Lost write detection is most effective when used with Data Guard. In this case, you set `DB_LOST_WRITE_PROTECT` in both primary and standby databases. When a standby database applies redo during managed recovery, it reads the corresponding blocks and compares the SCNs with the SCNs in the redo log. If the block SCN on the primary database is lower than on the standby database, then it detects a lost write on the primary database and throws an external error (ORA-752). If the SCN is higher, it detects a lost write on the standby database and throws an internal error (ORA-600 [3020]). In either case, the standby database writes the reason for the failure in the alert log and trace file.

To repair a lost write on a primary database, you must initiate failover to the standby database. To repair a lost write on a standby database, you must re-create the entire standby database or restore a backup of only the affected files.

Enabling lost write detection is also useful when you are not using Data Guard. In this case, you can encounter a lost write in two ways: during normal database operation or during media recovery. In the first case, there is no direct way to detect the error. Indirect symptoms such as inconsistent tables cannot be unambiguously traced to the lost write. If you retained a backup made *before* the suspected lost write, however, then you can restore this backup to an alternative location and recover it. To diagnose the problem, recover the database or tablespace to the SCN of the stale block read, which then generates the lost write error (ORA-752).

If a lost write error is encountered during media recovery, the only response is to open the database with the `RESETLOGS` option. The database is in a consistent state, but all data after the `RESETLOGS` SCN is lost. If you recover a backup made after database creation, you have no guarantee that other stale blocks have not corrupted the database. This possibility exists because the restored backup may have been made after an earlier lost write. To guarantee that no lost writes have corrupted the database, you must perform media recovery from database creation, which is not a practical strategy for most database environments.

See Also:

- *Oracle Data Guard Concepts and Administration* to learn how to use a standby database for lost write detection and repair
 - *Oracle Database Reference* to learn about the `DB_LOST_WRITE_PROTECT` initialization parameter
-
-

Using Flashback Database and Restore Points

This chapter explains Flashback Database and restore points. It discusses configuring, monitoring, and maintaining these features as part of an overall data protection strategy.

This chapter contains the following topics:

- [Overview of Flashback Database, Restore Points and Guaranteed Restore Points](#) (page 7-1)
- [About Logging for Flashback Database and Guaranteed Restore Points](#) (page 7-8)
- [Prerequisites for Flashback Database and Guaranteed Restore Points](#) (page 7-10)
- [Using Normal and Guaranteed Restore Points](#) (page 7-11)
- [Using Flashback Database](#) (page 7-17)

Note:

Detailed information on recovery scenarios that use Flashback Database and normal and guaranteed restore points can be found in [Performing Flashback and Database Point-in-Time Recovery](#) (page 18-1).

7.1 Overview of Flashback Database, Restore Points and Guaranteed Restore Points

Oracle Flashback Database and restore points are related data protection features that enable you to rewind data back in time to correct any problems caused by logical data corruption or user errors within a designated time window.

These features provide a more efficient alternative to point-in-time recovery and does not require a backup of the database to be restored first. The effects are similar to [database point-in-time recovery \(DBPITR\)](#). Flashback Database and restore points are not only effective in traditional database recovery situations but can also be useful during database upgrades, application deployments and testing scenarios when test databases must be quickly created and re-created. Flashback Database also provides an efficient alternative to rebuilding a failed primary database after a Data Guard failover.

Restore points provide capabilities related to Flashback Database and other media recovery operations. In particular, a guaranteed restore point created at a system change number (SCN) ensures that you can use Flashback Database to rewind the

database to this SCN. You can use restore points and Flashback Database independently or together.

Flashback Database is accessible through both RMAN and SQL as `FLASHBACK DATABASE`. You can use either language to quickly recover the database from logical data corruption or user errors. The following examples return the database to a specified SCN or restore point:

```
FLASHBACK DATABASE TO RESTORE POINT 'before_upgrade';  
FLASHBACK DATABASE TO SCN 202381;
```

See Also:

Oracle Data Guard Concepts and Administration

7.1.1 About Flashback Database

Flashback Database is similar to conventional point-in-time recovery in its effects. It enables you to return a database to its state at a time in the recent past. Flashback Database is much faster than point-in-time recovery because it does not require restoring data files from backup and requires applying fewer changes from the archived redo logs.

You can use Flashback Database to reverse most unwanted changes to a database if the data files are intact. You can return a database to its state in a previous [incarnation](#), and undo the effects of an `ALTER DATABASE OPEN RESETLOGS` statement.

"[Rewinding a Database with Flashback Database](#) (page 18-15)" explains how to use the `FLASHBACK DATABASE` command to reverse database changes.

Flashback Database uses its own logging mechanism, creating [flashback logs](#) and storing them in the [fast recovery area](#). You can only use Flashback Database if flashback logs are available. To take advantage of this feature, you must set up your database in advance to create flashback logs.

To enable Flashback Database, you configure a fast recovery area and set a [flashback retention target](#). This retention target specifies how far back you can rewind a database with Flashback Database.

From that time onwards, at regular intervals, the database copies images of each altered block in every data file into the flashback logs. These block images can later be reused to reconstruct the data file contents for any moment at which logs were captured.

When you use Flashback Database to rewind a database to a past target time, the command determines which blocks changed after the target time and restores them from the flashback logs. The database restores the version of each block that is immediately before the target time. The database then uses redo logs to reapply changes that were made after these blocks were written to the flashback logs.

Redo logs on disk or tape must be available for the entire time period spanned by the flashback logs. For example, if the flashback retention target is 1 week, then you must ensure that online and archived redo logs that contain all changes for the past week are accessible. In practice, redo logs are typically needed much longer than the flashback retention target to support point-in-time recovery.

7.1.2 About Flashback Database Window

The range of SCNs for which there is currently enough flashback log data to support the `FLASHBACK DATABASE` command is called the flashback database window. The flashback database window cannot extend further back than the earliest SCN in the available flashback logs.

You cannot back up flashback logs to locations outside the fast recovery area. To increase the likelihood that enough flashback logs are retained to meet the flashback database window, you can increase the space in your fast recovery area (see "[Table 5-3](#) (page 5-22)").

If the fast recovery area is not large enough to hold the flashback logs and files such as archived redo logs and other backups needed for the retention policy, then the database may delete flashback logs from the earliest SCNs forward to make room for other files. Consequently, the flashback database window can be shorter than the flashback retention target, depending on the size of the fast recovery area, other backups that must be retained, and how much flashback logging data is needed. The flashback retention target is a target, not a guarantee that Flashback Database is available.

If you cannot use `FLASHBACK DATABASE` because the flashback database window is not long enough, then usually you can use database point-in-time recovery (DBPITR) to achieve a similar result. Guaranteed restore points are the only way to ensure that you can use Flashback Database to return to a specific point in time or guarantee the size of the flashback window.

Note:

Some database operations, such as dropping a tablespace or shrinking a data file, cannot be reversed with Flashback Database. See "[Limitations of Flashback Database](#) (page 7-3)" for details.

See Also:

- [Rewinding a Database with Flashback Database](#) (page 18-15) to learn about Flashback Database
 - [Performing Database Point-in-Time Recovery](#) (page 18-25) to learn about DBPITR
-
-

7.1.3 Limitations of Flashback Database

Because Flashback Database works by undoing changes to the data files that exist at the moment when you run the command, it has certain limitations.

Following are the limitations of Flashback Database:

- Flashback Database can only undo changes to a data file made by Oracle Database. It cannot be used to repair media failures, or to recover from accidental deletion of data files.

- You cannot use Flashback Database to undo a shrink data file operation. However, you can take the shrunken file offline, flash back the rest of the database, and then later restore and recover the shrunken data file.
- You cannot use Flashback Database alone to retrieve a dropped data file. If you flash back a database to a time when a dropped data file existed in the database, only the data file entry is added to the control file. You can only recover the dropped data file by using RMAN to fully restore and recover the data file.
- If the database control file is restored from backup or re-created, all accumulated flashback log information is discarded. You cannot use `FLASHBACK DATABASE` to return to a point in time before the restore or re-creation of a control file.
- When using Flashback Database with a target time at which a `NOLOGGING` operation was in progress, block corruption is likely in the database objects and data files affected by the `NOLOGGING` operation. For example, if you perform a direct-path `INSERT` operation in `NOLOGGING` mode, and that operation runs from 9:00 to 9:15 on April 3, 2005, and you later use Flashback Database to return to the target time 09:07 on that date, the objects and data files updated by the direct-path `INSERT` may be left with block corruption after the Flashback Database operation completes.

If possible, avoid using Flashback Database with a target time or SCN that coincides with a `NOLOGGING` operation. Also, perform a full or incremental backup of the affected data files immediately after any `NOLOGGING` operation to ensure recoverability to points in time after the operation. If you expect to use Flashback Database to return to a point in time during an operation such as a direct-path `INSERT`, consider performing the operation in `LOGGING` mode.

See Also:

Oracle Database SQL Language Reference for more information about operations that support `NOLOGGING` mode.

7.1.4 About Normal Restore Points

Creating a normal restore point assigns a restore point name to an SCN or specific point in time.

Thus, a restore point functions as a bookmark or alias for this SCN. Before performing any operation that you may have to reverse, you can create a normal restore point. The control file stores the name of the restore point and the SCN.

If you use flashback features or point-in-time recovery, then you can use the name of the restore point instead of a time or SCN. The following commands support this use of restore points:

- The `RECOVER DATABASE` and `FLASHBACK DATABASE` commands in RMAN
- The `FLASHBACK TABLE` statement in SQL

Creating a normal restore point eliminates manually recording an SCN in advance or determine the correct SCN after the fact by using features such as Flashback Query.

Normal restore points are lightweight. The control file can maintain a record of thousands of normal restore points with no significant effect on database performance. Normal restore points eventually age out of the control file if not manually deleted, so they require no ongoing maintenance.

See Also:

Oracle Database Development Guide to learn how to use Flashback Query

7.1.5 About Guaranteed Restore Points

Like a normal restore point, a guaranteed restore point serves as an alias for an SCN in recovery operations. A principal difference is that guaranteed restore points never age out of the control file and must be explicitly dropped.

In general, you can use a guaranteed restore point as an alias for an SCN with any command that works with a normal restore point. Except as noted, the information about where and how to use normal restore points applies to guaranteed restore points as well.

A guaranteed restore point ensures that you can use Flashback Database to rewind a database to its state at the restore point SCN, even if the generation of [flashback logs](#) is disabled. If flashback logging is enabled, then a guaranteed restore point enforces the retention of flashback logs required for Flashback Database to any SCN after the earliest guaranteed restore point. Thus, if flashback logging is enabled, you can rewind the database to any SCN in the continuum rather than to a single SCN only.

Note:

If flashback logging is disabled, then you *cannot* FLASHBACK DATABASE directly to SCNs between the guaranteed restore points and the current time. You can, however, flashback to the guaranteed restore point first and then recover to SCN's between the guaranteed restore point and current time.

If the recovery area has enough disk space to store the needed logs, then you can use a guaranteed restore point to rewind a whole database to a known good state days or weeks ago. As with Flashback Database, even the effects of NOLOGGING operations like direct load inserts can be reversed with guaranteed restore points.

Note:

Limitations that apply to Flashback Database also apply to guaranteed restore points. For example, shrinking a data file or dropping a tablespace can prevent flashing back the affected data files to the guaranteed restore point. See "[Limitations of Flashback Database](#) (page 7-3)" for details. In addition, when there are guaranteed restore points in the database, the database compatibility parameter cannot be set to a higher database version. An attempt to do so results in an error. This restriction exists because flashback database is currently unable to reverse the effects of increasing the database version with the compatibility initialization parameter.

7.1.5.1 Guaranteed Restore Points versus Storage Snapshots

In practice, guaranteed restore points provide a useful alternative to storage snapshots.

Storage snapshots are often used to protect a database before risky operations such as large-scale database updates or application patches or upgrades. Rather than creating a snapshot or [duplicate database](#) to test the operation, you can create a guaranteed

restore point on a primary or [physical standby database](#). You can then perform the risky operation with the certainty that the required flashback logs are retained.

7.1.6 Overview of Restore Points in a Multitenant Environment

You can create both normal and guaranteed restore points in a multitenant environment.

The basic concepts of restore points for databases are also applicable to restore points in a multitenant environment. You can create the following types of restore points in a multitenant environment:

- CDB restore point
- PDB restore point
- Clean PDB restore point

See Also:

- [Overview of Flashback Database, Restore Points and Guaranteed Restore Points](#) (page 7-1)
 - [About CDB Restore Points](#) (page 7-6)
 - [About Restore Points in PDBs](#) (page 7-7)
 - [About the Namespace for PDB Restore Points](#) (page 7-8)
-
-

7.1.6.1 About CDB Restore Points

A CDB restore point serves as an alias for an SCN or a point in time in a multitenant container database (CDB). It can be a normal restore point or a guaranteed restore point.

CDB restore points are similar to restore points in a non-CDB, except that you need to connect to the root as a common user with the `SYSDBA` or `SYSBACKUP` privilege to create them. You can create CDB restore points starting with Oracle Database 12c Release 1 (12.1). CDB restore points are accessible to every [pluggable database \(PDB\)](#) within the CDB. However, a CDB restore point does not reflect the PDB sub-incarnation of any of its PDBs.

CDB restore points are useful in the following scenarios:

- The whole CDB needs to be recovered to a particular point in time
- Multiple PDBs in a CDB need to be recovered to a particular point in time

See Also:

- [Overview of Restore Points in a Multitenant Environment](#) (page 7-6)
 - [About Restore Points in PDBs](#) (page 7-7)
 - [Basic Concepts of Performing Flashback Database for CDBs and PDBs](#) (page 18-4)
 - [Performing a Flashback Database Operation for a Whole CDB](#) (page 18-19)
-

7.1.6.2 About Restore Points in PDBs

You can create normal and guaranteed restore points in a pluggable database (PDB). PDB restore points are accessible only to the PDB in which they are defined.

PDB Restore Points

A PDB restore point is a bookmark to a point in time or an SCN in a particular [pluggable database \(PDB\)](#). It pertains only to the PDB for which it is created and is only usable for operations on that PDB. A PDB restore point represents the PDB sub-incarnation of the point in time at which it was created.

PDB restore points can be normal restore points or guaranteed restore points. A guaranteed PDB restore point guarantees that you can perform a flashback operation for the PDB to this restore point.

A PDB restore point can be used to perform Flashback Database operations or point-in-time recovery only for the PDB in which it was created.

Note: Creating a guaranteed PDB restore point requires careful consideration because such a restore point can prevent required flashback logs in the [multitenant container database \(CDB\)](#) from being reused. This can potentially impact CDB functioning because the fast recovery area could run out of space.

Clean PDB Restore Points

A clean PDB restore point is a PDB restore point that is created when the PDB is closed and when there are no outstanding transactions for that PDB. Clean PDB restore points are only applicable to CDBs that use shared undo.

Clean PDB restore points can be normal or guaranteed restore points. Use the `CREATE CLEAN RESTORE POINT` command to explicitly create a clean PDB restore point. For a CDB that uses shared undo, if a PDB is closed and it has no outstanding transactions, any PDB restore point created is marked as a clean PDB restore point.

If you anticipate that you may need to rewind a PDB to a particular point in time, for example, to a state just before an application upgrade, then it is recommended that you create a clean PDB guaranteed restore point.

For CDBs that use shared undo, a Flashback Database operation to a clean PDB restore point is faster than a Flashback Database operation to an SCN or other restore points that are not clean PDB restore points. This is because RMAN does not need to restore any backups while performing a flashback operation to a clean PDB restore point.

See Also:

- [About the Namespace for PDB Restore Points](#) (page 7-8)
 - [About CDB Restore Points](#) (page 7-6)
 - [Basic Concepts of Performing Flashback Database for CDBs and PDBs](#) (page 18-4)
 - [Performing a Flashback Database Operation for PDBs](#) (page 18-22)
 - [About Incarnations of PDBs](#) (page 14-10)
-
-

7.1.6.3 About the Namespace for PDB Restore Points

Each pluggable database (PDB) has its own namespace for restore points. Therefore, you can define a PDB restore point with the same name in more than one PDB.

In a multitenant environment, when you use a restore point name in a PDB or for a PDB operation, the name is first interpreted as a [PDB restore point](#) for the concerned PDB. If a PDB restore point with the specified name is not found, then it is interpreted as a [CDB restore point](#).

See Also:

[About Restore Points in PDBs](#) (page 7-7)

7.2 About Logging for Flashback Database and Guaranteed Restore Points

Logging for Flashback Database and guaranteed restore points involves capturing images of data file blocks before changes are applied. The `FLASHBACK DATABASE` command can use these images to return the data files to their previous state.

The chief differences between normal flashback logging and logging for guaranteed restore points are related to when blocks are logged and whether the logs can be deleted in response to space pressure in the fast recovery area. These differences affect space usage for logs and database performance.

Your recoverability goals partially determine whether to enable logging for flashback database, or use guaranteed restore points, or both. The implications in performance and in space usage for these features, separately and when used together, also factor into your decision.

7.2.1 Guaranteed Restore Points and Fast Recovery Area Space Usage

Certain rules govern the usage of space in the fast recovery area.

When you create a guaranteed restore point, with or without enabling full flashback database logging, you must monitor the space available in your fast recovery area. "[Managing Space for Flashback Logs in the Fast Recovery Area](#) (page 12-9)" explains how to monitor fast recovery area disk space usage.

The following rules govern creating, retaining, overwriting and deleting of flashback logs in the fast recovery area:

- If the fast recovery area has enough space, then a flashback log is created whenever necessary to satisfy the flashback retention target.
- If a flashback log is old enough that it is no longer needed to satisfy the flashback retention target, then a flashback log is reused.
- If the database must create a flashback log and the fast recovery area is full or there is no disk space, then the oldest flashback log is reused instead.

Note:

Reusing the oldest flashback log shortens the flashback database window. If enough flashback logs are reused due to a lack of disk space, then the flashback retention target may not be satisfied.

- If the fast recovery area is full, then an archived redo log that is reclaimable according to the fast recovery area rules may be automatically deleted by the fast recovery area to make space for other files. In this case, any flashback logs that require the use of that redo log file for the use of `FLASHBACK DATABASE` are also deleted.

Note:

According to fast recovery area rules, a file is reclaimable when one of the following criteria is true:

- The file is reported as obsolete and not needed by the flashback database. For example, the file is outside the `DB_FLASHBACK_RETENTION_TARGET` parameters.
 - The file is backed up to tape.
-
-

- Files in the fast recovery area are not eligible for deletion if they are required to satisfy a guaranteed restore point. However, archived redo logs required to satisfy a guaranteed restore point may be deleted after they are backed up to disk or tape. When you use the `RMAN FLASHBACK DATABASE` command, if the archived redo logs required to satisfy a specified guaranteed restore point are not available in the fast recovery area, they are restored from the backups.

Retention of flashback logs and other files required to satisfy the guaranteed restore point, in addition to files required to satisfy the backup retention policy, can cause the fast recovery area to fill completely. Consult "[Responding to a Full Fast Recovery Area](#) (page 12-9)" if your fast recovery area becomes full.

Caution:

If no files are eligible for deletion from the fast recovery area because of the requirements imposed by your retention policy and the guaranteed restore point, then the database performs as if it has encountered a disk full condition. In many circumstances, this causes your database to halt. See "[Responding to a Full Fast Recovery Area](#) (page 12-9)".

7.2.2 About Logging for Guaranteed Restore Points with Flashback Logging Disabled

Assume that you create a guaranteed restore point when logging for Flashback Database is disabled. In this case, the first time a data file block is modified after the time of the guaranteed restore point, the database stores an image of the block before the modification in the flashback logs. Thus, the flashback logs preserve the contents of every changed data block when the guaranteed restore point was created. Later modifications to the same block do not cause the contents to be logged again unless another guaranteed restore point was created after the block was last modified or a subsequent flashback database operation has restored the original contents of the block. When you use Flashback Database to restore a database multiple times to the same restore point, it is common practise to drop and recreate the guaranteed restore point each time. This deletes the old flashback logs and also ensures that the space quota for the fast recovery area is not exceeded.

This method of logging has the following important consequences:

- `FLASHBACK DATABASE` can re-create the data file contents at the time of a guaranteed restore point by using the block images.
- For workloads that repeatedly modify the same data, disk space usage can be less than normal flashback logging. Less space is needed because each changed block is only logged once. Applications with low volume inserts may benefit from this disk space saving. This advantage is less likely for applications with high volume inserts or large batch inserts. The performance overhead of logging for a guaranteed restore point without flashback database logging enabled can also be lower.

Assume that your primary goal is the ability to return your database to the time at which the guaranteed restore point was created. In this case, it is usually more efficient to turn off flashback logging and use only guaranteed restore points. For example, suppose that you are performing an application upgrade on a database host over a weekend. You could create a guaranteed restore point at the start of the upgrade. If the upgrade fails, then reverse the changes with the `FLASHBACK DATABASE` command.

7.2.3 About Logging for Flashback Database with Guaranteed Restore Points Defined

If you enable Flashback Database and define one or more guaranteed restore points, then the database performs normal flashback logging.

In this case, the recovery area retains the flashback logs required to flash back to any arbitrary time between the present and the earliest currently defined guaranteed restore point. Flashback logs are not deleted in response to space pressure if they are required to satisfy the guarantee.

Flashback logging causes some performance overhead. Depending upon the pattern of activity on your database, it can also cause significant space pressure in the fast recovery area. Thus, you should monitor space used in the fast recovery area.

7.3 Prerequisites for Flashback Database and Restore Points

To ensure successful operation of Flashback Database and guaranteed restore points, you must first set some key database options.

Flashback Database

Configure the following database settings before enabling Flashback Database:

- Your database must be running in ARCHIVELOG mode, because archived logs are used in the Flashback Database operation.
- You must have a fast recovery area enabled, because flashback logs can only be stored in the fast recovery area.
- For Oracle Real Application Clusters (Oracle RAC) databases, the fast recovery area must be in a clustered file system or in ASM.
- For creating restore points in CDBs, the COMPATIBLE initialization parameter must be set to 12.1.0 or higher.

Guaranteed Restore Points

To use guaranteed restore points, the database must satisfy the following additional prerequisite: the COMPATIBLE initialization parameter must be set to 10.2.0 or greater.

Note:

There are no special prerequisites to set before using normal restore points.

Restore Points in PDBs

To create restore points in a [pluggable database \(PDB\)](#), the COMPATIBLE initialization parameter must be set to 12.2.0 or higher.

7.4 Using Normal and Guaranteed Restore Points

You can create, monitor, and drop both normal and guaranteed restore points.

This section contains the following topics:

- [Creating Normal and Guaranteed Restore Points in non-CDBs](#) (page 7-11)
- [Listing Restore Points Using the LIST Command](#) (page 7-14)
- [Dropping Restore Points](#) (page 7-16)

7.4.1 Creating Normal and Guaranteed Restore Points in non-CDBs

To create normal or guaranteed restore points, use the CREATE RESTORE POINT SQL statement, providing a name for the restore point and specifying whether it is to be a guaranteed restore point or a normal one (the default).

To create a restore point:

1. Connect SQL*Plus to a target database.

See Also:

Oracle Database Administrator's Guide for using SQL*Plus to connect to a database

2. Ensure that the database is open or mounted. If the database is mounted, then it must have been shut down cleanly (unless it is a physical standby database).

3. Run the `CREATE RESTORE POINT` statement.

The following example shows how to create a normal restore point in SQL*Plus:

```
SQL> CREATE RESTORE POINT before_upgrade;
```

This example shows how to create a guaranteed restore point:

```
SQL> CREATE RESTORE POINT before_upgrade GUARANTEE FLASHBACK DATABASE;
```

See Also:

- *Oracle Database SQL Language Reference* for reference information about the `SQL CREATE RESTORE POINT` statement
 - "[Listing Restore Points Using the LIST Command](#) (page 7-14)" to learn how to list restore point
 - "[Dropping Restore Points](#) (page 7-16)" to learn how to delete restore points
-
-

7.4.2 Creating CDB Restore Points

The `CREATE RESTORE POINT` SQL command enables you to create normal and guaranteed restore points in a multitenant container database (CDB).

To create a CDB restore point:

1. Ensure that the prerequisites described in [Prerequisites for Flashback Database and Restore Points](#) (page 7-10) are satisfied.
2. Connect SQL*Plus to the root as a common user with the `SYSDBA` or `SYSBACKUP` privilege.
3. Ensure that the CDB is open or mounted. If the CDB is mounted, then it must have been shut down cleanly (unless it is a physical standby database).
4. Run the `CREATE RESTORE POINT` statement to create a [CDB restore point](#).

The following command creates a normal CDB restore point:

```
SQL> CREATE RESTORE POINT cdb_before_upgrade;
```

The following command creates a guaranteed CDB restore point:

```
SQL> CREATE RESTORE POINT cdb_grp_before_upgrade GUARANTEE FLASHBACK DATABASE;
```

See Also:

- [About CDB Restore Points](#) (page 7-6)
 - [Creating PDB Restore Points](#) (page 7-13)
 - [Listing Restore Points Using the V\\$RESTORE_POINT View](#) (page 7-15)
 - *Oracle Database Administrator's Guide* for the steps to connect SQL*Plus to the root
-
-

7.4.3 Creating PDB Restore Points

You use the `CREATE RESTORE POINT` SQL statement to create restore points in a pluggable database (PDB).

The restore point can be a normal [PDB restore point](#), guaranteed PDB restore point, or clean PDB restore point. You can create PDB restore points either when connected to the PDB or to the root.

When a PDB uses shared undo, you can create a clean restore point only if the PDB does not have any outstanding transactions.

To create a PDB restore point when connected to the PDB:

1. Ensure that the prerequisites described in [Prerequisites for Flashback Database and Restore Points](#) (page 7-10) are met.
2. Connect SQL*Plus to the PDB as a common user or local user with the `SYSDBA` or `SYSBACKUP` privilege.
3. If you are creating a clean PDB restore point in a CDB that uses shared undo, then the PDB must be closed.

The following command displays the state of the PDB:

```
SQL> SELECT name, open_mode FROM V$PDBS;
```

Use the following command to close the PDB:

```
SQL> ALTER PLUGGABLE DATABASE CLOSE;
```

4. If the [multitenant container database \(CDB\)](#) is in mounted state, then it must have been shut down consistently (unless it is a physical standby database).
5. Set the current container to the PDB.

The following command sets to current container to the PDB `my_pdb`:

```
SQL> ALTER SESSION SET CONTAINER=my_pdb;
```

6. Create a PDB restore point by using the `CREATE RESTORE POINT` command.

The following command creates a normal PDB restore point:

```
SQL> CREATE RESTORE POINT before_patching;
```

The following command creates a guaranteed PDB restore point:

```
SQL> CREATE RESTORE POINT before_upgrade GUARENTEE FLASHBACK DATABASE;
```

The following command explicitly creates a clean PDB restore point. If a clean restore point cannot be created, then an error is returned.

```
SQL> CREATE CLEAN RESTORE POINT before_patching;
```

To create a PDB restore point when connected to the CDB:

1. Ensure that the prerequisites described in [Prerequisites for Flashback Database and Restore Points](#) (page 7-10) are met.

2. Connect SQL*Plus to the root as a common user with the SYSDBA or SYSBACKUP privilege.
3. If you are creating a clean PDB restore point in a CDB that uses shared undo, then the PDB must be closed.

The following command closes the PDB my_pdb:

```
SQL> ALTER PLUGGABLE DATABASE my_pdb CLOSE;
```

4. The CDB that contains the PDB can be open or mounted. If the CDB is mounted, then it must have been shut down consistently (unless it is a physical standby database).

The following commands place the CDB in a mounted state:

```
SQL> SHUTDOWN IMMEDIATE;  
SQL> STARTUP MOUNT;
```

5. Set the current container to the root.
SQL> ALTER SESSION SET CONTAINER = CDB\$ROOT;
6. Create a PDB restore point by using the CREATE RESTORE POINT command with the FOR PLUGGABLE DATABASE clause.

The following command creates a normal PDB restore point:

```
SQL> CREATE RESTORE POINT mypdb_before_patching FOR PLUGGABLE DATABASE my_pdb;
```

The following command creates a guaranteed PDB restore point:

```
SQL> CREATE RESTORE POINT mypdb_grp_before_upgrade FOR PLUGGABLE DATABASE my_pdb  
GUARANTEE FLASHBACK DATABASE;
```

The following command explicitly creates a clean PDB restore point (when the PDB is closed and has no pending transactions). If the restore point cannot be created, then an error is displayed.

```
SQL> CREATE CLEAN RESTORE POINT mypdb_crp_before_patching FOR PLUGGABLE DATABASE  
my_pdb;
```

See Also:

- [About Undo and Flashback Database Operations for PDBs](#) (page 18-6)
 - [About Restore Points in PDBs](#) (page 7-7)
 - [Creating CDB Restore Points](#) (page 7-12)
 - *Oracle Database Administrator's Guide* for the steps to connect SQL*Plus to the root
 - [Listing Restore Points Using the V\\$RESTORE_POINT View](#) (page 7-15)
-
-

7.4.4 Listing Restore Points Using the LIST Command

You can use the LIST command to list either a specific restore point or all restore points known to the RMAN repository. The variations of the command are as follows:

```
LIST RESTORE POINT restore_point_name;
LIST RESTORE POINT ALL;
```

RMAN indicates the SCN and time of the restore point, the type of restore point, and the name of the restore point. The following example shows sample output:

```
RMAN> LIST RESTORE POINT ALL;

using target database control file instead of recovery catalog
SCN              RSP Time  Type           Time         Name
-----
341859           28-APR-15                28-APR-15  NORMAL_RS
343690           28-APR-15  GUARANTEED     28-APR-15  GUARANTEED_RS
```

Note: The LIST command does not display details such as the PDB incarnation number and whether a restore point is a PDB restore point. To view additional details about restore points in a multitenant environment, see [Listing Restore Points Using the V\\$RESTORE_POINT View](#) (page 7-15).

See Also:

"[Rewinding a Database with Flashback Database](#) (page 18-15)"

7.4.5 Listing Restore Points Using the V\$RESTORE_POINT View

You can use the V\$RESTORE_POINT control file view to obtain information about all currently-defined restore points (normal and guaranteed), including CDB restore points and PDB restore points.

The V\$RESTORE_POINT view contains additional information about restore points in a multitenant environment that is not displayed by the LIST RESTORE POINT command. This includes details such as the incarnation of the [pluggable database \(PDB\)](#) in which a [PDB restore point](#) was created and whether a restore point is a PDB restore point or clean PDB restore point.

The following steps display information about PDB restore points for all PDBs in the CDB:

1. Connect SQL*Plus to the target database. If the target database is a [multitenant container database \(CDB\)](#), then connect to the root.
 - To view restore points for all PDBs, you must connect to the root as a common user with the SYSDBA or SYSBACKUP privilege.
 - To view the restore points in a particular PDB, you can connect to that PDB as a common user or local user with the SYSDBA or SYSBACKUP privilege.
2. Query the V\$RESTORE_POINT view to display information about restore points.

Example 7-1 Displaying Restore Points in a Multitenant Environment

The following query displays details about all restore points in a multitenant environment (query output formatted to fit in the page):

```
SELECT name, guarantee_flashback_database, pdb_restore_point,
clean_pdb_restore_point, pdb_incarnation#, storage_size FROM v$restore_point;
```

NAME STORAGE_SIZE -----	GUARANTEE_ -----	PDB_RESTORE_POINT -----	CLEAN_PDB_RESTORE_POINT -----
CDB_GRP_BEFORE_PATCH NO 84586	YES	NO	
PDB_GRP_BEFORE_UPGRADE_TEMP NO 4562	YES	YES	
CDB_RP1	NO	NO	NO
PDB1_BEFORE_PATCHING	NO	YES	NO
MYPDB_CLEAN_GRP_BEFORE_UPGRADE	NO	YES	YES

For normal restore points, `STORAGE_SIZE` is zero. For guaranteed restore points, `STORAGE_SIZE` indicates the amount of disk space in the fast recovery area used to retain logs required to guarantee `FLASHBACK DATABASE` to that restore point.

See Also:

- [Oracle Database Reference](#) for information about `V$RESTORE_POINT`
 - [Listing Restore Points Using the LIST Command](#) (page 7-14)
 - [Rewinding a Database with Flashback Database](#) (page 18-15)
 - [Performing a Flashback Database Operation for a Whole CDB](#) (page 18-19)
 - [Performing a Flashback Database Operation for PDBs](#) (page 18-22)
-
-

7.4.6 Dropping Restore Points

When you are satisfied that you do not need an existing restore point, or when you want to create a restore point with the name of an existing restore point, you can drop the restore point, using the `DROP RESTORE POINT SQL*Plus` statement.

For example:

```
SQL> DROP RESTORE POINT before_app_upgrade;
Restore point dropped.
```

The same statement is used to drop both normal and guaranteed restore points.

Note:

Normal restore points eventually age out of the control file, even if not explicitly dropped. The rules governing retention of restore points in the control file are:

- The most recent 2048 restore points are always kept in the control file, regardless of their age.
- Any restore point more recent than the value of `CONTROL_FILE_RECORD_KEEP_TIME` is retained, regardless of how many restore points are defined.

Normal restore points that do not meet either of these conditions may age out of the control file.

Guaranteed restore points never age out of the control file. They remain until they are explicitly dropped.

See also:

Oracle Database SQL Language Reference for reference information about the `SQL DROP RESTORE POINT` statement

7.5 Using Flashback Database

To use flashback logging for a target database, you must enable Flashback Database. Certain guidelines can be followed to ensure optimal performance of Flashback Database.

This section contains the following topics:

- [Enabling Flashback Database](#) (page 7-17)
- [Disabling Flashback Database Logging](#) (page 7-18)
- [Configuring the Environment for Optimal Flashback Database Performance](#) (page 7-19)
- [Monitoring the Effect of Flashback Database on Performance](#) (page 7-19)
- [About Flashback Writer \(RVWR\) Behavior with I/O Errors](#) (page 7-20)

7.5.1 Enabling Flashback Database

Use the `ALTER DATABASE` command to enable Flashback Database

To enable flashback logging:

1. Configure the recovery area as described in "[Enabling the Fast Recovery Area](#) (page 5-21)".
2. Ensure the database instance is open or mounted. If the instance is mounted, then the database must be shut down cleanly unless it is a physical standby database. Other Oracle Real Application Clusters (Oracle RAC) instances can be in any mode.

3. Optionally, set the `DB_FLASHBACK_RETENTION_TARGET` to the length of the desired flashback window in minutes:

```
ALTER SYSTEM SET DB_FLASHBACK_RETENTION_TARGET=4320 SCOPE=BOTH; # 3 days
```

By default `DB_FLASHBACK_RETENTION_TARGET` is set to 1 day (1440 minutes).

Note:

This setting must be persistent across database startup and shutdown.

4. Enable the Flashback Database feature for the whole database:

```
ALTER DATABASE FLASHBACK ON;
```

5. Optionally, disable flashback logging for specific tablespaces.

By default, flashback logs are generated for all permanent tablespaces. You can reduce overhead by disabling flashback logging for specific tablespaces as in the following example:

```
ALTER TABLESPACE tbs_3 FLASHBACK OFF;
```

You can re-enable flashback logging for a tablespace later with this command:

```
ALTER TABLESPACE tbs_3 FLASHBACK ON;
```

If you disable Flashback Database for a tablespace, then you must take its data files offline before running `FLASHBACK DATABASE`.

When you enable Flashback Database while the database is open, there is a very small chance the command may not be able to obtain the memory it needs. If the command fails because of that reason, retry the command after a while or retry after a shutdown and restart of the instance.

When you enable Flashback Database on a [physical standby database](#), you can flashback a standby database. Flashback Database of standby databases has some applications in the Data Guard environment.

See Also:

Oracle Data Guard Concepts and Administration for details about standby databases

7.5.2 Disabling Flashback Database Logging

Use the `ALTER DATABASE` command to disable Flashback Database.

On a database instance that is either in mount or open state, issue the following command:

```
ALTER DATABASE FLASHBACK OFF;
```

7.5.3 Configuring the Environment for Optimal Flashback Database Performance

Maintaining flashback logs imposes comparatively limited overhead on an database instance. Changed blocks are written from memory to the flashback logs at relatively infrequent, regular intervals, to limit processing and I/O overhead.

To achieve good performance for large production databases with Flashback Database enabled, Oracle recommends the following:

- Use a fast file system for your fast recovery area, preferably without operating system file caching.

Files that the database creates in the fast recovery area, including flashback logs, are typically large. Operating system file caching is typically not effective for these files, and may actually add CPU overhead for reading from and writing to these files. Thus, it is recommended to use a file system that avoids operating system file caching, such as Automatic Storage Management (ASM).

- Configure enough disk spindles for the file system that holds the fast recovery area.

For large production databases, multiple disk spindles may be needed to support the required disk throughput for the database to write the flashback logs effectively.

- If the storage system used to hold the fast recovery area does not have nonvolatile RAM, then try to configure the file system on striped storage volumes.

Use a relatively small stripe size such as 128 KB. This technique enables each write to the flashback logs to be spread across multiple spindles, improving performance.

- For large databases, set the initialization parameter `LOG_BUFFER` to at least 8 MB.

The overhead of logging for Flashback Database depends on the mixture of reads and writes in the database workload. When you have a write-intensive workload, the Flashback Database logging overhead is high since it must log all those database changes. Queries do not change data and thus do not contribute to logging activity for Flashback Database.

7.5.4 Monitoring the Effect of Flashback Database on Performance

Several data analysis methods are available to monitor the Flashback Database workload on your system.

- AWR reports

The Automatic Workload Repository (AWR) automates database statistics gathering by collecting, processing, and maintaining performance statistics for database problem detection and self-tuning. You can compare AWR reports from before and after the Flashback Database was turned on to monitor performance effects.

- AWR snapshots

You can review AWR snapshots to pinpoint system usage caused by flashback logging. For example, if `flashback buf free by RVWR` is the top wait event, then you know that Oracle Database cannot write flashback logs very quickly. Therefore, you might want to tune the file system and storage used by the fast

recovery area, possibly using a technique described in "[Configuring the Environment for Optimal Flashback Database Performance](#) (page 7-19)"

- **V\$FLASHBACK_DATABASE_STAT** view
The V\$FLASHBACK_DATABASE_STAT view shows the bytes of flashback data logged by the database. Each row in the view shows the statistics accumulated (typically over the course of an hour). The FLASHBACK_DATA and REDO_DATA columns describe bytes of flashback data and redo data written respectively during the time interval, while the DB_DATA column describes bytes of data blocks read and written. The columns FLASHBACK_DATA and REDO_DATA correspond to sequential writes, whereas DB_DATA column corresponds to random reads and writes.
- **V\$SYSSTAT** view
Because of the difference between sequential I/O and random I/O, a better indication of I/O overhead is the number of I/O operations issued for flashback logs. The V\$SYSSTAT statistics shown in [Table 7-1](#) (page 7-20) can tell you the number of I/O operations that your instance has issued for various purposes.

Table 7-1 V\$SYSSTAT Statistics

Column Name	Column Meaning
Physical write I/O request	The number of write operations issued for writing data blocks
Physical read I/O request	The number of read operations issued for reading data blocks
Redo writes	The number of write operations issued for writing to the redo log
Flashback log writes	The number of write operations issued for writing to flashback logs
Flashback log write bytes	Total size in bytes of flashback database data written from this instance

See Also:

- *Oracle Database Reference* for more details on columns in the V\$SYSSTAT view
- *Oracle Database Performance Tuning Guide* to learn about AWR
- *Oracle Database 2 Day + Performance Tuning Guide* for more information about AWR reports

7.5.5 About Flashback Writer (RVWR) Behavior with I/O Errors

When flashback is enabled or when there are guaranteed restore points, the background process RVWR writes flashback data to flashback database logs in the fast recovery area.

If RVWR encounters an I/O error, then the following behavior is expected:

- If there are any guaranteed restore points defined, then the instance fails when RVWR encounters I/O errors.

- If no guaranteed restore points are defined, then the instance remains unaffected when RVWR encounters I/O errors. Note the following cases:
 - On a primary database, Oracle Database automatically disables Flashback Database while the database is open. All existing transactions and queries proceed unaffected. This behavior is expected for both single-instance and Oracle RAC databases.
 - On a physical or logical standby, RVWR appears to have stopped responding, retrying the I/O periodically. This may eventually cause the logical standby or the managed recovery of the physical standby to suspend. (Oracle Database does not cause the standby instance to fail because it does not want to cause the primary database to fail in maximum protection mode.) To resolve the issue, you can issue either a `SHUTDOWN ABORT` or an `ALTER DATABASE FLASHBACK OFF` command.

Part III

Backing Up and Archiving Data

The chapters in this part describe how to use the RMAN utility to perform advanced backup and recovery operations, and explain RMAN performance tuning and troubleshooting.

This part contains these chapters:

- [RMAN Backup Concepts](#) (page 8-1)
- [Backing Up the Database](#) (page 9-1)
- [Backing Up the Database: Advanced Topics](#) (page 10-1)

RMAN Backup Concepts

This chapter describes the general concepts that you must understand to make any type of RMAN backup. This chapter contains the following topics:

- [About Consistent and Inconsistent RMAN Backups](#) (page 8-1)
- [About Online Backups and Backup Mode](#) (page 8-2)
- [About Backup Sets](#) (page 8-3)
- [About RMAN Image Copies](#) (page 8-10)
- [About Multiple Copies of RMAN Backups](#) (page 8-13)
- [About RMAN Control File and Server Parameter File Autobackups](#) (page 8-15)
- [About RMAN Incremental Backups](#) (page 8-17)
- [About Backup Retention Policies](#) (page 8-22)

8.1 About Consistent and Inconsistent RMAN Backups

Use the RMAN `BACKUP` command to create both consistent and inconsistent backups.

The RMAN `BACKUP` command supports backing up the following types of files:

- Data files and control files
- Server parameter file
- Archived redo logs
- RMAN backups

Although the database depends on other types of files, such as network configuration files, password files, and the contents of the Oracle home, you cannot back up these files with RMAN. Likewise, some features of Oracle Database, such as external tables, may depend upon files other than the data files, control files, and redo log. RMAN cannot back up these files. Use general-purpose backup software such as Oracle Secure Backup to protect files that RMAN does not support.

When you execute the `BACKUP` command in RMAN, the output is always either one or more backup sets or one or more image copies. A [backup set](#) is an RMAN-specific proprietary format, whereas an [image copy](#) is a bit-for-bit copy of a file. By default, RMAN creates backup sets.

See Also:

- [About Consistent RMAN Backups](#) (page 8-2)
 - [About Inconsistent RMAN Backups](#) (page 8-2)
-
-

8.1.1 About Consistent RMAN Backups

A consistent backup occurs when the database is in a consistent state. You can use the `BACKUP` command to make consistent backups of the database.

A database is in a consistent state after being shut down with the `SHUTDOWN NORMAL`, `SHUTDOWN IMMEDIATE`, or `SHUTDOWN TRANSACTIONAL` commands. A consistent shutdown guarantees that all redo has been applied to the data files. If you mount the database and make a backup at this point, then you can restore the database backup later and open it without performing media recovery. But you will, of course, lose all transactions that occurred after the backup was created.

8.1.2 About Inconsistent RMAN Backups

Any database backup that is not consistent is an inconsistent backup. A backup made when the database is open is inconsistent, as is a backup made after an instance failure or `SHUTDOWN ABORT` command.

When a database is restored from an inconsistent backup, Oracle Database must perform media recovery before the database can be opened, applying changes from the redo logs that took place after the backup was created.

Note:

RMAN does not permit you to make inconsistent backups when the database is in `NOARCHIVELOG` mode. If you employ user-managed backup techniques for a `NOARCHIVELOG` database, then you must not make inconsistent backups of this database.

If the database runs in `ARCHIVELOG` mode, and you back up the archived redo logs and data files, inconsistent backups can be the foundation for a sound backup and recovery strategy. Inconsistent backups offer superior availability because you do not have to shut down the database to make backups that fully protect the database.

8.2 About Online Backups and Backup Mode

You can create RMAN backups or user-managed backups.

When performing a [user-managed backup](#) of an online tablespace or database, an operating system utility can back up a data file at the same time that the database writer (DBWR) is updating the file. It is possible for the utility to read a block in a half-updated state, so that the block that is copied to the backup media is updated in its first half, while the second half contains older data. This type of [logical corruption](#) is known as a [fractured block](#), that is, a block that is not consistent with an SCN. If this backup must be restored and the block requires recovery, then recovery fails because the block is not usable.

For third-party snapshot technologies, you must use one of the following techniques to eliminate the risk of creating fractured blocks:

- Ensure that the snapshot technology complies with Oracle requirements for online backups
- Take the database or data files offline
- Place the database in backup mode before using a third-party snapshot backup

See Also:

- [Making Backups with Third-Party Snapshot Technologies](#) (page 29-22).
 - [Recovery Using Storage Snapshot Optimization](#) (page 30-10)
-

Unlike user-managed tools, RMAN does not require extra logging or backup mode because it knows the format of data blocks. RMAN is guaranteed not to back up fractured blocks. During an RMAN backup, a database server session reads each data block and checks whether it is fractured by comparing the block header and footer. If a block is fractured, then the session rereads the block. If the same fracture is found, then the block is considered permanently corrupt. Also, RMAN does not need to freeze the data file header checkpoint because it knows the order in which the blocks are read, which enables it to capture a known good checkpoint for the file.

See Also:

[Making User-Managed Backups of Online Tablespaces and Data Files](#) (page 29-6) to learn how to back up online tablespaces when not using RMAN

8.3 About Backup Sets

When you execute the `BACKUP` command in RMAN, you create one or more backup sets or image copies. By default, RMAN creates backup sets regardless of whether the destination is disk or a media manager.

Note:

Data file backup sets are typically smaller than data file image copies and take less time to write.

This section contains the following topics:

- [About Backup Sets and Backup Pieces](#) (page 8-4)
- [About RMAN Block Compression for Backup Sets](#) (page 8-4)
- [About Binary Compression for RMAN Backup Sets](#) (page 8-5)
- [About RMAN Backup Undo Optimization](#) (page 8-6)
- [About Encryption for RMAN Backup Sets](#) (page 8-6)
- [About File Names for RMAN Backup Pieces](#) (page 8-6)
- [About Number and Size of RMAN Backup Pieces](#) (page 8-7)

- [About Number and Size of RMAN Backup Sets](#) (page 8-7)
- [About Multiplexed RMAN Backup Sets](#) (page 8-8)
- [About RMAN Proxy Copies](#) (page 8-10)

8.3.1 About Backup Sets and Backup Pieces

RMAN can store backup data in a logical structure called a backup set, which is the smallest unit of an RMAN backup.

A backup set contains the data from one or more data files, archived redo logs, control files, or server parameter file. Backup sets, which are only created and accessed through RMAN, are the only form in which RMAN can write backups to media managers such as tape drives and tape libraries.

A backup set contains one or more binary files in an RMAN-specific format. Each of these files is known as a [backup piece](#). A backup set can contain multiple data files. For example, you can back up 10 data files into a single backup set consisting of a single backup piece. In this case, RMAN creates one backup piece as output. The backup set contains only this backup piece.

If you specify the `SECTION SIZE` parameter on the `BACKUP` command, then RMAN produces a [multisection backup](#). This is a backup of a single large file, produced by multiple channels in parallel, each of which produces one backup piece. Each backup piece contains one [file section](#) of the file being backed up.

For non-multisection backups, RMAN only records backup sets in the repository that complete successfully. There is no such thing as a partial backup set. This differs from an unsuccessful multisection backup, where it is possible for RMAN metadata to contain a record for a partial backup set. In the latter case, you must use the `DELETE` command to delete the partial backup set.

Note:

RMAN never considers partial backups as candidates for restore and recovery.

See Also:

[Backing Up the Database](#) (page 9-1)

8.3.2 About RMAN Block Compression for Backup Sets

RMAN can use block compression when creating backup sets.

The following types of block compression are available:

- Unused Block Compression (Supports disk backup and Oracle Secure Backup tape backup)
- Null Block Compression (Supports all backups)

RMAN block compression is not traditional binary compression. Rather, it is a set of techniques that RMAN uses to altogether avoid backing up certain blocks that are not needed in this backup.

8.3.2.1 About Unused Block Compression

When employing unused block compression, RMAN skips reading, and backing up, any database blocks that are not currently allocated to some database object. This is regardless of whether those blocks had previously been allocated.

So if a database table is dropped, RMAN will not back up the space that was occupied by that table until new objects are created in that space.

Unused block compression is used automatically when the following conditions are true:

- The `COMPATIBLE` initialization parameter is set to 10.2 or higher.
- There are currently no guaranteed restore points defined for the database.
- The data file is locally managed.
- The data file is being backed up to a backup set as part of a full backup or a level 0 incremental backup.
- The backup set is created on disk, or Oracle Secure Backup is the media manager.

8.3.2.2 About Null Block Compression

When employing null block compression, RMAN omits from its output any block that has never contained data.

Null block compression is always used with level 0 or full backups that are created in backup set format.

8.3.3 About Binary Compression for RMAN Backup Sets

RMAN supports binary compression of backup sets. Binary compression is only enabled when you specify `AS COMPRESSED BACKUPSET` in the `BACKUP` command, or one-time with the `CONFIGURE DEVICE TYPE [DISK | SBT] BACKUP TYPE TO COMPRESSED BACKUPSET` command.

You have two binary compression options:

- You can use the `BASIC` compression algorithm, which does not require the Oracle Advanced Compression option. This setting offers a compression ratio comparable to `MEDIUM`, at the expense of additional CPU consumption.
- If you have enabled the Oracle Advanced Compression option, you can choose from the compression levels outlined in "[About Oracle Advanced Compression Option](#) (page 6-8)".

See Also:

- [Configuring Compression Options](#) (page 6-7)
 - *Oracle Database Backup and Recovery Reference* to learn about `BACKUP AS BACKUPSET` and `CONFIGURE COMPRESSION ALGORITHM`
-
-

8.3.4 About RMAN Backup Undo Optimization

In backup undo optimization, RMAN excludes undo not needed for recovery of a backup, that is, for transactions that have been committed.

Backup undo optimization works for disk backups and Oracle Secure Backup tape backups. Unlike [backup optimization](#), backup undo optimization is not configurable.

8.3.5 About Encryption for RMAN Backup Sets

RMAN supports backup encryption for backup sets. You can use keystore-based transparent encryption, password-based encryption, or both.

You can use the `CONFIGURE ENCRYPTION` command to configure persistent transparent encryption. Use the `SET ENCRYPTION` command at the [RMAN session](#) level to specify password-based encryption.

Note:

Keystore-based encryption is more secure than password-based encryption because no passwords are involved. Use password-based encryption only when it is absolutely necessary because your backups must be transportable.

To create encrypted backups on disk with RMAN, the database must use the Advanced Security Option. For encrypted RMAN backups directly to tape, the [Oracle Secure Backup SBT](#) is the only supported interface.

See Also:

- [Configuring Backup Encryption](#) (page 6-9)
 - [Encrypting RMAN Backups](#) (page 10-11)
-
-

8.3.6 About File Names for RMAN Backup Pieces

You can either let RMAN determine a unique name for backup pieces or use the `FORMAT` clause to specify a name.

If you do not specify the `FORMAT` parameter, then RMAN automatically generates a unique file name with the `%U` substitution variable in the default backup location.

An example of RMAN generating an SBT backup piece name by `%U` is:

```
2i1nk47_1_1
```

An example of a non- Oracle Managed File (OMF) backup piece on disk is:

```
/backups/TEST/2i1nk47_1_1
```

The `FORMAT` clause supports substitution variables other than `%U` for generating unique file names. For example, you can use `%d` to generate the name of the database, `%I` for the DBID, `%t` for the time stamp, and so on.

You can specify up to four `FORMAT` parameters. If you specify multiple `FORMAT` parameters, then RMAN uses the multiple `FORMAT` parameters only when you specify

multiple copies. You can create multiple copies by using the `BACKUP . . . COPIES`, `SET BACKUP COPIES`, or `CONFIGURE . . . BACKUP COPIES` commands.

Note:

If you use a media manager, then check your vendor documentation for restrictions on `FORMAT`, such as the size of the name, the naming conventions, and so on.

See Also:

- [Specifying a Format for RMAN Backups](#) (page 9-4)
 - *Oracle Database Backup and Recovery Reference* for descriptions of the `FORMAT` clause and the substitution variables
-

8.3.7 About Number and Size of RMAN Backup Pieces

By default a backup set contains one backup piece. To restrict the size of each backup piece, specify the `MAXPIECESIZE` option of the `CONFIGURE CHANNEL` or `ALLOCATE CHANNEL` commands.

The `MAXPIECESIZE` option limits backup piece size to the specified number of bytes. If the total size of the backup set is greater than the specified backup piece size, then RMAN creates multiple physical pieces to hold the backup set contents.

You can use this option for media managers that cannot manage a backup piece that spans multiple tapes. For example, if a tape can hold 10 GB, but the backup set being created must hold 80 GB of data, then you must instruct RMAN to create backup pieces of 10 GB, small enough to fit on the tapes used with the media manager. In this case, the backup set media consists of eight tapes. Media managers supporting SBT 2.0 can return a value to RMAN indicating the largest supported backup piece size, which RMAN uses in planning backup activities.

If you specify the `SECTION SIZE` parameter on the `BACKUP` command, then RMAN can create a [multisection backup](#). In this case, a single backup set can contain multiple backup pieces, each containing a [file section](#). The purpose of multisection backups is to enable multiple channels to back up a large file in parallel.

See Also:

- [Configuring the Maximum Size of Backup Pieces](#) (page 6-5)
 - *Oracle Database Backup and Recovery Reference* for `ALLOCATE CHANNEL` syntax
 - *Oracle Database Backup and Recovery Reference* for `CONFIGURE` syntax
-

8.3.8 About Number and Size of RMAN Backup Sets

You use the `backupSpec` clause of the `BACKUP` command to specify the objects to be backed up. Each `backupSpec` clause produces at least one backup set.

The total number and size of backup sets depends mostly on an internal RMAN algorithm. However, you can influence RMAN behavior with the `MAXSETSIZE` parameter in the `CONFIGURE` or `BACKUP` command. By limiting the size of the backup set, the parameter indirectly limits the number of files in the set and can possibly force RMAN to create additional backup sets. Also, you can specify `BACKUP . . . FILESPERSET` to specify the maximum number of files in each backup set.

See Also:

- [About Backup Set Size](#) (page 10-2)
 - [Tuning RMAN Performance](#) (page 23-1) to learn about RMAN buffer management
 - *Oracle Database Backup and Recovery Reference* to learn the syntax for the `backupSpec` clause
-
-

8.3.9 About Multiplexed RMAN Backup Sets

When creating backup sets, RMAN can simultaneously read multiple files from disk and then write their blocks into the same backup set. For example, RMAN can read from two data files simultaneously, and then combine the blocks from these data files into a single backup piece. The combination of blocks from multiple files is called backup multiplexing.

Image copies, by contrast, are never multiplexed.

Note:

If RMAN creates a [multisection backup](#) of a data file, then the data file is not multiplexed with any other data file or [file section](#).

As [Figure 8-1](#) (page 8-9) illustrates, RMAN can back up three data files into a backup set that contains only one backup piece. This backup piece contains the intermingled data blocks of the three input data files.

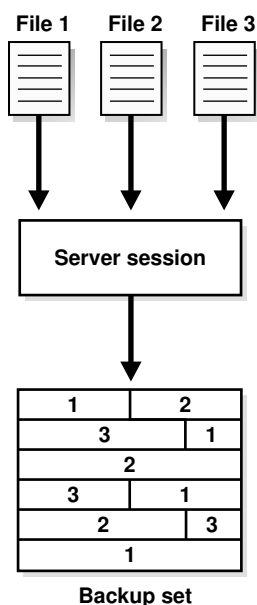
Figure 8-1 Data File Multiplexing

RMAN multiplexing is determined by several factors. For example, the `FILESERSET` parameter of the `BACKUP` command determines how many data files to put in each backup set. The `MAXOPENFILES` parameter of `ALLOCATE CHANNEL` or `CONFIGURE CHANNEL` defines how many data files RMAN can read from simultaneously. The basic multiplexing algorithm is as follows:

- Number of files in each backup set
This number is the minimum of the `FILESERSET` setting and the number of files read by each channel. The `FILESERSET` default is 64.
- The [level of multiplexing](#)
This is the number of input files simultaneously read and then written into the same backup piece. The level of multiplexing is the minimum of `MAXOPENFILES` and the number of files in each backup set. The `MAXOPENFILES` default is 8.

Suppose that you back up 12 data files with one channel when `FILESERSET` is set to 4. The level of multiplexing is the lesser of this number and 8. Thus, the channel simultaneously writes blocks from 4 data files into each backup piece.

Now suppose that you back up 50 data files with one channel. The number of files in each backup set is 50. The level of multiplexing is the lesser of this number and 8. Thus, the channel simultaneously writes blocks from 8 data files into each backup piece.

RMAN multiplexing of backup sets is different from [media manager multiplexing](#). One type of media manager multiplexing occurs when the media manager writes the concurrent output from multiple RMAN channels to a single sequential device. Another type occurs when a backup mixes database files and non-database files on the same tape.

Note:

Oracle recommends that you never use media manager multiplexing for RMAN backups.

See Also:

- [Allocation of Input Disk Buffers](#) (page 23-4) to learn how multiplexing affects allocation of disk buffers during backups
 - *Oracle Database Backup and Recovery Reference* for BACKUP syntax
-

8.3.10 About RMAN Proxy Copies

During a proxy copy, RMAN turns over control of the data transfer to a media manager that supports this feature. Proxy copy can only be used with media managers that support it and cannot be used with channels of type DISK. The PROXY option of the BACKUP command specifies that a backup is a proxy copy.

For each file that you attempt to back up with the BACKUP PROXY command, RMAN queries the media manager to determine whether it can perform a proxy copy. If the media manager cannot proxy copy the file, then RMAN backs up the file as if the PROXY option had not been used. (Use the PROXY ONLY option to force RMAN to fail if a proxy copy cannot be performed.)

Control files are never backed up with proxy copy. If the PROXY option is specified on an operation backing up a control file, then it is silently ignored for the purposes of backing up the control file.

See Also:

- *Oracle Database Reference* for more information about the V \$PROXY_DATAFILE view
 - *Oracle Database Reference* for more information about the V \$PROXY_ARCHIVEDLOG view
 - *Oracle Database Backup and Recovery Reference* for the BACKUP command and the PROXY option
-

8.4 About RMAN Image Copies

An image copy is an exact copy of a single data file, archived redo log file, or control file.

Image copies are not stored in an RMAN-specific format. They are identical to the results of copying a file with operating system commands. RMAN can use image copies during RMAN restore and recover operations, and you can also use image copies with non-RMAN restore and recovery techniques.

This section contains the following topics:

- [About RMAN-Created Image Copies](#) (page 8-10)
- [About User-Managed Image Copies](#) (page 8-11)

8.4.1 About RMAN-Created Image Copies

To create image copies and have them recorded in the RMAN repository, you run the RMAN BACKUP AS COPY command.

Alternatively, you can configure the default backup type for disk as image copies. A database server session is used to create the copy. The server session also performs actions such as validating the blocks in the file and recording the image copy in the RMAN repository.

As with backup pieces, `FORMAT` variables are used to specify the names of image copies. The default format `%U`, which was explained in "[About File Names for RMAN Backup Pieces](#) (page 8-6)", is defined differently for image copies. The following example shows the name for data file 2 generated by `%U`:

```
/dl/oracle/work/orcva/RDBMS/datafile/ol_mf_sysaux_2qylngm3_.dbf
```

When creating image copies, you can also name the output copies with the `DB_FILE_NAME_CONVERT` parameter of the `BACKUP` command. This parameter works identically to the `DB_FILE_NAME_CONVERT` initialization parameter. Pairs of file name prefixes are provided to change the names of the output files. If a file is not converted by any of the pairs, then RMAN uses the `FORMAT` specification: if no `FORMAT` is specified, then RMAN uses the default format `%U`.

Example 8-1 Specifying File Names with `DB_FILE_NAME_CONVERT`

This example copies the data files whose file name is prefixed with `/maindisk/oradata/users` so that they are prefixed with `/backups/users_ts`.

```
BACKUP AS COPY
  DB_FILE_NAME_CONVERT ('/maindisk/oradata/users',
                       '/backups/users_ts')
  TABLESPACE users;
```

If you run a `RESTORE` command, then by default RMAN restores a data file or control file to its original location by copying an image copy backup to that location. Image copies are chosen over backup sets because of the extra overhead of reading through an entire backup set in search of files to be restored.

If you must restore and recover a current data file, and if you have an image copy available on disk, then you do not need to have RMAN copy the image copy back to its old location. Instead, you can use the image copy in place as a replacement for the data file to be restored. "[Performing Complete Recovery After Switching to a Copy](#) (page 17-18)" explains how to perform this task.

See Also:

- [Configuring the Default Type for Backups: Backup Sets or Copies](#) (page 5-4) to learn how to make either backup sets or image copies the default type of RMAN backups
 - [Specifying Backup Set or Copy for an RMAN Backup to Disk](#) (page 9-3)
 - *Oracle Database Backup and Recovery Reference* to learn about the meaning of `%U` for image copies
-

8.4.2 About User-Managed Image Copies

RMAN can use image copies created by mechanisms outside of RMAN, such as native operating system file copy commands or third-party utilities that leave image copies of files on disk. This type of copy is known as a user-managed backup or operating system backup.

You can use the `CATALOG` command to inspect an existing image copy and enter its metadata into the RMAN repository. However, the `CATALOG` command does not do the following:

- Read all blocks in the data file copy to ensure there are no corruptions
- Guarantee that the image copy was correctly made in [backup mode](#)

After you catalog these files, you can use them with the `RESTORE` or `SWITCH` commands just as you can for RMAN-generated image copies.

Some sites store their data files on mirrored disk volumes, which permit the creation of image copies by [breaking a mirror](#). After you have broken the mirror, you can notify RMAN of the existence of a new user-managed copy, thus making it eligible for a backup. You must notify RMAN when the copy is no longer available by using the `CHANGE . . . UNCATALOG` command.

See Also:

- [Making User-Managed Database Backups](#) (page 29-1)
 - [Adding Backup Records to the RMAN Repository](#) (page 12-17) to learn how to catalog data file and archived log image copies
 - [Making Split Mirror Backups with RMAN](#) (page 10-9)
 - *Oracle Database Backup and Recovery Reference* for `CHANGE` syntax
-

8.5 About Sparse Backups

You can use the RMAN `BACKUP` command to back up data blocks from sparse data files, tablespaces containing sparse data files, sparse pluggable databases (PDBs), and multitenant container databases (CDBs) containing sparse PDBs.

A sparse data file is a logical Oracle object that is created as a shadow of a base data file object and is stored in a physical storage space known as delta space. For instance, consider a sparse database `DB0` that is created from a base database `DB`. In a sparse environment, it is mandatory that the base objects must be read-only. Unlike the base database, sparse databases are read-write databases. In this case, `DB`, a read-only database, consists of 5 data files. `DB0` recreates the logical versions of each of these 5 base data files and assigns a separate delta storage space for each individual file. When the sparse database `DB0` updates a data block in one of the sparse data files, only the updated block is logically stored in the delta space of that modified data file. When you choose to perform a sparse backup on `DB0`, the operation will copy data only from the delta storage space of the database and the delta space of the sparse data files. A sparse backup can either be in the backup set format (default) or the image copy format. RMAN restores sparse data files from sparse backups and then recovers them from archive and redo logs. You can perform a complete or a point-in-time recovery on sparse data files.

To perform sparse backup and recovery operations, your database must have the `COMPATIBLE` initialization parameter set to 12.2 or higher.

If your database has the `COMPATIBLE` initialization parameter as 12.2 and you perform a full or level 0 incremental backup on a non-sparse (normal) data file, then RMAN performs a traditional full or level 0 incremental backup of the specified data file. On the other hand, if you perform a full or level 0 incremental backup on a sparse

data file, then RMAN performs a backup only of all the latest changes from the delta storage space of that particular data file.

For a database with the `COMPATIBLE` initialization parameter less than 12.2, RMAN continues to perform the backup and recovery operations as before and are not influenced by the sparseness of a data file.

Sparse backups help in efficiently managing storage space and facilitate faster backup and recovery.

Note:

The base (read-only) data files in a sparse database are not encrypted. Ensure that the base data files are stored in a protected storage and accessed using secured communications.

See Also:

[Backing Up Sparse Databases with RMAN](#) (page 9-22)

8.6 About Multiple Copies of RMAN Backups

RMAN enables you to make multiple, identical copies of backups.

Use one of the following ways:

- Duplex backups with the `BACKUP . . . COPIES` command, in which case RMAN creates multiple copies of each backup set

See [About Duplexed Backup Sets](#) (page 8-13).

- Back up your files as backup sets or image copies, and then back up the backup sets or image copies with the `RMAN BACKUP BACKUPSET` or `BACKUP COPY OF` commands

See [About Backups of RMAN Backups](#) (page 8-14).

8.6.1 About Duplexed Backup Sets

When backing up data files, archived redo log files, server parameter files, and control files into backup pieces, RMAN can create a [duplexed backup set](#), producing up to four identical copies of each backup piece in the backup set on different backup destinations with one `BACKUP` command. Duplexing is not supported for backup operations that produce image copies.

You can use the `COPIES` parameter in the `CONFIGURE`, `SET`, or `BACKUP` commands to specify duplexing of backup sets when using the `BACKUP` command. RMAN can duplex backups to either disk or tape, but cannot duplex backups to tape and disk simultaneously. When backing up to tape, ensure that the number of copies does not exceed the number of available tape devices.

The `FORMAT` parameter of the `BACKUP` command specifies the destinations for duplexed backups. The following example creates three copies of the backup of data file 7:

```
BACKUP DEVICE TYPE DISK COPIES 3 DATAFILE 7
  FORMAT '/disk1/%U','?/oradata/%U','?/%U';
```

RMAN places the first copy of each backup piece in `/disk1`, the second in `?`/`oradata`, and the third in the Oracle home. RMAN does not produce three backup sets, each with a different unique backup set key. Rather, RMAN produces one backup set with a unique key, and generates three identical copies of each backup piece in the set.

See Also:

- ["Configuring Backup Duplexing \(page 6-5\)"](#)
 - ["Duplexing Backup Sets \(page 10-7\)"](#)
 - *Oracle Database Backup and Recovery Reference* for `CONFIGURE` syntax
 - *Oracle Database Backup and Recovery Reference* for `SET` syntax
-

8.6.2 About Backups of RMAN Backups

You can use the `BACKUP` command to back up existing backup sets and image copies. Backing up existing backups enables you to make multiple, identical copies of RMAN backups.

The following sections provide more information about the methods of creating backups up backups:

- [Backups of Backup Sets \(page 8-14\)](#)
- [Backups of Image Copies \(page 8-15\)](#)

8.6.2.1 Backups of Backup Sets

The RMAN `BACKUP BACKUPSET` command backs up backup sets that were created on disk. The command is a useful way to spread backups among multiple media.

If RMAN discovers that one copy of a backup set is corrupted or missing, then it searches for other copies of the same backup set. This behavior is similar to the behavior of RMAN when backing up archived redo logs that exist in multiple archiving destinations.

RMAN enables you to create encrypted backups of unencrypted backup sets. Before you back up the unencrypted backup sets, use the `SET ENCRYPTION FOR DATABASE ON` command to enable encryption. Note that the `SET` command enables encryption for the current RMAN session. If encryption is not required for subsequent operations, then turn off encryption for the database.

Example 8-2 Backing Up Backup Sets to Tape

This example shows how you might run the `BACKUP` command weekly as part of the production backup schedule. In this way, you ensure that all your backups exist on both disk and tape.

```
BACKUP DEVICE TYPE DISK AS BACKUPSET
  DATABASE PLUS ARCHIVELOG;
BACKUP
  DEVICE TYPE sbt
  BACKUPSET ALL; # copies backup sets on disk to tape
```

Note:

Backups to `sbt` that use automatic channels require that you first run the `CONFIGURE DEVICE TYPE sbt` command.

Example 8-3 Managing Space Allocation

You can also use `BACKUP BACKUPSET` to manage backup space allocation. This example backs up backup sets that were created more than a week ago from disk to tape, and then deletes them from disk.

```
BACKUP
  DEVICE TYPE sbt
  BACKUPSET COMPLETED BEFORE 'SYSDATE-7'
  DELETE INPUT;
```

`DELETE INPUT` here is equivalent to `DELETE ALL INPUT`: RMAN deletes all existing copies of the backup set. If you duplexed a backup to four locations, then RMAN deletes all four copies of the pieces in the backup set.

See Also:

["Backing Up RMAN Backups \(page 9-48\)"](#)

8.6.2.2 Backups of Image Copies

You can use the `BACKUP COPY OF` command to back up existing image copies of database files either as backup sets or as image copies. When using this command, an image copy of every data file specified in the command must exist. If there are multiple copies of a data file, then the latest one is used. If you specify a tablespace or the whole database, then RMAN issues an error if there are data files in the database or tablespace for which there are no image copy backups.

8.7 About RMAN Control File and Server Parameter File Autobackups

Having recent backups of your control file and server parameter file is extremely valuable in many recovery situations. To ensure that you have backups of these files, the database supports control file and server parameter file autobackups.

The autobackup occurs independently of any backup of the current control file explicitly requested as part of your `BACKUP` command. With a [control file autobackup](#), RMAN can recover the database even if the current control file, recovery catalog, and server parameter file are inaccessible. Because the path used to store the autobackup follows a well-known format, RMAN can search for and restore the server parameter file from that autobackup. After you have started the instance with the restored server parameter file, RMAN can restore the control file from the autobackup. After you mount the control file, use the RMAN repository in the mounted control file to restore the data files.

It is recommended that you turn on control file autobackups. Otherwise, RMAN database point-in-time recovery (DBPITR) and point-in-time recovery (PITR) for [PDBs](#) may not work effectively when PITR needs to undo data file additions or deletions.

This section contains the following topics:

- [When RMAN Performs Control File Autobackups \(page 8-16\)](#)

- [How RMAN Performs Control File Autobackups](#) (page 8-16)

8.7.1 When RMAN Performs Control File Autobackups

Depending on the configuration of the target database, RMAN can perform autobackups of the control file and server parameter file.

For non-CDBs, if `CONFIGURE CONTROLFILE AUTOBACKUP` is ON, then RMAN automatically backs up the control file and the current server parameter file (if used to start the database) after a successful `BACKUP` command. For CDBs and standalone databases with the `COMPATIBLE` initialization parameter set to 12.0 or higher, by default, the control file autobackup is turned on.

If the database runs in `ARCHIVELOG` mode, RMAN makes control file autobackups when a structural change to the database affects the contents of the control file.

Note:

Beginning with Oracle Database Release 11g Release 2, RMAN takes only one control file autobackup when multiple structural changes contained in a script (for example, adding tablespaces, altering the state of a tablespace or data file, adding a new online redo log, renaming a file, and so on) have been applied.

8.7.2 How RMAN Performs Control File Autobackups

The first channel allocated during the backup job creates the autobackup and places it into its own backup set. For autobackups after database structural changes, the server process associated with the structural change makes the backup.

If a server parameter file is in use by the database, then RMAN backs it up in the same backup set as the control file autobackup. After the autobackup completes, the database writes a message containing the complete path of the backup piece and the device type to the alert log located in the [Automatic Diagnostic Repository \(ADR\)](#).

Note:

Control file autobackups are never duplexed.

The control file autobackup file name has a default format of `%F` for all device types, so that RMAN can determine the file location and restore it without a repository. You can specify a different format with the `CONFIGURE CONTROLFILE AUTOBACKUP FORMAT` command, but all autobackup formats must include the `%F` variable. If you do not use the default format, then during disaster recovery you must specify the format that was used to generate the autobackups. Otherwise, RMAN cannot restore the autobackup.

See Also:

- [Configuring Control File and Server Parameter File Autobackups](#) (page 5-8)
 - *Oracle Database Backup and Recovery Reference* for CONFIGURE syntax
 - *Oracle Database Backup and Recovery Reference* for BACKUP syntax
 - *Oracle Database Backup and Recovery Reference* to learn about the substitution variable %F
-

8.8 About RMAN Incremental Backups

An incremental backup copies only those data blocks that have changed since a previous backup. You can use RMAN to create incremental backups of data files, tablespaces, or the whole database.

By default, RMAN makes full backups. A [full backup](#) of a data file includes every allocated block in the file being backed up. A full backup of a data file can be an image copy, in which case every data block is backed up. It can also be stored in a backup set, in which case data file blocks not in use may be skipped.

A full backup has no effect on subsequent incremental backups. Image copies are always full backups because they include every data block in a data file. A backup set is by default a full backup because it can potentially include every data block in a data file, although [unused block compression](#) means that blocks never used are excluded and, in some cases, currently unused blocks are excluded (see "[About RMAN Block Compression for Backup Sets](#) (page 8-4)").

A full backup cannot be part of an incremental backup strategy; that is, it cannot be the parent for a subsequent incremental backup.

See Also:

- [About Multilevel Incremental Backups](#) (page 8-17)
 - [About the Incremental Backup Algorithm](#) (page 8-20)
-

8.8.1 About Multilevel Incremental Backups

RMAN can create multilevel incremental backups. Each incremental level is denoted by a value of 0 or 1.

A [level 0 incremental backup](#), which is the base for subsequent incremental backups, copies all blocks containing data. The only difference between a level 0 incremental backup and a full backup is that a full backup is never included in an incremental strategy. Thus, an incremental level 0 backup is a full backup that happens to be the parent of incremental backups whose level is greater than 0.

A level 1 incremental backup can be either of the following types:

- A [differential incremental backup](#), which backs up all blocks changed after the most recent incremental backup at level 1 or 0

See [About Differential Incremental Backups](#) (page 8-18).

- A **cumulative incremental backup**, which backs up all blocks changed after the most recent incremental backup at level 0
See [About Cumulative Incremental Backups](#) (page 8-19).

Incremental backups are differential by default.

Incremental backups at level 0 can be either backup sets or image copies, but incremental backups at level 1 can only be backup sets.

Note:

Cumulative backups are preferable to differential backups when recovery time is more important than disk space, because fewer incremental backups must be applied during recovery.

The size of the backup file depends solely upon the number of blocks modified, the incremental backup level, and the type of incremental backup (differential or cumulative).

8.8.1.1 About Differential Incremental Backups

In a differential level 1 backup, RMAN backs up all blocks that have changed since the most recent incremental backup at level 1 (cumulative or differential) or level 0.

For example, in a differential level 1 backup, RMAN determines which level 1 backup occurred most recently and backs up all blocks modified after that backup. If no level 1 is available, then RMAN copies all blocks changed since the base level 0 backup.

If no level 0 backup is available in either the current or parent **incarnation**, then the behavior varies with the compatibility mode setting. If compatibility is $\geq 10.0.0$, RMAN copies all blocks that have been changed since the file was created. Otherwise, RMAN generates a level 0 backup.

Figure 8-2 Differential Incremental Backups

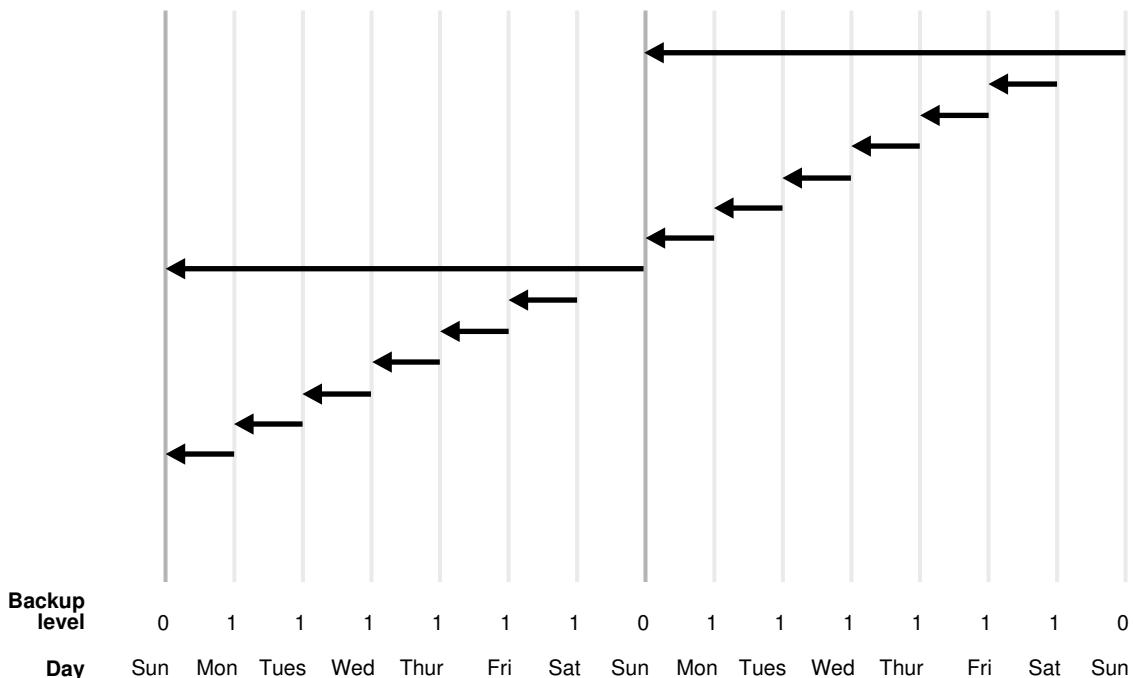

In the example shown in [Figure 8-2](#) (page 8-18), the following activity occurs each week:

- Sunday
An incremental level 0 backup backs up *all* blocks that have ever been in use in this database.
- Monday through Saturday
On each day from Monday through Saturday, a differential incremental level 1 backup backs up all blocks that have changed since the most recent incremental backup at level 1 or 0. The Monday backup copies blocks changed since Sunday level 0 backup, the Tuesday backup copies blocks changed since the Monday level 1 backup, and so forth.

8.8.1.2 About Cumulative Incremental Backups

In a cumulative level 1 backup, RMAN backs up all blocks used since the most recent level 0 incremental backup in either the current or parent incarnation.

Cumulative incremental backups reduce the work needed for a restore operation by ensuring that you only need one incremental backup from any particular level. Cumulative backups require more space and time than differential backups because they duplicate the work done by previous backups at the same level.

In the example shown in [Figure 8-3](#) (page 8-20), the following occurs each week:

- Sunday
An incremental level 0 backup backs up *all* blocks that have ever been in use in this database.
- Monday - Saturday
A cumulative incremental level 1 backup copies all blocks changed since the most recent level 0 backup. Because the most recent level 0 backup was created on Sunday, the level 1 backup on each day Monday through Saturday backs up all blocks changed since the Sunday backup.

See Also:

[Making and Updating RMAN Incremental Backups](#) (page 9-33)

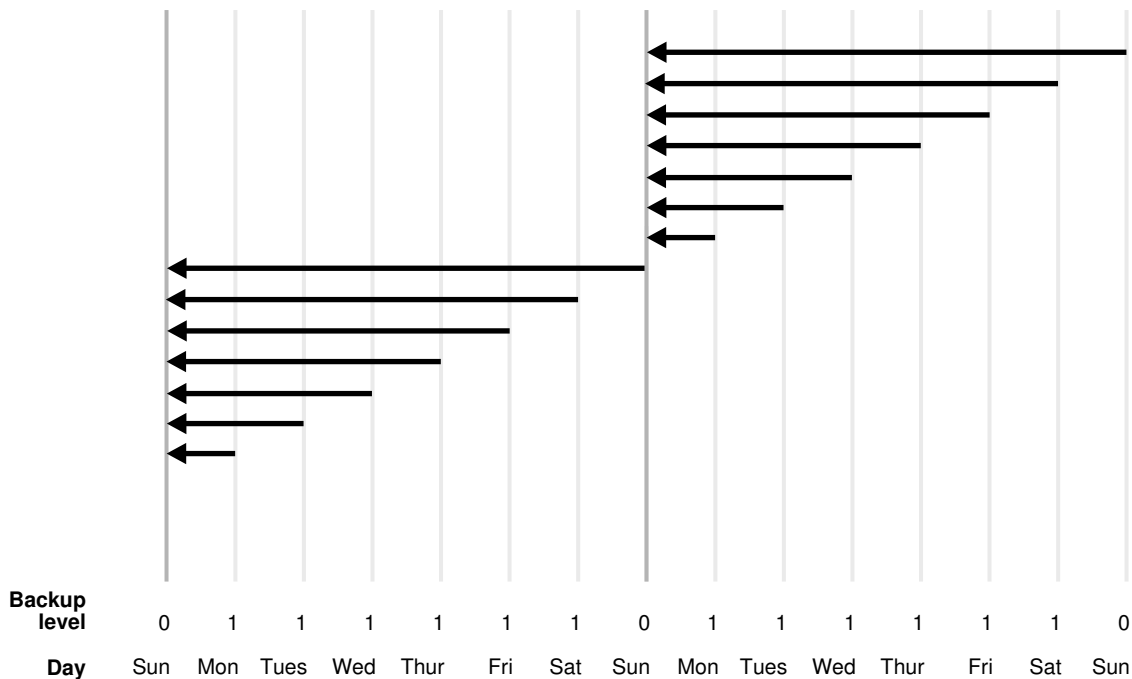
Figure 8-3 Cumulative Incremental Backups

8.8.2 About Block Change Tracking

The block change tracking feature for incremental backups improves incremental backup performance by recording changed blocks in each data file in a block change tracking file.

The block change tracking file is a small binary file stored in the [database area](#). RMAN tracks changed blocks as redo is generated.

If block change tracking is enabled, then RMAN uses the change tracking file to identify changed blocks for incremental backups, thus avoiding the need to scan every block in the data file. RMAN only uses block change tracking when the incremental level is greater than 0, because a [level 0 incremental backup](#) includes all blocks.

See Also:

[Using Block Change Tracking to Improve Incremental Backup Performance](#)
(page 9-40)

8.8.3 About the Incremental Backup Algorithm

The following concepts are essential for understanding the algorithm that RMAN uses to make incremental backups:

- Checkpoint SCN

Every data file has a [data file checkpoint SCN](#), which you can view in `V $DATAFILE.CHECKPOINT_CHANGE#`. All changes with an SCN *lower* than this SCN are guaranteed to be in the file. When a level 0 incremental backup is restored, the restored data file contains the checkpoint SCN that it had when the level 0 was created. When a level 1 incremental backup is applied to a file, the

checkpoint SCN of the file is advanced to the checkpoint SCN that the file had when the incremental level 1 backup was created.

- Incremental start SCN

This SCN applies only to level 1 incremental backups. All blocks whose SCN is greater than or equal to the incremental start SCN are included in the backup. Blocks whose SCN is lower than the incremental start SCN are not included in the backup. The incremental start SCN is most often the checkpoint SCN of the parent of the level 1 backup.

- Block SCN

Every data block in a data file records the SCN at which the most recent change was made to the block.

When RMAN makes a level 1 incremental backup of a file, RMAN reads the file, examines the SCN of every block, and backs up blocks whose SCN is greater than or equal to the incremental start SCN for this backup. If the backup is differential, then the incremental start SCN is the checkpoint SCN of the most recent level 1 backup. If the backup is cumulative, then the incremental start SCN is the checkpoint SCN of the most recent level 0 backup.

When block change tracking is enabled, RMAN uses bitmaps to avoid reading blocks that have not changed during the range from incremental start SCN to checkpoint SCN. RMAN still examines every block that is read and uses the SCN in the block to decide which blocks to include in the backup.

One consequence of the incremental backup algorithm is that RMAN applies all blocks containing changed data during recovery, even if the change is to an object created with the `NOLOGGING` option. Thus, if you restore a backup made before `NOLOGGING` changes were made, then incremental backups are the only way to recover these changes.

8.8.4 About Recovery with Incremental Backups

During media recovery, RMAN examines the restored files to determine whether it can recover them with an incremental backup. If it has a choice, then RMAN always chooses incremental backups over archived redo logs because applying changes at a block level is faster than applying redo.

RMAN does not need to restore a base incremental backup of a data file to apply incremental backups to the data file during recovery. For example, you can restore data file image copies and recover them with incremental backups.

See Also:

[About Selection of Incremental Backups and Archived Redo Logs](#) (page 14-7)

8.8.5 About the Incremental-Forever Backup Strategy for Recovery Appliance

The incremental-forever backup strategy eliminates the need for creating recurring full backups when backing up to Zero Data Loss Recovery Appliance (Recovery Appliance). Although Recovery Appliance supports other RMAN backup strategies, the recommended method for ongoing backups is the incremental-forever backup strategy.

With the incremental-forever backup strategy, you need to create only one initial level 0 full backup and subsequent level 1 incremental backups. The initial backup and the subsequent incrementals must be RMAN backup sets and not image copies.

Note that the Recovery Appliance incremental-forever backup strategy is different from the incrementally updated backup strategy in a conventional RMAN setup. With RMAN, incrementally updated backups use an initial image copy, followed by incremental backups which are eventually merged into the full backup. Therefore, there is always at least one full image copy, a few incremental backups, and some archived redo logs.

See Also:

- [About Real-Time Redo Transport for Recovery Appliance](#) (page 17-2)
 - *Zero Data Loss Recovery Appliance Protected Database Configuration Guide* for information about the incremental-forever backup strategy
-
-

8.9 About Backup Retention Policies

You can use the `CONFIGURE RETENTION POLICY` command to create a persistent and automatic backup retention policy.

When a backup retention policy is in effect, RMAN considers a backup of data files or control files as an [obsolete backup](#), that is, no longer needed for recovery, according to criteria specified in the `CONFIGURE` command. You can use the `REPORT OBSOLETE` command to view obsolete files and the `DELETE OBSOLETE` command to delete them.

As you produce backups over time, older backups become obsolete as they are no longer needed to satisfy the retention policy. RMAN can identify the obsolete files for you, but it does not automatically delete them. You must use the `DELETE OBSOLETE` command to delete files that are no longer needed to satisfy the retention policy.

If a fast recovery area is configured, then the database automatically deletes files that are either obsolete or backed up to tape when more recovery area space is needed for new files. The disk quota rules are distinct from the retention policy rules, but the database never deletes files in violation of the retention policy to satisfy the disk quota. Refer to "[Responding to a Full Fast Recovery Area](#) (page 12-9)".

A backup is obsolete when `REPORT OBSOLETE` or `DELETE OBSOLETE` determines, based on the user-defined retention policy, that it is not needed for recovery. A backup is considered an [expired backup](#) only when RMAN performs a crosscheck and cannot find the file. In short, *obsolete* means a file is not needed, whereas *expired* means it is not found.

A backup retention policy applies only to full or level 0 data file and control file backups. For data file copies and proxy copies, if RMAN determines that the copy or proxy copy is not needed, then the copy or proxy copy can be deleted. For data file backup sets, RMAN cannot delete the backup set until all data file backups within the backup set are obsolete.

The retention policy is not responsible for deleting or rendering obsolete archived redo logs and incremental level 1 backups. Rather, these files become obsolete when no full backups exist that need them. Besides affecting full or level 0 data file and control file backups, the retention policy affects archived redo logs and level 1 incremental backups. First, RMAN decides which data file and control file backups are obsolete. Then, RMAN considers as obsolete all archived logs and incremental level 1 backups

that are not needed to recover the oldest data file or control file backup that must be retained.

Note:

RMAN cannot implement an automatic retention policy if backups are deleted by non-RMAN techniques, for example, through the media manager's tape retention policy. The media manager must never expire a tape until all RMAN backups on that tape have been removed from the media manager's catalog.

There are two mutually exclusive options for implementing a retention policy: [redundancy](#) and [recovery window](#).

This section contains the following topics:

- [About the Recovery Window](#) (page 8-23)
- [About Backup Redundancy](#) (page 8-25)
- [About Batch Deletes of Obsolete Backups](#) (page 8-25)
- [About Backup Retention Policy and Fast Recovery Area Deletion Rules](#) (page 8-26)

8.9.1 About the Recovery Window

A recovery window is a period that begins with the current time and extends backward in time to the point of recoverability. The point of recoverability is the earliest time for a hypothetical point-in-time recovery, that is, the earliest point to which you can recover following a media failure.

For example, if you implement a recovery window of 1 week, then RMAN retains full backups and required incremental backups and archived logs so that the database can be recovered up to 7 days in the past. You implement this retention policy as follows:

```
CONFIGURE RETENTION POLICY TO RECOVERY WINDOW OF 7 DAYS;
```

This command ensures that for each data file, one backup that is older than the point of recoverability is retained. For example, if the recovery window is 7, then there must always exist one backup of each data file that satisfies the following condition:

```
SYSDATE - BACKUP CHECKPOINT TIME >= 7
```

All backups older than the most recent backup that satisfied this condition are obsolete.

Assume the retention policy illustrated in [Figure 8-4](#) (page 8-24). The retention policy has the following aspects:

- The recovery window is 7 days.
- Database backups are scheduled every two weeks on these days:
 - January 1
 - January 15
 - January 29

- February 12

- The database runs in ARCHIVELOG mode, and archived logs are saved on disk only if needed for the retention policy.

Figure 8-4 Recovery Window, Part 1

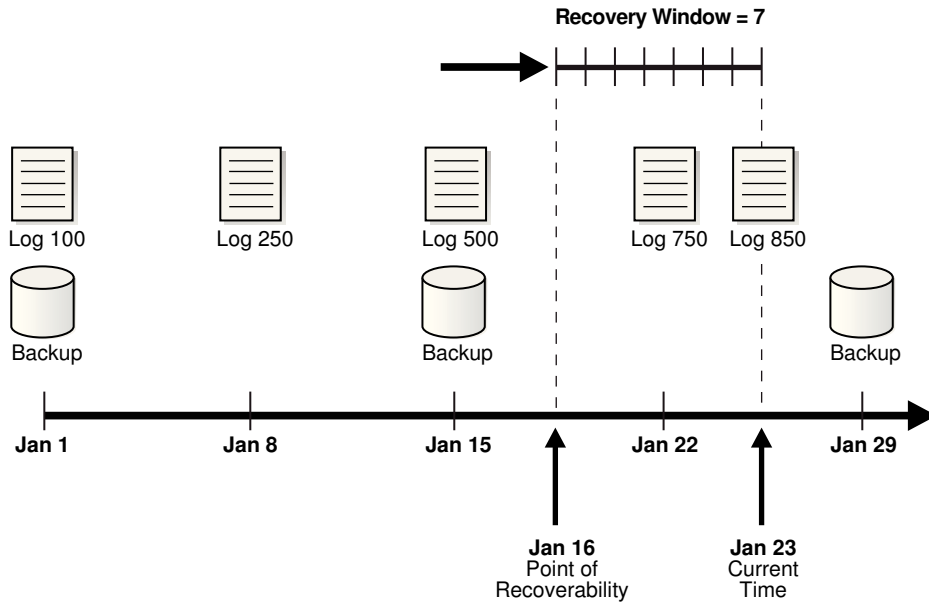

As illustrated in [Figure 8-4](#) (page 8-24), the current time is January 23 and the point of recoverability is January 16. Hence, the January 15 backup is needed for recovery, and so are the archived logs from log sequence 500 through 850. The logs before 500 and the January 1 backup are obsolete because they are not needed for recovery to a point within the window.

Assume the same scenario a week later, as depicted in [Figure 8-5](#) (page 8-24).

Figure 8-5 Recovery Window, Part 2

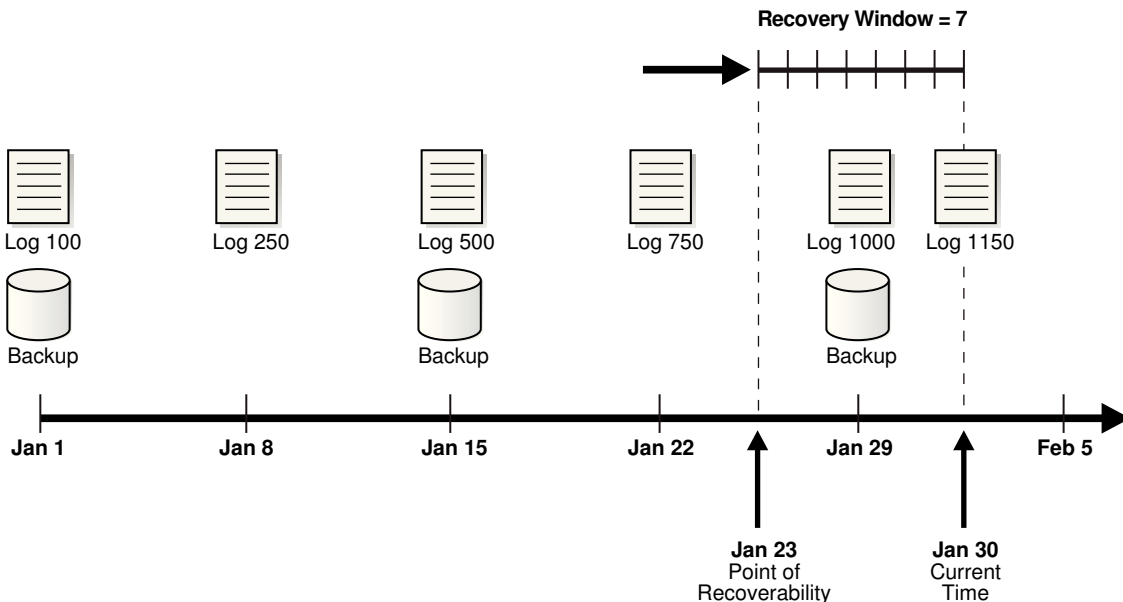

In this scenario, the current time is January 30 and the point of recoverability is January 23. Note how the January 15 backup is *not* obsolete even though a more recent backup (January 29) exists in the recovery window. This situation occurs because restoring the January 29 backup does not enable you to recover to the earliest time in the window, January 23. To ensure recoverability to any point in the window, you must save the January 15 backup and all archived logs from sequence 500 to 1150.

See Also:

[Configuring a Recovery Window-Based Retention Policy](#) (page 5-30)

8.9.2 About Backup Redundancy

In some cases using a recovery window can complicate disk space planning because the number of backups that must be retained is not constant and depends on the backup schedule. In contrast, a redundancy-based retention policy specifies how many backups of each data file must be retained.

For example, you can configure a redundancy of 2 as follows:

```
CONFIGURE RETENTION POLICY TO REDUNDANCY 2;
```

The default retention policy is configured to REDUNDANCY 1.

See Also:

[Configuring a Redundancy-Based Retention Policy](#) (page 5-30)

8.9.3 About Batch Deletes of Obsolete Backups

You can run the `REPORT OBSOLETE` command to determine which backups are currently obsolete according to the retention policy.

A companion command, `DELETE OBSOLETE`, deletes all files that are obsolete according to the retention policy. You can run `DELETE OBSOLETE` periodically to minimize space wasted by storing obsolete backups. For example, you can run `DELETE OBSOLETE` in a weekly script.

You can also override the configured retention policy by specifying the `REDUNDANCY` or `RECOVERY WINDOW` options on the `REPORT` or `DELETE` commands. Using `DELETE OBSOLETE` with a recovery window shorter than the configured recovery window effectively reduces the window of recoverability. For example, if the configured window is 14 days, but you execute `DELETE OBSOLETE RECOVERY WINDOW OF 7 DAYS`, then you no longer have the ability to recover to a time between 7 and 14 days ago.

See Also:

- [Reporting on RMAN Operations](#) (page 11-1) to learn how to generate reports and delete backups
 - *Oracle Database Backup and Recovery Reference* for `DELETE` syntax
 - *Oracle Database Backup and Recovery Reference* for `REPORT` syntax
-

8.9.4 About Backup Retention Policy and Fast Recovery Area Deletion Rules

If you configure a fast recovery area, then the database uses an internal algorithm to select files in the fast recovery area that are no longer needed to meet the configured retention policy.

The retention policy is never violated when determining which files to delete from the fast recovery area to satisfy the disk quota rules. These backups have status `OBSOLETE` and are eligible for deletion to satisfy the [disk quota](#) rules.

The RMAN status `OBSOLETE` is always determined in reference to a retention policy. For example, if a database backup is considered `OBSOLETE` in the RMAN repository, then it is because it is either not needed for recovery to a point within the recovery window, or it is redundant.

There is one important difference between the fast recovery area rules for `OBSOLETE` status and the disk quota rules for deletion eligibility. Assume that archived logs 1000 through 2000, which are on disk, are needed for the current recovery window and so are not obsolete. If you back up these logs to tape, then the retention policy considers the disk logs as required, that is, not obsolete. Nevertheless, the fast recovery area disk quota algorithm considers the logs on disk as eligible for deletion because they have been backed up to tape. The logs on disk do not have `OBSOLETE` status in the repository, but they are eligible for deletion by the fast recovery area.

See Also:

[Deletion Rules for the Fast Recovery Area](#) (page 12-7)

Backing Up the Database

This chapter explains how to perform the most basic backup tasks and implement backup strategies using RMAN. This chapter contains the following topics:

- [Overview of RMAN Backups](#) (page 9-1)
- [Specifying Backup Output Options](#) (page 9-2)
- [Backing Up Database Files with RMAN](#) (page 9-10)
- [Backing Up CDBs and PDBs](#) (page 9-15)
- [Backing Up Application Containers](#) (page 9-20)
- [Backing Up Sparse Databases with RMAN](#) (page 9-22)
- [Backing Up Archived Redo Logs with RMAN](#) (page 9-27)
- [Making and Updating RMAN Incremental Backups](#) (page 9-33)
- [Making Database Backups for Long-Term Storage](#) (page 9-44)
- [Backing Up RMAN Backups](#) (page 9-48)

See Also:

- [Backing Up the Database: Advanced Topics](#) (page 10-1) to learn about more advanced topics such as backup optimization, duplexing, backup encryption, and restartable backups
 - *Oracle Data Guard Concepts and Administration* to learn how to perform RMAN backup and recovery in a Data Guard environment
-

9.1 Overview of RMAN Backups

RMAN backups are created using the `BACKUP` command.

This section provides an overview of RMAN backups.

9.1.1 Purpose of RMAN Backups

The primary purpose of RMAN backups is to protect your data. If a media failure or disaster occurs, then you can restore your backups and recover lost changes.

You can also make backups to preserve data for long-time archival, as explained in "[Making Database Backups for Long-Term Storage](#) (page 9-44)", and to transfer data, as explained in the chapters included in [Transferring Data with RMAN](#) (page 1).

9.1.2 Basic Concepts of RMAN Backups

You can back up all or part of your database with the `BACKUP` command from within the RMAN client.

In many cases, after your database has been configured in accordance with your backup strategy, you can back up the database by entering the following command at the RMAN prompt:

```
RMAN> BACKUP DATABASE;
```

RMAN uses the configured settings, the records of previous backups, and the control file record of the database structure to determine an efficient set of steps for the backup. RMAN then performs these steps.

As explained in "[About RMAN File Management in a Data Guard Environment](#) (page 3-9)", you can run RMAN backups at any database in a Data Guard environment. Any backup of any database in the environment is usable for recovery of any other database if the backup is accessible. You can offload all backups of database files, including control file backups, to a [physical standby database](#) and thereby avoid consuming resources on the primary database.

See Also:

- *Oracle Database Backup and Recovery Reference* to learn about the `BACKUP` command
 - *Oracle Data Guard Concepts and Administration* to learn how to back up a standby database with RMAN
-
-

9.2 Specifying Backup Output Options

You can provide arguments to the `BACKUP` command to override the default backup options.

If you specify only the minimum required options for an RMAN command such as `BACKUP DATABASE`, then RMAN automatically determines the destination device, locations for backup output, and a backup tag based on your configured environment and built-in RMAN defaults.

The most typical backup options are described in the following sections:

- [Specifying the Device Type for an RMAN Backup](#) (page 9-3)
- [Specifying Backup Set or Copy for an RMAN Backup to Disk](#) (page 9-3)
- [Specifying a Format for RMAN Backups](#) (page 9-4)
- [Specifying Tags for an RMAN Backup](#) (page 9-5)
- [Making Compressed Backups](#) (page 9-7)
- [Specifying Multisection Incremental Backups](#) (page 9-8)
- [Making Multisection Backups Using Image Copies](#) (page 9-9)

See Also:

[Backing Up the Database: Advanced Topics](#) (page 10-1) to learn about advanced backup options such as duplexing and restarting backups

9.2.1 Specifying the Device Type for an RMAN Backup

The `BACKUP` command takes a `DEVICE TYPE` clause that specifies whether to back up to disk or tape device.

When you run `BACKUP` without a `DEVICE TYPE` clause, RMAN stores the backup on the configured default device (disk or `SBT`). You set the default device with the `CONFIGURE DEFAULT DEVICE TYPE` command.

Example 9-1 Specifying Device Type DISK

This example illustrates a backup to disk.

```
BACKUP
  DEVICE TYPE DISK
  DATABASE;
```

See Also:

[Configuring the Default Device for Backups: Disk or SBT](#) (page 5-3) for information about configuring the default device

9.2.2 Specifying Backup Set or Copy for an RMAN Backup to Disk

RMAN can create backups on disk as image copies or as backup sets.

"[Configuring the Default Type for Backups: Backup Sets or Copies](#) (page 5-4)" explains how to configure the default disk device. You can override this default with the `AS COPY` or `AS BACKUPSET` clauses.

Example 9-2 Making Image Copies

This example uses `BACKUP AS COPY` to back up to disk as image copies.

```
BACKUP AS COPY
  DEVICE TYPE DISK
  DATABASE;
```

Example 9-3 Making Backup Sets

To back up your data into backup sets, use the `AS BACKUPSET` clause. This example illustrates how you can allow backup sets to be created on the configured default device, or direct them specifically to disk or tape.

```
BACKUP AS BACKUPSET
  DATABASE;

BACKUP AS BACKUPSET
  DEVICE TYPE DISK
  DATABASE;

BACKUP AS BACKUPSET
  DEVICE TYPE SBT
  DATABASE;
```

9.2.3 Specifying a Format for RMAN Backups

RMAN provides a range of options to name the files generated by the `BACKUP` command.

RMAN uses the following set of rules to determine the format of the output files, which are listed in order of precedence:

1. If a `FORMAT` parameter is specified on the `BACKUP` command, then this setting controls the generated file name.

For example, you can direct the output to a specific location, as shown in the following command:

```
BACKUP DATABASE
  FORMAT '/disk1/backup_%U'; # specifies a location on the file system
```

In this case, backups are stored with generated unique file names with the prefix `/disk1/backup_`. The `%U` substitution variable, used to generate a unique string at this point in the file name, is required.

You can also use the `FORMAT` parameter to name an ASM disk group as the backup destination, as shown in the following example:

```
BACKUP DATABASE
  FORMAT '+dgroup1'; # specifies an ASM disk group
```

No `%U` is required in this case because [Automatic Storage Management \(ASM\)](#) generates unique file names as needed. However, you can specify `%U` if desired.

Note:

If you specify `FORMAT` when a fast recovery area is enabled, then RMAN obeys the `FORMAT` setting. If no location is specified in the `FORMAT` clause, then RMAN creates the backup in a platform-specific location.

2. If a `FORMAT` setting is configured for the specific channel used for the backup, then this setting controls the generated file name.
3. If a `FORMAT` setting is configured for the device type used for the backup, then this setting controls the generated file name.
4. If a [fast recovery area](#) is enabled during a disk backup, and if `FORMAT` is not specified, then RMAN creates the backup with an automatically generated name in the fast recovery area.
5. If no other conditions in this list apply, then the default location and file name format of the backup are platform-specific.

See Also:

Oracle Database Backup and Recovery Reference to learn about the `FORMAT` clause, and the installation guides in the Oracle Database documentation library to learn about the default file locations for your platform

9.2.3.1 Specifying Multiple Formats for Disk Backups

When backing up to disk, you can specify a format to spread the backup across several drives for improved performance.

- To back up a database to multiple disk drives, allocate one DISK channel for each disk drive and specify the format string on the ALLOCATE CHANNEL command so that the file names are on different disks.

```
RUN
{
  ALLOCATE CHANNEL disk1 DEVICE TYPE DISK FORMAT '/disk1/%d_backups/%U';
  ALLOCATE CHANNEL disk2 DEVICE TYPE DISK FORMAT '/disk2/%d_backups/%U';
  ALLOCATE CHANNEL disk3 DEVICE TYPE DISK FORMAT '/disk3/%d_backups/%U';
  BACKUP AS COPY DATABASE;
}
```

- To create a default configuration that distributes backups to multiple disk drives by default, configure multiple disk channels.

```
CONFIGURE DEVICE TYPE DISK PARALLELISM 3;
CONFIGURE DEFAULT DEVICE TYPE TO DISK;
CONFIGURE CHANNEL 1 DEVICE TYPE DISK FORMAT '/disk1/%d_backups/%U';
CONFIGURE CHANNEL 2 DEVICE TYPE DISK FORMAT '/disk2/%d_backups/%U';
CONFIGURE CHANNEL 3 DEVICE TYPE DISK FORMAT '/disk3/%d_backups/%U';
BACKUP AS COPY DATABASE;
```

Typically, you do not need to specify a format when backing up to tape because the default %U variable generates a unique file name for tape backups.

9.2.4 Specifying Tags for an RMAN Backup

RMAN attaches a character string called a tag to every backup it creates, as a way of identifying the backup. You can either accept the default tag or specify your own with the TAG parameter of the BACKUP command.

This section contains the following topics:

- [About Backup Tags](#) (page 9-5)
- [Specifying Tags for Backup Sets and Image Copies](#) (page 9-6)

9.2.4.1 About Backup Tags

User-specified tags are a useful way to indicate the purpose or usage of different classes of backups or copies.

You can tag backup sets, proxy copies, data file copies, or control file copies. For example, you can tag data file copies that you intend to use in a SWITCH command as `for_switch_only` and file copies to use only for a RESTORE command as `for_restore_only`.

Tags do not need to be unique, so multiple backup sets or image copies can have the same tag (for example, `weekly_backup`). Assume that you specify that a data file be restored from backups that have a specific tag. If multiple backups of the requested file have the desired tag, then RMAN restores the most recent backup that has the desired tag, within any constraints on the RESTORE command.

In practice, tags are often used to distinguish a series of backups created as part of a single strategy, such as an incremental backup strategy. For example, you might create a weekly incremental backup with a tag like `BACKUP TAG weekly_incremental`.

Many forms of the BACKUP command let you associate a tag with a backup, and many RESTORE and RECOVER commands let you specify a tag to restrict which backups to use in the RESTORE or RECOVER operation.

If you do not explicitly specify a tag with the TAG parameter of the BACKUP command, then RMAN implicitly creates a default tag for backups (except for control file autobackups). The format of the tag is TAGYYYYMMDDTHHMMSS, where YYYY is the year, MM is the month, DD is the day, HH is the hour (in 24-hour format), MM is the minutes, and SS is the seconds. For example, a backup of data file 1 may get the tag TAG20070208T133437. The date and time refer to when RMAN started the backup in the time zone of the instance performing the backup. If multiple backup sets are created by one BACKUP command, then each backup piece has the same default tag.

Tags are stored in uppercase, regardless of the case used when entering them. The maximum length of a backup tag is 30 bytes. Tags cannot use operating system environment variables or use special formats such as %T or %D.

See Also:

Oracle Database Backup and Recovery Reference for the default format description in BACKUP . . . TAG

9.2.4.2 Specifying Tags for Backup Sets and Image Copies

Use the TAG parameter with the BACKUP command to specify tags for backup sets and image copies.

The characters in a tag must be limited to the characters that are legal in file names on the target database file system. For example, [Automatic Storage Management \(ASM\)](#) does not support the use of the hyphen (-) in the file names it uses internally, so a tag including a hyphen (such as weekly-incr) is not a legal tag name for backups in ASM disk groups.

When you tag a backup set, the tag is an attribute of each backup piece in a given copy of a backup set. If you create a [multiplexed backup set](#), then each copy of the backup set is assigned the same tag.

Example 9-4 Applying a Tag to a Backup Set

This example creates one backup set with the tag MONDAYBKP.

```
BACKUP AS BACKUPSET
  COPIES 1
  DATAFILE 7
  TAG mondaybkp;
```

Example 9-5 Applying Tags to Image Copies

This example shows that copies of data files in tablespaces users and tools are assigned the tag MONDAYCPY. When you specify a tag for image copies, the tag applies to each individual copy.

```
BACKUP AS COPY
  TABLESPACE users, tools
  TAG mondaycpy;
```

Example 9-6 Assigning Tags to Output Copies

This example creates new copies of all image copies of the database that have the tag `full_cold_copy` and gives the new copies the tag `new_full_cold_copy`. You can use `FROM TAG` to copy an image copy with a specific tag, and then use `TAG` to assign the output copy a different tag.

```
BACKUP AS COPY
  COPY OF DATABASE
    FROM TAG full_cold_copy
  TAG new_full_cold_copy;
```

9.2.5 Making Compressed Backups

When creating backup sets, you can use RMAN support for binary compression of backup sets by including the `AS COMPRESSED BACKUPSET` option to the `BACKUP` command.

RMAN compresses the backup set contents before writing them to disk. The details of which binary compression level is used are automatically recorded in the backup set. There is no need to explicitly mention the type of compression used or how to decompress the backup set in the recovery operation.

Binary compression creates some performance overhead during backup and restore operations. Binary compression consumes CPU resources, so do not routinely schedule compressed backups when CPU usage is high. However, the following circumstances may warrant paying the performance penalty:

- You are using disk-based backups when disk space in your fast recovery area or other disk-based backup destination is limited.
- You are performing your backups to some device over a network when reduced network bandwidth is more important than CPU usage.
- You are using some archival backup media such as CD or DVD, where reducing backup sizes saves on media costs and archival storage.

See Also:

- [About Binary Compression for RMAN Backup Sets](#) (page 8-5)
- `AS COMPRESSED BACKUPSET` option of the `BACKUP` command in *Oracle Database Backup and Recovery Reference* for performance details regarding backup sets

Example 9-7 Making Compressed Backups

This example backs up the entire database and archived logs to the configured default backup destination (disk or tape), producing compressed backup sets.

```
BACKUP
  AS COMPRESSED BACKUPSET
  DATABASE PLUS ARCHIVELOG;
```

9.2.6 Specifying Multisection Incremental Backups

A multisection backup enables large data files to be divided into sections that can be backed up in parallel across multiple channels. This provides faster backup performance and better recovery times.

A multisection backup contains multiple backup pieces. During a multisection backup operation, RMAN writes to each backup piece, in parallel, by using a separate channel for each backup piece.

Multisection full backups of databases and data files are supported starting with Oracle Database 11g Release 1. Starting with Oracle Database 12c Release 1 (12.1), RMAN supports multisection incremental backups. Wherever applicable, RMAN also uses [unused block compression](#) and [block change tracking](#) while creating multisection incremental backups. When backup sets are used, you can create multisection full or incremental backups.

To create level 0 multisection incremental backups, the `COMPATIBLE` parameter must be set to 11.0 or higher. However, to create multisection incremental backups of level 1 or higher, you must set the `COMPATIBLE` parameter to 12.0.0 or higher. RMAN always creates multisection incremental backups with `FILESPESET` set to 1.

Use the `SECTION SIZE` clause of the `BACKUP` command to create multisection backups. The `SECTION SIZE` clause specifies the size of each backup section. If you specify a section size that is larger than the size of the file, then RMAN does not use multisection backups for that file. If you specify a small section size that would produce more than 256 sections, then RMAN increases the section size to a value that results in exactly 256 sections.

Views to Identify Multisection Backups

Use the `MULTI_SECTION` column of the `V$BACKUP_SET` view or the recovery catalog view `RC_BACKUP_SET` to determine if a backup is a multisection backup. For multisection backups, the `MULTI_SECTION` column contains YES.

Views That Contain Metadata for Multisection Backups

The `V$BACKUP_DATAFILE` and `RC_BACKUP_DATAFILE` views provide information about the number of blocks in each section of a multisection backup. The `BLOCKS` column specifies the number of blocks in each multisection backup.

Example 9-8 Multisection Incremental Backup of Database as Backup Sets

The following example creates a multisection level 1 incremental backup of the data file as backup sets.

1. Ensure that the initialization parameter `COMPATIBLE` of the target database is set to 12.0.0 or higher.
2. Start RMAN and connect to a target database as a user with the `SYSBACKUP` or `SYSDBA` privilege.

See Also:

[Making Database Connections with RMAN](#) (page 4-2) for information about connecting to a target database

3. If required, configure RMAN to write in parallel to the backup device.

The following example configures RMAN to use two disk channels in parallel.

```
CONFIGURE DEVICE TYPE disk PARALLELISM 2;
```

4. Execute BACKUP with SECTION SIZE to indicate that a multisection backup must be created.

The following example creates a multisection section level 1 backup of the data file users_df.dbf using backup sets. Each backup piece is 100MB.

```
BACKUP
  INCREMENTAL LEVEL 1
  SECTION SIZE 100M
  DATAFILE '/oradata/datafiles/users_df.dbf';
```

See Also:

- [About Unused Block Compression](#) (page 8-5)
 - [Using Block Change Tracking to Improve Incremental Backup Performance](#) (page 9-40)
-
-

9.2.7 Making Multisection Backups Using Image Copies

While an image copy is being created, RMAN uses multiple channels to write files sections. However, the output of this operation is one copy for each data file.

Multisection backups provide better performance by using multiple channels to back up large files in parallel. Starting with Oracle Database 12c Release 1 (12.1), you can create multisection full backups that are stored as image copies.

Use the SECTION SIZE clause to create multisection backups. If the section size that you specify is larger than the size of the file, then RMAN does not use multisection backups for that file. If you specify a small section size that would produce more than 256 sections, then RMAN increases the section size to a value that results in exactly 256 sections

Example 9-9 Multisection Backup of Data File as Image Copies

Use the following steps to create a multisection backup of a database as image copies:

1. Ensure that the COMPATIBLE parameter for the target database is set to 12.0.0 or higher.
2. Start RMAN and connect to a target database as a user with the SYSBACKUP or SYSDBA privilege.
3. If required, configure [channel parallelism](#) so that RMAN can perform the backup operation using multiple drives in parallel.
4. Execute BACKUP with SECTION SIZE and AS COPY to indicate that a multisection backup must be created using image copies.

The following command creates a multisection incremental backup of the entire database using image copies. Each backup piece is 500MB.

```
BACKUP
  AS COPY
```

```
SECTION SIZE 500M  
DATABASE;
```

See Also:

- [Making Database Connections with RMAN](#) (page 4-2) for information about connecting to a target database
 - [Specifying Multisection Incremental Backups](#) (page 9-8) for information about the views that contain information about multisection backups.
-

9.3 Backing Up Database Files with RMAN

This section contains the following topics:

- [Backing Up a Whole Database with RMAN](#) (page 9-10)
- [Backing Up Tablespaces and Data Files with RMAN](#) (page 9-11)
- [Backing Up Control Files with RMAN](#) (page 9-12)
- [Backing Up Server Parameter Files with RMAN](#) (page 9-14)
- [Backing Up a Database in NOARCHIVELOG Mode](#) (page 9-15)

9.3.1 Backing Up a Whole Database with RMAN

You can perform a whole database backup with the database mounted or open.

To perform a [whole database backup](#), from the RMAN prompt, use the `BACKUP DATABASE` command.

You may want to exclude specified tablespaces from a whole database backup. You can persistently skip tablespaces across RMAN sessions by executing the `CONFIGURE EXCLUDE` command for each tablespace that you always want to skip. You can override the configured setting with `BACKUP . . . NOEXCLUDE`.

To back up the database:

1. Start RMAN and connect to a target database and a recovery catalog (if used) as described in [Making Database Connections with RMAN](#) (page 4-2).
2. Ensure that the database is mounted or open.
3. Issue the `BACKUP DATABASE` command at the RMAN prompt.

The simplest form of the command requires no options or parameters:

```
BACKUP DATABASE;
```

The list of files backed up depends on the keyword used with the `BACKUP` command.

The following example backs up the database, switches the online redo logs, and includes archived logs in the backup:

```
BACKUP DATABASE PLUS ARCHIVELOG;
```

By archiving the logs immediately after the backup, you ensure that you have a full set of archived logs through the time of the backup. In this way, you guarantee that you can perform media recovery after restoring this backup.

See Also:

- *Oracle Database Backup and Recovery Reference* to learn about the `BACKUP` command options
 - [Skipping Offline, Read-Only, and Inaccessible Files](#) (page 10-7) to learn how to use `BACKUP . . . SKIP` to skip inaccessible data files or data files that are in offline or read-only tablespaces
 - [Configuring Tablespaces for Exclusion from Whole Database Backups](#) (page 6-6) for information about excluding tablespaces from a whole database backup
-
-

9.3.2 Backing Up Tablespaces and Data Files with RMAN

You can back up one or more tablespaces with the `BACKUP TABLESPACE` command or one or more data files with the `BACKUP DATAFILE` command.

When you specify tablespaces, RMAN translates the tablespace name internally into a list of data files. The database can be mounted or open. Tablespaces can be read/write or read-only.

Note:

Transportable tablespaces do not have to be in read/write mode for backup as in previous releases.

RMAN automatically backs up the control file and the server parameter file (if the instance was started with a server parameter file) when data file 1 is included in the backup. If [control file autobackup](#) is enabled, then RMAN writes the current control file and server parameter file to a separate autobackup piece. Otherwise, RMAN includes these files in the backup set that contains data file 1.

To back up tablespaces or data files:

1. Start RMAN and connect to a target database and a recovery catalog (if used).

See Also:

[Making Database Connections with RMAN](#) (page 4-2) for information about connecting to a target database

2. If the database instance is not started, then either mount or open the database.
3. Run the `BACKUP TABLESPACE` command or `BACKUP DATAFILE` command at the RMAN prompt.

The following example backs up the `users` and `tools` tablespaces to tape:

```
BACKUP
  DEVICE TYPE sbt
  TABLESPACE users, tools;
```

The following example uses an SBT channel to back up data files 1 through 4 and a data file copy stored at `/tmp/system01.dbf` to tape:

```
BACKUP
  DEVICE TYPE sbt
  DATAFILE 1,2,3,4
  DATAFILECOPY '/tmp/system01.dbf';
```

9.3.3 Backing Up Control Files with RMAN

You can back up the control file when the database is mounted or open. RMAN uses a snapshot control file to ensure a read-consistent version.

If the `CONFIGURE CONTROLFILE AUTOBACKUP` command is set to ON (by default it is OFF), then RMAN automatically backs up the control file and server parameter file after every backup and after database structural changes. The [control file autobackup](#) contains metadata about the previous backup, which is crucial for [disaster recovery](#).

Note:

You can restore a backup of a control file made on one Data Guard database to any other database in the environment. Primary and standby control file backups are interchangeable. See *Oracle Data Guard Concepts and Administration* to learn how to use RMAN to restore files on a standby database.

If the autobackup feature is not set, then you must manually back up the control file in one of the following ways:

- Run `BACKUP CURRENT CONTROLFILE`.
- Include a backup of the control file within any backup by using the `INCLUDE CURRENT CONTROLFILE` option of the `BACKUP` command.
- Back up data file 1, because RMAN automatically includes the control file and server parameter file in backups of data file 1.

Note:

If the control file block size is different from the block size for data file 1, then the control file cannot be written into the same backup set as the data file. RMAN writes the control file into a backup set by itself if the block size is different. The `V$CONTROLFILE.BLOCK_SIZE` column indicates the control file block size, whereas the `DB_BLOCK_SIZE` initialization parameter indicates the block size of data file 1.

9.3.3.1 About Manual Backups of the Control File

A manual backup of the control file is different from a control file autobackup. RMAN makes a control file autobackup after the files specified in the `BACKUP` command are backed up.

Thus, the autobackup—unlike a manual control file backup—contains metadata about the backup that just completed. Also, RMAN can automatically restore autobackups without the use of a recovery catalog.

You can make a manual backup of the current control file either as a [backup set](#) or as an [image copy](#). For a backup set, RMAN first creates a snapshot control file for read consistency. You can configure the file name and location of the snapshot control file. A snapshot control file is not needed for an image copy.

In an Oracle Real Application Clusters (Oracle RAC) environment, the following restrictions apply:

- The snapshot control file location must be on shared storage—that is, storage that is accessible by all Oracle RAC instances.
- The destination of an image copy of the current control file must be shared storage.

See Also:

- [Configuring the Snapshot Control File Location](#) (page 6-14)
 - [Making a Manual Backup of the Control File](#) (page 9-13)
-
-

9.3.3.2 Making a Manual Backup of the Control File

To make a manual backup, you can either specify `INCLUDE CURRENT CONTROLFILE` when backing up other files or specify `BACKUP CURRENT CONTROLFILE`.

You can also back up control file copies on disk by specifying the `CONTROLFILECOPY` parameter.

To manually back up the control file:

1. Start RMAN and connect to a target database and a recovery catalog (if used) as described in [Making Database Connections with RMAN](#) (page 4-2).
2. Ensure that the target database is mounted or open.
3. Execute the `BACKUP` command with the desired control file clause.

Example 9-10 Backing Up a Tablespace and Current Control File to Tape

This example backs up tablespace `users` to tape and includes the current control file in the backup:

```
BACKUP DEVICE TYPE sbt
    TABLESPACE users
    INCLUDE CURRENT CONTROLFILE;
```

Example 9-11 Backing Up Current Control File to Fast Recovery Area

This example backs up the current control file to the fast recovery area as a backup set:

```
BACKUP CURRENT CONTROLFILE;
```

RMAN first creates a snapshot control file.

Example 9-12 Backing Up the Current Control File as Image Copy

This example backs up the current control file to the default disk device as an image copy:

```
BACKUP AS COPY
  CURRENT CONTROLFILE
  FORMAT '/tmp/control01.ct1';
```

Example 9-13 Backing Up a Control File Copy

This example backs up the control file copy created in the previous example to tape:

```
BACKUP AS COPY
  CURRENT CONTROLFILE
  FORMAT '/tmp/control01.ct1';
BACKUP DEVICE TYPE sbt
  CONTROLFILECOPY '/tmp/control01.ct1';
```

A snapshot control file is not needed when backing up a control file copy.

If the control file autobackup feature is enabled, then RMAN makes two control file backups in these examples: the explicit backup of the files specified in the `BACKUP` command and the control file and server parameter file autobackup.

See Also:

Oracle Database Backup and Recovery Reference to learn about the `CONFIGURE CONTROLFILE AUTOBACKUP` command

9.3.4 Backing Up Server Parameter Files with RMAN

RMAN automatically backs up the current server parameter file in certain cases. The `BACKUP SPFILE` command backs up the parameter file explicitly. The server parameter file that is backed up is the one currently in use by the instance.

To back up the server parameter file:

1. Start RMAN and connect to a target database and a recovery catalog (if used) as described in [Making Database Connections with RMAN](#) (page 4-2).
2. Ensure that the target database is mounted or open.

The database must have been started with a server parameter file. If the instance is started with a client-side initialization parameter file, then RMAN issues an error if you execute `BACKUP . . . SPFILE`.

3. Execute the `BACKUP . . . SPFILE` command.

The following example backs up the server parameter file to tape:

```
BACKUP DEVICE TYPE sbt SPFILE;
```

See Also:

[Backing Up Control Files with RMAN](#) (page 9-12)

9.3.5 Backing Up a Database in NOARCHIVELOG Mode

You can only back up a database in NOARCHIVELOG mode when the database is closed and in a consistent state.

The script shown in [Example 9-14](#) (page 9-15) puts the database into the correct mode for a consistent, whole database backup and then backs up the database. The script assumes that [control file autobackup](#) is enabled for the database.

You can skip tablespaces, such as read-only tablespaces, but any skipped tablespace that has not been offline or read-only since its last backup is lost if the database has to be restored from a backup.

Example 9-14 Backing Up a Database in NOARCHIVELOG Mode

```
SHUTDOWN IMMEDIATE;
# Start the database in case it suffered instance failure or was
# closed with SHUTDOWN ABORT before starting this script.
STARTUP FORCE DBA;
SHUTDOWN IMMEDIATE;
STARTUP MOUNT;
# this example uses automatic channels to make the backup
BACKUP
  INCREMENTAL LEVEL 0
  MAXSETSIZE 10M
  DATABASE
  TAG 'BACKUP_1';
# Now that the backup is complete, open the database.
ALTER DATABASE OPEN;
```

9.4 Backing Up CDBs and PDBs

Use the BACKUP command to back up multitenant container databases (CDBs) and pluggable databases (PDBs).

This section contains the following topics:

- [About Backing Up CDBs and PDBs](#) (page 9-16)
- [Backing Up a Whole CDB](#) (page 9-16)
- [Backing Up the Root with RMAN](#) (page 9-17)
- [Backing Up the Root with Oracle Enterprise Manager Cloud Control](#) (page 9-17)
- [Backing Up PDBs with RMAN](#) (page 9-18)
- [Backing Up PDBs with Oracle Enterprise Manager Cloud Control](#) (page 9-18)
- [Backing Up Tablespaces and Data Files in a PDB](#) (page 9-19)

Note:

Backups of a **non-CDB** are not usable after the non-CDB is plugged in as a PDB into another CDB.

See Also:

Oracle Database Concepts for an introduction to PDBs

9.4.1 About Backing Up CDBs and PDBs

RMAN and Oracle Enterprise Manager Cloud Control provide full support for backup and recovery in a multitenant environment.

The [multitenant architecture](#) enables an Oracle Database to function as a CDB. You can back up and recover a whole CDB, the [root](#) only, or one or more pluggable databases (PDBs). You can also back up and recover individual tablespaces and data files in a PDB.

You might want to perform nightly backups of the whole multitenant container database (CDB) by using an incremental backup strategy, or you might want to make frequent separate backups of individual PDBs and do less frequent backups of either the whole CDB or of the root.

In terms of the ability to recover from data loss, separately backing up the root and all PDBs, including the CDB seed, is equivalent to backing up the whole CDB. The main difference is in the number of RMAN commands that you must enter and the time to recover. Recovering a whole CDB requires less time than recovering the root plus all PDBs.

If the compatibility parameter for CDBs and PDBs is set to 12.2 or higher, RMAN also enables you to perform sparse backups on your CDB and PDB. These backups copy the latest updates from the delta storage space assigned to each database.

See Also:

[About Sparse Backups](#) (page 8-12) for more information on sparse backups

9.4.2 Backing Up a Whole CDB

Backing up a whole multitenant container database (CDB) is similar to backing up a non-CDB. When you back up a whole CDB, RMAN backs up the root, all the pluggable databases (PDBs), and the archived redo logs.

The `BACKUP` command is used to back up CDBs. You can then recover either the whole CDB, the root only, or one or more PDBs from the CDB backup.

To backup up a whole CDB:

1. Start RMAN and connect to the root as a common user with the `SYSBACKUP` or `SYSDBA` privilege and to a recovery catalog (if used) as described in [Making Database Connections with RMAN](#) (page 4-2).
2. Ensure that the database is mounted or open.
3. Issue the `BACKUP DATABASE` command at the RMAN prompt.

The simplest form of the command requires no options or parameters:

```
BACKUP DATABASE ;
```

The list of files backed up depends on the keyword used with the `BACKUP` command.

The following example backs up the CDB, switches the online redo logs, and includes archived logs in the backup:

```
BACKUP DATABASE PLUS ARCHIVELOG;
```

By archiving the logs immediately after the backup, you ensure that you have a full set of archived logs through the time of the backup. In this way, you guarantee that you can perform media recovery after restoring this backup.

Note:

Proxy PDBs are not backed up while backing up a CDB.

9.4.3 Backing Up the Root with RMAN

You can use RMAN to make a backup of only the root. Because the root contains critical metadata for the whole CDB, Oracle recommends that you back up the root or back up the whole CDB at regular intervals.

To back up the root with RMAN:

1. Start RMAN and connect to the root as a common user with the `SYSPBACKUP` or `SYSDBA` privilege as described in [Connecting as Target to the Root](#) (page 4-8).
2. Enter the following command:

```
BACKUP DATABASE ROOT;
```

9.4.4 Backing Up the Root with Oracle Enterprise Manager Cloud Control

Oracle Enterprise Manager Cloud Control (Cloud Control) can be used to back up the root.

Use the following steps to back up the root with Cloud Control:

1. From the Database Home page, select **Backup & Recovery** from the Availability menu, and then select **Schedule Backup**.
2. If you have not logged in to the database previously, then the Database Login page is displayed. Log in to the database using Named or New credentials and then click **Login**.

Cloud Control displays the Schedule Backup page.

3. From the Customized Backup section, choose **Container Database Root**, and then click **Schedule Customized Backup**.

The Schedule Backup Wizard appears and displays the Options page.

4. Complete the wizard by navigating the remainder of the pages to back up the root. For more information about each page of the wizard, click **Help**.

See Also:

[Accessing the Database Home Page Using Cloud Control](#) (page 1-10)

9.4.5 Backing Up PDBs with RMAN

RMAN enables you to back up one or more PDBs in a CDB using the `BACKUP` command.

There are two approaches to backing up a PDB with RMAN:

- Connect to the root and then use the `BACKUP PLUGGABLE DATABASE` command. This approach enables you to back up multiple PDBs with a single command.

When you connect to the root and back up a PDB, this backup is visible to the root and to that particular PDB but not to the other PDBs.

- Connect to the PDB and use the `BACKUP DATABASE` command. This approach backs up only a single PDB and enables you to use the same commands used for backing up non-CDBs.

Backups created when connected to any PDB are visible when connected to the root.

When you back up individual PDBs, the archived redo logs are not backed up.

To back up one or more PDBs while connected to the root:

1. Start RMAN and connect to the root as a common user with the `SYSBACKUP` or `SYSDBA` privilege as described in [Connecting as Target to the Root](#) (page 4-8).
2. Issue a `BACKUP PLUGGABLE DATABASE` command at the RMAN prompt.

The following example backs up the PDBs `sales` and `hr`:

```
BACKUP PLUGGABLE DATABASE sales, hr;
```

To back up one PDB while connected to the PDB:

1. Start RMAN and connect to the PDB as a [local user](#) with the `SYSBACKUP` or `SYSDBA` privilege as described in [Connecting as Target to a PDB](#) (page 4-9).
2. Issue a `BACKUP DATABASE` command at the RMAN prompt.

```
BACKUP DATABASE;
```

Note:

Backing up a proxy PDB using RMAN is not supported.

9.4.6 Backing Up PDBs with Oracle Enterprise Manager Cloud Control

Oracle Enterprise Manager Cloud Control (Cloud Control) can be used to perform backups of pluggable databases (PDBs).

To back up one or more PDBs with Cloud Control, complete the following steps:

1. From the Database Home page, select **Backup & Recovery** from the Availability menu, and then select **Schedule Backup**.

2. If you have not logged in to the database previously, then the Database Login page is displayed. Log in to the database using Named or New credentials and then click **Login**.

Cloud Control displays the Schedule Backup page.

3. From the Customized Backup section, select **Pluggable Databases**, and then click **Schedule Customized Backup**.

The Schedule Backup Wizard appears and displays the Pluggable Databases page.

4. Select the PDBs that you want to back up by following these steps:
 - a. Click **Add** to display the Available Pluggable Databases page.
 - b. From the list of PDBs shown, click in the **Select** column to designate the PDBs you want to back up. Optionally, you can click **Select All** to turn on the Select option for all available PDBs. Click **Select None** to deselect all PDBs.
 - c. Click the **Select** button to return to the Pluggable Databases page.
 - d. Optionally, you can remove PDBs from the table by clicking in the **Select** column for each PDB that you want to remove and then clicking **Remove**.
5. Click **Next** to move to the Options page of the wizard.
6. Complete the wizard by navigating the remainder of the pages to back up the PDBs. For more information about each page of the wizard, click **Help**.

See Also:

[Accessing the Database Home Page Using Cloud Control](#) (page 1-10)

9.4.7 Backing Up Tablespaces and Data Files in a PDB

Because tablespaces in different PDBs can have the same name, to eliminate ambiguity you must connect directly to a PDB to back up one or more of its tablespaces.

Ensure that the CDB is open or mounted. Tablespaces can be read-only or read-write.

In contrast, because data file numbers and paths are unique across the CDB, you can connect to either the root or a PDB to back up PDB data files. If you connect to the root, you can back up data files from multiple PDBs with a single command. If you connect to a PDB, you can back up only data files in that PDB.

To back up tablespaces in a PDB:

1. Start RMAN and connect to the PDB as a local user with the `SYSPBACKUP` or `SYSDBA` privilege as described in [Connecting as Target to a PDB](#) (page 4-9).
2. Issue a `BACKUP TABLESPACE` command.

The following example backs up the tablespaces `users` and `examples` to the configured default device.

```
BACKUP TABLESPACE users, examples;
```

To back up data files in a PDB:

1. Do one of the following:
 - Start RMAN and connect to the root as a common user with the SYSBACKUP or SYSDBA privilege.
 - Start RMAN and connect to the PDB as a local user with the SYSBACKUP or SYSDBA privilege.
2. Issue a BACKUP DATAFILE command.

```
BACKUP DATAFILE 10, 13;
```

See Also:

- [Connecting as Target to the Root](#) (page 4-8)
 - [Connecting as Target to a PDB](#) (page 4-9)
-

9.5 Backing Up Application Containers

RMAN enables you to use the BACKUP command to perform backup operations on the application root, one or more application PDBs, and the application container.

Note:

- [About Backing Up Application Containers](#) (page 9-20)
 - [Backing Up the Application Root](#) (page 9-21)
 - [Backing Up the Application Root and its Application PDBs](#) (page 9-21)
 - [Backing Up Application PDBs](#) (page 9-22)
-

9.5.1 About Backing Up Application Containers

RMAN can back up application containers, application PDBs, and the application root.

An [application container](#) is an optional component of a CDB that stores data for one or more applications and shares application metadata and common data. A CDB can contain zero or more application containers. An application container consists of exactly one [application root](#) (different from the root in its CDB) and one or more [application PDBs](#). The application root serves as the parent container to all the application PDBs plugged into it.

An application container typically contains one or more application common users. An application common user can only connect to the application root in which it was created or a PDB that is plugged in to this application root. An application root has its own service name, and you can connect to the application root in the same way that you connect to a PDB.

To perform backup and recovery tasks for the application root or application PDBs, you connect either to the application root or CDB root.

See Also:

- *Oracle Database Concepts* for conceptual information about application containers
 - *Oracle Database Administrator's Guide* for information about creating application containers
-
-

9.5.2 Backing Up the Application Root

RMAN provides multiple ways of backing up the application root using the `BACKUP` command.

Use one of the following approaches to back up the application root:

- Connect to the [application root](#) and use the `BACKUP DATABASE ROOT` command
- Connect to the CDB root and use the `BACKUP PLUGGABLE DATABASE` command

The `COMPATIBLE` parameter for the CDB must be set to 12.2 or higher.

To connect to and back up the application root:

1. Start RMAN and connect to the application root as an application common user with the `SYSDBA` or `SYSBACKUP` privilege.

The application root has its own service name and you can connect to the application root in the same way that you connect to a PDB.

2. Use the following `BACKUP` command to back up the application root.

```
BACKUP DATABASE ROOT;
```

To back up the application root when connected to the root in a CDB

1. Start RMAN and connect to the CDB root as a common user with the `SYSDBA` or `SYSBACKUP` privilege.
2. Use the `BACKUP PLUGGABLE DATABASE` command to back up the application root.

The following example backs up an application root named `hr_appcont`:

```
BACKUP PLUGGABLE DATABASE hr_appcont;
```

See Also:

[Making RMAN Connections to a CDB](#) (page 4-7)

9.5.3 Backing Up the Application Root and its Application PDBs

Use the `BACKUP` command to back up an application container, which consists of the application root and all the application PDBs that belong to the application root.

The `COMPATIBLE` parameter for the CDB must be set to 12.2 or higher.

To back up the application root and all its application PDBs:

1. Start RMAN and connect to the [application root](#) as an application common user with the SYSDBA or SYSBACKUP privilege.

The application root has its own service name and you can connect to the application root in the same way that you connect to a PDB.

2. Use the following command to back up the [application container](#):

```
BACKUP DATABASE ;
```

See Also:

[Making RMAN Connections to a CDB](#) (page 4-7)

9.5.4 Backing Up Application PDBs

The BACKUP command is used to back up one or more application PDBs.

The COMPATIBLE parameter for the CDB must be set to 12.2 or higher.

To back up one or more application PDBs:

1. Start RMAN and establish one of the following types of connections:
 - Connect to the [application root](#) as an application common user with the SYSDBA or SYSBACKUP privilege.
The application root has its own service name and you can connect to the application root in the same way that you connect to a PDB.
 - Connect to the CDB root as a common user with the SYSDBA or SYSBACKUP privilege.
2. Use the BACKUP PLUGGABLE DATABASE command to back up the [application PDB](#). To back up multiple application PDBs, use a comma-separated list of application PDB names.

The following command backs up an application PDB named hr_app_pdb:

```
BACKUP PLUGGABLE DATABASE hr_app_pdb ;
```

See Also:

[Making RMAN Connections to a CDB](#) (page 4-7)

9.6 Backing Up Sparse Databases with RMAN

Use the BACKUP command to back up sparse databases.

This section contains the following topics:

- [Backing Up a Sparse Database with RMAN](#) (page 9-23)
- [Backing Up Sparse Tablespaces and Data Files with RMAN](#) (page 9-24)
- [Backing Up a Sparse CDB with RMAN](#) (page 9-25)

- [Backing Up a Sparse PDB with RMAN](#) (page 9-26)

Note:

The base (read-only) data files in a sparse database are not encrypted. Ensure that the base data files are stored in a protected storage and accessed using secured communications.

9.6.1 Backing Up a Sparse Database with RMAN

RMAN enables you to back up a sparse database, using steps similar to backing up a whole database, in the backup set or image copy format.

The difference while backing up a sparse database is that RMAN backs up data only from the delta storage space of the database, which contains the latest changes made to the data blocks within the sparse database.

Ensure you meet the following requirements before backing up a sparse database:

- The base database for your sparse database must be read-only
- The `COMPATIBLE` initialization parameter of the database being backed up must be set to 12.2 or higher.

To back up a sparse database

1. Start RMAN and connect to a target database as described in [Making Database Connections with RMAN](#) (page 4-2).
2. Ensure that the database is mounted or open.
3. Issue the `BACKUP` command with the `AS SPARSE` option. To specify your backup format, use one of the following options:
 - To create your backup in the backup set format, use the `AS SPARSE BACKUPSET` option. The following example performs a sparse backup in the backup set format:

```
BACKUP AS SPARSE BACKUPSET DATABASE PLUS ARCHIVELOG;
```

- To create your backup in the image copy format use the `AS SPARSE COPY` option. The following example performs a backup in the image copy format:

```
BACKUP AS SPARSE COPY DATABASE PLUS ARCHIVELOG;
```

- To create your backup in the compressed backup set format use the `COMPRESSED BACKUPSET` option. The following example performs a backup in the compressed backups set format:

```
BACKUP AS SPARSE COMPRESSED BACKUPSET DATABASE;
```

See Also:

- [About Sparse Backups](#) (page 8-12) for more information on sparse backups
 - [Backing Up a Whole Database with RMAN](#) (page 9-10) for more information on how to perform a traditional backup on a normal database
 - [Backing Up Sparse Tablespaces and Data Files with RMAN](#) (page 9-24)
 - [Performing Complete Recovery of a Sparse Database](#) (page 17-33)
-
-

See Also:

Oracle Database Backup and Recovery Reference for more information on the options to back up sparse databases

9.6.2 Backing Up Sparse Tablespaces and Data Files with RMAN

You can back up one or more tablespaces containing sparse data files or individual sparse data files using the `BACKUP` command.

While backing up tablespaces, RMAN translates the `BACKUP` command to individual data files that are sparse compatible. Similarly, only data files containing sparse data blocks are eligible for a sparse backup. RMAN creates sparse backups of sparse data files and non-sparse backups of non-sparse data files.

Ensure that the database containing the sparse tablespace or data file has the `COMPATIBLE` initialization parameter set to 12.2 or higher.

To back up sparse tablespaces or data files:

1. Start RMAN and connect to a target database. For tablespaces and data files in CDB, you must connect to the root as a user with the `SYSDBA` or `SYSBACKUP` privilege.

See Also:

[Making Database Connections with RMAN](#) (page 4-2) for information about connecting to a target database

2. Ensure that the database instance is mounted or open.
3. Run the `BACKUP` command for the tablespace or data file with the `AS SPARSE` option. Specify whether you want the backup in the backup set format, image copy format, or compressed backup set format. To do this, state one of the following options:

- To create your backup in the backup set format, use the `AS SPARSE BACKUPSET` option. The following example performs a sparse backup in the backup set format:

```
BACKUP AS SPARSE BACKUPSET TABLESPACE MYTBS1;
```

- To create your backup in the image copy format use the `AS SPARSE COPY` option. The following example performs a backup in the image copy format:

```
BACKUP AS SPARSE COPY DATAFILE 8,9,10;
```

- To create your backup in the compressed backup set format use the `COMPRESSED BACKUPSET` option. The following example performs a backup in the compressed backups set format:

```
BACKUP AS SPARSE COMPRESSED BACKUPSET TABLESPACE MYTBS3;
```

See Also:

- [Backing Up a Sparse Database with RMAN](#) (page 9-23)
 - *Oracle Database Backup and Recovery Reference*
-
-

9.6.3 Backing Up a Sparse CDB with RMAN

You can back up a sparse multitenant container database (CDB) or a CDB containing some sparse pluggable databases (PDBs) by performing a backup operation similar to backing up a sparse database using the `BACKUP` command.

Ensure that the `COMPATIBLE` initialization parameter of your CDB is set to 12.2 or higher.

To back up a sparse CDB:

1. Start RMAN and connect to root as a common user with the `SYSBACKUP` or `SYSDBA` privilege.
2. Ensure that the CDB is mounted or open and in `ARCHIVELOG` mode.
3. Enter the `BACKUP` command with the `AS SPARSE` option. Specify which format you want to create your backup in:
 - To create your backup in the backup set format, use the `AS SPARSE BACKUPSET` option. The following example performs a backup on the sparse CDB in the backup set format:

```
BACKUP AS SPARSE BACKUPSET DATABASE;
```

- To create your backup in the image copy format use the `AS SPARSE COPY` option. The following example performs a backup on the sparse CDB in the image copy format:

```
BACKUP AS SPARSE COPY DATABASE;
```

- To create your backup in the compressed backup set format use the `COMPRESSED BACKUPSET` option. The following example performs a backup on the sparse CDB in the compressed backups set format:

```
BACKUP AS SPARSE COMPRESSED BACKUPSET DATABASE;
```

See Also:

- [Backing Up a Sparse Database with RMAN](#) (page 9-23)
- [Performing Complete Recovery of a Sparse CDB](#) (page 17-33)

9.6.4 Backing Up a Sparse PDB with RMAN

RMAN enables you to back up one or more sparse PDBs in a CDB.

Ensure that the `COMPATIBLE` initialization parameter is set to 12.2 or higher.

To back up a sparse PDB while connected to root:

1. Start RMAN and connect to the root as a common user with the `SYSPBACKUP` or `SYSDBA` privilege as described in [Connecting as Target to the Root](#) (page 4-8).
2. Run the `BACKUP` command for the pluggable database. Specify the format for your backup:
 - To create your backup in the backup set format, use the `AS SPARSE BACKUPSET` option. The following example performs a sparse backup in the backup set format:

```
BACKUP AS SPARSE BACKUPSET PLUGGABLE DATABASE PDB1;
```
 - To create your backup in the image copy format use the `AS SPARSE COPY` option. The following example performs a backup in the image copy format:

```
BACKUP AS SPARSE COPY PLUGGABLE DATABASE PDB1;
```
 - To create your backup in the compressed backup set format use the `COMPRESSED BACKUPSET` option. The following example performs a backup in the compressed backups set format:

```
BACKUP AS SPARSE COMPRESSED BACKUPSET PLUGGABLE DATABASE PDB1;
```

To back up a sparse PDB while connected to the PDB:

1. Start RMAN. Connect to the sparse PDB as a [local user](#) with the `SYSPBACKUP` or `SYSDBA` privilege as described in [Connecting as Target to a PDB](#) (page 4-9).
2. Run the `BACKUP` command at the RMAN prompt, with the `AS SPARSE` option and the format required. To specify the format for your backup, use one of the following commands:
 - To create your backup in the backup set format, use the `AS SPARSE BACKUPSET` option. The following example performs a sparse backup in the backup set format:

```
BACKUP AS SPARSE BACKUPSET DATABASE;
```
 - To create your backup in the image copy format use the `AS SPARSE COPY` option. The following example performs a backup in the image copy format:

```
BACKUP AS SPARSE COPY DATABASE;
```

- To create your backup in the compressed backup set format use the `COMPRESSED BACKUPSET` option. The following example performs a backup in the compressed backups set format:

```
BACKUP AS SPARSE COMPRESSED BACKUPSET DATABASE;
```

3. To back up a tablespace from a sparse PDB, connect to the selected PDB directly and then run the `BACKUP` command with the `AS SPARSE` option, the appropriate backup format, and the tablespace name.
4. To back up a data file from a sparse PDB, you can either connect to root or directly to the PDB. Run the `BACKUP` command with the `AS SPARSE` option, the backup format, and the data file name, to back up an individual data file.

See Also:

[Backing Up PDBs with RMAN](#) (page 9-18)

[Performing Recovery of a Sparse PDB with RMAN](#) (page 17-34)

9.7 Backing Up Archived Redo Logs with RMAN

Archived redo logs are the key to successful media recovery. You should back them up regularly.

This section contains the following topics:

- [About Backups of Archived Redo Logs for non-CDBs](#) (page 9-27)
- [About Backup of Archived Redo Logs in CDBs](#) (page 9-29)
- [Backing Up Archived Redo Log Files in non-CDBs](#) (page 9-29)
- [Backing Up Only Archived Redo Logs That Need Backups in non-CDBs](#) (page 9-30)
- [Backing Up Archived Redo Logs in CDBs](#) (page 9-31)
- [Deleting Archived Redo Logs After Backups in non-CDBs](#) (page 9-32)
- [Deleting Archived Redo Logs After Backups in CDBs](#) (page 9-33)

9.7.1 About Backups of Archived Redo Logs for non-CDBs

Several features of RMAN backups are specific to archived redo logs. For example, you can use `BACKUP . . . DELETE` to delete one or all copies of archived redo logs from disk after backing them up to backup sets.

This section contains the following topics:

- [About Archived Redo Log Failover](#) (page 9-27)
- [About Online Redo Log Switching](#) (page 9-28)

9.7.1.1 About Archived Redo Log Failover

Even if your redo logs are being archived to multiple destinations and you use RMAN to back up archived redo logs, RMAN selects only one copy of the archived redo log

file to include in the backup set. Because logs with the same log sequence number are identical, RMAN does not need to include more than one log copy.

The [archived redo log failover](#) feature enables RMAN to complete a backup even when some archiving destinations are missing logs or contain logs with corrupt blocks. If at least one log corresponding to a given log sequence and thread is available in the fast recovery area or any of the archiving destinations, then RMAN tries to back it up. If RMAN finds a corrupt block in a log file during backup, it searches other destinations for a copy of that log without corrupt blocks.

For example, assume that you archive logs 121 through 124 to two destinations: /arch1 and /arch2. [Table 9-1](#) (page 9-28) shows the archived redo log records in the control file.

Table 9-1 Sample Archived Redo Log Records

Sequence	File Name in /arch1	File Name in /arch2
121	/arch1/archive1_121.arc	/arch2/archive1_121.arc
122	/arch1/archive1_122.arc	/arch2/archive1_122.arc
123	/arch1/archive1_123.arc	/arch2/archive1_123.arc
124	/arch1/archive1_124.arc	/arch2/archive1_124.arc

However, unknown to RMAN, a user deletes logs 122 and 124 from the /arch1 directory. Afterward, you run the following backup:

```
BACKUP ARCHIVELOG
  FROM SEQUENCE 121
  UNTIL SEQUENCE 125;
```

With failover, RMAN completes the backup, using logs 122 and 124 in /arch2.

9.7.1.2 About Online Redo Log Switching

Automatic online redo log switching is an important RMAN feature.

To make an open database backup of archived redo logs that includes the most recent online redo log, you can execute the BACKUP command with any of the following clauses:

- PLUS ARCHIVELOG
- ARCHIVELOG ALL
- ARCHIVELOG FROM . . .

Before beginning the backup, RMAN switches out of the current redo log group, and archives all online redo logs that have not yet been archived, up to and including the redo log group that was current when the command was issued. This feature ensures that the backup contains all redo generated before the start of the command.

An effective way of backing up archived redo logs is the BACKUP . . . PLUS ARCHIVELOG command, which causes RMAN to do the following:

1. Run the ALTER SYSTEM ARCHIVE LOG CURRENT statement.
2. Run BACKUP ARCHIVELOG ALL. If [backup optimization](#) is enabled, then RMAN skips logs that it has already backed up to the specified device.

3. Back up the rest of the files specified in the BACKUP command.
4. Run the ALTER SYSTEM ARCHIVE LOG CURRENT statement.
5. Back up any remaining archived logs generated during the backup. If backup optimization is not enabled, then RMAN backs up the logs generated in Step 1 plus all the logs generated during the backup.

The preceding steps guarantee that data file backups taken during the command are recoverable to a consistent state. Also, unless the online redo log is archived at the end of the backup, DUPLICATE is not possible with the backup.

9.7.2 About Backup of Archived Redo Logs in CDBs

In a CDB, archived redo logs can be backed up only when you connect to the root as a common user with the SYSDBA or SYSBACKUP privilege.

When you connect to a PDB as a local user with SYSDBA or SYSBACKUP privilege, you cannot back up or delete archived redo logs.

If your archived redo logs are being copied to multiple destinations, when you connect to the root and backup archived redo log files, RMAN includes only one copy of the archived redo log files in a backup. You can switch archived redo log files when you connect to root of a CDB. Therefore, the information in "[About Archived Redo Log Failover](#) (page 9-27)" and "[About Online Redo Log Switching](#) (page 9-28)" is applicable when you connect to the root. However, you cannot backup or switch archived redo log files when connected to a PDB.

See Also:

[Backing Up Archived Redo Logs in CDBs](#) (page 9-31)

9.7.3 Backing Up Archived Redo Log Files in non-CDBs

To back up archived logs, use the BACKUP ARCHIVELOG command.

If [backup optimization](#) is enabled, then RMAN skips backups of archived logs that have already been backed up to the specified device.

To back up archived redo log files:

1. Start RMAN and connect to a target database and a recovery catalog (if used) as described in [Making Database Connections with RMAN](#) (page 4-2).
2. Ensure that the target database is mounted or open.
3. Execute the BACKUP ARCHIVELOG or BACKUP . . . PLUS ARCHIVELOG command.

The following example backs up the database and all archived redo logs:

```
BACKUP DATABASE PLUS ARCHIVELOG;
```

The following example uses a configured disk or SBT channel to back up one copy of each log sequence number for all archived redo logs:

```
BACKUP ARCHIVELOG ALL;
```

You can also specify a range of archived redo logs by time, SCN, or log sequence number, as in the following example:

```
BACKUP ARCHIVELOG
  FROM TIME 'SYSDATE-30'
  UNTIL TIME 'SYSDATE-7';
```

9.7.4 Backing Up Only Archived Redo Logs That Need Backups in non-CDBs

You can indicate that RMAN should *automatically* skip backups of archived redo logs. Use one of the following techniques:

- Configure [backup optimization](#).
If you enable backup optimization, then the `BACKUP ARCHIVELOG` command skips backing up files when an identical archived log has been backed up to the specified device type. An archived log is considered identical to another when it has the same DBID, thread, sequence number, and `RESETLOGS SCN` and time.
- Configure an [archived redo log deletion policy](#).
If the deletion policy is configured with the `BACKED UP integer TIMES` clause, then a `BACKUP ARCHIVELOG` command copies the logs unless *integer* backups exist on the specified device type. If *integer* backups of the logs exist, then the `BACKUP ARCHIVELOG` command skips the logs.

The `BACKUP ... NOT BACKED UP integer TIMES` command specifies that RMAN backs up only those archived log files that have not been backed up at least *integer* times to the specified device. To determine the number of backups for a file, RMAN only considers backups created on the same device type as the current backup.

The `BACKED UP` clause is a convenient way to back up archived logs to a specified device type. For example, you can specify that RMAN should keep two copies of each archived redo log on tape and skip additional backups.

To back up archived redo logs that need backups:

1. Start RMAN and connect to a target database and a recovery catalog (if used) as described in [Making Database Connections with RMAN](#) (page 4-2).
2. Ensure that the target database is mounted or open.
3. Ensure that appropriate channels are configured for the backup.
4. Execute the `BACKUP ARCHIVELOG` command with the `NOT BACKED UP` clause.

```
BACKUP ARCHIVELOG ALL NOT BACKED UP 2 TIMES;
```

See Also:

- [Backup Optimization and the CONFIGURE command](#) (page 5-31)
 - [Configuring an Archived Redo Log Deletion Policy](#) (page 5-35)
 - [Using Backup Optimization to Skip Files](#) (page 10-4) for scenarios using `NOT BACKED UP`
-

9.7.5 Backing Up Archived Redo Logs in CDBs

You can back up archived redo logs in a multitenant container database (CDB) by using the `BACKUP ARCHIVELOG` command.

To back up archived redo logs in a CDB:

1. Start RMAN and connect to the root as a user with the `SYSDBA` or `SYSBACKUP` privilege as described in [Connecting as Target to the Root](#) (page 4-8).
2. Ensure that the target CDB is mounted or open.
3. Execute the `BACKUP ARCHIVELOG` or `BACKUP . . . PLUS ARCHIVELOG` command.

The following example backs up the database and all archived redo logs:

```
BACKUP DATABASE PLUS ARCHIVELOG;
```

The following example uses a configured disk or SBT channel to back up one copy of each log sequence number for all archived redo logs:

```
BACKUP ARCHIVELOG ALL;
```

To back up only archived redo logs that need backup in a CDB:

1. Start RMAN and connect to the root as a common user with the `SYSDBA` or `SYSBACKUP` privilege.
2. Ensure that the target CDB is mounted or open.
3. Ensure that appropriate channels are configured for the backup.
4. Configure RMAN to automatically skip backups of archived redo logs. Use one of the following techniques:
 - Configure backup optimization so that the `BACKUP ARCHIVELOG` command skips backing up files when an identical archived log has been backed up to the specified device type.
 - Configure an archived redo log retention policy using the `BACKED UP integer TIMES` clause. A `BACKUP ARCHIVELOG` command will copy the logs unless *integer* backups exist on the specified device type.
5. Execute the `BACKUP ARCHIVELOG` command with the `NOT BACKED UP` clause.

```
BACKUP ARCHIVELOG ALL NOT BACKED UP 2 TIMES;
```

See Also:

- [About Backup of Archived Redo Logs in CDBs](#) (page 9-29)
 - [Backing Up Only Archived Redo Logs That Need Backups in non-CDBs](#) (page 9-30)
-

9.7.6 Deleting Archived Redo Logs After Backups in non-CDBs

The `BACKUP ARCHIVELOG . . . DELETE INPUT` command deletes archived log files after they are backed up. This command eliminates the separate step of manually deleting archived redo logs.

With `DELETE INPUT`, RMAN deletes only the specific copy of the archived log chosen for the backup set. With `DELETE ALL INPUT`, RMAN deletes each backed-up archived redo log file from all log archiving destinations.

The `BACKUP . . . DELETE INPUT` and `DELETE ARCHIVELOG` commands obey the [archived redo log deletion policy](#) for logs in all archiving locations. For example, if you specify that logs be deleted only when backed up at least twice to tape, then `BACKUP . . . DELETE` honors this policy.

For the following procedure, assume that you archive to `/arc_dest1`, `/arc_dest2`, and the fast recovery area.

To delete archived redo logs after a backup:

1. Start RMAN and connect to a target database and a recovery catalog (if used) as described in [Making Database Connections with RMAN](#) (page 4-2).
2. Ensure that the target database is mounted or open.
3. Run the `BACKUP` command with the `DELETE INPUT` clause.

Assume that you run the following `BACKUP` command:

```
BACKUP DEVICE TYPE sbt
  ARCHIVELOG ALL
  DELETE ALL INPUT;
```

In this case, RMAN backs up only one copy of each log sequence number in these archiving locations. RMAN deletes all copies of any log that it backed up from both the fast recovery area and the other archiving destinations.

If you specify `DELETE INPUT` rather than `DELETE ALL INPUT`, then RMAN only deletes the specific archived redo log files that it backed up. For example, RMAN deletes the logs in `/arc_dest1` if these files were used as the source of the backup, but leave the contents of the `/arc_dest2` intact.

See Also:

- [Configuring an Archived Redo Log Deletion Policy](#) (page 5-35)
 - *Oracle Data Guard Concepts and Administration* to learn about archived redo log management with standby databases
 - *Oracle Database Backup and Recovery Reference* to learn about the `CONFIGURE ARCHIVELOG DELETION POLICY` and `DELETE ARCHIVELOG` commands
 - [Deleting RMAN Backups and Archived Redo Logs](#) (page 12-20)
-
-

9.7.7 Deleting Archived Redo Logs After Backups in CDBs

In a CDB, you can delete archived redo logs after they are backed up by using the `BACKUP ARCHIVELOG . . . DELETE INPUT` command.

To delete archived redo logs in a CDB after they are backed up:

1. Start RMAN and connect to the root as a user with the `SYSDBA` or `SYSBACKUP` privilege as described in [Making Database Connections with RMAN](#) (page 4-2).
2. Ensure that the target database is mounted or open.
3. Run the `BACKUP` command with the `DELETE INPUT` clause.

See Also:

Oracle Database Backup and Recovery Reference for information about the `BACKUP` command

9.8 Making and Updating RMAN Incremental Backups

An incremental backup copies only data file blocks that have changed since a specified previous backup. Use the `BACKUP` command to create incremental backups.

An incremental backup is either a [cumulative incremental backup](#) or a [differential incremental backup](#).

Although the content of the backups is the same, `BACKUP DATABASE` and `BACKUP INCREMENTAL LEVEL 0 DATABASE` are different. A [full backup](#) is not usable as part of an incremental strategy, whereas a [level 0 incremental backup](#) is the basis of an incremental strategy. No RMAN command can change a full backup into a level 0 incremental backup.

As with full backups, RMAN can make incremental backups of an `ARCHIVELOG` mode database that is open. If the database is in `NOARCHIVELOG` mode, then RMAN can make incremental backups only after a consistent shutdown.

This section contains the following topics:

- [Purpose of RMAN Incremental Backups](#) (page 9-33)
- [Planning an Incremental Backup Strategy](#) (page 9-34)
- [Making Incremental Backups](#) (page 9-35)
- [Incrementally Updating Backups](#) (page 9-36)
- [Using Block Change Tracking to Improve Incremental Backup Performance](#) (page 9-40)

9.8.1 Purpose of RMAN Incremental Backups

RMAN incremental backups provide multiple benefits.

The primary reasons for making incremental backups part of your strategy are:

- Faster daily backups if [block change tracking](#) is enabled (see "[Using Block Change Tracking to Improve Incremental Backup Performance](#) (page 9-40)")

- Ability to roll forward data file image copies, thereby reducing recovery time and avoiding repeated full backups
- Less bandwidth consumption when backing up over a network
- Improved performance when the aggregate tape bandwidth for tape write I/Os is much less than the aggregate disk bandwidth for disk read I/Os
- Possibility of recovering changes to objects created with the NOLOGGING option

For example, direct load inserts do not create redo log entries, so their changes cannot be reproduced with media recovery. Direct load inserts do change data blocks, however, and these blocks are captured by incremental backups.

- Ability to synchronize a physical standby database with the primary database

You can use the `RMAN BACKUP INCREMENTAL FROM SCN` command to create a backup on the primary database that starts at the current SCN of the standby database, which you can then use to roll forward the standby database. See *Oracle Data Guard Concepts and Administration* to learn how to apply incremental backups to a standby database.

See Also:

Oracle Database Administrator's Guide for more information about NOLOGGING mode

9.8.2 Planning an Incremental Backup Strategy

Choose a backup strategy according to an acceptable MTTR (mean time to recover).

For example, you can implement a three-level backup scheme so that a level 0 backup is taken monthly, a cumulative level 1 is taken weekly, and a differential level 1 is taken daily. In this strategy, you never have to apply more than a day of redo for complete recovery.

When deciding how often to take level 0 backups, a general rule is to take a new level 0 backup whenever 20% or more of the data has changed. If the rate of change to your database is predictable, then you can observe the size of your incremental backups to determine when a new level 0 backup is appropriate. The following SQL query determines the number of blocks written to an incremental level 1 backup of each data file with at least 20% of its blocks backed up:

```
SELECT FILE#, INCREMENTAL_LEVEL, COMPLETION_TIME,
       BLOCKS, DATAFILE_BLOCKS
FROM   V$BACKUP_DATAFILE
WHERE  INCREMENTAL_LEVEL > 0
AND    BLOCKS / DATAFILE_BLOCKS > .2
ORDER BY COMPLETION_TIME;
```

Compare the number of blocks in level 1 backups to a level 0 backup. For example, if you create only level 1 cumulative backups, then take a new level 0 backup when the most recent level 1 backup is about half the size of the level 0 backup.

An effective way to conserve disk space is to make incremental backups to disk, and then offload the backups to tape with the `BACKUP AS BACKUPSET` command. Incremental backups are generally smaller than full backups, which limits the space required to store them until they are moved to tape. When the incremental backups on disk are backed up to tape, the tape is more likely to stream because all blocks of the

incremental backup are copied to tape. There is no possibility of delay due to time required for RMAN to locate changed blocks in the data files.

Another strategy is to use incrementally updated backups, as explained in "[Incrementally Updating Backups](#) (page 9-36)". In this strategy, you create an image copy of each data file, and then periodically roll forward this copy by making and then applying a level 1 incremental backup. In this way you avoid the overhead of making repeated full image copies of your data files, but enjoy all of the advantages.

In a Data Guard environment, you can offload incremental backups to a [physical standby database](#). Incremental backups of a standby and primary database are interchangeable. Thus, you can apply an incremental backup of a standby database to a primary database, or apply an incremental backup of a primary database to a standby database.

See Also:

Oracle Data Guard Concepts and Administration to learn how to back up a standby database with RMAN. In particular, consult Chapter 10, "Managing Physical and Snapshot Standby Databases"

9.8.3 Making Incremental Backups

After starting RMAN, run the `BACKUP INCREMENTAL` command at the RMAN prompt. By default incremental backups are differential.

To make an incremental backup:

1. Start RMAN and connect to a target database and a recovery catalog (if used).

See Also:

[Making Database Connections with RMAN](#) (page 4-2)

2. Ensure that the target database is mounted or open.
3. Execute the `BACKUP INCREMENTAL` command with the desired options.

Use the `LEVEL` parameter to indicate the incremental level. The following example makes a level 0 incremental database backup.

```
BACKUP
  INCREMENTAL LEVEL 0
  DATABASE;
```

The following example makes a [differential incremental backup](#) at level 1 of the `SYSTEM` and `tools` tablespaces. It only backs up those data blocks changed since the most recent level 1 or level 0 backup.

```
BACKUP
  INCREMENTAL LEVEL 1
  TABLESPACE SYSTEM, tools;
```

The following example makes a [cumulative incremental backup](#) at level 1 of the tablespace `users`, backing up all blocks changed since the most recent level 0 backup.

```
BACKUP
  INCREMENTAL LEVEL 1 CUMULATIVE
  TABLESPACE users;
```

9.8.3.1 Making Incremental Backups of a VSS Snapshot

You can use the Volume Shadow Copy Service (VSS) with the Oracle VSS writer to make a shadow copy or snapshot of files in a database.

You must use a third-party backup program other than RMAN to make VSS snapshots with the Oracle VSS writer. In this case, the [fast recovery area](#) automates management of files that are backed up in a VSS snapshot and deletes them as needed.

You can use the `BACKUP INCREMENTAL LEVEL 1 . . . FROM SCN` command in RMAN to create incremental backups in the fast recovery area. Thus, you can use this command to create an incremental level 1 backup of a VSS shadow copy. RMAN can apply incremental backups during recovery transparently.

See Also:

Oracle Database Platform Guide for Microsoft Windows to learn how to make VSS backups with RMAN

9.8.4 Incrementally Updating Backups

By incrementally updating backups, you can avoid the overhead of making full image copy backups of data files, while also minimizing time required for media recovery of your database. For example, if you run a daily backup script, then you never have more than 1 day of redo to apply for media recovery.

To incrementally update data file backups:

1. Create a full image copy backup of a data file with a specified tag.
2. At regular intervals (such as daily), make a level 1 differential incremental backup of the data file and use the same tag as the base data file copy.
3. Apply the incremental backup to the most recent backup with the same tag.

This technique rolls forward the backup to the time when the level 1 incremental backup was made. RMAN can restore this [incremental forever](#) and apply changes from the redo log. The result equals restoring a data file backup taken at the SCN of the most recently applied incremental level 1 backup.

Note:

If you run `RECOVER COPY` daily *without* specifying an `UNTIL TIME`, then a continuously updated image copy cannot satisfy a [recovery window](#) of more than a day. The incrementally updated backup feature is an optimization for fast media recovery.

9.8.4.1 Incrementally Updating Backups: Basic Example

To create incremental backups for use in an incrementally updated backup strategy, use the `BACKUP . . . FOR RECOVER OF COPY WITH TAG` form of the `BACKUP`

command. The command is best understood in a sample script that implements the strategy.

The script in [Example 9-15](#) (page 9-37), run regularly, is all that is required to implement a strategy based on incrementally updated backups.

Example 9-15 Basic Incremental Update Script

```

RUN
{
  RECOVER COPY OF DATABASE
    WITH TAG 'incr_update';
  BACKUP
    INCREMENTAL LEVEL 1
    FOR RECOVER OF COPY WITH TAG 'incr_update'
    DATABASE;
}

```

To understand the script and the strategy, you must understand the effects of these two commands when no data file copies or incremental backups exist. Note two important features:

- The `BACKUP` command in [Example 9-15](#) (page 9-37) does not always create a level 1 incremental backup.
- The `RECOVER` command in [Example 9-15](#) (page 9-37) causes RMAN to apply any available incremental level 1 backups with the specified tag to a set of data file copies with the same tag.

[Table 9-2](#) (page 9-37) shows the effect of the script when it is run once per day starting on Monday.

Table 9-2 Effect of Basic Script When Run Daily

Command	Monday	Tuesday	Wednesday	Thursday Onward
RECOVER	Because no incremental backup or data file copy exists, the command generates a message (but not an error). That is, the command has no effect.	A database copy now exists, but no incremental level 1 backup exists with which to recover it. Thus, the <code>RECOVER</code> command has no effect.	The level 1 incremental backup made on Tuesday is applied to the database copy, bringing the copy up to the checkpoint SCN of the level 1 incremental backup.	The level 1 incremental backup made yesterday is applied to the database copy, bringing the copy up to the checkpoint SCN of the level 1 incremental backup.

Table 9-2 (Cont.) Effect of Basic Script When Run Daily

Command	Monday	Tuesday	Wednesday	Thursday Onward
BACKUP	<p>No level 0 image copy exists, so the command creates an image copy of the database and applies the tag <code>incr_update</code>. This copy is needed to begin the cycle of incremental updates.</p> <p>Note: If the script sets <code>DEVICE TYPE sbt</code>, then the first run creates the copy on disk, not on tape. Subsequent runs make level 1 backups on tape.</p>	<p>The command makes an incremental level 1 backup and assigns it the tag <code>incr_update</code>. This backup contains blocks that changed between Monday and Tuesday.</p>	<p>The command makes an incremental level 1 backup and assigns it the tag <code>incr_update</code>. This backup contains blocks that changed between Tuesday and Wednesday.</p>	<p>The command makes an incremental level 1 backup and assigns it the tag <code>incr_update</code>. This backup contains blocks that changed between now and the most recent backup with the tag <code>incr_update</code>.</p>

Note the following additional details about [Example 9-15](#) (page 9-37):

- Each time a data file is added to the database, an image copy of the new data file is created the next time the script runs. The next run makes the first level 1 incremental for the added data file. On all subsequent runs the new data file is processed like any other data file.
- You must use tags to identify the data file copies and incremental backups in this strategy so that they do not interfere with other backup strategies. If you use multiple incremental backup strategies, then RMAN cannot unambiguously create incremental level 1 backups unless you tag level 0 backups.

The incremental level 1 backups to apply to those image copies are selected based upon the tag of the image copy data files and the available incremental level 1 backups. The tag is essential in the selection of the incremental level backups.
- After the third run of the script, the following files are available for a point-in-time recovery:
 - An image copy of the database, as of the checkpoint SCN of the preceding run of the script, 24 hours earlier
 - An incremental backup for the changes after the checkpoint SCN of the preceding run
 - Archived redo logs including all changes between the checkpoint SCN of the image copy and the current time

If you must restore and recover your database during the following 24 hours, then you can restore the data files from the incrementally updated data file copies. You can then apply changes from the most recent incremental level 1 and the redo logs to reach the desired SCN. At most, you have 24 hours of redo to apply, which limits how long point-in-time recovery takes to finish.

9.8.4.2 Incrementally Updated Backups: Advanced Example

You can extend the basic script in [Example 9-15](#) (page 9-37) to provide fast recoverability to a window greater than 24 hours. [Example 9-16](#) (page 9-39) shows how to maintain a window of 7 days by specifying the beginning time of your window of recoverability in the RECOVER command.

Example 9-16 Advanced Incremental Update Script

```

RUN
{
  RECOVER COPY OF DATABASE
    WITH TAG 'incr_update'
    UNTIL TIME 'SYSDATE - 7';
  BACKUP
    INCREMENTAL LEVEL 1
    FOR RECOVER OF COPY WITH TAG 'incr_update'
    DATABASE;
}

```

[Table 9-3](#) (page 9-39) shows the effect of the script when it is run once per day starting on Monday, January 1.

Table 9-3 Effect of Advanced Script When Run Daily

Command	Monday 1/1	Tuesday 1/2 - Monday 1/8	Tuesday 1/9	Wednesday 1/10 Onward
RECOVER	Because no incremental backup or data file copy exists, the command generates a message (but not an error). That is, the command has no effect.	A database copy exists, but SYSDATE-7 specifies a time <i>before</i> the base copy was created. For example, on Wednesday SYSDATE-7 specifies the Wednesday <i>before</i> Monday 1/1. Thus, the RECOVER command has no effect.	SYSDATE-7 now specifies a date <i>after</i> the base copy was created. The database copy made on Monday 1/1 is updated with the incremental backup made on Tuesday 1/2, bringing the copy up to the checkpoint SCN of the level 1 incremental backup.	The database copy is updated with the incremental backup made 7 days ago, bringing the copy up to the checkpoint SCN of the level 1 incremental backup.

Table 9-3 (Cont.) Effect of Advanced Script When Run Daily

Command	Monday 1/1	Tuesday 1/2 - Monday 1/8	Tuesday 1/9	Wednesday 1/10 Onward
BACKUP	No level 0 image copy exists, so the command creates an image copy of the database and applies the tag <code>incr_update</code> . This copy is needed to begin the cycle of incremental updates. Note: If the script sets <code>DEVICE TYPE sbt</code> , then the first run creates the copy on disk, not on tape. Subsequent runs make level 1 backups on tape.	The command makes an incremental level 1 backup and assigns it the tag <code>incr_update</code> . This backup contains blocks that changed between yesterday and today.	The command makes an incremental level 1 backup and assigns it the tag <code>incr_update</code> . This backup contains blocks that changed between Monday 1/8 and Tuesday 1/9.	The command makes an incremental level 1 backup and assigns it the tag <code>incr_update</code> . This backup contains blocks that changed between yesterday and today.

As with the basic script in [Example 9-15](#) (page 9-37), you have fast recoverability to any point in time between the SCN of the data file copies and the present. RMAN can use both block changes from the incremental backups and individual changes from the redo logs. Because you have the daily level 1 incremental backups, you never need to apply more than 1 day of redo.

See Also:

Oracle Database Backup and Recovery Reference to learn about the `RECOVER` command

9.8.5 Using Block Change Tracking to Improve Incremental Backup Performance

The block change tracking feature for incremental backups improves backup performance by recording changed blocks for each data file.

This section contains the following topics:

- [About Block Change Tracking](#) (page 9-40)
- [Enabling and Disabling Block Change Tracking](#) (page 9-42)
- [Disabling Block Change Tracking](#) (page 9-43)
- [Checking Whether Change Tracking Is Enabled](#) (page 9-43)
- [Changing the Location of the Block Change Tracking File](#) (page 9-43)

9.8.5.1 About Block Change Tracking

If block change tracking is enabled on a primary or standby database, then RMAN uses a block change tracking file to identify changed blocks for incremental backups.

By reading this small bitmap file to determine which blocks changed, RMAN avoids having to scan every block in the data file that it is backing up.

Block change tracking is disabled by default. Nevertheless, the benefits of avoiding full data file scans during backup are considerable, especially if only a small percentage of data blocks are changed between backups. If your backup strategy involves incremental backups, then block change tracking is recommended. Block change tracking does not change the commands used to perform incremental backups. The [block change tracking file](#) requires no maintenance after initial configuration.

You can only enable block change tracking at a physical standby database if a license for the Oracle Active Data Guard option is enabled.

9.8.5.1.1 About Space Management in the Block Change Tracking File

Oracle Database automatically manages space in the change tracking file to retain block change data that covers the eight most recent backups. After the maximum of eight bitmaps is reached, the oldest bitmap is overwritten by the bitmap that tracks the current changes.

The block change tracking file maintains bitmaps that mark changes in the data files between backups. The database performs a bitmap switch before each backup.

The first level 0 incremental backup scans the entire data file. Subsequent incremental backups use the block change tracking file to scan only the blocks that have been marked as changed since the last backup. An incremental backup can be optimized only when it is based on a parent backup that was made after the start of the oldest bitmap in the block change tracking file.

Consider the eight-bitmap limit when developing your incremental backup strategy. For example, if you make a level 0 database backup followed by seven differential incremental backups, then the block change tracking file now includes eight bitmaps. If you then make a cumulative level 1 incremental backup, then RMAN cannot optimize the backup, because the bitmap corresponding to the parent level 0 backup is overwritten with the bitmap that tracks the current changes.

9.8.5.1.2 Location of the Block Change Tracking File

By default, the block change tracking file is created as an Oracle managed file in the destination specified by the `DB_CREATE_FILE_DEST` initialization parameter. You can also place the block change tracking file in any location that you choose, by specifying its name when enabling block change tracking.

One block change tracking file is created for the whole database. Oracle recommends against using a raw device (that is, a disk without a file system) as a change tracking file.

Note:

In an Oracle Real Application Clusters (Oracle RAC) environment, the change tracking file must be located on shared storage accessible from all nodes in the cluster.

RMAN does not support backup and recovery of the change tracking file. The database resets the change tracking file when it determines that the change tracking file is invalid. If you restore and recover the whole database or a subset, then the database resets the block change tracking file and starts tracking changes again. After

you make a level 0 incremental backup, the next incremental backup can use change tracking data.

9.8.5.1.3 About the Size of the Block Change Tracking File

The size of the block change tracking file is proportional to the size of the database and the number of enabled threads of redo.

The size of the block change tracking file can increase and decrease as the database changes. The size is not related to the frequency of updates to the database. Typically, the space required for block change tracking for a single instance is approximately 1/30,000 the size of the data blocks to be tracked. For an Oracle RAC environment, it is 1/30,000 of the size of the database, times the number of enabled threads.

The following factors that may cause the file to be larger than this estimate suggests:

- To avoid the overhead of allocating space as your database grows, the block change tracking file size starts at 10 megabytes. New space is allocated in 10 MB increments. Thus, for any database up to approximately 300 gigabytes, the file size is no smaller than 10 MB, for up to approximately 600 gigabytes the file size is no smaller than 20 megabytes, and so on.
- For each data file, a minimum of 320 kilobytes of space is allocated in the block change tracking file, regardless of the size of the data file. Thus, if you have a large number of relatively small data files, the change tracking file is larger than for databases with a smaller number of larger data files containing the same data.

9.8.5.2 Enabling and Disabling Block Change Tracking

You can enable block change tracking when the database is either open or mounted.

This section assumes that you intend to create the block change tracking file as an [Oracle managed file](#) in the [database area](#), which is where the database maintains active database files such as data files, control files, and online redo log files. See "[Overview of Files in the Fast Recovery Area](#) (page 5-19)" to learn about the database area and [fast recovery area](#).

To enable block change tracking:

1. Start SQL*Plus and connect to a target database with administrator privileges.
2. Ensure that the `DB_CREATE_FILE_DEST` initialization parameter is set.

```
SHOW PARAMETER DB_CREATE_FILE_DEST
```

If the parameter is not set, and if the database is open, then you can set the parameter with the following form of the `ALTER SYSTEM` statement:

```
ALTER SYSTEM SET
  DB_CREATE_FILE_DEST = '/disk1/bct/'
  SCOPE=BOTH SID='*';
```

3. Enable block change tracking.

Execute the following `ALTER DATABASE` statement:

```
ALTER DATABASE ENABLE BLOCK CHANGE TRACKING;
```

You can also create the change tracking file in a location that you choose yourself by using the following form of SQL statement:

```
ALTER DATABASE ENABLE BLOCK CHANGE TRACKING
  USING FILE '/mydir/rman_change_track.f' REUSE;
```

The REUSE option tells Oracle Database to overwrite any existing block change tracking file with the specified name.

9.8.5.3 Disabling Block Change Tracking

When you disable block change tracking, the database removes the block change tracking file from the operating system.

This section assumes that the block change tracking feature is currently enabled.

To disable block change tracking:

1. Start SQL*Plus and connect to a target database with administrator privileges.
2. Ensure that the target database is mounted or open.
3. Disable block change tracking.

Execute the following ALTER DATABASE statement:

```
ALTER DATABASE DISABLE BLOCK CHANGE TRACKING;
```

9.8.5.4 Checking Whether Change Tracking Is Enabled

You can query the V\$BLOCK_CHANGE_TRACKING view to determine whether change tracking is enabled, and if it is, the file name of the block change tracking file.

To determine whether change tracking is enabled:

Enter the following query in SQL*Plus (sample output included):

```
COL STATUS   FORMAT A8
COL FILENAME FORMAT A60

SELECT STATUS, FILENAME
FROM   V$BLOCK_CHANGE_TRACKING;

STATUS   FILENAME
-----
ENABLED  /disk1/bct/RDBMS/changetracking/ol_mf_2f71np5j_.chg
```

9.8.5.5 Changing the Location of the Block Change Tracking File

To move the change tracking file, use the ALTER DATABASE RENAME FILE statement.

The database must be mounted. The statement updates the control file to refer to the new location and preserves the contents of the change tracking file. If you cannot shut down the database, then you can disable and enable block change tracking. In this case, you lose the contents of the existing block change tracking file.

To change the location of the change tracking file:

1. Start SQL*Plus and connect to a target database.
2. If necessary, determine the current name of the change tracking file:

```
SQL> SELECT FILENAME FROM V$BLOCK_CHANGE_TRACKING;
```

3. If possible, shut down the database. For example:

```
SQL> SHUTDOWN IMMEDIATE
```

If you shut down the database, then skip to the next step. If you choose not to shut down the database, then execute the following SQL statements and skip all remaining steps:

```
SQL> ALTER DATABASE DISABLE BLOCK CHANGE TRACKING;
SQL> ALTER DATABASE ENABLE BLOCK CHANGE TRACKING USING FILE 'new_location';
```

In this case you lose the contents of the block change tracking file.

4. Using host operating system commands, move the block change tracking file to its new location.
5. Mount the database and move the change tracking file to a location that has more space. For example:

```
ALTER DATABASE RENAME FILE
  '/disk1/bct/RDBMS/changetracking/o1_mf_2f71np5j_.chg' TO
  '/disk2/bct/RDBMS/changetracking/o1_mf_2f71np5j_.chg';
```

This statement changes the location of the change tracking file while preserving its contents.

6. Open the database:

```
SQL> ALTER DATABASE OPEN;
```

See Also:

Oracle Database SQL Language Reference to learn about the `ALTER DATABASE` statement and the `ALTER SYSTEM` statement

9.9 Making Database Backups for Long-Term Storage

This section explains the basic concepts and tasks involved in making backups for long-term storage.

This section contains the following topics:

- [Purpose of Archival Backups](#) (page 9-44)
- [Basic Concepts of Archival Backups](#) (page 9-45)
- [Making an Archival Backup for Long-Term Storage](#) (page 9-46)
- [Making a Temporary Archival Backup](#) (page 9-47)

9.9.1 Purpose of Archival Backups

You can use `BACKUP . . . KEEP` to create a backup that is both all-inclusive and exempt from the backup retention policy.

The backup is all-inclusive because every file needed to restore and recover the database is backed up to a single disk or tape location. The `KEEP` option also specifies that the backup is exempt from the retention policy either forever or for a specified

period. The general name for a backup created with `BACKUP . . . KEEP` is an [archival backup](#).

As explained in "[About Data Archival](#) (page 1-4)", one purpose of a backup and recovery strategy is to preserve data. You can use `BACKUP . . . KEEP` to retain a database backup for longer than the time dictated by the retention policy. For example, you can back up the database on the first day of every year to satisfy a regulatory requirement and store the media off-site. Years after you make the archival backup, you can restore and recover it to query the data as it appeared at the time of the backup.

Another purpose of an archival backup is to create a backup that you want to restore for testing purposes and then delete. For example, you can back up the database, restore the database in a test environment, and then discard the archival backup after the test database is operational. A related purpose is to create a self-contained backup that you can delete after transferring it to another user or host. For example, another user might want a copy of the database for reporting or testing.

9.9.2 Basic Concepts of Archival Backups

You can exempt a backup from the retention policy by using the `KEEP` option with the `BACKUP` command.

You can also use the `KEEP` and `NOKEEP` options of the `CHANGE` command to change the status of an existing backup. Backups with `KEEP` attributes are valid backups that can be recovered like any other backups.

You can specify an end date for an archival backup with the `KEEP UNTIL TIME` clause, or specify that the backup is kept `FOREVER`. If you specify `UNTIL`, then `RMAN` marks the backup as obsolete when the `UNTIL` time has passed, regardless of any configured retention policy. For example, if you specify `KEEP UNTIL TIME '01-JAN-13'`, then the backup is obsolete one second after midnight on January 1, 2013. If you specify an `UNTIL TIME` of 9:00 p.m, then the backup is obsolete at 9:01 p.m.

When you specify `KEEP` on the `BACKUP` command, `RMAN` generates multiple backup sets. Note the following characteristics of the `BACKUP . . . KEEP` command:

- It automatically backs up the data files, control file (even if the [control file autobackup](#) is disabled), and the server parameter file.
- It automatically generates an archived redo log backup to ensure that the database backup can be recovered to a consistent state.
- If the `FORMAT`, `POOL`, or `TAG` parameters are specified, then they are used for all backups. For this reason, the `FORMAT` string must allow for the creation of multiple backup pieces. Specifying the `%U` substitution variable is the easiest way to meet this requirement.
- It supports an optional `RESTORE POINT` clause that creates a [normal restore point](#), which is a label for an SCN to which the backup must be recovered to be made consistent. The SCN is captured just after the data file backups complete. `RMAN` resynchronizes restore points with the [recovery catalog](#) and maintains the restore points while the backup exists.

See Also:

- [Listing Restore Points Using the LIST Command](#) (page 7-14) for information on how to display restore points
 - *Oracle Database Backup and Recovery Reference* for CHANGE syntax
 - *Oracle Database Backup and Recovery Reference* for BACKUP . . . KEEP syntax
-
-

9.9.3 Making an Archival Backup for Long-Term Storage

Typically, you make an archival backup to tape. Because your data protection backups are most likely to be on a set of tapes that remain accessible and are recycled, it is advisable to reserve a set of tapes for the archival backup.

You can write the archival backup to this special set of tapes and then place them in off-site storage. You can vary the procedure for creating an archival backup by creating a [stored script](#) or shell script that updates dynamically. When you run the script, you can dynamically set the name of the restore point, backup format, and so on.

See Also:

- [Using Substitution Variables in Command Files](#) (page 4-14)
 - [Creating and Executing Dynamic Stored Scripts](#) (page 13-23) to learn how to make archival backups with RMAN command files
-
-

9.9.3.1 Making an Archival Backup

Use the BACKUP command with the KEEP option to make archival backups.

This scenario makes a long-term archival backup with a backup [tag](#) of QUARTERLY and assigns it to a special family of Oracle Secure Backup tapes reserved for long-term storage. Note the following features of this example:

- The FOREVER keyword indicates that this backup is never eligible for deletion by the [backup retention policy](#).
- The BACKUP command creates the restore point named FY06Q4 to match the SCN at which point this backup is consistent.

To make a long-term archival backup:

1. Start RMAN and connect to a target database and recovery catalog.

The target database can be open or mounted. A recovery catalog is required for KEEP FOREVER, but is not required for any other KEEP option.

See Also:

[Making Database Connections with RMAN](#) (page 4-2)

2. Run BACKUP . . . KEEP to make the backup.

The following example generates a data file and archived log backup and creates a [normal restore point](#). The specified restore point must not already exist.

The log backup contains just those archived logs needed to restore this backup to a consistent state. The database performs an online redo log switch to archive the redo that is in the current online logs and is necessary to make this new backup consistent. The control file autobackup has a copy of the restore point, so it can be referenced as soon as the control file is restored.

```
RUN
{
  ALLOCATE CHANNEL c1
    DEVICE TYPE sbt
    PARMS 'ENV=(OB_MEDIA_FAMILY=archival_backup)';
  BACKUP DATABASE
    TAG quarterly
    KEEP FOREVER
    RESTORE POINT FY06Q4;
}
```

The following variation keeps the backup for 365 days instead of keeping it forever. After a year has passed, the backup becomes obsolete regardless of the backup retention policy settings.

```
RUN
{
  ALLOCATE CHANNEL c1 DEVICE TYPE sbt
    PARMS 'ENV=(OB_MEDIA_FAMILY=archival_backup)';
  BACKUP DATABASE
    TAG quarterly
    KEEP UNTIL TIME 'SYSDATE+365'
    RESTORE POINT FY06Q4;
}
```

See Also:

[Overview of Flashback Database, Restore Points and Guaranteed Restore Points](#) (page 7-1) to learn about restore points

9.9.4 Making a Temporary Archival Backup

One purpose of an archival backup is to create a test database.

The technique for making a test database is essentially the same as the technique described in "[Making an Archival Backup for Long-Term Storage](#) (page 9-46)". The difference is that you intend to delete the backup soon after creating it.

You can specify the temporary status of the backup with the BACKUP . . . KEEP UNTIL parameter. Assume that you want to make a backup and then restore it to a new host the same day. In this case, you can specify KEEP UNTIL TIME SYSDATE+1 to indicate that RMAN overrides the retention policy for this backup for only one day. After one day, the backup becomes obsolete, regardless of any configured backup retention policy.

The command in [Example 9-17](#) (page 9-48) makes an archival backup on a temporary disk with the tag TESTDB. The example creates a normal restore point, which is a label for the time to which the backup is recovered. RMAN only backs up the archived redo

logs if the database is open during the backup. Archived logs are not needed for offline backups and so are not backed up.

Example 9-17 Creating a Temporary Archival Backup

```
BACKUP DATABASE
  FORMAT '/disk1/oraclebck/%U'
  TAG TESTDB
  KEEP UNTIL TIME 'SYSDATE+1'
  RESTORE POINT TESTDB06;
```

The recommended technique for restoring an archival backup is to use the `DUPLICATE` command.

9.10 Backing Up RMAN Backups

This section explains how to back up backup sets and image copies and contains the following topics:

- [About Backups of RMAN Backups](#) (page 9-48)
- [Backing Up Backup Sets with RMAN](#) (page 9-50)
- [Backing Up Image Copy Backups with RMAN](#) (page 9-51)

9.10.1 About Backups of RMAN Backups

You can use the `BACKUP BACKUPSET` command to back up backup sets produced by other backup jobs. You can also use `BACKUP RECOVERY AREA` to back up recovery files created in the current and all previous fast recovery area destinations.

Recovery files are full and incremental backup sets, control file autobackups, data file copies, and archived redo logs. SBT and disk backups are supported for `BACKUP RECOVERY AREA`. For disk backups of the recovery files, you must use the `TO DESTINATION` option.

The preceding commands are especially useful in the following scenarios:

- Ensuring that all backups exist both on disk and on tape.
- Moving backups from disk to tape and then freeing space on disk. This task is especially important when the database uses a fast recovery area so that the space can be reused as needed.

You can also use the `BACKUP COPY OF` command to back up image copies of data files, control files, and archived redo logs. The output of this command can be either backup sets or image copies, so you can generate backup sets from image copies. This form of backup is used to back up a database backup created as image copies on disk to tape.

Note:

In a multitenant environment, you cannot back up backup sets and image copies of PDBs that have been dropped. RMAN skips backing up these backups.

5. Generate a report to see the effect of these copies under a redundancy-based backup retention policy.

For example, issue the following command:

```
REPORT OBSOLETE REDUNDANCY 1;
```

No copy is reported as obsolete because both copies of the backup set have the same values for `set_stamp` and `set_count`.

6. Generate a report to see the effect of these copies under a recovery window-based backup retention policy.

For example, issue the following command:

```
REPORT OBSOLETE RECOVERY WINDOW OF 1 DAYS;
```

No copy of the backup set is reported as obsolete or based on the `CHECKPOINT_CHANGE#` of this backup set, with the current time and the availability of other backups.

See Also:

- [Configuring a Redundancy-Based Retention Policy](#) (page 5-30)
 - [Reporting on RMAN Operations](#) (page 11-1) to learn how to use the `LIST` and `REPORT` commands
-

9.10.2 Backing Up Backup Sets with RMAN

Use the `BACKUP BACKUPSET` command to copy backup sets from disk to tape.

The procedure in this section assumes that you have configured an [SBT](#) device as your default device.

To back up backup sets from disk to tape:

1. If you are backing up a subset of available backup sets, then execute the `LIST BACKUPSET` command to obtain their primary keys.

The following example lists the backup sets in summary form:

```
RMAN> LIST BACKUPSET SUMMARY;
```

```
List of Backups
=====
Key TY LV S Device Type Completion Time #Pieces #Copies Comp Tag
-----
1 B F A DISK 28-MAY-13 1 1 NO TAG20070528T132432
2 B F A DISK 29-MAY-13 1 1 NO TAG20070529T132433
3 B F A DISK 30-MAY-13 1 1 NO TAG20070530T132434
```

The following example lists details about backup set 3:

```
RMAN> LIST BACKUPSET 3;
```

```
List of Backup Sets
=====
```

```

BS Key  Type LV Size      Device Type Elapsed Time Completion Time
-----
3       Full  8.33M    DISK        00:00:01    30-MAY-13
      BP Key: 3   Status: AVAILABLE Compressed: NO Tag: TAG20070530T132434
      Piece Name: /disk1/oracle/dbs/c-35764265-20070530-02
      Control File Included: Ckp SCN: 397221      Ckp time: 30-MAY-13
      SPFILE Included: Modification time: 30-MAY-13
      SPFILE db_unique_name: PROD

```

2. Execute the `BACKUP BACKUPSET` command.

The following example backs up all disk backup sets to tape and then deletes the input disk backups:

```

BACKUP BACKUPSET ALL
DELETE INPUT;

```

The following example backs up only the backup sets with the primary key 1 and 2 to tape and then deletes the input disk backups:

```

BACKUP BACKUPSET 1,2
DELETE INPUT;

```

3. Optionally, execute the `LIST` command to see a listing of backup sets and pieces.

The output lists all copies, including backup piece copies created by `BACKUP BACKUPSET`.

9.10.3 Backing Up Image Copy Backups with RMAN

Use the `BACKUP` command to back up image copies to tape.

This section assumes that you have configured an [SBT](#) device as your default device.

When you back up image copies that have multiple copies of the data files, specifying tags for the backups makes it easier to identify the input image copy. All image copies of data files have tags. The [tag](#) of an image copy is inherited by default when the image copy is backed up as a new image copy.

To back up image copies from disk to tape:

1. Issue the `BACKUP . . . COPY OF` or `BACKUP DATAFILECOPY` command.

The following example backs up data file copies that have the tag `DBCOPY`:

```

BACKUP DATAFILECOPY FROM TAG DBCOPY;

```

The following example backs up the latest image copies of a database to tape, assigns the tag `QUARTERLY_BACKUP`, and deletes the input disk backups:

```

BACKUP DEVICE TYPE sbt
TAG "quarterly_backup"
COPY OF DATABASE
DELETE INPUT;

```

2. Optionally, issue the `LIST` command to see a listing of backup sets. The output lists all copies, including backup piece copies created by the `BACKUP` command with the `BACKUPSET` clause.

Backing Up the Database: Advanced Topics

This chapter explains advanced RMAN backup procedures. This chapter contains the following topics:

- [Limiting the Size of RMAN Backup Sets](#) (page 10-1)
- [Using Backup Optimization to Skip Files](#) (page 10-4)
- [Skipping Offline, Read-Only, and Inaccessible Files](#) (page 10-7)
- [Duplexing Backup Sets](#) (page 10-7)
- [Making Split Mirror Backups with RMAN](#) (page 10-9)
- [Encrypting RMAN Backups](#) (page 10-11)
- [Restarting RMAN Backups](#) (page 10-13)
- [Managing Backup Windows](#) (page 10-15)

See Also:

[Backing Up the Database](#) (page 9-1) for basic backup procedures

10.1 Limiting the Size of RMAN Backup Sets

You can use the `CONFIGURE` command to create persistent settings that govern backup set size.

This control is helpful when backing up very large files. If you do not have a backup set size persistently configured, then you can also use the `BACKUP . . . MAXSETSIZE` command to limit the size of backup sets.

You can use the `CONFIGURE` command, but not the `BACKUP` command, to set a limit for the size of individual backup pieces. This control is especially useful when you use a media manager that has restrictions on the sizes of files, or when you must back up very large files.

See Also:

- [Configuring the Maximum Size of Backup Sets](#) (page 6-4)
 - [Configuring the Maximum Size of Backup Pieces](#) (page 6-5)
-
-

This section contains the following topics:

- [About Backup Set Size](#) (page 10-2)
- [Limiting the Size of Backup Sets with BACKUP ... MAXSETSIZE](#) (page 10-2)
- [Dividing the Backup of a Large Data File into Sections](#) (page 10-3)

10.1.1 About Backup Set Size

The `MAXSETSIZE` parameter of the `BACKUP` command specifies a maximum size for a backup set in units of bytes (default), kilobytes, megabytes, or gigabytes.

For example, to limit a backup set to 305 MB, specify `MAXSETSIZE 305M`. RMAN attempts to limit all backup sets to this size.

You can use `BACKUP . . . MAXSETSIZE` to limit the size of backup sets so that the database is divided among multiple backup sets. If the backup fails part way through, then you can use the restartable backup feature to back up only those files that were not backed up during the previous attempt.

In some cases the `MAXSETSIZE` value may be too small to contain the largest file that you are backing up. When determining whether `MAXSETSIZE` is too small, RMAN uses the size of the original data file rather than the file size after compression. RMAN displays an error stack such as the following:

```
RMAN-00571: =====  
RMAN-00569: ===== ERROR MESSAGE STACK FOLLOWS =====  
RMAN-00571: =====  
RMAN-03002: failure of backup command at 11/03/13 14:40:33  
RMAN-06182: archive log larger than MAXSETSIZE: thread 1 seq 1  
             /oracle/oradata/trgt/arch/archive1_1.dbf
```

See Also:

- [Restarting RMAN Backups](#) (page 10-13) for information on how to restart RMAN backups
 - *Oracle Database Backup and Recovery Reference* to learn about the `CONFIGURE MAXSETSIZE` command
-

10.1.2 Limiting the Size of Backup Sets with BACKUP ... MAXSETSIZE

Backup piece size is an issue in those situations where it exceeds the maximum file size of the file system or media management software. Use the `MAXSETSIZE` parameter of the `CONFIGURE CHANNEL` or `ALLOCATE CHANNEL` command to limit the size of backup pieces.

To limit the size of backup sets:

1. Start RMAN and connect to a target database and recovery catalog (if used).

See Also:

[Making Database Connections with RMAN](#) (page 4-2)

2. Execute the `BACKUP` command with the `MAXSETSIZE` parameter.

The following example backs up archived logs to tape, limiting the size of each backup set to 100 MB:

```
BACKUP DEVICE TYPE sbt
      MAXSETSIZE 100M
      ARCHIVELOG ALL;
```

10.1.3 Dividing the Backup of a Large Data File into Sections

If you specify the `SECTION SIZE` parameter on the `BACKUP` command, then RMAN creates a backup set in which each backup piece contains the blocks from one file section.

A [file section](#) is a contiguous range of blocks in a file. This type of backup is called a [multisection backup](#).

Note:

You cannot specify `SECTION SIZE` with `MAXPIECESIZE`.

The purpose of multisection backups is to enable RMAN channels to back up a single large file in parallel. RMAN divides the work among multiple channels, with each channel backing up one file section in a file. Backing up a file in separate sections can improve the performance of backups of large data files.

If a multisection backup completes successfully, then no backup set generated during the backup contains a partial data file. If a multisection backup is unsuccessful, then the RMAN metadata can contain a record for a partial backup set. RMAN does not consider partial backups for restore and recovery. You must use the `DELETE` command to delete the partial backup set.

If you specify a section size that is larger than the size of the file, then RMAN does not use multisection backup for the file. If you specify a small section size that would produce more than 256 sections, then RMAN increases the section size to a value that results in exactly 256 sections.

To make a multisection backup:

1. Start RMAN and connect to a target database and recovery catalog (if used).
2. If necessary, configure channel parallelism so that RMAN can make the backup parallel.
3. Execute `BACKUP` with the `SECTION SIZE` parameter.

For example, suppose that the `users` tablespace contains a single data file of 900 MB. Also assume that three SBT channels are configured, with the parallelism setting for the SBT device set to 3. You can break up the data file in this tablespace into file sections as shown in the following example:

```
BACKUP
      SECTION SIZE 300M
      TABLESPACE users;
```

In this example, each of the three SBT channels backs up a 300 MB file section of the `users` data file.

See Also:

[Make Parallel the Validation of a Data File](#) (page 16-6) to learn how to validate sections of a large data file

10.2 Using Backup Optimization to Skip Files

You run the `CONFIGURE BACKUP OPTIMIZATION` command to enable backup optimization. When certain criteria are met, RMAN skips backups of files that are identical to files that are already backed up.

For the following scenarios, assume that you configure backup optimization and a retention policy as shown in the following example.

Example 10-1 Configuring Backup Optimization

```
CONFIGURE DEFAULT DEVICE TYPE TO sbt;  
CONFIGURE BACKUP OPTIMIZATION ON;  
CONFIGURE RETENTION POLICY TO RECOVERY WINDOW OF 4 DAYS;
```

With RMAN configured as shown in [Example 10-1](#) (page 10-4), you run the following command every night to back up the database to tape:

```
BACKUP DATABASE;
```

Because backup optimization is configured, RMAN skips backups of offline and read-only data files only if the most recent backups were made on or after the earliest point in the recovery window. RMAN does not skip backups when the most recent backups are older than the window. For example, optimization ensures you do not end up with a new backup of a read-only data file every night, so long as one backup set containing this file exists within the recovery window.

See Also:

- [Backup Optimization and the CONFIGURE command](#) (page 5-31)
 - [About Backup Optimization for SBT Backups with Recovery Window Retention Policy](#) (page 5-33) for a scenario involving backup optimization and recovery windows
 - *Oracle Database Backup and Recovery Reference* for a detailed description of criteria used by `CONFIGURE BACKUP OPTIMIZATION` to determine whether a file is identical and can potentially be skipped
-

10.2.1 Optimizing a Daily Archived Log Backup to a Single Tape: Scenario

Assume that you want to back up all the archived logs every night, but you do not want to have multiple copies of each log sequence number. With RMAN configured as shown in [Example 10-1](#) (page 10-4), you run the following command in a script nightly at 1 a.m.:

```
BACKUP DEVICE TYPE sbt  
ARCHIVELOG ALL;
```

RMAN skips all logs except those produced in the last 24 hours. In this way, you keep only one copy of each archived log on tape.

10.2.2 Optimizing a Daily Archived Log Backup to Multiple Media Families: Scenario

In Oracle Secure Backup, a media family is a named group of volumes with a set of shared, user-defined attributes. In this scenario, you back up logs that are not on tape to one media family, then back up the same logs to a second media family. Finally, you delete old logs.

With RMAN configured as shown in [Example 10-2](#) (page 10-5), run the following script at the same time every night to back up the logs generated during the previous day to two separate media families.

Example 10-2 Backing Up Archived Redo Logs to Multiple Media Families

```
# The following command backs up just the logs that are not on tape. The
# first copies are saved to the tapes from the media family "log_family1".
RUN
{
  ALLOCATE CHANNEL c1 DEVICE TYPE sbt
    PARMS 'ENV=(OB_MEDIA_FAMILY=log_family1)';
  BACKUP ARCHIVELOG ALL;
}
# Make one more copy of the archived logs and save them to tapes from a
# different media family
RUN
{
  ALLOCATE CHANNEL c2 DEVICE TYPE sbt
    PARMS 'ENV=(OB_MEDIA_FAMILY=log_family2)';
  BACKUP ARCHIVELOG
    NOT BACKED UP 2 TIMES;
}
```

If your goal is to delete logs from disk that have been backed up two times to SBT, then the simplest way to achieve the goal is with an [archived redo log deletion policy](#). The following one-time configuration specifies that archived redo logs are eligible for deletion from disk if two archived log backups exist on tape:

```
CONFIGURE ARCHIVELOG DELETION POLICY
  TO BACKED UP 2 TIMES TO DEVICE TYPE sbt;
```

After running the script in [Example 10-2](#) (page 10-5), you can delete unneeded logs by executing `DELETE ARCHIVELOG ALL`.

10.2.3 Creating a Weekly Secondary Backup of Archived Logs: Example

Assume a more sophisticated scenario in which your goal is to back up the archived logs to tape every day. You are worried about tape failure, however, so you want to ensure that you have more than one copy of each log sequence number on a separate tape before you perform your weekly deletion of logs from disk. This scenario assumes that the database is not using a fast recovery area.

First, perform a one-time configuration as follows:

```
CONFIGURE BACKUP OPTIMIZATION ON;
CONFIGURE DEVICE TYPE sbt PARALLELISM 1;
CONFIGURE default DEVICE TYPE TO sbt;
CONFIGURE CHANNEL DEVICE TYPE sbt PARMS 'ENV=(OB_MEDIA_FAMILY=first_copy);
```

Because you have optimization enabled, you can run the following command every evening to back up all archived logs to the `first_copy` media family that have not already been backed up:

```
BACKUP ARCHIVELOG ALL TAG first_copy;
```

Every Friday evening you create an additional backup of all archived logs in a different media family. After the backup, you want to delete all archived logs that have at least two copies on tape. So you run the following script:

```
RUN
{
  # manually allocate a channel, to specify that the backup run by this
  # channel goes to both media families "first_copy" and "second_copy"
  ALLOCATE CHANNEL c1 DEVICE TYPE sbt
    PARMS 'ENV=(OB_MEDIA_FAMILY=second_copy)';
  ALLOCATE CHANNEL c2 DEVICE TYPE sbt
    PARMS 'ENV=(OB_MEDIA_FAMILY=first_copy)';
  BACKUP
    CHANNEL c1
    ARCHIVELOG
    UNTIL TIME 'SYSDATE'
    NOT BACKED UP 2 TIMES # back up only logs without 2 backups on tape
    TAG SECOND_COPY;
  BACKUP
    CHANNEL c2
    ARCHIVELOG
    UNTIL TIME 'SYSDATE'
    NOT BACKED UP 2 TIMES # back up only logs without 2 backups on tape
    TAG FIRST_COPY;
}

# now delete from disk all logs that have been backed up to tape at least twice
DELETE
  ARCHIVELOG ALL
  BACKED UP 2 TIMES TO DEVICE TYPE sbt;
```

The following table explains the effects of the daily and weekly backup scripts.

Table 10-1 Effects of Daily and Weekly Scripts

Script	Tape Contents After Script	Disk Contents After Script
Daily	Archived logs that have not yet been backed up are now in media family <code>first_copy</code> .	All archived logs created since the last <code>DELETE</code> command are still on disk.
Weekly	Archived logs that have fewer than two backups on tape are now in media families <code>first_copy</code> and <code>second_copy</code> .	All archived logs that have been backed up at least twice to tape are deleted.

After the weekly backup, you can send the tape from the media family `second_copy` to offsite storage. Use this tape backup only if the primary tape from pool `first_copy` is damaged. Because the secondary tape is offsite, you do not want RMAN to use it for recovery, so you can mark the backup as unavailable:

```
CHANGE BACKUP OF ARCHIVELOG TAG SECOND_COPY UNAVAILABLE;
```

See Also:

- [Maintaining RMAN Backups and Repository Records](#) (page 12-1) to learn how to change the status of and delete backups
- *Oracle Database Backup and Recovery Reference* to learn about the CHANGE and DELETE commands

10.3 Skipping Offline, Read-Only, and Inaccessible Files

By default, the BACKUP command terminates when it cannot access a data file.

You can specify parameters to prevent termination, as listed in [Table 10-2](#) (page 10-7).

Table 10-2 *BACKUP ... SKIP Options*

If you specify...	Then RMAN skips...
SKIP INACCESSIBLE	Data files that RMAN cannot read.
SKIP OFFLINE	Offline data files. Some offline data files can still be read because they exist on disk. Others have been deleted or moved and so cannot be read, making them inaccessible.
SKIP READONLY	Data files in read-only tablespaces.

The following example uses an automatic channel to back up the database, and skips all data files that might cause the backup job to terminate.

Example 10-3 *Skipping Files During an RMAN Backup*

```
BACKUP DATABASE
SKIP INACCESSIBLE
SKIP READONLY
SKIP OFFLINE;
```

10.4 Duplexing Backup Sets

RMAN can make up to four copies of a backup set simultaneously, each an exact duplicate of the others.

A copy of a [duplexed backup set](#) is a copy of each backup piece in the backup set, with each copy getting a unique copy number (for example, 0tcm8u2s_1_1 and 0tcm8u2s_1_2). It is not possible to duplex backup sets to the [fast recovery area](#).

You can use BACKUP . . . COPIES or CONFIGURE . . . BACKUP COPIES to duplex backup sets. RMAN can duplex backups to either disk or tape, but cannot duplex backups to tape and disk simultaneously. For DISK channels, specify multiple values in the FORMAT option to direct the multiple copies to different physical disks. For SBT channels, if you use a media manager that supports Version 2 of the SBT API, then the media manager automatically writes each copy to a separate medium (for example, a separate tape). When backing up to tape, ensure that the number of copies does not exceed the number of available tape devices.

Duplexing applies only to backup sets, not image copies. It is an error to specify the BACKUP . . . COPIES when creating image copy backups, and the CONFIGURE . . . BACKUP COPIES setting is ignored for image copy backups.

See Also:

[About Multiple Copies of RMAN Backups](#) (page 8-13) for a conceptual overview of RMAN backup copies

10.4.1 Duplexing Backup Sets with CONFIGURE BACKUP COPIES

The `CONFIGURE . . . BACKUP COPIES` command specifies the number of identical backup sets to create on the specified device type.

This setting applies to all backup sets except control file autobackups (because the autobackup of a control file always produces one copy) and backup sets when backed up with the `BACKUP BACKUPSET` command.

To duplex a backup with CONFIGURE ... BACKUP COPIES:

1. Configure the number of copies on the desired device type for data files and archived redo logs on the desired device types.

By default, `CONFIGURE . . . BACKUP COPIES` is set to 1 for each device type. The following example configures duplexing for data files and archived logs on tape and also duplexing for data files (but not archived redo logs) on disk:

```
CONFIGURE DEVICE TYPE sbt PARALLELISM 1;
CONFIGURE DEFAULT DEVICE TYPE TO sbt;
CONFIGURE CHANNEL DEVICE TYPE DISK FORMAT '/disk1/%U', '/disk2/%U';
CONFIGURE DATAFILE BACKUP COPIES FOR DEVICE TYPE sbt TO 2;
CONFIGURE ARCHIVELOG BACKUP COPIES FOR DEVICE TYPE sbt TO 2;
CONFIGURE DATAFILE BACKUP COPIES FOR DEVICE TYPE DISK TO 2;
```

2. Execute the `BACKUP` command.

The following command backs up the database and archived logs to tape, making two copies of each data file and archived log:

```
BACKUP AS BACKUPSET DATABASE PLUS ARCHIVELOG;
```

Because of the configured formats for the disk channel, the following command backs up the database to disk, placing one copy of the backup sets produced in the `/disk1` directory and the other in the `/disk2` directory:

```
BACKUP DEVICE TYPE DISK AS BACKUPSET DATABASE;
```

If the `FORMAT` clause were not configured on `CONFIGURE CHANNEL`, then you specify `FORMAT` on the `BACKUP` command itself. For example, you issue the following command:

```
BACKUP AS BACKUPSET DATABASE
  FORMAT '/disk1/%U',
         '/disk2/%U';
```

3. Issue a `LIST BACKUP` command to see a listing of backup sets and pieces.

For example, enter the following command:

```
LIST BACKUP SUMMARY;
```

The `#Copies` column shows the number of backup sets, which may have been produced by duplexing or by multiple backup commands.

See Also:

- [Configuring Backup Duplexing](#) (page 6-5)
 - [Configuring Backup Duplexing](#) (page 6-5) to learn about the `CONFIGURE BACKUP COPIES` command
 - [About Configuring the Environment for RMAN Backups](#) (page 5-1) to learn about basic backup configuration option
-

10.4.2 Duplexing Backup Sets with `BACKUP ... COPIES`

The `COPIES` option of the `BACKUP` command overrides every other `COPIES` or `DUPLEX` setting to control duplexing of backup sets.

To duplex a backup with `BACKUP ... COPIES`:

1. Specify the number of identical copies with the `COPIES` option of the `BACKUP` command. For example, run the following to make three copies of each backup set in the default `DISK` location:

```
BACKUP AS BACKUPSET DEVICE TYPE DISK
      COPIES 3
      INCREMENTAL LEVEL 0
      DATABASE;
```

Because you specified `COPIES` in the `BACKUP` command, RMAN makes three backup sets of each data file regardless of the `CONFIGURE DATAFILE COPIES` setting.

2. Issue a `LIST BACKUP` command to see a listing of backup sets and pieces (the `#Copies` column shows the number of copies, which may have been produced through duplexing or through multiple invocations of the `BACKUP` command). For example, enter:

```
LIST BACKUP SUMMARY;
```

10.5 Making Split Mirror Backups with RMAN

Many sites keep a backup of the database stored on disk in case a media failure occurs on the primary database or an incorrect user action requires point-in-time recovery. A data file backup on disk simplifies the restore step of recovery, making recovery much quicker and more reliable.

Caution:

Never make backups, split mirror or otherwise, of online redo logs. Restoring online redo log backups can create two archived logs with the same sequence number but different contents. Also, it is best to use the `BACKUP CONTROLFILE` command rather than a split mirror to make control file backups.

One way of creating a data file backup on disk is to use disk [mirroring](#). For example, the operating system can maintain three identical copies of each file in the database. In this configuration, you can split off a mirrored copy of the database to use as a backup.

RMAN does not automate the splitting of mirrors, but can make use of split mirrors in backup and recovery. For example, RMAN can treat a split mirror of a data file as a data file copy, and can also back up this copy to disk or tape. The procedure in this section explains how to make a [split mirror backup](#) with the ALTER SYSTEM SUSPEND/RESUME functionality.

Some mirroring technology does not require Oracle Database to suspend all I/O before a mirror can be separated and used as a backup. Refer to your storage manager, volume manager, or file system documentation for information about whether you must suspend I/O from the database instance.

To make a split mirror backup of a tablespace by using SUSPEND/RESUME:

1. Start RMAN and then place the tablespaces to back up into backup mode with the ALTER TABLESPACE . . . BEGIN BACKUP statement. (To place all tablespaces in backup mode, you can the ALTER DATABASE BEGIN BACKUP instead.)

For example, to place tablespace `users` in backup mode, you connect RMAN to a target database and run the following SQL command:

```
ALTER TABLESPACE users BEGIN BACKUP;
```

2. Suspend I/O if your mirroring software or hardware requires it. For example, enter the following command in RMAN:

```
ALTER SYSTEM SUSPEND;
```

3. Split the mirrors for the underlying data files contained in these tablespaces.

4. Take the database out of the suspended state. For example, enter the following command in RMAN:

```
ALTER SYSTEM RESUME;
```

5. Take the tablespaces out of backup mode. For example, enter:

```
ALTER TABLESPACE users END BACKUP;
```

You can also use ALTER DATABASE END BACKUP to take all tablespaces out of backup mode.

6. Catalog the user-managed mirror copies as data file copies with the CATALOG command. For example, enter:

```
CATALOG DATAFILECOPY '/dk2/oradata/trgt/users01.dbf'; # catalog split mirror
```

7. Back up the data file copies. For example, run the BACKUP DATAFILECOPY command at the prompt:

```
BACKUP DATAFILECOPY '/dk2/oradata/trgt/users01.dbf';
```

8. When you are ready to [resilver a split mirror](#), first use the CHANGE . . . UNCATALOG command to uncatalog the data file copies you cataloged in Step 6. For example, enter:

```
CHANGE DATAFILECOPY '/dk2/oradata/trgt/users01.dbf' UNCATALOG;
```

9. Resilver the split mirror for the affected data files.

See Also:

- [Making User-Managed Backups in SUSPEND Mode](#) (page 29-16)
 - *Oracle Database Administrator's Guide* for more information about the SUSPEND/RESUME feature
 - *Oracle Database SQL Language Reference* for the ALTER SYSTEM SUSPEND syntax
-
-

10.6 Encrypting RMAN Backups

You can protect RMAN backup sets with backup encryption. Encrypted backups cannot be read if they are obtained by unauthorized users.

The RMAN backup encryption feature requires the Enterprise Edition of the database.

This section contains the following topics:

- [About RMAN Backup Encryption Settings](#) (page 10-11)
- [Making Transparent-Mode Encrypted Backups](#) (page 10-12)
- [Making Password-Mode Encrypted Backups](#) (page 10-12)
- [Making Dual-Mode Encrypted Backups](#) (page 10-13)

10.6.1 About RMAN Backup Encryption Settings

Backup encryption is performed based on the specified encryption settings.

Encryption can be set with the following commands:

- `CONFIGURE ENCRYPTION`

You can use this command to persistently configure transparent encryption. You cannot persistently configure dual mode or password mode encryption.

- `SET ENCRYPTION`

You can use this command to configure dual mode or password mode encryption at the [RMAN session](#) level.

Note:

Keystore-based encryption is more secure than password-based encryption because no passwords are involved. Use password-based encryption only when absolutely necessary because your backups must be transportable.

The database uses a new encryption key for every encrypted backup. The backup encryption key is then encrypted with either the password, the database master key, or both, depending on the chosen encryption mode. Individual backup encryption keys or passwords are never stored in clear text.

A single restore operation can process backups encrypted in different modes. For each backup piece that it restores, RMAN checks whether it is encrypted. Transparently encrypted backups need no intervention if the Oracle keystore is open and available.

If password encryption is detected, then RMAN searches for a matching key in the list of passwords entered in the `SET DECRYPTION` command. If RMAN finds a usable key, then the restore operation proceeds. Otherwise, RMAN searches for a key in the Oracle keystore. If RMAN finds a usable key, then the restore operation proceeds; otherwise, RMAN signals an error that the backup piece cannot be decrypted.

Note:

If RMAN restores a set of backups created with different passwords, then all required passwords must be included with `SET DECRYPTION`.

RMAN encryption is a CPU-intensive operation and can affect backup performance. The actual amount of CPU utilization during encryption depends on whether both input and output devices for disk and SBT produce and consume data faster than the CPU can encrypt it. Here are a few guidelines for managing and trying to maximize CPU performance:

- Because encrypted backups consume more CPU resources than unencrypted backups, you can improve performance of encrypted backups to disk by using more RMAN channels. A general rule is to use the same number of channels as the number of CPU cores in your system. For example, use two channels for a dual-core processor.
- If both the disk subsystem and SBT-subsystem are fast, you can expect very high CPU utilization. You may want to consider slowing the rate of the backup by setting the `RMAN READRATE` parameter. For example, you can set an upper limit for block reads so that RMAN does not consume excessive disk bandwidth and thereby degrade online performance.

See Also:

- [Performing Complete Database Recovery](#) (page 17-12) to learn how to restore password-encrypted backups
 - [Determining the Encryption Status of Backup Pieces](#) (page 11-19)
 - *Oracle Database Backup and Recovery Reference* to learn about the `ENCRYPTION` and `DECRYPTION` options of the `SET` command
-

10.6.2 Making Transparent-Mode Encrypted Backups

If you have configured transparent encryption with the `CONFIGURE` command as explained in "[Configuring RMAN Backup Encryption Modes](#) (page 6-12)", then no additional commands are required to create encrypted backups. Make RMAN backups as normal.

10.6.3 Making Password-Mode Encrypted Backups

You can set an encryption password in an RMAN session by executing the `SET ENCRYPTION BY PASSWORD` command. If transparent encryption is configured, then specify the `ONLY` keyword to indicate that the backups are protected with a password and not with the configured transparent encryption.

Note:

Create a password that is secure. See *Oracle Database Security Guide* for more information.

To make password-mode encrypted backups:

1. Start RMAN and connect to a target database and recovery catalog (if used).
2. Execute the `SET ENCRYPTION ON IDENTIFIED BY password ONLY` command.

The following example sets the encryption password for all tablespaces (where *password* is a placeholder for the actual password that you enter) in the backup and specifies `ONLY` to indicate that the encryption is password-only:

```
SET ENCRYPTION IDENTIFIED BY password ONLY ON FOR ALL TABLESPACES;
```

3. Back up the database.

For example, enter the following command:

```
BACKUP DATABASE PLUS ARCHIVELOG;
```

10.6.4 Making Dual-Mode Encrypted Backups

Use the `SET ENCRYPTION BY PASSWORD` command at the RMAN prompt to make password-protected backups. If transparent encryption is configured, then *omit* the `ONLY` keyword to indicate that the backups are protected with both a password and the configured transparent encryption.

Note:

Create a password that is secure. See *Oracle Database Security Guide* for more information.

To make dual-mode encrypted backups:

1. Start RMAN and connect to a target database and recovery catalog (if used).
2. Execute the `SET ENCRYPTION BY PASSWORD` command, making sure to omit the `ONLY` keyword.

The following example sets the encryption password for all tablespaces (where *password* is a placeholder for the actual password that you enter) in the backup and omits `ONLY` to indicate dual-mode encryption:

```
SET ENCRYPTION IDENTIFIED BY password ON FOR ALL TABLESPACES;
```

3. Back up the database.

For example, enter the following command:

```
BACKUP DATABASE PLUS ARCHIVELOG;
```

10.7 Restarting RMAN Backups

With the restartable backup feature, RMAN backs up only those files that were not backed up after a specified date.

This section contains the following topics:

- [About Restartable Backups](#) (page 10-14)
- [Restarting a Backup After It Partially Completes](#) (page 10-14)

10.7.1 About Restartable Backups

The minimum unit of restartability is a data file. However, if a backup set contains one backup piece, and if this piece contains blocks from multiple data files, then the unit of restartability is the backup piece. The unit of restartability for image copies is a data file.

The benefit of restartable backups is that if the backup generates multiple backup sets, then the backup sets that completed successfully do not have to be rerun. However, if the entire database is written into one backup set, and if the backup fails halfway through, then the entire backup has to be restarted.

Any I/O errors that RMAN encounters when reading files or writing to the backup pieces or image copies cause RMAN to terminate the backup job in progress. For example, if RMAN tries to back up a data file but the data file is not on disk, then RMAN terminates the backup. If multiple channels are being used or redundant copies of backups are being created, however, then RMAN may be able to continue the backup without user intervention.

RMAN can back up only those files that have not been backed up since a specified date. Use this feature after a backup fails to back up the parts of the database missed by the failed backup.

You can restart a backup by specifying the `SINCE TIME` clause on the `BACKUP` command. If the `SINCE TIME` is later than the completion time, then RMAN backs up the file. If you use `BACKUP DATABASE NOT BACKED UP` without the `SINCE TIME` parameter, then RMAN only backs up files that have never been backed up.

See Also:

Oracle Database Backup and Recovery Reference for `BACKUP . . . NOT BACKED UP` syntax

10.7.2 Restarting a Backup After It Partially Completes

Use the `SINCE TIME` parameter of the `BACKUP` command to specify a date after which a new backup is required.

If the `SINCE TIME` is later than the completion time, then RMAN backs up the file. If you use `BACKUP DATABASE NOT BACKED UP` without the `SINCE TIME` parameter, then RMAN only backs up files that have never been backed up.

To only back up files that were not backed up after a specified date:

1. Start RMAN and connect to a target database and recovery catalog (if used).
2. Execute the `BACKUP . . . NOT BACKED UP SINCE TIME` command.

Specify a valid date in the `SINCE TIME` parameter. The following example uses the default configured channel to back up all database files and archived redo logs that have not been backed up in the last two weeks:

```
BACKUP
NOT BACKED UP SINCE TIME 'SYSDATE-14'
DATABASE PLUS ARCHIVELOG;
```

See Also:

Oracle Database Backup and Recovery Reference for an example of how to use the BACKUP command to restart a backup that did not complete

10.8 Managing Backup Windows

This section explains how to use backup windows to set limits for the time span in which a backup job can complete.

This section contains the following topics:

- [About Backup Windows](#) (page 10-15)
- [Specifying a Backup Duration](#) (page 10-15)
- [Permitting Partial Backups in a Backup Window](#) (page 10-16)
- [Minimizing Backup Load and Duration](#) (page 10-16)

10.8.1 About Backup Windows

A backup window is a period of time during which a backup must complete. For example, you may want to restrict your database backups to a window of time when user activity on your system is low, such as between 2:00 a.m. and 6:00 a.m.

RMAN backs up the least recently backed up files first. By default, RMAN backs up the files at the maximum possible speed. Specifying a window does not mean that RMAN backs up data faster than normal to ensure that the backup completes before the window ends.

By default, if the backup is not complete within the DURATION time, then RMAN interrupts the backup and reports an error. If the BACKUP command is in a RUN command, then the RUN command terminates. Any completed backup sets are retained and can be used in restore operations, even if the entire backup is not complete. Thus, if you retry a job that was interrupted when the available duration expired, each successive attempt covers more of the files needing backup. Any incomplete backup sets are discarded.

10.8.2 Specifying a Backup Duration

Use the DURATION parameter of the BACKUP command to specify how long a given backup job is allowed to run.

To specify a backup duration:

1. Start RMAN and connect to a target database and recovery catalog (if used).
2. Execute the BACKUP DURATION command.

For example, run the following command at 2:00 a.m. to specify that the backup runs until 6:00 a.m.:

```
BACKUP
  DURATION 4:00
  TABLESPACE users;
```

See Also:

Oracle Database Backup and Recovery Reference for the syntax of the BACKUP command

10.8.3 Permitting Partial Backups in a Backup Window

When you specify `PARTIAL`, RMAN does not report an error when a backup is interrupted because of the end of the backup window. Instead, RMAN displays a message showing which files are not backed up.

If the `BACKUP` command is part of a `RUN` block, then the remaining commands in the `RUN` block continue to execute.

If you specify `FILESPERSET 1`, then RMAN puts each file into its own backup set. When a backup is interrupted at the end of the backup window, only the backup of the file currently being backed up is lost. All backup sets completed during the window are saved, minimizing the lost work caused by the end of the backup window.

To prevent RMAN from issuing an error when a backup partially completes:

1. Start RMAN and connect to a target database and recovery catalog (if used).
2. Execute the `BACKUP DURATION` command with the `PARTIAL` option.

For example, you run the following command at 2:00 a.m. to specify that the backup runs until 6:00 a.m. and that each data file is in a separate backup set:

```
BACKUP
  DURATION 4:00 PARTIAL
  TABLESPACE users
  FILESPERSET 1;
```

10.8.4 Minimizing Backup Load and Duration

When using `DURATION` you can run the backup with the maximum possible performance, or run as slowly as possible while still finishing within the allotted time, to minimize the performance impact of backup tasks.

To maximize performance, use the `MINIMIZE TIME` option with `DURATION`, as shown in [Example 10-4](#) (page 10-16).

Example 10-4 Using MINIMIZE TIME with BACKUP DURATION

```
BACKUP
  DURATION 4:00 PARTIAL
  MINIMIZE TIME
  DATABASE
  FILESPERSET 1;
```

To extend the backup to use the full time available, use the `MINIMIZE LOAD` option, as in [Example 10-5](#) (page 10-17).

Example 10-5 Using MINIMIZE LOAD with BACKUP DURATION

In this example, RMAN monitors the progress of the running backup, and periodically estimates how long the backup takes to complete at its present rate. If RMAN estimates that the backup will finish before the end of the backup window, then it slows down the rate of backup so that the full available duration is used. This reduces the overhead on the database associated with the backup.

```
BACKUP
  DURATION 4:00
  MINIMIZE LOAD
  DATABASE
  FILESPERSET 1;
```

Note these issues when using DURATION and MINIMIZE LOAD with a tape backup:

- Efficient backup to tape requires tape streaming. If you use MINIMIZE LOAD, then RMAN may reduce the rate of backup to the point where tape streaming is not optimal.
- RMAN holds the tape resource for the entire duration of the backup window. This prevents the use of the tape resource for any other purpose during the backup window.

Because of these concerns, it is not recommended that you use MINIMIZE LOAD when backing up to tape.

See Also:

[Media Manager Component of the Write Phase for SBT](#) (page 23-9) for more details on efficient tape handling

Part IV

Managing RMAN Backups

The following chapters describe how to manage RMAN backups. This part of the book contains these chapters:

- [Reporting on RMAN Operations](#) (page 11-1)
- [Maintaining RMAN Backups and Repository Records](#) (page 12-1)
- [Managing a Recovery Catalog](#) (page 13-1)

Reporting on RMAN Operations

This chapter describes how to report on RMAN operations. This chapter contains the following topics:

- [Overview of RMAN Reporting](#) (page 11-1)
- [Listing Backups and Recovery-Related Objects](#) (page 11-3)
- [Reporting on Backups and Database Schema](#) (page 11-10)
- [Using V\\$ Views to Query Backup Metadata](#) (page 11-17)
- [Querying Recovery Catalog Views](#) (page 11-20)

11.1 Overview of RMAN Reporting

This section explains the purpose and basic concepts of RMAN reporting.

11.1.1 Purpose of RMAN Reporting

As part of your backup and recovery strategy, you should periodically run reports that indicate what you have backed up. You can determine which data files need backups or which files were not backed up recently. Also, you can preview which backups RMAN must restore if a problem occurs.

Another important aspect of backup and recovery is monitoring space usage. If you back up to disk, then it is possible for the disk to fill, which can create performance problems or even cause the database to halt. You can use RMAN to determine whether a backup is an [obsolete backup](#) and can therefore be deleted.

You may also need to obtain historical information about RMAN jobs. For example, you may want to know how many backup jobs have been issued, the status of each backup job (for example, whether it failed or completed), when a job started and finished, and what type of backup was performed.

11.1.2 Basic Concepts of RMAN Reporting

RMAN stores metadata of every database on which it performs operations.

RMAN always stores its RMAN repository of metadata in the control file of the target database. For example, suppose that you use RMAN to back up the `prod1` and `prod2` databases. RMAN stores the metadata for backups of `prod1` in the control file of `prod1`, and the metadata for backups of `prod2` in the control file of `prod2`.

Optionally, you can use RMAN with a [recovery catalog](#). In this case, RMAN maintains an additional repository of metadata in a set of tables in a separate [recovery catalog database](#). For example, you could create a recovery catalog in `prod3`. You can register multiple target databases in this recovery catalog. For example, if you register `prod1`

and `prod2` in the recovery catalog stored in `prod3`, then RMAN stores metadata about its backups of `prod1` and `prod2` in the [recovery catalog schema](#).

The following table lists the techniques used to access metadata from the RMAN repository.

Table 11-1 Techniques for Accessing Data from the RMAN Repository

Technique	Description	Additional Information
RMAN LIST and REPORT commands	The RMAN LIST and REPORT commands provide extensive information about available backups and how they can be used to restore and recover your database.	<ul style="list-style-type: none"> • "Listing Backups and Recovery-Related Objects (page 11-3)" • "Reporting on Backups and Database Schema (page 11-10)" • LIST, REPORT, and RESTORE commands in <i>Oracle Database Backup and Recovery Reference</i>
V\$ views	<p>When the database is open, several V\$ views provide direct access to RMAN repository records in the control file of each target database.</p> <p>Some V\$ views such as V\$DATAFILE_HEADER, V\$PROCESS, and V\$SESSION contain information not found in the recovery catalog views.</p>	<i>Oracle Database Reference</i>
RC_ views	<p>If your database is registered in a recovery catalog, then RC_ views provide direct access to the RMAN repository data stored in the recovery catalog.</p> <p>The RC_ views mostly correspond to the V\$ views.</p>	<i>Oracle Database Backup and Recovery Reference</i>
RESTORE ... PREVIEW and RESTORE ... VALIDATE HEADER commands	<p>These commands list the backups that RMAN can restore to the specified time.</p> <p>RESTORE ... PREVIEW queries the metadata but does not read the backup files. The RESTORE ... VALIDATE HEADER command performs the same work, but in addition to listing the files needed for restore and recovery operations, the command validates the backup file headers to determine whether the files on disk or in the media management catalog correspond to the metadata in the RMAN repository.</p>	These commands are documented in "Previewing Backups Used in Restore Operations (page 17-7)"

The RMAN repository can sometimes fail to reflect the reality on disk and tape. For example, a user may delete a backup with an operating system utility, so that the

RMAN repository incorrectly reports the backup as available. You can use commands such as `CHANGE`, `CROSSCHECK`, and `DELETE` to update the RMAN repository to reflect the actual state of available backups. Otherwise, the output of the commands and views may be misleading, which means that RMAN may not be able to find the backups to restore and recover your database.

See Also:

- [Crosschecking the RMAN Repository](#) (page 12-11) to learn how to keep the RMAN repository current
 - [Maintaining RMAN Backups and Repository Records](#) (page 12-1)
-

11.1.3 Reporting in a Data Guard Environment

In a Data Guard environment, you can use the `LIST`, `REPORT`, and `SHOW` commands just as you can when not using Data Guard. You can run these commands with the `FOR DB_UNIQUE_NAME` clause to show the backups associated with a specified database.

As explained in "[About RMAN File Management in a Data Guard Environment](#) (page 3-9)", every backup is associated with the primary or standby database that created it. For example, if you backed up the database with the `DB_UNIQUE_NAME` of `standby1`, then the `standby1` database is associated with this backup.

For example, the following command lists archived redo logs associated only with `sfstandby`:

```
LIST ARCHIVELOG ALL FOR DB_UNIQUE_NAME sfstandby;
```

If you use the `LIST`, `REPORT`, and `SHOW` commands in a Data Guard environment *without* specifying the `FOR DB_UNIQUE_NAME` clause, then RMAN shows the files that are accessible to the target database. "[About Association of Backups in a Data Guard Environment](#) (page 3-9)" explains when backups are considered accessible to RMAN.

In a Data Guard environment, you must use RMAN with a recovery catalog. RMAN stores the metadata for all backup and recovery files in the Data Guard environment in the recovery catalog. When running the RMAN reporting commands, you can either connect RMAN as `TARGET` to a mounted or open database, or identify the database with the `SET DBID` command.

See Also:

Oracle Data Guard Concepts and Administration to report on RMAN operations in a Data Guard environment

11.2 Listing Backups and Recovery-Related Objects

The `LIST` command uses the information in the RMAN repository to provide lists of backups and other objects relating to backup and recovery.

This section contains the following topics:

- [About the LIST Command](#) (page 11-4)
- [Listing All Backups and Copies](#) (page 11-6)

- [Listing Selected Backups and Copies](#) (page 11-8)
- [Listing Database Incarnations](#) (page 11-9)

11.2.1 About the LIST Command

The primary purpose of the LIST command is to list backup and copies.

For example, you can list:

- Backups and proxy copies of a database, tablespace, data file, archived redo log, or control file
- Backups that have expired
- Backups restricted by time, path name, device type, tag, or recoverability
- Archived redo log files and disk copies

Besides backups and copies, RMAN can list other types of data. The following table summarizes several useful objects that you can list.

Table 11-2 LIST Objects

Contents of List	Command	Description
Backup sets and proxy copies	LIST BACKUP	You can list all backup sets, copies, and proxy copies of a database, tablespace, data file, archived redo log, control file, or server parameter file.
Image copies	LIST COPY	You can list data file copies and archived redo log files. By default, LIST COPY displays copies of all database files and archived redo logs. Both usable and unusable image copies are included in the output, even those that cannot be restored or are expired or unavailable.
Archived redo log files	LIST ARCHIVELOG	You can list archive redo log files. You can list all archive log redo log files or specify individual archive log files through SCN, time, or sequence number ranges. If you specify a range you can further restrict the list returned by specifying an incarnation number.
Database incarnations	LIST INCARNATION	You can list all incarnations of a database. A new database incarnation is created when you open with the RESETLOGS option.
Databases in a Data Guard environment	LIST DB_UNIQUE_NAME	A database in a Data Guard environment is distinguished by its DB_UNIQUE_NAME initialization parameter setting. You can list all databases that have the same DBID.

Table 11-2 (Cont.) LIST Objects

Contents of List	Command	Description
Backups and copies for a primary or standby database in a Data Guard environment	<code>LIST ... FOR DB_UNIQUE_NAME</code>	You can list all backups and copies for a specified database in a Data Guard environment or for all databases in the environment. RMAN restricts the output to files or objects associated exclusively with the database with the specified <code>DB_UNIQUE_NAME</code> . For example, you can use <code>LIST</code> with <code>FOR DB_UNIQUE_NAME</code> to display the list of archived redo log files associated with a particular standby or primary database. Objects that are not owned by any database (<code>SITE_KEY</code> column in the recovery catalog view is null) are not listed.
Restore points	<code>LIST RESTORE POINT</code>	You can list restore points known to the RMAN repository.
Names of stored scripts	<code>LIST SCRIPT NAMES</code>	You can list the names of recovery catalog scripts created with the <code>CREATE SCRIPT</code> or <code>REPLACE SCRIPT</code> command. A recovery catalog is required.
Failures for use with Data Recovery Advisor	<code>LIST FAILURE</code>	A failure is a persistent data corruption mapped to a repair option . Diagnosing and Repairing Failures with Data Recovery Advisor (page 15-1) explains how to use <code>LIST FAILURE</code> with the <code>ADVISE</code> and <code>REPAIR</code> commands.

The `LIST` command supports options that control how output is displayed. [Table 11-3](#) (page 11-5) summarizes the most common `LIST` options.

Table 11-3 Most Common LIST Options

LIST Option	Description
<code>LIST EXPIRED</code>	Lists backups or copies that are recorded in the RMAN repository but that were not present at the expected location on disk or tape during the most recent crosscheck . Such backups may have been deleted outside of RMAN.
<code>LIST ... BY FILE</code>	Lists backups of each data file, archived redo log file, control file, and server parameter file. Each row describes a backup of a file.
<code>LIST ... SUMMARY</code>	Provides a one-line summary of each backup.

The `LIST` objects and options are not exhausted by the contents of the preceding tables. For example, you can list backups restricted by time, path name, device type, tag, or recoverability.

See Also:

Oracle Database Backup and Recovery Reference for a complete description of the `LIST` command

11.2.2 Listing All Backups and Copies

Specify the desired objects with the *listObjList* or *recordSpec* clause. If you do not specify an object, then RMAN displays copies of all database files and archived redo log files.

By default, RMAN serially lists each backup or proxy copy and then identifies the files included in the backup. You can also list backups by file.

By default, RMAN lists in verbose mode, which means that it provides extensive, multiline information. You can also list backups in a summary mode if the verbose mode generates too much output.

To view a summary report of all backups and copies, execute the `LIST` command with the `SUMMARY` option.

Example 11-1 Summary Listing of All Backups

This example shows a summary of all RMAN backups.

```
RMAN> list backup summary;
```

```
List of Backups
=====
Key      TY LV S Device Type Completion Time #Pieces #Copies Compressed Tag
-----
1        B A A SBT_TAPE 21-OCT-13      1      1      NO      TAG20131021T094505
2        B F A SBT_TAPE 21-OCT-13      1      1      NO      TAG20131021T094513
3        B A A SBT_TAPE 21-OCT-13      1      1      NO      TAG20131021T094624
4        B F A SBT_TAPE 21-OCT-13      1      1      NO      TAG20131021T094639
5        B F A DISK    04-NOV-13      1      1      YES     TAG20131104T195949
```

To view verbose output for backups and copies, execute the `LIST` command without the `SUMMARY` option.

Example 11-2 Verbose Listings of Backups and Copies

This example lists RMAN backups and copies with the default verbose output.

```
RMAN> list backup;
```

```
List of Backup Sets
=====
BS Key  Size      Device Type Elapsed Time Completion Time
-----
7       136M     DISK        00:00:20    04-NOV-13
        BP Key: 7   Status: AVAILABLE Compressed: NO Tag: TAG20071104T200759
        Piece Name: /d2/RDBMS/backupset/2013_11_04/
ol_mf_anmn TAG20071104T200759_ztjxx3k8_.bkp
```

```
List of Archived Logs in backup set 7
Thrd Seq      Low SCN      Low Time     Next SCN     Next Time
-----
1      1          173832      21-OCT-13   174750      21-OCT-13
1      2          174750      21-OCT-13   174755      21-OCT-13
1      3          174755      21-OCT-13   174758      21-OCT-13
```

```
BS Key  Type LV Size      Device Type Elapsed Time Completion Time
-----
8       Full  2M       DISK        00:00:01    04-NOV-13
        BP Key: 8   Status: AVAILABLE Compressed: NO Tag: TAG20071104T200829
        Piece Name: /disk1/oracle/dbs/c-774627068-20131104-01
```

Controlfile Included: Ckp SCN: 631510 Ckp time: 04-NOV-13
 SPFILE Included: Modification time: 21-OCT-13

RMAN> list copy;

List of Datafile Copies

=====

Key	File S	Completion Time	Ckp SCN	Ckp Time
1	7 A	11-OCT-13	360072	11-OCT-13
	Name: /work/orcva/RDBMS/datafile/ol_mf_tbs_2_2lv7bf82_.dbf			
	Tag: DF7COPY			
2	8 A	11-OCT-13	360244	11-OCT-13
	Name: /work/orcva/RDBMS/datafile/ol_mf_tbs_2_2lv7qmcj_.dbf			
	Tag: TAG20131011T184835			

List of Control File Copies

=====

Key	S	Completion Time	Ckp SCN	Ckp Time
3	A	11-OCT-13	360380	11-OCT-13
	Name: /d2/RDBMS/controlfile/ol_mf_TAG20131011T185335_2lv80zqd_.ctl			
	Tag: TAG20131011T185335			

List of Archived Log Copies for database with db_unique_name RDBMS

=====

Key	Thrd	Seq	S	Low Time
1	1	1	A	11-OCT-13
	Name: /work/arc_dest/arcr_1_1_603561743.arc			
2	1	2	A	11-OCT-13
	Name: /work/arc_dest/arcr_1_2_603561743.arc			
3	1	3	A	11-OCT-13
	Name: /work/arc_dest/arcr_1_3_603561743.arc			

Example 11-3 Listing Backups By File

This example illustrates how to list backups by file using LIST with the BY FILE option.

RMAN> list backup by file;

List of Datafile Backups

=====

File Key	TY	LV	S	Ckp SCN	Ckp Time	#Pieces	#Copies	Compressed	Tag
1	5	B	F	A 631092	04-NOV-13	1	1	YES	TAG20131104T195949
	2	B	F	A 175337	21-OCT-13	1	1	NO	TAG20131021T094513
2	5	B	F	A 631092	04-NOV-13	1	1	YES	TAG20131104T195949
	2	B	F	A 175337	21-OCT-13	1	1	NO	TAG20131021T094513

... some rows omitted

List of Archived Log Backups

=====

Thrd	Seq	Low SCN	Low Time	BS Key	S	#Pieces	#Copies	Compressed	Tag
------	-----	---------	----------	--------	---	---------	---------	------------	-----

```

-----
1  1      173832    21-OCT-13 7      A 1      1      NO      TAG20131104T200759
                                1      A 1      1      NO      TAG20131021T094505
1  2      174750    21-OCT-13 7      A 1      1      NO      TAG20131104T200759
                                1      A 1      1      NO      TAG20131021T094505
... some rows omitted
1  38     575472     03-NOV-13 7      A 1      1      NO      TAG20131104T200759
1  39     617944     04-NOV-13 7      A 1      1      NO      TAG20131104T200759

```

List of Controlfile Backups

```

=====
CF Ckp SCN Ckp Time  BS Key  S #Pieces #Copies Compressed Tag
-----
631510    04-NOV-13 8      A 1      1      NO      TAG20131104T200829
631205    04-NOV-13 6      A 1      1      NO      TAG20131104T200432

```

List of SPFILE Backups

```

=====
Modification Time BS Key  S #Pieces #Copies Compressed Tag
-----
21-OCT-13      8      A 1      1      NO      TAG20131104T200829
21-OCT-13      6      A 1      1      NO      TAG20131104T200432

```

See Also:

Oracle Database Backup and Recovery Reference for an explanation of the various column headings in the LIST output

11.2.3 Listing Selected Backups and Copies

You can specify several different conditions to narrow your LIST output.

To list selected backups and copies:

1. Start RMAN and connect to a target database and recovery catalog (if used).
2. Run LIST COPY or LIST BACKUP with the *listObjList* or *recordSpec* clause. For example, enter any of the following commands:

```

# lists backups of all files in database
LIST BACKUP OF DATABASE;
# lists copy of specified datafile
LIST COPY OF DATAFILE 'ora_home/oradata/trgt/system01.dbf';
# lists specified backup set
LIST BACKUPSET 213;
# lists datafile copy
LIST DATAFILECOPY '/tmp/tools01.dbf';

```

You can also restrict the search by specifying the *maintQualifier* or RECOVERABLE clause. For example, enter any of the following commands:

```

# specify a backup set by tag
LIST BACKUPSET TAG 'weekly_full_db_backup';
# specify a backup or copy by device type
LIST COPY OF DATAFILE 'ora_home/oradata/trgt/system01.dbf' DEVICE TYPE sbt;
# specify a backup by directory or path
LIST COPY LIKE '/tmp/%';
# specify a backup or copy by a range of completion dates
LIST COPY OF DATAFILE 2 COMPLETED BETWEEN '10-DEC-2012' AND '17-DEC-2012';
# specify logs backed up at least twice to tape
LIST ARCHIVELOG ALL BACKED UP 2 TIMES TO DEVICE TYPE sbt;

```

3. Examine the output.

The output depends upon the options that you pass to the `LIST` command. For example, the following lists copies of data file 1 contained in backup sets.

```
RMAN> LIST BACKUP OF DATAFILE 1;
```

```
List of Backup Sets
```

```
=====
```

```
BS Key   Type LV Size      Device Type Elapsed Time Completion Time
-----
2        Full   230M          SBT_TAPE   00:00:49    21-OCT-13
      BP Key: 2   Status: AVAILABLE Compressed: NO Tag: TAG20131021T094513
      Handle: 02f4eatc_1_1 Media: /smrdir
```

```
List of Datafiles in backup set 2
```

```
File LV Type Ckp SCN    Ckp Time Name
```

```
-----
1        Full 175337      21-OCT-13 /oracle/dbs/tbs_01.f
```

```
BS Key   Type LV Size      Device Type Elapsed Time Completion Time
-----
```

```
5        Full   233M          DISK       00:04:30    04-NOV-13
      BP Key: 5   Status: AVAILABLE Compressed: NO Tag: TAG20131104T195949
      Piece Name: /disk1/2013_11_04/o1_mf_nnndf_TAG20131104T195949_ztjxfvgz_.bkp
```

```
List of Datafiles in backup set 5
```

```
File LV Type Ckp SCN    Ckp Time Name
```

```
-----
1        Full 631092      04-NOV-13 /oracle/dbs/tbs_01.f
```

See Also:

- *Oracle Database Backup and Recovery Reference* for `listObjList` and `recordSpec` syntax
 - *Oracle Database Backup and Recovery Reference* for an explanation of the columns in the `LIST` output
-

11.2.4 Listing Database Incarnations

Each time an `OPEN RESETLOGS` operation is performed on a database, this operation creates a new incarnation of the database.

When performing incremental backups, RMAN can use a backup from a previous incarnation or the current incarnation as a basis for subsequent incremental backups. When performing restore and recovery operations, RMAN can use backups from a previous incarnation just as it can use backups from the current incarnation, if all archived logs are available.

To list database incarnations:

1. Start RMAN and connect to a target database and recovery catalog (if used).
2. Run the `LIST INCARNATION` command, as shown in the following example:

```
LIST INCARNATION;
```

If you are using a recovery catalog, and if you register multiple target databases in the same catalog, then you can distinguish them by using the `OF DATABASE` option:

```
LIST INCARNATION OF DATABASE prod3;
```

Following is a sample output of listing the incarnation of a particular database:

```
RMAN> LIST INCARNATION OF DATABASE rdbms;
```

```
List of Database Incarnations
DB Key  Inc Key DB Name  DB ID          STATUS  Reset SCN  Reset Time
-----  -
1       1       RDBMS   774627068     PARENT  1          21-OCT-13
2       2       RDBMS   774627068     CURRENT 173832     21-OCT-13
```

The preceding output indicates that a `RESETLOGS` operation was performed on database `rdbms` at SCN 173832, resulting in a new incarnation. The incarnation is distinguished by incarnation key (represented in the `Inc Key` column).

See Also:

- *Oracle Database Backup and Recovery Reference* for an explanation of the various column headings in the `LIST` output
 - [About Database Incarnations](#) (page 14-7) database incarnations and their effect on database recovery
-
-

11.3 Reporting on Backups and Database Schema

The `RMAN REPORT` command analyzes the available backups and your database.

This section contains the following topics:

- [About Reports of RMAN Backups](#) (page 11-10)
- [Reporting on Files Needing a Backup Under a Retention Policy](#) (page 11-11)
- [Reporting on Data Files Affected by Unrecoverable Operations](#) (page 11-13)
- [Reporting on Obsolete Backups](#) (page 11-13)
- [Reporting on the Database Schema](#) (page 11-14)

11.3.1 About Reports of RMAN Backups

The `REPORT` command provides various reports of RMAN backups.

You can use the `REPORT` command to answer important questions, such as:

- Which files need a backup?
- Which files have had unrecoverable operations performed on them?
- Which backups are obsolete and can be deleted?
- What was the physical schema of the target database or a database in the Data Guard environment at some previous time?
- Which files have not been backed up recently?

Reports enable you to confirm that your backup and recovery strategy is in fact meeting your requirements for database recoverability. The two major forms of `REPORT` used to determine whether your database is recoverable are:

- `REPORT NEED BACKUP`
Reports which database files must be backed up to meet a configured or specified retention policy
- `REPORT UNRECOVERABLE`
Reports which database files require backup because they have been affected by some `NOLOGGING` operation such as a direct-path `INSERT`

The RMAN repository contains other information that you can access with the `REPORT` command. The following table summarizes the `REPORT` options.

Table 11-4 *REPORT Options*

Contents of Report	Command	Description
Obsolete backups	<code>REPORT OBSOLETE</code>	Full backups, data file copies, and archived redo logs recorded in the RMAN repository that can be deleted because they are no longer needed
Database schema	<code>REPORT SCHEMA</code>	The names of all data files (permanent and temporary) and tablespaces for the target database at the specified point in time. If you use RMAN in a Data Guard environment, then you can report the schema for a specified <code>DB_UNIQUE_NAME</code> .

See Also:

Oracle Database Backup and Recovery Reference for a description of the `REPORT` command

11.3.2 Reporting on Files Needing a Backup Under a Retention Policy

Use the `REPORT NEED BACKUP` command to determine which database files need backup under a specific retention policy.

With no arguments, `REPORT NEED BACKUP` reports which objects need backup under the currently configured retention policy. The output for a configured retention policy of `REDUNDANCY 1` is similar to this example:

```
RMAN> REPORT NEED BACKUP;
```

```
RMAN retention policy will be applied to the command
```

```
RMAN retention policy is set to redundancy 1
```

```
Report of files with less than 1 redundant backups
```

```
File #bkps Name
```

```
-----  
2    0    /oracle/oradata/trgt/undotbs01.dbf
```

Note:

If you disable the retention policy using `CONFIGURE RETENTION POLICY TO NONE`, then `REPORT NEED BACKUP` returns an error message, because without a retention policy, RMAN cannot determine which files must be backed up.

11.3.2.1 Using RMAN REPORT NEED BACKUP with Different Retention Policies

You can use options of the `REPORT NEED BACKUP` command to specify different retention policies.

Use one of the following forms to specify different criteria for `REPORT NEED BACKUP`:

- `REPORT NEED BACKUP RECOVERY WINDOW OF n DAYS`
Displays objects requiring backup to satisfy a recovery window-based retention policy
- `REPORT NEED BACKUP REDUNDANCY n`
Displays objects requiring backup to satisfy a redundancy-based retention policy
- `REPORT NEED BACKUP DAYS n`
Displays files that require more than *n* days' worth of archived redo log files for recovery
- `REPORT NEED BACKUP INCREMENTAL n`
Displays files that require application of more than *n* incremental backups for recovery

11.3.2.2 Using RMAN REPORT NEED BACKUP with Tablespaces and Data Files

The `REPORT NEED BACKUP` command can check the entire database, skip specified tablespaces, or check only specific tablespaces or data files against different retention policies.

The following are examples:

```
REPORT NEED BACKUP RECOVERY WINDOW OF 2 DAYS DATABASE SKIP TABLESPACE TBS_2;  
REPORT NEED BACKUP REDUNDANCY 2 DATAFILE 1;  
REPORT NEED BACKUP TABLESPACE TBS_3; # uses configured retention policy  
REPORT NEED BACKUP INCREMENTAL 2; # checks entire database
```

See Also:

Oracle Database Backup and Recovery Reference for all possible options for `REPORT NEED BACKUP` and an explanation of the various column headings in the output

11.3.2.3 Using REPORT NEED BACKUP with Backups on Tape or Disk Only

You can limit the backups tested by the `REPORT NEED BACKUP` command to disk-based or tape-based backups only.

Following are some examples:

```
REPORT NEED BACKUP RECOVERY WINDOW OF 2 DAYS DATABASE DEVICE TYPE sbt;  
REPORT NEED BACKUP DEVICE TYPE DISK;  
REPORT NEED BACKUP TABLESPACE TBS_3 DEVICE TYPE sbt;
```

11.3.3 Reporting on Data Files Affected by Unrecoverable Operations

When a data file has been changed by an unrecoverable operation, such as a direct load insert, normal media recovery cannot be used to recover the file, because an unrecoverable operation does not generate redo. You must perform either a full or incremental backup of affected data files after such operations, to ensure that data blocks affected by the unrecoverable operation can be recovered using RMAN.

To identify data files affected by an unrecoverable operation:

1. Start RMAN and connect to a target database and recovery catalog (if used).

See Also:

[Making Database Connections with RMAN](#) (page 4-2)

2. Execute the `REPORT UNRECOVERABLE` command.

The following example includes sample output:

```
RMAN> REPORT UNRECOVERABLE;

Report of files that need backup due to unrecoverable operations
File Type of Backup Required Name
-----
1    full                               /oracle/oradata/trgt/system01.dbf
```

11.3.4 Reporting on Obsolete Backups

You can report backup sets, backup pieces, and data file copies that are obsolete that is, not needed to meet a specified retention policy by specifying the `OBSOLETE` keyword.

To report obsolete backups:

1. Start RMAN and connect to a target database and recovery catalog (if used).

See Also:

[Making Database Connections with RMAN](#) (page 4-2)

2. Execute the `CROSSCHECK` command to update the status of backups in the repository compared to their status on disk.

In the simplest case, you could crosscheck all backups on disk, tape or both, using any one of the following commands:

```
CROSSCHECK BACKUP DEVICE TYPE DISK;
CROSSCHECK BACKUP DEVICE TYPE sbt;
CROSSCHECK BACKUP; # crosschecks all backups on all devices
```

3. Run `REPORT OBSOLETE` to identify which backups are obsolete because they are no longer needed for recovery.

If you do not specify any other options, then `REPORT OBSOLETE` displays the backups that are obsolete according to the current retention policy, as shown in the following example:

```

RMAN> REPORT OBSOLETE;

RMAN retention policy will be applied to the command
RMAN retention policy is set to redundancy 1
Report of obsolete backups and copies
Type                Key      Completion Time   Filename/Handle
-----
Datafile Copy       44      08-FEB-13        /backup/ora_df549738566_s70_s1
Datafile Copy       45      08-FEB-13        /backup/ora_df549738567_s71_s1
Datafile Copy       46      08-FEB-13        /backup/ora_df549738568_s72_s1
Backup Set          26      08-FEB-13
  Backup Piece      26      08-FEB-13        /backup/ora_df549738682_s76_s1
.
.
.

```

You can also check which backups are obsolete under different recovery window-based or redundancy-based retention policies, by using `REPORT OBSOLETE` with `RECOVERY WINDOW` and `REDUNDANCY` options, as shown in these examples:

```

REPORT OBSOLETE RECOVERY WINDOW OF 3 DAYS;
REPORT OBSOLETE REDUNDANCY 1;

```

See Also:

- [Maintaining RMAN Backups and Repository Records](#) (page 12-1) for more details on how to update the RMAN repository record to contain the actual set of available backups.
 - [Configuring the Backup Retention Policy](#) (page 5-29) for a conceptual overview of RMAN backup retention policy
 - [Deleting Expired RMAN Backups and Copies](#) (page 12-25) for information about deleting RMAN backups and deleting records of RMAN backups from the RMAN repository
-
-

11.3.5 Reporting on the Database Schema

The `REPORT SCHEMA` command lists and displays information about the database files, tablespaces, and so on.

If you do not specify `FOR DB_UNIQUE_NAME` with `REPORT SCHEMA`, then a recovery catalog connection is optional, but a target database connection is required. In a Data Guard environment, you can specify `REPORT SCHEMA FOR DB_UNIQUE_NAME` to report the schema for a database in the environment. In this case, an RMAN connection to a target database is not required. You can connect RMAN to the recovery catalog and set the `DBID` instead.

To report on the database schema:

1. Start RMAN and connect to the desired databases.

See Also:

[Making Database Connections with RMAN](#) (page 4-2)

- If you did not connect RMAN to a target database in the previous step, and you intend to specify the `FOR DB_UNIQUE_NAME` clause on `REPORT SCHEMA`, then set the database DBID. For example, enter the following command:

```
RMAN> SET DBID 28014364;
```

- Run the `REPORT SCHEMA` command as shown in the following example:

```
RMAN> REPORT SCHEMA;
```

```
Report of database schema for database with db_unique_name DGRDBMS
```

```
List of Permanent Datafiles
```

```
=====
```

File	Size(MB)	Tablespace	RB segs	Datafile Name
1	450	SYSTEM	YES	/disk1/oracle/dbs/t_dbl.f
2	141	SYSAUX	NO	/disk1/oracle/dbs/t_ax1.f
3	50	UD1	YES	/disk1/oracle/dbs/t_undol.f
4	50	TBS_11	NO	/disk1/oracle/dbs/tbs_111.f
5	50	TBS_11	NO	/disk1/oracle/dbs/tbs_112.f

```
List of Temporary Files
```

```
=====
```

File	Size(MB)	Tablespace	Maxsize(MB)	Tempfile Name
1	40	TEMP	32767	/disk1/oracle/dbs/t_tmp1.f

If you use a recovery catalog, then you can use the *at* clause to specify a past time, SCN, or log sequence number, as shown in these examples of the command:

```
RMAN> REPORT SCHEMA AT TIME 'SYSDATE-14';      # schema 14 days ago
RMAN> REPORT SCHEMA AT SCN 1000;              # schema at scn 1000
RMAN> REPORT SCHEMA AT SEQUENCE 100 THREAD 1; # schema at sequence 100
RMAN> REPORT SCHEMA FOR DB_UNIQUE_NAME standby1; # schema for database standby1
```

See Also:

Oracle Database Backup and Recovery Reference for a description of the `REPORT SCHEMA` output

11.4 Reporting in CDBs and PDBs

You can view reports on the metadata related to a multitenant container database (CDB), the root only, or one or more pluggable databases (PDBs).

The concepts and practices of reporting on non-CDBs is applicable to CDBs and PDBs, with the differences described in the following sections.

- [Reporting in CDBs](#) (page 11-16)
- [Reporting in PDBs](#) (page 11-16)

11.4.1 Reporting in CDBs

The steps to view reporting information for a CDB are similar to the ones used for a [non-CDB](#). The only difference is that you must connect to the root as a [common user](#) with the common SYSBACKUP or common SYSDBA privilege.

The LIST and LIST BACKUP OF commands will display backups of the whole CDB. The REPORT NEED BACKUP TABLESPACE command displays information about the tablespaces in the root that need backup.

See Also:

[Making RMAN Connections to a CDB](#) (page 4-7)

The following command, when connected to the root, displays all the data files in the CDB that need backup:

```
REPORT NEED BACKUP;
```

This command, when connected to the root, provides a summary list of backups of the whole CDB:

```
LIST BACKUP SUMMARY;
```

11.4.2 Reporting in PDBs

Use one of the following techniques to view reporting information for PDBs:

- Connect to the root and use the LIST . . . PLUGGABLE DATABASE or REPORT PLUGGABLE DATABASE commands. This enables you to display information regarding one or more PDBs.

The following command, when connected to the root, provides a verbose list of backups in the PDBs hr_pdb and sales_pdb.

```
LIST BACKUP OF PLUGGABLE DATABASE hr_pdb, sales_pdb;
```

- Connect to the PDB and use the LIST BACKUP or REPORT commands. This approach displays information for only one PDB and also uses the same commands that are used for non-CDBs.

The following command, when connected to a particular PDB, displays all the data files in the PDB that need backup:

```
REPORT NEED BACKUP;
```

When connected to a PDB, you cannot view reporting information about obsolete backups or delete obsolete backups.

See Also:

[Making RMAN Connections to a CDB](#) (page 4-7)

11.4.2.1 Listing Backups of Dropped PDBs

Use the LIST command with the GUID option to list backups of pluggable databases (PDBs) that have been dropped from a multitenant container database (CDB).

After a PDB is dropped, you cannot perform operations or query data dictionary views by using the PDB name. However, you can obtain information about dropped PDBs by querying using GUID of a PDB.

To list backups of dropped PDBs:

1. Connect to the root as a common user with the SYSDBA or SYSBACKUP privilege.
2. Query the DBA_PDB_HISTORY view to determine the GUID of the PDB that was dropped.

The following example displays the PDBs that were dropped from the CDB test_db:

```
SELECT pdb_name, pdb_guid FROM dba_pdb_history
WHERE db_name = 'test_db';
```

3. Use the LIST command with the GUID option to display backups of a dropped PDB.

The following commands display backup sets and image copies of a dropped PDB with the specified GUID:

```
LIST BACKUP GUID 'CDFFD672330A7527D0147204CD0E08D4';
LIST COPY GUID 'CDFFD672330A7527D0147204CD0E08D4';
```

11.5 Using V\$ Views to Query Backup Metadata

In some cases, V\$ views supply information that is not available through use of the LIST and REPORT commands.

This section describes cases in which V\$ views are particularly useful and contains the following topics.

- [Querying Details of Past and Current RMAN Jobs](#) (page 11-17)
- [Determining the Encryption Status of Backup Pieces](#) (page 11-19)

11.5.1 Querying Details of Past and Current RMAN Jobs

An RMAN job is the set of commands executed within an RMAN session. Thus, one RMAN job can contain multiple commands.

For example, you may execute two separate BACKUP commands and a RECOVER COPY command in a single session. An [RMAN backup job](#) is the set of BACKUP commands executed in one RMAN job. For example, a BACKUP DATABASE and BACKUP ARCHIVELOG ALL command executed in the same RMAN job constitute a single RMAN backup job.

The views V\$RMAN_BACKUP_JOB_DETAILS and V\$RMAN_BACKUP_SUBJOB_DETAILS and their corresponding recovery catalog versions provide details of RMAN backup jobs. For example, the views show how long a backup took, how many backup jobs have been issued, the status of each backup job (for example, whether it failed or completed), when a job started and finished, and what type of backup was performed. The SESSION_KEY column is the unique key for the RMAN session in which the backup job occurred.

RMAN backups often write less than they read. Because of RMAN compression, the OUTPUT_BYTES_PER_SEC column cannot be used as the measurement of backup speed. The appropriate column to measure backup speed is INPUT_BYTES_PER_SEC.

The ratio between read and written data is described in the `COMPRESSION_RATIO` column.

To query details about past and current RMAN jobs:

1. Connect SQL*Plus to the database whose backup history you intend to query.
2. Query the `V$RMAN_BACKUP_JOB_DETAILS` view for information about the backup type, status, and start and end time.

The following query shows the backup job history ordered by session key, which is the primary key for the RMAN session:

```
COL STATUS FORMAT a9
COL hrs      FORMAT 999.99
SELECT SESSION_KEY, INPUT_TYPE, STATUS,
       TO_CHAR(START_TIME, 'mm/dd/yy hh24:mi') start_time,
       TO_CHAR(END_TIME, 'mm/dd/yy hh24:mi')   end_time,
       ELAPSED_SECONDS/3600                    hrs
FROM V$RMAN_BACKUP_JOB_DETAILS
ORDER BY SESSION_KEY;
```

The following sample output shows the backup job history:

SESSION_KEY	INPUT_TYPE	STATUS	START_TIME	END_TIME	HRS
9	DATAFILE FULL	COMPLETED	04/18/07 18:14	04/18/07 18:15	.02
16	DB FULL	COMPLETED	04/18/07 18:20	04/18/07 18:22	.03
113	ARCHIVELOG	COMPLETED	04/23/07 16:04	04/23/07 16:05	.01

3. Query the `V$RMAN_BACKUP_JOB_DETAILS` view for the rate of backup jobs in an RMAN session.

The following query shows the backup job speed ordered by session key, which is the primary key for the RMAN session. The columns `in_sec` and `out_sec` display the data input and output per second.

```
COL in_sec FORMAT a10
COL out_sec FORMAT a10
COL TIME_TAKEN_DISPLAY FORMAT a10
SELECT SESSION_KEY,
       OPTIMIZED,
       COMPRESSION_RATIO,
       INPUT_BYTES_PER_SEC_DISPLAY in_sec,
       OUTPUT_BYTES_PER_SEC_DISPLAY out_sec,
       TIME_TAKEN_DISPLAY
FROM V$RMAN_BACKUP_JOB_DETAILS
ORDER BY SESSION_KEY;
```

The following sample output shows the speed of the backup jobs:

SESSION_KEY	OPT	COMPRESSION_RATIO	IN_SEC	OUT_SEC	TIME_TAKEN
9	NO		8.24M	8.24M	00:01:14
16	NO	1.32732239	6.77M	5.10M	00:01:45
113	NO		2.99M	2.99M	00:00:44

4. Query the `V$RMAN_BACKUP_JOB_DETAILS` view for the size of the backups in an RMAN session.

If you run `BACKUP DATABASE`, then `V$RMAN_BACKUP_JOB_DETAILS.OUTPUT_BYTES` shows the total size of backup sets written by the backup job for the database that you are backing up. To view backup set sizes for all registered databases, query `V$RMAN_BACKUP_JOB_DETAILS`.

The following query shows the backup job size and throughput ordered by session key, which is the primary key for the RMAN session. The columns `in_size` and `out_size` display the data input and output per second.

```
COL in_size FORMAT a10
COL out_size FORMAT a10
SELECT SESSION_KEY,
       INPUT_TYPE,
       COMPRESSION_RATIO,
       INPUT_BYTES_DISPLAY in_size,
       OUTPUT_BYTES_DISPLAY out_size
FROM   V$RMAN_BACKUP_JOB_DETAILS
ORDER BY SESSION_KEY;
```

The following sample output shows the size of the backup jobs:

SESSION_KEY	INPUT_TYPE	COMPRESSION_RATIO	IN_SIZE	OUT_SIZE
10	DATAFILE FULL	1	602.50M	602.58M
17	DB FULL	1.13736669	634.80M	558.13M

See Also:

Oracle Database Reference to learn about the `V$RMAN_BACKUP_JOB_DETAILS` view

11.5.2 Determining the Encryption Status of Backup Pieces

The `ENCRYPTED` column of the `V$BACKUP_PIECE` and `V$RMAN_BACKUP_PIECE` views indicates whether a backup piece is encrypted (YES) or unencrypted (NO).

For example, you can run the following query in SQL*Plus to determine which backup pieces are encrypted:

```
COL BS_REC   FORMAT 99999
COL BP_REC   FORMAT 99999
COL MB       FORMAT 9999999
COL ENCRYPTED FORMAT A7
COL TAG      FORMAT A25

SELECT S.RECID AS "BS_REC", P.RECID AS "BP_REC", P.ENCRYPTED,
       P.TAG, P.HANDLE AS "MEDIA_HANDLE"
FROM   V$BACKUP_PIECE P, V$BACKUP_SET S
WHERE  P.SET_STAMP = S.SET_STAMP
AND    P.SET_COUNT = S.SET_COUNT;
```

The following sample output shows that the backups are encrypted:

```
BS_REC BP_REC ENCRYPT TAG
-----
MEDIA_HANDLE
-----
1      1 YES    TAG20070711T140124
/disk1/c-39525561-20070711-00
```

```
2      2 YES      TAG20070711T140128
/disk1/c-39525561-20070711-01

3      3 YES      TAG20070711T140130
/disk1/c-39525561-20070711-02
```

See Also:

Oracle Database Reference to learn about the V\$BACKUP_PIECE view

11.6 Querying Recovery Catalog Views

The LIST, REPORT, and SHOW commands provide the easiest means of accessing the data in the control file and the recovery catalog.

Nevertheless, you can sometimes also obtain useful information from the recovery catalog views, which reside in the recovery catalog schema and use the RC_ prefix.

This section contains the following topics:

- [About Recovery Catalog Views](#) (page 11-20)
- [Querying Catalog Views for the Target DB_KEY or DBID Values](#) (page 11-21)
- [Querying RC_BACKUP_FILES](#) (page 11-23)

11.6.1 About Recovery Catalog Views

RMAN obtains backup and recovery metadata from a target database control file and stores it in the tables of the recovery catalog. The recovery catalog views are derived from these tables. The recovery catalog views are not normalized or optimized for user queries.

In general, the recovery catalog views are not as user-friendly as the RMAN reporting commands. For example, when you start RMAN and connect to a target database, you obtain the information for this target database only when you issue LIST, REPORT, and SHOW commands. If you have 10 different target databases registered in the same recovery catalog, then any query of the catalog views shows the metadata for all incarnations of all 10 databases. You often must perform complex selects and joins among the views to extract usable information about a database [incarnation](#).

Most of the catalog views have a corresponding V\$ view in the database. For example, RC_BACKUP_PIECE corresponds to V\$BACKUP_PIECE. The primary difference between the recovery catalog view and corresponding V\$ view is that each recovery catalog view contains metadata about *all* the target databases registered in the recovery catalog. The V\$ view contains information only about itself.

See Also:

Oracle Database Backup and Recovery Reference for a description of recovery catalog views

11.6.1.1 About Unique Identifiers for Registered Databases

Most recovery catalog views contain the columns DB_KEY and DBINC_KEY. Each database registered in the recovery catalog can be uniquely identified by either the

primary key, which is the `DB_KEY` column value, or the `DBID`, which is the 32-bit unique database identifier. Each incarnation of a database is uniquely identified by the `DBINC_KEY` column.

You can use `DB_KEY` and `DBINC_KEY` to retrieve the records of a specific incarnation of a target database. Then, you can perform joins with most of the other catalog views to isolate records belonging to this incarnation.

An important difference between catalog and `V$` views is that a different system of unique identifiers is used for backup and recovery files. For example, many `V$` views such as `V$ARCHIVED_LOG` use the `RECID` and `STAMP` columns to form a concatenated primary key. The corresponding recovery catalog view uses a derived value as its primary keys and stores this value in a single column. For example, the primary key in `RC_ARCHIVED_LOG` is the `AL_KEY` column. The `AL_KEY` column value is the primary key that `RMAN` displays in the `LIST` command output.

11.6.1.2 About Unique Identifiers in a Data Guard Environment

Special considerations apply when querying the recovery catalog in a Data Guard environment.

In a Data Guard environment, multiple databases share the same `DBID`. Several views contain a `DB_UNIQUE_NAME` column, which indicates the `DB_UNIQUE_NAME` of the database incarnation to which the record belongs. All databases in a Data Guard environment share the same `DBID` but have different `DB_UNIQUE_NAME` values.

The value of `DB_UNIQUE_NAME` is `null` when the database name is not known to the catalog, as for Oracle9i databases that are registered in a recovery catalog. Also, the column value is `null` when a database is upgraded to Oracle Database 11g but the recovery catalog schema has not reconciled the database names for all files.

In the recovery catalog views, the primary database and its associated standby databases share the same `DB_KEY`. However, every database in a Data Guard environment has a unique `RC_SITE.SITE_KEY` value. For example, a primary database `prod` and its standby database `standby1` might both have the `DB_KEY` value of 1, whereas the `SITE_KEY` of `prod` is 3 and the `SITE_KEY` of `standby1` is 30.

Some recovery catalog views do not have a `DB_UNIQUE_NAME` column, but include a `SITE_KEY` column. You can use the `SITE_KEY` column to join with `RC_SITE.SITE_KEY` to determine the `DB_UNIQUE_NAME` of the database associated with a file. As explained in "[About RMAN File Management in a Data Guard Environment](#) (page 3-9)", every file in a Data Guard environment is associated with the primary or standby database that created it.

See Also:

Oracle Data Guard Concepts and Administration to learn how to report on and manage files in a Data Guard environment

11.6.2 Querying Catalog Views for the Target `DB_KEY` or `DBID` Values

The `DB_KEY` value, which is the primary key for a registered database, is used only in the recovery catalog. The easiest way to obtain the `DB_KEY` is to use the `DBID` of the target database, which is displayed whenever you connect `RMAN` to a database as `TARGET`.

The `DBID` distinguishes databases registered in the `RMAN` recovery catalog.

Assume that you want to obtain information about a database registered in the recovery catalog.

To query the catalog for information about the current incarnation of a database:

1. Determine the DBID for the database whose records you want to view.

You can obtain the DBID by looking at the output displayed when RMAN connects to the database, querying V\$RMAN_OUTPUT, or querying a V\$DATABASE view. The following example connects SQL*Plus to the desired database and queries the DBID:

```
SQL> CONNECT / AS SYSBACKUP
SQL> SELECT DBID
       2 FROM   V$DATABASE;

       DBID
-----
598368217
```

2. Start SQL*Plus and connect to the recovery catalog database as the owner of the recovery catalog.
3. Obtain the database key for the database whose DBID you obtained in Step 1.

To obtain the DB_KEY for a database run the following query, where *dbid_of_target* is the DBID obtained in Step 1:

```
SELECT DB_KEY
FROM   RC_DATABASE
WHERE  DBID = dbid_of_target;
```

4. Query the records for the current incarnation of the database whose DBID you obtained in Step 1.

To obtain information about the current incarnation of a target database, specify the target database DB_KEY value and perform a join with the RC_DATABASE_INCARNATION view. Use a WHERE condition to specify that the CURRENT_INCARNATION column value is set to YES. For example, to obtain information about backup sets in the current incarnation of a target database with the DB_KEY value of 1, query as follows:

```
SELECT BS_KEY, BACKUP_TYPE, COMPLETION_TIME
FROM   RC_DATABASE_INCARNATION i, RC_BACKUP_SET b
WHERE  i.DB_KEY = 1
AND    i.DB_KEY = b.DB_KEY
AND    i.CURRENT_INCARNATION = 'YES';
```

See Also:

- *Oracle Database Backup and Recovery Reference* for details about the RC_DATABASE_INCARNATION view
 - [About Database Incarnations](#) (page 14-7)
-

11.6.3 Querying RC_BACKUP_FILES

You can query the view RC_BACKUP_FILES for information about all backups of any database registered in the recovery catalog. Before querying RC_BACKUP_FILES, however, you must call the DBMS_RCVMAN.SETDATABASE procedure.

Specify the DBID of a database registered in the recovery catalog, as shown in the following example:

```
SQL> CALL DBMS_RCVMAN.SETDATABASE(null,null,null,2283997583);
```

The fourth parameter must be the DBID of a database registered in the recovery catalog. The other parameters must all be NULL.

See Also:

- *Oracle Database Backup and Recovery Reference* for details about the RC_BACKUP_FILES view
 - [Determining the DBID of the Database](#) (page 17-6) for techniques for determining the DBID of a database
-

Maintaining RMAN Backups and Repository Records

This chapter describes how to manage the RMAN repository records, and RMAN backups and copies. This chapter also explains maintenance tasks related to the fast recovery area. This chapter contains the following topics:

- [Overview of RMAN Backup and Repository Maintenance](#) (page 12-1)
- [Maintaining the Control File Repository](#) (page 12-4)
- [Maintaining the Fast Recovery Area](#) (page 12-7)
- [Updating the RMAN Repository](#) (page 12-11)
- [Deleting RMAN Backups and Archived Redo Logs](#) (page 12-20)
- [Dropping a Database](#) (page 12-27)

See Also:

[Managing a Recovery Catalog](#) (page 13-1) for RMAN maintenance issues that are specific to a [recovery catalog](#)

12.1 Overview of RMAN Backup and Repository Maintenance

This section explains the purpose and basic concepts of RMAN repository maintenance.

12.1.1 Purpose of Backup and Repository Maintenance

The recommended maintenance strategy is to configure a fast recovery area, a backup retention policy, and an archived redo log deletion policy. In this case, the database automatically maintains and deletes backups and archived redo logs as needed. However, manual maintenance of database backups and archived redo logs is sometimes necessary.

Managing RMAN backups involves the following related tasks:

- Managing the database backups that are stored on disk or tape
- Managing the records of those backups in the RMAN repository

An important part of RMAN maintenance is deleting backups that are no longer needed. If you configure a fast recovery area, then the database automatically deletes unneeded files in this area automatically; even so, you may want to delete backups

and copies from tape. You may even need to delete an entire database. You can use an RMAN command to perform these tasks.

The fast recovery area may require occasional maintenance. For example, the fast recovery area may become full, in which case you can add space to it. Alternatively, you may want to change the location of the recovery area.

It is possible for the [RMAN repository](#) to fail to reflect the true state of files on disk or tape. For example, a user may delete a backup from disk with an operating system utility. In this case, the RMAN repository shows that the file exists when it does not. In a similar situation, a tape containing RMAN backups may be corrupted. You can use [RMAN maintenance commands](#) to update the repository with accurate information.

12.1.2 Basic Concepts of Backup and Repository Maintenance

RMAN provides multiple commands to maintain RMAN backups and repository records.

Following are the RMAN maintenance commands:

- The `CATALOG` command enables you to add records about RMAN and user-managed backups that are currently not recorded in the RMAN repository, or to remove records for backups that are recorded.
- The `CHANGE` command enables you to update the status of records in the RMAN repository.
- The `CROSSCHECK` command enables you to synchronize the logical backup records with the physical reality of files in backup storage.
- The `DELETE` command enables you to delete backups from the operating system.

12.1.2.1 About Maintenance Commands and RMAN Repository Metadata

RMAN always stores its metadata in the control file of each target database on which it performs operations. If you register a target database in the recovery catalog, then RMAN stores the metadata for this target database in the recovery catalog.

All of the RMAN maintenance commands work with or without a recovery catalog.

See Also:

[Maintaining a Recovery Catalog](#) (page 13-26)

12.1.2.2 About Maintenance Commands in a Data Guard Environment

The database in a Data Guard environment that creates a backup or copy is associated with the file. For example, if RMAN is connected to target database `standby1` and backs it up, then this backup is associated with `standby1`.

If backups are accessible to RMAN according to the criteria specified in "[About RMAN File Management in a Data Guard Environment](#) (page 3-9)", you can use RMAN maintenance commands such as `CHANGE`, `DELETE`, and `CROSSCHECK` for backups when connected to any primary or standby database.

12.1.2.2.1 About Crosschecks in a Data Guard Environment

For a crosscheck, RMAN can only update the status of a file from `AVAILABLE` to `EXPIRED` when connected to the database associated with the file.

Thus, if RMAN crosschecks a file and does not find it, and if the file is associated with a database to which it is not connected as `TARGET`, then RMAN prompts you to perform the crosscheck when connected to the target database associated with the file. RMAN performs a crosscheck when you run the `CROSSCHECK` or `CHANGE . . . AVAILABLE` command.

12.1.2.2.2 About Deletion in a Data Guard Environment

RMAN can delete files when connected to any database. If RMAN is not connected as `TARGET` to the database associated with a file, and if RMAN cannot delete a file successfully, then RMAN prompts you to connect as `TARGET` to the database associated with the file. You must then use `DELETE . . . FORCE` to delete the file metadata.

12.1.2.2.3 About Updates to RMAN Metadata in a Data Guard Environment

If a maintenance command changes RMAN metadata only, then you can connect RMAN as `TARGET` to any database in the Data Guard environment.

Commands that change only metadata include:

- `CHANGE . . . UNAVAILABLE` or `CHANGE . . . UNCATALOG`
- `CHANGE . . . KEEP` or `CHANGE . . . NOKEEP`
- `CHANGE . . . RESET DB_UNIQUE_NAME`

By default, the `CHANGE` command only operates on files that are accessible according to the rules specified in "[About Accessibility of Backups in a Data Guard Environment](#) (page 3-9)". However, you can change the status of files associated with a database other than the target database by using the `FOR DB_UNIQUE_NAME` option.

12.1.2.2.4 About Files Not Associated with a Database

A backup remains associated with a database unless you explicitly use the `CHANGE . . . RESET DB_UNIQUE_NAME` to associate the backup with a different database.

In some cases the `DB_UNIQUE_NAME` may not be known for a specific file. For example, the value of `DB_UNIQUE_NAME` is `null` when the database name is not known to the recovery catalog, as for Oracle9i databases that are registered in a recovery catalog. Also, rows can have a `DB_UNIQUE_NAME` of `null` because a database has been upgraded to the current version, but the recovery catalog schema has not reconciled the `DB_UNIQUE_NAME` values for all files. By default, RMAN associates files whose `SITE_KEY` is `null` with the database to which RMAN is connected as `TARGET`.

See Also:

- *Oracle Data Guard Concepts and Administration* to learn how to use RMAN to back up and restore files in a Data Guard environment
 - *Oracle Database Backup and Recovery Reference* for a description of the RMAN `CHANGE` command
-
-

12.2 Maintaining the Control File Repository

RMAN is designed to work without a recovery catalog. If you choose not to use a recovery catalog, however, then the control file of each target database is the exclusive repository for RMAN metadata.

You must know how information is stored in the control file and ensure that your backup and recovery strategy protects the control file.

See Also:

Oracle Database Administrator's Guide for an overview of the control file and more details about managing control files

12.2.1 About Control File Records

The control file contains two types of records: circular reuse records and noncircular reuse records.

Circular reuse records contain noncritical information that is eligible to be overwritten if needed. These records contain information that is continually generated by the database. When all available record slots are full, the database either expands the control file to make room for a new record or overwrites the oldest record. The `CONTROL_FILE_RECORD_KEEP_TIME` initialization parameter specifies the minimum age in days of a record before it can be reused.

Noncircular reuse records contain critical information that does not change often and cannot be overwritten. Some examples of information in noncircular reuse records include data files, online redo log files, and redo threads.

As you make backups of a target database, the database records these backups in the control file. To prevent the control file from growing too large because of the addition of new records, records can be reused if they are older than a threshold that you specify. The `CONTROL_FILE_RECORD_KEEP_TIME` initialization parameter determines the minimum age in days of a record before it can be overwritten:

```
CONTROL_FILE_RECORD_KEEP_TIME = integer
```

For example, if the parameter value is 14, then any record of age 14 days or older is a candidate for reuse. Information in an overwritten record is lost. The oldest record available for reuse is used first.

When the database must add new RMAN repository records to the control file, but no record is older than the threshold, the database attempts to expand the size of the control file. If the underlying operating system prevents the expansion of the control file (due to a disk full condition, for instance), then the database overwrites the oldest record in the control file.

The database records the overwrite in the alert log located in the [Automatic Diagnostic Repository \(ADR\)](#). For each record that it overwrites, the database records an entry in the alert log similar to the following:

```
kccwnc: following control file record written over:
RECID #72 Recno 72 Record timestamp
07/28/06 22:15:21
Thread=1 Seq#=3460
Backup set key: stamp=372031415, count=17
Low scn: 0x0000.3af33f36
```

```
07/27/06 21:00:08
Next scn: 0x0000.3af3871b
07/27/06 23:23:54
Resetlogs scn and time
scn: 0x0000.00000001
```

12.2.1.1 About Fast Recovery Area and Control File Records

When a control file record containing information about a file created in the fast recovery area is about to be reused, the database attempts to delete the file from the fast recovery area when the file is eligible for deletion. Otherwise, the database expands the size of the control file section containing the record for this file.

The database logs the expansion in the alert log with a message like this example, where *nnnn* is the number of the control file record type:

```
kccwnc: trying to expand control file section nnnn for Oracle Managed Files
```

If the control file is at the maximum size supported under the host operating system, then the database cannot expand the control file. In such a situation, this warning appears in the alert log:

```
WARNING: Oracle Managed File filename is unknown to control file. This is the result
of limitation in control file size that could not keep all recovery area files.
```

The preceding message means that the control file cannot hold a record of all fast recovery area files needed to satisfy the configured retention policy. The next section explains how to respond to this situation.

See Also:

Oracle Database Reference for information about the
CONTROL_FILE_RECORD_KEEP_TIME initialization parameter

12.2.2 Preventing the Loss of Control File Records

The best way to prevent the loss of RMAN metadata because of overwritten control file records is to use a recovery catalog.

If you cannot use a recovery catalog, then you can take the following measures:

- Set the CONTROL_FILE_RECORD_KEEP_TIME value to slightly longer than the oldest file that you must keep. For example, if you back up the whole database once a week, then you must keep every backup for at least 7 days. Set CONTROL_FILE_RECORD_KEEP_TIME to a value such as 10 or 14. The default value of CONTROL_FILE_RECORD_KEEP_TIME is 7 days.

Caution:

Regardless of whether you use a recovery catalog, never use RMAN when CONTROL_FILE_RECORD_KEEP_TIME is set to 0. If you do, then you may lose backup records.

- Store the control file in a file system rather than on a [raw device](#) so that it can expand.

- Monitor the alert log to ensure that Oracle Database is not overwriting control file records. The alert log is located in the [Automatic Diagnostic Repository \(ADR\)](#).

If you use a fast recovery area, then follow these guidelines to avoid a situation in which the control file cannot hold a record of all fast recovery area files needed to satisfy the backup retention policy:

- If the block size of the control file is not at its maximum, then use a larger block size, preferably 32 kilobytes.
To achieve this aim, you must set the `SYSTEM` tablespace block size to be greater than or equal to the control file block size, and re-create the control file after changing `DB_BLOCK_SIZE`. The files in the fast recovery area are recataloged, but the records for files on tape are lost.
- Make the files in the fast recovery area eligible for deletion by backing them up to tertiary storage such as tape.
For example, you can use `BACKUP RECOVERY AREA` to specifically back up files in the fast recovery area to a media manager.
- If the backup retention policy is keeping backups and archived logs longer than your business requirements, then you can make more files in the fast recovery area eligible for deletion by changing the retention policy to a shorter recovery window or lower degree of redundancy.

12.2.3 Protecting the Control File

If you are not using a recovery catalog to store RMAN metadata, then it is doubly important that you protect each target database control file.

You can use the following strategy to protect the control file.

To protect the control file:

1. Create redundant copies of control files through [multiplexing](#) or operating system [mirroring](#).

In this way, the database can survive the loss of a subset of the control files without requiring you to restore a control file from backup. Oracle recommends that you use a minimum of two multiplexed or mirrored control files on separate disks.

2. Configure the [control file autobackup](#) feature.

In this case, RMAN automatically backs up the control file when you run certain RMAN commands. If a control file autobackup is available, RMAN can restore the server parameter and backup control file, and mount the database. After the control file is mounted, you can restore the remainder of the database.

3. Keep a record of the database DBID.

If you lose the control files, then you can use the DBID to recover the database.

See Also:

- [Backing Up Control Files with RMAN](#) (page 9-12) to learn about manual and automatic control file backups
 - [About RMAN Control File and Server Parameter File Autobackups](#) (page 8-15)
-

12.3 Maintaining the Fast Recovery Area

Although the fast recovery area is largely self-managing, some situations may require database administration intervention.

12.3.1 Deletion Rules for the Fast Recovery Area

RMAN uses certain rules to determine when files can be deleted from the fast recovery area.

The following rules govern when files become eligible for deletion from the recovery area:

- Permanent files are never eligible for deletion.
- Files that are obsolete under the retention policy are eligible for deletion.
- Transient files that have been copied to tape are eligible for deletion.
- Archived redo logs are not eligible for deletion until all the consumers of the logs have satisfied their requirements.

Consumers of logs can include RMAN, standby databases, Oracle Streams databases, and the Flashback Database feature.

- Foreign archived logs that have been mined by a LogMiner session on a logical standby database are eligible for deletion. Because it is generated from a different database than the current database, a [foreign archived redo log](#) has a different DBID than the current archived redo logs.

The safe and reliable way to control deletion of files from the fast recovery area is to configure your retention policy and archived log deletion policy. To increase the likelihood that files moved to tape are retained on disk, increase the fast recovery area quota.

See Also:

- ["Overview of Files in the Fast Recovery Area \(page 5-19\)"](#) for information about the contents of the fast recovery area and the difference between permanent and transient files
- ["Configuring an Archived Redo Log Deletion Policy \(page 5-35\)"](#) for information about how to configure an archived redo log deletion policy that determines when logs are eligible to be deleted
- [Configuring the Backup Retention Policy \(page 5-29\)](#) for information about how to configure the retention policy
- *Oracle Data Guard Concepts and Administration* to learn about archived redo log management in a Data Guard environment

12.3.2 Monitoring Fast Recovery Area Space Usage

You can use the V\$RECOVERY_FILE_DEST and V\$RECOVERY_AREA_USAGE views to determine whether you have allocated enough space for your fast recovery area.

Query the V\$RECOVERY_FILE_DEST view to discover the current location, disk quota, space in use, space reclaimable by deleting files, and total number of files in the fast recovery area. The space columns specify the amount in bytes. Query the V\$RECOVERY_AREA_USAGE view to discover the percentage of the total disk quota used by different types of files. Also, you can determine how much space for each type of file can be reclaimed by deleting files that are obsolete, redundant, or backed up to tape.

When guaranteed restore points are defined on your database, you must monitor the amount of space used in your fast recovery area for files required to meet the guarantee. Use the query for viewing guaranteed restore points in ["Listing Restore Points Using the LIST Command \(page 7-14\)"](#) and see the STORAGE_SIZE column to determine the space required for files related to each guaranteed restore point.

Example 12-1 Fast Recovery Area Space Consumption

The following example displays details about the fast recovery area such as the location, disk quota, space usage, and number of files.

```
SELECT * FROM V$RECOVERY_FILE_DEST;
```

NAME	SPACE_LIMIT	SPACE_USED	SPACE_RECLAIMABLE	NUMBER_OF_FILES	CON_ID
/mydisk/rcvsa	5368709120	109240320	256000	28	0

Example 12-2 Fast Recovery Area Space Usage Based on Type of Files

The following example displays the percentage of space used, percentage of space that can be reclaimed, and number of files in the fast recovery area for each type of file.

```
SELECT * FROM V$RECOVERY_AREA_USAGE;
```

FILE_TYPE	PERCENT_SPACE_USED	PERCENT_SPACE_RECLAIMABLE	NUMBER_OF_FILES	CON_ID
CONTROLFILE	0	0	0	0
ONLINELOG	2	0	22	0
ARCHIVELOG	4.05	2.01	31	0
BACKUPPIECE	3.94	3.86	8	0

IMAGECOPY	15.64	10.43	66	0
FLASHBACKLOG	.08	0	1	0

See Also:

- V\$RECOVERY_AREA_USAGE in *Oracle Database Reference*
 - V\$RECOVERY_FILE_DEST in *Oracle Database Reference*
-

12.3.3 Managing Space for Flashback Logs in the Fast Recovery Area

You cannot manage the flashback logs in the fast recovery area directly other than by setting the flashback retention target or using guaranteed restore points.

Nevertheless, you can manage fast recovery area space as a whole to maximize the space available for retention of flashback logs. In this way you increase the likelihood of achieving the flashback target.

To make space for flashback logs, back up the other contents of your fast recovery area to tape with commands such as `BACKUP RECOVERY AREA`, `BACKUP BACKUPSET`, and so on. Oracle Database automatically removes obsolete files from the fast recovery area. If offloading backups to tape still does not create enough space to satisfy the backup retention policy and flashback retention target, then allocate more space in the fast recovery area.

Note:

You cannot back up flashback logs. Thus, the `BACKUP RECOVERY AREA` operation does not include the flashback logs when backing up the fast recovery area contents to tape.

See Also:

[About Logging for Flashback Database with Guaranteed Restore Points Defined](#) (page 7-10) for the rules for flashback log deletion

12.3.4 Responding to a Full Fast Recovery Area

If the RMAN retention policy requires keeping a set of backups larger than the fast recovery area disk quota, or if the retention policy is set to `NONE`, then the fast recovery area can fill completely with no reclaimable space.

The database issues a warning alert when reclaimable space is less than 15% and a critical alert when reclaimable space is less than 3%. To warn the DBA of this condition, an entry is added to the alert log and to the `DBA_OUTSTANDING_ALERTS` table (used by Enterprise Manager). Nevertheless, the database continues to consume space in the fast recovery area until there is no reclaimable space left.

When the recovery area is completely full, the error displayed is as follows, where `nnnnn` is the number of bytes required and `mmmmm` is the disk quota:

```
ORA-19809: limit exceeded for recovery files
ORA-19804: cannot reclaim nnnnn bytes disk space from mmmm limit
```

You have several choices for how to resolve a full fast recovery area when no files are eligible for deletion:

- Make more disk space available and increase `DB_RECOVERY_FILE_DEST_SIZE` to reflect the additional space.

- Move backups from the fast recovery area to tertiary storage such as tape.

One convenient way to back up all of your recovery area files to tape together is the `BACKUP RECOVERY AREA` command. After you transfer backups from the recovery area to tape, you can delete files from the fast recovery area. Flashback logs cannot be backed up outside the recovery area and are not backed up by `BACKUP RECOVERY AREA`.

- Run `DELETE` for any files that have been removed with an operating system utility.

If you use host operating system commands to delete files, then the database is not aware of the resulting free space. You can run the `RMAN CROSSCHECK` command to have RMAN recheck the contents of the fast recovery area and identify expired files, and then use the `DELETE EXPIRED` command to delete every [expired backup](#) from the RMAN repository.

- Ensure that your guaranteed restore points are necessary. If not, delete them.

Flashback logs that are not needed for a guaranteed restore point are deleted automatically to gain space for other files in the fast recovery area. A guaranteed restore point forces the retention of flashback logs required to perform Flashback Database to the restore point SCN.

- Review your backup retention policy and, if using Data Guard, your archived redo log deletion policy.

See Also:

- [Deleting RMAN Backups and Archived Redo Logs](#) (page 12-20)
 - [Dropping Restore Points](#) (page 7-16)
 - [Backing Up the Database](#) (page 9-1) to decide on a retention policy
 - *Oracle Data Guard Concepts and Administration* for more information about archived log deletion policy with Data Guard
-
-

12.3.5 Changing the Fast Recovery Area to a New Location

Use the `ALTER SYSTEM` command to change the location of the fast recovery area.

If you must move the fast recovery area of your database to a new location, then follow this procedure:

1. Start SQL*Plus on the target database and change the `DB_RECOVERY_FILE_DEST` initialization parameter. For example, enter the following command to set the destination to the ASM disk group `disk1`:

```
ALTER SYSTEM SET DB_RECOVERY_FILE_DEST='+disk1' SCOPE=BOTH SID='*';
```

After you change this parameter, all new fast recovery area files are created in the new location.

2. Either leave or move the permanent files, flashback logs, and transient files in the old flash recovery location.

If you leave the existing files in the flash recovery, then the database deletes the transient files from the old fast recovery area as they become eligible for deletion.

If you must move the old files to the new fast recovery area, then see the *Oracle Automatic Storage Management Administrator's Guide*. The procedure for moving database files into and out of an ASM disk group with RMAN works when moving files into and out of a fast recovery area.

12.3.6 Disabling the Fast Recovery Area

The `ALTER SYSTEM` command can be used to disable the fast recovery area.

Before disabling the fast recovery area, you must first drop all guaranteed restore points and then turn off Flashback Database.

You can then set the `DB_RECOVERY_FILE_DEST` initialization parameter to a null string to disable the fast recovery area. For example, use the following SQL statement to change the parameter on a running database:

```
ALTER SYSTEM SET DB_RECOVERY_FILE_DEST='' SCOPE=BOTH SID='*';
```

The database no longer provides the space management features of the fast recovery area for the files stored in the old `DB_RECOVERY_FILE_DEST` location. The files are still known to the RMAN repository, however, and available for backup and restore activities.

12.3.7 Responding to an Instance Crash During File Creation

As a rule, the fast recovery area is self-maintaining. When an instance crashes during the creation of a file in the fast recovery area, however, the database may leave the file in the fast recovery area.

When this situation occurs, the alert log contains the following error, where *location* is the location of the fast recovery area:

```
ORA-19816: WARNING: Files may exist in location that are not known to database.
```

In such a situation, use the RMAN command `CATALOG RECOVERY AREA` to recatalog any such files. If the file header of the file in question is corrupted, then delete the file manually with an operating system utility.

12.4 Updating the RMAN Repository

Several situations can cause a discrepancy between the repository and the files that it records, including tape or disk failures and user-managed copies or deletions of RMAN-related files.

This section explains how to ensure that the RMAN repository accurately reflects the reality of the RMAN-related files stored on disk and tape.

12.4.1 Crosschecking the RMAN Repository

To ensure that data about backups in the recovery catalog or control file is synchronized with corresponding data on disk or in the media management catalog,

perform a crosscheck. The `CROSSCHECK` command operates only on files that are currently recorded in the RMAN repository.

If you use a fast recovery area, backup retention policy, and archived redo log deletion policy, then you do not need to perform crosschecks very often. If you delete files by means other than RMAN, then you must perform a crosscheck periodically to ensure that the repository data stays current.

12.4.1.1 About RMAN Crosschecks

Crosschecks update outdated RMAN repository information about backups whose repository records do not match their physical status. For example, if a user removes archived logs from disk with an operating system command, the repository still indicates that the logs are on disk, when in fact they are not.

Figure 12-1 (page 12-12) illustrates a crosscheck of a media manager. RMAN queries the RMAN repository for the names and locations of the four backup sets to be checked. RMAN sends this information to the target database server, which queries the media management software about the backups. The media management software then checks its media catalog and reports back to the server that backup set 3 is missing. RMAN updates the status of backup set 3 to `EXPIRED` in the repository. The record for backup set 3 is deleted after you run `DELETE EXPIRED`.

Figure 12-1 Crosschecking a Media Manager

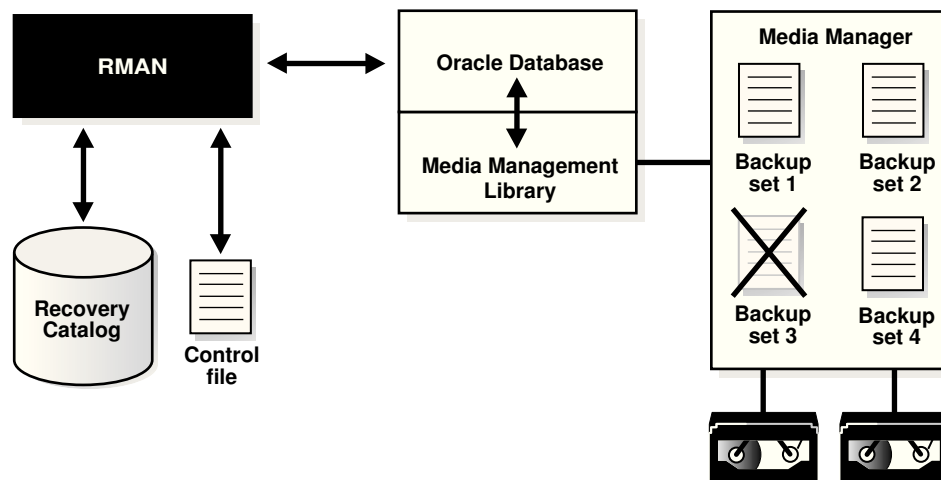

Crosschecks are useful because they can do the following:

- Update outdated information about backups that disappeared from disk or tape or became corrupted
- Update the repository if you delete archived redo logs or other files with operating system commands

Use the crosscheck feature to check the status of a backup on disk or tape. If the backup is on disk, then `CROSSCHECK` checks whether the header of the file is valid. If a backup is on tape, then the command checks that the backups exist in the media management software catalog.

Backup pieces and image copies can have the status `AVAILABLE`, `EXPIRED`, or `UNAVAILABLE`. You can view the status of backups by running the `RMAN LIST` command or by querying `V$BACKUP_FILES` or recovery catalog views such as `RC_DATAFILE_COPY` or `RC_ARCHIVED_LOG`. A crosscheck updates the RMAN repository so that all of these techniques provide accurate information. RMAN

updates each backup in the RMAN repository to status `EXPIRED` if the backup is no longer available. If a new crosscheck determines that an [expired backup](#) is available again, then RMAN updates its status to `AVAILABLE`.

Note:

The `CROSSCHECK` command does *not* delete operating system files or remove repository records. You must use the `DELETE` command for these operations.

You can issue the `DELETE EXPIRED` command to delete all expired backups. RMAN removes the record for the expired file from the repository. If for some reason the file still exists on the media, then RMAN issues warnings and lists the mismatched objects that cannot be deleted.

See Also:

- *Oracle Database Backup and Recovery Reference* for `CROSSCHECK` syntax and a description of the possible status values
 - *Oracle Database Backup and Recovery Reference* for `DELETE` syntax
-
-

12.4.1.2 Crosschecking All Backups and Copies

After connecting to the target database and recovery catalog (if you use one), run `CROSSCHECK` commands as needed to verify the status and availability of backups known to RMAN.

You can configure or manually allocate multiple channels before issuing `CROSSCHECK` or `DELETE` commands. RMAN searches for each backup on all channels that have the same device type as the channel used to create the backup. The multichannel feature is primarily intended for use when crosschecking or deleting backups on both disk and tape within a single command. For example, assume that you have an [SBT](#) channel configured as follows:

```
CONFIGURE DEVICE TYPE sbt PARALLELISM 1;
CONFIGURE DEFAULT DEVICE TYPE sbt;
```

In this case you can run the following commands to crosscheck both disk and SBT:

```
CROSSCHECK BACKUP;
CROSSCHECK COPY;
```

RMAN uses both the SBT channel and the preconfigured disk channel to perform the crosscheck. Sample output follows:

```
allocated channel: ORA_SBT_TAPE_1
channel ORA_SBT_TAPE_1: sid=12 devtype=SBT_TAPE
channel ORA_SBT_TAPE_1: WARNING: Oracle Test Disk API
using channel ORA_DISK_1
crosschecked backup piece: found to be 'AVAILABLE'
backup piece handle=/oracle/dbs/16c5esv4_1_1 recid=36 stamp=408384484
crosschecked backup piece: found to be 'AVAILABLE'
backup piece handle=/oracle/dbs/c-674966176-20000915-01 recid=37 stamp=408384496
crosschecked backup piece: found to be 'AVAILABLE'
backup piece handle=12c5erb2_1_1 recid=32 stamp=408382820
.
```

If you do not have an automatic SBT channel configured, then you can manually allocate maintenance channels on disk and tape.

```
ALLOCATE CHANNEL FOR MAINTENANCE DEVICE TYPE sbt;
CROSSCHECK BACKUP;
CROSSCHECK COPY;
```

You do not have to manually allocate a disk channel because RMAN uses the preconfigured disk channel.

12.4.1.3 Crosschecking Specific Backup Sets and Copies

You can use the `LIST` command to report your backups and then use the `CROSSCHECK` command to check that specific backups described in the `LIST` output still exist.

The `DELETE EXPIRED` command deletes repository records for backups that fail the crosscheck.

To crosscheck specified backups:

1. Start RMAN and connect to a target database and recovery catalog (if used).
2. Run a `LIST` command to identify the backups to be checked.

For example, run the following command:

```
LIST BACKUP; # lists all backup sets, proxy copies, and image copies
```

Crosscheck the desired backups or copies.

The following sample commands illustrate different types of crosschecks:

```
CROSSCHECK BACKUP; # checks backup sets, proxy copies, and image copies
CROSSCHECK COPY OF DATABASE;
CROSSCHECK BACKUPSET 1338, 1339, 1340;
CROSSCHECK BACKUPPIECE TAG 'nightly_backup';
CROSSCHECK BACKUP OF ARCHIVELOG ALL SPFILE;
CROSSCHECK BACKUP OF DATAFILE "?/oradata/trgt/system01.dbf"
  COMPLETED AFTER 'SYSDATE-14';
CROSSCHECK CONTROLFILECOPY '/tmp/control01.ct1';
CROSSCHECK DATAFILECOPY 113, 114, 115;
CROSSCHECK PROXY 789;
```

See Also:

Oracle Database Backup and Recovery Reference for more details on using `CROSSCHECK` to check backups of specific files

12.4.2 Changing the Repository Status of Backups and Copies

RMAN provides multiple methods of changing the repository status of backups and copies.

Perform any of the following tasks to change the repository status of backups and copies:

- Making backups available or unavailable

You can change the status of a backup if it becomes temporarily available or unavailable. For example, if a mounted disk undergoes maintenance, then you can update the records for backups on the disk to status UNAVAILABLE.

[Updating a Backup to Status AVAILABLE or UNAVAILABLE](#) (page 12-15) describes how to make backups available or unavailable.

- Including or exempting backups from the retention policy

Archival backups can be created by using the KEEP clause to exempt backups from the configured retention policy. You can also change the status of an archival backup and subsequently include it in the configured retention policy.

[Changing the Status of an Archival Backup](#) (page 12-15) describes how to change the status of archival backups.

12.4.2.1 Updating a Backup to Status AVAILABLE or UNAVAILABLE

Run the CHANGE . . . UNAVAILABLE command when a backup cannot be found or has migrated offsite.

RMAN does not use files with status UNAVAILABLE in RESTORE or RECOVER commands. If the file is later found or returns to the main site, then you can update its status again by issuing CHANGE . . . AVAILABLE . The files in the fast recovery area cannot be marked as UNAVAILABLE.

To update the status of a file in the repository to UNAVAILABLE or AVAILABLE:

1. Issue a LIST command to determine the availability status of RMAN backups. For example, issue the following command to list all backups:

```
LIST BACKUP;
```

2. Run CHANGE with the UNAVAILABLE or AVAILABLE keyword to update its status in the RMAN repository.

The following examples illustrate forms of the CHANGE command:

```
CHANGE DATAFILECOPY '/tmp/control01.ctl' UNAVAILABLE;
CHANGE COPY OF ARCHIVELOG SEQUENCE BETWEEN 1000 AND 1012 UNAVAILABLE;
CHANGE BACKUPSET 12 UNAVAILABLE;
CHANGE BACKUP OF SPFILE TAG "TAG20120208T154556" UNAVAILABLE;
CHANGE DATAFILECOPY '/tmp/system01.dbf' AVAILABLE;
CHANGE BACKUPSET 12 AVAILABLE;
CHANGE BACKUP OF SPFILE TAG "TAG20120208T154556" AVAILABLE;
```

See Also:

Oracle Database Backup and Recovery Reference for CHANGE command syntax

12.4.2.2 Changing the Status of an Archival Backup

You can designate backups as exempt from the retention policy. This technique is useful for archiving backups to comply with business requirements.

An [archival backup](#) is still a fully valid backup, however, and can be restored just as any other RMAN backup.

Note:

The `KEEP FOREVER` clause requires the use of a recovery catalog, because the control file cannot contain an infinitely large set of RMAN repository data.

You can use the `CHANGE` command to alter the `KEEP` status of an existing backup. For example, you may decide that you no longer want to keep a long-term backup. The same options available for `BACKUP . . . KEEP` are available with `CHANGE . . . KEEP`.

You cannot set `KEEP` attributes for backup sets or files stored in the [fast recovery area](#).

To alter the `KEEP` status of an archival backup:

1. Issue a `LIST` command to list the backups. For example, issue the following command to list all backups:

```
LIST BACKUP;
```

2. Issue a `CHANGE . . . KEEP` command to define a different retention period for this backup, or a `CHANGE . . . NOKEEP` command to let the retention policy apply to this file.

This example allows a backup set to be subject to the backup retention policy:

```
CHANGE BACKUPSET 231 NOKEEP;
```

This example makes a data file copy exempt from the retention policy for 180 days:

```
CHANGE DATAFILECOPY '/tmp/system01.dbf' KEEP UNTIL TIME 'SYSDATE+180';
```

See Also:

[Making Database Backups for Long-Term Storage](#) (page 9-44)

12.4.2.3 Changing the Status of Backups for Dropped PDBs

Use the `CHANGE` command with the `GUID` option to change the status of backups that correspond to pluggable databases (PDBs) that have been dropped from a multitenant container database (CDB).

After you drop a PDB, you cannot use the PDB name to change the status of backups associated with the dropped PDB. Instead, use the `GUID` to identify the dropped PDB.

1. Connect to the root as a common user with the `SYSDBA` or `SYSBACKUP` privilege.
2. Query the `DBA_PDB_HISTORY` view to determine the `GUID` of the PDB that was dropped.

The following example displays the PDBs that were deleted from the CDB

```
test_db:
```

```
SELECT pdb_name, pdb_guid FROM dba_pdb_history  
WHERE db_name = 'test_db';
```

3. Use the `CHANGE` command with the `GUID` clause to modify the status of a backup corresponding to a dropped PDB.

The following commands remove RMAN repository records of backup pieces and image copies associated with a dropped PDB that is identified using its GUID.

```
CHANGE BACKUPPIECE GUID 'DFCE8C3A437F214EB4230070EC0D294E' UNCATALOG;
CHANGE COPY GUID 'DFCE8C3A437F214EB4230070EC0D294E' UNCATALOG;
```

12.4.3 Adding Backup Records to the RMAN Repository

You can use the `CATALOG` command to make RMAN aware of the existence of archived logs not recorded in the repository or copies of database files that are created through means other than RMAN.

12.4.3.1 About Cataloging Operations

The target database control file keeps records of all archived redo logs generated by the target database and all RMAN backups. The purpose of the `CATALOG` command is to add metadata to the repository when it does not have a record of files for RMAN to manage.

Run the RMAN `CATALOG` command when:

- You use an operating system utility to make copies of data files, archived logs, or backup pieces. In this case, the repository has no record of them.
- You perform recovery with a backup control file and you change the archiving destination or format during recovery. In this situation, the repository does not have information about archived logs needed for recovery, and you must catalog these logs.
- You want to catalog data file copy as a level 0 backup, thus enabling you to perform an incremental backup later by using the data file copy as the base of an incremental backup strategy.
- You want to catalog user-managed copies of Oracle7 database files created before you migrated to a higher release, or of Oracle8 and higher database files created before you started to use RMAN. These data file copies enable you to recover the database if it fails after migration but before you have a chance to take a backup of the migrated database.

Whenever you make a user-managed copy, for example, by using the UNIX `cp` command to copy a data file, be sure to catalog it. When making user-managed copies, you can use the `ALTER TABLESPACE . . . BEGIN/END BACKUP` statement to make data file copies off an online tablespace. Although RMAN does not create such data file copies, you can use the `CATALOG` command to add them to the recovery catalog so that RMAN is aware of them.

For a user-managed copy to be cataloged, it must be:

- Accessible on disk
- A complete image copy of a single file
- Either a data file copy, control file copy, archived redo log copy, or backup piece copy

For example, if you store data files on mirrored disk drives, then you can create a user-managed copy by breaking the mirror. In this scenario, use the `CATALOG` command to notify RMAN of the existence of the user-managed copy after breaking the mirror. Before reforming the mirror, run a `CHANGE . . . UNCATALOG` command to notify RMAN that the file copy no longer exists.

12.4.3.2 Cataloging User-Managed Data File Copies

Use the `CATALOG` command to propagate information about user-managed copies to the RMAN repository. After the files are cataloged, you can run the `LIST` command or query `V$BACKUP_FILES` view to confirm the information is contained in the RMAN repository.

To create and catalog a user-managed copy of a data file:

1. Make a data file copy with an operating system utility. `ALTER TABLESPACE BEGIN/END BACKUP` is necessary if the database is open and the data files are online while the backup is in progress. This example backs up an online data file, using the `SQL*Plus HOST` command to issue an operating system command.

```
SQL> ALTER TABLESPACE users BEGIN BACKUP;
SQL> HOST CP $ORACLE_HOME/oradata/trgt/users01.dbf /tmp/users01.dbf;
SQL> ALTER TABLESPACE users END BACKUP;
```

2. Start RMAN and connect to a target database and recovery catalog (if used).
3. Run the `CATALOG` command.

For example, enter the following command to catalog a user-managed data file copy:

```
CATALOG DATAFILECOPY '/tmp/users01.dbf';
```

If you try to catalog a data file copy from a database other than the connected target database, then RMAN issues an error such as the following:

```
RMAN-00571: =====
RMAN-00569: ===== ERROR MESSAGE STACK FOLLOWS =====
RMAN-00571: =====
RMAN-03009: failure of catalog command on default channel at 08/29/2013 14:44:34
ORA-19563: datafile copy header validation failed for file /tmp/tools01.dbf
```

See Also:

Oracle Database Backup and Recovery Reference for `CATALOG` command syntax

12.4.3.3 Cataloging Backup Pieces

You can catalog backup pieces on disk. This technique is useful if you use an operating system utility to copy backup pieces from one location to another on the same host, or from one host to another.

You can even catalog a backup piece from a prior [incarnation](#) of the database. RMAN can determine whether that backup piece can be used during a subsequent restore and recovery operation.

To catalog a backup piece:

1. Start RMAN and connect to a target database and recovery catalog (if used).
2. Catalog the file names of the backup pieces.

For example, enter the following command:

```
CATALOG BACKUPPIECE '/disk2/09dtq55d_1_2', '/disk2/0bdtqdou_1_1';
```

3. Optionally, run a `LIST` command or query `V$` views to verify your changes.

Views include `V$BACKUP_PIECE`, `V$BACKUP_SET`, `V$BACKUP_DATAFILE`, `V$BACKUP_REDOLOG`, and `V$BACKUP_SPCFILE`. The following query shows the names of backup pieces:

```
SELECT HANDLE
FROM   V$BACKUP_PIECE;
```

See Also:

Oracle Database Backup and Recovery Reference for `CATALOG BACKUPPIECE` restrictions

12.4.3.4 Cataloging All Files in a Disk Location

If you use Automatic Storage Management (ASM), an Oracle Managed Files framework, or the fast recovery area, then you may want to recatalog files that are known to the disk management system but are no longer listed in the RMAN repository. This situation can occur when the intended mechanism for tracking file names fails due to media failure, software bug, or user error.

The `CATALOG START WITH` command enables you to search through all files in an ASM disk group, Oracle Managed Files location, or traditional file system directory and investigate those that are not recorded in the RMAN repository. If the command can catalog a file, then it does so. If it cannot catalog the file, then it makes its best guess about the contents of the skipped file.

The `CATALOG RECOVERY AREA` command enables you to catalog all files in the recovery area. Typically, you do not need to run this command manually because RMAN automatically runs it as needed, for example, when you restore or create a control file. You can run this command when files are copied into the fast recovery area by operating system utilities.

To catalog all files in a disk location:

1. Start RMAN and connect to a target database and recovery catalog (if used).
2. Run the `CATALOG` command, specifying the disk location whose files you want to catalog.

For example, enter the following commands:

```
CATALOG START WITH '+disk'; # catalog all files from an ASM disk group
CATALOG START WITH '/fs1/datafiles/'; # catalog all files in directory
```

Note:

Wildcard characters are not legal in the `START WITH` clause.

You can use the `CATALOG RECOVERY AREA` command to catalog all files in the recovery area. During this operation, any files in the recovery area not listed in the RMAN repository are added. For example:

```
CATALOG RECOVERY AREA;
```

3. Run a `LIST` command to verify that the files were cataloged.

12.4.4 Removing Records from the RMAN Repository

You can remove records for files from the RMAN repository.

12.4.4.1 About Uncataloging Operations in the RMAN Repository

Run the `CHANGE . . . UNCATALOG` command to perform the following actions on RMAN repository records:

- Update a backup record in the control file repository to status `DELETED`
- Delete a specific backup record from the recovery catalog (if you use one)

RMAN does not change the specified physical files: it only alters the repository records for these files.

You can use this command when you have deleted a backup through a means other than RMAN. For example, if you delete archived redo logs with an operating system utility, then remove the record for this log from the repository by issuing a `CHANGE ARCHIVELOG . . . UNCATALOG` command.

12.4.4.2 Removing Records for Files Deleted with Operating System Utilities

You can use the `CHANGE . . . UNCATALOG` command to update the RMAN repository for the absent files.

In some circumstances, users may have removed backups or archived redo logs with operating system utilities. Unless you run `CROSSCHECK`, RMAN does not know about the deletion. In such cases, you can use the `CHANGE . . . UNCATALOG` command.

To remove the catalog record for a backup or archived redo log:

1. Run a `CHANGE . . . UNCATALOG` command for the backups that you deleted from the operating system with operating system commands. This example deletes repository references to disk copies of the control file and data file 1:

```
CHANGE CONTROLFILECOPY '/tmp/control01.ct1' UNCATALOG;
CHANGE DATAFILECOPY '/tmp/system01.dbf' UNCATALOG;
```

2. Optionally, view the relevant recovery catalog view, for example, `RC_DATAFILE_COPY` or `RC_CONTROLFILE_COPY`, to confirm that a given record was removed. This query confirms that the record of copy 4833 was removed:

```
SELECT CDF_KEY, STATUS
FROM RC_DATAFILE_COPY
WHERE CDF_KEY = 4833;

CDF_KEY    STATUS
-----
0 rows selected.
```

12.5 Deleting RMAN Backups and Archived Redo Logs

You can use the RMAN `DELETE` command to delete archived redo logs and RMAN backups.

For backups on disk, deleting backups physically removes the backup file from disk. For backups on [SBT](#) devices, the RMAN `DELETE` command instructs the media manager to delete the backup pieces or proxy copies on tape. In either case, RMAN updates the RMAN repository to reflect the deletion.

Note:

In a CDB, you can delete archived logs only when you connect to the root as a user with the `SYSDBA` or `SYSBACKUP` privilege. Archived redo logs cannot be deleted when connected to a PDB.

12.5.1 Overview of Deleting RMAN Backups

Every RMAN backup produces a corresponding record in the RMAN repository. This record is stored in the control file. If a recovery catalog is used, then the record can also be found in the recovery catalog after the recovery catalog is resynchronized from the control file.

For example, if you generate a full database backup set, then you can view the record for this backup set in `V$BACKUP_SET`. If you use a recovery catalog, then you can also access the record in the `RC_BACKUP_SET` catalog view.

The `V$` control file views and recovery catalog views differ in the way that they store information, and this affects how RMAN handles repository records. The recovery catalog RMAN repository is stored in actual database tables, while the control file version of the repository is stored in an internal structure in the control file.

When you use an RMAN command to delete a backup or archived redo log file, RMAN does the following:

- Removes the physical file from the operating system (if the file is still present)
- Updates the file records in the control file to status `DELETED`
- Removes the file records from the recovery catalog tables (if RMAN is connected to a recovery catalog)

Because of the way that control file data is stored, RMAN cannot remove the record from the control file, only update it to `DELETED` status. Because the recovery catalog tables are ordinary database tables, however, RMAN deletes rows from them in the same way that rows are deleted from any table.

12.5.1.1 About RMAN Deletion Commands

You can delete backups and recovery catalog records for backups.

The following table describes the RMAN commands that can delete backups.

Table 12-1 RMAN Deletion Commands

Command	Purpose
DELETE	<p>To delete backups, update the control file records to status DELETED, and remove their records from the recovery catalog (if a recovery catalog is used).</p> <p>You can specify that DELETE removes backups that are EXPIRED or OBSOLETE. If you run DELETE EXPIRED on a backup that exists, then RMAN issues a warning and does not delete the backup. If you use the DELETE command with the optional FORCE keyword, then RMAN deletes the specified backups, but ignores any I/O errors, including those that occur when a backup is missing from disk or tape. It then updates the RMAN repository to reflect the fact that the backup is deleted, regardless of whether RMAN was able to delete the file or whether the file was missing.</p> <p>RMAN uses all configured channels to perform the deletion. If you use DELETE for files on devices that are not configured for automatic channels, then you must first use ALLOCATE CHANNEL FOR MAINTENANCE command. For example, if you made a backup with the SBT channel, but only a disk channel is configured, then you must manually allocate an SBT channel for DELETE. An automatic or manually allocated maintenance channel is required when you use DELETE command on a disk-only file.</p>
BACKUP . . .DELETE [ALL] INPUT	<p>To back up archived logs, data file copies, or backup sets, then delete the input files from the operating system after the successful completion of the backup. RMAN also deletes and updates repository records for the deleted input files.</p> <p>If you specify DELETE INPUT (without ALL), then RMAN deletes only the specific files that it backs up. If you specify ALL INPUT, then RMAN deletes all copies of the files recorded in the RMAN repository.</p>
CHANGE . . .UNCATALOG	<p>To delete recovery catalog records for specified backups and change their control file records to status DELETED. The CHANGE . . .UNCATALOG command only changes the RMAN repository record of backups, and does not actually delete backups.</p>

The RMAN repository record for an object can sometimes fail to reflect the physical status of the object. For example, you back up an archived redo log to disk and then use an operating system utility to delete it. If you run DELETE without first running CROSSCHECK, then the repository erroneously lists the log as AVAILABLE.

If you run RMAN interactively, then RMAN asks for confirmation before deleting any files. You can suppress these confirmations by using the NOPROMPT keyword with any form of the BACKUP command:

```
DELETE NOPROMPT ARCHIVELOG ALL;
```

See Also:

Oracle Database Backup and Recovery Reference for a description of `DELETE` behavior when mismatches occur between the RMAN repository and physical media

12.5.1.2 About Deletion of Archived Redo Logs

The recommended maintenance strategy is to configure a fast recovery area, a backup retention policy, and an archived redo log deletion policy.

By default, the archived redo logs deletion policy is configured to `NONE`. In this case, the fast recovery area considers the logs eligible for deletion if they have been backed up at least once to disk or tape or the logs are obsolete according to the backup retention policy.

Archived redo logs can be deleted automatically by the database or by any of the user-initiated RMAN commands listed in [Table 12-1](#) (page 12-22). For logs in the recovery area, the database retains them as long as possible and automatically deletes eligible logs when disk space is required. You can delete eligible logs from any location, inside or outside the recovery area, with `BACKUP . . . DELETE INPUT` or `DELETE ARCHIVELOG`. Both of these commands obey the archive redo log deletion policy when the policy is any setting other than `NONE`. You can override the archived redo log deletion policy settings by using the `FORCE` option in the `DELETE` command.

See Also:

- [Basic Concepts of Backup and Repository Maintenance](#) (page 12-2)
 - [Configuring an Archived Redo Log Deletion Policy](#) (page 5-35)
 - The `CONFIGURE ARCHIVELOG DELETION POLICY` entry in *Oracle Database Backup and Recovery Reference* for detailed information about policy options
-

12.5.2 Deleting All Backups and Copies

Use the RMAN `DELETE` command to delete backups and image copies.

In some circumstances, you may need to delete all backup sets, proxy copies, and image copies associated with a database. For example, you no longer need a database and want to remove all related files from the system. An image copy is a file generated with `BACKUP AS COPY` command, a log archived by the database, or a file cataloged with the `CATALOG` command.

To delete all backups and copies:

1. Start RMAN and connect to a target database and recovery catalog (if used).
2. If necessary, allocate maintenance channels for the devices containing the backups to be deleted.

As explained in [Table 12-1](#) (page 12-22), RMAN uses all configured channels to perform the deletion. If channels are configured, then you do not need to manually allocate maintenance channels.

3. Crosscheck the backups and copies to ensure that the logical records are synchronized with the physical media.

```
CROSSCHECK BACKUP;
CROSSCHECK COPY;
```

4. Delete the backups and copies.

For example, enter the following commands and then enter YES when prompted:

```
DELETE BACKUP;
DELETE COPY;
```

If disk and tape channels are configured, then RMAN uses both the configured SBT channel and the preconfigured disk channel when deleting. RMAN prompts you for confirmation before deleting any files.

12.5.3 Deleting Specified Backups and Copies

You can use both the `DELETE` and `BACKUP . . . DELETE` commands to delete specific backups and copies.

The `BACKUP . . . DELETE` command backs up the files first, typically to tape, and then deletes the input files afterward.

The `DELETE` command supports a wide range of options to identify objects to delete. When deleting archived redo logs, RMAN uses the configured settings to determine whether a log can be deleted.

To delete specified backups and copies:

1. Start RMAN and connect to a target database and recovery catalog (if used).
2. If necessary, allocate maintenance channels for the devices containing the backups to be deleted.

As explained in [Table 12-1](#) (page 12-22), RMAN uses all configured channels to perform the deletion. If channels are configured, then you do not need to manually allocate maintenance channels.

3. Delete the specified backups and copies.

The following examples show many of the common ways to specify backups and archived logs to delete with the `DELETE` command:

- Deleting backups using primary keys from `LIST` output:

```
DELETE BACKUPPIECE 101;
```

- Deleting backups by file name on disk:

```
DELETE CONTROLFILECOPY '/tmp/control01.ct1';
```

Deleting archived redo logs:

```
DELETE NOPROMPT ARCHIVELOG UNTIL SEQUENCE 300;
```

Deleting backups based on tags:

```
DELETE BACKUP TAG 'before_upgrade';
```

Delete backups based on the objects backed up and the media or disk location where the backup is stored:

```
DELETE BACKUP OF TABLESPACE users DEVICE TYPE sbt; # delete only from tape
DELETE COPY OF CONTROLFILE LIKE '/tmp/%';
```

Delete backups and archived redo logs from disk based on whether they are backed up on tape:

```
DELETE ARCHIVELOG ALL
    BACKED UP 3 TIMES TO sbt;
```

See Also:

- [Configuring an Archived Redo Log Deletion Policy](#) (page 5-35)
 - *Oracle Database Backup and Recovery Reference* for complete information about the `DELETE` command options
-
-

12.5.3.1 Deleting Specified Files with `BACKUP ... DELETE`

You can use `BACKUP . . . DELETE` to back up archived redo logs, data file copies, or backup sets and then delete the input files after successfully backing them up.

Specifying the `DELETE INPUT` option is equivalent to issuing the `DELETE` command for the input files. RMAN uses the configured settings to determine whether an archived redo log can be deleted. The `ALL` option in the `DELETE ALL INPUT` clause applies only to archived redo logs. If you run `BACKUP . . . DELETE ALL INPUT`, then the command deletes all copies of corresponding archived redo logs or data file copies that match the selection criteria in the `BACKUP` command.

See Also:

[Configuring an Archived Redo Log Deletion Policy](#) (page 5-35)

12.5.4 Deleting Expired RMAN Backups and Copies

If you run `CROSSCHECK`, and if RMAN cannot locate the files, then it updates their records in the RMAN repository to `EXPIRED` status. You can then use the `DELETE EXPIRED` command to remove records of expired backups and copies from the RMAN repository.

The `DELETE EXPIRED` command issues warnings if any files marked as `EXPIRED` actually exist. In rare cases, the repository can mark a file as `EXPIRED` even though it exists. For example, a directory containing a file is corrupted at the time of the crosscheck, but is later repaired, or the media manager was not configured properly and reported some backups as not existing when they really existed.

To delete expired repository records:

1. If you have not performed a crosscheck recently, then issue a `CROSSCHECK` command. For example, issue:

```
CROSSCHECK BACKUP;
```

2. Delete the expired backups. For example, issue:

```
DELETE EXPIRED BACKUP;
```

12.5.5 Deleting Obsolete RMAN Backups Based on Retention Policies

The RMAN `DELETE` command supports an `OBSOLETE` option, which deletes backups that are no longer needed to satisfy specified recoverability requirements.

You can delete files that are obsolete according to the configured default retention policy, or another retention policy that you specify as an option to the `DELETE OBSOLETE` command. As with other forms of the `DELETE` command, the files deleted are removed from backup media, deleted from the recovery catalog, and marked as `DELETED` in the control file.

If you specify the `DELETE OBSOLETE` command with no arguments, then RMAN deletes all obsolete backups defined by the configured retention policy. For example:

```
DELETE OBSOLETE;
```

12.5.5.1 DELETE OBSOLETE Behavior When KEEP UNTIL TIME Expires

If the `KEEP UNTIL TIME` period has not expired for an archival backup, RMAN does not consider the backup as obsolete. As soon as the `KEEP UNTIL` period expires, however, the backup is immediately considered to be obsolete, regardless of any configured backup retention policy. Thus, `DELETE OBSOLETE` deletes any backup created with `BACKUP ... KEEP UNTIL TIME` if the `KEEP` time has expired.

See Also:

Oracle Database Backup and Recovery Reference for `keepOption` syntax

12.5.6 Deleting Backups of Dropped PDBs

Use the `DELETE` command with the `GUID` option to delete backups of pluggable databases (PDBs) that have been dropped from a multitenant container database (CDB).

The `DELETE BACKUP ... OF PLUGGABLE DATABASE` command deletes backups of the specified PDB. However, after a PDB is dropped, you cannot use this command because the a PDB with the specified name no longer exists. In such cases, use the `DELETE BACKUP ... GUID` command to delete backups of dropped PDBs. Each PDB has a globally unique identifier (GUID) which can be used to uniquely identify a PDB. The GUID of dropped PDBs is available in the `DBA_PDB_HISTORY` view.

To delete backups of a dropped PDB:

1. Connect to the root as a common user with the `SYSDBA` or `SYSBACKUP` privilege.
2. Query the `DBA_PDB_HISTORY` view to determine the GUID of the PDB that was dropped.

The following example displays the PDBs that were deleted from the CDB `prod_db`:

```
SELECT pdb_name, pdb_guid FROM dba_pdb_history
WHERE db_name = 'prod_db';
```

3. Use the `DELETE` command with the `GUID` option to delete backups or copies associated with the dropped PDB.

The following commands delete backup sets and image copies of a dropped PDB with the specified GUID:

```
DELETE BACKUP GUID '100E64EC12445321C0352900AF0FAC93';
DELETE COPY GUID '100E64EC12445321C0352900AF0FAC93';
```

12.6 Dropping a Database

To remove a database from the operating system, you can use the `DROP DATABASE` command in RMAN. RMAN removes the server parameter file, all data files, online redo logs, and control files belonging to the target database.

`DROP DATABASE` requires that RMAN be connected to the target database, and that the target database be mounted. The command does not require connection to the recovery catalog. If RMAN is connected to the recovery catalog, and if you specify the option `INCLUDE COPIES AND BACKUPS`, then RMAN also unregisters the database.

To delete a database:

1. Start RMAN and connect to a target database and recovery catalog (if used).

See Also:

[Making Database Connections with RMAN](#) (page 4-2)

2. Catalog all backups that are associated with the database. For example, the following commands catalog files in the fast recovery area, and then in a secondary archiving destination:

```
CATALOG START WITH '+disk1'; # all files from recovery area on ASM disk
CATALOG START WITH '/arch_dest2'; # all files from second archiving location
```

3. Delete all backups and copies associated with the database. For example:

```
DELETE BACKUPSET; # deletes all backups
DELETE COPY; # deletes all image copies (including archived logs)
```

4. Remove the database from the operating system.

The following command deletes the database and automatically unregisters it from the recovery catalog (if used). RMAN prompts for confirmation.

```
DROP DATABASE;
```

See Also:

- [Dropping a Database with SQL*Plus](#) (page 31-19) to learn how to use the SQL `DROP DATABASE` statement
 - *Oracle Database Backup and Recovery Reference* for the RMAN `DROP DATABASE` command syntax
-

Managing a Recovery Catalog

This chapter explains how to manage an RMAN recovery catalog. The catalog is a database schema that contains the RMAN repository data for one or more target databases. This chapter contains the following topics:

- [Overview of the RMAN Recovery Catalog](#) (page 13-1)
- [Creating a Recovery Catalog](#) (page 13-5)
- [Registering a Database in the Recovery Catalog](#) (page 13-8)
- [Cataloging Backups in the Recovery Catalog](#) (page 13-10)
- [Creating and Managing Virtual Private Catalogs](#) (page 13-11)
- [Protecting the Recovery Catalog](#) (page 13-17)
- [Managing Stored Scripts](#) (page 13-20)
- [Maintaining a Recovery Catalog](#) (page 13-26)
- [Dropping a Recovery Catalog](#) (page 13-42)

See Also:

- [Maintaining RMAN Backups and Repository Records](#) (page 12-1) to learn how to manage the RMAN repository as stored in the control file, without a recovery catalog
 - The compatibility matrix in *Oracle Database Backup and Recovery Reference* for descriptions of supported interoperability scenarios
-

13.1 Overview of the RMAN Recovery Catalog

This section explains the basic concepts related to managing a recovery catalog.

13.1.1 Purpose of the RMAN Recovery Catalog

A recovery catalog is a database schema used by RMAN to store metadata about one or more Oracle databases. Typically, you store the catalog in a dedicated database.

A recovery catalog provides the following benefits:

- A recovery catalog creates redundancy for the RMAN repository stored in the control file of each [target database](#). The recovery catalog serves as a secondary metadata repository. If the target control file and all backups are lost, then the RMAN metadata still exists in the recovery catalog.

- A recovery catalog centralizes metadata for all your target databases. Storing the metadata in a single place makes reporting and administration tasks easier to perform.
- A recovery catalog can store metadata history much longer than the control file. This capability is useful if you must do a recovery that goes further back in time than the history in the control file. The added complexity of managing a recovery catalog database can be offset by the convenience of having the extended backup history available.

Some RMAN features function only when you use a recovery catalog. For example, you can store RMAN scripts in a recovery catalog. The chief advantage of a [stored script](#) is that it is available to any RMAN client that can connect to the target database and recovery catalog. Command files are only available if the RMAN client has access to the file system on which they are stored.

A recovery catalog is required when you use RMAN in a Data Guard environment. By storing backup metadata for all primary and standby databases, the catalog enables you to offload backup tasks to one standby database while enabling you to restore backups on other databases in the environment.

13.1.2 Basic Concepts for the RMAN Recovery Catalog

The recovery catalog contains metadata about RMAN operations for each registered target database. When RMAN is connected to a recovery catalog, RMAN obtains its metadata exclusively from the catalog.

The catalog includes the following types of metadata:

- Data file and archived redo log backup sets and backup pieces
- Data file copies
- Archived redo logs and their copies
- Database structure (tablespaces and data files)
- Stored scripts, which are named user-created sequences of RMAN commands
- Persistent RMAN configuration settings

13.1.2.1 About Database Registration in an RMAN Recovery Catalog

The process of enrolling of a database in a recovery catalog for RMAN use is called registration.

The recommended practice is to register every [target database](#) in your environment in a single recovery catalog. For example, you can register databases `prod1`, `prod2`, and `prod3` in a single catalog owned by `rco` in the database `catdb`.

See Also:

[Registering a Database in the Recovery Catalog](#) (page 13-8)

13.1.2.2 About Centralization of Metadata in a Base RMAN Recovery Catalog

The owner of a centralized recovery catalog, which is also called the base recovery catalog, can grant or revoke restricted access to the catalog to other database users.

Each restricted user has full read/write access to his own metadata, which is called a [virtual private catalog](#). The RMAN metadata is stored in the schema of the virtual private catalog owner. The owner of the base recovery catalog determines which objects each virtual private catalog user can access.

You can use a recovery catalog in an environment in which you use or have used different versions of Oracle Database. As a result, your environment can have different versions of the RMAN client, recovery catalog database, recovery catalog schema, and target database. "[Importing and Moving a Recovery Catalog](#) (page 13-39)" explains how to merge multiple recovery catalog schemas into one.

See Also:

[Creating and Managing Virtual Private Catalogs](#) (page 13-11)

13.1.2.3 About RMAN Recovery Catalog Resynchronization

For RMAN operations such as backup, restore, and crosscheck, RMAN always first updates the control file and then propagates the metadata to the recovery catalog. This flow of metadata from the mounted control file to the recovery catalog, which is known as recovery catalog resynchronization, ensures that the metadata that RMAN obtains from the control file is current.

See Also:

[Resynchronizing the Recovery Catalog](#) (page 13-27)

13.1.2.4 About Stored Scripts

You can use a stored script as an alternative to a command file for managing frequently used sequences of RMAN commands. The script is stored in the recovery catalog rather than on the file system.

A local stored script is associated with the target database to which RMAN is connected when the script is created, and can only be executed when you are connected to this target database. A global stored script can be run against any database registered in the recovery catalog. A virtual private catalog user has read-only access to global scripts. Creating or updating global scripts must be done while connected to the base recovery catalog.

See Also:

[Managing Stored Scripts](#) (page 13-20)

13.1.2.5 Recovery Catalog in a Data Guard Environment

You must use a recovery catalog to manage RMAN metadata for all physical databases, both primary and standby databases, in the Data Guard environment. RMAN uses the recovery catalog as the single source of truth for the Data Guard environment.

RMAN can use the recovery catalog to update a primary or standby control file in a [reverse resynchronization](#). In this case, the metadata flows from the catalog to the control file rather than the other way around. RMAN automatically performs

resynchronizations in most situations in which they are needed. Thus, you do not need to use the `RESYNC` command to manually resynchronize very often.

See Also:

- [About RMAN in a Data Guard Environment](#) (page 3-8)
 - *Oracle Data Guard Concepts and Administration* to learn how to configure the RMAN environment for use with a standby database
-
-

13.1.3 Basic Steps of Managing a Recovery Catalog

Managing a recovery catalog consists of creating the catalog and then registering your target databases with the catalog.

The basic steps for setting up a recovery catalog for use by RMAN are as follows:

1. Create the recovery catalog.

"[Creating a Recovery Catalog](#) (page 13-5)" explains how to perform this task.

2. Register your target databases in the recovery catalog.

This step enables RMAN to store metadata for the target databases in the recovery catalog. "[Registering a Database in the Recovery Catalog](#) (page 13-8)" explains this task.

3. If needed, catalog any older backups whose records are no longer stored in the target control file.

"[Cataloging Backups in the Recovery Catalog](#) (page 13-10)" explains how to perform this task.

4. If needed, create virtual private catalogs for specific users and determine the metadata to which they are permitted access.

"[Creating and Managing Virtual Private Catalogs](#) (page 13-11)" explains how to perform this task.

5. Protect the recovery catalog by including it in your backup and recovery strategy.

"[Protecting the Recovery Catalog](#) (page 13-17)" explains how to back up and recover the catalog, and increase its availability.

See Also:

- "[Managing Stored Scripts](#) (page 13-20)" for information about how to store RMAN scripts in the recovery catalog and manage them
 - "[Reporting on RMAN Operations](#) (page 11-1)" explains how to report on RMAN operations
 - "[Maintaining a Recovery Catalog](#) (page 13-26)" describes a variety of tasks for ongoing recovery catalog maintenance, including how to import one recovery catalog into another recovery catalog
 - "[Dropping a Recovery Catalog](#) (page 13-42)" for information about deleting a recovery catalog
-
-

13.2 Creating a Recovery Catalog

Creating a recovery catalog consists of multiple phases that includes configuring the recovery catalog database, creating the recovery catalog schema owner, and then creating the catalog.

This section contains the following topics:

- [Configuring the Recovery Catalog Database](#) (page 13-5)
- [Creating the Recovery Catalog Schema Owner](#) (page 13-7)
- [Executing the CREATE CATALOG Command](#) (page 13-7)

13.2.1 Configuring the Recovery Catalog Database

When you use a recovery catalog, RMAN requires that you maintain a recovery catalog schema. The recovery catalog is stored in the default tablespace of the schema. Privileged users such as SYS cannot be the owner of the recovery catalog.

Decide which database you will use to install the recovery catalog schema, and also how you will back up this database. Also, decide whether to operate the catalog database in ARCHIVELOG mode, which is recommended.

Note:

Do not use the target database to be backed up as the database for the recovery catalog. The recovery catalog must be protected if the target database is lost.

13.2.1.1 Planning the Size of the Recovery Catalog Schema

You must allocate space to be used by the catalog schema. The size of the recovery catalog schema depends upon the number of databases monitored by the catalog.

The schema also grows as the number of archived redo log files and backups for each database increases. Finally, if you use RMAN stored scripts stored in the catalog, some space must be allocated for those scripts.

For example, assume that the `trgt` database has 100 files, and that you back up the database once a day, producing 50 backup sets containing 1 backup piece each. If you assume that each row in the backup piece table uses the maximum amount of space,

then one daily backup consumes less than 170 kilobytes in the recovery catalog. So, if you back up once a day for a year, then the total storage in this period is about 62 megabytes. Assume approximately the same amount for archived logs. Thus, the worst case is about 120 megabytes for a year for metadata storage. For a more typical case in which only a portion of the backup piece row space is used, 15 MB for each year is realistic.

If you plan to register multiple databases in your recovery catalog, then remember to add up the space required for each one based on the previous calculation to arrive at a total size for the default tablespace of the recovery catalog schema.

13.2.1.2 Allocating Disk Space for the Recovery Catalog Database

If you are creating your recovery catalog in an existing database, then add enough room to hold the default tablespace for the recovery catalog schema.

If you are creating a new database to hold your recovery catalog, then in addition to the space for the recovery catalog schema itself, allow space for other files in the recovery catalog database:

- SYSTEM and SYSAUX tablespaces
- Temporary tablespaces
- Undo tablespaces
- Online redo log files

Most of the space used in the recovery catalog database is devoted to supporting tablespaces, for example, the SYSTEM, temporary, and undo tablespaces. [Table 13-1](#) (page 13-6) describes typical space requirements.

Table 13-1 Typical Recovery Catalog Space Requirements for 1 Year

Type of Space	Space Requirement
SYSTEM tablespace	90 MB
Temp tablespace	5 MB
Rollback or undo tablespace	5 MB
Recovery catalog tablespace	15 MB for each database registered in the recovery catalog
Online redo logs	1 MB each (three groups, each with two members)

Caution:

Ensure that the recovery catalog and target databases do *not* reside on the same disk. If both your recovery catalog and your target database suffer hard disk failure, then your recovery process is much more difficult. If possible, take other measures as well to eliminate common points of failure between your recovery catalog database and the databases that you are backing up.

13.2.2 Creating the Recovery Catalog Schema Owner

After choosing the recovery catalog database and creating the necessary space, you are ready to create the owner of the recovery catalog and grant this user necessary privileges.

Assume the following background information for the instructions in the following sections:

- User SBU has SYSBACKUP privilege on the recovery catalog database `catdb`.
- A tablespace called `TOOLS` in the recovery catalog database `CATDB` stores the recovery catalog. If you use an RMAN reserved word as a tablespace name, you must enclose it in quotes and put it in uppercase.

See Also:

See *Oracle Database Backup and Recovery Reference* for a list of RMAN reserved words

- A tablespace called `TEMP` exists in the recovery catalog database.

To create the recovery catalog schema in the recovery catalog database:

1. Start SQL*Plus and connect with administrator privileges to the database containing the recovery catalog. In this example, the database is `catdb`.
2. Create a user and schema for the recovery catalog. For example, you could enter the following SQL statement (replacing *password* with a user-defined password):

```
CREATE USER rco IDENTIFIED BY password
TEMPORARY TABLESPACE temp
DEFAULT TABLESPACE tools
QUOTA UNLIMITED ON tools;
```

Note:

Create a password that is secure. See *Oracle Database Security Guide* for more information.

3. Grant the `RECOVERY_CATALOG_OWNER` role to the schema owner. This role provides the user with all privileges required to maintain and query the recovery catalog.

```
GRANT RECOVERY_CATALOG_OWNER TO rco;
```

13.2.3 Executing the CREATE CATALOG Command

After creating the catalog owner, create the catalog tables with the RMAN `CREATE CATALOG` command. The command creates the catalog in the default tablespace of the catalog owner.

Note: Starting with Oracle Database 12c Release 1 (12.1.0.2), the recovery catalog database must use the Enterprise Edition of Oracle Database.

To create the recovery catalog:

1. Enable Oracle Partitioning for the recovery catalog database.
2. Start RMAN and connect to the database that will contain the catalog. Connect to the database as the recovery catalog owner.
3. Run the `CREATE CATALOG` command to create the catalog. The creation of the catalog can take several minutes. If the catalog tablespace is this user's default tablespace, then you can run the following command:

```
RMAN> CREATE CATALOG;
```

You can specify the tablespace name for the catalog in the `CREATE CATALOG` command. For example:

```
RMAN> CREATE CATALOG TABLESPACE cat_tbs;
```

Note:

If the tablespace name for the recovery catalog is an RMAN reserved word, then it *must* be uppercase and enclosed in quotes. For example:

```
CREATE CATALOG TABLESPACE 'CATALOG';
```

4. You can check the results by using SQL*Plus to query the recovery catalog to see which tables were created:

```
SQL> SELECT TABLE_NAME FROM USER_TABLES;
```

See Also:

- `GRANT` command syntax in *Oracle Database SQL Language Reference*
 - `CREATE USER` command syntax in *Oracle Database SQL Language Reference*
 - *Oracle Database Backup and Recovery Reference* for `CREATE CATALOG` command syntax
-

13.3 Registering a Database in the Recovery Catalog

Registering a target database in the recovery catalog maintains the database's records in the recovery catalog.

13.3.1 About Registration of a Database in the Recovery Catalog

The process of enrolling of a target database in a recovery catalog is called registration.

If a target database is not registered in the recovery catalog, then RMAN cannot use the catalog to store metadata for operations on this database. You can still perform RMAN operations on an unregistered database: RMAN always stores its metadata in the control file of the target database.

If you are *not* using the recovery catalog in a Data Guard environment, then use the `REGISTER` command to register each database. Each database must have a unique [DBID](#). If you use the `RMAN DUPLICATE` command or the `CREATE DATABASE`

statement in SQL, then the database is assigned a unique DBID automatically. If you create a database by other means, then the copied database may have the same DBID as its source database. You can change the DBID with the `DBNEWID` utility so that you can register the source and copy databases in the same catalog.

You can use the `UNREGISTER` command to unregister a database from the recovery catalog.

13.3.1.1 About Standby Database Registration

In a Data Guard environment, the primary and standby databases share the same DBID and database name. To be eligible for registration in the recovery catalog, each database in the Data Guard environment must have different `DB_UNIQUE_NAME` values.

The `DB_UNIQUE_NAME` parameter for a database is set in its initialization parameter file. If you use RMAN in a Data Guard environment, then you can use the `REGISTER DATABASE` command only for the primary database.

You can use the following techniques to register a standby database in the recovery catalog:

- When you connect to a standby database as `TARGET`, RMAN automatically registers the database in the recovery catalog.
- When you run the `CONFIGURE DB_UNIQUE_NAME` command for a standby database that is not known to the recovery catalog, RMAN automatically registers this standby database if its primary database is registered.

See Also:

- [Unregistering a Target Database from the Recovery Catalog](#) (page 13-32)
 - *Oracle Database Backup and Recovery Reference* for `DUPLICATE` command syntax
 - *Oracle Database Utilities* to learn how to use the `DBNEWID` utility to change the DBID
 - *Oracle Data Guard Concepts and Administration* to learn about using RMAN in a Data Guard environment
-

13.3.2 Registering a Database with the REGISTER DATABASE Command

The first step in using a recovery catalog with a target database is registering the target database in the recovery catalog. If you use the catalog in a Data Guard environment, then you can only register the primary database in this way.

Use the following procedure:

1. Start RMAN and connect to a target database and recovery catalog. The recovery catalog database must be open.

For example, issue the following command to connect to the catalog database with the net service name `catdb` as user `rco` (who owns the catalog schema):

```
% rman TARGET / CATALOG rco@catdb;
```

- If the target database is not mounted, then mount or open it:

```
STARTUP MOUNT;
```

- Register the target database in the connected recovery catalog:

```
REGISTER DATABASE;
```

RMAN creates rows in the catalog tables to contain information about the target database, then copies all pertinent data about the target database from the control file into the catalog, synchronizing the catalog with the control file.

- Verify that the registration was successful by running REPORT SCHEMA:

```
REPORT SCHEMA;
```

```
Report of database schema for database with db_unique_name TRGT
```

```
List of Permanent Datafiles=====
```

File	Size(MB)	Tablespace	RB segs	Datafile Name
1	307200	SYSTEM	NO	/oracle/oradata/trgt/system01.dbf
2	20480	UNDOTBS	YES	/oracle/oradata/trgt/undotbs01.dbf
3	10240	CWMLITE	NO	/oracle/oradata/trgt/cwmlite01.dbf
4	10240	DRSYS	NO	/oracle/oradata/trgt/drsys01.dbf
5	10240	EXAMPLE	NO	/oracle/oradata/trgt/example01.dbf
6	10240	INDX	NO	/oracle/oradata/trgt/indx01.dbf
7	10240	TOOLS	NO	/oracle/oradata/trgt/tools01.dbf
8	10240	USERS	NO	/oracle/oradata/trgt/users01.dbf

```
List of Temporary Files
```

```
=====
```

File	Size(MB)	Tablespace	Maxsize(MB)	Tempfile Name
1	200	TEMP	32767	/oracle/oradata/trgt/tbs_tmp.dbf

13.4 Cataloging Backups in the Recovery Catalog

If you have data file copies, backup pieces, or archived logs on disk, then you can catalog them in the recovery catalog with the CATALOG command. When using a recovery catalog, cataloging older backups that have aged out of the control file lets RMAN use the older backups during restore operations.

The following commands illustrate this technique:

```
CATALOG DATAFILECOPY '/disk1/old_datafiles/01_01_2003/users01.dbf';
CATALOG ARCHIVELOG '/disk1/arch_logs/archive1_731.dbf',
                  '/disk1/arch_logs/archive1_732.dbf';
CATALOG BACKUPPIECE '/disk1/backups/backup_820.bkp';
```

You can also catalog multiple backup files in a directory by using the CATALOG START WITH command, as shown in the following example:

```
CATALOG START WITH '/disk1/backups/';
```

RMAN lists the files to be added to the RMAN repository and prompts for confirmation before adding the backups. Be careful when creating your prefix with CATALOG START WITH. RMAN scans all paths for all files on disk that begin with the specified prefix. The prefix is not just a directory name. Using the wrong prefix can cause the cataloging of the wrong set of files.

For example, assume that a group of directories `/disk1/backups`, `/disk1/backups-year2003`, `/disk1/backupsets`, `/disk1/backupsets/test` and so on, all contain backup files. The following command catalogs all files in all of these directories, because `/disk1/backups` is a prefix for the paths for all of these directories:

```
CATALOG START WITH '/disk1/backups';
```

To catalog only backups in the `/disk1/backups` directory, the correct command is as follows:

```
CATALOG START WITH '/disk1/backups/';
```

See Also:

- *Oracle Database Backup and Recovery Reference* for REGISTER syntax
 - *Oracle Database Upgrade Guide* for issues relating to database migration
-

13.5 Creating and Managing Virtual Private Catalogs

RMAN provides multiple commands to create and manage virtual private catalogs.

13.5.1 Overview of Virtual Private Catalogs

By default, all of the users of an RMAN recovery catalog have full privileges to read, select, insert, update, and delete any metadata in the catalog. For example, if the administrators of two unrelated databases share the same recovery catalog, each administrator could, whether inadvertently or maliciously, destroy catalog data for the other's database. In many enterprises, this situation is tolerated because the same people manage many different databases and also manage the recovery catalog. But in other enterprises where clear separation of duty exists between administrators of various databases, and between the DBA and the administrator of the recovery catalog, you may desire to restrict each database administrator to modify only backup metadata belonging to those databases that they are responsible for, while still keeping the benefits of a single, centrally-managed, RMAN recovery catalog. This goal can be achieved by implementing [virtual private catalogs](#).

Every RMAN recovery catalog starting with Oracle Database 11g supports virtual private catalogs, but they are not used unless explicitly created. There is no restriction on the number of virtual private catalogs that can be created beneath one recovery catalog. Each virtual private catalog is owned by a database schema user which is different than the user who owns the recovery catalog.

After you set up a virtual private catalog user, the administrator for the recovery catalog grants each virtual private catalog the privilege to use that catalog for one or more databases that are currently registered in the recovery catalog. The administrator of the recovery catalog can also grant the privilege to register new databases while using a virtual private catalog.

Note:

Every virtual private catalog has access to all global stored scripts, and those non-global stored scripts that belong to those databases for which this virtual private catalog has privileges. Virtual private catalogs cannot access non-global stored scripts that belong to databases that they do not have privileges for, and they cannot create global stored scripts.

13.5.2 About Using the VPD Model for Virtual Private Catalogs

RMAN uses the Virtual Private Database (VPD) functionality to implement virtual private catalogs.

The VPD functionality is not enabled by default when the RMAN base recovery catalog is created. You need to explicitly enable the VPD model for a base recovery catalog by running the `$ORACLE_HOME/rdbms/admin/dbmsrmanvpc.sql` script after upgrading the base catalog schema.

The format of the `dbmsrmanvpc.sql` script is as follows:

```
$ORACLE_HOME/rdbms/admin/dbmsrmanvpc.sql [[-vpd | -novpd | -scan ]
base_catalog_schema_name[...]] | -all
```

The RMAN base catalog schema names are provided as command-line parameters when running `dbmsrmanvpc.sql`. You can specify a maximum of ten base catalog schema names each time you run the script.

[Table 13-2](#) (page 13-12) describes the options that you can use when running the `dbmsrmanvpc.sql` script. You must use one of the command line options or provide a catalog schema name.

Table 13-2 dbmsrmanvpc.sql Options

dbmsrmanvpc.sql Option Name	Description
-vpd	Grants the privileges required to support the VPD protected catalog. Connect to the RMAN base catalog and perform <code>UPGRADE CATALOG</code> after the VPD privileges are granted.
-novpd	Disables VPD functionality by cleaning up the base recovery catalog schema, revoking grants, and removing database objects. This option can only be used when there are no existing VPC users registered in the base recovery catalog.
-scan	Performs a scan of the RMAN base catalog owner schemas and reports on the roles granted and the status of VPC users.
-all	Automatically detects the RMAN base catalog schemas and upgrades.

Example 13-1 Enabling VPD Model for VPC User Schemas

Connect to SQL*Plus and use the following command to enable the VPD model for all the virtual private catalogs of the RMAN base catalog `rman_cat`.

```
SQL> @$ORACLE_HOME/rdbms/admin/dbmsrmanvpc.sql -vpd rman_cat
```

13.5.3 Creating Virtual Private Catalogs

Creating a virtual private catalog is a multi-step process in which you first create the database user who will own the virtual private catalog and then create the virtual private catalog.

Note:

If the recovery catalog is a virtual private catalog, then the RMAN client connecting to it must be at patch level 10.1.0.6 or 10.2.0.3. Oracle9i RMAN clients cannot connect to a virtual private catalog. This version restriction does not affect RMAN client connections to an Oracle Database 11g base recovery catalog, even if it has some virtual private catalog users.

Assume that the following databases are registered in the base recovery catalog: `prod1`, `prod2`, and `prod3`. The database user who owns the base recovery catalog is `rco`. You want to create database user `vpc1` and grant this user access privileges only to `prod1` and `prod2`. By default, a virtual private catalog owner has no access to the base recovery catalog.

The base RMAN recovery catalog must be created before you create virtual private catalogs.

To create a virtual private catalog:

1. Create the database user who will own the virtual private catalog and grant access privileges to this user.
 - a. Start SQL*Plus and connect to the recovery catalog database with administrator privileges.
 - b. Create the user who will own the virtual private catalog.

For example, if you want database user `vpc1` to own the virtual private catalog, then execute the following command (replacing *password* with a user-defined password):

```
SQL> CREATE USER vpc1 IDENTIFIED BY password
2  DEFAULT TABLESPACE vpcusers
3  QUOTA UNLIMITED ON vpcusers;
```

Note:

Create a password that is secure. See *Oracle Database Security Guide* for more information.

- c. Grant the `RECOVERY_CATALOG_OWNER` role to the user, and then exit SQL*Plus.

The following example grants the role to user `vpc1`:

```
SQL> GRANT recovery_catalog_owner TO vpc1;
SQL> EXIT;
```

- d. Start RMAN and connect to the recovery catalog database as the base recovery catalog owner (*not* the virtual private catalog owner).

The following example connects to the base recovery catalog as `rco`:

```
% rman
RMAN> CONNECT CATALOG rco@catdb;

recovery catalog database Password: password
connected to recovery catalog database
```

- e. Grant desired privileges to the virtual private catalog owner.

The following example gives user `vpcl` access to the metadata for `prod1` and `prod2` (but not `prod3`):

```
RMAN> GRANT CATALOG FOR DATABASE prod1 TO vpcl;
RMAN> GRANT CATALOG FOR DATABASE prod2 TO vpcl;
```

You can also use a DBID rather than a database name. The virtual private catalog user does not have access to the metadata for any other databases registered in the recovery catalog.

You can also grant the user the ability to register new target databases in the recovery catalog. For example:

```
RMAN> GRANT REGISTER DATABASE TO vpcl;
```

2. Create the virtual private catalog.
 - a. Start RMAN and connect to the recovery catalog database as the virtual private catalog owner (*not* the base recovery catalog owner).

The following example connects to the recovery catalog as `vpcl`:

```
% rman
RMAN> CONNECT CATALOG vpcl@catdb;
```

- b. Create the virtual private catalog.

The following command creates the virtual private catalog:

```
RMAN> CREATE VIRTUAL CATALOG;
```

- c. If you intend to use a 10.2 or earlier release of RMAN with this virtual private catalog, then execute the following PL/SQL procedure (where *base_catalog_owner* is the database user who owns the base recovery catalog):

```
SQL> EXECUTE base_catalog_owner.DBMS_RVCAT.CREATE_VIRTUAL_CATALOG;
```

3. (Optional) Enable the VPD model for the virtual private catalog by running the `dbmsrmanvpc.sql` script with the `vpd` option.

See Also:

- [About Using the VPD Model for Virtual Private Catalogs](#) (page 13-12) for information about `dbmsrmanvpc.sql` and its options
 - *Oracle Database Backup and Recovery Reference* for details about RMAN version compatibility
-

13.5.4 Registering a Database with a Virtual Private Catalog

To store backup metadata for a target database in a virtual private catalog, you must register the database with the virtual private catalog.

Create the virtual private catalog before you register a target database with it.

To register database with a virtual private catalog and store backup metadata:

1. Start RMAN and connect to the recovery catalog database as the virtual private catalog owner (*not* the base recovery catalog owner). Connect to the database that you want to register as TARGET.

```
%rman
RMAN> CONNECT TARGET /
RMAN> CONNECT CATALOG vpc1@catdb;
```

2. Register the database whose metadata must be stored in the virtual private catalog.

The following example registers the database with the virtual private catalog owner vpc1.

```
RMAN> REGISTER DATABASE;
```

3. Back up the database using the BACKUP command with the required clauses.

Metadata related to the backup is stored in the virtual private catalog.

13.5.5 Revoking Privileges from a Virtual Private Catalog Owner

After you create a virtual private catalog, you can revoke catalog access privileges as necessary.

Assume that two databases are registered in the base recovery catalog: prod1 and prod2. As owner of the base recovery catalog, you have granted the vpc1 user access privileges to prod1. You have also granted this user the right to register databases in his virtual private catalog. Now you want to revoke privileges from vpc1.

To revoke privileges from a virtual private catalog owner:

1. Start RMAN and connect to the recovery catalog database as the recovery catalog owner (*not* the virtual private catalog owner).

The following example connects to the recovery catalog as rco:

```
% rman
RMAN> CONNECT CATALOG rco@catdb;
```

2. Revoke specified privileges from the virtual private catalog owner.

The following command revokes access to the metadata for prod1 from virtual private catalog owner vpc1:

```
REVOKE CATALOG FOR DATABASE prod1 FROM vpc1;
```

You can also specify a DBID rather than a database name. The catalog vpc1 retains all other granted catalog privileges.

You can also revoke the privilege to register new target databases in the recovery catalog. For example:

```
REVOKE REGISTER DATABASE FROM vpc1;
```

13.5.6 Dropping a Virtual Private Catalog

When you drop a virtual private catalog, you do not remove the base recovery catalog itself, but only drop the security policies that restrict access to the base recovery catalog.

This section assumes that you have created a virtual private catalog and now want to drop it.

To drop a virtual private catalog:

1. Start RMAN and connect to the recovery catalog database as the virtual private catalog owner (*not* the base recovery catalog owner).

The following example connects to the recovery catalog as user vpc1:

```
% rman
RMAN> CONNECT CATALOG vpc1@catdb;
```

2. Drop the catalog.

If you are using an Oracle Database 11g or later RMAN executable, then drop the virtual private catalog with the `DROP CATALOG` command:

```
RMAN> DROP CATALOG;
```

If you are using an Oracle Database 10g or earlier RMAN executable, then you cannot use the `DROP CATALOG` command. Instead, connect SQL*Plus to the catalog database as the virtual private catalog user, then execute the following PL/SQL procedure (where *base_catalog_owner* is the database user who owns the base recovery catalog):

```
SQL> EXECUTE base_catalog_owner.DBMS_RCVCAT.DELETE_VIRTUAL_CATALOG;
```

13.5.7 Upgrading Virtual Private Catalogs

RMAN uses the Virtual Private Database (VPD) functionality to implement virtual private catalogs. If your database has not been upgraded to Oracle Database 12c Release 2 (12.2) or you created a recovery catalog and virtual private catalogs using a version lower than Oracle Database 12c Release 1 (12.1.0.2), then you must upgrade these virtual private catalogs. RMAN provides scripts, located in the `$ORACLE_HOME/rdbms/admin` directory, to upgrade virtual private catalogs.

To upgrade virtual private catalogs to Oracle Database 12c Release 2 (12.2):

1. Use SQL*Plus to connect to the recovery catalog database as the SYS user with SYSDBA privilege.
2. Run the `dbmsrmansys.sql` script to grant additional privileges that are required for the `RECOVERY_CATALOG_OWNER` role.

```
SQL> @$ORACLE_HOME/rdbms/admin/dbmsrmansys.sql
```

3. Connect RMAN to the base recovery catalog, upgrade the base recovery catalog, and then exit RMAN.

Assume that the database user who owns the base recovery catalog is `rco`. The following command upgrades the base recovery catalog. The `UPGRADE CATALOG` command must be entered twice to confirm the upgrade.

```
$ rman CATALOG rco@catdb
recovery catalog database password:
RMAN> UPGRADE CATALOG;
RMAN> UPGRADE CATALOG;
RMAN> EXIT;
```

4. Use SQL*Plus to connect to the recovery catalog database as the `SYS` user with `SYSDBA` privilege.
5. Run the `dbmsrmanvpc.sql` script to upgrade virtual private catalog schemas to the VPD model.

The base recovery catalog schema name must be provided as an input parameter to this script. You can specify a maximum of 10 schema names. Alternately, you can use the `-all` option to automatically detect base catalog schemas and upgrade all associated virtual private catalog schemas.

The following command upgrades the virtual private catalog schemas of the base recovery catalog owned by `rco`:

```
SQL> @$ORACLE_HOME/rdbms/admin/dbmsrmanvpc.sql rco
```

See Also:

[About Using the VPD Model for Virtual Private Catalogs](#) (page 13-12) for information about the `dbmsrmanvpc.sql` script and its options

13.6 Protecting the Recovery Catalog

Include the recovery catalog database in your backup and recovery strategy. If you do not back up the recovery catalog and a disk failure occurs that destroys the recovery catalog database, then you may lose the metadata in the catalog. Without the recovery catalog contents, recovery of your other databases is likely to be more difficult.

13.6.1 Backing Up the Recovery Catalog

A single recovery catalog can store metadata for multiple target databases. Consequently, loss of the recovery catalog can be disastrous. You must back up the recovery catalog frequently.

This section provides general guidelines for developing a strategy for protecting the recovery catalog.

13.6.1.1 Backing Up the Recovery Catalog Frequently

The recovery catalog database is a database like any other, and is also a key part of your backup and recovery strategy. Protect the recovery catalog like any other part of your database, by backing it up. The backup strategy for your recovery catalog database is part of an overall backup and recovery strategy.

Back up the recovery catalog with the same frequency that you back up a target database. For example, if you make a weekly whole database backup of a target database, then back up the recovery catalog after the backup of the target database. This backup of the recovery catalog can help you in a disaster recovery scenario. Even if you must restore the recovery catalog database with a control file autobackup, you

can use the full record of backups in your restored recovery catalog database to restore the target database.

13.6.1.2 Choosing the Appropriate Technique for Physical Backups

When backing up the recovery catalog database, you can use RMAN to make the backups.

As illustrated in [Figure 13-1](#) (page 13-18), start RMAN with the `NOCATALOG` option so that the repository for RMAN is the control file in the catalog database.

Figure 13-1 Using the Control File as the Repository for Backups of the Recovery Catalog

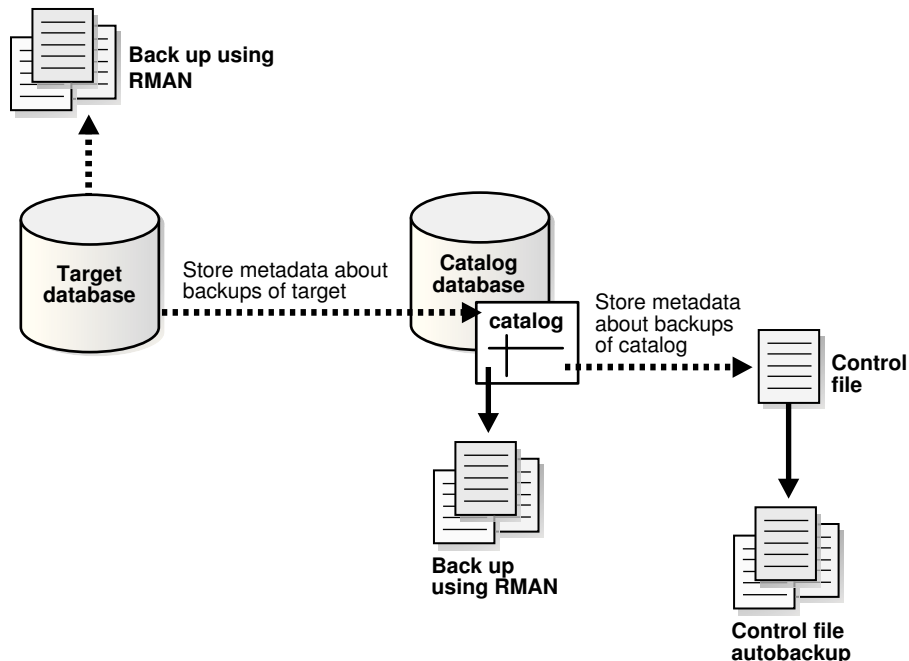

Follow these guidelines when developing an RMAN backup strategy for the recovery catalog database:

- Run the recovery catalog database in `ARCHIVELOG` mode so that you can do point-in-time recovery if needed.
- Set the retention policy to a `REDUNDANCY` value greater than 1.
- Back up the database to two separate media (for example, disk and tape).
- Run `BACKUP DATABASE PLUS ARCHIVELOG` at regular intervals, to a media manager if available, or just to disk.
- Do not use another recovery catalog as the repository for the backups.
- Configure the control file autobackup feature to `ON`.

With this strategy, the control file autobackup feature ensures that the recovery catalog database can always be recovered, so long as the control file autobackup is available.

See Also:

[Performing Disaster Recovery](#) (page 20-9) for more information for recovery with a control file autobackup

13.6.1.3 Separating the Recovery Catalog from the Target Database

A recovery catalog is only effective when separated from the data that it is designed to protect. Thus, you must never store a recovery catalog containing the RMAN repository for a database in the same database as the target database. Also, do not store the catalog database on the same disks as the target database.

To illustrate why data separation is advised, assume that you store the catalog for database `prod1` in `prod1`. If `prod1` suffers a total media failure, and if the recovery catalog for `prod1` is also stored in `prod1`, then if you lose the database you also lose the recovery catalog. At this point the only option is to restore an autobackup of the control file for `prod1` and use it to restore and recover the database without the benefit of any information stored in the recovery catalog.

13.6.1.4 Exporting the Recovery Catalog Data for Logical Backups

Logical backups of the RMAN recovery catalog created with the Data Pump Export utility can be a useful supplement for physical backups.

For damage to a recovery catalog database, you can use Data Pump Import to quickly reimport the exported recovery catalog data into another database and rebuild the catalog.

13.6.2 Recovering the Recovery Catalog

Restoring and recovering the recovery catalog database is much like restoring and recovering any other database with RMAN.

You can restore the control file and server parameter file for the recovery catalog database from an autobackup, then restore and perform complete recovery on the rest of the database. If you are in a situation where you are using multiple recovery catalogs, then you can also use another recovery catalog to record metadata about backups of this recovery catalog database.

If recovery of the recovery catalog database through the normal Oracle recovery procedures is not possible, then you must re-create the catalog. Examples of this worst-case scenario include:

- A recovery catalog database that has never been backed up
- A recovery catalog database that has been backed up, but cannot be recovered because the data file backups or archived logs are not available

You have the following options for partially re-creating the contents of the missing recovery catalog:

- Use the `RESYNC CATALOG` command to update the recovery catalog with any RMAN repository information from the control file of the target database or a control file copy. Any metadata from control file records that aged out of the control file is lost.
- Issue `CATALOG START WITH` commands to recatalog any available backups.

To minimize the likelihood of this worst-case scenario, your backup strategy must at least include backing up the recovery catalog. This technique is described in "[Backing Up the Recovery Catalog](#) (page 13-17)".

See Also:

- *Oracle Database Backup and Recovery Reference* for information about the CATALOG command
 - *Oracle Database Backup and Recovery Reference* for information about the CROSSCHECK command
-

13.7 Managing Stored Scripts

You can create and store scripts in the recovery catalog.

See Also:

[About Stored Scripts](#) (page 13-20)

13.7.1 About Stored Scripts

You can use a stored script as an alternative to a command file for managing frequently used sequences of RMAN commands. The script is stored in the recovery catalog rather than on the file system.

Stored scripts can be local or global. A local script is associated with the target database to which RMAN is connected when the script is created, and can only be executed when you are connected to that target database. A global stored script can be run against any database registered in the recovery catalog, if the RMAN client is connected to the recovery catalog and a target database.

The commands allowable within the brackets of the `CREATE SCRIPT` command are the same commands supported within a `RUN` block. Any command that is legal within a `RUN` command is permitted in the stored script. The following commands are not legal within stored scripts: `RUN`, `@`, and `@@`.

When specifying a script name, RMAN permits but generally does not require that you use quotes around the name of a stored script. If the name begins with a digit or is an RMAN reserved word, however, then you must put quotes around the name to use it as a stored script name. Consider avoiding stored script names that begin with nonalphabetic characters or that are the same as RMAN reserved words.

Consider using a naming convention to avoid confusion between global and local stored scripts. For the `EXECUTE SCRIPT`, `DELETE SCRIPT` and `PRINT SCRIPT` commands, if the script name passed as an argument is not the name of a script defined for the connected target instance, then RMAN looks for a global script by the same name. For example, if the global script `global_backup` is in the recovery catalog, but no local stored script `global_backup` is defined for the target database, then the following command deletes the global script:

```
DELETE SCRIPT global_backup;
```

To use commands related to stored scripts, even global scripts, you must be connected to both a recovery catalog and a target database instance.

13.7.2 Creating Stored Scripts

You can use the `CREATE SCRIPT` command to create a stored script.

If `GLOBAL` is specified, then a global script with this name must not exist in the recovery catalog. If `GLOBAL` is not specified, then a local script must not exist with the same name for the same target database. You can also use the `REPLACE SCRIPT` to create a new script or update an existing script.

To create a stored script:

1. Start RMAN and connect to a target database and recovery catalog (if used).

See Also:

[Making Database Connections with RMAN](#) (page 4-2)

2. Run the `CREATE SCRIPT` command.

The following example illustrates creation of a local script:

```
CREATE SCRIPT full_backup
{
  BACKUP DATABASE PLUS ARCHIVELOG;
  DELETE OBSOLETE;
}
```

For a global script, the syntax is similar:

```
CREATE GLOBAL SCRIPT global_full_backup
{
  BACKUP DATABASE PLUS ARCHIVELOG;
  DELETE OBSOLETE;
}
```

Optionally, you can provide a `COMMENT` with descriptive information:

```
CREATE GLOBAL SCRIPT global_full_backup
COMMENT 'use only with ARCHIVELOG mode databases'
{
  BACKUP DATABASE PLUS ARCHIVELOG;
  DELETE OBSOLETE;
}
```

You can also create a script by reading its contents from a text file. The file must begin with a left brace (`{`) character, contain a series of commands valid within a `RUN` block, and end with a right brace (`}`) character. Otherwise, a syntax error is signalled, just as if the commands were entered at the keyboard.

```
CREATE SCRIPT full_backup
FROM FILE '/tmp/my_script_file.txt';
```

3. Examine the output.

If no errors are displayed, then RMAN successfully created the script and stored in the recovery catalog.

See Also:

Oracle Database Backup and Recovery Reference for the list of RMAN reserved words

13.7.3 Replacing Stored Scripts

To update stored scripts, use the `REPLACE SCRIPT` command.

If you are replacing a local script, then you must be connected to the target database that you connected to when you created the script. If the script does not exist, then RMAN creates it.

To replace a stored script:

1. Start RMAN and connect to a target database and recovery catalog (if used).
2. Execute `REPLACE SCRIPT`.

This following example updates the script `full_backup` with new contents:

```
REPLACE SCRIPT full_backup
{
  BACKUP DATABASE PLUS ARCHIVELOG;
}
```

You can update global scripts by specifying the `GLOBAL` keyword as follows:

```
REPLACE GLOBAL SCRIPT global_full_backup
COMMENT 'A script for full backup to be used with any database'
{
  BACKUP AS BACKUPSET DATABASE PLUS ARCHIVELOG;
}
```

As with `CREATE SCRIPT`, you can update a local or global stored script from a text file with the following form of the command:

```
REPLACE GLOBAL SCRIPT global_full_backup
FROM FILE '/tmp/my_script_file.txt';
```

See Also:

Oracle Database Backup and Recovery Reference for `REPLACE SCRIPT` command syntax

13.7.4 Executing Stored Scripts

Use the `EXECUTE SCRIPT` command to run a stored script.

If `GLOBAL` is specified, then a global script with this name must exist in the recovery catalog; otherwise, RMAN returns error `RMAN-06004`. If `GLOBAL` is not specified, then RMAN searches for a local stored script defined for the current target database. If no local script with this name is found, then RMAN searches for a global script by the same name and executes it if one is found.

To execute a stored script:

1. Start RMAN and connect to a target database and recovery catalog (if used).
2. If needed, use SHOW to examine your configured channels.

Your script uses the automatic channels configured at the time you execute the script. Use `ALLOCATE CHANNEL` commands in the script if you must override the configured channels. Because of the `RUN` block, if an RMAN command in the script fails, subsequent RMAN commands in the script do not execute.

3. Run `EXECUTE SCRIPT`. This command requires a `RUN` block, as shown in the following example:

```
RUN
{
  EXECUTE SCRIPT full_backup;
}
```

The preceding command invokes a local script if one exists with the name specified. If no local script is found, but there is a global script with the name specified, then RMAN executes the global script.

You can also use `EXECUTE GLOBAL SCRIPT` to control which script is invoked if a local and a global script have the same name. If there is no local script called `global_full_backup`, the following two commands have the same effect:

```
RUN
{
  EXECUTE GLOBAL SCRIPT global_full_backup;
}

RUN
{
  EXECUTE SCRIPT global_full_backup;
}
```

See Also:

Oracle Database Backup and Recovery Reference for `EXECUTE SCRIPT` command syntax

13.7.5 Creating and Executing Dynamic Stored Scripts

You can specify substitution variables in the `CREATE SCRIPT` command.

When you start RMAN on the command line, the `USING` clause specifies one or more values for use in substitution variables in a command file. As in SQL*Plus, `&1` indicates where to place the first value, `&2` indicates where to place the second value, and so on.

To create and use a dynamic stored script:

1. Create a command file that contains a `CREATE SCRIPT` statement with substitution variables for values that must be dynamically updated.

The following example uses substitution variables for the name of the tape set, for a string in the `FORMAT` specification, and for the name of the restore point.

```
CREATE SCRIPT quarterly {
  ALLOCATE CHANNEL c1
    DEVICE TYPE sbt
    PARMS 'ENV=(OB_MEDIA_FAMILY=&1)';
  BACKUP
    TAG &2
    FORMAT '/disk2/bck/&1%U.bck'
    KEEP FOREVER
    RESTORE POINT &3
    DATABASE;
}
```

2. Connect RMAN to a target database (which must be mounted or open) and recovery catalog, specifying the initial values for the recovery catalog script.

For example, enter the following command:

```
% rman TARGET / CATALOG rco@catdb USING arc_backup bck0906 FY06Q3
```

A recovery catalog is required for `KEEP FOREVER`, but is not required for any other `KEEP` option.

3. Run the command file created in the first step to create the stored script.

For example, run the `/tmp/catscript.rman` command file as follows:

```
RMAN> @/tmp/catscript.rman
```

This step creates but does not execute the stored script.

4. Every quarter, execute the stored script, passing values for the substitution variables.

The following example executes the recovery catalog script named `quarterly`. The example specifies `arc_backup` as the name of the media family (set of tapes), `bck1206` as part of the `FORMAT` string and `FY06Q4` as the name of the restore point.

```
RUN
{
  EXECUTE SCRIPT quarterly
    USING arc_backup
      bck1206
      FY06Q4;
}
```

See Also:

[Making Database Backups for Long-Term Storage](#) (page 9-44)

13.7.6 Printing Stored Scripts

The `PRINT SCRIPT` command displays a stored script or writes it out to a file.

To print stored scripts:

1. Start RMAN and connect to a target database and recovery catalog.
2. Run the `PRINT SCRIPT` command as follows:

```
PRINT SCRIPT full_backup;
```

To send the contents of a script to a file, use this form of the command:

```
PRINT SCRIPT full_backup
  TO FILE '/tmp/my_script_file.txt';
```

For global scripts, the analogous syntax is as follows:

```
PRINT GLOBAL SCRIPT global_full_backup;
PRINT GLOBAL SCRIPT global_full_backup
  TO FILE '/tmp/my_script_file.txt';
```

See Also:

Oracle Database Backup and Recovery Reference for PRINT SCRIPT command syntax

13.7.7 Listing Stored Script Names

Use the LIST ... SCRIPT NAMES command to display the names of scripts defined in the recovery catalog.

LIST GLOBAL SCRIPT NAMES and LIST ALL SCRIPT NAMES are the only commands that work when RMAN is connected to a recovery catalog without connecting to a target instance; the other forms of the LIST ... SCRIPT NAMES command require a recovery catalog connection.

To list stored script names:

1. Start RMAN and connect to a target database and recovery catalog.
2. Run the LIST ... SCRIPT NAMES command.

For example, run the following command to list the names of all global and local scripts that can be executed for the currently connected target database:

```
LIST SCRIPT NAMES;
```

The following example lists *only* global script names:

```
LIST GLOBAL SCRIPT NAMES;
```

To list the names of all scripts stored in the current recovery catalog, including global scripts and local scripts for all target databases registered in the recovery catalog, use the following form of the command:

```
LIST ALL SCRIPT NAMES;
```

For each script listed, the output indicates which target database the script is defined for (or whether a script is global).

See Also:

Oracle Database Backup and Recovery Reference for LIST SCRIPT NAMES command syntax and output format

13.7.8 Deleting Stored Scripts

Use the `DELETE GLOBAL SCRIPT` command to delete a stored script from the recovery catalog.

To delete a stored script:

1. Start RMAN and connect to a target database and recovery catalog.
2. Enter the `DELETE SCRIPT` command.

If you use `DELETE SCRIPT` without `GLOBAL`, and there is no stored script for the target database with the specified name, then RMAN looks for a global stored script by the specified name and deletes the global script if it exists. For example, suppose you enter the following command:

```
DELETE SCRIPT 'global_full_backup';
```

In this case, RMAN looks for a script `global_full_backup` defined for the connected target database, and if it did not find one, it searches the global scripts for a script called `global_full_backup` and delete that script.

To delete a global stored script, use `DELETE GLOBAL SCRIPT`:

```
DELETE GLOBAL SCRIPT 'global_full_backup';
```

See Also:

Oracle Database Backup and Recovery Reference for `DELETE SCRIPT` command syntax

13.7.9 Executing a Stored Script at RMAN Startup

To run the RMAN client and start a stored script in the recovery catalog on startup, use the `SCRIPT` argument when starting the RMAN client.

For example, you could enter the following command to execute script `/tmp/fbkp.cmd`:

```
% rman TARGET / CATALOG rco@catdb SCRIPT '/tmp/fbkp.cmd';
```

You must connect to the recovery catalog, which contains the stored script, and the target database, to which the script applies, when starting the RMAN client.

If local and global stored scripts are defined with the same name, then RMAN always executes the local script.

See Also:

Oracle Database Backup and Recovery Reference for full RMAN client command line syntax

13.8 Maintaining a Recovery Catalog

Maintaining the recovery catalog consists of tasks such as resynchronizing, updating, and upgrading the recovery catalog.

This section describes various management and maintenance tasks.

13.8.1 About Recovery Catalog Maintenance

After you have created a recovery catalog and registered your target databases, you must maintain this catalog.

For example, you must run the [RMAN maintenance commands](#), which are explained in "[Maintaining RMAN Backups and Repository Records](#) (page 12-1)", to update backup records and to delete backups that are no longer needed. You must perform this type of maintenance regardless of whether you use RMAN with a recovery catalog. Other types of maintenance, such as upgrading a recovery catalog schema, are specific to use of RMAN with a recovery catalog.

If you use a recovery catalog in a Data Guard environment, then special considerations apply for backups and database files recorded in the catalog. See "[About RMAN File Management in a Data Guard Environment](#) (page 3-9)" for an explanation of when backups are accessible to RMAN and how RMAN maintenance commands work with accessible backups.

13.8.2 Resynchronizing the Recovery Catalog

When RMAN performs a resynchronization, it compares the recovery catalog to either the current or backup control file of the target database and updates the catalog with metadata that is missing or changed.

Most RMAN commands perform a resynchronization automatically when the target control file is mounted and the catalog is available. In a Data Guard environment, RMAN can perform a [reverse resynchronization](#) to update a database control file with metadata from the catalog.

13.8.2.1 About Resynchronization of the Recovery Catalog

Resynchronization of the recovery catalog ensures that the metadata that RMAN obtains from the control file stays current. Resynchronizations can be full or partial.

In a [partial resynchronization](#), RMAN reads the current control file of the target database to update changed metadata about new backups, new archived redo logs, and so on. RMAN does not resynchronize metadata about the database physical schema.

In a [full resynchronization](#), RMAN updates all changed records, including those for the database schema. RMAN performs a full resynchronization after structural changes to database (adding or dropping database files, creating new incarnation, and so on) or after changes to the RMAN persistent configuration.

RMAN creates a [snapshot control file](#), which is a temporary backup control file, when it performs a full resynchronization. The database ensures that only one RMAN session accesses a snapshot control file at any point in time. RMAN creates the snapshot control file in an operating system-specific location on the target database host. You can specify the name and location of the snapshot control file, as explained in "[Configuring the Snapshot Control File Location](#) (page 6-14)".

This snapshot control file ensures that RMAN has a consistent view of the control file. Because the control file is intended for short-term use, it is not registered in the catalog. RMAN records the control file checkpoint in the recovery catalog to indicate the currency of the catalog.

See Also:

Oracle Database Backup and Recovery Reference for more information about the RESYNC command

13.8.2.1.1 About RMAN Recovery Catalog Resynchronization in a Data Guard Environment

RMAN only automatically resynchronizes the recovery catalog with a database when connected to this database as TARGET. Thus, RMAN does not automatically resynchronize every database in a Data Guard environment when connected as TARGET to one database in the environment.

You can use the RESYNC CATALOG FROM DB_UNIQUE_NAME command to manually resynchronize the recovery catalog with a database in the Data Guard environment.

For an example of a manual resynchronization, assume that RMAN is connected as TARGET to production database prod, and that you have used CONFIGURE to create a configuration for dgprod3. If you run RESYNC CATALOG FROM DB_UNIQUE_NAME dgprod3, then RMAN resynchronizes the recovery catalog with the dgprod3 control file. In this case RMAN performs both a normal resynchronization, in which metadata flows from the dgprod3 control file to the catalog, and a [reverse resynchronization](#). In a reverse resynchronization, RMAN uses the persistent configurations in the recovery catalog to update the dgprod3 control file.

See Also:

Oracle Data Guard Concepts and Administration

13.8.2.2 Deciding When to Resynchronize the Recovery Catalog

RMAN automatically resynchronizes the recovery catalog when RMAN is connected to a target database and recovery catalog and you have executed RMAN commands.

Thus, you do not need to manually run the RESYNC CATALOG command very often. The following sections describe situations requiring a manual catalog resynchronization:

- [Resynchronizing After the Recovery Catalog is Unavailable](#) (page 13-28)
- [Resynchronizing in ARCHIVELOG Mode When You Back Up Infrequently](#) (page 13-29)
- [Resynchronizing After Configuring a Standby Database](#) (page 13-29)
- [Resynchronizing the Recovery Catalog Before Control File Records Age Out](#) (page 13-29)

13.8.2.2.1 Resynchronizing After the Recovery Catalog is Unavailable

If the recovery catalog is unavailable when you issue RMAN commands that cause a partial resynchronization, then open the catalog database later and resynchronize it manually with the RESYNC CATALOG command.

For example, the target database may be in New York while the recovery catalog database is in Japan. You may not want to make daily backups of the target database in CATALOG mode, to avoid depending on the availability of a geographically distant

database. In such a case you could connect to the catalog as often as feasible and run the `RESYNC CATALOG` command.

13.8.2.2.2 Resynchronizing in ARCHIVELOG Mode When You Back Up Infrequently

Assume that a target database runs in ARCHIVELOG mode. Also assume that you do the following:

- Back up the database infrequently (for example, hundreds of redo logs are archived between database backups)
- Generate a high number of log switches every day (for example, 1000 switches between catalog resynchronizations)

In this case, you may want to manually resynchronize the recovery catalog regularly because the recovery catalog is *not* updated automatically when a redo log switch occurs or when a redo log is archived. The database stores metadata about redo log switches and archived redo logs only in the control file. You must periodically resynchronize to propagate this information into the recovery catalog.

How frequently you must resynchronize the recovery catalog depends on the rate at which the database archives redo logs. The cost of the operation is proportional to the number of records in the control file that have been inserted or changed since the previous resynchronization. If no records have been inserted or changed, then the cost of resynchronization is very low; if many records have been inserted or changed, then the resynchronization is more time-consuming.

13.8.2.2.3 Resynchronizing After Configuring a Standby Database

You can create or change an RMAN configuration for a standby database even when not connected to this database as `TARGET`.

You perform this task with the `CONFIGURE DB_UNIQUE_NAME` or `CONFIGURE . . . FOR DB_UNIQUE_NAME` command. As explained in "[Manually Resynchronizing the Recovery Catalog](#) (page 13-30)", you can resynchronize the standby database manually to update the control file of the standby database.

13.8.2.2.4 Resynchronizing the Recovery Catalog Before Control File Records Age Out

Your goal is to ensure that the metadata in the recovery catalog is current. Because the recovery catalog obtains its metadata from the target control file, the currency of the data in the catalog depends on the currency of the data in the control file. You must make sure that the backup metadata in the control file is recorded in the catalog before it is overwritten with new records.

The `CONTROL_FILE_RECORD_KEEP_TIME` initialization parameter determines the minimum number of days that records are retained in the control file before they are candidates for being overwritten. Thus, you must ensure that you resynchronize the recovery catalog with the control file records before these records are erased.

Perform either of the following actions at intervals less than the `CONTROL_FILE_RECORD_KEEP_TIME` setting:

- Make a backup, thereby performing an implicit resynchronization of the recovery catalog
- Manually resynchronize the recovery catalog with the `RESYNC CATALOG` command

Make sure that `CONTROL_FILE_RECORD_KEEP_TIME` is longer than the interval between backups or resynchronizations. Otherwise, control file records could be

reused before they are propagated to the recovery catalog. An extra week is a safe margin in most circumstances.

Caution:

Never set `CONTROL_FILE_RECORD_KEEP_TIME` to 0. If you do, then backup records may be overwritten in the control file before RMAN can add them to the catalog.

One problem can arise if the control file becomes too large. The size of the target database control file grows depending on the number of:

- Backups that you perform
- Archived redo logs that the database generates
- Days that this information is stored in the control file

If the control file grows so large that it can no longer expand because it has reached either the maximum number of blocks or the maximum number of records, then the database may overwrite the oldest records even if their age is less than the `CONTROL_FILE_RECORD_KEEP_TIME` setting. In this case, the database writes a message to the alert log. If you discover that this situation occurs frequently, then reducing the value of `CONTROL_FILE_RECORD_KEEP_TIME` and increase the frequency of resynchronizations.

See Also:

- *Oracle Database Reference* for more information about the `CONTROL_FILE_RECORD_KEEP_TIME` parameter
 - *Oracle Database Administrator's Guide* for more detailed information on other aspects of control file management
 - [Preventing the Loss of Control File Records](#) (page 12-5) to learn how to monitor the overwriting of control file records
-

13.8.2.3 Manually Resynchronizing the Recovery Catalog

Use `RESYNC CATALOG` to force a full resynchronization of the recovery catalog with a target database control file.

You can specify a database unique name with `RESYNC CATALOG FROM DB_UNIQUE_NAME` or `ALL`, depending on whether you want to resynchronize a specific database or all databases in the Data Guard environment. To use `DB_UNIQUE_NAME ALL`, you must connect to the target database using password file authentication and as the `SYS` user. Typically, you perform this operation after you run the `CONFIGURE` command for a standby database, but have not yet connected to this standby database.

1. Start RMAN and connect to a target database and recovery catalog.
2. Mount or open the target database:

```
STARTUP MOUNT;
```

3. Resynchronize the recovery catalog.

Run the `RESYNC CATALOG` command at the RMAN prompt as follows:

```
RESYNC CATALOG;
```

The following example resynchronizes the control file of `standby1`:

```
RESYNC CATALOG FROM DB_UNIQUE_NAME standby1;
```

The following variation, when connected to the target database as the `SYS` user and using password file authentication, resynchronizes the control files for all databases in the Data Guard environment:

```
RESYNC CATALOG FROM DB_UNIQUE_NAME ALL;
```

See Also:

- *Oracle Database Backup and Recovery Reference* for `RESYNC CATALOG` command syntax
 - *Oracle Data Guard Concepts and Administration* to learn how to configure the RMAN environment for use with a standby database
-

13.8.3 Updating the Recovery Catalog After Changing a `DB_UNIQUE_NAME`

You may decide to change the `DB_UNIQUE_NAME` of a database in a Data Guard environment. In this case, you can run the `CHANGE DB_UNIQUE_NAME` command to associate the metadata stored in recovery catalog for the old `DB_UNIQUE_NAME` to the new `DB_UNIQUE_NAME`.

The `CHANGE DB_UNIQUE_NAME` command does not actually change the `DB_UNIQUE_NAME` of the database itself. Instead, it updates the catalog metadata for the database whose unique name has been or will be changed.

The following procedure assumes that the `DB_UNIQUE_NAME` of the primary database is `prodny`, and that you have changed the `DB_UNIQUE_NAME` of a standby database from `prodsf1` to `prodsf2`. You can use the same procedure after changing the `DB_UNIQUE_NAME` of a *primary* database, except in Step 1 (page 13-31) connect RMAN as `TARGET` to a standby database instead of a primary database.

To update the recovery catalog after `DB_UNIQUE_NAME` is changed:

1. Connect RMAN to the *primary* database as `TARGET` and also to the recovery catalog. For example, enter the following commands:

```
% rman
RMAN> CONNECT CATALOG rco@catdb

recovery catalog database Password: password
connected to recovery catalog database

RMAN> CONNECT TARGET sbu@prodny

target database Password: password
connected to target database: PRODNY (DBID=39525561)
```

2. List the `DB_UNIQUE_NAME` values known to the recovery catalog.

Run the following `LIST` command:

```
RMAN> LIST DB_UNIQUE_NAME OF DATABASE;
```

3. Change the `DB_UNIQUE_NAME` in the RMAN metadata.

The following example changes the database unique name from standby database `prodsf1` to `prodsf2`:

```
RMAN> CHANGE DB_UNIQUE_NAME FROM prodsf1 TO prodsf2;
```

13.8.4 Unregistering a Target Database from the Recovery Catalog

You can use the `UNREGISTER DATABASE` command to unregister a database from the recovery catalog.

When a database is unregistered from the recovery catalog, all RMAN repository records in the recovery catalog are lost. The database can be registered again, but the recovery catalog records for that database are then based on the contents of the control file at the time of reregistration. Records older than the `CONTROLFILE_RECORD_KEEP_TIME` setting in the target database control file are lost. Stored scripts, which are not stored in the control file, are also lost.

13.8.4.1 Unregistering a Target Database When Not in a Data Guard Environment

Use the `UNREGISTER DATABASE` command to unregister a target database.

This scenario assumes that you are not using the recovery catalog to store metadata for primary and standby databases.

To unregister a database:

1. Start RMAN and connect as `TARGET` to the database to unregister. Also connect to the recovery catalog.

It is not necessary to connect to the target database, but if you do not, then you must specify the name of the target database in the `UNREGISTER` command. If multiple databases have the same name in the recovery catalog, then you must create a `RUN` block around the command and use `SET DBID` to set the `DBID` for the database.

2. Make a note of the `DBID` as displayed by RMAN at startup.

For example, RMAN outputs a line of the following form when it connects to a target database that is open:

```
connected to target database: PROD (DBID=39525561)
```

3. As a precaution, it may be useful to list all of the backups recorded in the recovery catalog using `LIST BACKUP SUMMARY` and `LIST COPY SUMMARY`. This way, you can recatalog backups not known to the control file if you later decide to reregister the database.
4. If your intention is to actually delete all backups of the database completely, then run `DELETE` statements to delete all existing backups. Do not delete all backups if your intention is only to remove the database from the recovery catalog and rely on the control file to store the RMAN metadata for this database.

The following commands illustrate how to delete backups:

```
DELETE BACKUP DEVICE TYPE sbt;
DELETE BACKUP DEVICE TYPE DISK;
DELETE COPY;
```

RMAN lists the backups that it intends to delete and prompts for confirmation before deleting them.

5. Run the UNREGISTER DATABASE command. For example:

```
UNREGISTER DATABASE;
```

RMAN displays the database name and DBID, and prompts you for a confirmation:

```
database name is "RDBMS" and DBID is 931696259
```

```
Do you really want to unregister the database (enter YES or NO)? yes
```

When the process is complete, RMAN outputs the following message:

```
database unregistered from the recovery catalog
```

13.8.4.2 Unregistering a Standby Database

The UNREGISTER command supports a DB_UNIQUE_NAME clause for use in a Data Guard environment. You can use this clause to remove metadata for a specific database.

The recovery catalog associates a backup with a particular database. When you unregister a database, RMAN updates the database name for these backup files to null. Thus, the backups are still recorded but have no owner. You can execute the CHANGE ... RESET DB_UNIQUE_NAME command to associate ownership of the currently ownerless backups to a different database. If you specify INCLUDING BACKUPS on the UNREGISTER command, then RMAN removes the backup metadata for the unregistered database as well.

In this scenario, assume that primary database lnx3 has associated standby database standby1. You want to unregister the standby database.

To unregister a standby database:

1. Start RMAN and connect as TARGET to the *primary* database. Also, connect RMAN to a recovery catalog.

For example, enter the following commands:

```
% rman
RMAN> CONNECT TARGET "sbu@lnx3 AS SYSBACKUP";

target database Password: password
connected to target database: LNX3 (DBID=781317675)

RMAN> CONNECT CATALOG rco@catdb;
```

2. List the database unique names.

For example, execute the LIST DB_UNIQUE_NAME command as follows:

```
RMAN> LIST DB_UNIQUE_NAME OF DATABASE;
```

List of Databases

DB Key	DB Name	DB ID	Database Role	Db_unique_name
--------	---------	-------	---------------	----------------

```

-----
1      LNX3      781317675      STANDBY      STANDBY1
1      LNX3      781317675      PRIMARY      LNX3

```

3. Run the `UNREGISTER DB_UNIQUE_NAME` command.

For example, execute the `UNREGISTER` command as follows to unregister database `standby`:

```

RMAN> UNREGISTER DB_UNIQUE_NAME standby1;

```

RMAN displays the database name and DBID, and prompts you for a confirmation:

```

database db_unique_name is "standby1", db_name is "LNX3" and DBID is 781317675

```

```

Do you really want to unregister the database (enter YES or NO)? yes

```

When the process is complete, RMAN outputs the following message:

```

database with db_unique_name standby1 unregistered from the recovery catalog

```

13.8.4.3 Unregistering a Target Database in a Recovery Appliance Environment

In a Zero Data Loss Recovery Appliance (Recovery Appliance) environment, the `UNREGISTER DATABASE` command cannot be used to unregister a protected database from the Recovery Appliance catalog. Instead, use the `DBMS_RA.DELETE_DB` procedure.

To unregister a target database from the Recovery Appliance recovery catalog:

1. Obtain the `DB_NAME` of the protected database that you want to unregister.
2. (Optional) To delete all the backups associated with this protected database, perform the following steps:
 - Connect to the protected database as a user with the `SYSDBA` or `SYSBACKUP` privilege.
 - Use the following commands to delete all backups:

```

DELETE BACKUP DEVICE TYPE sbt;
DELETE BACKUP DEVICE TYPE DISK;
DELETE COPY;

```

RMAN lists the backups that it intends to delete and prompts for confirmation before deleting them.

3. Start `SQL*Plus` and connect to the Recovery Appliance metadata database as `RASYS` (Recovery Appliance catalog owner).
4. Unregister the protected database from Recovery Appliance using the `DBMS_RA.DELETE_DB` procedure.

```

begin
    DBMS_RA.DELETE_DB('TEST_DB');
end;
/

```

RMAN prompts you to confirm the unregister database operation.

See Also:

Zero Data Loss Recovery Appliance Administrator's Guide for details of the `DBMS_RA.DELETE_DB` procedure

13.8.5 Resetting the Database Incarnation in the Recovery Catalog

You create an incarnation of the database when you open the database with the `RESETLOGS` option. You can access a record of the new incarnation in the `V$DATABASE_INCARNATION` view.

If you open the database with the `RESETLOGS` option, then a new database incarnation record is automatically created in the recovery catalog. The database also implicitly and automatically issues a `RESET DATABASE` command, which specifies that this new incarnation of the database is the current incarnation. All subsequent backups and log archiving done by the target database is associated with the new database incarnation.

Whenever RMAN returns the database to an SCN before the current `RESETLOGS` SCN, either with `RESTORE` and `RECOVER` or `FLASHBACK DATABASE`, the `RESET DATABASE TO INCARNATION` command is required. However, you do not need to execute `RESET DATABASE TO INCARNATION` explicitly in the following scenarios because RMAN runs the command implicitly with Flashback.

- You use `FLASHBACK DATABASE` to rewind the database to an SCN in the [direct ancestral path](#).
- You use `FLASHBACK DATABASE` to rewind the database to a [restore point](#).

The following procedure explains how to reset the database incarnation when recovering through a `RESETLOGS`.

To reset the recovery catalog to an older incarnation for media recovery:

1. Determine the incarnation key of the desired database incarnation. Obtain the incarnation key value by issuing a `LIST` command:

```
LIST INCARNATION OF DATABASE trgt;
```

```
List of Database Incarnations
```

DB Key	Inc Key	DB Name	DB ID	STATUS	Reset SCN	Reset Time
1	2	TRGT	1224038686	PARENT	1	02-JUL-12
1	582	TRGT	1224038686	CURRENT	59727	10-JUL-12

The incarnation key is listed in the `Inc Key` column.

2. Reset the database to the old incarnation. For example, enter:

```
RESET DATABASE TO INCARNATION 2;
```

3. If the control file of the previous incarnation is available and mounted, then skip to Step 6 of this procedure. Otherwise, shut down the database and start it without mounting. For example:

```
SHUTDOWN IMMEDIATE
STARTUP NOMOUNT
```

- Restore a control file from the old incarnation. If you have a control file tagged, then specify the tag. Otherwise, you can run the `SET UNTIL` command, as in this example:

```
RUN
{
  SET UNTIL 'SYSDATE-45';
  RESTORE CONTROLFILE; # only if current control file is not available
}
```

- Mount the restored control file:

```
ALTER DATABASE MOUNT;
```

- Run `RESTORE` and `RECOVER` commands to restore and recover the database files from the prior incarnation, then open the database with the `RESETLOGS` option. For example, enter:

```
RESTORE DATABASE;
RECOVER DATABASE;
ALTER DATABASE OPEN RESETLOGS;
```

See Also:

- [About Database Incarnations](#) (page 14-7)
 - Oracle Database Backup and Recovery Reference* for `RESET DATABASE` syntax
 - Oracle Database Backup and Recovery Reference* for `LIST` syntax
-
-

13.8.6 Upgrading the Recovery Catalog

This section explains what a recovery catalog upgrade is and when you must do it.

13.8.6.1 About Recovery Catalog Upgrades

If you are upgrading to Oracle Database 12c Release 1 (12.1.0.2), then the recovery catalog database must use the Enterprise Edition of Oracle Database.

If you use a version of the recovery catalog schema that is older than that required by the RMAN client, then you must upgrade it. The compatibility matrix in *Oracle Database Backup and Recovery Reference* explains which schema versions are compatible with which versions of RMAN. For example, you must upgrade the catalog if you use an Oracle Database 11g RMAN client with a release 10.2 version of the recovery catalog schema.

The Oracle Database 10g Release 1 version of the recovery catalog schema requires the `CREATE TYPE` privilege. If you created the recovery catalog owner in a release before 10gR1, and if you granted the `RECOVERY_CATALOG_OWNER` role when it did not include the `CREATE TYPE` privilege, then you must grant `CREATE TYPE` to this user explicitly before upgrading the catalog.

You receive an error when issuing `UPGRADE CATALOG` if the recovery catalog is at a version greater than that required by the RMAN client. RMAN permits the `UPGRADE CATALOG` command to be run if the recovery catalog is current and does not require upgrading, however, so that you can re-create packages at any time if necessary. Check the message log for error messages generated during the upgrade.

13.8.6.1.1 Special Considerations for Upgrading the Recovery Catalog in a Data Guard Environment

Assume that you upgrade the recovery catalog schema to Oracle Database 11g in a Data Guard environment. When RMAN connects to a standby database, it automatically registers the new database information and resynchronizes to obtain the file names from the control file.

During the resynchronization, RMAN associates the names with the target database name. Because the recovery catalog contains historical metadata, some records in the catalog are not known to the control file. For example, the `standby1` control file does not know about all backups made on `primary1`. The database unique name for these old records is `null`. As explained in "[About Recovery Catalog Maintenance](#) (page 13-27)", you can use `CROSSCHECK` to fix these records.

13.8.6.2 Determining the Schema Version of the Recovery Catalog

The schema version of the recovery catalog is stored in the recovery catalog itself. The information is important in case you maintain multiple databases of different versions in your production system, and you must determine whether the catalog schema version is usable with a specific target database version.

To determine the schema version of the recovery catalog:

1. Start SQL*Plus and connect to the recovery catalog database as the catalog owner.
2. Query the `RCVER` table to obtain the schema version, as in the following example (sample output included):

```
SELECT *
FROM   rcver;

VERSION
-----
12.01.00.01
```

If the table displays multiple rows, then the highest version in the `RCVER` table is the current catalog schema version. The table stores only the major version numbers and not the patch numbers. For example, assume that the `rcver` table displays the following rows:

```
VERSION
-----
10.02.00
11.02.00
12.01.00.01
```

These rows indicate that the catalog was created with a release 10.2.0 executable, then upgraded to release 11.2.0, and finally upgraded to release 12.1.0.1. The current version of the catalog schema is 12.1.0.1.

See Also:

Oracle Database Backup and Recovery Reference for the complete set of compatibility rules governing the RMAN environment

13.8.6.3 Using the UPGRADE CATALOG Command

This scenario assumes that you are upgrading a recovery catalog schema to the current version.

Note: Starting with Oracle Database 12c Release 1 (12.1.0.2), the recovery catalog database must use the Enterprise Edition of Oracle Database.

To upgrade the recovery catalog to Oracle Database 12c Release 1 (12.1.0.1):

1. If you created the recovery catalog owner in a release before 10gR1, and if the RECOVERY_CATALOG_OWNER role did not include the CREATE TYPE privilege, then grant it.

For example, start SQL*Plus and connect to the recovery catalog database with administrator privileges. You can then execute the following GRANT statement:

```
SQL> GRANT CREATE TYPE TO rman;
SQL> EXIT;
```

2. Start RMAN and connect RMAN to the recovery catalog database.
3. Run the UPGRADE CATALOG command:

```
RMAN> UPGRADE CATALOG;

recovery catalog owner is rman
enter UPGRADE CATALOG command again to confirm catalog upgrade
```

4. Run the UPGRADE CATALOG command again to confirm:

```
RMAN> UPGRADE CATALOG;

recovery catalog upgraded to version 12.01.00.01
DBMS_RCVMAN package upgraded to version 12.01.00.01
DBMS_RCVCAT package upgraded to version 12.01.00.01
```

Note:

To bypass this step, add the NOPROMPT option after the UPGRADE CATALOG command in step 3.

To upgrade the recovery catalog to Oracle Database 12c Release 1 (12.1.0.2) or higher:

1. Enable Oracle Partitioning for the recovery catalog database.
2. If the recovery catalog database uses the Standard Edition, then use one of the following techniques:
 - Migrate the recovery catalog database from Standard Edition to Enterprise Edition.

Note: *Oracle Database Upgrade Guide* for information about moving to the Enterprise Edition

- Move the recovery catalog into an Oracle Enterprise Edition database and then use the `IMPORT CATALOG` command to import the recovery catalog into this database.
3. Use `SQL*Plus` to connect to the recovery catalog database as the `SYS` user with the `SYSDBA` privilege.
 4. Run the `dbmsrmansys.sql` script to grant additional privileges that are required for the `RECOVERY_CATALOG_OWNER` role.

```
SQL> @$ORACLE_HOME/rdbms/admin/dbmsrmansys.sql
```

5. Exit `SQL*Plus`.
6. Start `RMAN` and connect `RMAN` to the recovery catalog database.
7. Run the `UPGRADE CATALOG` command:

```
RMAN> UPGRADE CATALOG;
```

```
recovery catalog owner is rman
enter UPGRADE CATALOG command again to confirm catalog upgrade
```

8. Run the `UPDATE CATALOG` command again to confirm:

```
RMAN> UPGRADE CATALOG;
```

```
recovery catalog upgraded to version 12.01.00.01
DBMS_RCVMAN package upgraded to version 12.01.00.01
DBMS_RCVCAT package upgraded to version 12.01.00.01
```

Note:

To bypass this step, add the `NOPROMPT` option after the `UPGRADE CATALOG` command in step 7.

See Also:

- *Oracle Database Backup and Recovery Reference* for `UPGRADE CATALOG` command syntax
 - *Oracle Database Backup and Recovery Reference* for information about recovery catalog compatibility
 - *Oracle Database Upgrade Guide* for complete compatibility and migration information
-
-

13.8.7 Importing and Moving a Recovery Catalog

You can use the `IMPORT CATALOG` command in `RMAN` to merge one recovery catalog schema into another.

This command is useful in the following situations:

- You have multiple recovery catalog schemas for different versions of the database. You want to merge all existing schemas into one without losing backup metadata.

- You want to move a recovery catalog from one database to another database.

13.8.7.1 About Recovery Catalog Imports

When using `IMPORT CATALOG`, the **source catalog schema** is the catalog schema to import into a different schema. The **destination catalog schema** is the catalog schema into which you intend to import the source catalog schema.

By default, RMAN imports metadata from all target databases registered in the source recovery catalog. Optionally, you can specify the list of database IDs to be imported from the source catalog schema.

By default, RMAN unregisters the imported databases from the source catalog schema after a successful import. To indicate whether the unregister was successful, RMAN prints messages before and after unregistering the merged databases. You can also specify the `NO UNREGISTER` option to specify that the databases is not unregistered from the source catalog.

A **stored script** is either global or local. It is possible for global scripts, but not local scripts, to have name conflicts during import because the destination schema already contains the script name. In this case, RMAN renames the global script name to `COPY OF script_name`. For example, RMAN renames `bp_cmd` to `COPY OF bp_cmd`.

If the renamed global script is still not unique, then RMAN renames it to `COPY(2) OF script_name`. If this script name also exists, then RMAN renames the script to `COPY(3) OF script_name`. RMAN continues the `COPY(n) OF` pattern until the script is uniquely named.

13.8.7.2 About Importing Recovery Catalogs in a Recovery Appliance Environment

In a Recovery Appliance environment, a single, centrally-managed Recovery Appliance catalog residing on the Recovery Appliance is shared by all the protected databases. This catalog must be used by all protected databases that send backups to Recovery Appliance.

When you move protected databases to a data protection strategy that uses Recovery Appliance, you can choose to migrate existing backups and backup metadata to Recovery Appliance. To migrate backup metadata, you must import the RMAN recovery catalog into the Recovery Appliance catalog.

See Also:

- *Zero Data Loss Recovery Appliance Administrator's Guide* for an overview of the Recovery Appliance catalog
 - *Zero Data Loss Recovery Appliance Protected Database Configuration Guide* for the steps to migrate backups and backup metadata
-
-

13.8.7.3 Prerequisites for Importing a Recovery Catalog

A target database, recovery catalog database, and recovery catalog schema can be at different database versions. The recommended practice is to import all existing recovery catalogs into a single recovery catalog at the latest version of the recovery catalog schema.

"[Determining the Schema Version of the Recovery Catalog](#) (page 13-37)" explains how to determine the catalog version. Check the compatibility matrix to determine which schema versions are compatible in your environment.

When using `IMPORT CATALOG`, the version of the source recovery catalog schema must be equal to the current version of the RMAN executable with which you run the command. If the source catalog schema is a *lower* version, then upgrade it to the current version before importing the schema. "[Upgrading the Recovery Catalog](#) (page 13-36)" explains how to upgrade. If the source recovery catalog schema is a *higher* version, then retry the import with a higher version RMAN executable.

No database can be registered in both the source and destination catalog schema. If a database is currently registered in both catalog schemas, then unregister the database from source catalog schema before performing the import.

See Also:

Oracle Database Backup and Recovery Reference

13.8.7.4 Importing a Recovery Catalog

When importing one recovery catalog into another, no connection to a target database is necessary. RMAN only needs connectivity to the source and destination catalogs.

In this example, database `srcdb` contains a 10.2 recovery catalog schema owned by user `102cat`, while database `destdb` contains an 11.1 recovery catalog schema owned by user `111cat`.

To import a recovery catalog:

1. Start RMAN and connect as `CATALOG` to the destination recovery catalog schema. For example:

```
% rman
RMAN> CONNECT CATALOG 111cat@destdb;
```

2. Import the source recovery catalog schema, specifying the connection string for the source catalog.

For example, enter the following command to import the catalog owned by `102cat` on database `srcdb`:

```
IMPORT CATALOG 102cat@srcdb;
```

A variation is to import metadata for a subset of the target databases registered in the source catalog. You can specify the databases by `DBID` or database name, as shown in the following examples:

```
IMPORT CATALOG 102cat@srcdb DBID=1423241, 1423242;
IMPORT CATALOG 102cat@srcdb DB_NAME=prod3, prod4;
```

3. Optionally, connect to a target database to check that the metadata was successfully imported. For example, the following commands connect to database `prod1` as `TARGET` and list all backups for this database:

```
CONNECT TARGET "sbu@prod1 AS SYSBACKUP";
LIST BACKUP;
```

`sbu` is a user who is granted the `SYSBACKUP` privilege in the target database.

13.8.7.5 Moving a Recovery Catalog

The procedure for moving a recovery catalog from one database to another is a variation of the procedure for importing a catalog.

In this scenario, the source database is the database containing the existing recovery catalog, while the destination database contains the moved recovery catalog.

To move a recovery catalog from the source database to the destination database:

1. Create a recovery catalog on the destination database, but do not register any databases in the new catalog.

"[Creating a Recovery Catalog](#) (page 13-5)" explains how to perform this task.

2. Import the source catalog into the catalog created in the preceding step.

"[Importing a Recovery Catalog](#) (page 13-41)" explains how to perform this task.

13.9 Dropping a Recovery Catalog

The `DROP CATALOG` command removes those objects that were created by the `CREATE CATALOG` command. If the user who owns the recovery catalog also owns objects that were *not* created by `CREATE CATALOG`, then the `DROP CATALOG` command does not remove these objects.

If you drop a recovery catalog, and if you have no backups of the recovery catalog schema, then backups of all target databases registered in this catalog may become unusable. However, the control file of every target database still retains a record of recent backups of this database.

The `DROP CATALOG` command is not appropriate for unregistering a single database from a recovery catalog that has multiple target databases registered. Dropping the recovery catalog deletes the recovery catalog record of backups for all target databases registered in the catalog.

To drop a recovery catalog schema:

1. Start RMAN and connect to a target database and recovery catalog. Connect to the recovery catalog as the owner of the catalog schema to be dropped.

The following example connects to a recovery catalog as user `rco`:

```
% rman TARGET / CATALOG rco@catdb
```

2. Run the `DROP CATALOG` command:

```
DROP CATALOG;
```

```
recovery catalog owner is rco
```

```
enter DROP CATALOG command again to confirm catalog removal
```

Note:

To bypass the next confirmation step, add the `NOPROMPT` option with the `DROP CATALOG` command in this step.

3. Run the `DROP CATALOG` command again to confirm:

```
DROP CATALOG;
```

Note:

Even after you drop the recovery catalog, the control file still contains records about the backups. To purge RMAN repository records from the control file, re-create the control file.

See Also:

- *Oracle Database Backup and Recovery Reference* for DROP CATALOG command syntax
 - [Unregistering a Target Database from the Recovery Catalog](#) (page 13-32) to learn how to unregister a database from the catalog
-
-

Part V

Diagnosing and Responding to Failures

The following chapters describe how to diagnose and respond to media failures and data corruptions. This part of the book contains the following chapters:

- [RMAN Data Repair Concepts](#) (page 14-1)
- [Diagnosing and Repairing Failures with Data Recovery Advisor](#) (page 15-1)
- [Validating Database Files and Backups](#) (page 16-1)
- [Performing Complete Database Recovery](#) (page 17-1)
- [Performing Flashback and Database Point-in-Time Recovery](#) (page 18-1)
- [Performing Block Media Recovery](#) (page 19-1)
- [Performing RMAN Recovery: Advanced Scenarios](#) (page 20-1)
- [Performing RMAN Tablespace Point-in-Time Recovery \(TSPITR\)](#) (page 21-1)
- [Recovering Tables and Table Partitions from RMAN Backups](#) (page 22-1)

RMAN Data Repair Concepts

This chapter describes the general concepts that you must understand to perform [data repair](#). This chapter contains the following topics:

- [Overview of RMAN Data Repair](#) (page 14-1)
- [About RMAN Restore Operations](#) (page 14-3)
- [About RMAN Media Recovery](#) (page 14-6)

14.1 Overview of RMAN Data Repair

As explained in "[About Data Protection](#) (page 1-2)", a principal purpose of a backup and recovery strategy is data protection. The key to an effective, efficient strategy is to understand the basic options of data repair.

14.1.1 About Problems Requiring Data Repair

While several problems can halt the normal operation of an Oracle database or affect database I/O operations, only the following typically require DBA intervention and data repair: user errors, application errors, and media failures.

14.1.1.1 About User Errors

User errors occur when, either due to an error in application logic or a manual mistake, data in your database is changed or deleted incorrectly.

For example, a user logs in to the wrong database and drops a database table. User errors are estimated to be the greatest single cause of database downtime.

14.1.1.2 About Application Errors

Sometimes a software malfunction can corrupt data blocks. In a physical corruption, which is also called a media corruption, the database does not recognize the block.

14.1.1.3 About Media Failures

A media failure occurs when a problem external to the database prevents it from reading from or writing to a file during normal operations.

Typical media failures include disk failures and the deletion of database files. Media failures are less common than user or application errors, but your backup and recovery strategy should prepare for them.

14.1.2 About RMAN Data Repair Techniques

RMAN provides multiple methods of data repair.

Depending on the situations you anticipate, consider incorporating each of the options described in the following table into your strategy for responding to data loss, and then set up your database to make these options possible.

Table 14-1 RMAN Data Repair Techniques

Data Repair Technique	Description	Additional Information
Data Recovery Advisor	This Oracle Database infrastructure can diagnose failures, advise you on how to respond to them, and repair the failures automatically.	"Overview of Data Recovery Advisor (page 15-1)"
logical flashback features	This subset of Oracle Flashback Technology features enables you to view or rewind individual database objects or transactions to a past time. These features do not require use of RMAN.	"Overview of Oracle Flashback Technology and Database Point-in-Time Recovery (page 18-1)"
Oracle Flashback Database	Flashback Database is a block-level recovery mechanism that is similar to media recovery, but is generally faster and does not require a backup to be restored. You can return your whole database to a previous state without restoring old copies of your data files from backup, if you have enabled flashback logging in advance. You must have a fast recovery area configured for logging for flashback database or guaranteed restore points.	"Basic Concepts of Point-in-Time Recovery and Flashback Features (page 18-1)"
data file media recovery	This form of media recovery enables you to restore data file backups and apply archived redo logs or incremental backups to recover lost changes. You can either recover a whole database or a subset of the database. Data file media recovery is the most general-purpose form of recovery and can protect against both physical and logical failures.	<ul style="list-style-type: none"> • "Performing Complete Database Recovery (page 17-1)" • "Performing Database Point-in-Time Recovery (page 18-25)"

Table 14-1 (Cont.) RMAN Data Repair Techniques

Data Repair Technique	Description	Additional Information
block media recovery	This form of media recovery enables you to recover individual blocks within a data file rather than the whole data file.	" Overview of Block Media Recovery (page 19-1)"
tablespace point-in-time recovery (TSPITR)	This is a specialized form of point-in-time recovery in which you recover one or more tablespaces to a time earlier than the rest of the database.	" Overview of RMAN TSPITR (page 21-1)"

In general, the concepts required to use the preceding repair techniques are explained along with the techniques. This chapter explains concepts that are common to several RMAN data repair solutions.

14.2 About RMAN Restore Operations

In an RMAN restore operation, you select files to be restored and then run the RESTORE command. Typically, you restore files in preparation for media recovery.

You can restore the following types of files:

- Database (all data files)
- Tablespaces
- Control files
- Archived redo logs
- Server parameter files

You can specify either the default location or a new location for restored data files and control files. If you restore to the default location, then RMAN overwrites any files with the same name that currently exist in this location. Alternatively, you can use the SET NEWNAME command to specify new locations for restored data files. You can then run a SWITCH command to update the control file to indicate that the restored files in their new locations are now the current data files.

See Also:

- *Oracle Database Backup and Recovery Reference* for RESTORE syntax and prerequisites
 - *Oracle Database Backup and Recovery Reference* for SET NEWNAME syntax
 - *Oracle Database Backup and Recovery Reference* for SWITCH syntax
-
-

14.2.1 About RMAN Backup Selection

RMAN uses the records of available backup sets or image copies in the RMAN repository to select the best available backups for use in the restore operation.

The most recent backup available, or the most recent backup satisfying any `UNTIL` clause specified in the `RESTORE` command, is the preferred choice. If two backups are from the same point in time, then RMAN prefers image copies over backup sets because RMAN can restore more quickly from image copies than from backup sets (especially those stored on tape).

All specifications of the `RESTORE` command must be satisfied before RMAN restores a backup. Unless limited by the `DEVICE TYPE` clause, the `RESTORE` command searches for backups on all device types of configured channels. If no available backup in the repository satisfies all the specified criteria, then RMAN returns an error indicating that the file cannot be restored.

If you use only manually allocated channels, then a backup job may fail if there is no usable backup on the media for which you allocated channels. Configuring automatic channels makes it more likely that RMAN can find and restore a backup that satisfies the specified criteria.

See Also:

["Configuring Advanced Channel Options \(page 6-1\)"](#)

14.2.2 About RMAN Restore Failover

RMAN automatically uses restore failover to skip corrupted or inaccessible backups and look for usable backups. When a backup is not found, or contains corrupt data, RMAN automatically looks for another backup from which to restore the desired files.

RMAN generates messages that indicate the type of failover that it is performing. For example, when RMAN fails over to another backup of the same file, it generates a message similar to the following:

```
failover to piece handle=/u01/backup/db_1 tag=BACKUP_031009
```

If no usable copies are available, then RMAN searches for previous backups. The message generated is similar to the following example:

```
ORA-19624: operation failed, retry possible  
ORA-19505: failed to identify file "/u01/backup/db_1"  
ORA-27037: unable to obtain file status  
SVR4 Error: 2: No such file or directory  
Additional information: 3  
failover to previous backup
```

RMAN performs restore failover repeatedly until it has exhausted all possible backups. If all of the backups are unusable or no backups exists, then RMAN attempts to re-create the data file. Restore failover is also used when there are errors restoring archived redo logs during `RECOVER`, `RECOVER . . . BLOCK`, and `FLASHBACK DATABASE` commands.

14.2.3 About RMAN Restore of Encrypted Backups

RMAN automatically decrypts backup sets that are protected with backup encryption when their contents are restored. Additional steps, if any, depend on the technique that was used to encrypt the backups.

- Transparent backup encryption using an auto-login software keystore requires no intervention if the Oracle keystore is available.

When restoring a backup on a host that is different from the source host on which the backup is created, manually copy the Oracle keystore from the source database to the destination host.

- Transparent backup encryption using a password-based keystore requires the keystore to be open.

Manually copy the Oracle software keystore to the destination host on which the backup is being restored and provide the password required to open the keystore. The `SET DECRYPTION WALLET OPEN IDENTIFIED BY` command to provide the password.

- Password-encrypted backups require the correct password to be entered before they can be restored.

Use the `SET DECRYPTION IDENTIFIED BY` command to specify the password that must be used to decrypt the encrypted backup.

- Dual-mode encrypted backups can be restored either transparently, by using the Oracle software keystore, or by specifying a password for decryption.

TDE Master Keys and Transparently Encrypted Backups

When you reset (or rotate, rekey) a TDE master encryption key, RMAN can still restore backups that were encrypted using the old TDE master encryption key. This is possible because the Oracle keystore stores a history of all retired TDE master encryption keys.

Note: If the Oracle keystore that contains the TDE master key is lost and needs to be recreated, then any backups that were encrypted using the old TDE master keys are invalidated and cannot be used.

See Also: *Oracle Database Advanced Security Guide*

14.2.4 About RMAN Restore Operations and ASM

When Automatic Storage Management (ASM) disk groups are used, an RMAN restore operation creates new copies of data files only if the full name of a data file, including the incarnation, does not match with the name of an existing data file.

A fully qualified ASM file name is of the form `+diskgroup/dbname/filetype/filetypetag.file.incarnation`. When you first restore the control file and then restore the other database files, the names of the data files in the control file may not match with the names of the existing data files and therefore the data files are recreated.

Use one of the following methods to ensure that existing data files are not recreated during a restore or duplicate operation:

- In the control file, use alias names for each data file. The alias must not include the ASM incarnation number.
- After restoring the control file and before restoring the other database files, use the `CATALOG` command to ensure that the existing data files are cataloged in the restored control file. Next, use the `SWITCH` command to make the restored control file point to the existing data files.
- Use `SET NEWNAME` to rename the data files before restoring the data files and after restoring the control file.

14.2.5 About RMAN Restore Optimization

RMAN uses restore optimization to avoid restoring data files from backup when possible. If a data file is present in the correct location and its header contains the expected information, then RMAN does not restore the data file from backup.

Note:

Restore optimization only checks the data file header. It does not scan the data file body for corrupted blocks.

You can use the `FORCE` option of the `RESTORE` command to override this behavior and restore the requested files unconditionally.

Restore optimization is particularly useful when an operation that restores several data files is interrupted. For example, assume that a full database restore encounters a power failure after all except one data file has been restored. If you run the same `RESTORE` command again, then RMAN only restores the single data file that was not restored during the previous attempt.

Restore optimization is also used when duplicating a database. If a data file at the duplicate is in the correct place with the correct header contents, then the data file is not duplicated. Unlike `RESTORE`, `DUPLICATE` does not support a `FORCE` option. To force RMAN to duplicate a data file that is skipped due to restore optimization, delete the data file from the duplicate before running the `DUPLICATE` command.

See Also:

Oracle Real Application Clusters Administration and Deployment Guide for description of `RESTORE` behavior in an Oracle RAC configuration

14.3 About RMAN Media Recovery

In media recovery, RMAN applies changes to restored data to roll forward this data in time.

RMAN can perform either [data file media recovery](#) or [block media recovery](#).

Data file media recovery is the application of redo logs or incremental backups to a restored data file to update it to the current time or some other specified time. As explained in *Oracle Database Concepts*, you can use RMAN to perform [complete recovery](#), [database point-in-time recovery \(DBPITR\)](#), or [tablespace point-in-time](#)

[recovery \(TSPITR\)](#). You can use the `RESTORE` command to restore backups of lost and damaged data files or control files and the `RECOVER` command to perform media recovery.

Block media recovery is the recovery of individual data blocks rather than entire data files. This section explains data file media recovery only. Block media recovery, which is a specialized form of media recovery, is explained in "[Overview of Block Media Recovery](#) (page 19-1)".

14.3.1 About Selection of Incremental Backups and Archived Redo Logs

RMAN automates media recovery. RMAN automatically restores and applies both incremental backups and archived redo logs in whatever combination is most efficient.

If the RMAN repository indicates that no copies of a required log sequence number exist on disk, then it automatically restores the required log from backup. By default, RMAN restores the archived logs to the fast recovery area, if an archiving destinations is set to `USE_DB_RECOVERY_FILE_DEST`. Otherwise, RMAN restores the logs to the first local archiving destination specified in the initialization parameter file.

See Also:

Oracle Database Backup and Recovery Reference for `CROSSCHECK` syntax

14.3.2 About Database Incarnations

A database incarnation is created whenever you open the database with the `RESETLOGS` option.

After complete recovery, you can resume normal operations without an `OPEN RESETLOGS`. After a `DBPITR` or recovery with a backup control file, however, you must open the database with the `RESETLOGS` option, thereby creating a new incarnation of the database. The database requires a new incarnation to avoid confusion when two different redo streams have the same SCNs, but occurred at different times. If you apply the wrong redo to your database, then you corrupt it.

The existence of multiple incarnations of a single database determines how RMAN treats backups that are not in the current incarnation path. Usually, the current database incarnation is the correct one to use. Nevertheless, in some cases resetting the database to a previous incarnation is the best approach. For example, you may be dissatisfied with the results of a point-in-time recovery that you have performed and want to return the database to a time before the `RESETLOGS`. An understanding of database incarnations is helpful to prepare for such situations.

14.3.2.1 About RMAN OPEN RESETLOGS Operations

RMAN performs certain actions when you open the database with the `RESETLOGS` option.

The action performed are as follows:

- Archives the current online redo logs (if they are accessible) and then erases the contents of the online redo logs and resets the log sequence number to 1.

For example, if the current online redo logs are sequence 1000 and 1001 when you open `RESETLOGS`, then the database archives logs 1000 and 1001 and then resets the online redo logs to sequence 1 and 2.

- Creates the online redo log files if they do not currently exist.
- Initializes redo thread records and online redo log records in the control file to the beginning of the new database incarnation.

More specifically, the database sets the redo thread status to closed, sets the current thread sequence in the redo thread records to 1, sets the thread checkpoint of each redo thread to the beginning of log sequence 1, chooses one redo log from each thread and initialize its sequence to 1, and so on.

- Updates all current data files and online redo logs and all subsequent archived redo logs with a new `RESETLOGS SCN` and time stamp.

Because the database does not apply an archived redo log to a data file unless the `RESETLOGS SCN` and time stamps match, the `RESETLOGS` requirement prevents you from corrupting data files with archived logs that are not from direct parent incarnations of the current incarnation. The relationship among incarnations is explained more fully in the following section.

In previous releases, it was recommended that you back up the database immediately after the `OPEN RESETLOGS`. Because you can now easily recover a pre-`RESETLOGS` backup like any other backup, making a new database backup is optional. To perform recovery through `RESETLOGS` you must have all archived logs generated after the most recent backup and at least one control file (current, backup, or created).

14.3.2.2 Relationship Among Database Incarnations

Database incarnations can stand in the following relationships to each other:

- The **current incarnation** is the one in which the database is currently operating.
- The incarnation from which the current incarnation branched following an `OPEN RESETLOGS` operation is the **parent incarnation** of the current incarnation.
- The parent of the parent incarnation is an **ancestor incarnation**. Any parent of an ancestor incarnation is also an ancestor of the current incarnation.
- The **direct ancestral path** of the current incarnation begins with the earliest incarnation and includes only the branches to an ancestor of the current incarnation, the parent incarnation, or the current incarnation.

An incarnation number is used to uniquely tag and identify a stream of redo. [Figure 14-1](#) (page 14-9) illustrates a database that goes through several incarnations, each with a different incarnation number.

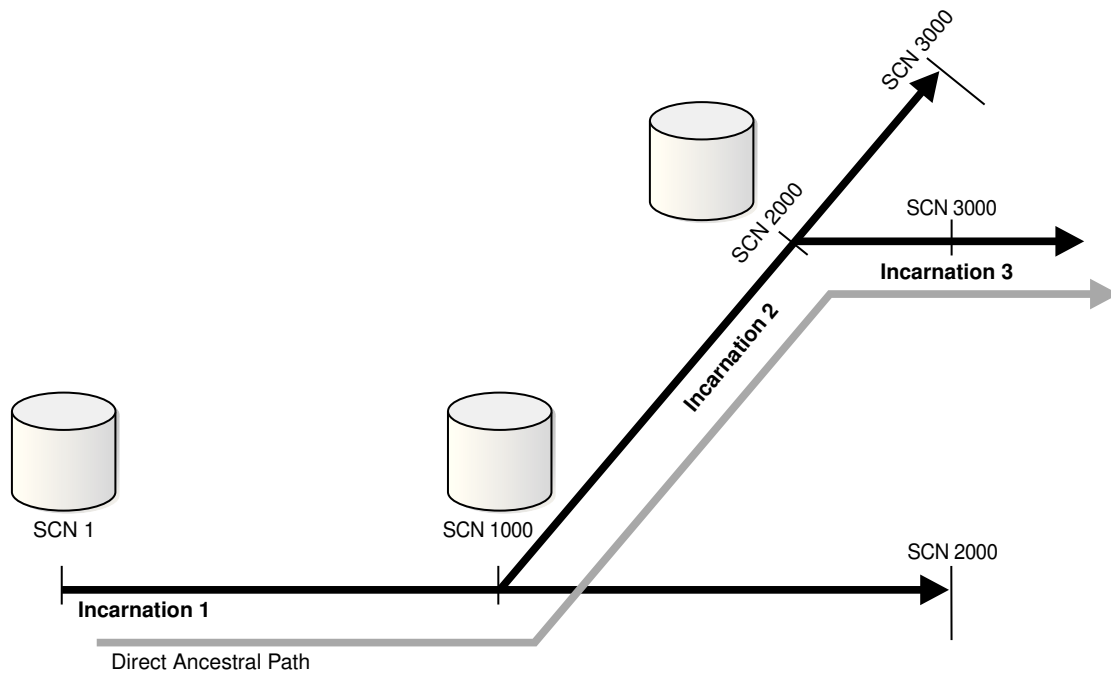
Figure 14-1 Database Incarnation History

Incarnation 1 of the database starts at SCN 1 and continues through SCN 1000 to SCN 2000. Suppose that at SCN 2000 in incarnation 1, you perform a point-in-time recovery back to SCN 1000, and then open the database with the `RESETLOGS` option. Incarnation 2 now begins at SCN 1000 and continues to SCN 3000. In this example, incarnation 1 is the parent of incarnation 2.

Suppose that at SCN 3000 in incarnation 2, you perform a point-in-time recovery to SCN 2000 and open the database with the `RESETLOGS` option. In this case, incarnation 2 is the parent of incarnation 3. Incarnation 1 is an ancestor of incarnation 3.

When DBPITR or Flashback Database has occurred in database, an SCN can refer to multiple points in time, depending on which incarnation is current. For example, SCN 1500 in [Figure 14-1](#) (page 14-9) could refer to an SCN in incarnation 1 or 2.

You can use the `RESET DATABASE TO INCARNATION` command to specify that SCNs are to be interpreted in the frame of reference of a specific database incarnation. The `RESET DATABASE TO INCARNATION` command is required when you use `FLASHBACK`, `RESTORE`, or `RECOVER` to return to an SCN in a noncurrent database incarnation. However, RMAN executes the `RESET DATABASE TO INCARNATION` command implicitly with Flashback, as explained in ["Resetting the Database Incarnation in the Recovery Catalog](#) (page 13-35)".

See Also:

- ["Recovering the Database to an Ancestor Incarnation](#) (page 18-38)"
 - *Oracle Database Backup and Recovery Reference* for details about the `RESET DATABASE` command
-
-

14.3.2.3 About Incarnations of PDBs

A pluggable database (PDB) incarnation is a subincarnation of the multitenant container database (CDB) and is expressed as *(database_incarnation, pdb_incarnation)*.

For example, if the CDB is incarnation 5, and a PDB is incarnation 3, then the fully specified incarnation number of the PDB is (5, 3). The initial incarnation of a PDB is 0. Subsequent incarnations are unique but not always sequential numbers.

The `V$PDB_INCARNATION` view contains information about all PDB incarnations. Use the following query to display the current incarnation of a PDB:

```
SELECT PDB_INCARNATION# FROM V$PDB_INCARNATION
       WHERE STATUS = 'CURRENT' AND CON_ID = PDB_container_id;
```

14.3.2.4 About Orphaned Backups

When a database goes through multiple incarnations, some backups can become orphaned backups. Orphaned backups are backups created during incarnations of the database that are not in the direct ancestral path.

Assume the scenario shown in [Figure 14-1](#) (page 14-9). If incarnation 3 is the current incarnation, then the following backups are orphaned:

- All backups from incarnation 1 after SCN 1000
- All backups from incarnation 2 after SCN 2000

In contrast, the following backups are not orphaned because they are in the direct ancestral path:

- All backups from incarnation 1 before SCN 1000
- All backups from incarnation 2 before SCN 2000
- All backups from incarnation 3

You can use orphaned backups when you intend to restore the database to an SCN not in the direct ancestral path. RMAN can restore backups from parent and ancestor incarnations and recover to the current time, even across `OPEN RESETLOGS` operations, if a continuous path of archived logs exists from the earliest backups to the point to which you want to recover. If you restore a control file from an incarnation in which the changes represented in the backups had not been abandoned, then RMAN can also restore and recover orphaned backups.

14.3.2.5 About Orphaned PDB Backups

Orphan PDB backups can result when you perform point-in-time recovery on a pluggable database (PDB) and then open the PDB using the `RESETLOGS` option.

After recovering a PDB to a specified point-in-time, when you open the PDB using the `RESETLOGS` option, a new incarnation of the PDB is created. Orphan PDB backups are backups that were created when the SCN or time value was between the SCN or time to which the PDB was recovered and the SCN or time at which the PDB was opened in `RESETLOGS` mode. The `END_RESETLOGS_SCN` column of the `V$PDB_INCARNATION` view contains the SCN at which the PDB is opened in `RESETLOGS` mode.

Diagnosing and Repairing Failures with Data Recovery Advisor

This chapter explains how to use the Data Recovery Advisor tool in RMAN to diagnose and repair database failures. This chapter contains the following topics:

- [Overview of Data Recovery Advisor](#) (page 15-1)
- [Listing Failures](#) (page 15-8)
- [Checking for Block Corruptions by Validating the Database](#) (page 15-9)
- [Determining Repair Options](#) (page 15-11)
- [Repairing Failures](#) (page 15-14)
- [Changing Failure Status and Priority](#) (page 15-16)

15.1 Overview of Data Recovery Advisor

This section explains the purpose and basic concepts of the [Data Recovery Advisor](#).

15.1.1 Purpose of Data Recovery Advisor

Data Recovery Advisor is an Oracle Database tool that automatically diagnoses data failures, determines and presents appropriate repair options, and executes repairs at the user's request.

In this context, a data failure is a corruption or loss of persistent data on disk. By providing a centralized tool for automated data repair, Data Recovery Advisor improves the manageability and reliability of an Oracle database and thus helps reduce the [MTTR](#).

Diagnosing a data failure and devising an optimal strategy for repair requires a high degree of training and experience. Data Recovery Advisor provides the following advantages over traditional repair techniques:

- Data Recovery Advisor can potentially detect, analyze, and repair data failures *before* a database process discovers the corruption and signals an error. Early warnings help limit damage caused by corruption.
- Manually assessing symptoms of data failures and correlating them into a problem statement can be complex, error-prone, and time-consuming. Data Recovery Advisor automatically diagnoses failures, assesses their impact, and reports these findings to the user.
- Traditionally, users must manually determine repair options along with the repair impact. If multiple failures are present, then users must determine the right sequence of repair execution and try to consolidate repairs. In contrast, Data

Recovery Advisor automatically determines the best repair options and runs checks to ensure that these options are feasible in your environment.

- Execution of a data repair can be complex and error-prone. If you choose an automated repair option, then Data Recovery Advisor executes the repair and verifies its success.

15.1.2 Basic Concepts of Data Recovery Advisor

You must familiarize yourself with a few concepts before using the Data Recovery Advisor.

See Also:

- [User Interfaces to Data Recovery Advisor](#) (page 15-2)
 - [About Data Integrity Checks](#) (page 15-2)
 - [About Failures](#) (page 15-3)
 - [About Manual Actions and Automatic Repair Options](#) (page 15-4)
 - [About Supported Database Configurations for Data Recovery Advisor](#) (page 15-6)
-
-

15.1.2.1 User Interfaces to Data Recovery Advisor

Data Recovery Advisor has both a command-line and GUI interface. The GUI interface is available in Oracle Enterprise Manager Cloud Control.

In the RMAN command-line interface, the Data Recovery Advisor commands are `LIST FAILURE`, `ADVISE FAILURE`, `REPAIR FAILURE`, and `CHANGE FAILURE`.

A [failure](#) is detected either automatically by the database or through a manual check such as the `VALIDATE` command. You can use the `LIST FAILURE` command to view problem statements for failures and the effect of these failures on database operations. Each failure is uniquely identified by a failure number. In the same RMAN session, you can then use the `ADVISE FAILURE` command to view repair options, which typically include both automated and manual options.

After executing `ADVISE FAILURE`, you can either repair failures manually or run the `REPAIR FAILURE` command to repair the failures automatically. A [repair](#) is an action that fixes one or more failures. Examples of repairs include [block media recovery](#), [data file media recovery](#), and [Oracle Flashback Database](#). When you choose an automated [repair option](#), Data Recovery Advisor verifies the repair success and closes the relevant repaired failures.

15.1.2.2 About Data Integrity Checks

A checker is a diagnostic operation or procedure registered with the Health Monitor to assess the health of the database or its components.

The health assessment is known as a [data integrity check](#) and can be invoked reactively or proactively.

Failures are normally detected reactively. A database operation involving corrupted data results in an error, which automatically invokes a data integrity check that searches the database for failures related to the error. If failures are diagnosed, then

they are recorded in the [Automatic Diagnostic Repository \(ADR\)](#), which is a directory structure stored outside of the database. You can use Data Recovery Advisor to generate repair advice and repair failures only after failures have been detected by the database and stored in ADR.

You can also invoke a data integrity check proactively. You can execute the check through the Health Monitor, which detects and stores failures in the same way as when the checks are invoked reactively. You can also check for block corruption with the `VALIDATE` and `BACKUP VALIDATE` commands, as explained in "[Checking for Block Corruptions by Validating the Database](#) (page 15-9)".

See Also:

Oracle Database Administrator's Guide to learn how to use the Health Monitor

15.1.2.3 About Failures

A failure is a persistent data corruption that is detected by a data integrity check.

A failure can manifest itself as observable symptoms such as error messages and alerts, but a failure is different from a symptom because it represents a diagnosed [problem](#). After a problem is diagnosed by the database as a failure, you can obtain information about the failure and potentially repair it with Data Recovery Advisor.

Because failure information is not stored in the database itself, the database does not need to be open or mounted for you to access it. You can view failures when the database is started in `NOMOUNT` mode. Thus, the availability of the control file and [recovery catalog](#) does not affect the ability to view detected failures, although it may affect the feasibility of some repairs.

Data Recovery Advisor can diagnose failures such as the following:

- Components such as data files and control files that are not accessible because they do not exist, do not have the correct access permissions, have been taken offline, and so on
- Physical corruptions such as block checksum failures and invalid block header field values
- Inconsistencies such as a data file that is older than other database files
- I/O failures such as hardware errors, operating system driver failures, and exceeding operating system resource limits (for example, the number of open files)

The Data Recovery Advisor may detect or handle some logical corruptions. In general, corruptions of this type require help from Oracle Support Services.

See Also:

- [About the Failure Status](#) (page 15-4)
 - [About Failure Priority](#) (page 15-4)
 - [About Failure Grouping](#) (page 15-4)
-
-

15.1.2.3.1 About the Failure Status

Every failure has a failure status: `OPEN` or `CLOSED`.

The status of a failure is `OPEN` until the appropriate repair action is invoked. The status changes to `CLOSED` after the failure is repaired.

Every time you execute `LIST FAILURE`, Data Recovery Advisor revalidates all open failures and closes failures that no longer exist. Thus, if you fixed some failures as part of a separate procedure, or if the failures were transient problems that disappeared by themselves, running `LIST FAILURE` automatically closes them.

You can use `CHANGE FAILURE` to change the status of an open failure to `CLOSED` if you have fixed it manually. However, it makes sense to use `CHANGE FAILURE . . . CLOSED` only if for some reason the failure was not closed automatically. If a failure still exists when you use `CHANGE` to close it manually, then Data Recover Advisor re-creates it with a different failure ID when the appropriate data integrity check is executed.

15.1.2.3.2 About Failure Priority

Every failure has a failure priority: `CRITICAL`, `HIGH`, or `LOW`. Data Recovery Advisor only assigns `CRITICAL` or `HIGH` priority to diagnosed failures.

Failures with `CRITICAL` priority require immediate attention because they make the whole database unavailable. For example, a disk containing a current control file may fail. Failures with `HIGH` priority make a database partly unavailable or unrecoverable and usually have to be repaired quickly. Examples include block corruptions and missing archived redo logs.

If a failure was assigned a `HIGH` priority, but the failure has little impact on database availability and recoverability, then you can downgrade the priority to `LOW`. A `LOW` priority indicates that a failure can be ignored until more important failures are fixed.

By default `LIST FAILURE` displays only failures with `CRITICAL` and `HIGH` priority. You can use the `CHANGE` command to change the status for `LOW` and `HIGH` failures, but you cannot change the status of `CRITICAL` failures. The main reason for changing a priority to `LOW` is to reduce the `LIST FAILURE` output. If a failure cannot be revalidated at this time (for example, because of another failure), then `LIST FAILURE` shows the failure as open.

15.1.2.3.3 About Failure Grouping

For clarity, Data Recovery Advisor groups related failures together.

For example, if 20 different blocks in a file are corrupted, then these failures are grouped under a single parent failure. By default, Data Recovery Advisor lists information about the group of failures, although you can specify the `DETAIL` option to list information about the individual subfailures.

A subfailure has the same format as a failure. You can get advice on a subfailure and repair it separately or in combination with any other failure.

15.1.2.4 About Manual Actions and Automatic Repair Options

The `ADVISE FAILURE` command can present both manual and automatic repair options. Data Recovery Advisor categorizes manual actions as either mandatory or optional.

In some cases, the only possible actions are manual. Suppose that no backups exist for a lost control file. In this case, the manual action is to execute the `CREATE`

CONTROLFILE statement. Data Recovery Advisor presents this manual action as mandatory because no automatic repair is available. In contrast, suppose that RMAN backups exist for a missing data file. In this case, the REPAIR FAILURE command can perform the repair automatically by restoring and recovering the data file. An optional manual action is to restore the data file if it was unintentionally renamed or moved. Data Recovery Advisor suggests optional manual actions if they might prevent a more extreme form of repair such as data file restore and recovery.

In contrast to manual actions, automated repairs can be performed by Data Recovery Advisor. The ADVISE FAILURE command presents an option ID for each automated repair option and summarizes the action.

Data Recovery Advisor performs feasibility checks before recommending an automated repair. For example, Data Recovery Advisor checks that all backups and archived redo logs needed for media recovery are present and consistent. Data Recovery Advisor may need specific backups and archived redo logs. If the files needed for recovery are not available, then recovery is not possible.

Note:

For performance reasons, Data Recovery Advisor does not exhaustively check every byte in every file. Thus, a feasible repair may still fail because of a corrupted backup or archived redo log file.

15.1.2.4.1 About Consolidated Repairs

When possible, Data Recovery Advisor consolidates repairs to fix multiple failures into a single repair. A consolidated repair may contain multiple steps.

Sometimes a consolidated repair is not possible, as when one failure prevents the creation of repairs for other failures. For example, the feasibility of a data file repair cannot be determined when the control file is missing. In such cases, Data Recovery Advisor generates a repair option for failures that can be repaired and prints a message stating that some selected failures cannot be repaired at this time. After executing the proposed repair, you can repeat the LIST, ADVISE, and REPAIR sequence to repair remaining failures.

15.1.2.4.2 About Repair Scripts

Whenever Data Recovery Advisor generates an automated repair option, it creates a script that explains which commands RMAN intends to use to repair the failure. Data Recovery Advisor prints the location of this script, which is a text file residing on the operating system.

[Example 15-1](#) (page 15-5) shows a sample repair script, which shows how Data Recovery Advisor plans to repair the loss of data file 27.

Example 15-1 Sample Repair Script

```
# restore and recover data file
ALTER DATABASE DATAFILE 27 OFFLINE;
restore datafile 27;
recover datafile 27;
ALTER DATABASE DATAFILE 27 ONLINE;
```

If you do not want Data Recovery Advisor to automatically repair the failure, then you can copy the script, edit it, and execute it manually.

15.1.2.5 About Supported Database Configurations for Data Recovery Advisor

This section describes the supported database configurations for Data Recovery Advisor.

15.1.2.5.1 About Data Recovery Advisor and Oracle Real Application Clusters

Data Recovery Advisor only supports single-instance databases. Oracle Real Application Clusters (Oracle RAC) databases are not supported.

If a data failure occurs that brings down all Oracle RAC instances, then you can mount the database in single-instance mode and use Data Recovery Advisor to detect and repair control file, `SYSTEM` data file, and data dictionary failures. You can also invoke data recovery checks proactively to test other database components for data failures. This approach does not detect data failures that are local to other cluster instances, for example, an inaccessible data file.

15.1.2.5.2 About Data Recovery Advisor and Oracle Data Guard

There are some limitation with Data Recovery Advisor in an Oracle Data Guard environment.

In a Data Guard environment, Data Recovery Advisor cannot do the following:

- Use files transferred from a [physical standby database](#) to repair failures on a primary database
- Diagnose and repair failures on a standby database

However, if the primary database is unavailable, then Data Recovery Advisor may recommend a failover to a standby database. After the failover you can repair the old primary database. If you are using Enterprise Manager Cloud Control in a Data Guard configuration, then you can initiate a failover through the Data Recovery Advisor recommendations page.

See Also:

Oracle Data Guard Concepts and Administration to learn how to use RMAN in a Data Guard configuration

15.1.2.5.3 About Data Recovery Advisor and CDBs

Data Recovery Advisor can only be used to diagnose and repair data corruptions in non-CDBs and the root of a multitenant container database (CDB). Data Recovery Advisor is not supported for pluggable databases (PDBs).

15.1.3 Basic Steps of Diagnosing and Repairing Failures

The Data Recovery Advisor workflow begins when you either suspect or discover a failure. You can discover failures in many ways, including error messages, alerts, trace files, and failed data integrity checks.

As explained in "[About Data Integrity Checks](#) (page 15-2)", the database can automatically diagnose failures when errors occur.

To respond to failures, start an RMAN session and perform all of the following steps in the same session and in the order they are listed:

1. List failures by running the `LIST FAILURE` command.

This task is explained in "[Listing Failures](#) (page 15-8)".

2. If you suspect that failures exist that have not been automatically diagnosed by the database, then run `VALIDATE DATABASE` to check for corrupt blocks and missing files.

If `VALIDATE` detects a problem, then RMAN triggers execution of a failure assessment. If a failure is detected, then RMAN logs it into the Automated Diagnostic Repository, where it can be accessed by Data Recovery Advisor.

This task is explained in "[Checking for Block Corruptions by Validating the Database](#) (page 15-9)".

3. Determine repair options by running the `ADVISE FAILURE` command.

This task is explained in "[Determining Repair Options](#) (page 15-11)".

4. Choose a repair option. You can repair the failures manually or run the `REPAIR FAILURE` command to fix them automatically.

This task is explained in "[Repairing Failures](#) (page 15-14)".

5. Return to the first step to confirm that all failures were repaired or determine which failures remain.

Performing the steps for diagnosing and repairing failures in an order that is different from the one listed in this section may result in errors.

If appropriate, you can use `CHANGE FAILURE` command at any time in the Data Recovery Advisor workflow to change the priority of a failure from `LOW` to `HIGH` or `HIGH` to `LOW`, or close a failure that has been fixed manually. This task is explained in "[Changing Failure Status and Priority](#) (page 15-16)".

See Also:

Oracle Data Guard Concepts and Administration for a complete example on recovering a database using the Data Recovery Advisor

15.1.4 Diagnosing and Repairing Failures in CDBs

You can use the Data Recovery Advisor to automatically diagnose data failures, determine appropriate repair options, and execute repairs in a CDB.

The steps used for a CDB are similar to the ones that you would use for a [non-CDB](#). The only difference is that, for a CDB, you connect to the root and then use the steps described in this chapter to perform repair actions.

You cannot diagnose data failures and execute repairs for individual [PDBs](#) in a CDB.

See Also:

"[Making RMAN Connections to a CDB](#) (page 4-7)"

15.2 Listing Failures

If you suspect or know that one or more database failures have occurred, then use `LIST FAILURE` to obtain information about them.

You can list all or a subset of failures and restrict output in various ways. Failures are uniquely identified by failure numbers. These numbers are not consecutive, so gaps between failure numbers have no significance.

The `LIST FAILURE` command does not execute data integrity checks to diagnose new failures; rather, it lists the results of previously executed assessments. Thus, repeatedly executing `LIST FAILURE` reveals new failures only if the database automatically diagnosed them in response to errors that occurred in between command executions. However, executing `LIST FAILURE` causes Data Recovery Advisor to revalidate all existing failures. If a user fixed failures manually, or if transient failures disappeared, then Data Recovery Advisor removes these failures from the `LIST FAILURE` output. If a failure cannot be revalidated at this moment (for example, because of another failure), `LIST FAILURE` shows the failure as open.

See Also:

- [Listing All Failures](#) (page 15-8)
 - [Listing a Subset of Failures](#) (page 15-9)
-
-

15.2.1 Listing All Failures

The easiest way to determine problems that your database is encountering is to use the `LIST FAILURE` command.

To list all failures:

1. Start RMAN and connect to a target database. The target database instance must be started.
2. Execute the `LIST FAILURE` command.

The following example reports all failures known to Data Recovery Advisor (the output has been reformatted to fit on the page).

```
RMAN> LIST FAILURE;
```

```
List of Database Failures
=====
```

Failure ID	Priority	Status	Time Detected	Summary
142	HIGH	OPEN	23-APR-13	One or more non-system datafiles are missing
101	HIGH	OPEN	23-APR-13	Datafile 1: '/disk1/oradata/prod/system01.dbf' contains one or more corrupt blocks

In this example, RMAN reports two different failures: a group of missing data files and a data file with corrupt blocks. The output indicates the unique identifier for each failure (142 and 101), the priority, status, and detection time.

3. Optionally, execute `LIST FAILURE . . . DETAIL` to list failures individually.

Data Recovery Advisor consolidates failures when possible. Specify the `DETAIL` option to list failures individually. For example, if multiple block corruptions exist in a file, then specifying the `DETAIL` option lists each of the block corruptions. The following example lists detailed information about failure 101.

```
RMAN> LIST FAILURE 101 DETAIL;
```

```
List of Database Failures
```

```
=====
```

```
Failure ID Priority Status      Time Detected Summary
```

```
-----
```

```
101          HIGH      OPEN        23-APR-13   Datafile 1: '/disk1/oradata/prod/
system01.dbf' contains one or more corrupt blocks
```

```
List of child failures for parent failure ID 101
```

```
Failure ID Priority Status      Time Detected Summary
```

```
-----
```

```
104          HIGH      OPEN        23-APR-13   Block 56416 in datafile 1: '/disk1/
oradata/prod/system01.dbf' is media corrupt
```

```
Impact: Object BLKTEST owned by SYS might be unavailable
```

4. Proceed to determine how to repair the failures displayed by the `LIST FAILURE` command as described in "[Determining Repair Options](#) (page 15-11)".

15.2.2 Listing a Subset of Failures

Besides providing more verbose output, `LIST FAILURE` also enables you to restrict output.

For example, you can execute `LIST FAILURE` with the `CRITICAL`, `HIGH`, `LOW`, or `CLOSED` options to list only failures with a particular status or priority. You can also exclude specified failures from the output by specifying `EXCLUDE FAILURE`.

To list a subset of failures:

1. Start RMAN and connect to a target database. The target database instance must be started.
2. Execute `LIST FAILURE` with the desired options.

The following examples illustrate some `LIST FAILURE` commands:

```
LIST FAILURE LOW;
LIST FAILURE CLOSED;
LIST FAILURE EXCLUDE FAILURE 234234;
```

See Also:

Oracle Database Backup and Recovery Reference to learn about the `LIST FAILURE` command

15.3 Checking for Block Corruptions by Validating the Database

The database invokes data integrity checks reactively when a user transaction is trying to access corrupted data. In some cases, latent failures can go undetected.

For example, when a data block corruption error occurs, the database reactively execute a data integrity check that validates the block on which the error occurred and other blocks in its immediate vicinity. However, blocks outside of the vicinity may be corrupted. Also, corrupted blocks that are never read by the database are never detected by a reactive data integrity check.

One effective way to execute a data integrity check proactively is to run the `VALIDATE` or `BACKUP VALIDATE` commands in RMAN. These commands can check data files and control files for physical and logical corruption. If RMAN discovers block corruptions, then it logs them into the Automatic Diagnostic Repository and creates one or more failures. You can then use Data Recovery Advisor to list information about the failures and repair them.

To validate the database:

1. Start RMAN and connect to a target database. The target database must be mounted.
2. Validate the desired database files.

The following example uses `VALIDATE DATABASE` to check for physical and logical corruption in the whole database (partial sample output included). Because "[Listing Failures](#) (page 15-8)" indicates that some data files are missing, the `SKIP INACCESSIBLE` clause is specified. The output shows that the `system01.dbf` database file has one newly corrupt block (Blocks Failing) and no blocks previously marked corrupt by the database (Marked Corrupt).

```
RMAN> VALIDATE CHECK LOGICAL SKIP INACCESSIBLE DATABASE;
```

```
Starting validate at 23-APR-13
allocated channel: ORA_DISK_1
channel ORA_DISK_1: SID=103 device type=DISK
could not access datafile 28
skipping inaccessible file 28
RMAN-06060: WARNING: skipping datafile compromises tablespace USERS recoverability
RMAN-06060: WARNING: skipping datafile compromises tablespace USERS recoverability
channel ORA_DISK_1: starting validation of datafile
channel ORA_DISK_1: specifying datafile(s) for validation
input datafile file number=00001 name=/disk1/oradata/prod/system01.dbf
input datafile file number=00002 name=/disk1/oradata/prod/sysaux01.dbf
input datafile file number=00022 name=/disk1/oradata/prod/undotbs01.dbf
input datafile file number=00023 name=/disk1/oradata/prod/cwmlite01.dbf
input datafile file number=00024 name=/disk1/oradata/prod/drsys01.dbf
input datafile file number=00025 name=/disk1/oradata/prod/example01.dbf
input datafile file number=00026 name=/disk1/oradata/prod/indx01.dbf
input datafile file number=00027 name=/disk1/oradata/prod/tools01.dbf
channel ORA_DISK_1: validation complete, elapsed time: 00:00:25
List of Datafiles
=====
File Status Marked Corrupt Empty Blocks Blocks Examined High SCN
-----
1 FAILED 0 3536 57600 637711
File Name: /disk1/oradata/prod/system01.dbf
Block Type Blocks Failing Blocks Processed
-----
Data 1 41876
Index 0 7721
Other 0 4467
.
.
```



```

File Status Marked Corrupt Empty Blocks Blocks Examined High SCN
-----
27 OK 0 1272 1280 400914
File Name: /disk1/oradata/prod/tools01.dbf
Block Type Blocks Failing Blocks Processed
-----
Data 0 0
Index 0 0
Other 0 8

```

validate found one or more corrupt blocks
See trace file /disk1/oracle/log/diag/rdbms/prod/prod/trace/prod_ora_2596.trc
for details

```

channel ORA_DISK_1: starting validation of datafile
channel ORA_DISK_1: specifying datafile(s) for validation
including current control file for validation
including current SPFILE in backup set
channel ORA_DISK_1: validation complete, elapsed time: 00:00:01
List of Control File and SPFILE
=====

```

```

File Type Status Blocks Failing Blocks Examined
-----
SPFILE OK 0 2
Control File OK 0 512
Finished validate at 23-APR-13

```

See Also:

- [About Data Integrity Checks](#) (page 15-2)
 - [Validating Database Files and Backups](#) (page 16-1)
 - *Oracle Database Backup and Recovery Reference* to learn about the VALIDATE command
 - *Oracle Database Administrator's Guide* to learn about how Oracle Database manages diagnostic data
-
-

15.4 Determining Repair Options

Use the ADVISE FAILURE command to display repair options after running LIST FAILURE in an RMAN session. This command prints a summary of the failures and implicitly closes all open failures that are repaired.

Where appropriate, the ADVISE FAILURE command presents a list of manual and automated repair options. Manual options, which are categorized as either mandatory or optional, appear first. In some cases, an optional manual fix can avoid more extreme actions such as restoring and recovering data files. As a rule, use the repair technique that has the least effect on the database and the least possibility for error.

See Also:

- [Determining Repair Options for All Failures](#) (page 15-12)
 - [Determining Repair Options for a Subset of Failures](#) (page 15-13)
-
-

15.4.1 Determining Repair Options for All Failures

If one or more failures exist, then you typically use `LIST FAILURE` to show information about the failures and then `ADVISE FAILURE` in the same RMAN session to obtain a report of your repair options.

To determine repair options for all failures:

1. List failures as described in "[Listing All Failures](#) (page 15-8)".
2. In the same RMAN session, execute `ADVISE FAILURE`.

The following example requests repair options for all failures known to Data Recovery Advisor and includes sample output (reformatted to fit the page).

```
RMAN> ADVISE FAILURE;

List of Database Failures
=====

Failure ID Priority Status   Time Detected Summary
-----
142          HIGH   OPEN    23-APR-13   One or more non-system datafiles
                                     are missing
101          HIGH   OPEN    23-APR-13   Datafile 1: '/disk1/oradata/prod/
system01.dbf' contains one or more corrupt blocks

analyzing automatic repair options; this may take some time
using channel ORA_DISK_1
analyzing automatic repair options complete

Mandatory Manual Actions
=====
no manual actions available

Optional Manual Actions
=====
1. If file /disk1/oradata/prod/users01.dbf was unintentionally renamed or moved,
restore it

Automated Repair Options
=====
Option Repair Description
-----
1      Restore and recover datafile 28; Perform block media recovery of
      block 56416 in file 1
      Strategy: The repair includes complete media recovery with no data loss
      Repair script: /disk1/oracle/log/diag/rdbms/prod/prod/hm/reco_660500184.hm
```

In the preceding example, `ADVISE FAILURE` reports two failures: a missing data file and a data file with corrupt blocks. The command does not list mandatory manual actions, but it suggests making sure that the missing data file was not accidentally renamed or removed. The automated repair option involves [block media recovery](#) and restoring and recovering the missing data file. `ADVISE FAILURE` lists the location of the repair script.

The following variation of the same example shows the output when the RMAN backups or archived redo logs needed for the automated repair are not available. The command `ADVISE FAILURE` now shows mandatory manual actions.

```

RMAN> ADVISE FAILURE;

List of Database Failures
=====

Failure ID Priority Status    Time Detected Summary
-----
142          HIGH    OPEN      23-APR-13    One or more non-system datafiles
are missing
101          HIGH    OPEN      23-APR-13    Datafile 1:
'/disk1/oradata/prod/system01.dbf' contains one or more corrupt blocks

analyzing automatic repair options; this may take some time
allocated channel: ORA_DISK_1
channel ORA_DISK_1: SID=103 device type=DISK
analyzing automatic repair options complete

Mandatory Manual Actions
=====
1. If file /disk1/oradata/prod/users01.dbf was unintentionally renamed or
moved, restore it
2. Contact Oracle Support Services if the preceding recommendations cannot be
used, or if they do not fix the failures selected for repair

Optional Manual Actions
=====
no manual actions available

Automated Repair Options
=====
Option Repair Description
-----
1      Perform block media recovery of block 56416 in file 1
      Strategy: The repair includes complete media recovery with no data loss
      Repair script: /disk1/oracle/log/diag/rdbms/prod/prod/hm/reco_1863891774.hm

3. Proceed to "Repairing Failures (page 15-14)" to determine how to repair the
failures shown in the LIST FAILURE output.

```

15.4.2 Determining Repair Options for a Subset of Failures

You can also request repair options for specific failures. You can specify failures by status (CRITICAL, HIGH, or LOW) or by failure number. You can also use EXCLUDE FAILURE to exclude one or more failures from the report.

To determine repair options for a subset of failures:

1. List failures as described in "[Listing All Failures](#) (page 15-8)".
2. In the same RMAN session, execute ADVISE FAILURE with the desired options.

The following example requests repair options for failure 101 only.

```

RMAN> ADVISE FAILURE 101;

List of Database Failures
=====

Failure ID Priority Status    Time Detected Summary
-----
101          HIGH    OPEN      23-APR-13    Datafile 1: '/disk1/oradata/prod/

```

```
system01.dbf' contains one or more corrupt blocks

analyzing automatic repair options; this may take some time
using channel ORA_DISK_1
analyzing automatic repair options complete

Mandatory Manual Actions
=====
no manual actions available

Optional Manual Actions
=====
no manual actions available

Automated Repair Options
=====
Option Repair Description
-----
1      Perform block media recovery of block 56416 in file 1
      Strategy: The repair includes complete media recovery with no data loss
      Repair script: /disk1/oracle/log/diag/rdbms/prod/prod/hm/reco_708819503.htm
```

3. Proceed to "[Repairing Failures](#) (page 15-14)" to determine how to repair the failures displayed by the LIST FAILURE command.

See Also:

Oracle Database Backup and Recovery Reference to learn about the ADVISE FAILURE command

15.5 Repairing Failures

You can use Data Recovery Advisor to repair failures automatically.

This section contains the following topics:

- [About Repairing Failures](#) (page 15-14)
- [Repairing a Failure](#) (page 15-15)

15.5.1 About Repairing Failures

If ADVISE FAILURE suggests manual repairs, then try these first. If manual repairs are not possible, or if they do not repair all failures, then you can use REPAIR FAILURE to automatically fix failures suggested in the most recent ADVISE FAILURE command in your current RMAN session.

By default, REPAIR FAILURE prompts for confirmation before it begins executing. You can suppress the confirmation prompt by specifying the NOPROMPT option. After it starts executing, the command indicates the current phase of repair. Depending on the circumstances, RMAN may prompt for a response. After executing a repair, RMAN reevaluates all existing failures on the chance that they may have been fixed during this repair.

While repairing a failure, wherever possible, RMAN takes a file online, restores and recovers it, and then brings it back online again. You can repair failures for a selected database, tablespace, or data file.

Before performing a repair, it is typically advisable to preview it by specifying the `PREVIEW` option. RMAN does not make any repairs and generates a script with all repair actions and comments. If you do not specify a particular repair option, then RMAN uses the first repair option of the most recent `ADVISE FAILURE` command in the current session. By default the repair script is displayed to standard output. You can use the `SPOOL` command to write the script to an editable file.

See Also:

- *Oracle Database Backup and Recovery Reference* to learn about the `REPAIR FAILURE` command
 - *Oracle Database Backup and Recovery Reference* to learn about the `SPOOL` command
-
-

15.5.2 Repairing a Failure

By default the script is displayed to standard output. You can use the `SPOOL` command to write the script to an editable file.

To repair a failure:

1. List failures as described in "[Listing All Failures](#) (page 15-8)".
2. Display repair options as described in "[Determining Repair Options](#) (page 15-11)".
3. Optionally, execute `REPAIR FAILURE PREVIEW`.

The following example previews the first repair options displayed by the previous `ADVISE FAILURE` command in the RMAN session.

```
RMAN> REPAIR FAILURE PREVIEW;
```

```
Strategy: The repair includes complete media recovery with no data loss
Repair script: /disk1/oracle/log/diag/rdbms/prod/prod/hm/reco_475549922.hm
contents of repair script:
# restore and recover datafile
sql 'alter database datafile 28 offline';
restore datafile 28;
recover datafile 28;
sql 'alter database datafile 28 online';
# block media recovery
recover datafile 1 block 56416;
```

4. Execute `REPAIR FAILURE`.

The following repair restores and recovers one data file and performs block media recovery on one corrupt block. RMAN prompts for confirmation that it should perform the repair. The user-entered text is in bold.

```
RMAN> REPAIR FAILURE;
```

```
Strategy: The repair includes complete media recovery with no data loss
Repair script: /disk1/oracle/log/diag/rdbms/prod/prod/hm/reco_475549922.hm
contents of repair script:
# restore and recover data file
sql 'alter database datafile 28 offline';
restore datafile 28;
```

```

recover datafile 28;
sql 'alter database datafile 28 online';
# block media recovery
recover datafile 1 block 56416;

```

Do you really want to execute the above repair (enter YES or NO)? **YES**
executing repair script

sql statement: alter database datafile 28 offline

Starting restore at 23-APR-13
using channel ORA_DISK_1

```

channel ORA_DISK_1: starting datafile backup set restore
channel ORA_DISK_1: specifying datafile(s) to restore from backup set
channel ORA_DISK_1: restoring datafile 00028 to /disk1/oradata/prod/users01.dbf
channel ORA_DISK_1: reading from backup piece /disk2/PROD/backupset/2013_04_18/
o1_mf_nnndf_TAG20130418T182042_32fjzd3z_.bkp
channel ORA_DISK_1: piece handle=/disk2/PROD/backupset/2013_04_18/
o1_mf_nnndf_TAG20130418T182042_32fjzd3z_.bkp tag=TAG20130418T182042
channel ORA_DISK_1: restored backup piece 1
channel ORA_DISK_1: restore complete, elapsed time: 00:00:03
Finished restore at 23-APR-13

```

Starting recover at 23-APR-13
using channel ORA_DISK_1

```

starting media recovery
media recovery complete, elapsed time: 00:00:01

```

Finished recover at 23-APR-13

sql statement: alter database datafile 28 online

```

Starting recover at 23-APR-13
using channel ORA_DISK_1
searching flashback logs for block images until SCN 429690
finished flashback log search, restored 1 blocks

```

```

starting media recovery
media recovery complete, elapsed time: 00:00:03

```

Finished recover at 23-APR-13
repair failure complete

5. Optionally, execute `LIST FAILURE` to confirm

15.6 Changing Failure Status and Priority

In some situations, you may want to use the `CHANGE FAILURE` command to alter the status or priority of a failure.

For example, if a block corruption has `HIGH` priority, you may want to change it to `LOW` temporarily if the block is in a little-used tablespace.

If you repair a failure by a means other than the `REPAIR FAILURE` command, then Data Recovery Advisor closes it implicitly the next time you execute `LIST FAILURE`. For this reason, you do not normally need to execute the `CHANGE FAILURE . . . CLOSED` command. You need to use this command only if the automatic failure revalidation fails, but you believe the failure no longer exists. If you use `CHANGE`

FAILURE to close a failure that still exists, then Data Recovery Advisor re-creates it with a different failure ID when the appropriate data integrity check is executed.

Typically, you specify the failures to change by failure number. You can also change failures in bulk by specifying ALL, CRITICAL, HIGH, or LOW. You can change a failure to CLOSED or to PRIORITY HIGH or PRIORITY LOW.

To change the status or priority of a failure:

1. List failures as described in "[Listing All Failures](#) (page 15-8)".

The following example lists one failure involving corrupt data blocks.

```
RMAN> LIST FAILURE;
```

```
List of Database Failures
=====
```

Failure ID	Priority	Status	Time Detected	Summary
142	HIGH	OPEN	23-APR-13	One or more non-system datafiles are missing
101	HIGH	OPEN	23-APR-13	Datafile 25: '/disk1/oradata/prod/example01.dbf' contains one or more corrupt blocks

2. Execute CHANGE FAILURE with the desired options.

The following example changes the priority of a block corruption failure from HIGH to LOW.

```
RMAN> CHANGE FAILURE 101 PRIORITY LOW;
```

```
List of Database Failures
=====
```

Failure ID	Priority	Status	Time Detected	Summary
101	HIGH	OPEN	23-APR-13	Datafile 25: '/disk1/oradata/prod/example01.dbf' contains one or more corrupt blocks

```
Do you really want to change the above failures (enter YES or NO)? YES
changed 1 failures to LOW priority
```

3. Optionally, execute LIST FAILURE ALL to view the change.

If you execute LIST FAILURE without ALL, then the command lists failures with LOW priority only if no CRITICAL or HIGH priority failures exist.

```
RMAN> LIST FAILURE ALL;
```

```
List of Database Failures
=====
```

Failure ID	Priority	Status	Time Detected	Summary
142	HIGH	OPEN	23-APR-13	One or more non-system datafiles are missing
101	LOW	OPEN	23-APR-13	Datafile 25: '/disk1/oradata/prod/example01.dbf' contains one or more corrupt blocks

See Also:

Oracle Database Backup and Recovery Reference to learn about the `CHANGE` command

Validating Database Files and Backups

This chapter explains how to check the integrity of database files and backups. This chapter contains the following topics:

- [Overview of RMAN Validation](#) (page 16-1)
- [Checking for Block Corruption with the VALIDATE Command](#) (page 16-4)
- [Validating Database Files with BACKUP VALIDATE](#) (page 16-6)
- [Validating Backups Before Restoring Them](#) (page 16-7)
- [Validating CDBs and PDBs](#) (page 16-8)

16.1 Overview of RMAN Validation

This section explains the basic concepts and tasks involved in RMAN validation.

16.1.1 Purpose of RMAN Validation

The main purpose of RMAN validation is to check for corrupt blocks and missing files. You can also use RMAN to determine whether backups can be restored.

You can use the following RMAN commands to perform validation:

- VALIDATE
- BACKUP . . . VALIDATE
- RESTORE . . . VALIDATE

See Also:

- *Oracle Database Backup and Recovery Reference* for VALIDATE syntax
 - *Oracle Database Backup and Recovery Reference* for RESTORE . . . VALIDATE syntax
-

16.1.2 Basic Concepts of RMAN Validation

The database prevents operations that result in unusable backup files or corrupted restored data files.

The database automatically does the following:

- Blocks access to data files while they are being restored or recovered

- Permits only one restore operation for each data file at a time
- Ensures that incremental backups are applied in the correct order
- Stores information in backup files to allow detection of corruption
- Checks a block every time it is read or written in an attempt to report a corruption as soon as it has been detected

16.1.2.1 About Checksums and Corrupt Blocks

A corrupt block is a block that has been changed so that it differs from what Oracle Database expects to find.

Block corruptions can be caused by several different failures including, but not limited to the following:

- Faulty disks and disk controllers
- Faulty memory
- Oracle Database software defects

DB_BLOCK_CHECKSUM is a database initialization parameter that controls the writing of checksums for the blocks in data files and online redo log files in the database (not backups). If DB_BLOCK_CHECKSUM is `typical`, then the database computes a checksum for each block during normal operations and stores it in the header of the block before writing it to disk. When the database reads the block from disk later, it recomputes the checksum and compares it to the stored value. If the values do not match, then the block is corrupt.

By default, the `BACKUP` command computes a checksum for each block and stores it in the backup. The `BACKUP` command ignores the values of `DB_BLOCK_CHECKSUM` because this initialization parameter applies to data files in the database, not backups.

16.1.2.2 About Physical and Logical Block Corruption

In a physical corruption, which is also called a media corruption, the database does not recognize the block at all: the checksum is invalid, the block contains all zeros, or the header and footer of the block do not match.

Note:

By default, the `BACKUP` command computes a checksum for each block and stores it in the backup. If you specify the `NOCHECKSUM` option, then RMAN does not perform a checksum of the blocks when creating the backup.

In a [logical corruption](#), the contents of the block are logically inconsistent. Examples of logical corruption include corruption of a row piece or index entry. If RMAN detects logical corruption, then it logs the block in the alert log and server session trace file.

By default, RMAN does not check for logical corruption. If you specify `CHECK LOGICAL` on the `BACKUP` command, however, then RMAN tests data and index blocks for logical corruption, such as corruption of a row piece or index entry, and log them in the alert log located in the [Automatic Diagnostic Repository \(ADR\)](#). If you use RMAN with the following configuration when backing up or restoring files, then it detects all types of block corruption that are possible to detect:

- In the initialization parameter file of a database, set `DB_BLOCK_CHECKSUM=typical` so that the database calculates data file checksums automatically (not for backups, but for data files in use by the database)
- Do not precede the `BACKUP` command with `SET MAXCORRUPT` so that RMAN does not tolerate any unmarked block corruptions.
- In a `BACKUP` command, do *not* specify the `NOCHECKSUM` option so that RMAN calculates a checksum when writing backups
- In `BACKUP` and `RESTORE` commands, specify the `CHECK LOGICAL` option so that RMAN checks for logical and physical corruption

16.1.2.3 About Limits for Corrupt Blocks in RMAN Backups

You can use the `SET MAXCORRUPT` command to set the total number of unmarked corruptions permitted in a file for RMAN backups. The default is zero, meaning that RMAN does not tolerate unmarked corrupt blocks of any kind.

If the `MAXCORRUPT` limit is exceeded when RMAN encounters an unmarked corrupt block during a backup, then RMAN terminates the backup. Otherwise, RMAN writes the newly detected corrupt block to the backup with a special header indicating that the block is marked corrupt. You can use the `VALIDATE` command to determine which blocks are marked as corrupt and to find any unmarked corrupt blocks.

Because RMAN allows marked corrupt blocks in a backup, and because RMAN can be instructed to allow unmarked corrupt blocks to be marked as corrupt in the backup (when `MAXCORRUPT` is used), it is possible to restore a data file that has several blocks marked as corrupt. If you backup this restored data file (assuming no new corruptions have happened), even without `MAXCORRUPT` setting, the backup succeeds. This is because the previously marked corruptions do not stop RMAN from completing the backup.

See Also:

Oracle Database Backup and Recovery Reference for `SET MAXCORRUPT` syntax

16.1.2.4 About Detecting Block Corruption

Oracle Database supports different techniques for detecting, repairing, and monitoring block corruption.

The technique depends on whether the corruption is [interblock corruption](#) or [intrablock corruption](#). In intrablock corruption, the corruption occurs within the block itself. This corruption can be either physical or logical. In an interblock corruption, the corruption occurs between blocks and can only be logical.

For example, the `V$DATABASE_BLOCK_CORRUPTION` view records intrablock corruptions, while the [Automatic Diagnostic Repository \(ADR\)](#) tracks all types of corruptions. [Table 16-1](#) (page 16-4) summarizes how the database treats different types of block corruption.

Table 16-1 Detection, Repair, and Monitoring of Block Corruption

Response	Intrablock Corruption	Interblock Corruption
Detection	All database utilities detect intrablock corruption, including RMAN (for example, the <code>BACKUP</code> command) and the <code>DBVERIFY</code> utility. If a database process can encounter the <code>ORA-1578</code> error, then it can detect the corruption and monitor it.	Only <code>DBVERIFY</code> and the <code>ANALYZE</code> statement detect interblock corruption.
Tracking	The <code>V\$DATABASE_BLOCK_CORRUPTION</code> view displays blocks marked corrupt by Oracle Database components such as RMAN commands, <code>ANALYZE</code> , <code>SQL</code> queries, and so on. Any process that encounters an intrablock corruption records the block corruption in this view and in ADR.	The database monitors this type of block corruption in ADR.
Repair	Repair techniques include block media recovery , restoring data files, recovering with incremental backups, and block newing. Block media recovery can repair physical corruptions, but not logical corruptions. Any RMAN command that fixes or detects that a block is repaired updates <code>V\$DATABASE_BLOCK_CORRUPTION</code> . For example, RMAN updates the repository at end of successful block media recovery. If a <code>BACKUP</code> , <code>RESTORE</code> , or <code>VALIDATE</code> command detects that a block is no longer corrupted, then it removes the repaired block from the view.	You must fix interblock corruption using manual techniques such as dropping an object, rebuilding an index, and so on.

See Also:

- [Performing Complete Database Recovery](#) (page 17-1)
- [Performing Block Media Recovery](#) (page 19-1)
- *Oracle Database Administrator's Guide* to learn about ADR

16.2 Checking for Block Corruption with the VALIDATE Command

You can use the `VALIDATE` command to manually check for physical and logical corruptions in database files.

This command performs the same types of checks as `BACKUP VALIDATE`, but `VALIDATE` can check a larger selection of objects. For example, you can validate individual blocks with the `VALIDATE DATAFILE . . . BLOCK` command.

To specify a copy number for the backup piece being validated, run the `VALIDATE FROM COPY NUMBER` command.

When validating whole files, RMAN checks every block of the input files. If the backup validation discovers previously unmarked corrupt blocks, then RMAN updates the `V$DATABASE_BLOCK_CORRUPTION` view with rows describing the corruptions.

Use `VALIDATE BACKUPSET` when you suspect that one or more backup pieces in a backup set are missing or have been damaged. This command checks every block in a backup set to ensure that the backup can be restored. If RMAN finds block corruption, then it issues an error and terminates the validation. The command `VALIDATE BACKUPSET` enables you to choose which backups to check, whereas the `VALIDATE` option of the `RESTORE` command lets RMAN choose.

To use `VALIDATE` to check database files and backups:

1. Start RMAN and connect to a target database.

See Also:

["Making Database Connections with RMAN \(page 4-2\)"](#)

2. Execute the `VALIDATE` command with the desired options.

For example, to validate all data files and control files (and the server parameter file if one is in use), execute the following command at the RMAN prompt:

```
RMAN> VALIDATE DATABASE;
```

Alternatively, you can validate a particular backup set by using the form of the command shown in the following example (sample output included).

```
RMAN> VALIDATE BACKUPSET 22;

Starting validate at 17-AUG-13
using channel ORA_DISK_1
allocated channel: ORA_SBT_TAPE_1
channel ORA_SBT_TAPE_1: SID=89 device type=SBT_TAPE
channel ORA_SBT_TAPE_1: Oracle Secure Backup
channel ORA_DISK_1: starting validation of datafile backup set
channel ORA_DISK_1: reading from backup piece
/disk1/oracle/work/orcva/RDBMS/backupset/2013_08_16/o1_mf_nnndf_
TAG20130816T153034_2g774bt2_.bkp
channel ORA_DISK_1: piece
handle=/disk1/oracle/work/orcva/RDBMS/backupset/2013_08_16/o1_mf_nnndf_
TAG20130816T153034_2g774bt2_.bkp tag=TAG20130816T153034
channel ORA_DISK_1: restored backup piece 1
channel ORA_DISK_1: validation complete, elapsed time: 00:00:01
Finished validate at 17-AUG-13
```

The following example illustrates how you can check individual data blocks within a data file for corruption.

```
RMAN> VALIDATE DATAFILE 1 BLOCK 10;

Starting validate at 17-AUG-13
using channel ORA_DISK_1
channel ORA_DISK_1: starting validation of datafile
channel ORA_DISK_1: specifying datafile(s) for validation
input datafile file number=00001 name=/disk1/oracle/dbs/tbs_01.f
channel ORA_DISK_1: validation complete, elapsed time: 00:00:01
List of Datafiles
=====
File Status Marked Corrupt Empty Blocks Blocks Examined High SCN
-----
1 OK 0 2 127 481907
```

```
File Name: /disk1/oracle/dbs/tbs_01.f
Block Type Blocks Failing Blocks Processed
-----
Data      0          36
Index     0          31
Other     0          58
```

Finished validate at 17-AUG-13

Make Parallel the Validation of a Data File

If you must validate a large data file, then RMAN can make the work parallel by dividing the file into sections and processing each [file section](#) in parallel. If multiple channels are configured or allocated, and if you want the channels to make parallel the validation, then specify the `SECTION SIZE` parameter of the `VALIDATE` command.

If you specify a section size that is larger than the size of the file, then RMAN does not create file sections. If you specify a small section size that would produce more than 256 sections, then RMAN increases the section size to a value that results in exactly 256 sections.

To make parallel the validation of a data file:

1. Start RMAN and connect to a target database. The target database must be mounted or open.
2. Run `VALIDATE` with the `SECTION SIZE` parameter.

The following example allocates two channels and validates a large data file. The section size is 1200 MB.

```
RUN
{
  ALLOCATE CHANNEL c1 DEVICE TYPE DISK;
  ALLOCATE CHANNEL c2 DEVICE TYPE DISK;
  VALIDATE DATAFILE 1 SECTION SIZE 1200M;
}
```

See Also:

- ["Dividing the Backup of a Large Data File into Sections \(page 10-3\)"](#)
 - *Oracle Database Backup and Recovery Reference* to learn about the `VALIDATE` command
-

16.3 Validating Database Files with BACKUP VALIDATE

You can also use the `BACKUP VALIDATE` command to perform validation.

This command can perform the following tasks:

- Check data files for physical and logical block corruption
- Confirm that all database files exist and are in the correct locations

When you run `BACKUP VALIDATE`, RMAN reads the files to be backed up in their entirety, as it does during a real backup. RMAN does not, however, actually produce any backup sets or image copies.

You cannot use the `BACKUPSET`, `MAXCORRUPT`, or `PROXY` parameters with `BACKUP VALIDATE`. To validate specific backup sets, run the `VALIDATE` command.

To validate files with the `BACKUP VALIDATE` command:

1. Start RMAN and connect to a target database and recovery catalog (if used).
2. Run the `BACKUP VALIDATE` command.

For example, you can validate that all database files and archived logs can be backed up by running a command as shown in the following example. This command checks for physical corruptions only.

```
BACKUP VALIDATE
  DATABASE
  ARCHIVELOG ALL;
```

To check for logical corruptions in addition to physical corruptions, run the following variation of the preceding command:

```
BACKUP VALIDATE
  CHECK LOGICAL
  DATABASE
  ARCHIVELOG ALL;
```

In the preceding examples, the RMAN client displays the same output as when really backing up the files. If RMAN cannot back up one or more of the files, then it issues an error message. For example, RMAN may show output similar to the following:

```
RMAN-00571: =====
RMAN-00569: ===== ERROR MESSAGE STACK FOLLOWS =====
RMAN-00571: =====
RMAN-03002: failure of backup command at 08/29/2013 14:33:47
ORA-19625: error identifying file /oracle/oradata/trgt/arch/archive1_6.dbf
ORA-27037: unable to obtain file status
SVR4 Error: 2: No such file or directory
Additional information: 3
```

See Also:

- *Oracle Database Backup and Recovery Reference* for `BACKUP` syntax
 - [Performing Block Media Recovery](#) (page 19-1) to learn how to repair corrupt blocks discovered by `BACKUP VALIDATE`
-

16.4 Validating Backups Before Restoring Them

You can run `RESTORE . . . VALIDATE` to test whether RMAN can restore a specific file or set of files from a backup. RMAN chooses which backups to use.

The database must be mounted or open for this command. You do not have to take data files offline when validating the restore of data files, because validation of backups of the data files only reads the backups and does not affect the production data files.

When validating files on disk or tape, RMAN reads all blocks in the backup piece or image copy. RMAN also validates offsite backups. The validation is identical to a real restore operation except that RMAN does not write output files.

RMAN also allows to specify a copy number for the backup pieces being validated.

Note:

As an additional test measure, you can perform a [trial recovery](#) with the `RECOVER . . . TEST` command. A trial recovery applies redo in a way similar to normal recovery, but it is in memory only and it rolls back its changes after the trial.

To validate backups with the RESTORE command:

1. Run the `RESTORE` command with the `VALIDATE` option.

This following example illustrates validating the restore of the database and all archived redo logs:

```
RESTORE DATABASE VALIDATE;  
RESTORE ARCHIVELOG ALL VALIDATE;
```

If you do *not* see an RMAN error stack, then skip the subsequent steps. The lack of error messages means that RMAN had confirmed that it can use these backups successfully during a real restore and recovery.

2. If you see error messages in the output and the `RMAN-06026` message, then investigate the cause of the problem. If possible, correct the problem that is preventing RMAN from validating the backups and retry the validation.

The following error means that RMAN cannot restore one or more of the specified files from your available backups:

```
RMAN-06026: some targets not found - aborting restore
```

The following sample output shows that RMAN encountered a problem reading the specified backup:

```
RMAN-03009: failure of restore command on c1 channel at 12-DEC-12 23:22:30  
ORA-19505: failed to identify file "oracle/dbs/1fafv9gl_1_1"  
ORA-27037: unable to obtain file status  
SVR4 Error: 2: No such file or directory  
Additional information: 3
```

See Also:

Oracle Database Backup and Recovery Reference to learn about the `RESTORE . . . VALIDATE` command

16.5 Validating CDBs and PDBs

RMAN enables you to validate multitenant container databases (CDBs) and pluggable databases (PDBs) using the `VALIDATE` command.

You can also choose to specify a copy number for the backup pieces being validated for both CDBs and PDBs.

All of the procedures in this chapter apply to CDBs, with the differences described in the following sections:

- [Validating a Whole CDB](#) (page 16-9)
- [Validating PDBs](#) (page 16-9)

16.5.1 Validating a Whole CDB

The steps to validate a CDB are similar to the ones used to validate a non-CDB.

The only difference is that you must connect to the [root](#) as a [common user](#) with the common SYSBACKUP or SYSDBA privilege. Then, use the `VALIDATE DATABASE` and `RESTORE DATABASE VALIDATE` commands.

See Also:

["Making RMAN Connections to a CDB](#) (page 4-7)"

The following command, when connected to the root, validates the whole CDB:

```
VALIDATE DATABASE;
```

The following command validates the root:

```
VALIDATE DATABASE ROOT;
```

16.5.2 Validating PDBs

There are multiple methods to validate PDBs.

Use one of the following techniques to validate PDBs:

- Connect to the root and use the `VALIDATE PLUGGABLE DATABASE` or `RESTORE PLUGGABLE DATABASE VALIDATE` command. This enables you to validate one or more PDBs.

The following command, when connected to the root, validates the PDBs `hr_pdb` and `sales_pdb`.

```
VALIDATE PLUGGABLE DATABASE hr_pdb, sales_pdb;
```

- Connect to the PDB and use the `VALIDATE DATABASE` and `RESTORE DATABASE VALIDATE` commands to validate only one PDB. The commands used here are the same commands that you would use for a non-CDB.

The following command, when connected to a PDB, validates the restore of the database.

```
RESTORE DATABASE VALIDATE;
```

See Also:

["Making RMAN Connections to a CDB](#) (page 4-7)"

Performing Complete Database Recovery

This chapter explains how to use RMAN to return your database to normal operation after the loss of one or more data files. This chapter contains the following topics:

- [Overview of Complete Database Recovery](#) (page 17-1)
- [Preparing for Complete Database Recovery](#) (page 17-3)
- [Performing Complete Database Recovery](#) (page 17-12)
- [Performing Complete Recovery of CDBs](#) (page 17-20)
- [Performing Complete Recovery of Application Containers](#) (page 17-29)
- [Performing Complete Recovery of Sparse Databases with RMAN](#) (page 17-32)

17.1 Overview of Complete Database Recovery

This section explains the purpose of complete restore and recovery of the database and specifies the scope of the chapter.

This section contains the following topics:

- [Purpose of Complete Database Recovery](#) (page 17-1)
- [Scope of This Chapter](#) (page 17-1)
- [About Real-Time Redo Transport for Recovery Appliance](#) (page 17-2)

17.1.1 Purpose of Complete Database Recovery

This chapter assumes that some or all of your data files are lost or damaged. Typically, this situation is caused by a media failure or accidental deletion. Your goal is to return the database to normal operation by restoring the damaged files from RMAN backups and recovering all database changes.

17.1.2 Scope of This Chapter

This chapter explains how to use complete recovery to fix the most common database problems. This chapter makes the following assumptions:

- You have lost some or all data files and your goal is to recover all changes, but you have not lost all current control files or an entire online redo log group.
- Your database is using the current server parameter file.
- You have the complete set of archived redo logs and incremental backups needed for recovery of your data file backups. Every data file either has a backup, or a

complete set of online and archived redo logs goes back to the creation of a data file with no backup.

RMAN can handle lost data files without user intervention during restore and recovery. When a data file is lost, the possible cases can be classified as follows:

- The control file knows about the data file, that is, you backed up the control file after data file creation, but the data file itself is not backed up. If the data file record is in the control file, then `RESTORE` creates the data file in the original location or in a user-specified location. The `RECOVER` command can then apply the necessary logs to the data file.
 - The control file does not have the data file record, that is, you did not back up the control file after data file creation. During recovery, the database detects the missing data file and reports it to RMAN, which creates a data file and continues recovery by applying the remaining logs. If the data file was created in a parent incarnation, then it is created during the restore or recovery phase as appropriate.
- You are not restoring and recovering an encrypted tablespace.
If you perform media recovery on an encrypted tablespace, then the Oracle keystore must be open when performing media recovery of this tablespace.
 - Your database runs in a single-instance configuration.
Although RMAN can restore and recover databases in Oracle RAC and Data Guard configurations, these scenarios are beyond the scope of this manual.
 - You are using the RMAN client rather than Oracle Enterprise Manager.

See Also:

- "[Performing Flashback and Database Point-in-Time Recovery](#) (page 18-1)" for information about recovering some but not all database changes
 - "[Performing Recovery with a Backup Control File](#) (page 20-4)" for information about recovering the database when all control files are lost
 - "[Restoring the Server Parameter File](#) (page 20-2)" for information about restoring a backup server parameter file
 - *Oracle Database Administrator's Guide* to learn about encrypted tablespaces.
 - *Oracle Real Application Clusters Administration and Deployment Guide* for more information about using RMAN with Oracle RAC
 - *Oracle Data Guard Concepts and Administration* for more information about using RMAN with Data Guard
-
-

17.1.3 About Real-Time Redo Transport for Recovery Appliance

With [Zero Data Loss Recovery Appliance \(Recovery Appliance\)](#), the window of potential data loss that exists between successive archived log backups can be substantially reduced. Real-time redo transport enables you to recover target databases up to within a few seconds of a database failure.

Note:

Real-time redo transport can be used only with Recovery Appliance.

When real-time redo transport is configured for a target database, redo data from the current redo log groups is written asynchronously to Recovery Appliance as it is generated. As the redo stream is received, it is stored as a complete RMAN archived redo log. If the target database crashes, the redo data received from the current redo log group, until the time of the crash, is used during restore and recovery operations.

You must perform certain configuration steps to enable real-time redo transport for the target database.

See Also:

Zero Data Loss Recovery Appliance Protected Database Configuration Guide for the steps to configure real-time redo transport

17.2 Preparing for Complete Database Recovery

Although RMAN simplifies most database restore and recovery tasks, you must still plan your database restore and recovery strategy based on which database files have been lost and your recovery goal. This section contains the following topics:

- [Identifying the Database Files to Restore or Recover](#) (page 17-3)
- [Determining the DBID of the Database](#) (page 17-6)
- [Previewing Backups Used in Restore Operations](#) (page 17-7)
- [Validating Backups Before Restoring Them](#) (page 17-9)
- [Restoring Archived Redo Logs Needed for Recovery](#) (page 17-9)
- [Providing the Password Required to Decrypt Encrypted Backups](#) (page 17-11)

17.2.1 Identifying the Database Files to Restore or Recover

The techniques for determining which files require restore or recovery depend upon the type of file that is lost.

This section contains the following topics:

- [Identifying a Lost Control File](#) (page 17-3)
- [Identifying Data Files Requiring Media Recovery](#) (page 17-4)

17.2.1.1 Identifying a Lost Control File

It is usually obvious when the control file of your database is lost. The database shuts down immediately when any of the multiplexed control files become inaccessible. Also, the database reports an error if you try to start it without a valid control file at each location specified in the `CONTROL_FILES` initialization parameter.

Loss of some but not all copies of your control file does not require you to restore a control file from backup. If at least one control file remains intact, then you can either copy an intact copy of the control file over the damaged or missing control file, or

update the initialization parameter file so that it does not refer to the damaged or missing control file. After the CONTROL_FILES parameter references only present, intact copies of the control file, you can restart your database.

If you restore the control file from backup, then you must perform media recovery of the whole database and then open it with the OPEN RESETLOGS option, even if no data files must be restored. This technique is described in "[Performing Recovery with a Backup Control File](#) (page 20-4)".

17.2.1.2 Identifying Data Files Requiring Media Recovery

The decision about when and how to recover depends on the state of the database and the location of its data files.

Use RMAN or SQL*Plus to identify data files that require media recovery.

See Also:

- [Identifying Data Files with RMAN](#) (page 17-4)
 - [Identifying Data Files with SQL](#) (page 17-5)
-
-

17.2.1.2.1 Identifying Data Files with RMAN

An easy technique for determining which data files are missing is to run a VALIDATE DATABASE command, which attempts to read all specified data files. [Example 17-1](#) (page 17-4) validates the database (sample output included).

Example 17-1 VALIDATE DATABASE

```
RMAN> VALIDATE DATABASE;

Starting validate at 20-OCT-13
allocated channel: ORA_DISK_1
channel ORA_DISK_1: SID=90 device type=DISK
could not read file header for datafile 7 error reason 4
RMAN-00571: =====
RMAN-00569: ===== ERROR MESSAGE STACK FOLLOWS =====
RMAN-00571: =====
RMAN-03002: failure of backup command at 10/20/2013 13:05:43
RMAN-06056: could not access datafile 7
```

The output of [Example 17-1](#) (page 17-4) indicates that data file 7 is inaccessible. You can then run the REPORT SCHEMA command to obtain the tablespace name and file name for data file 7 as follows (sample output included):

```
RMAN> REPORT SCHEMA;

Report of database schema for database with db_unique_name RDBMS

List of Permanent Datafiles
=====
File Size(MB) Tablespace          RB segs Datafile Name
-----
1      450      SYSTEM                ***      +DATAFILE/tbs_01.f
2       86      SYSAUX                ***      +DATAFILE/tbs_ax1.f
3       15      UD1                   ***      +DATAFILE/tbs_undol.f
4        2      SYSTEM                ***      +DATAFILE/tbs_02.f
5        2      TBS_1                 ***      +DATAFILE/tbs_11.f
6        2      TBS_1                 ***      +DATAFILE/tbs_12.f
```

```
7 2 TBS_2 *** +DATAFILE/tbs_21.f
```

List of Temporary Files

=====

File	Size(MB)	Tablespace	Maxsize(MB)	Tempfile Name
1	40	TEMP	32767	+DATAFILE/tbs_tmpl.f

17.2.1.2.2 Identifying Data Files with SQL

Although `VALIDATE DATABASE` is a good technique for determining whether files are inaccessible, you may want to use SQL queries to obtain more detailed information.

To determine whether data files require media recovery:

1. Start SQL*Plus and connect to the target database instance with administrator privileges.
2. Determine the status of the database by executing the following SQL query:

```
SELECT STATUS FROM V$INSTANCE;
```

If the status is `OPEN`, then the database is open. Nevertheless, some data files may require media recovery.

3. Query `V$DATAFILE_HEADER` to determine the status of your data files. Run the following SQL statements to check the data file headers:

```
SELECT FILE#, STATUS, ERROR, RECOVER, TABLESPACE_NAME, NAME
FROM V$DATAFILE_HEADER
WHERE RECOVER = 'YES'
OR (RECOVER IS NULL AND ERROR IS NOT NULL);
```

Each row returned represents a data file that either requires media recovery or has an error requiring a restore. Check the `RECOVER` and `ERROR` columns. `RECOVER` indicates whether a file needs media recovery, and `ERROR` indicates whether there was an error reading and validating the data file header.

If `ERROR` is not `NULL`, then the data file header cannot be read and validated. Check for a temporary hardware or operating system problem causing the error. If there is no such problem, then you must restore the file or switch to a copy.

If the `ERROR` column is `NULL` and the `RECOVER` column is `YES`, then the file requires media recovery (and may also require a restore from backup).

Note:

Because `V$DATAFILE_HEADER` only reads the header block of each data file, it does not detect all problems that require the data file to be restored. For example, this view cannot tell whether a data file contains corrupt data blocks.

4. Optionally, query `V$RECOVER_FILE` to list data files requiring recovery by data file number with their status and error information. For example, execute the following query:

```
SELECT FILE#, ERROR, ONLINE_STATUS, CHANGE#, TIME
FROM V$RECOVER_FILE;
```

Note:

You cannot use V\$RECOVER_FILE with a control file restored from backup or a control file that was re-created after the time of the media failure affecting the data files. A restored or re-created control file does not contain the information needed to update V\$RECOVER_FILE accurately.

To find data file and tablespace names, you can also perform joins using the data file number and the V\$DATAFILE and V\$TABLESPACE views, as shown in the following example.

```
SELECT r.FILE# AS df#, d.NAME AS df_name, t.NAME AS tbsp_name,
       d.STATUS, r.ERROR, r.CHANGE#, r.TIME
FROM V$RECOVER_FILE r, V$DATAFILE d, V$TABLESPACE t
WHERE t.TS# = d.TS#
AND d.FILE# = r.FILE#;
```

The ERROR column identifies the problem for each file requiring recovery.

See Also:

- V\$DATAFILE_HEADER in *Oracle Database Reference*
 - V\$RECOVER_FILE in *Oracle Database Reference*
 - V\$DATAFILE in *Oracle Database Reference*
 - V\$TABLESPACE in *Oracle Database Reference*
-
-

17.2.2 Determining the DBID of the Database

In situations requiring the recovery of your server parameter file or control file from autobackup, you must know the DBID. Be sure to record the DBID along with other basic information about your database.

If you do not have a record of the DBID of your database, then you can find it in the following places without opening your database:

- The DBID is used in forming the file name for the control file autobackup. Locate this file, and then refer to "[Configuring the Control File Autobackup Format](#) (page 5-8)" to determine where the DBID appears in the file name.
- If you have any text files that preserve the output from an RMAN session, then the DBID is displayed by the RMAN client when it starts up and connects to your database. Typical output follows:

```
% rman TARGET /

Recovery Manager: Release 12.1.0.1.0 - Production on Wed Jan 16 17:51:30 2013

Copyright (c) 1982, 2013, Oracle and/or its affiliates. All rights reserved.

connected to target database: PROD (DBID=36508508)
```

17.2.3 Previewing Backups Used in Restore Operations

You can apply `RESTORE . . . PREVIEW` to any `RESTORE` operation to create a detailed list of every backup to be used in the requested `RESTORE` operation, and the necessary target SCN for recovery after the `RESTORE` operation is complete. This command accesses the RMAN repository to query the backup metadata, but does not actually read the backup files to ensure that they can be restored.

As an alternative to `RESTORE . . . PREVIEW`, you can use the `RESTORE . . . VALIDATE HEADER` command. In addition to listing the files needed for restore and recovery, the `RESTORE . . . VALIDATE HEADER` command validates the backup file headers to determine whether the files on disk or in the media management catalog correspond to the metadata in the RMAN repository.

When planning your restore and recovery operation, use `RESTORE . . . PREVIEW` or `RESTORE . . . VALIDATE HEADER` to ensure that all required backups are available or to identify situations in which you may want to direct RMAN to use or avoid specific backups.

To preview backups to be used in a restore operation:

1. Run a `RESTORE` command with the `PREVIEW` option.

For example, run one of the following commands:

```
RESTORE DATABASE PREVIEW;
RESTORE ARCHIVELOG FROM TIME 'SYSDATE-7' PREVIEW;
```

If the report produced by `RESTORE . . . PREVIEW` provides too much information, then specify the `SUMMARY` option as shown in the following example:

```
RESTORE DATABASE PREVIEW SUMMARY;
```

If you are satisfied with the output, then stop here. If the output indicates that RMAN will request a backup from a tape that you know is temporarily unavailable, then continue with this procedure. If the output indicates that a backup is stored off-site, then skip to "[Recalling Off-site Backups](#) (page 17-8)".

2. If needed, use the `CHANGE` command to set the backup status of any temporarily unavailable backups to `UNAVAILABLE`.

"[Updating a Backup to Status AVAILABLE or UNAVAILABLE](#) (page 12-15)" explains how to perform this task.

3. Optionally, run `RESTORE . . . PREVIEW` again to confirm that the restore operation does not attempt to use unavailable backups.

See Also:

Oracle Database Backup and Recovery Reference for details on interpreting `RESTORE . . . PREVIEW` output, which is in the same format as the output of the `LIST` command

17.2.3.1 Recalling Off-site Backups

Some media managers provide status information to RMAN about which backups are off-site. An **offsite backup** is stored in a remote location, such as a secure storage facility, and cannot be restored unless the media manager retrieves the media.

Off-site backups are marked as `AVAILABLE` in the RMAN repository even though the media must be retrieved from storage before the backup can be restored. If RMAN attempts to restore an off-site backup, then the restore job fails.

To recall offsite backups:

1. (Optional) Identify the off-site backups using the `RESTORE . . . PREVIEW` command. The command output indicates whether backups are stored off-site, as shown by the text after the sample output in the following example.

```
List of Backup Sets
=====
```

```

BS Key   Size       Device Type Elapsed Time Completion Time
-----
9        2.25M      SBT_TAPE    00:00:00    21-MAY-13
BP Key: 9   Status: AVAILABLE Compressed: NO   Tag: TAG20130521T144258
Handle: 0aii9k7i_1_1  Media: 0aii9k7i_1_1

```

```
List of Archived Logs in backup set 9
```

```

Thrd Seq     Low SCN     Low Time    Next SCN    Next Time
-----
1     1         392314     21-MAY-13  392541     21-MAY-13
1     2         392541     21-MAY-13  392545     21-MAY-13
1     3         392545     21-MAY-13  392548     21-MAY-13
1     4         392548     21-MAY-13  395066     21-MAY-13
1     5         395066     21-MAY-13  395095     21-MAY-13
1     6         395095     21-MAY-13  395355     21-MAY-13

```

```
List of remote backup files
```

```

=====
Handle: aii9k7i_1_1  Media: 0aii9k7i_1_1
validation succeeded for backup piece
Finished restore at 21-MAY-13
released channel: dev1

```

You can use `RESTORE . . . PREVIEW RECALL` to instruct the media manager to make off-site backups available.

2. If backups are stored offsite, then execute a `RESTORE . . . PREVIEW` command with the `RECALL` option.

The following example initiates recall for the off-site archived log backups shown in the previous step (sample output included):

```
RESTORE ARCHIVELOG ALL PREVIEW RECALL;
```

The following sample output indicates that RMAN initiated a recall:

```
List of Backup Sets
=====
```

```

BS Key  Size      Device Type Elapsed Time Completion Time
-----
9       2.25M      SBT_TAPE    00:00:00    21-MAY-13
BP Key: 9   Status: AVAILABLE Compressed: NO Tag: TAG20130521T144258
Handle: VAULT0aii9k7i_1_1 Media: /tmp,VAULT0aii9k7i_1_1

```

List of Archived Logs in backup set 9

Thrd	Seq	Low SCN	Low Time	Next SCN	Next Time
1	1	392314	21-MAY-13	392541	21-MAY-13
1	2	392541	21-MAY-13	392545	21-MAY-13
1	3	392545	21-MAY-13	392548	21-MAY-13
1	4	392548	21-MAY-13	395066	21-MAY-13
1	5	395066	21-MAY-13	395095	21-MAY-13
1	6	395095	21-MAY-13	395355	21-MAY-13

Initiated recall for the following list of remote backup files

```

=====
Handle: VAULT0aii9k7i_1_1 Media: /tmp,VAULT0aii9k7i_1_1
validation succeeded for backup piece
Finished restore at 21-MAY-13
released channel: dev1

```

3. Run the RESTORE . . . PREVIEW command. If necessary, return to the previous step until no backups needed for the restore operation are reported as off-site.

17.2.4 Validating Backups Before Restoring Them

Although the procedures in "[Previewing Backups Used in Restore Operations](#) (page 17-7)" indicate which backups will be restored, they do not verify that the backups are actually usable. You can run RMAN commands to test the availability of usable backups for any RESTORE operation, or test the contents of a specific backup for use in RESTORE operations. The contents of the backups are actually read and checked for corruption. You have the following validation options:

- RESTORE . . . VALIDATE tests whether RMAN can restore a specific object from a backup. RMAN chooses which backups to use.
- VALIDATE BACKUPSET tests the validity of a backup set that you specify.

See Also:

[Validating Database Files and Backups](#) (page 16-1)

17.2.5 Restoring Archived Redo Logs Needed for Recovery

RMAN restores archived redo log files from backup automatically as needed to perform recovery. You can also restore archived redo logs manually to save the time needed to restore these files later during the RECOVER command, or if you want to store the restored archived redo log files in some new location. RMAN also gives you the flexibility of restoring all archive redo log files, the current ones, or archive redo log files from a specified previous incarnation of the database.

In case of missing archived redo logs during disaster recovery, RMAN enables you to automate the database recovery till the last available archived redo log, using the UNTIL AVAILABLE REDO option. You can use this option only when performing recovery for a whole database. Using this option for a data file, tablespace, or

pluggable database is not supported. To perform point-in-time recovery for a pluggable database, you must provide the SCN number as the point of recovery.

By default, RMAN restores archived redo logs with names constructed using the `LOG_ARCHIVE_FORMAT` and the highest `LOG_ARCHIVE_DEST_n` parameters of the target database. These parameters are combined in a platform-specific fashion to form the name of the restored archived log.

This section contains the following topics:

- [Restoring Archived Redo Logs to a New Location](#) (page 17-10)
- [Restoring Archived Redo Logs to Multiple Locations](#) (page 17-11)

17.2.5.1 Restoring Archived Redo Logs to a New Location

You can override the default location for restored archived redo logs with the `SET ARCHIVELOG DESTINATION` command. This command manually stages archived logs to different locations while a database restore operation is occurring. During recovery, RMAN knows where to find the newly restored archived logs; it does not require them to be in the location specified in the initialization parameter file.

To restore archived redo logs to a new location:

1. Start RMAN and connect to a target database.

See Also:

["Making Database Connections with RMAN \(page 4-2\)"](#)

2. Ensure that the database is mounted or open.
3. Perform the following operations within a `RUN` command:
 - a. Specify the new location for the restored archived redo logs using `SET ARCHIVELOG DESTINATION`.
 - b. Either explicitly restore the archived redo logs or execute commands that automatically restore the logs.

The following sample `RUN` command explicitly restores all backup archived logs to a new location:

```
RUN
{
  SET ARCHIVELOG DESTINATION TO '/oracle/temp_restore';
  RESTORE ARCHIVELOG ALL;
  # restore and recover data files as needed
  .
  .
  .
}
```

The following example sets the archived log destination and then uses `RECOVER DATABASE` to restore archived logs from this destination automatically:

```
RUN
{
  SET ARCHIVELOG DESTINATION TO '/oracle/temp_restore';
  RESTORE DATABASE;
```

```

    RECOVER DATABASE; # restores and recovers logs automatically
  }

```

17.2.5.2 Restoring Archived Redo Logs to Multiple Locations

You can specify restore destinations for archived logs multiple times in one **RUN block**, to distribute restored logs among several destinations. (You cannot, however specify multiple destinations simultaneously to produce multiple copies of the same log during the restore operation.) You can use this feature to manage disk space used to contain the restored logs.

This example restores 300 archived redo logs from backup, distributing them across the directories `/fs1/tmp`, `/fs2/tmp`, and `/fs3/tmp`:

```

RUN
{
  # Set a new location for logs 1 through 100.
  SET ARCHIVELOG DESTINATION TO '/fs1/tmp';
  RESTORE ARCHIVELOG FROM SEQUENCE 1 UNTIL SEQUENCE 100;
  # Set a new location for logs 101 through 200.
  SET ARCHIVELOG DESTINATION TO '/fs2/tmp';
  RESTORE ARCHIVELOG FROM SEQUENCE 101 UNTIL SEQUENCE 200;
  # Set a new location for logs 201 through 300.
  SET ARCHIVELOG DESTINATION TO '/fs3/tmp';
  RESTORE ARCHIVELOG FROM SEQUENCE 201 UNTIL SEQUENCE 300;
  # restore and recover data files as needed
  .
  .
  .
}

```

When you issue a `RECOVER` command, RMAN finds the needed restored archived logs automatically across the destinations to which they were restored, and applies them to the data files.

17.2.6 Providing the Password Required to Decrypt Encrypted Backups

If backups are encrypted, then RMAN decrypts these backups while restoring their contents. Depending on the encryption mode used to create encrypted backups, you may need to perform additional steps before restoring these encrypted backups.

Backups that were encrypted using transparent encryption with an auto-login keystore require no intervention to restore, if the keystore is available. For backups encrypted with a password-based software keystore, in addition to requiring the keystore to be available, the keystore password to be provided. The keystore password is used to open the keystore and must be provided before the restore operation is performed. Use the `SET` command with the `DECRYPTION WALLET OPEN IDENTIFIED BY` option to specify the password that must be used to open the keystore.

The following command sets the keystore password for a password-based software keystore (where *password* is a placeholder for the actual password that you enter):

```
SET DECRYPTION WALLET OPEN IDENTIFIED BY password;
```

Backups created using password-mode encryption require the correct password to be entered before they can be restored. Use the `SET DECRYPTION` command to specify the password used to decrypt the backups. If you are restoring from a group of backups that were created with different passwords, then specify all of the required passwords on the `SET DECRYPTION` command. RMAN automatically uses the correct

password with each backup set. The SET command must be used before executing the RESTORE and RECOVER commands.

The following command sets the password used to decrypt backups (where *password* is a placeholder for the actual password that you enter):

```
SET DECRYPTION IDENTIFIED BY password;
```

See Also:

Oracle Database Backup and Recovery Reference for additional information about performing restore operations using encrypted backups

17.3 Performing Complete Database Recovery

During complete recovery RMAN restores one or more data files and then applies all the redo generated after the restored backup.

This section describes the basic outline of complete database recovery, which is intended to encompass a wide range of different scenarios.

This section contains the following topics:

- [About Complete Database Recovery](#) (page 17-12)
- [Performing Complete Recovery of the Whole Database](#) (page 17-13)
- [Performing Complete Recovery of a Tablespace](#) (page 17-16)
- [Performing Complete Recovery After Switching to a Copy](#) (page 17-18)

17.3.1 About Complete Database Recovery

You use the RESTORE and RECOVER commands to restore and recover the database. During the recovery, RMAN automatically restores backups of any needed archived redo logs. If backups are stored on a media manager, then channels must be configured in advance or a RUN block with ALLOCATE CHANNEL commands must be used to enable access to backups stored there.

If RMAN restores archived redo logs to the fast recovery area during a recovery, then it automatically deletes the restored logs after applying them to the data files. Otherwise, you can use the DELETE ARCHIVELOG command to delete restored archived redo logs from disk when they are no longer needed for recovery. For example, you can enter the following command:

```
RECOVER DATABASE DELETE ARCHIVELOG;
```

17.3.1.1 About Restoring Data Files to a Nondefault Location

If you cannot restore data files to their default locations, then you must update the control file to reflect the new locations of the data files. Use the RMAN SET NEWNAME command within a RUN command to specify the new file name. Afterward, use a SWITCH command, which is equivalent to using the SQL statement ALTER DATABASE RENAME FILE, to update the names of the data files in the control file. SWITCH DATAFILE ALL updates the control file to reflect the new names for all data files for which a SET NEWNAME has been issued in a RUN command.

See Also:

Oracle Database Backup and Recovery Reference for SWITCH syntax

17.3.2 Performing Complete Recovery of the Whole Database

This scenario assumes that database `trgt` has lost most or all of its data files. It also assumes that the database uses a fast recovery area.

After restore and recovery of a whole database, when the database is open, missing temporary tablespaces that were recorded in the control file are re-created with their previous creation size, `AUTOEXTEND`, and `MAXSIZE` attributes. Only temporary tablespaces that are missing are re-created. If a temp file exists at the location recorded in the RMAN repository but has an invalid header, then RMAN does not re-create the temp file.

If the temp files were created as Oracle-managed files, then they are re-created in the current `DB_CREATE_FILE_DEST` location. Otherwise, they are re-created at their previous locations. If RMAN cannot re-create the file due to an I/O error or some other cause, then the error is reported in the alert log and the database open operation continues.

See Also:

[Scope of This Chapter](#) (page 17-1) for some of the assumptions used in the recovery procedures

To restore and recover the whole database:

1. Complete the preparation steps required for your scenario as described in "[Preparing for Complete Database Recovery](#) (page 17-3)".
2. Start RMAN and connect to a target database as described in "[Making Database Connections with RMAN](#) (page 4-2)".

RMAN displays the database status when it connects: `not started`, `not mounted`, `not open` (when the database is mounted but not open), or `none` (when the database is open).

3. If the database is not mounted, then mount but do not open the database.

For example, enter the following command:

```
STARTUP MOUNT;
```

4. Use the `SHOW` command to see which channels are preconfigured.

For example, enter the following command (sample output is included):

```
SHOW ALL;
```

```
RMAN configuration parameters for database with db_unique_name PROD1 are:
```

```
.  
.
.
```

```
CONFIGURE DEFAULT DEVICE TYPE TO DISK; # default
```

```
CONFIGURE DEVICE TYPE DISK PARALLELISM 1 BACKUP TYPE TO BACKUPSET; # default
```

```
CONFIGURE DEVICE TYPE SBT_TAPE PARALLELISM 1 BACKUP TYPE TO BACKUPSET; # default
CONFIGURE CHANNEL DEVICE TYPE 'SBT_TAPE' PARMS "SBT_
LIBRARY=/usr/local/oracle/backup/lib/libobk.so";
```

If the necessary devices and channels are configured, then no action is necessary. Otherwise, you can use the `CONFIGURE` command to configure automatic channels, or include `ALLOCATE CHANNEL` commands within a `RUN` block.

5. If you are restoring password-protected encrypted backups, then specify the password.

Use the `SET DECRYPTION IDENTIFIED BY` command to specify a password for password-protected backups, as shown in the following example (where *password* represents the actual password that you enter):

```
SET DECRYPTION IDENTIFIED BY password;
```

If you created backups with different passwords, then you can run the `SET DECRYPTION IDENTIFIED BY password` command multiple times, specifying all of the possible passwords that might be required to restore the backups.

6. Restore and recover the database. Do one of the following:

- If you are restoring all data files to their original locations, then execute `RESTORE DATABASE` and `RECOVER DATABASE` sequentially at the `RMAN` prompt.

For example, enter the following commands if automatic channels are configured (sample output included):

```
RMAN> RESTORE DATABASE;

Starting restore at 20-JUN-13
allocated channel: ORA_DISK_1
channel ORA_DISK_1: SID=35 device type=DISK
allocated channel: ORA_SBT_TAPE_1
channel ORA_SBT_TAPE_1: SID=34 device type=SBT_TAPE
channel ORA_SBT_TAPE_1: Oracle Secure Backup

channel ORA_DISK_1: starting datafile backup set restore
channel ORA_DISK_1: specifying datafile(s) to restore from backup set
channel ORA_DISK_1: restoring datafile 00001 to /disk1/oracle/dbs/tbs_01.f
channel ORA_DISK_1: restoring datafile 00002 to /disk1/oracle/dbs/tbs_ax1.f
.
.
.
Finished restore at 20-JUN-13

RMAN> RECOVER DATABASE;

Starting recover at 20-JUN-13
using channel ORA_DISK_1
allocated channel: ORA_SBT_TAPE_1
channel ORA_SBT_TAPE_1: SID=34 device type=SBT_TAPE
channel ORA_SBT_TAPE_1: Oracle Secure Backup

starting media recovery

channel ORA_DISK_1: starting archived log restore to default destination
channel ORA_DISK_1: restoring archived log
archived log thread=1 sequence=5
```



```

channel ORA_DISK_1: restoring archived log
archived log thread=1 sequence=6
.
.
channel ORA_DISK_1: reading from backup piece
/disk1/oracle/work/orcva/TKRM/backupset/2013_06_20/ol_mf_annnn_
TAG20130620T113128_29jhr197_.bkp
channel ORA_DISK_1: piece
handle=/disk1/oracle/work/orcva/TKRM/backupset/2013_06_20/ol_mf_annnn_
TAG20130620T113128_29jhr197_.bkp tag=TAG20130620T113128
channel ORA_DISK_1: restored backup piece 1
channel ORA_DISK_1: restore complete, elapsed time: 00:00:02
archived log file name=/disk1/oracle/work/orcva/TKRM/archive/2013_06_
20/ol_mf_1_5_29jhr47k_.arc thread=1 sequence=5
channel default: deleting archived log(s)
.
.
media recovery complete, elapsed time: 00:00:15
Finished recover at 20-JUN-13

```

If you manually allocate channels, then you must issue the RESTORE and RECOVER commands together within a RUN block as shown in the following example:

```

RUN
{
  ALLOCATE CHANNEL c1 DEVICE TYPE sbt;
  RESTORE DATABASE;
  RECOVER DATABASE;
}

```

- If you are restoring some data files to new locations, then execute RESTORE DATABASE and RECOVER DATABASE sequentially in a RUN command. Use the SET NEWNAME command to rename data files, as described in "[About Restoring Data Files to a Nondefault Location](#) (page 17-12)".

The following example restores the database, specifying new names for three of the data files, and then recovers the database:

```

RUN
{
  SET NEWNAME FOR DATAFILE 2 TO '/disk2/df2.dbf';
  SET NEWNAME FOR DATAFILE 3 TO '/disk2/df3.dbf';
  SET NEWNAME FOR DATAFILE 4 TO '/disk2/df4.dbf';
  RESTORE DATABASE;
  SWITCH DATAFILE ALL;
  RECOVER DATABASE;
}

```

7. Examine the output to see if media recovery was successful. If so, open the database.

For example, enter the following command:

```
ALTER DATABASE OPEN;
```

17.3.3 Performing Complete Recovery of a Tablespace

Use the `RESTORE` and `RECOVER` commands with the `TABLESPACE` option to perform complete recovery of a tablespace

[Scope of This Chapter](#) (page 17-1) for some of the assumptions used in the recovery procedures

In the basic scenario, the database is open, and some but not all of the data files are damaged. You want to restore and recover the damaged tablespace while leaving the database open so that the rest of the database remains available. This scenario assumes that database `TRGT` has lost tablespace `USERS`.

To restore and recover a tablespace:

1. Complete the preparation steps required for your scenario as described in "[Preparing for Complete Database Recovery](#) (page 17-3)".
2. Start RMAN and connect to a target database as described in "[Making Database Connections with RMAN](#) (page 4-2)".

3. If the database is open, then take the tablespace requiring recovery offline.

For example, enter the following command to take `USERS` offline:

```
ALTER TABLESPACE users OFFLINE IMMEDIATE;
```

4. Use the `SHOW` command to see which channels are preconfigured.

For example, enter the following command (sample output is included):

```
SHOW ALL;

RMAN configuration parameters for database with db_unique_name PROD1 are:
.
.
.
CONFIGURE DEFAULT DEVICE TYPE TO DISK; # default
CONFIGURE DEVICE TYPE DISK PARALLELISM 1 BACKUP TYPE TO BACKUPSET; # default
CONFIGURE DEVICE TYPE SBT_TAPE PARALLELISM 1 BACKUP TYPE TO BACKUPSET; # default
CONFIGURE CHANNEL DEVICE TYPE 'SBT_TAPE' PARMS "SBT_
LIBRARY=/usr/local/oracle/backup/lib/libobk.so";
```

If the necessary devices and channels are configured, then no action is necessary. Otherwise, you can use the `CONFIGURE` command to configure automatic channels, or include `ALLOCATE CHANNEL` commands within a `RUN` block.

5. If restoring password-protected encrypted backups, then specify the password.

Use the `SET DECRYPTION IDENTIFIED BY` command to specify a password for password-protected backups, as shown in the following example (where *password* represents the actual password that you enter):

```
SET DECRYPTION IDENTIFIED BY password;
```

6. Restore and recover the tablespace. Do one of the following:
 - If you are restoring data files to their original locations, then run the `RESTORE TABLESPACE` and `RECOVER TABLESPACE` commands at the RMAN prompt.

For example, enter the following command if automatic channels are configured (sample output included):

```
RMAN> RESTORE TABLESPACE users;
```

```
Starting restore at 20-JUN-13
allocated channel: ORA_DISK_1
channel ORA_DISK_1: SID=37 device type=DISK
allocated channel: ORA_SBT_TAPE_1
channel ORA_SBT_TAPE_1: SID=38 device type=SBT_TAPE
channel ORA_SBT_TAPE_1: Oracle Secure Backup

channel ORA_DISK_1: starting datafile backup set restore
channel ORA_DISK_1: specifying datafile(s) to restore from backup set
channel ORA_DISK_1: restoring datafile 00012 to /disk1/oracle/dbs/users01.f
channel ORA_DISK_1: restoring datafile 00013 to /disk1/oracle/dbs/users02.f
channel ORA_DISK_1: restoring datafile 00021 to /disk1/oracle/dbs/users03.f
channel ORA_DISK_1: reading from backup piece
/disk1/oracle/work/orcva/TKRM/backupset/2013_06_20/o1_mf_nnndf_
TAG20130620T105435_29jflwor_.bkp
channel ORA_DISK_1: piece
handle=/disk1/oracle/work/orcva/TKRM/backupset/2013_06_20/o1_mf_nnndf_
TAG20130620T105435_29jflwor_.bkp tag=TAG20130620T105435
channel ORA_DISK_1: restored backup piece 1
channel ORA_DISK_1: restore complete, elapsed time: 00:00:01
Finished restore at 20-JUN-13
```

```
RMAN> RECOVER TABLESPACE users;
```

```
Starting recover at 20-JUN-13
using channel ORA_DISK_1
using channel ORA_SBT_TAPE_1

starting media recovery

archived log for thread 1 with sequence 27 is on disk as file
/disk1/oracle/work/orcva/TKRM/archivelog/2013_06_20/o1_mf_1_27_29jjmtc9_.arc
archived log for thread 1 with sequence 28 is on disk as file
/disk1/oracle/work/orcva/TKRM/archivelog/2013_06_20/o1_mf_1_28_29jjnc5x_.arc
.
.
.
channel ORA_DISK_1: starting archived log restore to default destination
channel ORA_DISK_1: restoring archived log
archived log thread=1 sequence=5
channel ORA_DISK_1: restoring archived log
archived log thread=1 sequence=6
channel ORA_DISK_1: restoring archived log
archived log thread=1 sequence=7
.
.
.
channel ORA_DISK_1: reading from backup piece
/disk1/oracle/work/orcva/TKRM/backupset/2013_06_20/o1_mf_anannn_
TAG20130620T113128_29jhr197_.bkp
channel ORA_DISK_1: piece
handle=/disk1/oracle/work/orcva/TKRM/backupset/2013_06_20/o1_mf_anannn_
TAG20130620T113128_29jhr197_.bkp tag=TAG20130620T113128
channel ORA_DISK_1: restored backup piece 1
channel ORA_DISK_1: restore complete, elapsed time: 00:00:02
archived log file name=/disk1/oracle/work/orcva/TKRM/archivelog/2013_06_
```

```

20/ol_mf_1_5_29jdkvjg_.arc thread=1 sequence=5
channel default: deleting archived log(s)
archived log file name=/disk1/oracle/work/orcva/TKRM/archivelog/2013_06_
20/ol_mf_1_5_29jdkvjg_.arc RECID=91 STAMP=593611179
archived log file name=/disk1/oracle/work/orcva/TKRM/archivelog/2013_06_
20/ol_mf_1_6_29jdkvbz_.arc thread=1 sequence=6
channel default: deleting archived log(s)
.
.
.
media recovery complete, elapsed time: 00:00:01
Finished recover at 20-JUN-13

```

- If you are restoring some data files to new locations, then execute `RESTORE TABLESPACE` and `RECOVER TABLESPACE` in a `RUN` command. Use the `SET NEWNAME` command to rename data files, as described in "[About Restoring Data Files to a Nondefault Location](#) (page 17-12)".

The following example restores the data files in tablespace `users` to a new location, and then performs recovery. Assume that the old data files were stored in the `/disk1` path and the new ones will be stored in the `/disk2` path.

```

RUN
{
  # specify the new location for each datafile
  SET NEWNAME FOR DATAFILE '/disk1/oracle/dbs/users01.f' TO
    '/disk2/users01.f';
  SET NEWNAME FOR DATAFILE '/disk1/oracle/dbs/users02.f' TO
    '/disk2/users02.f';
  SET NEWNAME FOR DATAFILE '/disk1/oracle/dbs/users03.f' TO
    '/disk2/users03.f';
  RESTORE TABLESPACE users;
  SWITCH DATAFILE ALL; # update control file with new file names
  RECOVER TABLESPACE users;
}

```

7. Examine the output to see if recovery was successful. If so, bring the recovered tablespace back online.

For example, enter the following command:

```
ALTER TABLESPACE users ONLINE;
```

17.3.4 Performing Complete Recovery After Switching to a Copy

If you have image copies of the inaccessible data files in the fast recovery area, then you can use the `SWITCH DATAFILE ... TO COPY` command to point the control file at the data file copy and then use `RECOVER` to recover lost changes. You can also use the `SWITCH DATABASE TO COPY` command to point the control file at a copy of the whole database. Because you do not need to restore backups, this recovery technique takes less time than traditional restore and recovery.

Note:

A `SWITCH TABLESPACE ... TO COPY` command is also supported for cases when all data files in a tablespace are lost and copies of all data files exist. The same restriction exists for `SWITCH DATABASE TO COPY`.

This section contains the following topics:

- [Switching to a Data File Copy](#) (page 17-19)
- [Switching to a Database Copy](#) (page 17-19)

17.3.4.1 Switching to a Data File Copy

You can switch to an existing image copy of a data file instead of restoring a damaged data file.

[Scope of This Chapter](#) (page 17-1) for some of the assumptions used in the recovery procedures

In the basic scenario, the database is open, and some but not all of the data files are damaged. During the course of the day, a data file goes missing due to storage failure. You must repair this file, but cannot afford the time to do a restore and recovery from a backup. You decide to use a recent image copy backup as the new file, thus eliminating restore time. This scenario assumes that database `trgt` has lost data file 4.

To switch to a data file copy and perform recovery:

1. Complete the preparation steps required for your scenario as described in "[Preparing for Complete Database Recovery](#) (page 17-3)".
2. Start RMAN and connect to a target database as described in "[Making Database Connections with RMAN](#) (page 4-2)".
3. If the database is open, then take the tablespace requiring recovery offline.

Enter the following command to take data file 4 offline:

```
ALTER DATABASE DATAFILE 4 OFFLINE;
```

4. Switch the offline data file to the latest copy.

Enter the following command to point the control file to the latest image copy of data file 4:

```
SWITCH DATAFILE 4 TO COPY;
```

5. Recover the data file with the `RECOVER DATAFILE` command.

Enter the following command:

```
RECOVER DATAFILE 4;
```

RMAN automatically restores archived redo logs and incremental backups. Because the database uses a fast recovery area, RMAN automatically deletes them after they have been applied.

6. Examine the output to see if recovery was successful. If so, bring the recovered data file back online.

Enter the following command to bring data file 4 online:

```
ALTER DATABASE DATAFILE 4 ONLINE;
```

17.3.4.2 Switching to a Database Copy

You can perform complete database recovery by switching to image copies of damaged data files instead of restoring these data files.

[Scope of This Chapter](#) (page 17-1) for some of the assumptions used in the recovery procedures

In this scenario, the database is shut down, and all of the data files are damaged. You have image copies of all the damaged data files and decide to use the existing image copies as the new data files, thus eliminating restore time.

To switch to a database copy and perform recovery:

1. Complete the preparation steps required for your scenario as described in "[Preparing for Complete Database Recovery](#) (page 17-3)".
2. Start RMAN and connect to a target database as described in "[Making Database Connections with RMAN](#) (page 4-2)".
3. Mount the database.
4. Switch the database to the latest copy.

Enter the following command to point the control file to the latest image copy of the database:

```
SWITCH DATABASE TO COPY;
```

5. Recover the database with the `RECOVER DATABASE` command.

Enter the following command:

```
RECOVER DATABASE;
```

RMAN automatically restores archived redo logs and incremental backups. Because the database uses a fast recovery area, RMAN automatically deletes them after they have been applied.

6. Examine the output to see if recovery was successful. If so, open the database.

Enter the following command to open the database:

```
ALTER DATABASE OPEN;
```

17.4 Performing Complete Recovery of CDBs

RMAN and Oracle Enterprise Manager Cloud Control (Cloud Control) provide full support for backup and recovery in a multitenant environment. You can back up and recover a whole [multitenant container database \(CDB\)](#), [root](#) only, or one or more pluggable databases ([PDBs](#)).

The section contains the following topics:

- [Performing Complete Recovery of a Whole CDB](#) (page 17-21)
- [Performing Complete Recovery of the Root](#) (page 17-22)
- [Performing Complete Recovery of PDBs with RMAN](#) (page 17-23)
- [Performing Complete Recovery of PDBs with Cloud Control](#) (page 17-25)
- [Performing Complete Recovery of Tablespaces or Data Files in a PDB with RMAN](#) (page 17-26)

- [Performing Complete Recovery of Tablespaces in a PDB with Cloud Control](#) (page 17-28)
- [Performing Complete Recovering of CDBs After Switching to a Copy](#) (page 17-29)

17.4.1 Performing Complete Recovery of a Whole CDB

When you recover a whole CDB, you recover the root and all PDBs in a single operation.

To recover a whole CDB:

1. Complete the preparation steps required for your scenario as described in "[Preparing for Complete Database Recovery](#) (page 17-3)"
2. Connect to the root as a common user with the SYSDBA or SYSBACKUP privilege as described in "[Connecting as Target to the Root](#) (page 4-8)".
3. If the database is not mounted, then mount but do not open the database. Use the following `g` command:

```
STARTUP MOUNT;
```

4. Use the `SHOW` command to see which channels are preconfigured.

If the necessary devices and channels are configured, then no action is necessary. Otherwise, you can use the `CONFIGURE` command to configure automatic channels, or include `ALLOCATE CHANNEL` commands within a `RUN` block.

5. Restore and recover the database. Do one of the following:

- If you are restoring all data files to their original locations, then execute `RESTORE DATABASE` and `RECOVER DATABASE` sequentially at the RMAN prompt.

For example, enter the following commands if automatic channels are configured:

```
RESTORE DATABASE;
RECOVER DATABASE;
```

If you manually allocate channels, then you must issue the `RESTORE` and `RECOVER` commands together within a `RUN` block as shown in the following example:

```
RUN
{
  ALLOCATE CHANNEL c1 DEVICE TYPE sbt;
  RESTORE DATABASE;
  RECOVER DATABASE;
}
```

- If you are restoring some data files to new locations, then execute `RESTORE DATABASE` and `RECOVER DATABASE` sequentially in a `RUN` command. Use the `SET NEWNAME` command to rename data files.

The following example restores the database, specifying new names for three of the data files, and then recovers the database:

```

RUN
{
  SET NEWNAME FOR DATAFILE 2 TO '/disk2/df2.dbf';
  SET NEWNAME FOR DATAFILE 3 TO '/disk2/df3.dbf';
  SET NEWNAME FOR DATAFILE 4 TO '/disk2/df4.dbf';
  RESTORE DATABASE;
  SWITCH DATAFILE ALL;
  RECOVER DATABASE;
}

```

6. Examine the output to see if media recovery was successful. If so, open the database.

For example, enter the following command:

```
ALTER DATABASE OPEN;
```

See Also:

["About Restoring Data Files to a Nondefault Location \(page 17-12\)"](#)

17.4.2 Performing Complete Recovery of the Root

You might consider recovering only the root if a data corruption or user error occurs that affects only the root. However, Oracle strongly recommends that you recover all PDBs after recovering the root to prevent metadata inconsistencies among the root and the PDBs. In this case, it might be preferable to perform a complete recovery of the whole CDB.

See Also:

[Scope of This Chapter \(page 17-1\)](#) for some of the assumptions used in the recovery procedures

To recover the root:

1. Start RMAN and connect to the root as a common user with the SYSDBA or SYSBACKUP privilege.

See Also:

["Making RMAN Connections to a CDB \(page 4-7\)"](#)

2. Place the CDB in mounted mode.

```
SHUTDOWN IMMEDIATE
STARTUP MOUNT
```

3. (Optional) Use the CONFIGURE command to configure the default device type and automatic channels.
4. Restore and recover the root with the following commands:

```
RESTORE DATABASE ROOT;
RECOVER DATABASE ROOT;
```

5. Examine the output to see if media recovery was successful. If so, proceed to the next step.
6. (Strongly recommended) Recover all PDBs, including the CDB seed.
 - a. Issue the `RESTORE PLUGGABLE DATABASE` and `RECOVER PLUGGABLE DATABASE` commands.

The following example recovers the PDBs `sales` and `hr`:

```
RESTORE PLUGGABLE DATABASE 'PDB$SEED', sales, hr;
RECOVER PLUGGABLE DATABASE 'PDB$SEED', sales, hr;
```

- b. Examine the output to see if media recovery was successful. If so, proceed to the next step.
7. Open the CDB and all PDBs.

```
ALTER DATABASE OPEN;
ALTER PLUGGABLE DATABASE ALL OPEN;
```

See Also:

- ["Performing Complete Recovery of a Whole CDB \(page 17-21\)"](#)
 - ["Performing Complete Recovery of the Whole Database \(page 17-13\)"](#) for more options when recovering
 - ["Connecting as Target to the Root \(page 4-8\)"](#)
-
-

17.4.3 Performing Complete Recovery of PDBs with RMAN

You can perform complete recovery of one or more PDBs without affecting operations of other open PDBs.

See Also:

[Scope of This Chapter \(page 17-1\)](#) for some of the assumptions used in the recovery procedures

There are two approaches to recovering a PDB with RMAN:

- Connect to the root and then use the `RESTORE PLUGGABLE DATABASE` and `RECOVER PLUGGABLE DATABASE` commands. This approach enables you to recover multiple PDBs with a single command.
- Connect to the PDB and use the `RESTORE DATABASE` and `RECOVER DATABASE` commands. This approach recovers only a single PDB and enables you to use the same commands used for recovering non-CDB databases.

Video:

Recovering a Pluggable Database

To recover one or more PDBs while connected to the root:

1. Start RMAN and connect to the root as a common user with the SYSDBA or SYSBACKUP privilege.

See Also:

["Making RMAN Connections to a CDB \(page 4-7\)"](#)

2. Close the PDBs that you want to recover.

```
ALTER PLUGGABLE DATABASE sales, hr CLOSE;
```

If any data files are missing, an error occurs and you cannot close a PDB. You must then connect to the PDB to which the missing data file belongs, take the missing data file offline, and then close the PDB.

The following command takes the data file 12 offline:

```
ALTER PLUGGABLE DATABASE DATAFILE 12 OFFLINE;
```

Note:

If the data files that store the SYSTEM tablespace of a PDB are missing, then follow the recovery steps described in [Performing Complete Recovery of Tablespaces or Data Files in a PDB with RMAN \(page 17-26\)](#).

3. (Optional) Use the CONFIGURE command to configure the default device type and automatic channels.
4. Issue the RESTORE PLUGGABLE DATABASE and RECOVER PLUGGABLE DATABASE commands.

The following example recovers the CDB seed, PDB\$SEED, and the PDBs sales and hr:

```
RESTORE PLUGGABLE DATABASE 'pdb$seed', sales, hr;
RECOVER PLUGGABLE DATABASE 'pdb$seed', sales, hr;
```

5. If any data files were taken offline in Step 2, make these data files online.

Connect to the PDB to which the missing data file belongs and then make the data file online. The following command makes the data file 12 online:

```
ALTER DATABASE DATAFILE 12 ONLINE;
```

6. Examine the output to see if media recovery was successful. If so, open the PDBs.

```
ALTER PLUGGABLE DATABASE sales, hr OPEN;
```

To connect to and recover one PDB:

1. Start RMAN and connect to the PDB as a [local user](#) with SYSDBA system privilege.

See Also:

["Making RMAN Connections to a CDB \(page 4-7\)"](#)

2. Close the PDB.

```
ALTER PLUGGABLE DATABASE CLOSE;
```

If any data files are missing, an error occurs and you cannot close the PDB. You must take the missing data file offline and then close the PDB.

The following command takes the data file 12 offline:

```
ALTER DATABASE DATAFILE 12 OFFLINE;
```

Note:

If the data files that store the `SYSTEM` tablespace of a PDB are missing, then follow the recovery steps described in [Performing Complete Recovery of Tablespaces or Data Files in a PDB with RMAN](#) (page 17-26).

3. (Optional) Use the `CONFIGURE` command to configure the default device type and automatic channels.**4. Issue the `RESTORE DATABASE` and `RECOVER DATABASE` commands.**

```
RESTORE DATABASE;
RECOVER DATABASE;
```

5. If any data files were taken offline in Step 2, make these data files online.

The following command makes the data file 12 online:

```
ALTER DATABASE DATAFILE 12 ONLINE;
```

6. Open the PDB.

```
ALTER PLUGGABLE DATABASE OPEN;
```

See Also:

- ["Connecting as Target to the Root](#) (page 4-8)"
- ["Connecting as Target to a PDB](#) (page 4-9)"

17.4.4 Performing Complete Recovery of PDBs with Cloud Control

To recover one or more PDBs with Oracle Enterprise Manager Cloud Control (Cloud Control), complete these steps:

1. From the Database Home page, select **Backup & Recovery** from the Availability menu, and then select **Perform Recovery**.
2. If you have not logged in to the database previously, the Database Login page is displayed. Log in to the database using Named or New credentials and then click **Login**.

Cloud Control displays the Perform Recovery page.

3. From the User Directed Recovery section, select **Pluggable Databases** from the Recovery Scope drop-down list, and then click **Recover**.

The Perform Pluggable Database Recovery Wizard appears and displays the Pluggable Databases page.

4. Select the PDBs that you want to recover by following these steps:
 - a. Click **Add** to display the Available Pluggable Databases page.
 - b. From the list of PDBs shown, click in the **Select** column to designate the PDBs that you want to recover. Optionally, you can click **Select All** to turn on the Select option for all available PDBs. Click **Select None** to deselect all PDBs.
 - c. Click the **Select** button to return to the Pluggable Databases page.
 - d. Optionally, you can remove PDBs from the table by clicking in the **Select** column for each PDB that you want to remove and then clicking **Remove**.
5. Complete the wizard by navigating through the remainder of the pages to recover the PDBs. For more information about each page of the wizard, click **Help**.

See Also:

["Accessing the Database Home Page Using Cloud Control \(page 1-10\)"](#)

17.4.5 Performing Complete Recovery of Tablespaces or Data Files in a PDB with RMAN

Because tablespaces in different PDBs can have the same name, to eliminate ambiguity you must connect directly to a PDB to recover one or more of its tablespaces. In contrast, because data file numbers and paths are unique across the CDB, you can connect to either the root or a PDB to recover PDB data files.

If you connect to the root, you can recover data files from multiple PDBs with a single command. If you connect to a PDB, you can recover only data files in that PDB.

To restore and recover a non-SYSTEM tablespace in a PDB:

1. Complete the preparation steps required for your scenario as described in "[Preparing for Complete Database Recovery \(page 17-3\)](#)".
2. Start RMAN and connect to a target database as described in "[Making Database Connections with RMAN \(page 4-2\)](#)".
3. If the database is open, then take the tablespace requiring recovery offline.
For example, enter the following command to take USERS offline:

```
ALTER TABLESPACE users OFFLINE IMMEDIATE;
```
4. Use the SHOW command to see which channels are preconfigured.
If the necessary devices and channels are configured, then no action is necessary. Otherwise, you can use the CONFIGURE command to configure automatic channels, or include ALLOCATE CHANNEL commands within a RUN block.
5. If restoring password-protected encrypted backups, then specify the password.

Use the `SET DECRYPTION IDENTIFIED BY` command to specify a password for password-protected backups, as shown in the following example (where *password* represents the actual password that you enter):

```
SET DECRYPTION IDENTIFIED BY password;
```

6. Restore and recover the tablespace. Do one of the following:

- If you are restoring data files to their original locations, then run the `RESTORE TABLESPACE` and `RECOVER TABLESPACE` commands at the RMAN prompt.

For example, enter the following commands if automatic channels are configured:

```
RMAN> RESTORE TABLESPACE users;
RMAN> RECOVER TABLESPACE users;
```

- If you are restoring some data files to new locations, then execute `RESTORE TABLESPACE` and `RECOVER TABLESPACE` in a `RUN` command. Use the `SET NEWNAME` command to rename data files.

7. Examine the output to see if recovery was successful. If so, bring the recovered tablespace back online.

For example, enter the following command:

```
ALTER TABLESPACE users ONLINE;
```

To restore and recover the SYSTEM tablespace in a PDB:

1. Start RMAN and connect to the root as a common user with the `SYSDBA` or `SYSBACKUP` privilege as described in "[Connecting as Target to the Root](#) (page 4-8)".
2. Shut down the CDB and restart it in mount mode.

```
SHUTDOWN IMMEDIATE;
STARTUP MOUNT;
```

3. Restore and recover the data files that store the `SYSTEM` tablespace of the affected PDB.

```
RESTORE DATAFILE 2,3;
RECOVER DATAFILE 2,3;
```

4. Open all the PDBs in the CDB.

```
ALTER PLUGGABLE DATABASE ALL OPEN READ WRITE;
```

To recover non-SYSTEM data files in a PDB:

1. Do one of the following:

- Start RMAN and connect to the root as a [common user](#) with the `SYSDBA` or `SYSBACKUP` privilege as described in "[Connecting as Target to the Root](#) (page 4-8)".
- Start RMAN and connect to the PDB as a local user with the `SYSDBA` privilege as described in "[Connecting as Target to a PDB](#) (page 4-9)".

2. Issue the `RESTORE DATAFILE` and `RECOVER DATAFILE` commands.

```
RESTORE DATAFILE 10, 13;  
RECOVER DATAFILE 10, 13;
```

See Also:

["About Restoring Data Files to a Nondefault Location \(page 17-12\)"](#)

17.4.6 Performing Complete Recovery of Tablespaces in a PDB with Cloud Control

To perform complete recovery of tablespaces in a PDB with Oracle Enterprise Manager Cloud Control (Cloud Control), complete these steps:

1. From the Database Home page, select **Backup & Recovery** from the Availability menu, and then select **Perform Recovery**.
2. If you have not logged in to the database previously, the Database Login page is displayed. Log in to the database using Named or New credentials and then click **Login**.

Cloud Control displays the Perform Recovery page.

3. From the User Directed Recovery section, select **Tablespaces** from the Recovery Scope drop-down list, and then click **Recover**.
4. On the Perform Object Level Recovery:Point-in-time page, ensure that **Recover to the current time** is selected, and click **Next**.
5. On the Perform Object Level Recovery: Tablespaces page, select the tablespaces that you want to recover by completing these steps:
 - a. Click **Add** to display the Available Tablespaces page.

The Search Results table shows all available tablespaces and includes the name of the PDB to which each tablespace belongs.
 - b. Click **Select** to designate the tablespaces that you want to recover. Optionally, you can click **Select All** to turn on the Select option for all available tablespaces. Click **Select None** to deselect all tablespaces.
 - c. Click the **Select** button to return to the Perform Object Level Recovery: Tablespaces page.
 - d. Optionally, you can remove tablespaces from the table by turning on the Select option for each tablespace that you want to remove and then clicking **Remove**.
6. Click **Next** to move to the next step in the wizard.
7. Complete the wizard by navigating through the remainder of the pages to recover the PDB tablespace. For more information about each page of the wizard, click **Help**.

See Also:

["Accessing the Database Home Page Using Cloud Control \(page 1-10\)"](#)

17.4.7 Performing Complete Recovering of CDBs After Switching to a Copy

If you have image copies of the inaccessible data files in your CDB or PDB, then you can recover lost changes by using the SWITCH command to point the control file at the data file copies. The information in "[Performing Complete Recovery After Switching to a Copy](#) (page 17-18)" applies to CDBs and PDBs with the following differences.

See Also:

[Scope of This Chapter](#) (page 17-1) for some of the assumptions used in the recovery procedures

To switch a data file in a CDB, connect to the root and use the same steps that you would use for a non-CDB as described in [Switching to a Data File Copy](#) (page 17-19).

To switch a data file in a PDB, use one of the following techniques:

- Connect to the root and use the SWITCH . . . PLUGGABLE DATABASE or SWITCH DATAFILE command. This enables you to switch the data files for one or more PDBs.
- Connect to the PDB and use the SWITCH DATABASE or SWITCH DATAFILE command to switch data files in that PDB.

See Also:

["Making RMAN Connections to a CDB](#) (page 4-7)"

17.5 Performing Complete Recovery of Application Containers

RMAN enables you to use the RESTORE and RECOVER commands to perform complete recovery of the application containers without impacting the other containers in the CDB.

Note:

- [Performing Complete Recovery of the Application Root](#) (page 17-29)
 - [Performing Complete Recovery of the Application Root and Application PDBs](#) (page 17-31)
 - [Performing Complete Recovery of Application PDBs](#) (page 17-31)
-
-

17.5.1 Performing Complete Recovery of the Application Root

Use the RESTORE and RECOVER commands to perform complete recovery of the application root.

Use one of the following approaches to perform complete recovery of the application root:

- Connect to the application root and use the `RESTORE DATABASE` and `RECOVER DATABASE` commands
- Connect to the CDB root and use the `RESTORE PLUGGABLE DATABASE` and `RECOVER PLUGGABLE DATABASE` commands

The `COMPATIBLE` parameter for the CDB must be set to 12.2 or higher.

To connect to and recover the application root:

1. Start RMAN and connect to the [application root](#) as an application common user with the `SYSDBA` or `SYSBACKUP` privilege.

The application root has its own service name and you can connect to the application root in the same way that you connect to a PDB.

2. Close the application container whose application root needs recovery.

```
ALTER DATABASE CLOSE;
```

3. (Optional) Use the `CONFIGURE` command to configure the default device type and automatic channels.

4. Restore and recover the application root using the following commands:

```
RESTORE DATABASE ROOT;  
RECOVER DATABASE ROOT;
```

5. Examine the output to see if media recovery was successful. If so, proceed to the next step.

6. Open the application root.

```
ALTER DATABASE OPEN;
```

To recover the application root when connected to the root in a CDB

1. Start RMAN and connect to the CDB root as a common user with the `SYSDBA` or `SYSBACKUP` privilege.

2. Close the application container that must be recovered.

The following command closes the application container whose application root is called `hr_appcont`.

```
ALTER PLUGGABLE DATABASE hr_appcont CLOSE;
```

3. (Optional) Use the `CONFIGURE` command to configure the default device type and automatic channels.

4. Restore and recover the application root.

The following commands restore and recover an application root named `hr_appcont`:

```
RESTORE PLUGGABLE DATABASE hr_appcont;  
RECOVER PLUGGABLE DATABASE hr_appcont;
```

5. Examine the output to see if media recovery was successful. If so, proceed to the next step.

6. Open the application root.

```
ALTER PLUGGABLE DATABASE hr_appcont OPEN;
```

See Also:

[Making RMAN Connections to a CDB](#) (page 4-7)

17.5.2 Performing Complete Recovery of the Application Root and Application PDBs

You can perform complete recovery of an application container, which includes the application root and all its application PDBs without impacting the other PDBs within the CDB.

The `COMPATIBLE` parameter for the CDB must be set to 12.2 or higher.

To perform complete recovery of the application root and all its application PDBs:

1. Start RMAN and connect to the [application root](#) as an application common user with the `SYSDBA` or `SYSBACKUP` privilege.

The application root has its own service name and you can connect to the application root in the same way that you connect to a PDB.

2. Close the [application container](#) that must be recovered.

```
ALTER DATABASE CLOSE;
```

3. (Optional) Use the `CONFIGURE` command to configure the default device type and automatic channels.

4. Restore and recover the application container (application root and all application PDBs) using the following commands.

```
RESTORE DATABASE;  
RECOVER DATABASE;
```

5. Examine the output to see if media recovery was successful. If so, proceed to the next step.

6. Open the application root and all the application PDBs.

```
ALTER DATABASE OPEN;  
ALTER PLUGGABLE DATABASE ALL OPEN;
```

See Also:

[Making RMAN Connections to a CDB](#) (page 4-7)

17.5.3 Performing Complete Recovery of Application PDBs

Use the `RESTORE` and `RECOVER` commands to perform complete recovery of one or more application PDBs.

The `COMPATIBLE` parameter for the CDB must be set to 12.2 or higher.

To perform complete recovery of an application PDB:

1. Start RMAN and establish one of the following types of connections:

- Connect to the [application root](#) as an application common user with the SYSDBA or SYSBACKUP privilege.

The application root has its own service name and you can connect to the application root in the same way that you connect to a PDB.

- Connect to the CDB root as a common user with the SYSDBA or SYSBACKUP privilege.

2. Close the [application PDB](#) for which complete recovery is required.

The following command closes the application PDB called hr_appcont_pdb1:

```
ALTER PLUGGABLE DATABASE hr_appcont_pdb1 CLOSE;
```

3. (Optional) Use the CONFIGURE command to configure the default device type and automatic channels.

4. Restore and recover the application PDB.

The following commands perform complete recovery of an application PDB called hr_appcont_pdb1

```
RESTORE PLUGGABLE DATABASE hr_appcont_pdb1;  
RECOVER PLUGGABLE DATABASE hr_appcont_pdb1;
```

5. Examine the output to see if media recovery was successful. If so, proceed to the next step.

6. Open the application PDB.

The following commands opens the application PDB called hr_appcont_pdb1:

```
ALTER PLUGGABLE DATABASE hr_appcont_pdb1 OPEN;
```

See Also:

[Making RMAN Connections to a CDB](#) (page 4-7)

17.6 Performing Complete Recovery of Sparse Databases with RMAN

This section contains the following topics:

- [Performing Complete Recovery of a Sparse Database](#) (page 17-33)
- [Performing Complete Recovery of a Sparse CDB](#) (page 17-33)
- [Performing Complete Recovery of a Sparse PDB](#) (page 17-34)

Note:

The base (read-only) data files in a sparse database are not encrypted. Ensure that the base data files are stored in a protected storage and accessed using secured communications.

17.6.1 Performing Complete Recovery of a Sparse Database

Performing recovery of a database containing sparse data files is very similar to performing recovery of a whole database.

RMAN first restores the logical data that was backed up from the delta storage space of the database and then recovers the database by reading from the redo log and applying the logical data file blocks. You can perform either complete recovery or point-in-time recovery of a sparse database, tablespace, or data file.

To recover a sparse database:

1. Complete the preparation steps required for your scenario as described in "[Preparing for Complete Database Recovery](#) (page 17-3)".
2. Start RMAN and connect to a target database as described in "[Making Database Connections with RMAN](#) (page 4-2)".
3. If the database is not mounted, then mount but do not open the database.

For example, enter the following command:

```
STARTUP MOUNT;
```

4. Use the SHOW command to see which channels are preconfigured.

If the necessary devices and channels are configured, then no action is necessary. Otherwise, you can use the CONFIGURE command to configure automatic channels, or include ALLOCATE CHANNEL commands within a RUN block.

5. Restore and recover the sparse database. The following commands perform complete recovery of a sparse database:

```
RESTORE FROM SPARSE DATABASE;  
RECOVER DATABASE;
```

6. To recover a specific tablespace containing sparse data files, use the RESTORE and RECOVER commands for the tablespace.

The following example restores and recovers the tablespace MY_TBS

```
RESTORE FROM SPARSE TABLESPACE MY_TBS;  
RECOVER TABLESPACE MY_TBS;
```

17.6.2 Performing Complete Recovery of a Sparse CDB

Performing recovery of a sparse CDB is very similar to performing the complete recovery of a sparse database.

To recover a sparse CDB:

1. Complete the preparation steps required for your scenario as described in "[Preparing for Complete Database Recovery](#) (page 17-3)".
2. Start RMAN and connect to the root as a common user with the SYSDBA or SYSBACKUP privilege as described in "[Making Database Connections with RMAN](#) (page 4-2)".

3. If the CDB is not mounted, then mount but do not open the CDB.

For example, enter the following command:

```
STARTUP MOUNT;
```

4. Use the SHOW command to see which channels are preconfigured.

If the necessary devices and channels are configured, then no action is necessary. Otherwise, you can use the CONFIGURE command to configure automatic channels, or include ALLOCATE CHANNEL commands within a RUN block.

5. Restore and recover the sparse CDB. The following commands perform complete recovery of a sparse CDB:

```
RESTORE FROM SPARSE DATABASE;
RECOVER DATABASE;
```

6. To recover a specific tablespace containing sparse data files, use the RESTORE and RECOVER commands for the tablespace.

The following example restores and recovers the tablespace MY_TBS

```
RESTORE FROM SPARSE TABLESPACE MY_TBS;
RECOVER TABLESPACE MY_TBS;
```

17.6.3 Performing Recovery of a Sparse PDB with RMAN

The steps to recover a sparse PDB are similar to the steps performed to recover a normal PDB. You can recover a sparse PDB while you are connected at the root level or at the CDB level. The steps to perform the recovery operation are listed below.

To recover one or more sparse PDBs while connected to the root:

1. Start RMAN and connect to the root as a common user with the SYSDBA or SYSBACKUP privilege as described in "[Making RMAN Connections to a CDB](#) (page 4-7)".
2. Close the PDBs that you want to recover.

```
ALTER PLUGGABLE DATABASE sales, hr CLOSE;
```

If any data files are missing, an error occurs and you cannot close a PDB. You must then connect to the PDB to which the missing data file belongs, take the missing data file offline, and then close the PDB.

The following command takes the data file 12 offline:

```
ALTER PLUGGABLE DATABASE DATAFILE 12 OFFLINE;
```

Note:

If the data files that store the SYSTEM tablespace of a PDB are missing, then follow the recovery steps described in [Performing Complete Recovery of Tablespaces or Data Files in a PDB with RMAN](#) (page 17-26).

3. (Optional) Use the CONFIGURE command to configure the default device type and automatic channels.

4. Run the RESTORE and RECOVER commands for the pluggable database.

The following example performs complete recovery of the PDB HR_PDB when connected to the root:

```
RESTORE FROM SPARSE PLUGGABLE DATABASE HR_PDB;  
RECOVER PLUGGABLE DATABASE HR_PDB;
```

To connect to and recover one sparse PDB:

1. Start RMAN and connect to the PDB as a [local user](#) with the SYSDBA or SYSBACKUP system privilege as described in "[Making RMAN Connections to a CDB](#) (page 4-7)".
2. Close the PDB.

```
ALTER PLUGGABLE DATABASE CLOSE;
```

If any data files are missing, an error occurs and you cannot close the PDB. You must take the missing data file offline and then close the PDB.

The following command takes the data file 12 offline:

```
ALTER DATABASE DATAFILE 12 OFFLINE;
```

Note:

If the data files that store the SYSTEM tablespace of a PDB are missing, then follow the recovery steps described in [Performing Complete Recovery of Tablespaces or Data Files in a PDB with RMAN](#) (page 17-26).

3. (Optional) Use the CONFIGURE command to configure the default device type and automatic channels.
4. Issue the RESTORE and RECOVER commands.

The following example restores and recovers the PDB USERS_PDB

```
RESTORE FROM SPARSE DATABASE FROM USERS_PDB;  
RECOVER DATABASE USERS_PDB;
```

.

Performing Flashback and Database Point-in-Time Recovery

This chapter explains how to investigate unwanted database changes, and select and perform an appropriate recovery strategy based upon Oracle Flashback Technology and database backups. It contains the following topics:

- [Overview of Oracle Flashback Technology and Database Point-in-Time Recovery](#) (page 18-1)
- [Rewinding a Table with Flashback Table](#) (page 18-7)
- [Rewinding a DROP TABLE Operation with Flashback Drop](#) (page 18-10)
- [Rewinding a Database with Flashback Database](#) (page 18-15)
- [Performing Database Point-in-Time Recovery](#) (page 18-25)
- [Flashback and Database Point-in-Time Recovery Scenarios](#) (page 18-34)

18.1 Overview of Oracle Flashback Technology and Database Point-in-Time Recovery

This section explains the purpose and basic concepts of [Oracle Flashback Technology](#) and database point-in-time recovery.

18.1.1 Purpose of Flashback and Database Point-in-Time Recovery

Typically, the following situations call for flashback features or point-in-time recovery:

- A user error or corruption removes needed data or introduces corrupted data. For example, a user or DBA might erroneously delete or update the contents of one or more tables, drop database objects that are still needed during an update to an application, or run a large batch update that fails midway.
- A database upgrade fails or an upgrade script goes awry.
- A complete database recovery after a media failure cannot succeed because you do not have all of the needed redo logs or incremental backups.

In these situations, you can use point-in-time recovery or flashback features to return the database or database object to its state at a previous point in time.

18.1.2 Basic Concepts of Point-in-Time Recovery and Flashback Features

The most basic solution to unwanted database changes is RMAN [database point-in-time recovery \(DBPITR\)](#). DBPITR is sometimes called [incomplete recovery](#) because it does not use all of the available redo or completely recover all changes to your

database. In this case, you restore a whole database backup and then apply redo logs or incremental backups to re-create all changes up to a point in time before the unwanted change.

If unwanted database changes are extensive but confined to specific tablespaces, then you can use [tablespace point-in-time recovery \(TSPITR\)](#) to return these tablespaces to an earlier [system change number \(SCN\)](#) while the unaffected tablespaces remain available. RMAN TSPITR is an advanced technique described in [Performing RMAN Tablespace Point-in-Time Recovery \(TSPITR\)](#) (page 21-1).

If unwanted database changes are limited to specific tables or table partitions, then you can use a previously created RMAN backup to return only these objects to a point in time before the unwanted changes occurred. Recovering tables or table partitions to a specific point in time is described in [Recovering Tables and Table Partitions from RMAN Backups](#) (page 22-1).

Oracle Database also provides a set of features collectively known as Flashback Technology that supports viewing past states of data, and winding and rewinding data back and forth in time, without requiring the restore of the database from backup. Depending on the changes to your database, Flashback Technology can often reverse the unwanted changes more quickly and with less impact on database availability.

18.1.2.1 Basic Concepts of Database Point-in-Time Recovery for non-CDBs

DBPITR works at the physical level to return the data files to their state at a target time in the past. In an RMAN DBPITR operation, you specify a target SCN, log sequence, restore point, or time. RMAN restores the database from backups created before the target time, and then applies incremental backups and logs to re-create all changes between the time of the data file backups and the end point of recovery. When the end point is specified as an SCN, the database applies the redo logs and stops after each redo thread or the specified SCN, whichever occurs first. When the end point is specified as a time, the database internally determines a suitable SCN for the specified time and then recovers to this SCN.

If your backup strategy is properly designed and your database is running in ARCHIVELOG mode, then DBPITR is an option in nearly all circumstances. RMAN simplifies DBPITR in comparison to the user-managed DBPITR described in "[Performing Incomplete Database Recovery](#) (page 30-20)". Given a target SCN, data files are restored from backup and recovered efficiently with no intervention from the user. Nevertheless, RMAN DBPITR has the following disadvantages:

- You cannot return selected objects to their earlier state, only the entire database.
- Your entire database is unavailable during the DBPITR.
- DBPITR can be time-consuming because RMAN must restore all data files. Also, RMAN may need to restore redo logs and incremental backups to recover the data files. If backups are on tape, then this process can take even longer.

18.1.2.2 Basic Concepts of Point-in-Time Recovery for PDBs

RMAN provides support for point-in-time recovery for one or more pluggable databases ([PDBs](#)). The process of performing recovery is similar to that of DBPITR. You use the RECOVER command to perform point-in-time recovery of one or more PDBs. However, to recover PDBs, you must connect to the root as a user with SYSDBA or SYSBACKUP privilege. See "[Performing Point-in-Time Recovery of CDBs and PDBs](#) (page 18-28)".

18.1.2.3 Basic Concepts of Flashback Technology

The flashback features of the Oracle Database are more efficient than media recovery in most circumstances in which they are available. You can use them to investigate past states of the database.

18.1.2.3.1 About Physical Flashback Features Useful in Backup and Recovery

[Oracle Flashback Database](#), which is explained in "[Rewinding a Database with Flashback Database](#) (page 18-15)", is the most efficient alternative to DBPITR. Unlike the other flashback features, it operates at a physical level and reverts the current data files to their contents at a past time. The result is like the result of a DBPITR, including the `OPEN RESETLOGS`, but Flashback Database is typically faster because it does not require you to restore data files and requires only limited application of redo compared to media recovery.

As explained in "[Configuring the Fast Recovery Area](#) (page 5-19)", a [fast recovery area](#) is required for Flashback Database. To enable logging for Flashback Database, you must set the `DB_FLASHBACK_RETENTION_TARGET` initialization parameter and issue the `ALTER DATABASE FLASHBACK ON` statement.

During normal operation, the database periodically writes old images of data file blocks to the [flashback logs](#). Flashback logs are written sequentially and often in bulk. In some respects, flashback logging is like a continuous backup. The database automatically creates, deletes, and resizes flashback logs in the recovery area. Flashback logs are not archived. You need only be aware of flashback logs for monitoring performance and determining disk space allocation for the recovery area.

When you perform a Flashback Database operation, the database uses flashback logs to access past versions of data blocks and also uses some data in the archived redo logs. Consequently, you cannot enable Flashback Database *after* a failure is discovered and then use Flashback Database to rewind through this failure. You can use the related capability of guaranteed restore points to protect the contents of your database at a fixed point in time, such as immediately before a risky database change.

18.1.2.3.2 About Logical Flashback Features Useful in Backup and Recovery

The remaining flashback features operate at the logical level. The logical features documented in this chapter are as follows:

- Flashback Table

You can recover a table or set of tables to a specified earlier point in time without taking any part of the database offline. In many cases, Flashback Table eliminates the need to perform more complicated point-in-time recovery operations. Flashback Table restores tables while automatically maintaining associated attributes such as current indexes, triggers, and constraints, and not requiring you to find and restore application-specific properties.

"[Rewinding a Table with Flashback Table](#) (page 18-7)" explains how to use this feature.

See Also:

[Recovering Tables and Table Partitions from RMAN Backups](#) (page 22-1) for information about recovering tables using previously-created RMAN backups

- Flashback Drop

You can reverse the effects of a `DROP TABLE` statement.

"[Rewinding a DROP TABLE Operation with Flashback Drop](#) (page 18-10)" explains how to use this feature.

All logical flashback features except Flashback Drop rely on **undo data**. Used primarily for providing read consistency for SQL queries and rolling back transactions, undo records contain the information required to reconstruct data as it existed at a past time and examine the record of changes since that past time.

Flashback Drop relies on a mechanism called the [recycle bin](#), which the database uses to manage dropped database objects until the space they occupied is needed for new data. There is no fixed amount of space allocated to the recycle bin, and no guarantee regarding how long dropped objects remain in the recycle bin. Depending on system activity, a dropped object may remain in the recycle bin for seconds or for months.

See Also:

- *Oracle Database Concepts* and *Oracle Database Administrator's Guide* for more information about undo data and automatic undo management
 - *Oracle Database Development Guide* to learn how to use the logical flashback features
 - "[Overview of Flashback Database_ Restore Points and Guaranteed Restore Points](#) (page 7-1)" for more information about setting up your database to use Flashback Database, and on the related restore points feature
-
-

18.1.3 Basic Concepts of Performing Flashback Database for CDBs and PDBs

You can perform a Flashback Database operation for a whole multitenant container database (CDB) or for a particular pluggable database (PDB).

Flashback Database for a whole CDB enables you to rewind the entire CDB, including all its PDBs, to a previous point in time. Flashback Database for a particular PDB enables you to reverse unwanted changes caused by logical data corruption or user errors in that PDB. When you perform a Flashback Database operation for a specific PDB, the other PDBs can be open and operational.

You can perform multiple flashback database operations on a single PDB. However, you can only perform a flashback operation on a PDB to one of its ancestor incarnations. A PDB must always stay in a past incarnation that is compatible with the overall database incarnation.

To perform a Flashback Database operation for a PDB, the desired target point in time can be specified using a PDB restore point, a [CDB restore point](#), an SCN, or a time expression. A flashback operation on a PDB to a CDB restore point is equivalent to a flashback operation on the PDB to the restore point SCN on the CDB incarnation. In general, for PDBs, a flashback operation to a [PDB restore point](#) is more accurate than a flashback operation to a CDB restore point. This is because a PDB restore point represents the PDB sub-incarnation of the point in time at which it was created.

You can also perform a Flashback Database operation for a PDB on a physical standby database.

Backups of a PDB continue to be valid even after a Flashback Database operation is performed on that PDB. In case of a media failure, you can recover from the failure by restoring these PDB backups. This type of PDB recovery can recover through database resetlogs and PDB resetlogs.

Note:

You cannot perform a flashback operation only on the root, you must perform a flashback operation on the entire CDB.

Note:

To perform a flashback operation for an application container, you must perform flashback operations for the application root and all the individual application PDBs that are part of the application container. Performing a flashback operation on the application root reverts only the application root to the specified point in time.

See Also:

- [About Flashback Database and PITR for PDBs](#) (page 18-5)
 - [About Undo and Flashback Database Operations for PDBs](#) (page 18-6)
 - [About Managing Redo Corruption in CDBs](#) (page 18-6)
 - [Performing a Flashback Database Operation for a Whole CDB](#) (page 18-19)
 - [Performing a Flashback Database Operation for PDBs](#) (page 18-22)
 - [Performing Flashback Database with SQL*Plus](#) (page 30-1)
-
-

18.1.3.1 About Flashback Database and PITR for PDBs

For pluggable databases (PDBs) that use local undo, database point-in-time recovery (PITR) and flashback operations are independent of each other.

For PDBs that use shared undo, database point-in-time recovery and flashback operations are independent with the following caveat:

- If you perform a flashback operation for a PDB or recover a PDB to a particular point in time, Oracle Database may apply undo data during the PDB resetlogs operation to back out transactions that are not committed at that point in time. If you subsequently recover the entire [multitenant container database \(CDB\)](#) to a point in time that is in the middle of the PDB resetlogs operation, then you will receive a warning that some PDBs may not be opened. For such PDBs, you need to perform one of the following mutually exclusive actions:
 - Recover the entire CDB or perform a flashback operation for the entire CDB to a different SCN

- Recover all the affected PDBs or perform a flashback database operation for all the affected PDBs to a different SCN

See Also:

- [Basic Concepts of Performing Flashback Database for CDBs and PDBs](#) (page 18-4)
 - [About Undo and Flashback Database Operations for PDBs](#) (page 18-6)
 - [About Managing Redo Corruption in CDBs](#) (page 18-6)
-

18.1.3.2 About Undo and Flashback Database Operations for PDBs

A multitenant container database (CDB) can use shared undo or local undo. The technique used by RMAN to perform flashback database operations depends on the type of undo configuration for the CDB.

When a CDB uses local undo, performing a flashback database operation on a [pluggable database \(PDB\)](#) is straight-forward because only data files related to that PDB need to be modified.

In the case of a CDB that uses shared undo, since one set of tablespaces is shared by all PDBs, undo data for multiple PDBs may be mixed within the undo tablespaces and even within individual data blocks. Therefore, to perform a flashback database operation for a PDB, RMAN automatically uses an auxiliary instance to restore shared undo tablespaces and certain tablespaces in the root and then recovers data to the required point in time. This process may involve restoring backups for a relatively small amount of data. When you perform a flashback database operation on a PDB to a clean PDB restore point, no auxiliary instance or restoring of backups is required.

By default, the auxiliary instance is created in the fast recovery area. You can use the `AUXILIARY DESTINATION` clause in the `FLASHBACK DATABASE` command to specify an alternate location for the auxiliary instance.

See Also:

- [Basic Concepts of Performing Flashback Database for CDBs and PDBs](#) (page 18-4)
 - [About Flashback Database and PITR for PDBs](#) (page 18-5)
 - [About Managing Redo Corruption in CDBs](#) (page 18-6)
 - [Performing a Flashback Database Operation for a Whole CDB](#) (page 18-19)
 - [Performing a Flashback Database Operation for PDBs](#) (page 18-22)
-

18.1.3.3 About Managing Redo Corruption in CDBs

In very rare circumstances, the redo logs in a [multitenant container database \(CDB\)](#) may be corrupted. In such a scenario, if the affected data blocks reside only in one of the pluggable databases (PDBs), then you can do one of the following:

- perform a flashback operation on the PDB to a point in time before the corruption and then open the PDB with `RESETLOGS`
- perform a point-in-time recovery of the PDB to a point in time before the corruption and then open the PDB with `RESETLOGS`

After you perform one of these steps on the primary database, any standby database of this primary database can also skip the corrupted redo provided you perform the steps required to enable a standby to follow a primary after a PITR or Flashback on the PDB.

See Also:

- [Basic Concepts of Performing Flashback Database for CDBs and PDBs](#) (page 18-4)
 - [About Undo and Flashback Database Operations for PDBs](#) (page 18-6)
 - [About Flashback Database and PITR for PDBs](#) (page 18-5)
 - *Oracle Data Guard Concepts and Administration Guide* for steps to enable a standby to follow a primary
-
-

18.2 Rewinding a Table with Flashback Table

Flashback Table uses information in the undo tablespace rather than restored backups to retrieve the table. When a Flashback Table operation occurs, new rows are deleted and old rows are reinserted. The rest of your database remains available while the flashback of the table is being performed.

This section contains the following topics:

- [Prerequisites for Flashback Table](#) (page 18-7)
- [Performing a Flashback Table Operation](#) (page 18-8)

See Also:

Oracle Database Administrator's Guide for more information about Automatic Undo Management

18.2.1 Prerequisites for Flashback Table

To use the Flashback Table feature on one or more tables, use the `FLASHBACK TABLE` SQL statement with a target time or SCN.

You must have the following privileges to use the Flashback Table feature:

- You must have been granted the `FLASHBACK ANY TABLE` system privilege or you must have the `FLASHBACK` object privilege on the table.
- You must have `READ` or `SELECT`, `INSERT`, `DELETE`, and `ALTER` privileges on the table.

- To flash back a table to a restore point, you must have the `SELECT ANY DICTIONARY` or `FLASHBACK ANY TABLE` system privilege or the `SELECT_CATALOG_ROLE` role.

For an object to be eligible to be flashed back, the following prerequisites must be met:

- The object must **not** be included the following categories: tables that are part of a cluster, materialized views, Advanced Queuing (AQ) tables, static data dictionary tables, system tables, remote tables, object tables, nested tables, or individual table partitions or subpartitions.
- The structure of the table must not have been changed between the current time and the target flashback time.

The following Data Definition Language (DDL) operations change the structure of a table: upgrading, moving, or truncating a table; adding a constraint to a table, adding a table to a cluster; modifying or dropping a column; adding, dropping, merging, splitting, coalescing, or truncating a partition or subpartition (except adding a range partition).

- Row movement must be enabled on the table, which indicates that rowids change after the flashback occurs.

This restriction exists because if rowids before the flashback were stored by the application, then there is no guarantee that the rowids correspond to the same rows after the flashback. If your application depends on rowids, then you cannot use Flashback Table.

- The undo data in the [undo tablespace](#) must extend far enough back in time to satisfy the flashback target time or SCN.

The point to which you can perform Flashback Table is determined by the [undo retention period](#), which is the minimal time for which undo data is kept before being recycled, and tablespace characteristics. The undo data contains information about data blocks before they were changed. The flashback operation uses undo to re-create the original data.

To ensure that the undo information is retained for Flashback Table operations, Oracle suggests setting the `UNDO_RETENTION` parameter to 86400 seconds (24 hours) or greater for the undo tablespace.

Note:

`FLASHBACK TABLE . . . TO BEFORE DROP` is a use of the Flashback Drop feature, not Flashback Table, and therefore is not subject to these prerequisites. See "[Rewinding a DROP TABLE Operation with Flashback Drop](#) (page 18-10)" for more information.

18.2.2 Performing a Flashback Table Operation

In this scenario, assume that you want to perform a flashback of the `hr.temp_employees` table after a user made some incorrect updates.

To perform a flashback of `temp_employees`:

1. Ensure that the prerequisites described in [Prerequisites for Flashback Table](#) (page 18-7) are met.

2. Connect SQL*Plus to the target database and identify the current SCN.

You cannot roll back a `FLASHBACK TABLE` statement, but you can issue another `FLASHBACK TABLE` statement and specify a time just before the current time. Therefore, it is advisable to record the current SCN. You can obtain it by querying `V$DATABASE` as follows:

```
SELECT CURRENT_SCN FROM V$DATABASE;
```

3. Identify the time, SCN, or restore point to which you want to return the table.

If you have created restore points, then you can list available restore points by executing the following query:

```
SELECT NAME, SCN, TIME FROM V$RESTORE_POINT;
```

4. Ensure that enough undo data exists to rewind the table to the specified target.

If the `UNDO_RETENTION` initialization parameter is set, and the undo retention guarantee is on, then you can use the following query to determine how long undo data is being retained:

```
SELECT NAME, VALUE/60 MINUTES_RETAINED
FROM V$PARAMETER
WHERE NAME = 'undo_retention';
```

5. Ensure that row movement is enabled for all objects that you are rewinding with Flashback Table.

You can enable row movement for a table with the following SQL statement, where *table* is the name of the table that you are rewinding:

```
ALTER TABLE table ENABLE ROW MOVEMENT;
```

6. Determine whether the table that you intend to flash back has dependencies on other tables. If dependencies exist, then decide whether to flash back these tables as well.

You can issue the following SQL query to determine the dependencies, where *schema_name* is the schema for the table to be flashed back and *table_name* is the name of the table:

```
SELECT other.owner, other.table_name
FROM sys.all_constraints this, sys.all_constraints other
WHERE this.owner = schema_name
AND this.table_name = table_name
AND this.r_owner = other.owner
AND this.r_constraint_name = other.constraint_name
AND this.constraint_type='R';
```

7. Execute a `FLASHBACK TABLE` statement for the objects to flash back.

The following SQL statement returns the `hr.temp_employees` table to the restore point named `temp_employees_update`:

```
FLASHBACK TABLE hr.temp_employees
TO RESTORE POINT temp_employees_update;
```

The following SQL statement rewinds the `hr.temp_employees` table to its state when the database was at the time specified by the SCN:

```
FLASHBACK TABLE hr.temp_employees  
TO SCN 123456;
```

As shown in the following example, you can also specify the target point in time with `TO_TIMESTAMP`:

```
FLASHBACK TABLE hr.temp_employees  
TO TIMESTAMP TO_TIMESTAMP('2013-10-17 09:30:00', 'YYYY-MM-DD HH:MI:SS');
```

Note:

The mapping of time stamps to SCNs is not always exact. When you use time stamps with the `FLASHBACK TABLE` statement, the time to which the table is flashed back can vary by up to approximately 3 seconds of the time specified for `TO_TIMESTAMP`. If an exact point in time is required, then use an SCN rather than a time.

8. Optionally, query the table to check the data.

See Also: [Keeping Triggers Enabled During Flashback Table](#) (page 18-10)

18.2.2.1 Keeping Triggers Enabled During Flashback Table

By default, the database disables triggers on the affected table before performing a `FLASHBACK TABLE` operation. After the operation, the database returns the triggers to the state they were in before the operation (enabled or disabled). To keep triggers enabled during the flashback of the table, add an `ENABLE TRIGGERS` clause to the `FLASHBACK TABLE` statement in Step 7 (page 18-9).

For example, assume that at 17:00 an HR administrator discovers that an employee is missing from the `hr.temp_employees` table. This employee was included in the table at 14:00, the last time the report was run. Therefore, someone accidentally deleted the record for this employee between 14:00 and 17:00. The HR administrator uses Flashback Table to return the table to its state at 14:00, respecting any triggers set on the `hr.temp_employees` table, by using the SQL statement in the following example:

```
FLASHBACK TABLE hr.temp_employees  
TO TIMESTAMP TO_TIMESTAMP('2013-03-03 14:00:00', 'YYYY-MM-DD HH:MI:SS')  
ENABLE TRIGGERS;
```

See Also:

- *Oracle Database Administrator's Guide* to learn how to recover tables with the Flashback Table feature
 - *Oracle Database SQL Language Reference* for a simple Flashback Table scenario
-
-

18.3 Rewinding a DROP TABLE Operation with Flashback Drop

This section explains how to retrieve objects from the recycle bin with the `FLASHBACK TABLE ... TO BEFORE DROP` statement.

This section contains the following topics:

- [About Flashback Drop](#) (page 18-11)
- [Prerequisites of Flashback Drop](#) (page 18-11)
- [Performing a Flashback Drop Operation](#) (page 18-12)

18.3.1 About Flashback Drop

Flashback Drop reverses the effects of a `DROP TABLE` operation. Flashback Drop is faster than other recovery mechanisms that can be used in this situation, such as point-in-time recovery, and does not lead to downtime or loss of recent transactions.

When you drop a table, the database does not immediately remove the space associated with the table. Instead, the table is renamed and, along with any associated objects, placed in the recycle bin. System-generated recycle bin object names are unique. You can query objects in the recycle bin, just as you can query other objects.

A flashback operation retrieves the table from the recycle bin. When retrieving dropped tables, you can specify either the original user-specified name of the table or the system-generated name.

When you drop a table, the table and all of its dependent objects go into the recycle bin together. Likewise, when you perform Flashback Drop, the objects are generally all retrieved together. When you restore a table from the recycle bin, dependent objects such as indexes do not get their original names back; they retain their system-generated recycle bin names. Oracle Database retrieves all indexes defined on the table except for bitmap join indexes, and all triggers and constraints defined on the table except for referential integrity constraints that reference other tables.

Some dependent objects such as indexes may possibly have been reclaimed because of space pressure. In such cases, the reclaimed dependent objects are not retrievable from the recycle bin.

18.3.2 Prerequisites of Flashback Drop

The following list summarizes the user privileges required for the operations related to Flashback Drop and the recycle bin:

- `DROP`
Any user with `DROP` privileges over an object can drop the object, placing it in the recycle bin.
- `FLASHBACK TABLE ... TO BEFORE DROP`
Privileges for this statement are tied to the privileges for `DROP`. That is, any user who can drop an object can perform Flashback Drop to retrieve the dropped object from the recycle bin.
- `PURGE`
Privileges for a purge of the recycle bin are tied to the `DROP` privileges. Any user having `DROP TABLE`, `DROP ANY TABLE`, or `PURGE DBA_RECYCLE_BIN` privileges can purge the objects from the recycle bin.
- `READ` or `SELECT` and `FLASHBACK` for objects in the Recycle Bin
Users must have the `READ` or `SELECT` and `FLASHBACK` privileges over an object in the recycle bin to query the object in the recycle bin. Any users who had the `READ`

or `SELECT` privilege over an object before it was dropped continue to have the `READ` or `SELECT` privilege over the object in the recycle bin. Users must have `FLASHBACK` privilege to query any object in the recycle bin, because these are objects from a past state of the database.

Objects must meet the following prerequisites to be eligible for retrieval from the recycle bin:

- The recycle bin is only available for non-system, locally managed tablespaces. If a table is in a non-system, locally managed tablespace, but one or more of its dependent segments (objects) is in a dictionary-managed tablespace, then these objects are protected by the recycle bin.
- Tables that have fine-grained auditing (FGA) and Virtual Private Database (VPD) policies defined over them are not protected by the recycle bin.
- Partitioned index-organized tables are not protected by the recycle bin.
- The table must not have been purged, either by a user or by Oracle Database during a space reclamation operation.

18.3.3 Performing a Flashback Drop Operation

Use the `FLASHBACK TABLE . . . TO BEFORE DROP` statement to recover objects from the recycle bin. You can specify either the name of the table in the recycle bin or the original table name.

This section assumes a scenario in which you drop the wrong table. Many times you have been asked to drop tables in the test databases, but in this case you accidentally connect to the production database instead and drop `hr.employee_demo`. You decide to use `FLASHBACK TABLE` to retrieve the dropped object.

To retrieve a dropped table:

1. Ensure that the prerequisites described in [Prerequisites of Flashback Drop](#) (page 18-11) are met.
2. Connect SQL*Plus to the target database and obtain the name of the dropped table in the recycle bin.

You can use the SQL*Plus command `SHOW RECYCLEBIN` as follows:

```
SHOW RECYCLEBIN;
```

ORIGINAL_NAME	RECYCLEBIN_NAME	TYPE	DROP TIME
EMPLOYEE_DEMO	BIN\$gk31sj/3akk5hg3j21k15j3d==\$0	TABLE	2013-04-11:17:08:54

The `ORIGINAL_NAME` column shows the original name of the object, whereas the `RECYCLEBIN_NAME` column shows the name of the object as it exists in the bin.

Alternatively, you can query `USER_RECYCLEBIN` or `DBA_RECYCLEBIN` to obtain the table name. The following example queries the `RECYCLEBIN` view to determine the original names of dropped objects:

```
SELECT object_name AS recycle_name, original_name, type
FROM recyclebin;
```

RECYCLE_NAME	ORIGINAL_NAME	TYPE
-----	-----	-----

```

BIN$gk3lsj/3akk5hg3j2lk15j3d==$0 EMPLOYEE_DEMO TABLE
BIN$JKS983293M1dsab4gsz/I249==$0 I_EMP_DEMO INDEX

```

If you plan to manually restore original names for dependent objects, then ensure that you make note of each dependent object's system-generated recycle bin name before you restore the table.

Note:

Object views such as DBA_TABLES do not display the recycle bin objects.

3. Optionally, query the table in the recycle bin.

You must use the recycle bin name of the object in your query rather than the object's original name. The following example queries the table with the recycle bin name of BIN\$gk3lsj/3akk5hg3j2lk15j3d==\$0:

```

SELECT *
FROM "BIN$gk3lsj/3akk5hg3j2lk15j3d==$0";

```

Quotation marks are required because of the special characters in the recycle bin name.

Note:

If you have the necessary privileges, then you can also use Flashback Query on tables in the recycle bin, but only by using the recycle bin name rather than the original table name. You cannot use Data Manipulation Language (DML) or DDL statements on objects in the recycle bin.

4. Retrieve the dropped table.

Use the FLASHBACK TABLE ... TO BEFORE DROP statement. The following example restores the BIN\$gk3lsj/3akk5hg3j2lk15j3d==\$0 table, changes its name back to hr.employee_demo, and purges its entry from the recycle bin:

```
FLASHBACK TABLE "BIN$gk3lsj/3akk5hg3j2lk15j3d==$0" TO BEFORE DROP;
```

The table name is enclosed in quotation marks because of the possibility of special characters appearing in the recycle bin object names.

Alternatively, you can use the original name of the table:

```
FLASHBACK TABLE HR.EMPLOYEE_DEMO TO BEFORE DROP;
```

You can also assign a new name to the restored table by specifying the RENAME TO clause. For example:

```
FLASHBACK TABLE "BIN$gk3lsj/3akk5hg3j2lk15j3d==$0" TO BEFORE DROP
RENAME TO hr.emp_demo;
```

5. Optionally, verify that all dependent objects retained their system-generated recycle bin names.

The following query determines the names of the indexes of the retrieved hr.employee_demo table:

```
SELECT INDEX_NAME
FROM   USER_INDEXES
WHERE  TABLE_NAME = 'EMPLOYEE_DEMO';
```

```
INDEX_NAME
-----
BIN$JKS983293M1dsab4gsz/I249==$0
```

- Optionally, rename the retrieved indexes to their original names.

The following statement renames the index to its original name of `i_emp_demo`:

```
ALTER INDEX "BIN$JKS983293M1dsab4gsz/I249==$0" RENAME TO I_EMP_DEMO;
```

- If the retrieved table had referential constraints before it was placed in the recycle bin, then re-create them.

This step must be performed manually because the recycle bin does not preserve referential constraints on a table.

See Also:

[Retrieving Objects Using Flashback Drop When Multiple Objects Share the Same Original Name](#) (page 18-14)

18.3.3.1 Retrieving Objects Using Flashback Drop When Multiple Objects Share the Same Original Name

You can create, and then drop, several objects with the same original name. All dropped objects are stored in the recycle bin. For example, consider the SQL statements in [Example 18-1](#) (page 18-14).

See Also:

- Oracle Database Administrator's Guide* to learn how to use Flashback Drop and manage the recycle bin
 - Oracle Database SQL Language Reference* for information about the `FLASHBACK TABLE` statement
-
-

Example 18-1 Dropping Multiple Objects with the Same Name

```
CREATE TABLE temp_employees ( ...columns ); # temp_employees version 1
DROP TABLE temp_employees;
```

```
CREATE TABLE temp_employees ( ...columns ); # temp_employees version 2
DROP TABLE temp_employees;
```

```
CREATE TABLE temp_employees ( ...columns ); # temp_employees version 3
DROP TABLE temp_employees;
```

In [Example 18-1](#) (page 18-14), each table `temp_employees` is assigned a unique name in the recycle bin when it is dropped. You can use a `FLASHBACK TABLE ... TO BEFORE DROP` statement with the original name of the table, as shown in this example:

```
FLASHBACK TABLE temp_employees TO BEFORE DROP;
```

The most recently dropped table with this original name is retrieved from the recycle bin, with its original name. [Example 18-2](#) (page 18-15) shows the retrieval from the recycle bin of all three dropped `temp_employees` tables from the previous example, with each assigned a new name.

Example 18-2 Renaming Dropped Tables

```
FLASHBACK TABLE temp_employees TO BEFORE DROP
  RENAME TO temp_employees_VERSION_3;
FLASHBACK TABLE temp_employees TO BEFORE DROP
  RENAME TO temp_employees_VERSION_2;
FLASHBACK TABLE temp_employees TO BEFORE DROP
  RENAME TO temp_employees_VERSION_1;
```

Because the original name in `FLASHBACK TABLE` refers to the most recently dropped table with this name, the last table dropped is the first retrieved.

You can also retrieve any table from the recycle bin, regardless of any collisions among original names, by using the unique recycle bin name of the table. For example, assume that you query the recycle bin as follows (sample output included):

```
SELECT object_name, original_name, createtime
FROM recyclebin;
```

OBJECT_NAME	ORIGINAL_NAME	CREATETIME
BIN\$yrMKlZaLMhfgNagAIMenRA==\$0	TEMP_EMPLOYEES	2013-02-05:21:05:52
BIN\$yrMKlZaVMhfgNagAIMenRA==\$0	TEMP_EMPLOYEES	2013-02-05:21:25:13
BIN\$yrMKlZaQMhfgNagAIMenRA==\$0	TEMP_EMPLOYEES	2013-02-05:22:05:53

You can use the following command to retrieve the middle table:

```
FLASHBACK TABLE BIN$yrMKlZaVMhfgNagAIMenRA==$0 TO BEFORE DROP;
```

18.4 Rewinding a Database with Flashback Database

This section explains the most common scenario for using Flashback Database to reverse unwanted changes to your database.

This section contains the following topics:

- [Prerequisites of Flashback Database](#) (page 18-15)
- [Performing a Flashback Database Operation](#) (page 18-16)
- [Performing a Flashback Database Operation for a Whole CDB](#) (page 18-19)
- [Performing a Flashback Database Operation for PDBs](#) (page 18-22)
- [Monitoring Flashback Database](#) (page 18-24)

18.4.1 Prerequisites of Flashback Database

To use the `FLASHBACK DATABASE` command to return your database contents to points in time within the flashback window, your database must have been previously configured for flashback logging as described in "[Overview of Flashback Database Restore Points and Guaranteed Restore Points](#) (page 7-1)". To return the database to a guaranteed restore point, you must have previously defined a guaranteed restore point as described in "[Using Normal and Guaranteed Restore Points](#) (page 7-11)".

Flashback Database works by undoing changes to the data files that exist at the moment that you run the command. Note the following important prerequisites:

- No current data files are lost or damaged. You can only use `FLASHBACK DATABASE` to rewind changes to a data file made by an Oracle database, not to repair media failures.
- You are not trying to recover from accidental deletion of data files, undo a shrink data file operation, or undo a change to the database name.
- You are not trying to use `FLASHBACK DATABASE` to return to a point in time before the restore or re-creation of a control file. If the database control file is restored from backup or re-created, then all accumulated flashback log information is discarded.
- You are not trying to use `FLASHBACK DATABASE` to undo a compatibility change.

See Also:

Oracle Database Backup and Recovery Reference for a complete list of command prerequisites and usage notes for `FLASHBACK DATABASE`

18.4.2 Performing a Flashback Database Operation

This section presents a basic technique for performing a flashback of the database, specifying the desired target point in time with a time expression, the name of a normal or guaranteed restore point, or an SCN.

This scenario assumes that you are rewinding the database to a point in time within the current database [incarnation](#). To return the database to the point in time immediately before the most recent `OPEN RESETLOGS` operation, see "[Rewinding an OPEN RESETLOGS Operation with Flashback Database](#) (page 18-35)".

By default, an SCN used in a `FLASHBACK DATABASE` command refers to an SCN in the [direct ancestral path](#) of the database incarnations. As explained in "[About Database Incarnations](#) (page 14-7)", an incarnation is in this path if it was not abandoned after the database was previously opened with the `RESETLOGS` option. To retrieve changes in abandoned incarnations, see "[Rewinding the Database to an SCN in an Abandoned Incarnation Branch](#) (page 18-36)".

To perform a Flashback Database operation:

1. Ensure that the prerequisites described in [Prerequisites of Flashback Database](#) (page 18-15) are met.
2. Connect SQL*Plus to the target database and determine the desired SCN, restore point, or point in time for the `FLASHBACK DATABASE` command.

Obtain the earliest SCN in the flashback database window as follows:

```
SELECT OLDEST_FLASHBACK_SCN, OLDEST_FLASHBACK_TIME
FROM   V$FLASHBACK_DATABASE_LOG;
```

The most recent SCN that can be reached with Flashback Database is the current SCN of the database. The following query returns the current SCN:

```
SELECT CURRENT_SCN
FROM   V$DATABASE;
```

You can query available guaranteed restore points as follows (sample output included):

```
SELECT NAME, SCN, TIME, DATABASE_INCARNATION#,
       GUARANTEE_FLASHBACK_DATABASE
FROM   V$RESTORE_POINT
WHERE  GUARANTEE_FLASHBACK_DATABASE='YES';
```

NAME	SCN	TIME	DATABASE_INCARNATION#	GUA
BEFORE_CHANGES	5753126	04-MAR-12 12.39.45 AM	2	YES

Note:

If the flashback window does not extend far enough back into the past to reach the desired target time, and if you do not have a guaranteed restore point at the desired time, then you can achieve similar results by using database point-in-time recovery, as described in "[Performing Database Point-in-Time Recovery](#) (page 18-25)".

3. Shut down the database consistently, ensure that it is not opened by any instance, and then mount it:

```
SHUTDOWN IMMEDIATE;
STARTUP MOUNT;
```

4. Repeat the query in Step 1 of this procedure.

Some flashback logging data is generated when the database is shut down. If flashback logs were deleted due to space pressure in the fast recovery area, then your target SCN may not be reachable.

Note:

If you run `FLASHBACK DATABASE` when your target SCN is outside the flashback window, then `FLASHBACK DATABASE` fails with an `ORA-38729` error. In this case your database does not change.

5. Start RMAN and connect to the target database.

See Also:

["Making Database Connections with RMAN](#) (page 4-2)"

6. Run the `SHOW` command to see which channels are preconfigured.

During the flashback operation, RMAN may need to restore archived redo logs from backup. Enter the following command to see whether channels are configured (sample output is included):

```
SHOW ALL;
```

```
RMAN configuration parameters for database with db_unique_name PROD1 are:
```

```
.
.
.
```

```
CONFIGURE DEFAULT DEVICE TYPE TO DISK; # default
CONFIGURE DEVICE TYPE DISK PARALLELISM 1 BACKUP TYPE TO BACKUPSET; # default
CONFIGURE DEVICE TYPE SBT_TAPE PARALLELISM 1 BACKUP TYPE TO BACKUPSET; # default
CONFIGURE CHANNEL DEVICE TYPE 'SBT_TAPE' PARMS "SBT_LIBRARY=/usr/local/oracle/
backup/lib/libobk.so";
```

If the necessary devices and channels are configured, then no action is necessary. Otherwise, use the `CONFIGURE` command to configure automatic channels, or include `ALLOCATE CHANNEL` commands within a `RUN` block.

7. Run the `RMAN FLASHBACK DATABASE` command.

You can specify the target time by using a form of the command shown in the following examples:

```
FLASHBACK DATABASE TO SCN 46963;

FLASHBACK DATABASE
  TO RESTORE POINT BEFORE_CHANGES;

FLASHBACK DATABASE TO TIME
  "TO_DATE('09/20/12','MM/DD/YY')";
```

When the `FLASHBACK DATABASE` command completes, the database is left mounted and recovered to the specified target time.

8. Open the database read-only in SQL*Plus and run some queries to verify the database contents.

Open the database read-only as follows:

```
ALTER DATABASE OPEN READ ONLY;
```

If you are satisfied with the state of the database, then end the procedure with Step 9 (page 18-18). If you are *not* satisfied with the state of the database, skip to Step 10 (page 18-19).

9. If you are satisfied with the results, then perform either of the following mutually exclusive actions:

- Make the database available for updates by opening the database with the `RESETLOGS` option. If the database is currently open read-only, then execute the following commands in SQL*Plus:

```
SHUTDOWN IMMEDIATE
STARTUP MOUNT
ALTER DATABASE OPEN RESETLOGS;
```

Note:

After you perform this `OPEN RESETLOGS` operation, all changes to the database after the target SCN for `FLASHBACK DATABASE` are abandoned. Nevertheless, you can use the technique in "[Rewinding the Database to an SCN in an Abandoned Incarnation Branch](#)" (page 18-36) to return the database to that range of SCNs while they remain in the flashback window.

- Use Oracle Data Pump Export to make a logical backup of the objects whose state was corrupted. Afterward, use `RMAN` to recover the database to the present time:

```
RECOVER DATABASE;
```

This step undoes the effect of the Flashback Database by reapplying all changes in the redo logs to the database, returning it to the most recent SCN.

After reopening the database read/write, you can import the exported objects with the Data Pump Import utility. See *Oracle Database Utilities* to learn how to use Data Pump.

10. If you find that you used the wrong restore point, time, or SCN for the flashback, then mount the database and perform one of the following mutually exclusive options:

- If your chosen target time was not far enough in the past, then use another `FLASHBACK DATABASE` command to rewind the database further back in time:

```
FLASHBACK DATABASE TO SCN 42963; #earlier than current SCN
```

- If you chose a target SCN that is too far in the past, then use `RECOVER DATABASE UNTIL` to wind the database forward in time to the desired SCN:

```
RECOVER DATABASE UNTIL SCN 56963; #later than current SCN
```

- If you want to completely undo the effect of the `FLASHBACK DATABASE` command, then you can perform complete recovery of the database by using the `RECOVER DATABASE` command without an `UNTIL` clause or `SET UNTIL` command:

```
RECOVER DATABASE;
```

The `RECOVER DATABASE` command reapplies all changes to the database, returning it to the most recent SCN.

18.4.3 Performing a Flashback Database Operation for a Whole CDB

You can perform a flashback database operation for a whole multitenant container database (CDB) using the `FLASHBACK DATABASE` command.

When `COMPATIBLE` is set to 12.1.0, in rare cases, performing a flashback database operation on a CDB across PDB (pluggable database) point-in-time recovery (PITR) or PDB flashback may result in the following error:

```
ORA-39866: Data files for Pluggable Database <PDB_name> must be
offline to flashback across special 12.1 PDB resetlogs
```

To resolve this error and perform a flashback operation on a CDB across PDB PITR or PDB flashback, use the steps described in “Performing Flashback Database Operations on a CDB When a PDB Was Recovered Using DBPITR” in the *Oracle Database Backup and Recovery User’s Guide 12c Release 1 (12.1)*.

The steps to perform a Flashback Database operation for a CDB are similar to the ones used for non-CDBs, with the differences described below.

To perform a flashback database operation for a whole CDB:

1. Ensure that the prerequisites described in [Prerequisites of Flashback Database](#) (page 18-15) are met.
2. Connect SQL*Plus to the target CDB and determine the desired SCN, restore point, or point in time for the `FLASHBACK DATABASE` command.

Obtain the earliest SCN in the flashback database window as follows:

```
SELECT OLDEST_FLASHBACK_SCN, OLDEST_FLASHBACK_TIME
FROM V$FLASHBACK_DATABASE_LOG;
```

The most recent SCN that can be reached with Flashback Database is the current SCN of the database. The following query returns the current SCN:

```
SELECT CURRENT_SCN
FROM V$DATABASE;
```

You can query available guaranteed restore points as follows (sample output included):

```
SELECT NAME, SCN, TIME, DATABASE_INCARNATION#,
       GUARANTEE_FLASHBACK_DATABASE
FROM V$RESTORE_POINT
WHERE GUARANTEE_FLASHBACK_DATABASE='YES';
```

NAME	SCN	TIME	DATABASE_INCARNATION#	GUA
BEFORE_CHANGES	5753126	04-MAR-12 12.39.45 AM		2 YES

Note:

If the flashback window does not extend far enough back into the past to reach the desired target time, and if you do not have a guaranteed restore point at the desired time, then you can achieve similar results by using database point-in-time recovery, as described in "[Performing Point-in-Time Recovery of a Whole CDB](#) (page 18-28)".

3. Shut down the database consistently, ensure that it is not opened by any instance, and then mount it:

```
SHUTDOWN IMMEDIATE;
STARTUP MOUNT;
```

4. Repeat the query in Step 2 of this procedure.

Some flashback logging data is generated when the database is shut down. If flashback logs were deleted due to space pressure in the fast recovery area, then your target SCN may not be reachable.

Note:

If you run FLASHBACK DATABASE when your target SCN is outside the flashback window, then FLASHBACK DATABASE fails with an ORA-38729 error. In this case your database does not change.

5. Connect to the root as a common user with the SYSDBA or SYSBACKUP privilege as described in [Making Database Connections with RMAN](#) (page 4-2).
6. Run the SHOW command to see which channels are preconfigured.

During the flashback operation, RMAN may need to restore archived redo logs from backup. Enter the following command to see whether channels are configured (sample output is included):

```
SHOW ALL;
```

If the necessary devices and channels are configured, then no action is necessary. Otherwise, use the `CONFIGURE` command to configure automatic channels, or include `ALLOCATE CHANNEL` commands within a `RUN` block.

7. Run the `FLASHBACK DATABASE` command to perform a flashback operation for the whole CDB to a specified point in time.

You can specify the target time by using an SCN, a time expression, or a [CDB restore point](#).

The following examples perform a flashback database operation for the whole CDB:

```
FLASHBACK DATABASE TO SCN 345588;
FLASHBACK DATABASE TO RESTORE POINT cdb_before_upgrade;
```

8. Open the CDB read-only in SQL*Plus and run some queries to verify the database contents.

Open the CDB read-only as follows:

```
ALTER DATABASE OPEN READ ONLY;
```

If you are satisfied with the state of the database, then end the procedure with Step 9 (page 18-18). If you are *not* satisfied with the state of the database, skip to Step 10 (page 18-19).

9. If you are satisfied with the results, then perform either of the following mutually exclusive actions:

- Make the database available for updates by opening the database with the `RESETLOGS` option. If the database is currently open read-only, then execute the following commands in SQL*Plus:

```
SHUTDOWN IMMEDIATE
STARTUP MOUNT
ALTER DATABASE OPEN RESETLOGS;
```

Note:

After you perform this `OPEN RESETLOGS` operation, all changes to the database after the target SCN for `FLASHBACK DATABASE` are abandoned. Nevertheless, you can use the technique in "[Rewinding the Database to an SCN in an Abandoned Incarnation Branch](#) (page 18-36)" to return the database to that range of SCNs while they remain in the flashback window.

- Use Oracle Data Pump Export to make a logical backup of the objects whose state was corrupted. Afterward, use RMAN to recover the database to the present time:

```
RECOVER DATABASE;
```

This step undoes the effect of the Flashback Database by reapplying all changes in the redo logs to the database, returning it to the most recent SCN.

After reopening the database read/write, you can import the exported objects with the Data Pump Import utility. See *Oracle Database Utilities* to learn how to use Data Pump.

10. If you find that you used the wrong restore point, time, or SCN for the flashback, then mount the database and perform one of the following mutually exclusive options:

- If your chosen target time was not far enough in the past, then use another `FLASHBACK DATABASE` command to rewind the database further back in time:

```
FLASHBACK DATABASE TO SCN 42963; #earlier than current SCN
```

- If you chose a target SCN that is too far in the past, then use `RECOVER DATABASE UNTIL` to wind the database forward in time to the desired SCN:

```
RECOVER DATABASE UNTIL SCN 56963; #later than current SCN
```

- If you want to completely undo the effect of the `FLASHBACK DATABASE` command, then you can perform complete recovery of the database by using the `RECOVER DATABASE` command without an `UNTIL` clause or `SET UNTIL` command:

```
RECOVER DATABASE;
```

The `RECOVER DATABASE` command reapplies all changes to the database, returning it to the most recent SCN.

11. Since the [PDBs](#) are not automatically opened when the CDB is opened, open the PDBs.

The following command, when connected to the root, opens all the PDBs:

```
ALTER PLUGGABLE DATABASE ALL OPEN;
```

If you want to open only some PDBs, then you can open each PDB separately. The following command, when connected to the root, opens the PDB `my_pdb`.

```
ALTER PLUGGABLE DATABASE my_pdb OPEN;
```

See Also:

- [About CDB Restore Points](#) (page 7-6)
 - [About Managing Redo Corruption in CDBs](#) (page 18-6)
 - [Performing a Flashback Database Operation for PDBs](#) (page 18-22)
-

18.4.4 Performing a Flashback Database Operation for PDBs

You can perform a flashback database operation for a single pluggable database (PDB) in a multitenant container database (CDB) using the `FLASHBACK DATABASE` command.

Performing a Flashback Database operation on a particular [PDB](#) modifies only data files related to that PDB. The other PDBs in the [CDB](#) are not impacted and are available for use.

When using restore points, you can perform a flashback database operation either to a [CDB restore point](#), [PDB restore point](#), PDB clean restore point, or PDB guaranteed restore point.

To perform a Flashback Database operation for a PDB:

1. Connect to the root as a common user with the `SYSDBA` or `SYSBACKUP` privilege.

See [Making Database Connections with RMAN](#) (page 4-2).

2. Ensure that the CDB is open.

The following command, when connected to the root, displays the mode in which the CDB is open.

```
SELECT open_mode from V$DATABASE;
```

3. Determine the desired SCN, restore point, or point in time for the Flashback Database command.

Query the `V$RESTORE_POINT` view to obtain the list of PDB restore points. `V$FLASHBACK_DATABASE_LOG` displays the oldest SCN to which a flashback operation can be performed.

4. Ensure that the PDB for which the Flashback Database operation must be performed is closed. Other PDBs can be open and operational.

When connected to the root, the following `ALTER PLUGGABLE DATABASE` command closes the PDB `my_pdb`.

```
ALTER PLUGGABLE DATABASE my_pdb CLOSE;
```

5. Perform a Flashback Database operation for the specified PDB to the desired point in time.

The following are some examples of flashback database operations for PDBs.

- For a PDB that uses local undo:

```
FLASHBACK PLUGGABLE DATABASE my_pdb TO SCN 24368;
```

```
FLASHBACK PLUGGABLE DATABASE my_pdb TO RESTORE POINT guar_rp;
```

```
FLASHBACK PLUGGABLE DATABASE my_pdb TO CLEAN RESTORE POINT clean_rp;
```

- For a PDB that uses shared undo, you can optionally include the `AUXILIARY DESTINATION` clause to specify a location for the auxiliary instance that stores data files restored as part of the Flashback Database operation. If you omit this clause, then the auxiliary instance is created in the fast recovery area.

```
FLASHBACK PLUGGABLE DATABASE my_pdb TO SCN 24368 AUXILIARY DESTINATION '+data';
```

```
FLASHBACK PLUGGABLE DATABASE my_pdb TO RESTORE POINT before_appl_changes AUXILIARY DESTINATION '/temp/aux_dest';
```

```
FLASHBACK PLUGGABLE DATABASE my_pdb TO TIME "TO_DATE('03/20/15','MM/DD/YY)";
```

6. Open the PDB with `RESETLOGS`.

The following command opens the PDB named `my_pdb` with `RESETLOGS`:

```
ALTER PLUGGABLE DATABASE my_pdb OPEN RESETLOGS;
```

Note:

Flashback operations are not supported for proxy PDBs.

Note:

- [About Restore Points in PDBs](#) (page 7-7)
 - [Listing Restore Points Using the V\\$RESTORE_POINT View](#) (page 7-15)
 - [About Undo and Flashback Database Operations for PDBs](#) (page 18-6)
 - [Basic Concepts of Performing Flashback Database for CDBs and PDBs](#) (page 18-4)
 - [Performing a Flashback Database Operation for a Whole CDB](#) (page 18-19)
-
-

18.4.5 Monitoring Flashback Database

When you use Flashback Database to rewind a database to a past target time, Flashback Database determines which blocks changed after the target time and restores them from the flashback logs. This is called the **restore phase**. After this phase completes, Flashback Database then uses redo logs to reapply changes that were made after these blocks were written to the flashback logs. This is called the **recovery phase**.

The progress of Flashback Database during the restore phase can be monitored by querying the V\$SESSION_LONGOPS view. The opname is `Flashback Database`. Under the column `TOTALWORK` is the number of megabytes of flashback logs that must be read. The column `SO FAR` in [Example 18-3](#) (page 18-24) lists the number of megabytes that have been currently read.

Example 18-3 Tracking Flashback Database Progress - Restore Phase

```
SQL> SELECT sofar, totalwork, units FROM v$session_longops WHERE opname = 'Flashback Database';
```

```
SO FAR  TOTALWORK  UNITS
-----  -
17          60 Megabytes
```

The progress of Flashback Database during the recovery phase can be monitored by querying the view V\$RECOVERY_PROGRESS.

See Also:

The *Oracle Database Reference* for information about the view V\$RECOVERY_PROGRESS

18.5 Performing Database Point-in-Time Recovery

RMAN DBPITR restores the database from backups before the target time for recovery, then uses incremental backups and redo to roll the database forward to the target time. You can recover to an SCN, time, log sequence number, or restore point. Oracle recommends that you create restore points at important times to make point-in-time recovery more manageable if it ever becomes necessary.

Oracle recommends that you perform Flashback Database rather than database point-in-time recovery if possible. Media recovery with backups are the last option when flashback technologies cannot be used to undo the most recent changes.

This section contains the following topics:

- [Prerequisites of Database Point-in-Time Recovery](#) (page 18-25)
- [Performing Database Point-in-Time Recovery](#) (page 18-25)
- [Performing Point-in-Time Recovery of CDBs and PDBs](#) (page 18-28)
- [Performing Point-in-Time Recovery of Application PDBs](#) (page 18-32)
- [Performing Point-in-Time Recovery of Sparse Databases](#) (page 18-33)

18.5.1 Prerequisites of Database Point-in-Time Recovery

The prerequisites for database point-in-time recovery (DBPITR) are as follows:

- Your database must be running in ARCHIVELOG mode.
- You must have backups of all data files from before the target SCN for DBPITR and archived logs for the period between the SCN of the backups and the target SCN.
- If the backups were encrypted using transparent encryption, and if a password-based software keystore was used, then the keystore password must be provided before the restore operation is performed. Use the `SET` command with the `DECRYPTION WALLET OPEN IDENTIFIED BY` option to specify the password that must be used to open the password-based keystore. Note that this command is not required when an auto-login software keystore is used.

See Also:

Oracle Database Backup and Recovery Reference for the syntax and usage of the `SET` command

For a complete account of command prerequisites and usage notes, refer to the `RECOVER` entry in *Oracle Database Backup and Recovery Reference*.

18.5.2 Performing Database Point-in-Time Recovery

This section explains the basic steps of DBPITR. The procedure makes the following assumptions:

- You are performing DBPITR within the current database [incarnation](#). If your target time is not in the current incarnation, then see "[Recovering the Database to](#)

[an Ancestor Incarnation](#) (page 18-38)" for more information about DBPITR to ancestor incarnations.

- The control file is current. If you must restore a backup control file, then see "[Performing Recovery with a Backup Control File](#) (page 20-4)".
- Your database is using the current server parameter file. If you must restore a backup server parameter file, then see "[Restoring the Server Parameter File](#) (page 20-2)".

When performing DBPITR, you can avoid errors by using the SET UNTIL command to set the target time at the beginning of the procedure, rather than specifying the UNTIL clause on the RESTORE and RECOVER commands individually. This ensures that the data files restored from backup have time stamps early enough to be used in the subsequent RECOVER operation.

To perform DBPITR:

1. Ensure that the prerequisites described in [Prerequisites of Database Point-in-Time Recovery](#) (page 18-25) are met.
2. Determine the time, SCN, restore point, or log sequence that ends recovery.

You can use the Flashback Query features to help you identify when the logical corruption occurred. If you have a [flashback data archive](#) enabled for a table, then you can query data that existed far in the past.

You can also use the alert log to try to determine the time of the event from which you must recover.

Alternatively, you can use a SQL query to determine the log sequence number that contains the target SCN and then recover through this log. For example, run the following query to list the logs in the current database incarnation (sample output included):

```
SELECT RECID, STAMP, THREAD#, SEQUENCE#, FIRST_CHANGE#
       FIRST_TIME, NEXT_CHANGE#
FROM   V$ARCHIVED_LOG
WHERE  RESETLOGS_CHANGE# =
       ( SELECT RESETLOGS_CHANGE#
         FROM   V$DATABASE_INCARNATION
         WHERE  STATUS = 'CURRENT' );
```

RECID	STAMP	THREAD#	SEQUENCE#	FIRST_CHAN	FIRST_TIM	NEXT_CHANG
1	344890611	1	1	20037	24-SEP-13	20043
2	344890615	1	2	20043	24-SEP-13	20045
3	344890618	1	3	20045	24-SEP-13	20046

For example, if you discover that a user accidentally dropped a tablespace at 9:02 a.m., then you can recover to 9 a.m., just before the drop occurred. You lose all changes to the database made after this time.

3. If you are using a target time expression instead of a target SCN, then ensure that the time format environment variables are appropriate before invoking RMAN.

The following are sample Globalization Support settings:

```
NLS_LANG = american_america.us7ascii
NLS_DATE_FORMAT="Mon DD YYYY HH24:MI:SS"
```

4. Connect RMAN to the target database and, if applicable, the recovery catalog database. Bring the database to a mounted state:

```
SHUTDOWN IMMEDIATE;
STARTUP MOUNT;
```

See Also:

["Making Database Connections with RMAN \(page 4-2\)"](#)

5. Perform the following operations within a RUN block:
 - a. For DBPITR, use SET UNTIL to specify the target time, SCN, or log sequence number, or use SET TO to specify a restore point. If specifying a time, then use the date format specified in the NLS_LANG and NLS_DATE_FORMAT environment variables.
 - b. If automatic channels are not configured, then manually allocate disk and tape channels as needed.
 - c. Restore and recover the database.

The following example performs DBPITR on the target database until SCN 1000:

```
RUN
{
  SET UNTIL SCN 1000;
  RESTORE DATABASE;
  RECOVER DATABASE;
}
```

As shown in the following examples, you can also use time expressions, restore points, or log sequence numbers to specify the SET UNTIL time:

```
SET UNTIL TIME 'Nov 15 2013 09:00:00';
SET UNTIL SEQUENCE 9923;
SET TO RESTORE POINT before_update;
```

If the operation completes without errors, then DBPITR has succeeded.

6. Perform either of the following mutually exclusive actions:
 - Open your database for read/write, abandoning all changes after the target SCN. In this case, you must shut down the database, mount it, and then execute the following command:

```
ALTER DATABASE OPEN RESETLOGS;
```

The OPEN RESETLOGS operation fails if a data file is offline unless the data file went offline normally or is read-only. You can bring files in read-only or offline normal tablespaces online after the RESETLOGS because they do not need any redo.
 - Export one or more objects from your database with Data Pump Export. You can then recover the database to the current point in time and reimport the exported objects, thus returning these objects to their state before the unwanted change without abandoning all other changes.

18.5.3 Performing Point-in-Time Recovery of CDBs and PDBs

RMAN enables you to perform point-in-time recovery (PITR) of [CDBs](#) and [PDBs](#). PITR for PDBs can only be performed using RMAN. If you are not using a recovery catalog, it is recommended that you turn on control file auto backups. Otherwise, PITR for PDBs may not work effectively when RMAN needs to undo data file additions or deletions.

The information in this chapter about PITR applies to CDBs, with the differences described in the following sections.

About DBPITR of PDBs and the Fast Recovery Area

When you perform DBPITR of a PDB, all the data files for this PDB are recovered in-place. However, to recover the PDB to the specified target time, RMAN also needs the UNDO tablespace as it existed at the target time. Because the UNDO tablespace is shared by all PDBs, it cannot be recovered in-place. RMAN restores the UNDO, SYSTEM, and SYSAUX tablespaces in the root to an auxiliary database and then uses the undo information to recover the PDB to the target time. If a fast recovery is configured, Oracle Database uses it as the auxiliary destination. If the fast recovery area is not configured, then you must use the `AUXILIARY DESTINATION` clause to specify the location used for auxiliary database files. Ensure that there is sufficient space in the fast recovery area to restore the root tablespaces and the undo tablespace. If the fast recovery area does not have the required space, use an alternate location by specifying the `AUXILIARY DESTINATION` clause.

The following sections contain the steps to perform point-in-time recovery in CDBs and PDBs:

- [Performing Point-in-Time Recovery of a Whole CDB](#) (page 18-28)
- [Performing Point-in-Time Recovery of PDBs](#) (page 18-30)

18.5.3.1 Performing Point-in-Time Recovery of a Whole CDB

The steps to perform PITR of a whole CDB are similar to the ones used for [non-CDBs](#), with the differences described in this section.

To perform point-in-time recovery of a whole CDB:

1. Ensure that the prerequisites described in [Prerequisites of Database Point-in-Time Recovery](#) (page 18-25) are met.
2. Determine the time, SCN, restore point, or log sequence that ends recovery.

You can use the Flashback Query features to help you identify when the logical corruption occurred. If you have a [flashback data archive](#) enabled for a table, then you can query data that existed far in the past.

You can also use the alert log to try to determine the time of the event from which you must recover.

Alternatively, you can use a SQL query to determine the log sequence number that contains the target SCN and then recover through this log. For example, run the following query to list the logs in the current database incarnation (sample output included):

```
SELECT RECID, STAMP, THREAD#, SEQUENCE#, FIRST_CHANGE#  
       FIRST_TIME, NEXT_CHANGE#
```

```

FROM V$ARCHIVED_LOG
WHERE RESETLOGS_CHANGE# =
      ( SELECT RESETLOGS_CHANGE#
        FROM V$DATABASE_INCARNATION
        WHERE STATUS = 'CURRENT' );

```

RECID	STAMP	THREAD#	SEQUENCE#	FIRST_CHAN	FIRST_TIM	NEXT_CHANG
1	344890611	1	1	20037	24-SEP-13	20043
2	344890615	1	2	20043	24-SEP-13	20045
3	344890618	1	3	20045	24-SEP-13	20046

For example, if you discover that a user accidentally dropped a tablespace at 9:02 a.m., then you can recover to 9 a.m., just before the drop occurred. You lose all changes to the database made after this time.

3. If you are using a target time expression instead of a target SCN, then ensure that the time format environment variables are appropriate before invoking RMAN.

The following are sample Globalization Support settings:

```

NLS_LANG = american_america.us7ascii
NLS_DATE_FORMAT="Mon DD YYYY HH24:MI:SS"

```

4. Connect RMAN to the root as a **common user** with the common SYSBACKUP or SYSDBA privilege as described in "[Connecting as Target to the Root](#) (page 4-8)". If applicable, connect to a recovery catalog.

5. Bring the CDB to a mounted state.

```

SHUTDOWN IMMEDIATE;
STARTUP MOUNT;

```

6. Perform the following operations within a RUN block:

- a. For DBPITR, use SET UNTIL to specify the target time, SCN, or log sequence number, or use SET TO to specify a restore point. If specifying a time, then use the date format specified in the NLS_LANG and NLS_DATE_FORMAT environment variables.
- b. If automatic channels are not configured, then manually allocate disk and tape channels as needed.
- c. Restore and recover the CDB.

The following example performs DBPITR on the target CDB until SCN 1000:

```

RUN
{
  SET UNTIL SCN 1000;
  RESTORE DATABASE;
  RECOVER DATABASE;
}

```

As shown in the following examples, you can also use time expressions, restore points, or log sequence numbers to specify the SET UNTIL time:

```

SET UNTIL TIME 'Nov 15 2013 09:00:00';
SET UNTIL SEQUENCE 9923;
SET TO RESTORE POINT before_update;

```

If the operation completes without errors, then DBPITR has succeeded.

7. Perform either of the following mutually exclusive actions:

- Open your CDB for read/write, abandoning all changes after the target SCN. In this case, you must shut down the CDB, mount it, and then execute the following command:

```
ALTER DATABASE OPEN RESETLOGS;
```

The `OPEN RESETLOGS` operation fails if a data file is offline unless the data file went offline normally or is read-only. You can bring files in read-only or offline normal tablespaces online after the `RESETLOGS` because they do not need any redo.

- Export one or more objects from your CDB with Data Pump Export. You can then recover the CDB to the current point in time and reimport the exported objects, thus returning these objects to their state before the unwanted change without abandoning all other changes.

8. Open all the PDBs.

PDBs are not opened when the CDB is opened. The following command, when connected to the `root`, opens all the PDBs.

```
ALTER PLUGGABLE DATABASE ALL OPEN;
```

You can open each PDB separately.

18.5.3.2 Performing Point-in-Time Recovery of PDBs

The steps to perform point-in-time recovery of PDBs are similar to the ones for performing DBPITR, with the differences described in this section. When you recover one or more PDBs to a specified point-in-time, the remaining PDBs in the CDB are not affected and they can be open and operational. After recovery, the old backups of the PDB remain valid and can be used if a media failure occurs. You do not need to create new backups.

When performing DBPITR on one or more PDBs in a CDB that uses shared undo, backups of the root and the CDB seed (`PDB$SEED`) of the CDB that contains the PDBs are required.

Starting with Oracle Database 12c Release 2 (12.2), if `COMPATIBLE` is set to 12.2.0, you can perform flashback database for a CDB across a PDB flashback operation or PDB PITR.

In a Data Guard environment, for the standby database to follow a primary database in which a PDB was restored to a particular point in time, you may need to either flashback the entire standby database, restore the PDB, or flash back the PDB.

To perform DBPITR on a PDB:

1. Ensure that the prerequisites described in [Prerequisites of Database Point-in-Time Recovery](#) (page 18-25) are met.
2. Determine the time, SCN, restore point, or log sequence that ends recovery.

Use Flashback Query or the alert log to determine when the logical corruption occurred. Or, use a SQL query to determine the log sequence number that contains the target SCN and then recover through this log.

3. If you are using a target time expression instead of a target SCN, then ensure that the time format environment variables are appropriate before invoking RMAN.

The following are sample Globalization Support settings:

```
NLS_LANG = american_america.us7ascii
NLS_DATE_FORMAT="Mon DD YYYY HH24:MI:SS"
```

4. Connect RMAN to the root as a common user with the SYSDBA or SYSBACKUP privilege as described in "[Making RMAN Connections to a CDB](#) (page 4-7)". If applicable, connect to a recovery catalog.
5. Close the PDB that is being recovered. The other PDBs and the CDB can remain open.

```
ALTER PLUGGABLE DATABASE pdb1 CLOSE;
```

6. Perform the following operations within a RUN block:
 - a. For DBPITR, use SET UNTIL to specify the target time, SCN, or log sequence number, or use SET TO to specify a restore point. If specifying a time, then use the date format specified in the NLS_LANG and NLS_DATE_FORMAT environment variables.
 - b. If automatic channels are not configured, then manually allocate disk and tape channels as needed.
 - c. Restore and recover the CDB.

The following example performs DBPITR on the PDB my_pdb until SCN 1000:

```
RUN
{
  SET UNTIL SCN 1000;
  RESTORE PLUGGABLE DATABASE my_pdb;
  RECOVER PLUGGABLE DATABASE my_pdb;
}
```

If the operation completes without errors, then DBPITR has succeeded.

7. Open the PDB abandoning all changes after the target SCN.

The following example opens the PDB named my_pdb.

```
ALTER PLUGGABLE DATABASE my_pdb OPEN RESETLOGS;
```

Example 18-4 Recovering a PDB to a Specified Point-in-time

This example recovers a PDB named PDB5 up to the SCN 1066 and then opens it for read/write access. Connect to the root as a common user with the SYSDBA or SYSBACKUP privilege and enter the following commands:

```
ALTER PLUGGABLE DATABASE pdb5 CLOSE;
run
{
  SET UNTIL SCN 1066;
  RESTORE PLUGGABLE DATABASE pdb5;
  RECOVER PLUGGABLE DATABASE pdb5;
}
ALTER PLUGGABLE DATABASE pdb5 OPEN RESETLOGS;
```

This example assumes that a [fast recovery area](#) is being used. If you do not use a fast recovery area, then you must specify the temporary location of the auxiliary set files by using the `AUXILIARY DESTINATION` clause. See "[About DBPITR of PDBs and the Fast Recovery Area](#) (page 18-28)" for information about the fast recovery area usage during point-in-time recovery of PDBs.

`RESETLOGS` creates a new PDB incarnation. You can query the `V$PDB_INCARNATION` view for the incarnation number as described in "[About Incarnations of PDBs](#) (page 14-10)".

18.5.4 Performing Point-in-Time Recovery of Application PDBs

Use the `RESTORE` and `RECOVER` commands to perform point-in-time recovery of an application PDB.

The `COMPATIBLE` parameter for the CDB must be set to 12.2 or higher.

To perform point-in-time recovery of an application PDB:

1. Ensure that the prerequisites for point-in-time recovery are met.
2. Start RMAN and connect to the [application root](#) as an application common user with the `SYSDBA` or `SYSBACKUP` privilege.

The application root has its own service name and you can connect to the application root in the same way that you connect to a PDB.

3. Determine the time, SCN, restore point, or log sequence that ends recovery.
4. Close the [application PDB](#) that must be recovered.

The following command closes the application PDB called `hr_appcont_pdb1`.

```
ALTER PLUGGABLE DATABASE hr_appcont_pdb1 CLOSE;
```

5. Perform the following operations within a `RUN` block:
 - a. Use `SET UNTIL` to specify the target time, SCN, or log sequence number, or use `SET TO` to specify a restore point. If specifying a time, then use the date format specified in the `NLS_LANG` and `NLS_DATE_FORMAT` environment variables.
 - b. If automatic channels are not configured, then manually allocate disk and tape channels as needed.
 - c. Restore and recover the application container.

```
RUN
{
SET UNTIL SCN 34506;
RESTORE PLUGGABLE DATABASE hr_appcont_pdb1;
RECOVER PLUGGABLE DATABASE hr_appcont_pdb1;
}
```

6. Open the application PDB with `RESETLOGS`. This results in all changes after the target SCN being abandoned.

```
ALTER PLUGGABLE DATABASE hr_appcont_pdb1 OPEN RESETLOGS;
```

See Also:

[Making RMAN Connections to a CDB](#) (page 4-7)

18.5.5 Performing Point-in-Time Recovery of Sparse Databases

Performing point-in-time recovery of sparse databases is similar to performing point-in-time recovery of normal databases. To perform point-in-time recovery of a sparse database, you must ensure that the `COMPATIBLE` initialization parameter of the database being recovered is set to 12.2 or higher.

Note:

The base (read-only) data files in a sparse database are not encrypted. Ensure that the base data files are stored in a protected storage and accessed using secured communications.

To perform point-in-time recovery of a sparse database:

1. Ensure that the prerequisites described in [Prerequisites of Database Point-in-Time Recovery](#) (page 18-25) are met.
2. Determine the time, SCN, restore point, or log sequence that ends recovery.

You can use the Flashback Query features to help you identify when the logical corruption occurred. If you have a [flashback data archive](#) enabled for a table, then you can query data that existed far in the past.

You can also use the alert log to try to determine the time of the event from which you must recover.

Alternatively, you can use a SQL query to determine the log sequence number that contains the target SCN and then recover through this log. For example, run the following query to list the logs in the current database incarnation (sample output included):

```
SELECT RECID, STAMP, THREAD#, SEQUENCE#, FIRST_CHANGE#
       FIRST_TIME, NEXT_CHANGE#
FROM   V$ARCHIVED_LOG
WHERE  RESETLOGS_CHANGE# =
      ( SELECT RESETLOGS_CHANGE#
        FROM   V$DATABASE_INCARNATION
        WHERE  STATUS = 'CURRENT' );
```

RECID	STAMP	THREAD#	SEQUENCE#	FIRST_CHAN	FIRST_TIM	NEXT_CHANG
1	344890611	1	1	20037	24-SEP-13	20043
2	344890615	1	2	20043	24-SEP-13	20045
3	344890618	1	3	20045	24-SEP-13	20046

For example, if you discover that a user accidentally dropped a tablespace at 9:02 a.m., then you can recover to 9 a.m., just before the drop occurred. You lose all changes to the database made after this time.

3. If you are using a target time expression instead of a target SCN, then ensure that the time format environment variables are appropriate before invoking RMAN.

The following are sample Globalization Support settings:

```
NLS_LANG = american_america.us7ascii
NLS_DATE_FORMAT="Mon DD YYYY HH24:MI:SS"
```

4. Connect RMAN to the target database and, if applicable, the recovery catalog database as described in "[Making Database Connections with RMAN](#) (page 4-2)". Bring the database to a mounted state:

```
SHUTDOWN IMMEDIATE;
STARTUP MOUNT;
```

If the operation completes without errors, then DBPITR has succeeded.

5. Perform the following operations within a RUN block:
 - a. For DBPITR, use SET UNTIL to specify the target time, SCN, or log sequence number, or use SET TO to specify a restore point. If specifying a time, then use the date format specified in the NLS_LANG and NLS_DATE_FORMAT environment variables.
 - b. If automatic channels are not configured, then manually allocate disk and tape channels as needed.
 - c. Restore and recover the sparse database with the FROM SPARSE option.

The following example performs point-in-time recovery for a sparse database till the SCN 2775080:

```
RUN
{
  SET UNTIL SCN 2775080;
  RESTORE FROM SPARSE DATABASE;
  RECOVER DATABASE;
}
```

6. Perform either of the following mutually exclusive actions:
 - Open your database for read/write, abandoning all changes after the target SCN. In this case, you must shut down the database, mount it, and then execute the following command:

```
ALTER DATABASE OPEN RESETLOGS;
```

The OPEN RESETLOGS operation fails if a data file is offline unless the data file went offline normally or is read-only. You can bring files in read-only or offline normal tablespaces online after the RESETLOGS because they do not need any redo.

- Export one or more objects from your database with Data Pump Export. You can then recover the database to the current point in time and reimport the exported objects, thus returning these objects to their state before the unwanted change without abandoning all other changes.

18.6 Flashback and Database Point-in-Time Recovery Scenarios

This section describes variations on the basic scenarios described in "[Rewinding a Database with Flashback Database](#) (page 18-15)" and "[Performing Database Point-in-Time Recovery](#) (page 18-25)".

This section contains the following topics:

- [Rewinding an OPEN RESETLOGS Operation with Flashback Database](#) (page 18-35)
- [Rewinding the Database to an SCN in an Abandoned Incarnation Branch](#) (page 18-36)
- [Recovering the Database to an Ancestor Incarnation](#) (page 18-38)

18.6.1 Rewinding an OPEN RESETLOGS Operation with Flashback Database

The procedure for using Flashback Database to reverse an unwanted ALTER DATABASE OPEN RESETLOGS statement is similar to the general case described in "[Performing a Flashback Database Operation](#) (page 18-16)". Rather than specifying a particular SCN or point in time for the FLASHBACK DATABASE command, however, you use FLASHBACK DATABASE TO BEFORE RESETLOGS.

To undo an OPEN RESETLOGS operation:

1. Connect SQL*Plus to the target database and verify that the beginning of the flashback window is earlier than the time of the most recent OPEN RESETLOGS.

Run the following queries:

```
SELECT RESETLOGS_CHANGE#
FROM   V$DATABASE;
```

```
SELECT OLDEST_FLASHBACK_SCN
FROM   V$FLASHBACK_DATABASE_LOG;
```

If V\$DATABASE.RESETLOGS_CHANGE# is greater than V\$FLASHBACK_DATABASE_LOG.OLDEST_FLASHBACK_SCN, then you can use Flashback Database to reverse the OPEN RESETLOGS. operation

2. Shut down the database, mount it, and recheck the flashback window. If the resetlogs SCN is still within the flashback window, then proceed to the next step.
3. Connect RMAN to the target database.

See Also:

["Making Database Connections with RMAN](#) (page 4-2)"

4. Perform a flashback to the SCN immediately before the RESETLOGS.

Use the following form of the FLASHBACK DATABASE command:

```
FLASHBACK DATABASE TO BEFORE RESETLOGS;
```

As with other uses of FLASHBACK DATABASE, if the target SCN is before the beginning of the flashback database window, an error is returned and the database is not modified. If the command completes successfully, then the database is left mounted and recovered to the most recent SCN before the OPEN RESETLOGS operation in the previous incarnation.

5. Open the database read-only in SQL*Plus and perform queries as needed to ensure that the effects of the logical corruption have been reversed.

Open the database read-only as follows:

```
ALTER DATABASE OPEN READ ONLY;
```

6. To make the database available for updates again, shut down the database, mount it, and then execute the following command:

```
ALTER DATABASE OPEN RESETLOGS;
```

18.6.1.1 About Undoing an OPEN RESETLOGS on Standby Databases with Flashback Database

Flashback Database across OPEN RESETLOGS may be used to perform the following functions in a Data Guard environment:

- Flashback to undo logical standby switchovers
In this case, the database reverts to its role (primary or standby) at the target time for the Flashback Database operation.
- Undo of a physical standby activation
You can temporarily activate a physical standby database, use it for testing or reporting purposes, and then use Flashback Database to return it to its role as a physical standby.
- Ongoing use of a standby database for testing
The use of Flashback Database means that you do not require the use of storage snapshots.

See Also:

Oracle Data Guard Concepts and Administration for details on these advanced applications of Flashback Database with Data Guard

18.6.2 Rewinding the Database to an SCN in an Abandoned Incarnation Branch

The effect of Flashback Database or DBPITR followed by an OPEN RESETLOGS operation is to return the database to a previous SCN, and to abandon changes after this point. Therefore, some SCNs after that point can refer either to changes that were abandoned or changes in the current history of the database. In this way, a target SCN specified in FLASHBACK DATABASE can be ambiguous.

Unlike SCNs, time expressions and restore points are not ambiguous. A time expression is always associated with the incarnation that was current at that time. A restore point is always associated with the current incarnation when it was created. This is true even for times and restore points that correspond to abandoned database incarnations. The database incarnation is automatically reset to the incarnation that was current at the specified time or when the restore point was created.

You may want to use Flashback Database to rewind the database to an SCN in the parent incarnation that is later than the SCN of the OPEN RESETLOGS operation at which the current incarnation path branched from the old incarnation. [Figure 14-1](#) (page 14-9) shows how SCNs can be generated in an incarnation branch even after an OPEN RESETLOGS operation creates a new incarnation. As shown in the diagram, the database could be at SCN 3000 in incarnation 3 when you must return to the abandoned SCN 1500 in incarnation 1.

If the SCN to which you are rewinding is in the [direct ancestral path](#), or if you are rewinding the database to a [restore point](#), then an explicit RESET DATABASE

command is not necessary for Flashback Database. However, an explicit `RESET DATABASE TO INCARNATION` command is required when you use `FLASHBACK DATABASE` to rewind the database to an SCN in an abandoned database incarnation.

To rewind the database to an SCN in an abandoned incarnation branch:

1. Use SQL*Plus to connect to the target database and verify that the flashback logs contain enough information to flash back to the SCN.

For example, execute the following query:

```
SELECT OLDEST_FLASHBACK_SCN
FROM   V$FLASHBACK_DATABASE_LOG;
```

2. Determine the target incarnation number for the Flashback Database operation, that is, the incarnation key for the parent incarnation.

For example, execute the following query:

```
SELECT PRIOR_INCARNATION#
FROM   V$DATABASE_INCARNATION
WHERE  STATUS = 'CURRENT';
```

3. Start RMAN and connect to the target database.

See Also:

["Making Database Connections with RMAN \(page 4-2\)"](#)

4. Shut down the database, and then mount it as follows:

```
SHUTDOWN IMMEDIATE;
STARTUP MOUNT;
```

5. Set the database incarnation to the parent incarnation.

For example, use the following command to return to incarnation 1:

```
RESET DATABASE TO INCARNATION 1;
```

6. Run the `FLASHBACK DATABASE` command, specifying the target SCN.

For example, use the following command to rewind the database to SCN 1500:

```
FLASHBACK DATABASE TO SCN 1500;
```

7. Open the database read-only in SQL*Plus and perform queries as needed to ensure that the effects of the logical corruption have been reversed.

Open the database read-only as follows:

```
ALTER DATABASE OPEN READ ONLY;
```

8. To make the database available for updates again, shut down the database, mount it, and then execute the following command:

```
ALTER DATABASE OPEN RESETLOGS;
```

See Also:

- ["About Database Incarnations \(page 14-7\)"](#) for useful background information about database incarnations, abandoned changes, and the effects of `ALTER DATABASE OPEN RESETLOGS`
 - *Oracle Database Backup and Recovery Reference* for details about the `RESET DATABASE` command
-

18.6.3 Recovering the Database to an Ancestor Incarnation

The procedure for DBPITR within the current incarnation is different from DBPITR to an SCN in a noncurrent incarnation. In the latter case, you must explicitly execute the `RESET DATABASE` to reset the database to the incarnation that was current at the target SCN. Also, you must restore a control file from the database incarnation containing the target SCN.

When RMAN is connected to a recovery catalog, a `RESTORE CONTROLFILE` command only searches the current database incarnation for the closest time specified in the `UNTIL` clause. To restore a control file from a noncurrent incarnation, you must execute `LIST INCARNATION` to identify the target database incarnation and specify this incarnation in the `RESET DATABASE TO INCARNATION` command.

When RMAN is connected to a recovery catalog, you cannot execute the `RESET DATABASE TO INCARNATION` command before the database is mounted. Thus, you must execute `SET UNTIL`, restore the control file from autobackup, and then mount it.

Assume the following situation:

- RMAN is connected to a recovery catalog.
- You have a backup of target database `trgt` from October 2, 2013.
- DBPITR was performed on this database on October 10, 2013 to correct an earlier error. The `OPEN RESETLOGS` operation after that DBPITR started a new incarnation.

On October 25, you discover that you need crucial data that was dropped from the database at 8:00 a.m. on October 8, 2013. This time is before the beginning of the current incarnation.

To perform DBPITR to a noncurrent incarnation:

1. Start RMAN and connect to a target database and recovery catalog.

See Also:

["Making Database Connections with RMAN \(page 4-2\)"](#)

2. Determine which database incarnation was current at the time of the backup.

Use `LIST INCARNATION` to find the primary key of the incarnation that was current at the target time:

```
LIST INCARNATION OF DATABASE trgt;
```

```
List of Database Incarnations
```

DB Key	Inc Key	DB Name	DB ID	STATUS	Reset SCN	Reset Time
1	2	TRGT	1224038686	PARENT	1	02-OCT-13
1	582	TRGT	1224038686	CURRENT	59727	10-OCT-13

Look at the `Reset SCN` and `Reset Time` columns to identify the correct incarnation, and note the incarnation key in the `Inc Key` column. In this example, the backup was made 2 October 2013. In this case, the incarnation key value is 2.

3. Ensure that the database is started but not mounted.

```
STARTUP FORCE NOMOUNT;
```

4. Reset the target database to the incarnation obtained in Step 2.

In this example, specify the incarnation current at the time of the backup of 2 October. Use the value from the `Inc Key` column to identify the incarnation.

```
RESET DATABASE TO INCARNATION 2;
```

5. Restore and recover the database, performing the following actions in the `RUN` command:

- Set the end time for recovery to the time just before the loss of the data.
- Allocate any channels required that are not configured.
- Restore the control file from the October 2 backup and mount it.
- Restore the data files and recover the database. Use the `RECOVER DATABASE . . . UNTIL` command to perform DBPITR, bringing the database to the target time of 7:55 a.m. on October 8, just before the data was lost.

The following example shows all of the steps required in this case:

```
RUN
{
  SET UNTIL TIME 'Oct 8 2013 07:55:00';
  RESTORE CONTROLFILE;
  # without recovery catalog, use RESTORE CONTROLFILE FROM AUTOBACKUP
  ALTER DATABASE MOUNT;
  RESTORE DATABASE;
  RECOVER DATABASE;
}
ALTER DATABASE OPEN RESETLOGS;
```

See Also:

Oracle Database Backup and Recovery Reference for details about the `RESET DATABASE` command

Performing Block Media Recovery

This chapter explains how to restore and recover individual data blocks within a data file. This chapter contains the following topics:

- [Overview of Block Media Recovery](#) (page 19-1)
- [Prerequisites for Block Media Recovery](#) (page 19-4)
- [Recovering Individual Blocks](#) (page 19-5)
- [Recovering All Blocks in V\\$DATABASE_BLOCK_CORRUPTION](#) (page 19-8)

See Also:

- *Oracle Database Backup and Recovery Reference* for RECOVER syntax
 - *Oracle Database Reference* for details about the V\$DATABASE_BLOCK_CORRUPTION view
-

19.1 Overview of Block Media Recovery

This section explains the purpose and basic concepts of block media recovery and contains the following topics:

- [Purpose of Block Media Recovery](#) (page 19-1)
- [Basic Concepts of Block Media Recovery](#) (page 19-2)

19.1.1 Purpose of Block Media Recovery

You can use [block media recovery](#) to recover one or more corrupt data blocks within a data file. Block media recovery provides the following advantages over [data file media recovery](#):

- Lowers the [mean time to recover \(MTTR\)](#) because only blocks needing recovery are restored and recovered
- Enables affected data files to remain online during recovery

Without block media recovery, if even a single block is corrupt, then you must take the data file offline and restore a backup of the data file. You must apply all redo generated for the data file after the backup was created. The entire file is unavailable until media recovery completes. With block media recovery, only the blocks actually being recovered are unavailable during the recovery.

Block media recovery is most useful for [physical corruption](#) problems that involve a small, well-known number of blocks. Block-level data loss usually results from

intermittent, random I/O errors that do not cause widespread data loss, and memory corruptions that are written to disk. Block media recovery is not intended for cases where the extent of data loss or corruption is unknown and the entire data file requires recovery. In such cases, data file media recovery is the best solution.

19.1.2 Basic Concepts of Block Media Recovery

Usually, the database marks a block as media corrupt and then writes it to disk when the corruption is first encountered. No subsequent read of the block is successful until the block is recovered. You can perform block recovery only on blocks that are marked corrupt or that fail a corruption check.

If the database on which the corruption occurs is associated with a real-time query physical standby database, then the database *automatically* attempts to perform block media recovery. The primary database searches for good copies of blocks on the standby database and, if they are found, repairs the blocks with no impact to the query that encountered the corrupt block. The Oracle Database physical block corruption message (ORA-1578) is displayed only if the database cannot repair the corruption.

Whenever block corruption has been automatically detected, you can perform block media recovery manually with the `RECOVER . . . BLOCK` command. By default, RMAN first searches for good blocks in the real-time query physical standby database, then flashback logs and then blocks in full or level 0 incremental backups.

Note:

For block media recovery to work automatically, the physical standby database must be in real-time query mode. An Oracle Active Data Guard license is required.

If a corrupt data block is discovered on a real-time query physical standby database, the server attempts to repair the corruption by obtaining a copy of the block from the primary database. The repair is performed in the background, enabling subsequent queries to succeed if the repair is successful. Automatic block repair is attempted if the following database initialization parameters are configured on the standby database as described:

- The `LOG_ARCHIVE_CONFIG` parameter is configured with a `DG_CONFIG` list and a `LOG_ARCHIVE_DEST_n` parameter is configured for the primary database with the `DB_UNIQUE_NAME` attribute

or

- The `FAL_SERVER` parameter is configured and its value contains an Oracle Net service name for the primary database

Note:

If a corrupt block is detected during validation, such as by the RMAN `VALIDATE` command, then recovery is *not* initiated automatically.

See Also:

- *Oracle Database Backup and Recovery Reference* for RECOVER . . . BLOCK syntax
 - *Oracle Data Guard Concepts and Administration* to learn about the real-time query option for standby databases
-
-

19.1.2.1 About Identifying Corrupt Blocks

The `V$DATABASE_BLOCK_CORRUPTION` view displays blocks marked corrupt by database components such as RMAN, ANALYZE, and SQL queries.

The following types of corruption result in the addition of rows to this view:

- Physical corruption (sometimes called media corruption)

The database does not recognize the block: the `checksum` is invalid, the block contains all zeros, or the block header is corrupt.

Physical corruption checking is enabled by default. You can turn off checksum checking by specifying the `NOCHECKSUM` option of the `BACKUP` command, but other physical consistency checks, such as checks of the block headers and footers, cannot be disabled.

- Logical corruption

The block has a valid checksum, the header and footer match, and so on, but the contents are logically inconsistent. Block media recovery may not be able to repair all logical block corruptions. In these cases, alternate recovery methods, such as tablespace point-in-time recovery, or dropping and re-creating the affected objects, may repair the corruption.

Logical corruption checking is disabled by default. You can turn it on by specifying the `CHECK LOGICAL` option of the `BACKUP`, `RESTORE`, `RECOVER`, and `VALIDATE` commands.

The database can detect some corruptions by validating relationships between blocks and segments, but cannot detect them by a check of an individual block. The `V$DATABASE_BLOCK_CORRUPTION` view does not record at this level of granularity.

19.1.2.2 About Missing Redo During Block Recovery

Like data file media recovery, block media recovery cannot generally survive a missing or inaccessible archived log, although it attempts restore failover when looking for usable copies of archived redo log files, as described in "[About RMAN Restore Failover](#) (page 14-4)". Also, block media recovery cannot survive physical redo corruptions that result in `checksum` failure. However, block media recovery can survive gaps in the redo stream if the missing or corrupt redo records do not affect the blocks being recovered. Whereas data file recovery requires an unbroken series of redo changes from the beginning of recovery to the end, block media recovery only requires an unbroken set of redo changes for the blocks being recovered.

Note:

Each block is recovered independently during block media recovery, so recovery may be successful for a subset of blocks.

When RMAN first detects missing or corrupt redo records during block media recovery, it does not immediately signal an error because the block undergoing recovery may create one later in the redo stream. When a block is re-created, all previous redo for that block becomes irrelevant because the redo applies to an old incarnation of the block. For example, the database creates a new block when users drop or truncate a table and then use the block for other data.

Assume that media recovery is performed on block 13 as depicted in [Figure 19-1](#) (page 19-4).

Figure 19-1 Performing RMAN Media Recovery

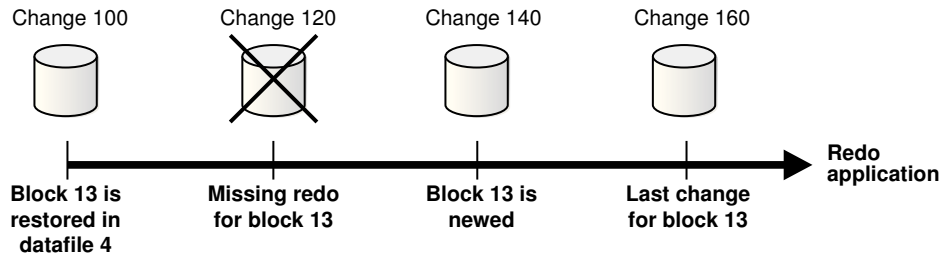

After block recovery begins, RMAN discovers that change 120 is missing from the redo stream, either because the log block is corrupt or because the log cannot be found. RMAN continues recovery if block 13 is re-created later in the redo stream. Assume that in change 140 a user drops the table `employees` stored in block 13, allocates a new table in this block, and inserts data into the new table. At this point, the database formats block 13 as a new block. Recovery can now proceed with this block even though some redo preceding the recreation operation was missing.

19.2 Prerequisites for Block Media Recovery

The following prerequisites apply to the `RECOVER . . . BLOCK` command:

- The target database must run in ARCHIVELOG mode and be open or mounted with a current control file.
- If the target database is a standby database, then it must be in a consistent state, recovery cannot be in session, and the backup must be older than the corrupted file.
- The backups of the data files containing the corrupt blocks must be full or level 0 backups. They cannot be proxy copies or incremental backups.

If only [proxy copy](#) backups exist, then you can restore them to a nondefault location on disk, in which case RMAN considers them data file copies and searches them for blocks during block media recovery.

- RMAN can use only archived redo logs for the recovery.

RMAN cannot use level 1 incremental backups. Block media recovery cannot survive a missing or inaccessible archived redo log, although it can sometimes survive missing redo records.

- Flashback Database must be enabled on the target database for RMAN to search the flashback logs for good copies of corrupt blocks.

If flashback logging is enabled and contains older, uncorrupted versions of the corrupt blocks, then RMAN can use these blocks, possibly speeding up the recovery.

- The target database must be associated with a real-time query physical standby database for RMAN to search the database for good copies of corrupt blocks.

19.3 Recovering Individual Blocks

Typically, block corruption is reported in the following locations:

- Results of the `LIST FAILURE, VALIDATE, or BACKUP . . . VALIDATE` command
- The `V$DATABASE_BLOCK_CORRUPTION` view
- Error messages in standard output
- The alert log
- User trace files
- Results of the SQL commands `ANALYZE TABLE` and `ANALYZE INDEX`
- Results of the `DBVERIFY` utility
- Third-party media management output

For example, you may discover the following messages in a user trace file:

```
ORA-01578: ORACLE data block corrupted (file # 7, block # 3)
ORA-01110: data file 7: '/oracle/oradata/trgt/tools01.dbf'
ORA-01578: ORACLE data block corrupted (file # 2, block # 235)
ORA-01110: data file 2: '/oracle/oradata/trgt/undotbs01.dbf'
```

This section contains the following topics:

- [Recovering Individual Blocks Using the RECOVER...BLOCK Command](#) (page 19-5)
- [Example: Recovering Individual Blocks Using the Data Recovery Advisor](#) (page 19-6)

19.3.1 Recovering Individual Blocks Using the RECOVER...BLOCK Command

In the following procedure, you identify the blocks that require recovery and then use any available backup to restore and recover these blocks.

To recover specific data blocks using the RECOVER...BLOCK command:

1. Obtain the data file numbers and block numbers of the corrupted blocks.

The easiest way to locate trace files and the alert log is to connect SQL*Plus to the target database and execute the following query:

```
SELECT NAME, VALUE
FROM   V$DIAG_INFO;
```

2. Start RMAN and connect to the target database, which must be mounted or open.
3. Run the `SHOW ALL` command to confirm that the appropriate channels are preconfigured.
4. Run the `RECOVER . . . BLOCK` command at the RMAN prompt, specifying the file and block numbers for the corrupted blocks.

The following example recovers two blocks.

```
RECOVER
  DATAFILE 8 BLOCK 13
  DATAFILE 2 BLOCK 19;
```

You can also specify various options to control RMAN behavior. The following example indicates that only backups with the tag `mondayam` are used when searching for blocks. You could use the `FROM BACKUPSET` option to restrict the type of backup that RMAN searches, or the `EXCLUDE FLASHBACK LOG` option to restrict RMAN from searching the flashback logs.

```
RECOVER
  DATAFILE 8 BLOCK 13
  DATAFILE 2 BLOCK 199
  FROM TAG mondayam;
```

19.3.2 Example: Recovering Individual Blocks Using the Data Recovery Advisor

You can use the Data Recovery Advisor to diagnose and repair failures caused by data block corruptions. In this example, corrupt data blocks were discovered when the `VALIDATE DATABASE` command was run as described in "[Checking for Block Corruptions by Validating the Database](#) (page 15-9)".

To generate automated repair options and repair the failure using the Data Recovery Advisor:

1. Start RMAN and connect to the target database.

See Also:

["Making Database Connections with RMAN](#) (page 4-2)"

2. List the failures recorded by the Data Recovery Advisor using the following command:

```
LIST FAILURE;

Database Role: PRIMARY

List of Database Failures
=====

Failure ID Priority Status   Time Detected Summary
-----
5720      HIGH    OPEN    24-APR-14   Datafile 14:
'/home1/oracle/dbs/tbs_32.f' contains one or more corrupt blocks
```

3. Generate repair options for the failure listed Step 2 (page 19-6).

The following command generates repair options and creates a repair script to perform the automated repair tasks.

```
ADVISE FAILURE;

Database Role: PRIMARY

List of Database Failures
=====
```

```

Failure ID Priority Status      Time Detected Summary
-----
5720          HIGH      OPEN        24-APR-14    Datafile 14:
'/home1/oracle/dbs/tbs_32.f' contains one or more corrupt blocks

analyzing automatic repair options; this may take some time
using channel ORA_DISK_1
analyzing automatic repair options complete

Mandatory Manual Actions
=====
no manual actions available

Optional Manual Actions
=====
no manual actions available

Automated Repair Options
=====
Option Repair Description
-----
1          Perform block media recovery of block 20 in file 14
Strategy: The repair includes complete media recovery with no data loss
Repair script: /home1/oracle/log/diag/rdbms/db12/hm/reco_287949467.hm

```

4. Perform the automated repairs recommended by Data Recovery Advisor.

RMAN uses the repair script generated by the `ADVISE FAILURE` command to perform the required repairs.

```
REPAIR FAILURE;
```

```

Strategy: The repair includes complete media recovery with no data loss
Repair script: /home1/oracle/log/diag/rdbms/db12/hm/reco_287949467.hm
contents of repair script:
# block media recovery  recover datafile 14 block 20;
Do you really want to execute the above repair (enter YES or NO)?
yes
executing repair script
Starting recover at 24-APR-14
using channel ORA_DISK_1
channel ORA_DISK_1: restoring block(s)channel
ORA_DISK_1: specifying block(s) to restore from backup setrestoring blocks of
datafile 00014
channel ORA_DISK_1: reading from backup piece /backups/DB121/backupset/2014_04_24/
o1_mf_nnndf_TAG20140424T213309_9omsd7vb_.bkp
channel ORA_DISK_1: piece handle=/backups/DB121/backupset/2014_04_24/
o1_mf_nnndf_TAG20140424T213309_9omsd7vb_.bkp tag=TAG20140424T213309
channel ORA_DISK_1: restored block(s) from backup piece 1
channel ORA_DISK_1: block restore complete, elapsed time: 00:00:01
starting media recovery
media recovery complete, elapsed time: 00:00:03
Finished recover at 24-APR-14repair failure complete

```

When the `LIST FAILURE` command displays more than one failures, you can perform repair actions only for a particular failure. Use the option number displayed in the Automated Repair Options section of the `ADVISE FAILURE` command output to perform specific repair actions.

The following command performs only the repair actions listed under Option 2 of the Automated Repair Options section.

```
REPAIR FAILURE USING ADVISE OPTION 2;
```

See Also:

[Diagnosing and Repairing Failures with Data Recovery Advisor](#) (page 15-1)

19.4 Recovering All Blocks in V\$DATABASE_BLOCK_CORRUPTION

In this scenario, RMAN automatically recovers all blocks listed in the V\$DATABASE_BLOCK_CORRUPTION view.

To recover all blocks logged in V\$DATABASE_BLOCK_CORRUPTION:

1. Start SQL*Plus and connect to the target database.
2. Query V\$DATABASE_BLOCK_CORRUPTION to determine whether corrupt blocks exist. For example, execute the following statement:

```
SQL> SELECT * FROM V$DATABASE_BLOCK_CORRUPTION;
```

3. Start RMAN and connect to the target database.

See Also:

["Making Database Connections with RMAN](#) (page 4-2)"

4. Recover all blocks marked corrupt in V\$DATABASE_BLOCK_CORRUPTION.

The following command repairs all physically corrupted blocks recorded in the view:

```
RMAN> RECOVER CORRUPTION LIST;
```

After the blocks are recovered, the database removes them from V\$DATABASE_BLOCK_CORRUPTION.

See Also:

Oracle Database Backup and Recovery Reference to learn about the RECOVER . . . BLOCK command

Performing RMAN Recovery: Advanced Scenarios

The preceding chapters in [Diagnosing and Responding to Failures](#) (page 1) cover the most basic recovery scenarios and are intended to be as generic as possible. The scenarios in this chapter are less common or are more complicated than the basic scenarios.

This chapter contains the following topics:

- [Recovering a NOARCHIVELOG Database with Incremental Backups](#) (page 20-1)
- [Restoring the Server Parameter File](#) (page 20-2)
- [Performing Recovery with a Backup Control File](#) (page 20-4)
- [Performing Disaster Recovery](#) (page 20-9)
- [Restoring a Database on a New Host](#) (page 20-12)
- [Restoring and Recovering Files Over the Network](#) (page 20-21)

20.1 Recovering a NOARCHIVELOG Database with Incremental Backups

Restoring a database running in NOARCHIVELOG mode is similar to restoring a database in ARCHIVELOG mode. The main differences are:

- Only consistent backups can be used in restoring a database in NOARCHIVELOG mode.
- Media recovery is not possible because no archived redo logs exist.

You can perform limited recovery of changes to a database running in NOARCHIVELOG mode by applying incremental backups. The incremental backups must be consistent, like all backups of a database run in NOARCHIVELOG mode, so you cannot make backups of the database when it is open.

When you are recovering a NOARCHIVELOG database, specify the NOREDO option on the RECOVER command to indicate that RMAN does not attempt to apply archived redo logs. Otherwise, RMAN returns an error.

To recover a NOARCHIVELOG database with incremental backups:

1. After connecting to the target database and the recovery catalog, place the database in a mounted state:

```
STARTUP FORCE MOUNT
```

2. Restore and recover the database.

For example, you can perform incomplete recovery with the following commands:

```
RESTORE DATABASE
  FROM TAG "consistent_whole_backup";
RECOVER DATABASE NOREDO;
```

3. Open the database with the RESETLOGS option.

For example, enter the following command:

```
ALTER DATABASE OPEN RESETLOGS;
```

20.2 Restoring the Server Parameter File

If you lose the server parameter file, then RMAN can restore it to its default location or to a location of your choice. Unlike the loss of the control file, the loss of the server parameter file does not cause the instance to immediately stop. The instance may continue operating, although you must shut it down and restart it after restoring the server parameter file.

Note the following considerations when restoring the server parameter file:

- If the instance is already started with the server parameter file, then you cannot overwrite the existing server parameter file.
- When the instance is started with a client-side initialization parameter file, RMAN restores the server parameter file to the default location if the `TO` clause is not used in the restore command. The default location is platform-specific, for example, `*/dbs/spfile.ora` on Linux.
- A recovery catalog simplifies the recovery procedure because you can avoid recording and remembering the DBID. This procedure assumes that you are *not* using a recovery catalog.

To restore the server parameter file from autobackup:

1. Start RMAN and do one of the following:

- If the database instance is started at the time of the loss of the server parameter file, then connect to the target database.
- If the database instance is not started when the server parameter file is lost, and if you are not using a recovery catalog, then run the `SET DBID` command to set the DBID of the target database. See "[Determining the DBID of the Database](#) (page 17-6)" for details on determining the DBID.

2. Shut down the database instance and restart it without mounting the database.

When the server parameter file is not available, RMAN starts the instance with a dummy parameter file. For example, enter the following command:

```
STARTUP FORCE NOMOUNT;
```

3. Execute a `RUN` command to restore the server parameter file.

Depending on the situation, you may need to execute multiple commands in the `RUN` command. Note the following considerations:

- If restoring from tape, then use `ALLOCATE CHANNEL` to allocate an SBT channel manually. If restoring from disk, then RMAN uses the default disk channel.
- If the autobackups were not produced with the default format (`%F`), then use the `SET CONTROLFILE AUTOBACKUP FOR DEVICE TYPE` command to specify the format in effect when the autobackup was performed.
- If the most recent autobackup was not created today, then use `SET UNTIL` to specify the date from which to start the search.
- If RMAN is not connected to a recovery catalog, then use `SET DBID` to set the DBID for the target database.
- To restore the server parameter file to a nondefault location, specify the `TO` clause or `TO PFILE` clause on the `RESTORE SPFILE` command.
- If you know that RMAN never produces more than *n* autobackups each day, then you can set the `RESTORE SPFILE FROM AUTOBACKUP ... MAXSEQ` parameter to *n* to reduce the search time. `MAXSEQ` is set to 255 by default, and `RESTORE` counts backward from `MAXSEQ` to find the last backup of the day. To terminate the restore operation if you do not find the autobackup in the current day (or specified day), set `MAXDAYS 1` on the `RESTORE` command.

The following example illustrates a `RUN` command that restores a server parameter file from an autobackup on tape:

```
RUN
{
  ALLOCATE CHANNEL c1 DEVICE TYPE sbt PARMS ...;
  SET UNTIL TIME 'SYSDATE-7';
  SET CONTROLFILE AUTOBACKUP FORMAT
    FOR DEVICE TYPE sbt TO '/disk1/control_files/autobackup_%F';
  SET DBID 123456789;
  RESTORE SPFILE
    TO '/tmp/spfileTEMP.ora'
    FROM AUTOBACKUP MAXDAYS 10;
}
```

4. Restart the database instance with the restored file.

If you are restarting RMAN with a server parameter file in a nondefault location, then create an initialization parameter file with the line `SPFILE=new_location`, where `new_location` is the path name of the restored server parameter file. Then, restart the instance with the client-side initialization parameter file.

For example, create a file `/tmp/init.ora` which contains the single line:

```
SPFILE=/tmp/spfileTEMP.ora
```

You can use the following RMAN command to restart the instance with the restored server parameter file:

```
STARTUP FORCE PFILE=/tmp/init.ora;
```

20.2.1 Restoring the Server Parameter File from a Control File Autobackup

If you have configured control file autobackups, then the server parameter file is backed up with the control file whenever an autobackup is taken.

To restore the server parameter file from the control file autobackup, you must first set the DBID for your database and then use the `RESTORE SPFILE FROM AUTOBACKUP` command. If the autobackup is in a nondefault format, then first use the `SET CONTROLFILE AUTOBACKUP FORMAT` command to specify the format.

[Example 20-1](#) (page 20-4) sets the DBID and restores the server parameter file from a control file autobackup in a nondefault location.

Example 20-1 Restoring the Server Parameter File from a Control File Autobackup

```
SET DBID 320066378;
RUN
{
  SET CONTROLFILE AUTOBACKUP FORMAT
  FOR DEVICE TYPE DISK TO 'autobackup_format';
  RESTORE SPFILE FROM AUTOBACKUP;
}
```

RMAN uses the autobackup format and DBID to hunt for control file autobackups. If a control file autobackup is found, then RMAN restores the server parameter file from that backup to its default location.

To learn how to determine the correct value for `autobackup_format`, see the description of `CONFIGURE CONTROLFILE AUTOBACKUP FORMAT` in the entry for the `CONFIGURE` command in *Oracle Database Backup and Recovery Reference*.

See Also:

["Determining the DBID of the Database \(page 17-6\)"](#) for details on how to determine the DBID

20.2.2 Creating an Initialization Parameter File with RMAN

You can also restore the server parameter file as a client-side initialization parameter file with the `TO PFILE 'filename'` clause. The file name that you specify must be on a file system accessible from the host where the RMAN client is running. This file need not be accessible directly from the host running the instance.

The following RMAN command creates an initialization parameter file named `/tmp/initTEMP.ora` on the system running the RMAN client:

```
RESTORE SPFILE TO PFILE '/tmp/initTEMP.ora';
```

To restart the instance with the initialization parameter file, use the following command, again running RMAN on the same client host:

```
STARTUP FORCE PFILE='/tmp/initTEMP.ora';
```

20.3 Performing Recovery with a Backup Control File

This section explains what to do when all current control files are lost and you must restore a backup control file.

This section contains the following topics:

- [About Recovery with a Backup Control File](#) (page 20-5)
- [Performing Recovery with a Backup Control File and No Recovery Catalog](#) (page 20-7)

20.3.1 About Recovery with a Backup Control File

If all copies of the current control file are lost or damaged, then you must restore and mount a backup control file. You must then run the `RECOVER` command, even if no data files have been restored, and open the database with the `RESETLOGS` option. If some copies of the current control file are usable, however, then you can follow the procedure in "[Responding to the Loss of a Subset of the Current Control Files](#) (page 31-1)" and avoid the recovery and `RESETLOGS` operation.

During recovery, RMAN automatically searches for online and archived logs that are not recorded in the RMAN repository and catalogs any that it finds. RMAN attempts to find a valid archived redo log in any current archiving destination with the current log format. The current format is specified in the initialization parameter file used to start the instance (or all instances in an Oracle RAC configuration). Similarly, RMAN attempts to find the online redo logs by using the file names listed in the control file.

If you changed the archiving destination or format during recovery, or if you added new online log members after the backup of the control file, then RMAN may not be able to automatically catalog a needed online or archived log. Whenever RMAN cannot find online redo logs and you did not specify an `UNTIL` time, RMAN reports errors similar to the following:

```
RMAN-00571: =====
RMAN-00569: ===== ERROR MESSAGE STACK FOLLOWS =====
RMAN-00571: =====
RMAN-03002: failure of recover command at 08/29/2013 14:23:09
RMAN-06054: media recovery requesting unknown log: thread 1 scn 86945
```

In this case, you must use the `CATALOG` command to manually add the required redo logs to the repository so that recovery can proceed.

See Also:

- The discussion of `RESTORE CONTROLFILE` in *Oracle Database Backup and Recovery Reference* for more details about restrictions on using `RESTORE CONTROLFILE` in different scenarios (such as when using a recovery catalog, or restoring from a specific backup)
 - [About Control File Locations During RMAN Restore](#) (page 20-5)
 - [About RMAN Recovery With and Without a Recovery Catalog](#) (page 20-6)
 - [About RMAN Recovery When Using a Fast Recovery Area](#) (page 20-7)
-

20.3.1.1 About Control File Locations During RMAN Restore

When you are restoring the control file, the default destination is all of the locations defined in the `CONTROL_FILES` initialization parameter. If you do not set the `CONTROL_FILES` initialization parameter, then the database uses the same rules to determine the destination for the restored control file that it uses when creating a control file if the `CONTROL_FILES` parameter is not set. These rules are described in *Oracle Database SQL Language Reference* in the description of the `CREATE CONTROLFILE` statement.

One way to restore the control file to one or more new locations is to change the `CONTROL_FILES` initialization parameter, and then use the `RESTORE CONTROLFILE` command with no arguments to restore the control file to the default locations. For example, if you are restoring your control file after a disk failure made some but not all `CONTROL_FILES` locations unusable, you can change `CONTROL_FILES` to replace references to the failed disk with path names pointing to another disk, and then run `RESTORE CONTROLFILE` with no arguments.

You can also restore the control file to any location that you choose other than the `CONTROL_FILES` locations, by using the form `RESTORE CONTROLFILE TO 'filename':`

```
RESTORE CONTROLFILE TO '/tmp/my_controlfile';
```

You can perform this operation with the database in `NOMOUNT`, `MOUNT`, or `OPEN` states, because you are not overwriting any of the control files currently in use. Any existing file named `'filename'` is overwritten. After restoring the control file to a new location, you can then update the `CONTROL_FILES` initialization parameter to include the new location.

See Also:

Oracle Database Backup and Recovery Reference for `RESTORE CONTROLFILE` syntax

20.3.1.2 About RMAN Recovery With and Without a Recovery Catalog

When RMAN is connected to a recovery catalog, the recovery procedure with a backup control file is identical to recovery with a current control file. The RMAN metadata missing from the backup control file is available from the recovery catalog. The only exception is if the database name is not unique in the catalog, in which case you must use `SET DBID` command before restoring the control file.

If you are not using a recovery catalog, then you must restore your control file from an autobackup. To restore the control file from autobackup, the database must be in a `NOMOUNT` state. As shown in [Example 20-2](#) (page 20-6), you must first set the `DBID` for your database, and then use the `RESTORE CONTROLFILE FROM AUTOBACKUP` command.

Example 20-2 *Setting the DBID and Restoring the Control File from Autobackup*

```
SET DBID 320066378;
RUN
{
  SET CONTROLFILE AUTOBACKUP FORMAT
    FOR DEVICE TYPE DISK TO 'autobackup_format';
  RESTORE CONTROLFILE FROM AUTOBACKUP;
}
```

RMAN uses the autobackup format and `DBID` to determine where to hunt for the control file autobackup. If one is found, RMAN restores the control file to all control file locations listed in the `CONTROL_FILES` initialization parameter.

See Also:

- The description of `CONFIGURE CONTROLFILE AUTOBACKUP FORMAT` in the entry for `CONFIGURE` in *Oracle Database Backup and Recovery Reference* to learn how to determine the correct value for the autobackup format.
 - See "[Determining the DBID of the Database](#) (page 17-6)" to learn how to determine your DBID.
-
-

20.3.1.3 About RMAN Recovery When Using a Fast Recovery Area

The commands for restoring a control file are the same whether or not the database uses a fast recovery area. If the database uses a recovery area, then RMAN updates a control file restored from backup by crosschecking all disk-based backups and image copies recorded in the control file. RMAN catalogs any backups in the recovery area that are not recorded. As a result, the restored control file has a complete and accurate record of all backups in the recovery area and any other backups known to the control file at the time of the backup.

RMAN does not automatically crosscheck tape backups after restoring a control file. If you are using tape backups, then you can restore and mount the control file, and optionally crosscheck the backups on tape, as shown in the following example:

```
CROSSCHECK BACKUP DEVICE TYPE sbt;
```

20.3.2 Performing Recovery with a Backup Control File and No Recovery Catalog

This section assumes that you have RMAN backups of the control file, but do not use a recovery catalog. It also assumes that you enabled the control file autobackup feature for the target database and can restore an autobackup of the control file.

Because the autobackup uses a well-known format, RMAN can restore it even though it does not have a repository available that lists the available backups. You can restore the autobackup to the default or a new location. RMAN replicates the control file to all `CONTROL_FILES` locations automatically.

Note:

If you know the backup piece name that contains the control file (for example, from the media manager or because the piece is on disk), then you can specify the piece name using the `RESTORE CONTROLFILE FROM 'filename'` command. The database records the location of every autobackup in the alert log.

Because you are not connected to a recovery catalog, the RMAN repository contains only information about available backups at the time of the control file backup. If you know the location of other usable backup sets or image copies, then add them to the control file RMAN repository with the `CATALOG` command.

To recover the database with a control file autobackup in `NOCATALOG` mode:

1. Start RMAN and connect to a target database.

See Also:

["Making Database Connections with RMAN \(page 4-2\)"](#)

2. Start the target database instance without mounting the database. For example:

```
STARTUP NOMOUNT;
```

3. Set the database identifier for the target database with the `SET DBID` command.

RMAN displays the DBID whenever you connect to a target database. You can also obtain it by inspecting saved RMAN log files, querying the catalog, or looking at the file names of control file autobackup. For example, run:

```
SET DBID 676549873;
```

4. Write an RMAN command file to restore the autobackup control file and perform recovery.

The command file contains the following steps:

- a. Optionally, specify the most recent backup time stamp that RMAN can use when searching for a control file autobackup to restore.
- b. If you know that a different control file autobackup format was in effect when the control file autobackup was created, then specify a nondefault format for the restore of the control file.
- c. If an [SBT](#) channel created the control file autobackup, then allocate one or more SBT channels. Because no recovery catalog is available, you cannot use preconfigured channels.
- d. Restore the autobackup of the control file, optionally setting the maximum number of days backward that RMAN can search and the initial sequence number that it uses in its search for the first day.
- e. If you know that the control file contains information about configured channels that is useful to you in the rest of the restore process, then you can exit RMAN to clear manually allocated channels from [Step 4.c](#) (page 20-8).

If you restart the RMAN client and mount the database, then these configured channels are available for your use. If you do not care about using configured channels from your control file, then you can simply mount the database.

- f. This step depends on whether the online redo logs are available. The option `OPEN RESETLOGS` is always required after recovery with a backup control file, regardless of whether logs are available.

If the online redo logs are usable, then RMAN can find and apply these logs. Perform a complete restore and recovery as described in ["Performing Complete Database Recovery \(page 17-12\)"](#).

If the online redo logs are unusable, then perform DBPITR as described in ["Performing Database Point-in-Time Recovery \(page 18-25\)"](#). An `UNTIL` clause is required to specify a target time, SCN, or log sequence number for the recovery before the first SCN of the online redo logs (otherwise, RMAN issues the `RMAN-6054` error).

When you perform DBPITR with a backup control file, before opening the database with `RESETLOGS`, you can open the database read-only using

SQL*Plus and run queries as needed to verify that the effects of the logical corruption have been reversed. If you are satisfied with the results, then you can open the database with RESETLOGS.

Note:

When specifying log sequences, if the last created archived redo log has sequence n , then specify UNTIL SEQUENCE $n+1$ so that RMAN applies n and then stops.

In the following example, the online redo log files have been lost, and the most recent archived redo log sequence number is 13243. This example shows how to restore the control file autobackup and recover through the latest log.

```

RUN
{
# Optionally, set upper limit for eligible time stamps of control file
# backups
# SET UNTIL TIME '09/10/2013 13:45:00';
# Specify a nondefault autobackup format only if required
# SET CONTROLFILE AUTOBACKUP FORMAT FOR DEVICE TYPE DISK
#   TO '?/oradata/%F.bck';
ALLOCATE CHANNEL c1 DEVICE TYPE sbt PARMS '...'; # allocate manually
RESTORE CONTROLFILE FROM AUTOBACKUP
    MAXSEQ 100          # start at sequence 100 and count down
    MAXDAYS 180;       # start at UNTIL TIME and search back 6 months
ALTER DATABASE MOUNT;
}
# Now use automatic channels configured in restored control file
RESTORE DATABASE UNTIL SEQUENCE 13244;
RECOVER DATABASE UNTIL SEQUENCE 13244;

```

5. If recovery was successful, then open the database and reset the online logs:

```
ALTER DATABASE OPEN RESETLOGS;
```

20.4 Performing Disaster Recovery

Disaster recovery includes the restoration and recovery of the target database after the loss of the entire target database, the recovery catalog database, all current control files, all online redo log files, and all parameter files.

This section contains the following topics:

- [Prerequisites of Disaster Recovery](#) (page 20-9)
- [Recovering the Database After a Disaster](#) (page 20-10)

20.4.1 Prerequisites of Disaster Recovery

To perform a disaster recovery, you must have the following:

- Backups of all data files
- All archived redo logs generated after the creation time of the oldest backup that you intend to restore
- At least one control file autobackup

- A record of the DBID of the database

20.4.2 Recovering the Database After a Disaster

The procedure for disaster recovery is similar to the procedure for recovering the database with a backup control file in NOCATALOG mode. If you are restoring the database to a new host, then review the considerations described in "[Restoring a Database on a New Host](#) (page 20-12)".

This scenario assumes that the Linux server on which your database was running has been damaged beyond repair. Fortunately, you backed up the database to Oracle Secure Backup and have the tapes available. The scenario assumes the following:

- Oracle Database is installed on the new host.
- You are restoring the database to a new Linux host with the same directory structure as the old host.
- You have one tape drive containing backups of all the data files and archived redo logs through log 1124, and autobackups of the control file and server parameter file.
- You do not use a recovery catalog with the database.

To recover the database on the new host:

1. Ensure that the prerequisites described in [Prerequisites of Disaster Recovery](#) (page 20-9) are met.
2. If possible, restore or re-create all relevant network files such as `tnsnames.ora` and `listener.ora` and a password file.
3. Start RMAN and connect to the target database instance.

At this stage, no initialization parameter file exists. If you have set `ORACLE_SID` and `ORACLE_HOME`, then you can use operating system authentication to connect as `SYSDBA` or `SYSBACKUP`.

See Also:

["Making Database Connections with RMAN](#) (page 4-2)"

4. Specify the DBID for the target database with the `SET DBID` command, as described in "[Restoring the Server Parameter File](#) (page 20-2)".

For example, enter the following command:

```
SET DBID 676549873;
```

5. Run the `STARTUP NOMOUNT` command.

When the server parameter file is not available, RMAN attempts to start the instance with a dummy server parameter file.

6. Allocate a channel to the media manager and then restore the server parameter file from autobackup.

For example, enter the following command to restore the server parameter file from Oracle Secure Backup:

```

RUN
{
  ALLOCATE CHANNEL c1 DEVICE TYPE sbt;
  RESTORE SPFILE FROM AUTOBACKUP;
}

```

7. Restart the instance with the restored server parameter file.

```
STARTUP FORCE NOMOUNT;
```

8. Write a command file to perform the restore and recovery operation, and then execute the command file. The command file must do the following:
 - a. Allocate a channel to the media manager.
 - b. Restore a control file autobackup (see ["Performing Recovery with a Backup Control File and No Recovery Catalog \(page 20-7\)"](#)).
 - c. Mount the restored control file.
 - d. Catalog any backups not recorded in the repository with the CATALOG command.
 - e. Restore the data files to their original locations. If volume names have changed, then run SET NEWNAME commands before the restore operation and perform a switch after the restore operation to update the control file with the new locations for the data files, as shown in the following example.
 - f. Recover the data files. RMAN stops recovery when it reaches the log sequence number specified.

```

RMAN> RUN
{
  # Manually allocate a channel to the media manager
  ALLOCATE CHANNEL t1 DEVICE TYPE sbt;
  # Restore autobackup of the control file. This example assumes that you have
  # accepted the default format for the autobackup name.
  RESTORE CONTROLFILE FROM AUTOBACKUP;
  # The set until command is used in case the database
  # structure has changed in the most recent backups, and you want to
  # recover to that point in time. In this way RMAN restores the database
  # to the same structure that the database had at the specified time.
  ALTER DATABASE MOUNT;
  SET UNTIL SEQUENCE 1124 THREAD 1;
  RESTORE DATABASE;
  RECOVER DATABASE;
}

```

The following example of the RUN command shows the same scenario except with new file names for the restored data files:

```

RMAN> RUN
{
  # If you must restore the files to new locations,
  # use SET NEWNAME commands:
  SET NEWNAME FOR DATAFILE 1 TO '/dev/vgd_1_0/rlvt5_500M_1';
  SET NEWNAME FOR DATAFILE 2 TO '/dev/vgd_1_0/rlvt5_500M_2';
  SET NEWNAME FOR DATAFILE 3 TO '/dev/vgd_1_0/rlvt5_500M_3';
  ALLOCATE CHANNEL t1 DEVICE TYPE sbt;
  RESTORE CONTROLFILE FROM AUTOBACKUP;
  ALTER DATABASE MOUNT;
  SET UNTIL SEQUENCE 124 THREAD 1;
}

```

```
RESTORE DATABASE;  
SWITCH DATAFILE ALL; # Update control file with new location of data files.  
RECOVER DATABASE;  
}
```

9. If recovery was successful, then open the database and reset the online logs:

```
ALTER DATABASE OPEN RESETLOGS;
```

20.5 Restoring a Database on a New Host

If your goal is to perform a test run of your disaster recovery procedures, or to permanently move a database to a new host, then you can use the procedure in this section. This procedure uses the `RESTORE` and `RECOVER` commands.

If you use the procedure in this section, then the DBID for the restored database is the same as the DBID for the original database. Do not register a test database created in this way in the same recovery catalog as the source database. Because the DBID of the two databases is the same, the metadata for the test database can interfere with RMAN's ability to restore and recover the source database.

If your goal is to create a copy of your target database for ongoing use on a new host, then use the `RMAN DUPLICATE` command instead of this procedure. The `DUPLICATE` command assigns a new DBID to the database it creates, enabling it to be registered in the same recovery catalog as the original database.

See Also:

["Overview of RMAN Database Duplication \(page 25-1\)"](#) to learn how to duplicate a database

This section contains the following topics:

- [Preparing to Restore a Database on a New Host \(page 20-12\)](#)
- [Restoring Disk Backups to a New Host \(page 20-13\)](#)
- [Testing the Restore of a Database on a New Host \(page 20-14\)](#)

20.5.1 Preparing to Restore a Database on a New Host

To prepare for the restoration of the database to a new host, take the following steps:

- Record the DBID for your source database. If you do not know the DBID for your database, then see ["Determining the DBID of the Database \(page 17-6\)"](#) to learn how to determine the DBID.
- Make the source database initialization parameter file accessible on the new host. Copy the file from the old host to a new host by using an operating system utility.
- If you perform a test restore operation only, then ensure that RMAN is *not* connected to the recovery catalog. Otherwise, RMAN records metadata about the restored data files in the recovery catalog. This metadata interferes with future attempts to restore and recover the primary database.

If you must use a recovery catalog because the control file is not large enough to contain the RMAN repository data on all of the backups that you must restore, then use Oracle Data Pump to export the catalog and import it into a different

schema or database. Afterward, use the copied recovery catalog for the test restore. Otherwise, the recovery catalog considers the restored database as the current target database.

- Ensure that backups used for the restore operation are accessible on the restore host. For example, if the backups were made with a media manager, then verify that the tape device is connected to the new host. If you are using disk copies, then use the procedure in the following section.
- If you are performing a trial restore of the production database, then perform either of the following actions before restoring the database in the test environment:
 - If the test database will use a fast recovery area that is physically *different* from the recovery area used by the production database, then set `DB_RECOVERY_FILE_DEST` in the test database instance to the new location.
 - If the test database will use a fast recovery area that is physically the *same* as the recovery area used by the production database, then set `DB_UNIQUE_NAME` in the test database instance to a different name from the production database.

If you do not perform either of the preceding actions, then RMAN assumes that you are restoring the production database and deletes flashback logs from the fast recovery area because they are considered unusable.

20.5.2 Restoring Disk Backups to a New Host

To move the database to a new host by using data file copies or backup sets on disk, you must transfer the files manually to the new host. This example assumes that RMAN is using a recovery catalog.

To restore backup files to a new host:

1. Start RMAN and connect to a target database and recovery catalog.

See Also:

["Making Database Connections with RMAN \(page 4-2\)"](#)

2. Run a `LIST` command to see a listing of backups of the data file and control file autobackups.

For example, enter the following command to view data file copies:

```
LIST COPY;
```

For example, enter the following command to view control file backups:

```
LIST BACKUP OF CONTROLFILE;
```

The piece name of the autobackup must use the `%F` substitution variable, so the autobackup piece name includes the string `c-#####-YYYYMMDD-##`, where `#####` stands for the DBID, `YYYYMMDD` is a time stamp in the Gregorian calendar of the day the backup is generated, and `##` is the sequence in hexadecimal.

3. Copy the backups to the new host with an operating system utility.

Enter a command such as the following to copy all data file copies to the `?`/`oradata/trgt` directory on the new host:

```
% cp -r /disk1/*dbf /net/new_host/oracle/oradata/trgt
```

Enter a command such as the following to copy the autobackup backup piece to the `/tmp` directory on the new host:

```
% cp -r /disk1/auto_bkp_loc/c-1618370911-20130208-00 /net/new_host/tmp
```

As explained in "[Restoring the Server Parameter File from a Control File Autobackup](#) (page 20-3)", you must use the `SET CONTROLFILE AUTOBACKUP FORMAT` command when restoring an autobackup from a nondefault location.

20.5.3 Testing the Restore of a Database on a New Host

This scenario tests whether you can restore your database to a new host. In this scenario, you have two networked Linux hosts, `hosta` and `hostb`. A target database named `trgta` is on `hosta` and is registered in recovery catalog `catdb`. You want to test the restore and recovery of `trgta` on `hostb`, while keeping database `trgta` up and running on `hosta`.

Now, assume that the directory structure of `hostb` is different from `hosta`. The target database is located in `/net/hosta/dev3/oracle/dbs`, but you want to restore the database to `/net/hostb/oracle/oradata/test`. You have tape backups of data files, control files, archived redo logs, and the server parameter file on a media manager accessible by both hosts. The `ORACLE_SID` for the `TRGTA` database is `TRGTA` and does not change for the restored database.

Caution:

If you are restoring the database for test purposes, then *never* connect RMAN to the test database and the recovery catalog.

To restore the database on a new host:

1. Ensure that the backups of the target database are accessible on the new host.

To test disaster recovery, you must have a recoverable backup of the target database. When preparing your disaster recovery strategy, ensure that the backups of the data files, control files, and server parameter file are restorable on `hostb`. Thus, you must configure the media management software so that `hostb` is a media manager client and can read the backup sets created on `hosta`. Consult the media management vendor for support on this issue.

2. Configure the `ORACLE_SID` on `hostb`.

This scenario assumes that you want to start the RMAN client on `hostb` and authenticate yourself through the operating system. However, you must be connected to `hostb` either locally or through a net service name.

After logging in to `hostb` with administrator privileges, edit the `/etc/group` file so that you are included in the `DBA` group:

```
dba:*:614:<your_user_name>
```

Set the `ORACLE_SID` environment variable on `hostb` to the same value used on `hosta`:

```
% setenv ORACLE_SID trgta
```

3. Start RMAN on `hostb` and connect to the target database *without* connecting to the recovery catalog.

For example, enter the following command:

```
% rman NOCATALOG
RMAN> CONNECT TARGET /
```

See Also:

["Making Database Connections with RMAN \(page 4-2\)"](#)

4. Set the DBID and start the database instance without mounting the database.

For example, run `SET DBID` to set the DBID, then run `STARTUP NOMOUNT`:

```
SET DBID 1340752057;
STARTUP NOMOUNT
```

RMAN fails to find the server parameter file, which has not yet been restored, but starts the instance with a "dummy" file. Sample output follows:

```
startup failed: ORA-01078: failure in processing system parameters
LRM-00109: could not open parameter file '/net/hostb/oracle/dbs/inittrgta.ora'
```

```
trying to start the Oracle instance without parameter files ...
Oracle instance started
```

5. Restore and edit the server parameter file.

Because you enabled the control file autobackup feature when making your backups, the server parameter file is included in the backup. If you are restoring an autobackup that has a nondefault format, then use the `SET CONTROLFILE AUTOBACKUP FORMAT` command to indicate the format.

Allocate a channel to the media manager, then restore the server parameter file as a client-side parameter file and use the `SET` command to indicate the location of the autobackup (in this example, the autobackup is in `/tmp`):

```
RUN
{
  ALLOCATE CHANNEL c1 DEVICE TYPE sbt PARMS '...';
  SET CONTROLFILE AUTOBACKUP FORMAT FOR DEVICE TYPE DISK TO '/tmp/%F';
  RESTORE SPFILE
    TO PFILE '?/oradata/test/inittrgta.ora'
    FROM AUTOBACKUP;
  SHUTDOWN ABORT;
}
```

6. Edit the restored initialization parameter file.

Change any location-specific parameters, for example, those ending in `_DEST`, to reflect the new directory structure. For example, edit the following parameters:

```
- IFILE
- LOG_ARCHIVE_DEST_1
- CONTROL_FILES
```

7. Restart the instance with the edited initialization parameter file.

For example, enter the following command:

```
STARTUP FORCE NOMOUNT PFILE='?/oradata/test/inittrgta.ora';
```

8. Restore the control file from an autobackup and then mount the database.

For example, enter the following command:

```
RUN
{
  ALLOCATE CHANNEL c1 DEVICE TYPE sbt PARMS '...';
  RESTORE CONTROLFILE FROM AUTOBACKUP;
  ALTER DATABASE MOUNT;
}
```

RMAN restores the control file to whatever locations you specified in the CONTROL_FILES initialization parameter.

9. Catalog the data file copies that you copied in "[Restoring Disk Backups to a New Host](#) (page 20-13)", using their new file names or CATALOG START WITH (if you know all the files are in directories with a common prefix easily addressed with a CATALOG START WITH command). For example, run:

```
CATALOG START WITH '/oracle/oradata/trgt/';
```

If you want to specify files individually, then you can execute a CATALOG command as follows:

```
CATALOG DATAFILECOPY
  '/oracle/oradata/trgt/system01.dbf', '/oracle/oradata/trgt/undotbs01.dbf',
  '/oracle/oradata/trgt/cwmlite01.dbf', '/oracle/oradata/trgt/drsys01.dbf',
  '/oracle/oradata/trgt/example01.dbf', '/oracle/oradata/trgt/indx01.dbf',
  '/oracle/oradata/trgt/tools01.dbf', '/oracle/oradata/trgt/users01.dbf';
```

10. Start a SQL*Plus session on the new database and query the database file names recorded in the control file.

Because the control file is from the trgta database, the recorded file names use the original hosta file names. You can query V\$ views to obtain this information. Run the following query in SQL*Plus:

```
COLUMN NAME FORMAT a60
SPOOL LOG '/tmp/db_filenames.out'
SELECT FILE# AS "File/Grp#", NAME
FROM V$DATAFILE
UNION
SELECT GROUP#,MEMBER
FROM V$LOGFILE;
SPOOL OFF
EXIT
```

11. Write the RMAN restore and recovery script. The script must include the following steps:
 - a. For each data file on the destination host that is restored to a different path than it had on the source host, use a SET NEWNAME command to specify the new path on the destination host. If the file systems on the destination system are set up to have the same paths as the source host, then do not use SET NEWNAME for those files restored to the same path as on the source host.
 - b. For each online redo log that is to be created at a different location than it had on the source host, use SQL ALTER DATABASE RENAME FILE commands to

specify the path name on the destination host. If the file systems on the destination system are set up to have the same paths as the source host, then do not use `ALTER DATABASE RENAME FILE` for those files restored to the same path as on the source host.

- c. Perform a `SET UNTIL` operation to limit recovery to the end of the archived redo logs. The recovery stops with an error if no `SET UNTIL` command is specified.
- d. Restore and recover the database.
- e. Run the `SWITCH DATAFILE ALL` command so that the control file recognizes the new path names as the official new names of the data files.

The following code shows the RMAN script `reco_test.rman` that can perform the restore and recovery operation.

```
RUN
{
  # allocate a channel to the tape device
  ALLOCATE CHANNEL c1 DEVICE TYPE sbt PARMS '...';

  # rename the data files and online redo logs
  SET NEWNAME FOR DATAFILE 1 TO '?/oradata/test/system01.dbf';
  SET NEWNAME FOR DATAFILE 2 TO '?/oradata/test/undotbs01.dbf';
  SET NEWNAME FOR DATAFILE 3 TO '?/oradata/test/cwmlite01.dbf';
  SET NEWNAME FOR DATAFILE 4 TO '?/oradata/test/drsys01.dbf';
  SET NEWNAME FOR DATAFILE 5 TO '?/oradata/test/example01.dbf';
  SET NEWNAME FOR DATAFILE 6 TO '?/oradata/test/indx01.dbf';
  SET NEWNAME FOR DATAFILE 7 TO '?/oradata/test/tools01.dbf';
  SET NEWNAME FOR DATAFILE 8 TO '?/oradata/test/users01.dbf';
  ALTER DATABASE RENAME FILE '/dev3/oracle/dbs/redo01.log'
    TO '?/oradata/test/redo01.log';
  ALTER DATABASE RENAME FILE '/dev3/oracle/dbs/redo02.log'
    TO '?/oradata/test/redo02.log';

  # Do a SET UNTIL to prevent recovery of the online logs
  SET UNTIL SCN 123456;
  # restore the database and switch the data file names
  RESTORE DATABASE;
  SWITCH DATAFILE ALL;

  # recover the database
  RECOVER DATABASE;
}
EXIT
```

12. Execute the script created in the previous step.

For example, start RMAN to connect to the target database and run the `@` command:

```
% rman TARGET / NOCATALOG
RMAN> @reco_test.rman
```

13. Open the restored database with the `RESETLOGS` option.

From the RMAN prompt, open the database with the `RESETLOGS` option:

```
ALTER DATABASE OPEN RESETLOGS;
```

Caution:

When you re-open your database in the next step, do not connect to the recovery catalog. Otherwise, the new database incarnation created is registered automatically in the recovery catalog, and the file names of the production database are replaced by the new file names specified in the script.

14. Optionally, delete the test database with all of its files.

Note:

If you used an ASM disk group, then the `DROP DATABASE` command is the only way to safely remove the files of the test database. If you restored to non-ASM storage then you can also use operating system commands to remove the database.

Use the `DROP DATABASE` command to delete all files associated with the database automatically. The following example deletes the database files:

```
STARTUP FORCE NOMOUNT PFILE='?/oradata/test/inittrgta.ora';
DROP DATABASE;
```

Because you did not perform the restore and recovery operation when connected to the recovery catalog, the recovery catalog contains no records for any of the restored files or the procedures performed during the test. Likewise, the control file of the `trgta` database is completely unaffected by the test.

20.6 Restoring Backups Created Using Older Versions of RMAN

You can restore backups that were created using older versions of RMAN, up to Oracle Database 9i Release 2 (9.2.0.8).

There must be a supported upgrade path between the Oracle Database version on which the backups were created and the Oracle software version on which you want to run the restored database.

In this example, the source database is an Oracle Database 11g Release 2 database and it is configured to use a server parameter file (spfile). The database runs in `ARCHIVELOG` mode and uses a fast recovery area. Control file autobackups are also configured. You then create RMAN backups of the source database, including the archived redo logs.

The destination host on which these backups are restored has Oracle Database 12c Release 1 installed.

To restore RMAN backups that were created using an RMAN version that is older than the current target database version:

1. Verify that there is a supported upgrade path from the database version on which the backups were created to the Oracle server version on which you plan to restore the database.

For example, if your RMAN backups were created on Oracle Database 11g Release 2 (11.2.0.3) and you want to run the restored database on Oracle Database 12c Release 1 (12.1), then you must verify that there is a supported upgrade path from release 11.2.0.3 to release 12.1.

See Also:

Oracle Database Upgrade Guide for information about the database upgrade paths

2. Ensure that the source database backups are available at the destination host on which they must be restored.

You can either use an operating system utility to copy the backups to the destination host or store the backups in a shared location that is accessible to the destination host.

3. Shut down the destination database.
4. On the destination host, set the `ORACLE_SID` to the same value that was used on the source database.

```
% setenv ORACLE_SID db112
```

5. Start RMAN on the destination host and connect to the target database using operating system authentication and without a recovery catalog.

```
% rman target / NOCATALOG
```

6. Set the `DBID` to the same value as the source database.

The following command sets the `DBID` to 699892390, which is the `DBID` of the source database whose backups are being restored.

```
RMAN> set DBID 699892390;
```

7. Start the target database in `nomount` mode.

```
RMAN> startup nomount;
```

RMAN fails to find the server parameter file, which has not yet been restored. However, the instance is started with a “dummy” file and the following output is displayed:

```
startup failed: ORA-01078: failure in processing system parameters
LRM-00109: could not open parameter file '/oracle/dbs/inittrgta.ora'
trying to start the Oracle instance without parameter files ...
Oracle instance started
```

8. Restore the server parameter file from the source database autobackup.

Because controlfile autobackups were enabled in the source database, the server parameter file is included in the backup. To restore an autobackup that has a nondefault format, use the `SET CONTROLFILE AUTOBACKUP FORMAT` command to indicate the format.

The following example sets the autobackup format, restores the spfile in the source database to the pfile `/dev3/oracle/network/init_db112.ora`, and then shuts down the target database.

```
run
{
  set controlfile autobackup format for device type disk to '/scratch/fra/cf/
%F.bck';
  restore spfile to pfile '/dev3/oracle/network/init_db112.ora' from autobackup
```

```

recovery area '/scratch /fra/cf' db_name 'DB112';
    shutdown abort;
}

```

9. Edit the restored initialization parameter file and modify the required initialization parameters.

This includes the `COMPATIBLE` parameter, if the compatibility requirement for the target database is different from that set in the source database, and parameters that are deprecated in the target database release. Also update any location-specific parameters such as those ending with `_DEST` to reflect the new directory structure.

In this example, you must edit the pfile located at `/dev3/oracle/network/init_db112.ora`.

10. Restart the instance with the edited initialization parameter file.

The following command starts the database instance in nomount mode using the edited parameter file.

```

RMAN> startup force nomount pfile='/dev3/oracle/network/init_db112.ora';

```

11. Restore the control file from an autobackup and then mount the database.

The following example sets the format for the control file autobackups, restores the control file from an autobackup, and then mounts the database.

```

run
{
    set controlfile autobackup format for device type disk to '/scratch/fra/cf/
%F.bck';
    restore controlfile from autobackup recovery area '/scratch/fra/cf' db_name
'DB112';
    alter database mount;
}

```

The control file is restored to the location specified in the `CONTROL_FILES` initialization parameter in the edited initialization parameter file.

12. Catalog data file copies of the source database that were made available to the destination host.

If all the files are in directories with a common prefix, then use the `CATALOG START WITH` command. If you want to specify the file names individually, then use the `CATALOG DATAFILECOPY` command.

In the following example, all the data file copies are stored in a single folder `/scratch/fra/DB112/backupset` and so we use the `CATALOG START WITH` command.

```

RMAN> catalog start with '/scratch/fra/DB112/backupset';

```

13. Restore and recover the source database.

If the data files are restored to a different path than those on the source database, you must specify a new path on the destination host by using the `SET NEWNAME` command. If the online redo logs are to be created in a different location than those on the source database, then use the `ALTER DATABASE RENAME FILE` command to specify the location of each redo log file on the destination database.

In this example, the `SET NEWNAME FOR DATABASE` command is used to specify the new location for all restored data files. The new location for each online redo

log file is specified using an ALTER DATABASE RENAME FILE command. Recovery is performed until the SCN specified in the command.

```
run
{
  set newname for database to '/ade/b/1885631999/oracle/dbs/%U.f';
  alter database rename file '/dev1/oracle/dbs/redo01.log' to '/dev3/oracle/dbs/redo1.log';
  alter database rename file '/dev1/oracle/dbs/redo02.log' to '/dev3/oracle/dbs/redo2.log';
  set until scn 1092435;
  restore database;
  switch datafile all;
  recover database;
}
```

14. Open the restored database with the RESETLOGS and UPGRADE options.

```
RMAN> alter database open resetlogs upgrade;
Statement processed
RMAN-06900: WARNING: unable to generate V$RMAN_STATUS or V$RMAN_OUTPUT row
RMAN-06901: WARNING: disabling update of the V$RMAN_STATUS and V$RMAN_OUTPUT rows
ORACLE error from target database:
ORA-04023: Object SYS.STANDARD could not be validated or authorized
```

The error is caused by database packages that need to be revalidated as part of the upgrade process.

15. Exit RMAN.

16. Upgrade the target database to the desired Oracle release by performing the steps required to upgrade a database.

See Also:

Oracle Database Upgrade Guide for information about upgrading the database

20.7 Restoring and Recovering Files Over the Network

RMAN enables you to restore or recover files by connecting, over the network, to a physical standby database that contains the required files. You can restore an entire database, data files, control files, server parameter file, or tablespaces. Restoring files over the network is very useful in scenarios where you need to synchronize the primary and standby databases.

Backup sets are used to restore or recover files over the network. Therefore, you can use multisection backups, encryption, and compression to improve backup and restore performance.

Restoring and recovering files over the network is supported starting with Oracle Database 12c Release 1 (12.1).

This section includes:

- [About Restoring Files Over the Network](#) (page 20-22)
- [About Recovering Files Over the Network](#) (page 20-22)
- [Scenarios for Restoring and Recovering Files Over the Network](#) (page 20-22)

- [Restoring Data Files Over the Network](#) (page 20-23)
- [Rolling Forward a Physical Standby Database Using the RECOVER Command](#) (page 20-23)

20.7.1 About Restoring Files Over the Network

RMAN restores database files, over the network, from a physical standby database by using the `FROM SERVICE` clause of the `RESTORE` command. The `FROM SERVICE` clause provides the service name of the physical standby database from which the files must be restored. During the restore operation, RMAN creates backup sets, on the physical standby database, of the files that need to be restored and then transfers these backup sets to the target database over the network.

Use the `SECTION SIZE` clause of the `RESTORE` command to perform a multisection restore operation. To encrypt the backup sets created on the physical standby database, use the `SET ENCRYPTION` command before the `RESTORE` command to specify the encryption algorithm used.

To transfer files from the physical standby database as compressed backup sets, use the `USING COMPRESSED BACKUPSET` clause in the `RESTORE` command. By default, RMAN compresses backup sets using the algorithm that is set in the RMAN configuration. You can override the default and set a different algorithm by using the `SET COMPRESSION ALGORITHM` command before the `RESTORE` statement.

20.7.2 About Recovering Files Over the Network

RMAN can perform recovery by fetching an incremental backup, over the network, from a primary database and then applying this incremental backup to the physical standby database. RMAN is connected as `TARGET` to the physical standby database. The recovery process is optimized by restoring only the used data blocks in a data file. Use the `FROM SERVICE` clause to specify the service name of the primary database from which the incremental backup must be fetched.

To use multisection backup sets during the recovery process, specify the `SECTION SIZE` clause in the `RECOVER` command. To transfer the required files from the primary database as encrypted backup sets, use the `SET ENCRYPTION` command before the `RESTORE` command to specify the encryption algorithm used to create the backup sets.

To compress backup sets that are used to recover files over the network, use the `USING COMPRESSED BACKUPSET`. RMAN compresses backup sets when it creates them on the primary database and then transfers these backup sets to the target database.

20.7.3 Scenarios for Restoring and Recovering Files Over the Network

Recovering files by connecting, over the network, to physical standby database is useful in the following scenarios:

- You need to roll-forward a physical standby database to make it in-sync with the primary database.
After creating an incremental backup of the latest changes on the primary database, you can restore the physical standby database using the incremental backup.
- You want to restore lost data files, control files, or tablespaces on a primary database using the corresponding files on the physical standby database. You can also restore files on a physical standby database by using the primary database.

20.7.4 Restoring Data Files Over the Network

In this example, the `DB_UNIQUE_NAME` of the primary database is `MAIN` and the `DB_UNIQUE_NAME` of the physical standby database is `STANDBY`. The data file `sales.dbf` on the primary database was lost. You want to restore this data file from the physical standby database. The service name of the physical standby database is `standby_tns`. The `RESTORE` command with the `FROM SERVICE` clause enables you to restore the lost data file in the primary database by using the data file in the physical standby database. The password file in the primary database and the physical standby database are the same.

Use the following steps to restore the data file `sales.dbf` in the primary database by using the data file in the physical standby database:

1. Connect to the primary database as a user with the `SYSBACKUP` privilege.

```
%RMAN
RMAN> CONNECT TARGET "sbu@main AS SYSBACKUP";
```

Enter the password for the `sbu` user when prompted.

2. Specify that the backup sets must be encrypted using the AES128 encryption algorithm

```
RMAN> SET ENCRYPTION ALGORITHM 'AES128';
```

3. Ensure that the `tnsnames.ora` file in the physical standby database contains an entry corresponding to the primary database. Also ensure that the password files on the primary and physical standby database are the same.
4. Restore the data file on the primary database by using the data file on the physical standby database. The following command creates multisection backup sets to perform the restore operation.

```
RESTORE DATAFILE '/oradata/datafiles/sales.dbf'
FROM SERVICE standby_tns
SECTION SIZE 120M;
```

20.7.5 Rolling Forward a Physical Standby Database Using the RECOVER Command

You can use the `RECOVER ... FROM SERVICE` command to synchronize the data files on the physical standby database with those on the primary database. `RMAN` creates an incremental backup containing the changes to the primary database, transfers the incremental backup over the network to the physical standby database, and then applies the incremental backup to the physical standby database. All changes to data files on the primary database, beginning with the SCN in the standby data file header, are included in the incremental backup.

The `RECOVER ... FROM SERVICE` command refreshes the standby data files and rolls them forward to the same point-in-time as the primary. However, the standby control file still contains old SCN values which are lower than the SCN values in the standby data files. Therefore, to complete the synchronization of the physical standby database, you must refresh the standby control file and then update the data file names, online redo log file names, and the standby redo log file names in the refreshed standby control file.

If network resources are a constraint, then you can use the `BACKUP INCREMENTAL` command to create incremental backups on the primary database, and then use the incremental backups to roll forward the physical standby database.

[Steps to Refresh a Physical Standby Database with Changes Made to the Primary Database](#) (page 20-24) describes the steps to refresh a physical standby using the `FROM SERVICE` clause.

See Also:

Oracle Data Guard Concepts and Administration for information about using the `BACKUP INCREMENTAL` command to roll forward a physical standby database

20.7.5.1 Steps to Refresh a Physical Standby Database with Changes Made to the Primary Database

Assume that the `DB_UNIQUE_NAME` of the primary database is `MAIN` and its net service name is `primary_db`. The `DB_UNIQUE_NAME` of the standby database is `STANDBY` and its net service name is `standby_db`.

Use the following steps to refresh the physical standby database with changes made to the primary database:

1. Ensure that the following prerequisites are met:
 - Oracle Net connectivity is established between the physical standby database and the primary database.

You can do this by adding an entry corresponding to the primary database in the `tnsnames.ora` file of the physical standby database.

See Also:

Oracle Database Net Services Administrator's Guide for information about establishing Oracle Net connectivity

- The password files on the primary database and the physical standby database are the same.
 - The `COMPATIBLE` parameter in the initialization parameter file of the primary database and physical standby database is set to 12.0.
2. Start RMAN and connect as target to the physical standby database. It is recommended that you also connect to a recovery catalog.

The following commands connect as `TARGET` to the physical standby database and as `CATALOG` to the recovery catalog. The connection to the physical standby is established using the `sbu` user, who has been granted `SYSBACKUP` privilege. The net service name of the physical standby database is `standby_db` and that of the recovery catalog is `catdb`.

```
CONNECT TARGET "sbu@standby_db AS SYSBACKUP";  
CONNECT CATALOG rman@catdb;
```

3. Obtain the names of the data files and the temp files in the physical standby database using the following command:

```
REPORT SCHEMA;
```

This command also implicitly resynchronizes the recovery catalog and ensures that it contains all the file names of the standby database.

4. Note the names of the online redo log files and standby redo log files of the physical standby database. You may require these names in a later step.

The following command lists the names and group identifiers of the redo log files:

```
SELECT type, group#, member FROM v$logfile;
```

5. Stop the managed recovery processes on the physical standby database.

The following command stops the recovery processes:

```
ALTER DATABASE RECOVER MANAGED STANDBY DATABASE CANCEL;
```

When using Data Guard Broker, use the following command to stop the managed recovery process:

```
DGMGRL > edit database standby_db set state='APPLY-OFF';
```

6. Note the current SCN of the physical standby database. This is required to determine, in a later step, if new data files were added to the primary database.

Query the V\$DATABASE view to obtain the current SCN using the following command:

```
SELECT CURRENT_SCN FROM V$DATABASE;
```

7. Place the physical standby database in NOMOUNT mode.

Use the following steps to place the standby in NOMOUNT mode:

```
SHUTDOWN IMMEDIATE;
STARTUP NOMOUNT;
```

8. Restore the standby control file by using the control file on the primary database.

The following command restores the control file on the physical standby database by using the primary database control file.

```
RESTORE STANDBY CONTROLFILE FROM SERVICE primary_db;
```

After this step, the names of files in the standby control file are the names that were used in the primary database.

9. Mount the standby database using the following command:

```
ALTER DATABASE MOUNT;
```

10. Update the names of the data files and the temp files in the standby control file.

- If you are connected to a recovery catalog, then use the following command to update the file names:

```
RECOVER DATABASE NOREDO;
```

- If you are not connected to a recovery catalog, then use the CATALOG command and the SWITCH command to update all the data file names.

```
CATALOG START WITH '/disk2/datafiles/';
SWITCH DATABASE TO COPY;
```

Here, `/disk2/datafiles/` is the location of the data files on the physical standby database. All data files must be stored in this location.

If the data files are in different locations, then use the `ALTER DATABASE RENAME FILE` command to rename data files.

11. Refresh the data files on the physical standby database by using an incremental backup of the data files on the primary database.

The following command creates a multisection incremental backup on the primary database that is then used to refresh the standby data files. `primary_db` is the net service name of the primary database that is used to refresh the standby database. The `NOREDO` clause specifies that the archived redo log files must not be applied during recovery.

```
RECOVER DATABASE
FROM SERVICE primary_db
NOREDO
SECTION SIZE 120M;
```

12. Use the current SCN returned in Step 6 to determine if new data files were added to the primary database since the standby database was last refreshed. If yes, these data files need to be restored on the standby from the primary database.

The following example assumes that the `CURRENT_SCN` returned in Step 6 is 35806 and lists the data files that were created on the primary after the timestamp represented by this SCN:

```
SELECT file# FROM V$DATAFILE WHERE creation_change# >= 35806;
```

13. If no files are returned in Step 12, then go to Step 14. If one or more files are returned in Step 12, then restore these data files from the primary database.

- If you are not connected to a recovery catalog, then use the following commands to restore data files that were added to the primary after the standby was last refreshed (data files 15 and 17 were added to the primary):

```
RUN
{
SET NEWNAME FOR DATABASE TO '/oracle/database';
RESTORE DATAFILE 15, 17 FROM SERVICE primary_db;
}
```

- If you are connected to a recovery catalog, then use the following command to restore data files that were added to the primary after the standby was last refreshed (data files 15 and 17 were added to the primary):

```
RESTORE DATAFILE 15, 17 FROM SERVICE primary_db;
```

14. Update the names of the online redo logs and standby redo logs in the standby control file using one of the following methods:

- Use the `ALTER DATABASE CLEAR` command to clear the log files in all redo log groups of the standby database. RMAN then recreates all the standby redo logs and the online redo log files.

Note:

Clearing log files is recommended only if the standby database does not have access to the online redo log files and standby redo log files of the primary database. If the standby database has access to the redo log files of the primary database and the redo log file names of the primary database are OMF names, then the `ALTER DATABASE` command will delete log files on the primary database.

The `GROUP#` column of the `V$LOGFILE` view queried in Step 4 (page 20-25) provides the redo log group identifiers of the log groups that must be cleared. Use separate `ALTER DATABASE CLEAR` commands to clear each redo log group.

The following command clears the redo log group with identifier 2.

```
ALTER DATABASE CLEAR LOGFILE GROUP 2;
```

You can delete the old redo log files after clearing all the redo log groups.

- Use the `ALTER DATABASE RENAME FILE` command to rename the redo log files. Use a separate command to rename each log file listed in Step 4 (page 20-25).

To rename log files, the `STANDBY_FILE_MANAGEMENT` initialization parameter must be set to `MANUAL`. Renaming log files is recommended when the number of online redo logs files and standby redo log files is the same in the primary database and the physical standby database.

See Also:

Oracle Database SQL Language Reference for the `ALTER DATABASE` command syntax

15. On the primary database, switch the archived redo log files using the following command:

```
ALTER SYSTEM ARCHIVE LOG CURRENT;
```

16. (For Active Data Guard only) Perform the following steps to recover redo data and open the physical standby database in read-only mode:

```
ALTER DATABASE RECOVER MANAGED STANDBY DATABASE UNTIL CONSISTENT;
ALTER DATABASE OPEN READ ONLY;
```

17. Start the managed recovery processes on the physical standby database.

The following command starts the managed recovery process:

```
ALTER DATABASE RECOVER MANAGED STANDBY DATABASE DISCONNECT FROM SESSION;
```

When using Data Guard Broker, use the following command to start the managed recovery process:

```
DGMGRL> edit database standby_db set state='APPLY-ON';
```

Performing RMAN Tablespace Point-in-Time Recovery (TSPITR)

This chapter explains how to perform RMAN tablespace point-in-time recovery. This chapter contains the following sections:

- [Overview of RMAN TSPITR](#) (page 21-1)
- [TSPITR Restrictions, Special Cases, and Limitations](#) (page 21-5)
- [Planning and Preparing for TSPITR](#) (page 21-6)
- Running RMAN TSPITR:
 - [Performing Fully Automated RMAN TSPITR](#) (page 21-9)
 - [Overriding Defaults for RMAN TSPITR with an RMAN-Managed Auxiliary Database](#) (page 21-11)
 - [Performing RMAN TSPITR Using Your Own Auxiliary Database](#) (page 21-21)
- [Troubleshooting RMAN TSPITR](#) (page 21-27)

21.1 Overview of RMAN TSPITR

To use RMAN [tablespace point-in-time recovery \(TSPITR\)](#) effectively, it is helpful to understand what types of problems it can resolve, its components, what RMAN does during TSPITR, and the various limitations and restrictions on when and how it can be run. This section explains the basic concepts, preparatory tasks, and modes of running RMAN TSPITR.

To perform TSPITR for CDBs and PDBs, you must connect to the root as a user with the `SYSDBA` or `SYSDBA` privilege. To perform TSPITR of one or more PDBs, you must have a backup of the root and the CDB seed of the CDB that contains the PDBs.

21.1.1 Purpose of RMAN TSPITR

Recovery Manager (RMAN) TSPITR enables quick recovery of one or more tablespaces in a database to an earlier time without affecting the rest of the tablespaces and objects in the database.

RMAN TSPITR is most useful for the following situations:

- To recover a logical database to a point different from the rest of the physical database, when multiple logical databases exist in separate tablespaces of one physical database. For example, you maintain logical databases in the `orders`

and `personnel` tablespaces. An incorrect batch job or data manipulation language (DML) statement corrupts the data in only one tablespace.

- To recover data lost after data definition language (DDL) operations that change the structure of tables. You cannot use Flashback Table to rewind a table to before the point of a structural change such as a truncate table operation.
- To recover a table after it has been dropped with the `PURGE` option.
- To recover from the logical corruption of a table.
- To recover dropped tablespaces. In fact, RMAN can perform TSPITR on dropped tablespaces even when a recovery catalog is not used.

You can also use Flashback Database to rewind data, but you must rewind the entire database rather than just a subset. Also, unlike TSPITR, the Flashback Database feature necessitates the overhead of maintaining flashback logs. The point in time to which you can flash back the database is more limited than the TSPITR window, which extends back to your earliest recoverable backup.

21.1.2 Basic Concepts of RMAN TSPITR

The following sections explain RMAN TSPITR fundamentals:

- [Common Terms for RMAN TSPITR](#) (page 21-2)
- [Modes of RMAN TSPITR](#) (page 21-3)
- [How RMAN TSPITR Works With an RMAN-Managed Auxiliary Database](#) (page 21-4)

21.1.2.1 Common Terms for RMAN TSPITR

[Table 21-1](#) (page 21-2) defines some common entities that are used by RMAN TSPITR.

Table 21-1 RMAN TSPITR Entities

Name	Explanation
Target instance	Contains the tablespace to be recovered to the target time
Target time	Point in time or SCN of the tablespace after TSPITR completes
Auxiliary database	A database used in the recovery process to perform the work of recovery. The auxiliary database has other files associated with it. See auxiliary set for a complete list.
Auxiliary destination	An optional disk location that RMAN uses to temporarily store the auxiliary set files. The auxiliary destination is used only with an RMAN-managed auxiliary database. Specifying an auxiliary destination with a user-managed auxiliary database results in an error. All references to auxiliary destination in this chapter assume use of an RMAN-managed auxiliary database.
Recovery set	Data files in the tablespaces that you intend to recover

Table 21-1 (Cont.) RMAN TSPITR Entities

Name	Explanation
Auxiliary set	<p>Data files required for TSPITR that are not part of the recovery set. The auxiliary set typically includes:</p> <ul style="list-style-type: none"> • The SYSTEM and SYSAUX tablespaces. • Data files containing rollback or undo segments from the target database instance. • Temporary tablespaces. • Control file from source database. • Archived redo logs that must be restored to recover the auxiliary database to specified point in time. • Online redo logs of the auxiliary database. These logs are different from the online redo logs of the source database. They are created when the auxiliary database is opened with the RESETLOGS option. <p>The auxiliary set does not include the parameter file, password file, or associated network files.</p>

21.1.2.2 Modes of RMAN TSPITR

You start RMAN TSPITR with the `RMAN RECOVER TABLESPACE` command. You have several options for running RMAN TSPITR. The difference between the various modes of operation corresponds to how much automation versus customization you require in your environment. There are three ways to run the utility:

- Fully Automated (the default)

In this mode, RMAN manages the entire TSPITR process including the auxiliary database. You specify the tablespaces of the recovery set, an auxiliary destination, the target time, and you allow RMAN to manage all other aspects of TSPITR.

The default mode is recommended unless you specifically need more control over the location of recovery set files after TSPITR, auxiliary set files during TSPITR, channel settings and parameters or some other aspect of your auxiliary database. For more information, see "[Performing Fully Automated RMAN TSPITR](#) (page 21-9)".

- Automated: RMAN-Managed Auxiliary Database with User Settings

You can override some defaults of RMAN TSPITR while still using an RMAN-managed auxiliary database and destination. This variation of the default mode enables you to benefit from some built-in management that RMAN TSPITR provides while being able to specify:

- Location of auxiliary set or recovery set files
- Initialization parameters

For more information, see "[Overriding Defaults for RMAN TSPITR with an RMAN-Managed Auxiliary Database](#) (page 21-11)".

- Non-Automated: TSPITR and User-Managed Auxiliary Database

This mode of RMAN TSPITR requires you to set up and manage all aspects of the auxiliary database and some aspects of the TSPITR process. This mode may be

appropriate if, for example, you must allocate a different number of channels or change the channel parameters for your user-managed auxiliary database.

For more information, see "[Performing RMAN TSPITR Using Your Own Auxiliary Database](#) (page 21-21)".

21.1.2.3 How RMAN TSPITR Works With an RMAN-Managed Auxiliary Database

Having selected tablespaces from the recovery set, an auxiliary destination and a target time, you are now ready to perform Fully Automated RMAN TSPITR (default). The automated mode of RMAN TSPITR shares many of these high-level processing steps.

RMAN TSPITR automatically performs the following actions:

1. If the tablespaces in the recovery set have not been dropped, checks to see if they are self-contained by executing the `DBMS_TTS.TRANSPORT_SET_CHECK` for the recovery set tablespaces and then checking that the view `TRANSPORT_SET_VIOLATIONS` is empty. If the query returns rows, RMAN stops TSPITR processing. You must resolve any tablespace containment violations before TSPITR can proceed. [Example 21-1](#) (page 21-8) shows you how to set up and run the query before invoking RMAN TSPITR.
2. Checks to see if a connection to a user-managed auxiliary database was provided. If it is, then RMAN TSPITR uses it. If not, RMAN TSPITR creates the auxiliary database, starts it, and connects to it.
3. Takes the tablespaces to be recovered offline in the target database, if the tablespaces in the recovery set have not been dropped.
4. Restores a backup control file from a point in time before the target time to the auxiliary database.
5. Restores the data files from the recovery set and the auxiliary set to the auxiliary database.

Files are restored either in the:

- Locations that you specify for each file
 - Original location of the file (for recovery set data files)
 - Auxiliary destination (if you used the `AUXILIARY DESTINATION` argument of `RECOVER TABLESPACE` and an RMAN-managed auxiliary database)
6. Recovers the restored data files in the auxiliary database to the specified time.
 7. Opens the auxiliary database with the `RESETLOGS` option.
 8. Makes the recovery set tablespaces read-only in the auxiliary database.
 9. Exports the recovery set tablespaces from the auxiliary database using the Data Pump utility to produce a transportable tablespace dump file.
 10. Shuts down the auxiliary database.
 11. Drops the recovery set tablespaces from the target.
 12. Data Pump utility reads the transportable tablespace dump file and plugs the recovery set tablespaces into the target.

13. Makes the tablespaces that were put in the target database read/write and immediately takes them offline.
14. Deletes all auxiliary set files.

At this point, RMAN TSPITR has finished. The recovery set data files are returned to their contents at the specified point in time, and belong to the target database.

The recovery set tablespaces are left offline for you to back up and then bring back online. These last steps follow Oracle's recommendation and best practice of backing up recovered tablespaces as soon as TSPITR completes.

21.2 TSPITR Restrictions, Special Cases, and Limitations

Some database problems cannot be resolved with TSPITR. The following list explains when you *cannot* perform TSPITR:

- If there are no archived redo logs or if the database runs in NOARCHIVELOG mode.
- If TSPITR is used to recover a renamed tablespace to a point in time before it was renamed, you must use the previous name of the tablespace to perform the recovery operation.

In this case when TSPITR completes, the target database contains two copies of the same tablespace, the original tablespace with the new name and the TSPITR tablespace with the old name. If this is not your goal, then you can drop the new tablespace with the new name.

- If constraints for the tables in tablespace `tbs1` are contained in tablespace `tbs2`, then you cannot recover `tbs1` without also recovering `tbs2`.
- If a table and its indexes are stored in different tablespaces, then the indexes must be dropped before performing TSPITR.
- You cannot use TSPITR to recover the current default tablespace.
- You cannot use TSPITR to recover tablespaces containing any of the following objects:
 - Objects with underlying objects (such as materialized views) or contained objects (such as partitioned tables) unless all of the underlying or contained objects are in the recovery set. Additionally, if the partitions of a partitioned table are stored in different tablespaces, then you must either drop the table before performing TSPITR or move all the partitions to the same tablespace before performing TSPITR.
 - Undo or rollback segments
 - Oracle8-compatible advanced queues with multiple recipients
 - Objects owned by the user `SYS`. Examples of these types of objects are: PL/SQL, Java classes, callout programs, views, synonyms, users, privileges, dimensions, directories, and sequences.

21.2.1 Limitations of TSPITR

After TSPITR completes, RMAN recovers the data files in the recovery set to the target time. Note the following special cases:

- TSPITR does not recover query optimizer statistics for recovered objects. You must gather new statistics after TSPITR completes.
- If you run TSPITR on a tablespace and bring the tablespace online at time *t*, then backups of the tablespace created before time *t* are no longer usable for recovery with a current control file. You cannot use the current control file to recover the database to any time less than or equal to *t*.
- If one or more data files in the recovery set have Oracle Managed File (OMF) names and the compatibility in the target database is set to version 10.1 or earlier, RMAN cannot reuse the data file. This restriction is true even if no SET NEWNAME command is provided for the data file. A new OMF name is created for the recovery set data file. This action temporarily doubles the space requirements for the data file. This is because DB_CREATE_FILE_DEST has two copies of the data file (the original data file and the one used by TSPITR) until the tablespace is dropped in the target and the original data file is deleted.

RMAN uses the transportable tablespaces functionality to perform TSPITR. Therefore, any limitations on transportable tablespaces are also applicable to TSPITR.

See Also:

Oracle Database Administrator's Guide for information about limitations on transportable tablespaces

21.2.2 About Special Considerations When Not Using a Recovery Catalog

You must be aware of following precautions:

- Because RMAN has no historical record of the undo in the control file, RMAN assumes that the current set of tablespaces with rollback or undo segments were the same set present at the time when recovery was performed. If the tablespace set has changed since that time, then the current rollback or undo segments were the same segments present at the time to which recovery is performed. If the undo segments have changed since that time, then you can use `UNDO TABLESPACE` to indicate the correct set of tablespaces with undo at the point in time where the tablespaces are being recovered.
- TSPITR to a time that is too old may not succeed if Oracle Database has reused the control file records for needed backups. (In planning your database, set the `CONTROL_FILE_RECORD_KEEP_TIME` initialization parameter to a value large enough to ensure that control file records needed for TSPITR are kept.)
- To rerun TSPITR when you are not using a recovery catalog, you must first drop the tablespace to be used by TSPITR from the target database.

21.3 Planning and Preparing for TSPITR

Read and understand the considerations described in "[TSPITR Restrictions, Special Cases, and Limitations](#) (page 21-5)". You must complete the following steps when preparing for TSPITR:

To prepare for TSPITR:

1. Select the target time until which the tablespace must be recovered as described in "[Selecting the Right Target Time for TSPITR](#) (page 21-7)".

2. Determine the recovery set as described in "[Determining the Recovery Set](#) (page 21-7)".
3. Identify and preserve objects that will be lost after the TSPITR operation completes as described in "[Identifying and Preserving Objects That Are Lost After TSPITR](#) (page 21-8)".

21.3.1 Selecting the Right Target Time for TSPITR

It is extremely important that you choose the right target time or SCN for your TSPITR.

Note that after you bring a tablespace online after TSPITR, you cannot use any backup from a time earlier than the moment you brought the tablespace online.

If you have a recovery catalog, then you can perform repeated TSPITR operations to different target times because the catalog contains tablespace history information. If RMAN uses only a control file, however, repeated TSPITR is only possible after dropping the tablespace because the control file does not have the tablespace history. In this case, RMAN only knows about the current set of tablespaces. The tablespace on which TSPITR was performed has a creation time equal to the time it was brought online.

To identify a target time for TSPITR, investigate past states of your data and find the point in time when unwanted changes occurred by using one of the following techniques:

- Flashback Query
- Oracle Transaction Query
- Flashback Version Query

See Also:

- "[TSPITR Restrictions, Special Cases, and Limitations](#) (page 21-5)"
 - *Oracle Database Development Guide* for more information on Flashback Query, Flashback Transaction Query, and Flashback Version Query
-
-

21.3.2 Determining the Recovery Set

Initially, your recovery set includes the data files for the tablespaces that you intend to recover. However, if objects in the tablespaces that you need have relationships (such as constraints) to objects in other tablespaces, then you must account for these relationships before you can perform TSPITR as described in [Identify and Resolve Dependencies on the Primary Database](#) (page 21-8)

You have the following choices when faced with such a relationship:

- Add the tablespace including the related objects to your recovery set
- Remove the relationship
- Suspend the relationship for the duration of TSPITR

21.3.2.1 Identify and Resolve Dependencies on the Primary Database

RMAN TSPITR requires that the tablespace be self-contained and that no SYS -owned objects reside in the tablespace. You can use the `DBMS_TTS.TRANSPORT_SET_CHECK` procedure to locate objects outside the tablespace and identify relationships between objects that span the recovery set boundaries. If the `TRANSPORT_SET_VIOLATIONS` view returns rows, you must investigate and correct the problem according to the choices mentioned earlier in this step.

Note:

If one or more of the tablespaces in the recovery set have been dropped, RMAN TSPITR cannot run the procedure `DBMS_TTS.TRANSPORT_SET_CHECK`. In this case, `DBMS_TTS.TRANSPORT_SET_CHECK` is run when the Data Pump export of the auxiliary database occurs. Just like RMAN TSPITR, if the export operation encounters any tablespaces that are not self-contained, it fails.

Record all actions performed during this step so that you can re-create any suspended or removed relationships after completing TSPITR. Proceed with TSPITR *only* when the `TRANSPORT_SET_VIOLATIONS` view is empty for the tablespaces in the recovery set.

The query in [Example 21-1](#) (page 21-8) illustrates how to use the `DBMS_TTS.TRANSPORT_SET_CHECK` procedure for an initial recovery set consisting of tablespaces `tools` and `users`. It queries the transportable tablespace violations table to manage any dependencies. No rows are returned from this query when all dependencies are managed.

Example 21-1 Querying `DBMS_TTS.TRANSPORT_SET_CHECK` for a Subset of Tablespaces

```
BEGIN
  DBMS_TTS.TRANSPORT_SET_CHECK('USERS,TOOLS', TRUE,TRUE);
END;
/
SELECT * FROM TRANSPORT_SET_VIOLATIONS;
```

See Also:

Oracle Database PL/SQL Packages and Types Reference for more information about the `DBMS_TTS.TRANSPORT_SET_CHECK` procedure and corresponding view

21.3.3 Identifying and Preserving Objects That Are Lost After TSPITR

When you perform RMAN TSPITR on a tablespace, objects created after the target recovery time are lost. You can preserve such objects after they are identified by exporting them before TSPITR with the Data Pump Export utility and reimporting them afterward with Data Pump Import.

To determine which objects are lost in TSPITR, query the `TS_PITR_OBJECTS_TO_BE_DROPPED` view on the primary database. [Table 21-2](#) (page 21-9) describes the contents of the view.

Table 21-2 TS_PITR_OBJECTS_TO_BE_DROPPED View

Column Name	Meaning
OWNER	Owner of the object to be dropped
NAME	The name of the object that is lost by undergoing TSPITR
CREATION_TIME	Creation time stamp for the object
TABLESPACE_NAME	Name of the tablespace containing the object

Filter the view for objects whose `CREATION_TIME` is after the target time for TSPITR. For example, with a recovery set consisting of `users` and `tools`, and a recovery point in time of November 2, 2013, 7:03:11 am, issue the statement shown in [Example 21-2](#) (page 21-9).

Example 21-2 Querying TS_PITR_OBJECTS_TO_BE_DROPPED

```
SELECT OWNER, NAME, TABLESPACE_NAME,
       TO_CHAR(CREATION_TIME, 'YYYY-MM-DD:HH24:MI:SS')
FROM TS_PITR_OBJECTS_TO_BE_DROPPED
WHERE TABLESPACE_NAME IN ('USERS', 'TOOLS')
AND CREATION_TIME > TO_DATE('02-NOV-13:07:03:11', 'YY-MON-DD:HH24:MI:SS')
ORDER BY TABLESPACE_NAME, CREATION_TIME;
```

The `TO_CHAR` and `TO_DATE` functions are used to avoid issues with different national date formats. Of course, you can use local date formats in your own work.

Alternatively, if you have the SCN of the tablespaces, you can use conversion functions to determine the time stamp associated with the SCN and the objects that are dropped. For example, if the SCN to recover tablespaces `USERS` and `TOOLS` is 1645870, use the statement in [Example 21-3](#) (page 21-9) to determine the objects that are dropped.

Example 21-3 Using SCN and TS_PITR_OBJECTS_TO_BE_DROPPED

```
SELECT OWNER, NAME, TABLESPACE_NAME,
       TO_CHAR(CREATION_TIME, 'YYYY-MM-DD:HH24:MI:SS')
FROM TS_PITR_OBJECTS_TO_BE_DROPPED
WHERE TABLESPACE_NAME IN ('USERS', 'TOOLS')
AND CREATION_TIME > TO_DATE(TO_CHAR(SCN_TO_TIMESTAMP(1645870),
'MM/DD/YYYY HH24:MI:SS'),
'MM/DD/YYYY HH24:MI:SS')
ORDER BY TABLESPACE_NAME, CREATION_TIME;
```

See Also:

Oracle Database Reference for more information about the `TS_PITR_OBJECTS_TO_BE_DROPPED` view

21.4 Performing Fully Automated RMAN TSPITR

In the default mode, RMAN bases as much of the configuration for TSPITR as possible on the target database. During TSPITR, the recovery set data files are written in their current locations on the target database (For OMF files, see "[Limitations of TSPITR](#)" (page 21-5)). The same channel configurations for the target database are used on the

auxiliary database when restoring files from backup. Auxiliary set data files and other auxiliary database files, however, are stored in the auxiliary destination.

Use the `AUXILIARY DESTINATION` parameter to set a location for RMAN to use for the auxiliary set data files. The auxiliary destination must be a location on disk with enough space to hold auxiliary set data files. Even if you use other techniques to rename some or all of the auxiliary set data files, specifying an `AUXILIARY DESTINATION` parameter provides a default location for auxiliary set data files for which names are not specified. TSPITR does not fail if you inadvertently do not provide names for all auxiliary set data files.

To perform fully automated RMAN TSPITR, the user performing TSPITR must be able to connect with the `SYSDBA` or `SYSPRIV` privilege using operating system authentication.

To perform fully automated RMAN TSPITR:

1. Review the information in "[TSPITR Restrictions, Special Cases, and Limitations](#) (page 21-5)".
2. Perform the tasks in "[Planning and Preparing for TSPITR](#) (page 21-6)".
3. Start an RMAN session on the target database and, if applicable, connect to a recovery catalog.

See Also:

["Making Database Connections with RMAN](#) (page 4-2)"

Note:

Do not connect to an auxiliary database when starting the RMAN client for automated TSPITR. If RMAN is connected to an auxiliary database when you run `RECOVER TABLESPACE`, then RMAN assumes that you are managing your own auxiliary database, as described in "[Performing RMAN TSPITR Using Your Own Auxiliary Database](#) (page 21-21)", and tries to use the connected auxiliary for TSPITR.

4. Configure any channels required for TSPITR on the target instance.

The auxiliary database uses the same channel configuration as the target instance when performing TSPITR.

5. Run the `RECOVER TABLESPACE` command, specifying both the `UNTIL` clause and the `AUXILIARY DESTINATION` parameter.

This example returns the `USERS` and `TOOLS` tablespaces to the end of log sequence number 1299, and stores the auxiliary set files in the `/disk1/auxdest` directory.

```
RECOVER TABLESPACE users, tools
  UNTIL LOGSEQ 1300 THREAD 1
  AUXILIARY DESTINATION '/disk1/auxdest';
```

6. View the results of the `RECOVER` command to decide which step to take:
 - If no error occurs during TSPITR, then proceed to Step 7 (page 21-11).

The tablespaces are taken offline by RMAN, restored from backup and recovered to the desired point in time on the auxiliary database, and then reimported to the target database. The tablespaces are left offline. All auxiliary set data files and other auxiliary database files are cleaned up from the auxiliary destination.

- If an error occurs during TSPITR, then proceed to "[Troubleshooting RMAN TSPITR](#) (page 21-27)".
7. If TSPITR completes successfully, then back up the recovered tablespaces before bringing them online.

For example, enter the following command:

```
BACKUP TABLESPACE users, tools;
```

After you perform TSPITR on a tablespace, you can no longer use previous backups of that tablespace after TSPITR successfully completes. If you use the recovered tablespaces without taking a backup, then you run your database without a usable backup of these tablespaces.

8. Bring the tablespaces back online.

For example, enter the following command:

```
RMAN> ALTER TABLESPACE users, tools ONLINE;
```

Your recovered tablespaces are now ready for use.

21.5 Overriding Defaults for RMAN TSPITR with an RMAN-Managed Auxiliary Database

You can customize the following aspects of RMAN TSPITR while still mostly following the procedure described in "[Performing Fully Automated RMAN TSPITR](#) (page 21-9)":

- Rename or relocate your recovery set data files so that the data files making up the recovered tablespaces are not stored in the original locations after TSPITR. This may be necessary if the disk that originally contained the tablespace is not usable.

This task is described in "[Renaming TSPITR Recovery Set Data Files with SET NEWNAME](#) (page 21-12)".

- Specify a location other than the auxiliary destination for some or all auxiliary set data files. You might choose this option if no single location on disk has enough space for all auxiliary set files.

This task is described in "[Naming TSPITR Auxiliary Set Data Files](#) (page 21-12)".

- Rename files in an Oracle Managed Files format.

This task is described in "[Considerations When Renaming OMF Auxiliary Set Files in TSPITR](#) (page 21-13)".

- Set up image copy backups of your auxiliary set data files in advance to avoid having to restore data files during TSPITR.

This task is described in "[Using Image Copies for Faster RMAN TSPITR Performance](#) (page 21-16)".

- Customize initialization parameters for your RMAN-managed auxiliary database. This task is described in "[Customizing Initialization Parameters for the Automatic Auxiliary Database in TSPITR](#) (page 21-18)".

21.5.1 Renaming TSPITR Recovery Set Data Files with SET NEWNAME

You may not want the recovery set data files restored and recovered in their original locations. The `SET NEWNAME` command enables you to specify a new destination. When you specify a new destination for the recovery set, RMAN does not remove the original data files of the tablespaces.

To specify new recovery set file names, create a `RUN` block and use `SET NEWNAME` commands within it. Be sure to assign names that do not conflict with each other or with the names of your current data files. [Example 21-4](#) (page 21-12) illustrates the basic technique.

Example 21-4 Renaming Recovery Set Files

```

RUN
{
  .
  .
  .
  SET NEWNAME FOR DATAFILE 'ORACLE_HOME/oradata/trgt/users01.dbf'
    TO '/newFs/users01.dbf';
  ...other SET NEWNAME commands...
  RECOVER TABLESPACE users, tools UNTIL SEQUENCE 1300 THREAD 1;
}

```

In this example, RMAN takes the following actions:

- Restores each specified data file to the new location during TSPITR.
- Uses the image copy if one exists at the specified location and its checkpoint is before the specified point in time. If this criteria is not met, then RMAN overwrites the image copy.
- Plugs the newly recovered data file into the target control file.

RMAN does not detect conflicts between names set with `SET NEWNAME` and current data file names on the target database until the actual recovery. If RMAN detects a conflict, then TSPITR fails and RMAN reports an error. The valid data file is not overwritten.

21.5.2 Naming TSPITR Auxiliary Set Data Files

Unlike recovery set data files, which are usually stored in their original locations, auxiliary set data files must not overwrite the corresponding original files in the target database. If you do not specify an auxiliary set file location that is different from its original location, then TSPITR fails. The failure occurs when RMAN attempts to overwrite the corresponding file in the original database and discovers the file in use.

The simplest way to provide locations for auxiliary set data files is to specify an auxiliary destination for TSPITR. However, RMAN supports the following alternatives for controlling the location of auxiliary set data files, which are listed in order of precedence shown in [Table 21-3](#) (page 21-13).

Table 21-3 Order of Precedence for Naming Files

Order	Technique	Section
1	SET NEWNAME	"Using SET NEWNAME to Name Auxiliary Set Data Files During TSPITR (page 21-15)"
2	CONFIGURE AUXNAME	"Using SET NEWNAME and CONFIGURE AUXNAME with Auxiliary Set Image Copies (page 21-17)"
3	DB_FILE_NAME_CONVERT	"Using DB_FILE_NAME_CONVERT to Name Auxiliary Set Data Files During TSPITR (page 21-15)". If the target database uses OMF names for auxiliary set, then you cannot use DB_FILE_NAME_CONVERT. See "Considerations When Renaming OMF Auxiliary Set Files in TSPITR (page 21-13)".
4	AUXILIARY DESTINATION argument to RECOVER TABLESPACE when using an RMAN-managed auxiliary database	

Settings higher on the list override settings lower on the list in situations where both have been applied. For example, you might run `RECOVER TABLESPACE . . . AUXILIARY DESTINATION` on a target database when some auxiliary set data files have auxiliary names configured with `CONFIGURE AUXNAME`.

Even if you intend to use either of the preceding techniques to provide locations for specific files, Oracle recommends that you provide an `AUXILIARY DESTINATION` argument to `RECOVER TABLESPACE` when using an RMAN-managed auxiliary database. If you overlook renaming some auxiliary set data files, then TSPITR still succeeds. Any files not otherwise renamed are placed in the auxiliary destination.

Note:

You can view any current `CONFIGURE AUXNAME` settings by running the `SHOW AUXNAME` command, which is described in *Oracle Database Backup and Recovery Reference*.

21.5.2.1 Considerations When Renaming OMF Auxiliary Set Files in TSPITR

Auxiliary set data files can have Oracle Managed Files (OMF) in the target and can use Automatic Storage Management (ASM) or non-ASM storage. TSPITR performs name conversion differently when the `DB_FILE_NAME_CONVERT` initialization parameter is set and the OMF files are in ASM or non-ASM storage.

21.5.2.1.1 Using ASM Storage

For Oracle Managed Files (OMF) that use ASM storage, the database converts only disk group names as in: `+DISK1` to `+DISK2`.

You can use `DB_FILE_NAME_CONVERT` and `LOG_FILE_NAME_CONVERT` initialization parameters for the auxiliary database to specify the conversion of the disk group. RMAN uses the pattern to convert the ASM disk group name and generates a valid OMF file name in the converted disk group. The following command demonstrates this point:

```
LOG_FILE_NAME_CONVERT='+onlinelogs','+tmpasm'
```

If the `DB_FILE_NAME_CONVERT` and `LOG_FILE_NAME_CONVERT` parameters change a substring other than the disk group name, the conversion is ignored and the resulting disk group name is used, for example:

```
DB_FILE_NAME_CONVERT='+DATAFILE/prod','+DATAFILE/tspitr'
```

The preceding command results in an invalid ASM OMF file name and the change is ignored. Instead, the files are created in disk group name `+DATAFILE` and the following message is issued:

```
WARNING: DB_FILE_NAME_CONVERT resulted in invalid ASM names; names changed to disk group only
```

If auxiliary set data files are stored in ASM disk groups, then you can use the `SET NEWNAME` command to redirect individual files to a specific disk group accessible from the auxiliary database (and allow the database to generate the file name within the disk group). [Example 21-5](#) (page 21-14) shows how to do this.

Example 21-5 Redirecting ASM files

```
RUN
{
  SET NEWNAME FOR DATAFILE 1 TO "+DISK2";
  SET NEWNAME FOR DATAFILE 2 TO "+DISK3";
  RECOVER TABLESPACE users, tools
  UNTIL LOGSEQ 1300 THREAD 1
  AUXILIARY DESTINATION '/disk1/auxdest';
}
```

21.5.2.1.2 Using Non-ASM Storage

The initialization parameters `DB_FILE_NAME_CONVERT` and `LOG_FILE_NAME_CONVERT` cannot be used to rename OMF (non-ASM) file names for the auxiliary database because this method generates invalid OMF file names. If you must control the generation of new OMF file names that do not use ASM storage, you must rename them using one of the following alternate techniques. The various naming options are listed in order from most recommended to least recommended.

1. Use an auxiliary destination, as described in "[Performing Fully Automated RMAN TSPITR](#) (page 21-9)".
2. Specify locations for new OMF files with one or more of the OMF initialization parameters for the auxiliary database so that all of the necessary OMF files are handled:
 - `DB_CREATE_FILE_DEST` for the auxiliary set data files
 - `DB_CREATE_ONLINE_LOG_DEST_n` with `DB_CREATE_FILE_DEST` for the online redo logs of the auxiliary database if the online logs are not created in the `DB_CREATE_FILE_DEST`

21.5.2.2 Using SET NEWNAME to Name Auxiliary Set Data Files During TSPITR

To specify a new name for an auxiliary set data file, you can enclose `RECOVER TABLESPACE` in a `RUN` command and use a `SET NEWNAME` command within the `RUN` block to rename the file. [Example 21-6](#) (page 21-15) illustrates the basic technique.

Example 21-6 Renaming Auxiliary Set Oracle Managed Files (OMF) in TSPITR

```
RUN
{
  SET NEWNAME FOR DATAFILE '?/oradata/prod/system01.dbf'
    TO '/disk1/auxdest/system01.dbf';
  SET NEWNAME FOR DATAFILE '?/oradata/prod/sysaux01.dbf'
    TO '/disk1/auxdest/sysaux01.dbf';
  SET NEWNAME FOR DATAFILE '?/oradata/prod/undotbs01.dbf'
    TO '/disk1/auxdest/undotbs01.dbf';
  RECOVER TABLESPACE users, tools
    UNTIL LOGSEQ 1300 THREAD 1
    AUXILIARY DESTINATION '/disk1/auxdest';
}
```

The result depends on whether `/disk1/auxdest/system01.dbf` exists when `RECOVER TABLESPACE` is executed. If `?/oradata/system01.dbf` exists at the specified location and was created at an SCN before the `UNTIL` time for TSPITR, then the `DATAFILECOPY` is used and the restore operation is not necessary. For more information, see "[Using SET NEWNAME and CONFIGURE AUXNAME with Auxiliary Set Image Copies](#) (page 21-17)". Otherwise, RMAN restores the auxiliary set data file to the `NEWNAME` instead of the default location. If your intention is to control where the auxiliary set data files are stored, then ensure that no file is stored at the location specified by `SET NEWNAME` before performing TSPITR.

21.5.2.3 Using DB_FILE_NAME_CONVERT to Name Auxiliary Set Data Files During TSPITR

Assume that you do not want to use an auxiliary destination for all of your auxiliary set data files, but you also do not want to name every file individually. In this case, you can include a `DB_FILE_NAME_CONVERT` initialization parameter in the initialization parameter file used by the auxiliary database. You can use this technique only in the following circumstances:

One of the following situations exists:

- You create your own initialization parameter file for an automatically managed auxiliary database, as described in "[Customizing Initialization Parameters for the Automatic Auxiliary Database in TSPITR](#) (page 21-18)"
- You create your own auxiliary database, as described in "[Performing RMAN TSPITR Using Your Own Auxiliary Database](#) (page 21-21)"

The `DB_FILE_NAME_CONVERT` initialization parameter in the auxiliary database specifies how to derive names for files in the auxiliary database from the original names of the corresponding files in the target database instance. The parameter consists of a list of pairs of strings. For any file name that contains the first string of a pair as a substring, the name of the corresponding file in the auxiliary database is generated by substituting the second string of the pair into the original file name.

For example, assume that the target instance contains the following files:

- `?/oradata/trgt/system01.dbf` of the `SYSTEM` tablespace

- `?/oradata/trgt/sysaux01.dbf` of the SYSAUX tablespace
- `?/oradata/trgt/undotbs01.dbf` of the undotbs tablespace

To place the corresponding files of the auxiliary database in `/bigtmp`, you add the following line to the auxiliary database parameter file:

```
DB_FILE_NAME_CONVERT=('?/oradata/trgt', '/bigtmp')
```

New file names for the corresponding auxiliary database files are `/bigtmp/trgt/system01.dbf`, `/bigtmp/trgt/sysaux01.dbf`, and `/bigtmp/trgt/undotbs01.dbf`.

The most important point to remember is that `DB_FILE_NAME_CONVERT` *must* be present in the auxiliary database parameter file. If the auxiliary database was manually created, then add `DB_FILE_NAME_CONVERT` to the auxiliary database parameter file.

You can still rename individual auxiliary set data files with the `SET NEWNAME` or `CONFIGURE AUXNAME` command. Also, files that do not match the patterns provided in `DB_FILE_NAME_CONVERT` are not renamed. When using RMAN-managed auxiliary database, you can use the `AUXILIARY DESTINATION` parameter of `RECOVER TABLESPACE` command to ensure that all auxiliary set data files are sent to some destination. If the renaming methods do not provide a new name for a file at the auxiliary database, then TSPITR fails.

21.5.2.3.1 Renaming Temp Files During TSPITR

Temp files are considered part of the auxiliary set for your database. When the auxiliary database is instantiated, RMAN re-creates the temporary tablespaces of the target database and generates their names with the regular rules for the auxiliary data file names.

To rename temp files, you can use one of the following:

- `SET NEWNAME FOR TEMPFILE` command
- `DB_FILE_NAME_CONVERT` initialization parameter of the auxiliary database. See the previous example. If the temporary files have non-ASM Oracle Managed File names, you cannot use this parameter option. See "[Considerations When Renaming OMF Auxiliary Set Files in TSPITR](#) (page 21-13)".
- `AUXILIARY DESTINATION` clause of the `RECOVER` command when using an RMAN-managed auxiliary database

21.5.3 Using Image Copies for Faster RMAN TSPITR Performance

You can enhance TSPITR performance by redirecting RMAN to use existing image copies of the recovery set and auxiliary set data files. In this case, RMAN does not need to restore the data files from backup.

In general, if a suitable image copy is available in the specified location, then RMAN uses the image copy to perform TSPITR, and the data file copy is uncataloged from the target control file.

You can use the following techniques to tell RMAN about the possible existence of an image copy of a data file:

- Use the `CONFIGURE AUXNAME` command with image copies of auxiliary set data files

- Use the `SET NEWNAME` command with image copies of recovery set data files or auxiliary set data files

The following topics describe how to use these techniques:

- [Using SET NEWNAME with Recovery Set Image Copies](#) (page 21-17)
- [Using SET NEWNAME and CONFIGURE AUXNAME with Auxiliary Set Image Copies](#) (page 21-17)

21.5.3.1 Using SET NEWNAME with Recovery Set Image Copies

During TSPITR, RMAN looks in the specified `NEWNAME` location for the data file. RMAN checks whether an image copy backup of the data file exists with a [data file checkpoint](#) SCN early enough that it can be recovered to the target time. If RMAN finds a usable image copy, then RMAN uses it in TSPITR. Otherwise, RMAN restores the data file to the `NEWNAME` location. Any file in the location specified by the `NEWNAME` is overwritten. The specified `NEWNAME` becomes the name of the data file in the target database after TSPITR completes. [Example 21-7](#) (page 21-17) illustrates this technique.

Example 21-7 Using SET NEWNAME

```
RUN
{
SET NEWNAME FOR DATAFILE 'ORACLE_HOME/oradata/trgt/users01.dbf'
  TO '/newfs/users1.dbf';
...other RMAN commands, if any...
RECOVER TABLESPACE users, tools UNTIL SEQUENCE 1300 THREAD 1;
}
```

21.5.3.2 Using SET NEWNAME and CONFIGURE AUXNAME with Auxiliary Set Image Copies

The `CONFIGURE AUXNAME` command sets a persistent alternative location for an auxiliary set data file image copy, whereas the `SET NEWNAME` command sets an alternative location for the duration of a `RUN` command.

Assume that you use `SET NEWNAME` or `CONFIGURE AUXNAME` to specify a new location for an auxiliary set data file. Also assume that there is an image copy at that location with an SCN that can be used in TSPITR. In this case, RMAN uses the image copy. If there is no usable image copy at that location, however, then RMAN restores a usable copy from backup. (If an image copy is present but the SCN is after the target time for TSPITR, then the data file is overwritten by the restored file.)

As with all auxiliary set files, the file is deleted after TSPITR. This behavior occurs regardless of whether it was an image copy created before TSPITR or restored by RMAN during TSPITR.

The primary use of `CONFIGURE AUXNAME` is to make TSPITR faster by eliminating restore times. If you anticipate performing TSPITR, then you can include in your backup routine the maintenance of a set of image copies of the auxiliary set data files, and update these periodically to the earliest point to which you expect to perform TSPITR. The recommended usage model is:

1. Configure the `AUXNAME` for the files once when setting up this strategy.
2. Perform `BACKUP AS COPY DATAFILE n FORMAT auxname` regularly to maintain the updated image copy. For better performance, use an incrementally updated backup strategy to keep the image copies up-to-date without performing full backups of the data files.

3. When TSPITR is needed, specify a target time after the last update of the image copy.

21.5.3.3 Performing TSPITR with CONFIGURE AUXNAME and Image Copies: Scenario

Assume that you have enough disk space to save image copies of your entire database for use in TSPITR. In preparation for the possibility of TSPITR, you do the following:

- Configure an `AUXNAME` for each data file in the auxiliary set by using a command of the following form:

```
CONFIGURE AUXNAME FOR DATAFILE n TO auxname_n;
```

- Take an image copy of the auxiliary set every Sunday by using a command of the following form:

```
BACKUP AS COPY DATAFILE n FORMAT auxname_n
```

If the image copies are all in the same location on disk, and if they are named similarly to the original data files, then you can avoid performing backups of every data file. Instead, you can use the `FORMAT` or `DB_FILE_NAME_CONVERT` options of the `BACKUP` command and use `BACKUP AS COPY DATABASE`. For example, if the configured auxiliary names are a translation of the location `maindisk` to `auxdisk`, then you use the following command:

```
BACKUP AS COPY  
DATABASE  
DB_FILE_NAME_CONVERT (maindisk, auxdisk);
```

Note:

Because Oracle managed file names cannot generally be translated using a simple substitution, you cannot typically use `DB_FILE_NAME_CONVERT` to generate names for image copies stored in OMF.

After these steps, you are prepared for TSPITR without restoring the auxiliary set from backup. For example, if an erroneous batch job, started on November 15, 2013, at 19:00:00, incorrectly updates the tables in the tablespace `parts`, you use the following command to perform TSPITR on tablespace `parts`:

```
RECOVER TABLESPACE parts UNTIL TIME 'November 15 2013, 19:00:00';
```

Because `AUXNAME` locations are configured and refer to data file copies from an SCN before the TSPITR target time, the auxiliary set is not restored from backup. Instead, the data file copies are used in recovery, which reduces the restore overhead.

You can also prevent the recovery set from being restored. You must take frequent image copies of the tablespaces and use `SET NEWNAME` to specify the location of these copies. This method ensures that the recovery set is not restored and the tablespace changes location after TSPITR successfully completes.

21.5.4 Customizing Initialization Parameters for the Automatic Auxiliary Database in TSPITR

The automatic auxiliary database uses a set of default initialization parameters as shown in [Table 21-4](#) (page 21-19). It also looks for additional initialization parameters to complement the default parameters in a location that is operating system-dependent. For example, in UNIX this location is: `?/rdbms/admin/`

`params_auxinst.ora`. RMAN always looks for this additional parameter file for an RMAN-automatic auxiliary database when performing TSPITR. If the file is not found, then RMAN does not generate an error. Instead, RMAN uses the default parameters in [Table 21-4](#) (page 21-19) for the RMAN-managed automatic auxiliary database.

Table 21-4 Default Initialization Parameters for the RMAN-Managed Auxiliary Database

Initialization Parameter	Value
DB_NAME	Same as DB_NAME of the source database
COMPATIBLE	Same as the COMPATIBLE setting of the target database
DB_UNIQUE_NAME	RMAN auto-generated unique value based on DB_NAME
DB_BLOCK_SIZE	Same as the DB_BLOCK_SIZE of the target database
DB_CREATE_FILE_DEST	Auxiliary destination (only if the AUXILIARY DESTINATION argument is specified when using an RMAN-managed auxiliary database). RMAN creates Oracle Managed Files for the auxiliary set files in this location.
LOG_ARCHIVE_DEST_1	Auxiliary destination (only if the AUXILIARY DESTINATION clause is specified when using an RMAN-managed auxiliary database). Archived logs needed for recovery are restored to this location.
SGA_TARGET	280M
DB_FILES	Same as DB_FILES of the target database
PROCESSES	50

Usually it is not necessary to alter or add to the values of these initialization parameters, especially if you provide an AUXILIARY DESTINATION clause to the RECOVER TABLESPACE command when using a RMAN-managed auxiliary database. If you override an initialization parameter in [Table 21-4](#) (page 21-19) with an inappropriate value, then TSPITR may fail due to problems with the auxiliary database. Nevertheless, you can add other parameters besides these basic parameters if needed. For example, you can use DB_FILE_NAME_CONVERT to specify the names of the data files in the auxiliary and recovery sets.

To override or specify parameters for the automatic auxiliary database, you can do either of the following:

- Place the initialization parameters in the operating system specific default auxiliary parameter file name. For example, in UNIX, the file name is: `~/rdbms/admin/params_auxinst.ora`.
- Perform these steps:
 1. Place the initialization parameters in a file.
 2. Specify the location of this file with the `SET AUXILIARY INSTANCE PARAMETER FILE` command before executing TSPITR.

Regardless of the method that you choose, the parameters that you specify take precedence over defaults and can override the value of an AUXILIARY DESTINATION clause.

This section contains the following topics:

- [Specifying the Auxiliary Database Archived Logs in TSPITR](#) (page 21-20)
- [Specifying the Auxiliary Database Control File Location in TSPITR](#) (page 21-20)
- [Specifying the Auxiliary Database Online Log Location in TSPITR](#) (page 21-20)

21.5.4.1 Specifying the Auxiliary Database Control File Location in TSPITR

If you use an initialization parameter file, then you can specify your own location for the control file of your auxiliary database. Set the `CONTROL_FILES` initialization parameter to specify a location for the control files.

If you do not explicitly specify a control file location, and if you use the `AUXILIARY DESTINATION` clause, then RMAN locates the control file in the auxiliary destination. If you do not use the `AUXILIARY DESTINATION` clause, then the auxiliary database control files are stored in an operating system-specific location.

No matter where you store your auxiliary database control file, it is removed at the end of the TSPITR operation. Because control files are relatively small, it is rare that RMAN encounters a problem creating an auxiliary control file. If there is not enough space to create the control file, however, then TSPITR fails.

21.5.4.2 Specifying the Auxiliary Database Archived Logs in TSPITR

To perform recovery on the auxiliary and recovery sets after restoring them at the auxiliary database, RMAN may need to restore archived logs. When an auxiliary destination is being used, the archived logs are restored to that location. In the absence of an auxiliary destination and any other initialization parameters, the archived logs are restored to an operating system specific location. For details, consult your operating system specific documentation. You can use the `LOG_ARCHIVE_DEST_1` initialization parameter to specify an alternative location where the archived logs are restored.

21.5.4.3 Specifying the Auxiliary Database Online Log Location in TSPITR

If you specify the `LOG_FILE_NAME_CONVERT` initialization parameter in your auxiliary database parameter file and the parameter successfully converts the names of the online redo logs of the target, then this parameter determines the online redo log location. The same restrictions that apply to OMF data files, apply to OMF online redo logs. For more information, see "[Considerations When Renaming OMF Auxiliary Set Files in TSPITR](#) (page 21-13)". If RMAN is managing the auxiliary database and an auxiliary destination is specified, RMAN creates the online redo log in the auxiliary destination.

Alternatively, you can use `DB_CREATE_FILE_DEST` or `DB_CREATE_FILE_DEST` and `DB_CREATE_ONLINE_LOG_1` to specify the location where the auxiliary database redo logs are created. If you choose the latter option, you must use `DB_CREATE_ONLINE_LOG_1` with `DB_CREATE_FILE_DEST`.

TSPITR fails to create the online redo logs if you do not specify a location for them by using one of the following:

- `LOG_FILE_NAME_CONVERT`
- `DB_CREATE_FILE_DEST`
- `DB_CREATE_FILE_DEST` and `DB_CREATE_ONLINE_LOG_1`

- `AUXILIARY DESTINATION`

21.6 Performing RMAN TSPITR Using Your Own Auxiliary Database

Although Oracle recommends that you let RMAN manage all aspects of the auxiliary database, there may be times when you must create and manage your own auxiliary database. If you select this mode, you are responsible for setting up, starting, stopping and cleaning up the auxiliary database used in TSPITR.

One reason that you might want to create your own instance is to exercise control of channels used in TSPITR. The automatic auxiliary database uses the configured channels of the target database as the basis for the channels to configure on the auxiliary database and to use during the restore operation. You may need different channel settings and may not want to use the `CONFIGURE` command to change the settings on the target database. In this case, you can operate your own auxiliary database. By connecting to the auxiliary database before invoking `RECOVER`, a run block can provide specific channel allocations using the `ALLOCATE AUXILIARY CHANNEL` command.

This section contains the following topics:

- [Preparing Your Own Auxiliary Database for RMAN TSPITR](#) (page 21-21)
- [Preparing RMAN Commands for TSPITR with Your Own Auxiliary Database](#) (page 21-24)
- [Executing TSPITR with Your Own Auxiliary Database](#) (page 21-25)
- [Performing TSPITR with Your Own Auxiliary Database: Scenario](#) (page 21-26)

21.6.1 Preparing Your Own Auxiliary Database for RMAN TSPITR

Creating an Oracle instance suitable for use as an auxiliary database requires that you complete all of the following steps:

- [Step 1: Create an Oracle Password File for the Auxiliary Database](#) (page 21-21)
- [Step 2: Create an Initialization Parameter File for the Auxiliary Database](#) (page 21-21)
- [Step 3: Check Oracle Net Connectivity to the Auxiliary Database](#) (page 21-24)

21.6.1.1 Step 1: Create an Oracle Password File for the Auxiliary Database

For instructions on how to create and maintain Oracle password files, refer to *Oracle Database Administrator's Guide*.

21.6.1.2 Step 2: Create an Initialization Parameter File for the Auxiliary Database

Use a text editor to create an initialization parameter file for the auxiliary database on the target database host. For this example, assume that your parameter file is placed at `/tmp/initAux.ora`. Set the parameters described in [Table 21-5](#) (page 21-22).

Note:

For TSPITR, the target and auxiliary database instances must be on the same host.

Table 21-5 Initialization Parameters in a User-Managed Auxiliary Database

Initialization Parameter	Mandatory?	Value
DB_NAME	YES	The same name as the target database
DB_UNIQUE_NAME	YES	A value different from any database in the same Oracle home. For simplicity, specify <code>_dbname</code> . For example, if the target database name is <code>trgt</code> , then specify <code>_trgt</code> .
REMOTE_LOGIN_PASSWORDFILE	YES	Set to <code>EXCLUSIVE</code> when connecting to the auxiliary database with a password file. Otherwise, set to <code>NONE</code> .
COMPATIBLE	YES	The same value as the parameter in the target database
DB_BLOCK_SIZE	YES	If this initialization parameter is set in the target database, then it must be set to the same value in the auxiliary database.
LOG_FILE_NAME_CONVERT	NO	<p>Patterns to generate file names for the online redo logs of the auxiliary database based on the online redo log names of the target database. Query <code>V\$LOGFILE.MEMBER</code> to obtain target instance online redo log file names, and ensure that the conversion pattern matches the format of the file name shown in the view.</p> <p>Note: Some platforms do not support ending patterns in a forward or backward slash (<code>\</code> or <code>/</code>).</p> <p>See Also: "Specifying the Auxiliary Database Online Log Location in TSPITR (page 21-20)" for restrictions on possible values for <code>LOG_FILE_NAME_CONVERT</code> with OMF file names and "Considerations When Renaming OMF Auxiliary Set Files in TSPITR (page 21-13)"</p>

Table 21-5 (Cont.) Initialization Parameters in a User-Managed Auxiliary Database

Initialization Parameter	Mandatory?	Value
DB_FILE_NAME_CONVERT	NO	Patterns to convert file names for the data files of the auxiliary database. You can use this parameter to generate file names for those files that you did not name with SET NEWNAME or CONFIGURE AUXNAME. Obtain the data file names by querying V\$DATAFILE.NAME, and ensure that the conversion pattern matches the format of the file name displayed in the view. Note: Some platforms do not support ending patterns in a forward or backward slash (\ or /). See Also: "Using DB_FILE_NAME_CONVERT to Name Auxiliary Set Data Files During TSPITR (page 21-15)" and "Considerations When Renaming OMF Auxiliary Set Files in TSPITR (page 21-13)" .
DB_CREATE_FILE_DEST	NO	Identifies a location for all auxiliary set files.
LOG_ARCHIVE_DEST_n	NO	Identifies where archived logs required for recover are created.
DB_CREATE_ONLINE_LOG_n	NO	With DB_CREATE_FILE_DEST identifies a different location where online redo logs are created.
CONTROL_FILES	NO	File names that do not conflict with the control file names of the target instance (or any other existing file).
SGA_TARGET	NO (Recommended)	280M
STREAMS_POOL_SIZE	NO YES	If SGA_TARGET is set If SGA_TARGET is not set

Set other parameters as needed, including the parameters to specify how much memory the auxiliary database uses.

The following example shows possible initialization parameter settings for an auxiliary database for TSPITR:

```
DB_NAME=trgt
DB_UNIQUE_NAME=_trgt
CONTROL_FILES=/tmp/control01.ctl
DB_FILE_NAME_CONVERT=(' /oracle/oradata/trgt/' ,'/tmp/')
LOG_FILE_NAME_CONVERT=(' /oracle/oradata/trgt/redo' ,'/tmp/redo')
REMOTE_LOGIN_PASSWORDFILE=exclusive
COMPATIBLE =11.0.0
DB_BLOCK_SIZE=8192
```

Note:

After setting these initialization parameters, ensure that you do not overwrite the initialization settings for the production files at the target database.

21.6.1.3 Step 3: Check Oracle Net Connectivity to the Auxiliary Database

The auxiliary database must have a valid net service name. Before proceeding, use SQL*Plus to ensure that you can establish a SYSBACKUP or SYSDBA connection to the auxiliary database.

See Also:

Oracle Database Net Services Administrator's Guide for more information about Oracle Net

21.6.2 Preparing RMAN Commands for TSPITR with Your Own Auxiliary Database

If you run your own auxiliary database, then it is possible for the sequence of commands required for TSPITR to be long. This situation can occur when you allocate a complex channel configuration for restoring from backup and you are not using `DB_CREATE_FILE_DEST` to determine file naming of auxiliary set files.

You may want to store the series of commands for TSPITR in an RMAN command file. Review the command file carefully to catch any errors. To read the command file into RMAN, use the `@` command (or the `CMDFILE` command-line argument when starting RMAN).

The following example runs the command file named `/tmp/tspitr.rman`:

```
@/tmp/tspitr.rman;
```

See Also:

["Using Command Files with RMAN \(page 4-13\)"](#)

21.6.2.1 Planning Channels for TSPITR with Your Own Auxiliary Database

When you run your own auxiliary database, the default behavior is to use the automatic channel configuration of the target database. If you decide to allocate your own channels with a different configuration (changing the number of channels or channel parameters), you can include `ALLOCATE AUXILIARY CHANNEL` commands in a `RUN` block along with the `RECOVER TABLESPACE` command for TSPITR. Plan these commands, if necessary, and add them to the sequence of commands you run for TSPITR.

See Also:

["Performing TSPITR with Your Own Auxiliary Database: Scenario \(page 21-26\)"](#) to learn how to include channel allocation in your TSPITR script

21.6.2.2 Planning Data File Names with Your Own Auxiliary Database: SET NEWNAME

You may want to use `SET NEWNAME` commands to refer to existing image copies of auxiliary set files to improve TSPITR performance, or to assign new names to the recovery set files for after TSPITR. Plan these commands, if necessary, and add them to the sequence of commands that you run for TSPITR. For more information, see "[Renaming TSPITR Recovery Set Data Files with SET NEWNAME](#) (page 21-12)".

21.6.3 Executing TSPITR with Your Own Auxiliary Database

With the preparations described in [Preparing Your Own Auxiliary Database for RMAN TSPITR](#) (page 21-21) and [Preparing RMAN Commands for TSPITR with Your Own Auxiliary Database](#) (page 21-24) complete and your TSPITR commands completely planned, you are now ready to perform TSPITR. The following steps are required:

- [Step 1: Start the Auxiliary Database in NOMOUNT Mode](#) (page 21-25)
- [Step 2: Connect the RMAN Client to Target and Auxiliary Databases](#) (page 21-25)
- [Step 3: Execute the RECOVER TABLESPACE Command](#) (page 21-26)

See Also:

[Performing TSPITR with Your Own Auxiliary Database: Scenario](#)
(page 21-26)

21.6.3.1 Step 1: Start the Auxiliary Database in NOMOUNT Mode

Before beginning RMAN TSPITR, start SQL*Plus and connect to the auxiliary database with `SYSOPER` privileges.

Start the auxiliary database in `NOMOUNT` mode, specifying a parameter file if necessary. For example, enter the following SQL*Plus command:

```
SQL> STARTUP NOMOUNT PFILE='/tmp/initAux.ora'
```

Remember that if you specify `PFILE`, then the path for the `PFILE` is a client-side path on the host from which you run SQL*Plus.

Because the auxiliary database does not yet have a control file, you can only start the instance in `NOMOUNT` mode. Do not create a control file or try to mount or open the auxiliary database for TSPITR.

21.6.3.2 Step 2: Connect the RMAN Client to Target and Auxiliary Databases

Start RMAN and connect to the target database and the manually created auxiliary database.

```
rman target dba AUXILIARY auxusr@aux
```

See Also:

["Making Database Connections with RMAN](#) (page 4-2)"

21.6.3.3 Step 3: Execute the RECOVER TABLESPACE Command

In the simplest case, execute the `RECOVER TABLESPACE . . . UNTIL` command at the RMAN prompt:

```
RECOVER TABLESPACE ts1, ts2... UNTIL TIME 'time';
```

If you want to use the `ALLOCATE AUXILIARY CHANNEL` or `SET NEWNAME` commands, then include these commands before the `RECOVER TABLESPACE` command within a `RUN` command. The following example illustrates this technique:

```
RUN
{
  ALLOCATE AUXILIARY CHANNEL c1 DEVICE TYPE DISK;
  ALLOCATE AUXILIARY CHANNEL c2 DEVICE TYPE sbt;
  # and so on...
  RECOVER TABLESPACE ts1, ts2 UNTIL TIME 'time';
}
```

21.6.4 Performing TSPITR with Your Own Auxiliary Database: Scenario

This scenario shows the execution of a `RECOVER TABLESPACE . . . UNTIL` operation. This scenario illustrates the following features of RMAN TSPITR:

- Managing your own auxiliary database
- Configuring channels for restore of backups from disk and [SBT](#) devices
- Using recoverable image copies for some auxiliary set data files using `SET NEWNAME`
- Specifying new names for recovery set data files using `SET NEWNAME`

To use TSPITR with your own auxiliary database:

1. Prepare the auxiliary database as described in "[Preparing Your Own Auxiliary Database for RMAN TSPITR](#) (page 21-21)". Specify a password for the auxiliary database in the password file, and set up the auxiliary database parameter file / `bigtmp/init_tspitr_prod.ora` with the following settings:

```
DB_NAME=PROD
DB_UNIQUE_NAME=tspitr_PROD
CONTROL_FILES=/bigtmp/tspitr_cntrl.dbf
DB_CREATE_FILE_DEST=/bigtmp
COMPATIBLE=11.0.0
BLOCK_SIZE=8192
REMOTE_LOGIN_PASSWORD=exclusive
```

2. Create service name `pitprod` for the auxiliary database, and check for connectivity.
3. Using SQL*Plus, connect to the auxiliary database with `SYSOPER` privileges. Start the instance in `NOMOUNT` mode:

```
SQL> STARTUP NOMOUNT PFILE=/bigtmp/init_tspitr_prod.ora
```

4. Start RMAN and connect to the target and auxiliary database instances.

```
rman target / auxiliary '"sbu@pitprod AS SYSBACKUP"'
```

See Also:

["Making Database Connections with RMAN \(page 4-2\)"](#)

5. Enter the following commands in a RUN block to set up and execute TSPITR:

```

RUN
{
# Specify NEWNAME for recovery set data files
SET NEWNAME FOR TABLESPACE clients
    TO '?/oradata/prod/rec/%b';

# Specify NEWNAMES for some auxiliary set
# data files that have a valid image copy to avoid restores:
SET NEWNAME FOR DATAFILE '?/oradata/prod/system01.dbf'
    TO '/backups/prod/system01_monday_noon.dbf';
SET NEWNAME FOR DATAFILE '?/oradata/prod/system02.dbf'
    TO '/backups/prod/system02_monday_noon.dbf';
SET NEWNAME FOR DATAFILE '?/oradata/prod/sysaux01.dbf'
    TO '/backups/prod/sysaux01_monday_noon.dbf';
SET NEWNAME FOR DATAFILE '?/oradata/prod/undo01.dbf'
    TO '/backups/prod/undo01_monday_noon.dbf';

# Specify the types of channels to use
ALLOCATE AUXILIARY CHANNEL c1 DEVICE TYPE DISK;
ALLOCATE AUXILIARY CHANNEL t1 DEVICE TYPE sbt;

# Recover the clients tablespace to 24 hours ago:
RECOVER TABLESPACE clients UNTIL TIME 'sysdate-1';
}

```

Consider storing this command sequence in a command file and executing the command file.

If the TSPITR operation is successful, then the results are:

- The recovery set data files are registered in the target database control file under the names specified with `SET NEWNAME`, with their contents as of the time specified time for TSPITR.
- The auxiliary files are removed by RMAN, including the control files, online logs, and auxiliary set data files of the auxiliary database.
- The auxiliary database is shut down.

If the TSPITR operation fails, the auxiliary set files are removed and the auxiliary database is shut down. The recovery set files are left in the specified location and in an unresolved state from the failed TSPITR run.

21.7 Troubleshooting RMAN TSPITR

A variety of problems can cause RMAN TSPITR to fail. This section lists possible areas to check and fix:

- File name conflicts
See [Troubleshooting File Name Conflicts During TSPITR \(page 21-28\)](#).
- Mismatched or incorrect TSPITR target times for sets of tablespaces and undo segments

See [Troubleshooting the Identification of Tablespaces with Undo Segments During TSPITR](#) (page 21-28).

- Management issues with auxiliary databases not created by RMAN
See [Troubleshooting the Restart of a Manual Auxiliary Database After TSPITR Failure](#) (page 21-28).

21.7.1 Troubleshooting File Name Conflicts During TSPITR

Name conflicts can occur between files in the target database, file names assigned by the `SET NEWNAME` or `CONFIGURE AUXNAME` commands, and file names generated by the effect of the `DB_FILE_NAME_CONVERT` parameter.

Suppose that `SET NEWNAME`, `CONFIGURE AUXNAME`, and `DB_FILE_NAME_CONVERT` cause multiple files in the auxiliary or recovery sets to have the same name. In this case, RMAN reports an error during TSPITR. To correct the problem, use different values for these parameters.

21.7.2 Troubleshooting the Identification of Tablespaces with Undo Segments During TSPITR

During TSPITR, RMAN needs information about which tablespaces had undo segments at the TSPITR target time. This information is usually available in the recovery catalog, if one is used.

If there is no recovery catalog or if the information is not found in the recovery catalog, RMAN assumes that the set of tablespaces with undo segments at the target time equals the set of tablespaces with undo segments at the present time. If this assumption is not correct, then TSPITR fails with an error. In this case, use the `UNDO TABLESPACE` clause to provide a list of tablespaces with undo segments at the target time.

21.7.3 Troubleshooting the Restart of a Manual Auxiliary Database After TSPITR Failure

If you are managing your own auxiliary database and TSPITR fails, do not attempt to rerun TSPITR without resolving the errors and following this approach:

1. Identify and fix the problems that prevented TSPITR from a successful run.
2. Start the auxiliary database in `NOMOUNT`.
3. Run TSPITR again.

Recovering Tables and Table Partitions

This chapter describes how to recover tables and table partitions to a specified point in time. This chapter contains the following topics:

- [Overview of Recovering Tables and Table Partitions from RMAN Backups](#) (page 22-1)
- [Preparing to Recover Tables and Table Partitions](#) (page 22-7)
- [Recovering Tables and Table Partitions](#) (page 22-8)
- [Recovering Tables and Table Partitions in PDBs](#) (page 22-9)
- [Examples: Recovering Tables and Table Partitions From RMAN Backups](#) (page 22-10)

22.1 Overview of Recovering Tables and Table Partitions

The RMAN RECOVER command enables you to recover tables and table partitions from RMAN backups.

Note:

There are other methods of recovering tables to a specified point in time such as Oracle Flashback and TSPITR. For more information about the scenarios in which these methods are useful and how to recover tables using these methods, see:

- [Performing Flashback and Database Point-in-Time Recovery](#) (page 18-1)
- [Performing RMAN Tablespace Point-in-Time Recovery \(TSPITR\)](#) (page 21-1)

See Also:

- [Purpose of Recovering Tables and Table Partitions from RMAN Backups](#) (page 22-2)
 - [RMAN Backups Required to Recover Tables and Table Partitions](#) (page 22-2)
 - [Basic Concepts of Recovering Tables and Table Partitions from RMAN Backups](#) (page 22-2)
-

22.1.1 Purpose of Recovering Tables and Table Partitions from RMAN Backups

RMAN enables you to recover one or more tables or table partitions to a specified point in time without affecting the remaining database objects. You can use previously-created RMAN backups to recover tables and table partitions to a specified point in time.

Recovering tables and table partitions from RMAN backups is useful in the following scenarios:

- You need to recover a very small number of tables to a particular point in time. In this situation, TSPITR is not the most effective solution because it moves all the objects in the tablespace to a specified point in time.
- You need to recover tables that have been logically corrupted or have been dropped and purged.
- Flashback Table is not possible because the desired point-in-time is older than available undo.
- You want to recover data that is lost after a DDL operation modified the structure of tables. Using Flashback Table is not possible because a DDL was run on the tables between the desired point in time and the current time. Flashback Table cannot rewind tables through structural changes such as a truncate table operation.

22.1.2 RMAN Backups Required to Recover Tables and Table Partitions

To recover table or table partitions, you need a full backup of undo, `SYSTEM`, `SYSAUX`, and the tablespace that contains the table or table partition.

To recover a table, all partitions that contain the dependent objects of the table must be included in the recovery set. If the indexes or partitions for a table in tablespace `tbs1` are contained in tablespace `tbs2`, then you can recover the table only if tablespace `tbs2` is also included in the recovery set.

To recover tables in a PDB, you need backups of the following:

- `SYSTEM`, `SYSAUX`, and undo tablespace of the root, CDB seed, and the PDB containing the tables
- Tablespace containing the tables or partitions

See Also: [Prerequisites for Recovering Tables and Table Partitions from RMAN Backups](#) (page 22-7)

22.1.3 Basic Concepts of Recovering Tables and Table Partitions from RMAN Backups

RMAN uses the `RECOVER` command to recover tables or table partitions to a specified point in time.

To recover tables and table partitions from an RMAN backup, you need to provide the following information:

- Names of tables or table partitions that must be recovered

- Point in time to which the tables or table partitions must be recovered
- Whether the recovered tables or table partitions must be imported into the target database

RMAN uses this information to automate the process of recovering the specified tables or table partitions. As part of the recovery process, RMAN creates an auxiliary database that is used to recover tables or table partitions to the specified point in time.

If the recovered tables or table partitions need to be renamed, mapped to a new tablespace, or mapped to a new schema, then you must specify the new names for the tables, tablespaces, or schemas.

See Also:

- [Steps Performed By RMAN to Recover Tables and Table Partitions](#) (page 22-3)
 - [About the Location of Auxiliary Database Files During RMAN Table Recovery](#) (page 22-4)
 - [About the Data Pump Export Dump File Used During RMAN Table Recovery](#) (page 22-5)
 - [About Renaming Recovered Tables and Table Partitions During RMAN Recovery](#) (page 22-5)
 - [About Recovering Tables and Partitions Into a New Schema](#) (page 22-6)
-
-

22.1.3.1 Steps Performed By RMAN to Recover Tables and Table Partitions

RMAN performs the following steps while automating the process of recovering tables or table partitions from an RMAN backup:

1. Determines which backup contains the tables or table partitions that need to be recovered, based on the point in time specified for the recovery.

2. Determines if there is sufficient space on the target host to create the auxiliary instance that will be used during the table or partition recovery process.

If the required space is not available, then RMAN displays an error and exits the recovery operation.

3. Creates an auxiliary database on the target host and recovers the specified tables or table partitions, until the specified point in time, into this auxiliary database.

You can specify the location on the target host to which the recovered data files are stored in the auxiliary database.

4. Creates a Data Pump [export dump file](#) that contains the recovered tables or table partitions.

You can specify the name and the location of the Data Pump [export dump file](#) used to store the metadata of the recovered tables or table partitions.

5. (Optional) Imports the Data Pump export dump file into the target instance.

You can choose not to import the export dump file that contains the recovered tables or table partitions into the target database. If you do not import the export dump file as part of the recovery process, you must manually import it later using the Data Pump Import utility.

6. (Optional) Renames the recovered tables or table partitions in the target database.

You can also import recovered objects into a tablespace or schema that is different from the one in which they originally existed.

See Also:

- [About the Location of Auxiliary Database Files During RMAN Table Recovery](#) (page 22-4)
 - [About the Data Pump Export Dump File Used During RMAN Table Recovery](#) (page 22-5)
 - [About Importing Recovered Tables and Table Partitions into the Target Database](#) (page 22-5)
 - [About Renaming Recovered Tables and Table Partitions During RMAN Recovery](#) (page 22-5)
 - [About Recovering Tables and Partitions Into a New Schema](#) (page 22-6)
-
-

22.1.3.2 About the Location of Auxiliary Database Files During RMAN Table Recovery

To recover the specified tables or table partitions, RMAN creates an auxiliary database that it uses during the recovery process. Use one of the following techniques to specify the location, on the target host, that is used to store data files for the auxiliary database:

- `AUXILIARY DESTINATION` clause in the `RECOVER` command
- `SET NEWNAME` command

Use a `RUN` block containing the `RECOVER` command and required `SET NEWNAME` commands that rename the data files.

See Also:

- `RECOVER` command syntax in *Oracle Database Backup and Recovery Reference*
 - `SET` command syntax in *Oracle Database Backup and Recovery Reference*
-
-

It is recommended that you provide a location for data files in the auxiliary database by using the `AUXILIARY DESTINATION` clause. When you use the `SET NEWNAME` command, if you omit the name of even one data file required for the recovery process, the tables or table partitions cannot be recovered.

22.1.3.3 About the Data Pump Export Dump File Used During RMAN Table Recovery

After recovering tables or table partitions to the specified point in time on the auxiliary database, RMAN creates a Data Pump [export dump file](#) that contains the recovered objects. You can either specify a name and location for this dump file or allow RMAN to use a default name and location.

Use the `DATAPUMP DESTINATION` clause of the `RECOVER` command to specify the location in which the Data Pump [export dump file](#) is created. The location is typically the path of the operating-system directory that stores the dump file. If you omit this clause, the dump file is stored in the location specified by the `AUXILIARY DESTINATION` parameter. If you do not specify an auxiliary destination, the dump file is stored in a default operating system-specific location. On Linux, this default location is `$ORACLE_HOME/dbs`. On Windows, the default location is `%ORACLE_HOME\database`.

Use the `DUMP FILE` clause of the `RECOVER` command to specify the name of the Data Pump [export dump file](#). If you omit this clause, RMAN uses a default operating system-specific name for the dump file. On Linux and Windows, the default dump file name is `tspitr_SID-of-clone_n.dmp`, where `SID-of-clone` is the Oracle SID of the auxiliary database created by RMAN to perform the recovery and `n` is any randomly-generated number. If a file with the name specified by `DUMP FILE` exists in the location in which the dump file must be created, then the recover operation fails.

22.1.3.4 About Importing Recovered Tables and Table Partitions into the Target Database

By default, RMAN imports the recovered tables or table partitions, which are stored in the [export dump file](#), into the target database. However, you can choose not to import the recovered tables or table partitions by using the `NOTABLEIMPORT` clause of the `RESTORE` command.

When `NOTABLEIMPORT` is used, RMAN recovers them to the specified point and then creates the [export dump file](#). However, this dump file is not imported into the target database. You must manually import this dump file into your target database, when required, by using the Data Pump Import utility.

If an error occurs during the import operation, RMAN does not delete the [export dump file](#) at the end of the table recovery. This enables you to manually import the dump file.

22.1.3.5 About Renaming Recovered Tables and Table Partitions During RMAN Recovery

When you recover tables or table partitions, you can rename the recovered objects after they are imported into the target database. The `REMAP TABLE` clause enables you to rename recovered tables or table partitions in your target database. To import the recovered tables or table partitions into a tablespace that is different from the one in which these objects originally existed, use the `REMAP TABLESPACE` clause of the `RECOVER` command. Only the tables or table partitions that are being recovered are remapped, the existing objects are not changed.

If a table with the same name as the one that you recovered exists in the target database, RMAN displays an error message indicating that the `REMAP TABLE` clause must be used to rename the recovered table.

When you recover table partitions, each table partition is recovered into a separate table. Use the `REMAP TABLE` clause to specify the table names into which each

recovered partition must be imported. If you do not explicitly specify table names, RMAN generates table names by concatenating the recovered table name and partition name. The generated names are in the format *tablename_partitionname*. If a table with this name exists in the target database, then RMAN appends *_1* to the name. If this name too exists, then RMAN appends *_2* to the name and so on.

Note:

When you use the `REMAP` option, any named constraints and indexes are not imported. This is to avoid name conflicts with existing tables.

22.1.3.6 About Recovering Tables and Partitions Into a New Schema

Recovering tables or table partitions into a different schema enables you to avoid name conflicts that may be caused by constraint, index, or trigger names that already existing in the source schema.

Starting with Oracle Database 12c Release 2 (12.2), you can recover tables or table partitions into a schema that is different from the source schema (the schema in which they originally existed). While recovering objects into a different schema, you can either retain their original names or rename them. You can rename tables and remap the schema in a single recovery operation. For example, you can recover the `HR.EMPLOYEES` table either into the `NEW_HR.EMPLOYEES` table, the `HR.NEW_EMPLOYEES` table, or the `NEW_HR.NEW_EMPLOYEES` table. The `REMAP TABLE` clause enables you to rename objects and recover them into a different schema.

During table recovery, use the `REMAP TABLE` clause of the `RECOVER TABLE` command to map the source schema to a new schema. The new schema must exist in the target database before you perform the recovery.

Note:

Table recovery is not supported on physical standby databases. For logical standby databases, objects that are recovered on the primary database are propagated to the logical standby.

Note:

[Example: Recovering a Table into a New Schema](#) (page 22-12)

22.1.4 Limitations of Recovering Tables and Table Partitions from RMAN Backups

When you use the `RECOVER` command to recover tables or table partitions contained in an RMAN backup, the following limitations exist.

- Tables and table partitions belonging to `SYS` schema cannot be recovered.
- Tables and table partitions from `SYSTEM` and `SYSAUX` tablespaces cannot be recovered.
- Tables and table partitions on standby databases cannot be recovered.

- Tables with named NOT NULL constraints cannot be recovered with the REMAP option.

22.2 Preparing to Recover Tables and Table Partitions

Review the limitations described in "[Limitations of Recovering Tables and Table Partitions from RMAN Backups](#) (page 22-6)".

The preparation for recovering tables or table partitions from RMAN backups involves the following steps:

- Verifying that the prerequisites required to recover tables or table partitions are met
- Determining the point in time to which the tables or table partitions must be recovered
- Deciding if the recovered tables or table partitions must be imported into the target database

By default, RMAN imports the recovered tables or table partitions into the target database. However, you can specify that RMAN must not import the recovered objects.

- Deciding if the recovered tables or table partitions must be renamed, mapped to a new tablespace, or mapped to a new schema.

See Also:

- "[Prerequisites for Recovering Tables and Table Partitions from RMAN Backups](#) (page 22-7)"
 - "[About Importing Recovered Tables and Table Partitions into the Target Database](#) (page 22-5)"
 - "[Determining the Point-in-time to Which Tables and Table Partitions Must be Recovered](#) (page 22-8)"
 - "[About Renaming Recovered Tables and Table Partitions During RMAN Recovery](#) (page 22-5)"
 - "[About Recovering Tables and Partitions Into a New Schema](#) (page 22-6)"
-
-

22.2.1 Prerequisites for Recovering Tables and Table Partitions from RMAN Backups

- The target database must be in read-write mode.
- The target database must be in ARCHIVELOG mode.
- You must have RMAN backups of the tables or table partitions as they existed at the point in time to which you want recover these objects.
- To recover single table partitions, the COMPATIBLE initialization parameter for target database must be set to 11.1.0 or higher.

See Also: [Backups Required to Recover Tables and Table Partitions](#)
(page 22-2)

22.2.2 Determining the Point-in-time to Which Tables and Table Partitions Must be Recovered

It is very important to determine the exact point in time to which you want to recover the tables or table partitions. RMAN enables you to specify the required point in time using one of the following:

- **SCN**
Recovers tables or table partitions to the state that they were at the time specified by the SCN.
- **Time**
Recovers tables or table partitions to the state they were in at the specified time. Use the date format specified in the `NLS_LANG` and `NLS_DATE_FORMAT` environment variables. You can also use data constants such as `SYSDATE` to specify the time, for example `SYSDATE-30`.
- **Sequence number**
Recovers tables or table partitions to the state they were at the time specified by the log sequence number and thread number.

22.3 Recovering Tables and Table Partitions

This section describes the steps required to recover tables or table partitions in a **non-CDB** to a specified point in time.

To recover tables or table partitions to a specified point in time:

1. Perform the planning tasks described in "[Preparing to Recover Tables and Table Partitions](#) (page 22-7)".
2. Start RMAN and connect as `TARGET` to the target database. You must connect as a user with the `SYSBACKUP` or `SYSDBA` privilege.

See Also:

["Making Database Connections with RMAN](#) (page 4-2)"

3. Recover the selected tables or table partitions to the specified point in time by using the `RECOVER TABLE` command. You must use the `AUXILIARY DESTINATION` clause and one of the following clauses to specify the point in time for recovery: `UNTIL TIME`, `UNTIL SCN`, or `UNTIL SEQUENCE`.

You can use the following additional clauses in the `RECOVER` command:

- `DUMP FILE` and `DATAPUMP DESTINATION`
Specifies the name of the [export dump file](#) containing recovered tables or table partitions and the location in which it must be stored. See "[About the Data](#)

[Pump Export Dump File Used During RMAN Table Recovery](#) (page 22-5)" for information.

- NOTABLEIMPORT

Indicates that the recovered tables or table partitions must not be imported into the target database. See "[About Importing Recovered Tables and Table Partitions into the Target Database](#) (page 22-5)"

- REMAP TABLE

Renames the recovered tables or table partitions in the target database. This clause is also used to recover tables or table partitions into a schema that is different from the source schema.

See "[About Renaming Recovered Tables and Table Partitions During RMAN Recovery](#) (page 22-5) and [About Recovering Tables and Partitions Into a New Schema](#) (page 22-6)"

- REMAP TABLESPACE

Recovers the tables or table partitions into a tablespace that is different from the one in which these objects originally existed.

See "[About Renaming Recovered Tables and Table Partitions During RMAN Recovery](#) (page 22-5)"

See Also:

For examples on recovering tables and table partitions, see:

- "[Example: Recovering Tables to a Specified Point in Time](#) (page 22-10)"
 - "[Example: Recovering Table Partitions to a Specified Log Sequence Number](#) (page 22-11)"
 - *Oracle Database Backup and Recovery Reference* for more examples on recovering tables and table partitions
-
-

22.4 Recovering Tables and Table Partitions in PDBs

RMAN enables you to recover one or more tables or table partitions in a pluggable database (PDB) to a specified point-in-time without impacting other objects in the PDB. The steps used to recover tables or table partitions in a PDB are similar to the ones used for non-CDBs, with the differences described in this section.

To recover tables or table partitions in a PDB:

1. Perform the planning tasks described in "[Preparing to Recover Tables and Table Partitions](#) (page 22-7)".
2. Start RMAN and connect to the root as a user with the SYSDBA or SYSBACKUP privilege.

See Also:

"[Making RMAN Connections to a CDB](#) (page 4-7)"

3. Recover the tables or table partitions to the specified point in time by using the `RECOVER TABLE ... OF PLUGGABLE DATABASE` command.

You must use the `AUXILIARY DESTINATION` clause and one of the following clauses: `UNTIL TIME`, `UNTIL SCN`, or `UNTIL SEQUENCE`.

Depending on your requirements, you may also need to use the one or more of the following clauses: `DUMP FILE`, `DATAPUMP DESTINATION`, `NOTABLEIMPORT`, `REMAP TABLE`, or `REMAP TABLESPACE`.

See Also:

- ["Basic Concepts of Recovering Tables and Table Partitions from RMAN Backups \(page 22-2\)"](#)
 - *Oracle Database Backup and Recovery Reference* for information about the `RECOVER` command
-
-

The following command recovers the table `PDB_EMP` in the PDB `HR_PDB` to the state that it was in 4 days before the current date. `HR` is the name of the schema that contains the table. The recovered table is renamed to `EMP_RECVR`.

```
RECOVER TABLE HR.PDB_EMP OF PLUGGABLE DATABASE HR_PDB
UNTIL TIME 'SYSDATE-4'
AUXILIARY DESTINATION '/tmp/backups'
REMAP TABLE 'HR'.'PDB_EMP':'EMP_RECVR';
```

22.5 Examples: Recovering Tables and Table Partitions From RMAN Backups

This section contains the following examples that demonstrate how to recover tables and table partitions to a specified point in time by using RMAN backups:

- [Example: Recovering Tables to a Specified Point in Time \(page 22-10\)](#)
- [Example: Recovering Table Partitions to a Specified Log Sequence Number \(page 22-11\)](#)
- [Example: Recovering a Table into a New Schema \(page 22-12\)](#)

22.5.1 Example: Recovering Tables to a Specified Point in Time

This example recovers multiple tables to a specified point in time that is represented using `SYSDATE`.

Assume that you want to recover two tables `EMP` and `DEPT` to the state they were in two days ago, before some logical corruption occurred. However, you do not want RMAN to import these tables into the target database. RMAN must only create the [export dump file](#), called `emp_dept_exp_dump.dat`, in the location `/tmp/recover/dumpfiles`. Using `NOTABLEIMPORT` indicates that these tables must not be imported into the target database. You can import these tables, when required, by using the Data Pump import utility. The auxiliary destination used during the recovery process is `/tmp/oracle/recover`.

To recover tables `EMP` and `DEPT` without importing them into the target database:

1. Perform the planning tasks described in "[Preparing to Recover Tables and Table Partitions](#) (page 22-7)".

In this example, you need to recover tables to a point in time specified by an expression that uses `SYSDATE`. However, the recovered tables must not be imported in to the target database.

2. Start an RMAN session and connect as `TARGET` to the target database as described in "[Making Database Connections with RMAN](#) (page 4-2)".
3. Recover the tables `EMP` and `DEPT` using the following clauses in the `RECOVER` command: `DATAPUMP DESTINATION`, `DUMP FILE`, `REMAP TABLE`, and `NOTABLEIMPORT`.

The following `RECOVER` command recovers the `EMP` and `DEPT` tables.

```
RECOVER TABLE SCOTT.EMP, SCOTT.DEPT
  UNTIL TIME 'SYSDATE-1'
  AUXILIARY DESTINATION '/tmp/oracle/recover'
  DATAPUMP DESTINATION '/tmp/recover/dumpfiles'
  DUMP FILE 'emp_dept_exp_dump.dat'
  NOTABLEIMPORT;
```

See Also:

Oracle Database Backup and Recovery Reference for additional examples about recovering tables to a specified point in time

22.5.2 Example: Recovering Table Partitions to a Specified Log Sequence Number

This example uses RMAN backups to recover multiple table partitions.

In this example, the table `sales`, in the schema `sh`, contains the following partitions: `sales_1998`, `sales_1999`, `sales_2000`, and `sales_2001`. This table is stored in the `sales_ts` tablespace. You need to recover two partitions, `sales_1998` and `sales_1999`, to a point in time that is specified by a redo log sequence number. The recovered tables must be automatically imported into the target database and mapped to the tablespace `SALES_PRE_2000_TS`.

To recover the partitions `sales_1998` and `sales_1999` to a specified log sequence number:

1. Perform the planning tasks described in "[Preparing to Recover Tables and Table Partitions](#) (page 22-7)".

In this example, you need to recover two table partitions to a specified log sequence number and then import these partitions into the target database.

2. Start an RMAN session and connect as `TARGET` to the target database as described in "[Making Database Connections with RMAN](#) (page 4-2)".
3. Recover partitions using the following `RECOVER` command with the `REMAP TABLE` and `REMAP TABLESPACE` clauses.

```
RECOVER TABLE SH.SALES:SALES_1998, SH.SALES:SALES_1999
  UNTIL SEQUENCE 354
  AUXILIARY DESTINATION '/tmp/oracle/recover'
  REMAP TABLE 'SH'. 'SALES': 'SALES_1998': 'HISTORIC_SALES_1998',
  'SH'. 'SALES': 'SALES_1999': 'HISTORIC_SALES_1999'
```

```
REMAP TABLESPACE 'SALES_TS':'SALES_PRE_2000_TS';
```

In this case, the specified table partitions are imported as separate tables, called `historic_sales_1998` and `historic_sales_1999`, into the `sales_pre_2000_ts` tablespace of the target database. The `REMAP TABLE` clause specifies the names used for the imported tables. The auxiliary destination used during the recovery process is `/tmp/oracle/recover`.

If you omit the `REMAP TABLE` clause, RMAN uses default names for the imported tables. The name is a combination of the original table name and the partition name.

22.5.3 Example: Recovering a Table into a New Schema

This example recovers multiple tables into a new schema that is different from the source schema.

In this example, the `HR.DEPARTMENTS` and `SH.CHANNELS` tables need to be recovered to the state that they were in one day ago, before a logical corruption occurred. The recovered tables must be renamed as `NEW_DEPARTMENTS` and `NEW_CHANNELS` and imported into the `EXAMPLE` schema. The schema `EXAMPLE` exists at the time this example is run.

The `REMAP TABLE` clause is used to indicate how the source schema is mapped to a new target schema. The auxiliary destination used during the recovery process is `/tmp/auxdest`.

1. Perform the planning tasks required to recover tables from RMAN backups. In this example, you need to recover tables to a point in time specified by an expression that uses `SYSDATE`.

See [Preparing to Recover Tables and Table Partitions](#) (page 22-7).

2. Start an RMAN session and connect to the target database as described in "[Making Database Connections with RMAN](#)" (page 4-2)".
3. Recover the `HR.DEPARTMENTS` and `SH.CHANNELS` tables, rename them to `NEW_DEPARTMENTS` and `NEW_CHANNELS` respectively, and then import them into the `EXAMPLE` schema.

The following `RECOVER` command performs the required table recovery:

```
RECOVER TABLE HR.DEPARTMENTS, SH.CHANNELS
UNTIL TIME 'SYSDATE - 1'
AUXILIARY DESTINATION '/tmp/auxdest'
REMAP TABLE hr.departments:example.new_departments,
sh.channels:example.new_channels;
```

Part VI

Tuning and Troubleshooting

The following chapters describe how to tune and troubleshoot RMAN operations. This part of the book contains these chapters:

- [Tuning RMAN Performance](#) (page 23-1)
- [Troubleshooting RMAN Operations](#) (page 24-1)

Tuning RMAN Performance

This chapter contains the following topics:

- [Purpose of RMAN Performance Tuning](#) (page 23-1)
- [Basic Concepts of RMAN Performance Tuning](#) (page 23-1)
- [Using V\\$ Views to Diagnose RMAN Performance Problems](#) (page 23-11)
- [Tuning RMAN Backup Performance](#) (page 23-15)

23.1 Purpose of RMAN Performance Tuning

An RMAN backup or restore job can be divided into separate phases or components. The slowest of these phases in any RMAN job is called the **bottleneck**. The purpose of RMAN tuning is to identify the bottlenecks for a given job and use RMAN commands, initialization parameters, or adjustments to physical media to improve performance.

23.2 Basic Concepts of RMAN Performance Tuning

Tuning RMAN performance requires a detailed understanding of how RMAN creates a backup. The work of a backup is performed by one or more channels. A [channel](#) represents a stream of bytes to a storage device.

For the purposes of illustration, you can think of the byte stream as passing from the input buffers in memory through the CPU to the output buffers, and from there to the storage device. To direct a backup to two tape devices, you allocate two tape channels so that each byte stream goes to a different device.

The work of each channel, whether of type disk or System Backup Tape (SBT), is subdivided into distinct phases. The following table describes these phases.

Table 23-1 Phases in Channel Work

Sequence	Phase	Description	Additional Information
1	Read phase	A channel reads blocks from disk into input I/O buffers.	" Read Phase (page 23-3)"
2	Copy phase	A channel copies blocks from input buffers to output buffers and performs additional processing on the blocks.	" Copy Phase (page 23-6)"

Table 23-1 (Cont.) Phases in Channel Work

Sequence	Phase	Description	Additional Information
3	Write phase	A channel writes the blocks from output buffers to storage media. The write phase can take either of the following mutually exclusive forms, depending on the type of backup media: write phase for System Backup Tape (SBT) or write phase for disk.	<ul style="list-style-type: none"> • "Write Phase for System Backup Tape (SBT) (page 23-7)" • "Write Phase for Disk (page 23-10)"

Figure 23-1 (page 23-2) depicts two channels backing up data stored on three disks. Each channel reads the data into the input buffers, processes the data while copying it from the input to the output buffers, and then writes the data from the output buffers to disk.

Figure 23-1 Phases of a Multichannel Backup to Disk

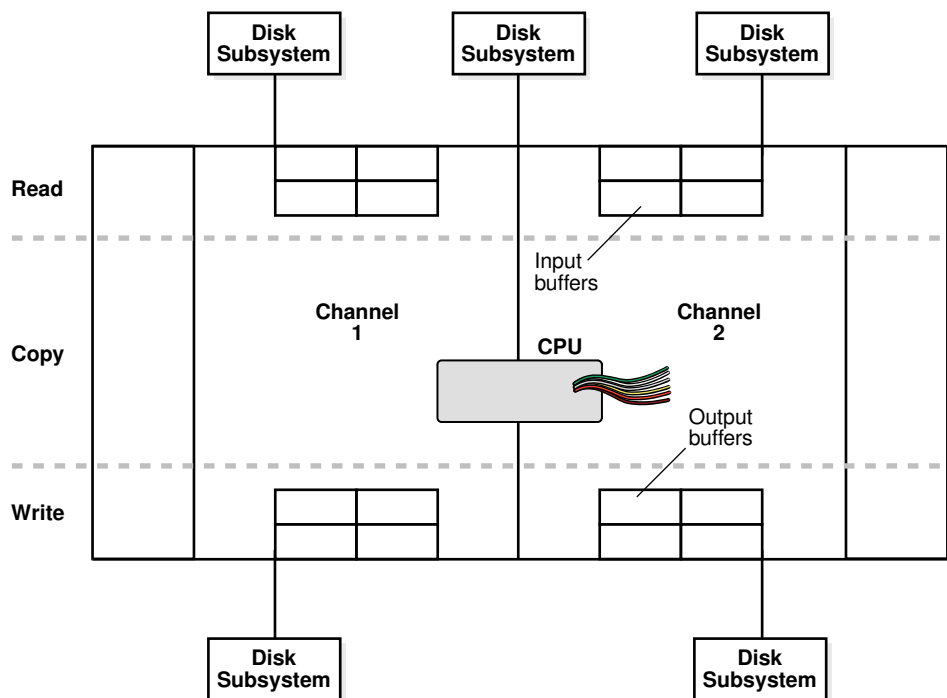
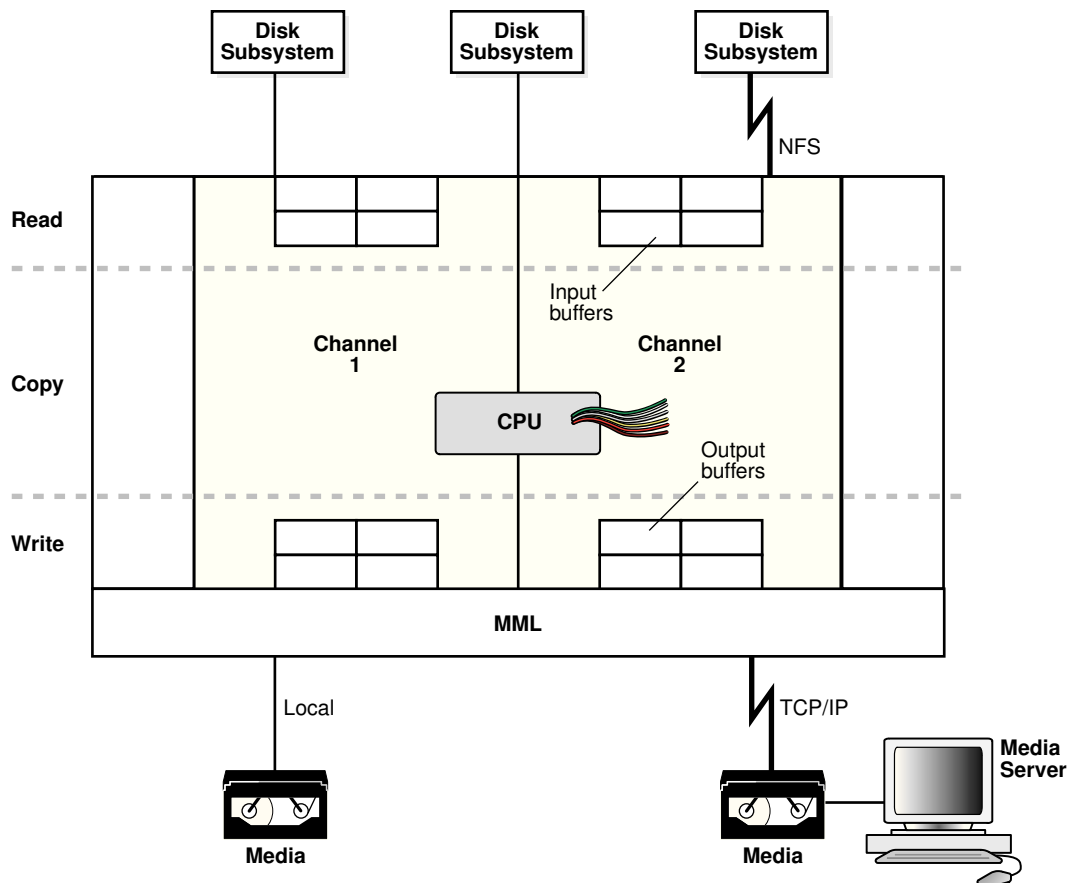

Figure 23-2 (page 23-3) also depicts two channels backing up data stored on three disks, but one disk is mounted remotely over the network. Each channel reads the data into the input buffers, processes the data while copying it from the input buffers to the output buffers, and then writes the data from the output buffers to tape. Channel 1 writes the data to a locally attached tape drive, whereas channel 2 sends the data over the network to a remote media server.

Figure 23-2 Phases of a Multichannel Backup to Tape



When restoring data, a channel performs these steps in reverse order and reverses the reading and writing operations. The following sections explain RMAN tuning concepts in terms of a backup.

The number of channels available for use with a device determines whether RMAN can read from and write to this device in parallel. It is recommended that the number of channels be equal to the number of storage devices used. Therefore, when RMAN uses disk, the number of channels must be equal to the number of physical disks accessed. When RMAN uses tape, the number of channels must be equal to the number of tape drives accessed by RMAN.

23.2.1 Read Phase

This section explains factors that affect performance when an RMAN channel is reading data from disk:

- [Allocation of Input Disk Buffers](#) (page 23-4)
- [Synchronous and Asynchronous Disk I/O](#) (page 23-5)
- [Disk I/O Slaves](#) (page 23-5)
- [RATE Channel Parameter](#) (page 23-6)

23.2.1.1 Allocation of Input Disk Buffers

During a backup, an RMAN channel reads the blocks from the input files into I/O disk buffers. The database files on the disk subsystem can be managed by either [Automatic Storage Management \(ASM\)](#) or an alternative volume manager or file system. The considerations for backup tuning change depending on whether you manage database files with ASM.

The allocation of the input buffers depends on how the files are multiplexed. Backup [multiplexing](#) is RMAN's ability to read several files in a backup simultaneously from different sources and then write them to a single backup piece. The [level of multiplexing](#), which is the number of input files simultaneously read and then written into the same [backup piece](#), is determined by the algorithm described in "[About Multiplexed RMAN Backup Sets](#) (page 8-8)". Review this section before proceeding.

When an RMAN channel backs up files from disk, it uses the rules described in [Table 23-2](#) (page 23-4) to determine how large to make the input disk buffers.

Table 23-2 Data File Read Buffer Sizing Algorithm

Level of Multiplexing	Input Disk Buffer Size
Less than or equal to 4	The RMAN channel allocates 16 buffers of size 1 megabyte (MB) so that the total buffer size for all the input files is 16 MB.
Greater than 4 but less than or equal to 8	The RMAN channel allocates a variable number of disk buffers of size 512 kilobytes (KB) so that the total buffer size for all the input files is less than 16 MB.
Greater than 8	The RMAN channel allocates 4 disk buffers of 128 KB for each file, so that the total buffer size for each input file is 512 KB.

In the example shown in [Figure 23-3](#) (page 23-5), one channel is backing up four data files. `MAXOPENFILES` is set to 4 and `FILESERSET` is set to 4. Thus, the level of multiplexing is 4. So, the total size of the buffers for each data file is 4 MB. The combined size of all the buffers is 16 MB.

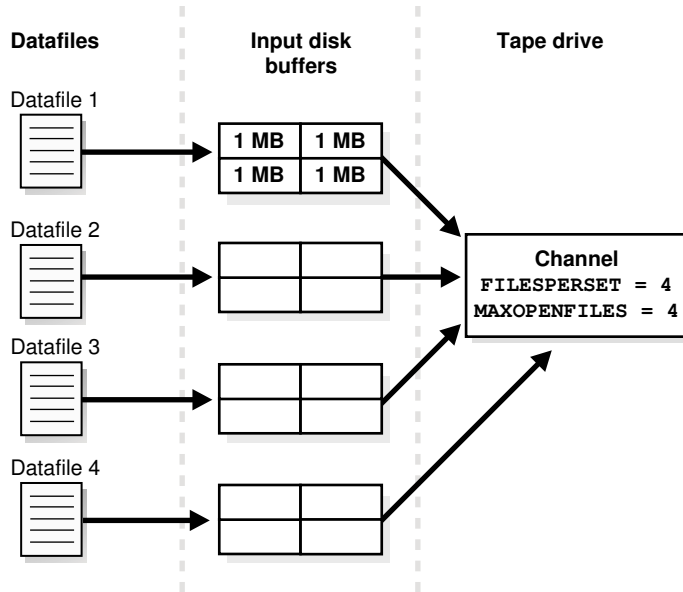
Figure 23-3 Disk Buffer Allocation

```

SGA if BACKUP_DISK_IO_SLAVES ≠ 0
      or
PGA if BACKUP_DISK_IO_SLAVES = 0

```

If a channel is backing up files stored in ASM, then the number of input disk buffers equals the number of physical disks in the ASM disk group only if the level of multiplexing is 1. For example, if a data file is stored in an ASM disk group that contains 16 physical disks, then the channel allocates 16 input buffers for the data file backup.

If a channel is restoring a backup from disk, then 4 buffers are allocated. The size of the buffers is dependent on the operating system.

23.2.1.2 Synchronous and Asynchronous Disk I/O

When a channel reads from or writes to disk, the I/O is either [synchronous I/O](#) or [asynchronous I/O](#). When the disk I/O is synchronous, a server process can perform only one task at a time. When the disk I/O is asynchronous, a server process can begin an I/O operation and then perform other work while waiting for the I/O to complete. RMAN can also begin multiple I/O operations before waiting for the first to complete.

When reading from an ASM [disk group](#), use asynchronous disk I/O if possible. Also, if a channel reads from a [raw device](#) managed with a volume manager, then asynchronous disk I/O also works well. Some operating systems support native asynchronous disk I/O. The database takes advantage of this feature if it is available.

23.2.1.3 Disk I/O Slaves

On operating systems that do not support native asynchronous I/O, the database can simulate it with special I/O slave processes. These processes are dedicated to performing I/O on behalf of another process.

You can control disk I/O slaves by setting the `DBWR_IO_SLAVES` initialization parameter, which is not dynamic. The parameter specifies the number of I/O server processes used by the database writer process (DBWR). By default, the value is 0 and I/O server processes are not used. If asynchronous I/O is disabled, then RMAN allocates four backup disk I/O slaves for any nonzero value of `DBWR_IO_SLAVES`.

When attempting to get shared buffers for I/O slaves, the database does the following:

- If the `LARGE_POOL_SIZE` initialization parameter is set, and if the `DBWR_IO_SLAVES` parameter is set to a nonzero value, then the database attempts to get memory from the large pool. If this value is not large enough, then an error is recorded in the alert log, the database does not try to get buffers from the shared pool, and asynchronous I/O is not used.
- If the `LARGE_POOL_SIZE` initialization parameter is not set or is set to zero, then the database attempts to get memory from the shared pool.
- If the database cannot get enough memory, then it obtains I/O buffer memory from the Program Global Area (PGA) and writes a message to the `alert.log` file indicating that synchronous I/O is used for this backup.

The memory from the large pool is used for many features, including the shared server, parallel query, and RMAN I/O slave buffers. Configuring the large pool prevents RMAN from competing with other subsystems for the same memory.

Requests for contiguous memory allocations from the shared pool are usually small (under 5 KB). However, a request for a large contiguous memory allocation can either fail or require significant memory housekeeping to release the required amount of contiguous memory. Although the shared pool may be unable to satisfy this memory request, the large pool can do so. The large pool does not have a least recently used (LRU) list; the database does not attempt to age memory out of the large pool.

23.2.1.4 RATE Channel Parameter

In the `ALLOCATE` and `CONFIGURE CHANNEL` commands, the `RATE` parameter specifies the bytes per second that are read on a channel. You can use this parameter to set an upper limit for bytes read so that RMAN does not consume excessive disk bandwidth and degrade online performance. Essentially, `RATE` serves as a backup throttle. For example, if you set `RATE 1500K`, and if each disk drive delivers 3 megabytes per second, then the channel leaves some disk bandwidth available to the online system.

23.2.2 Copy Phase

In this phase, a channel copies blocks from the input buffers to the output buffers and performs additional processing. For example, if a channel reads data from disk and backs up to tape, then the channel copies the data from the disk buffers to the output tape buffers.

The copy phase involves the following types of processing:

- Validation
- Compression
- Encryption

When performing [validation](#) of the blocks, RMAN checks them for corruption. Validation is explained in [Validating Database Files and Backups](#) (page 16-1). Typically, this processing is not CPU-intensive.

When performing [binary compression](#), RMAN applies a compression algorithm to the data in backup sets. Binary compression can be CPU-intensive. You can choose which compression algorithm RMAN uses for backups. The basic compression level for RMAN has a good compression ratio for most scenarios. If you enabled the Oracle Advanced Compression option, there are several different levels to choose from that

provide tradeoffs between compression ratios and required CPU resources. Binary compression is explained in "[About Binary Compression for RMAN Backup Sets](#) (page 8-5)" and in "[Making Compressed Backups](#) (page 9-7)".

When performing [backup encryption](#), RMAN encrypts backup sets by using an algorithm listed in `V$RMAN_ENCRYPTION_ALGORITHMS`. RMAN offers three modes of encryption: transparent, password-protected, and dual-mode. Backup encryption is explained in "[Encrypting RMAN Backups](#) (page 10-11)". Backup encryption can be CPU-intensive.

23.2.3 Write Phase for System Backup Tape (SBT)

When backing up to SBT, RMAN gives the [media management software](#) a stream of bytes and associates a unique name with this stream. All details of how and where that stream is stored are handled entirely by the media manager. Thus, a backup to tape involves the interaction of both RMAN and the media manager.

Factors that affect the write phase for SBT are described in the following topics:

- [RMAN Component of the Write Phase for SBT](#) (page 23-7)
- [Media Manager Component of the Write Phase for SBT](#) (page 23-9)

23.2.3.1 RMAN Component of the Write Phase for SBT

The RMAN-specific factors affecting the SBT write phase are analogous to the factors affecting disk reads. In both cases, the buffer allocation, slave processes, and synchronous or asynchronous I/O affect performance.

23.2.3.1.1 Allocation of Tape Buffers

If you back up to or restore from an [SBT](#) device, then by default the database allocates four buffers for each channel for the tape writers (or reads if restoring data as shown in [Figure 23-4](#) (page 23-7)). The size of the tape I/O buffers is platform-dependent. You can change this value with the `PARMS` and `BLKSIZE` parameters of the `ALLOCATE CHANNEL` or `CONFIGURE CHANNEL` command.

Figure 23-4 Allocation of Tape Buffers

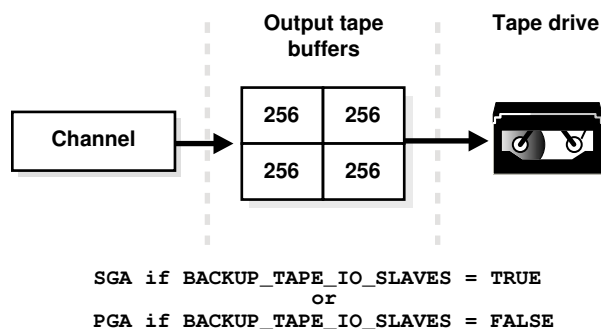

23.2.3.1.2 Tape I/O Slaves

RMAN allocates the tape buffers in the System Global Area (SGA) or the Program Global Area (PGA), depending on whether I/O slaves are used. If you set the initialization parameter `BACKUP_TAPE_IO_SLAVES=true`, then RMAN allocates tape buffers from the SGA. Tape devices can only be accessed by one process at a time, so RMAN starts as many slaves as necessary for the number of tape devices. If the `LARGE_POOL_SIZE` initialization parameter is also set, then RMAN allocates buffers

from the large pool. If you set `BACKUP_TAPE_IO_SLAVES=false`, then RMAN allocates the buffers from the PGA.

If you use I/O slaves, then set the `LARGE_POOL_SIZE` initialization parameter to dedicate SGA memory to holding these large memory allocations. This parameter prevents RMAN I/O buffers from competing with the library cache for SGA memory. If I/O slaves for tape I/O were requested but there is not enough space in the SGA for them, slaves are not used, and a message appears in the alert log.

The parameter `BACKUP_TAPE_IO_SLAVES` specifies whether RMAN uses slave processes rather than the number of slave processes. Tape devices can only be accessed by one process at a time, and RMAN uses the number of slaves necessary for the number of tape devices.

23.2.3.1.3 Synchronous and Asynchronous I/O

When an SBT channel reads or writes data to tape, the I/O is always synchronous. For tape I/O, each channel allocated (whether manually or automatically) corresponds to a server process, called here a channel process.

Figure 23-5 (page 23-8) shows synchronous I/O in a backup to tape.

Figure 23-5 Synchronous Tape I/O

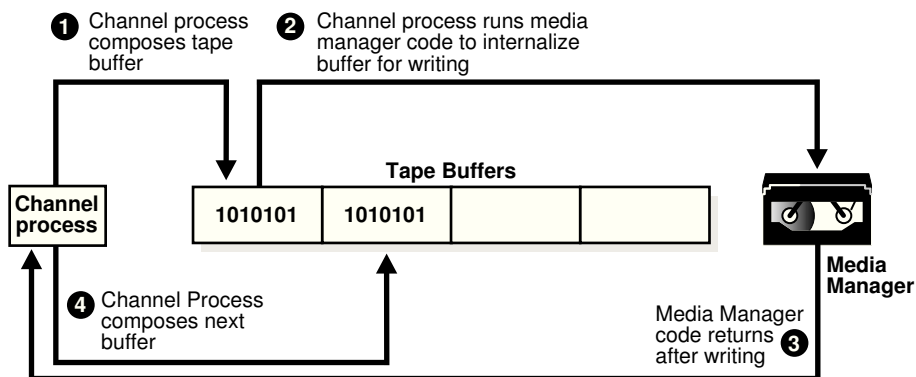

The following steps occur:

1. The channel process composes a tape buffer.
2. The channel process executes media manager code that processes the tape buffer and internalizes it for further processing and storage by the media manager.
3. The media manager code returns a message to the server process stating that it has completed writing.
4. The channel process can initiate a new task.

Figure 23-6 (page 23-9) shows asynchronous I/O in a tape backup. Asynchronous I/O to tape is simulated by using tape slaves. In this case, each allocated channel corresponds to a server process, which in the explanation that follows is identified as a channel process. For each channel process, one tape slave is started (or more than one, if multiple copies exist).

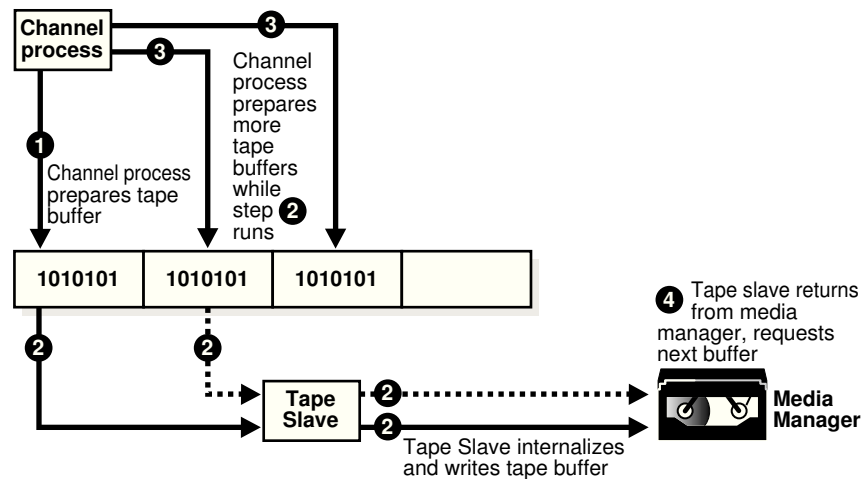
Figure 23-6 Asynchronous Tape I/O

The following steps occur:

1. A channel process writes blocks to a tape buffer.
2. The channel process sends a message to the tape slave process to process the tape buffer. The tape slave process executes media manager code that processes the tape buffer and internalizes it so that the media manager can process it.
3. While the tape slave process is writing, the channel process is free to read data from the data files and prepare more output buffers.
4. After the tape slave channel returns from the media manager code, it requests a new tape buffer, which usually is ready. Thus waiting time for the channel process is reduced, and the backup is completed faster.

23.2.3.2 Media Manager Component of the Write Phase for SBT

The following factors affect the speed of the backup to tape:

- [Network Throughput](#) (page 23-9)
- [Native Transfer Rate](#) (page 23-9)
- [Tape Compression](#) (page 23-10)
- [Tape Streaming](#) (page 23-10)
- [Physical Tape Block Size](#) (page 23-10)

23.2.3.2.1 Network Throughput

If the tape device is remote, then the media manager must transfer data over the network. For example, an administrative domain in Oracle Secure Backup can contain multiple networked client hosts, media servers, and tape devices. If the database is on one host, but the output tape drive is attached to a different host, then Oracle Secure Backup manages the data transfer over the network. The network throughput is the upper limit for backup performance.

23.2.3.2.2 Native Transfer Rate

The tape [native transfer rate](#) is the speed of writing to a tape without compression. This speed represents the upper limit of the backup rate. The upper limit of your

backup performance should be the aggregate transfer rate of all of your tape drives. If your backup is performing at that rate, and if it is not using an excessive amount of CPU, then RMAN performance tuning does not help.

23.2.3.2.3 Tape Compression

The level of tape compression is very important for backup performance. If the tape has good compression, then the sustained backup rate is faster. For example, if the compression ratio is 2:1 and native transfer rate of the tape drive is 6 megabytes per second, then the resulting backup speed is 12 megabytes per second. In this case, RMAN must be able to read disks with a throughput of more than 12 megabytes per second or the disk becomes the bottleneck for the backup.

Note:

Do not use both tape compression provided by the media manager and binary compression provided by RMAN. If the media manager compression is efficient, then it is usually the better choice. Using RMAN-compressed backup sets can be an effective alternative to reduce bandwidth used to move uncompressed backup sets over a network to the media manager, if the CPU overhead required to compress the data in RMAN is acceptable.

23.2.3.2.4 Tape Streaming

Tape streaming during write operations has a major effect on tape backup performance. Many tape drives are fixed-speed, streaming tape drives. Because such drives can write data at only one speed, when they run out of data to write to tape, the tape must slow and stop. Typically, when the drive's buffer empties, the tape is moving so quickly that it actually overshoots; to continue writing, the drive must rewind the tape to locate the point where it stopped writing. Multiple speed tape drives are available that alleviate this problem.

23.2.3.2.5 Physical Tape Block Size

The physical tape block size can affect backup performance. The block size is the amount of data written by media management software to a tape in one write operation. In general, the larger the tape block size, the faster the backup. The physical tape block size is not controlled by RMAN or Oracle database, but by media management software. See your media management software's documentation for details.

23.2.4 Write Phase for Disk

The principal factor affecting the write phase for disk is the buffer size. When the output of the backup resides on disk, each channel allocates four output buffers of 1 MB each. The disk channel writes the blocks to the disk subsystem. When restoring files, the read phase is similar to the write phase when backing up files, except the blocks move in the opposite direction.

If RMAN reads from a disk asynchronously, then it writes to the disk asynchronously. When writing to disk, you can make use of disk I/O slaves just as when reading from disk.

If RMAN is backing up files to a disk-based output destination striped over multiple disks, then you can allocate multiple channels. The number of channels is limited only to the number of disks over which the destination is striped. ASM is one example of a destination striped over multiple disks.

23.3 Using V\$ Views to Diagnose RMAN Performance Problems

Typically, you begin the tuning process by using V\$ views to determine where RMAN backup and restore operations are encountering problems.

This section contains the following topics:

- [Monitoring RMAN Job Progress with V\\$SESSION_LONGOPS](#) (page 23-11)
- [Identifying Bottlenecks with V\\$BACKUP_SYNC_IO and V\\$BACKUP_ASYNC_IO](#) (page 23-13)

23.3.1 Monitoring RMAN Job Progress with V\$SESSION_LONGOPS

You can monitor the progress of backups and restore jobs by querying the view V\$SESSION_LONGOPS. RMAN uses two types of rows in V\$SESSION_LONGOPS: detail rows and aggregate rows.

Detail rows describe the files being processed by one job step, whereas aggregate rows describe the files processed by all job steps in an RMAN command. A job step is the creation or restoration of one backup set or data file copy. Detail rows are updated with every buffer that is read or written during the backup step, so their granularity of update is small. Aggregate rows are updated when each job step completes, so their granularity of update is large.

[Table 23-3](#) (page 23-11) describes the columns in V\$SESSION_LONGOPS that are most relevant for RMAN. Typically, you view the detail rows rather than the aggregate rows to determine the progress of each backup set.

Table 23-3 Columns of V\$SESSION_LONGOPS Relevant for RMAN

Column	Description for Detail Rows
SID	The server session ID corresponding to an RMAN channel
SERIAL#	The server session serial number. This value changes each time a server session is reused.
OPNAME	A text description of the row. Examples of details rows include RMAN: datafile copy, RMAN: full datafile backup, and RMAN: full datafile restore. Note: RMAN: aggregate input and RMAN: aggregate output are the only aggregate rows.
CONTEXT	For backup output rows, this value is 2. For all other rows except proxy copy (which does not update this column), the value is 1.

Table 23-3 (Cont.) Columns of V\$SESSION_LONGOPS Relevant for RMAN

Column	Description for Detail Rows
SOFAR	The meaning of this column depends on the type of operation described by this row: <ul style="list-style-type: none"> For image copies, the number of blocks that have been read For backup input rows, the number of blocks that have been read from the files being backed up For backup output rows, the number of blocks that have been written to the backup piece For restores, the number of blocks that have been processed to the files that are being restored in this one job step For proxy copies, the number of files that have been copied
TOTALWORK	The meaning of this column depends on the type of operation described by this row: <ul style="list-style-type: none"> For image copies, the total number of blocks in the file. For backup input rows, the total number of blocks to be read from all files processed in this job step. For backup output rows, the value is 0 because RMAN does not know how many blocks that it will write into any backup piece. For restores, the total number of blocks in all files restored in this job step. For proxy copies, the total number of files to be copied in this job step.

Each server session performing a backup or restore job reports its progress compared to the total work required for a job step. For example, if you restore the database with two channels, and each channel has two backup sets to restore (a total of four sets), then each server session reports its progress through a single backup set. When a set is completely restored, RMAN begins reporting progress on the next set to restore.

To monitor RMAN job progress:

1. Before starting the RMAN job, create a script file (called, for this example, `longops`) containing the following SQL statement:

```
SELECT SID, SERIAL#, CONTEXT, SOFAR, TOTALWORK,
       ROUND(SOFAR/TOTALWORK*100,2) "%_COMPLETE"
FROM   V$SESSION_LONGOPS
WHERE  OPNAME LIKE 'RMAN%'
AND    OPNAME NOT LIKE '%aggregate%'
AND    TOTALWORK != 0
AND    SOFAR <> TOTALWORK;
```

2. Start RMAN and connect to the target database and recovery catalog (if used).
3. Start an RMAN job. For example, enter:

```
RMAN> RESTORE DATABASE;
```

4. While the RMAN job is running, start SQL*Plus and connect to the target database, and execute the `longops` script to check the progress of the RMAN job. If you

repeat the query while the RMAN job progresses, then you see output such as the following:

```
SQL> @longops
      SID      SERIAL#    CONTEXT          SOFAR  TOTALWORK  %_COMPLETE
-----
       8         19         1          10377    36617     28.34

SQL> @longops
      SID      SERIAL#    CONTEXT          SOFAR  TOTALWORK  % COMPLETE
-----
       8         19         1          21513    36617     58.75

SQL> @longops
      SID      SERIAL#    CONTEXT          SOFAR  TOTALWORK  % COMPLETE
-----
       8         19         1          29641    36617     80.95

SQL> @longops
      SID      SERIAL#    CONTEXT          SOFAR  TOTALWORK  % COMPLETE
-----
       8         19         1          35849    36617     97.9

SQL> @longops
no rows selected
```

5. If you run the longops script at intervals of 2 minutes or more and the %_COMPLETE column does not increase, then RMAN is encountering a problem. See "[Monitoring RMAN Interaction with the Media Manager](#) (page 24-9)" to obtain more information.

If you frequently monitor the execution of long-running tasks, then you could create a shell script or batch file under your host operating system that runs SQL*Plus to execute this query repeatedly.

23.3.2 Identifying Bottlenecks with V\$BACKUP_SYNC_IO and V\$BACKUP_ASYNC_IO

You can use the V\$BACKUP_SYNC_IO and V\$BACKUP_ASYNC_IO views to determine the source of backup or restore bottlenecks and to see detailed progress of backup jobs.

V\$BACKUP_SYNC_IO contains rows when the I/O is synchronous to the process (or thread on some platforms) performing the backup. V\$BACKUP_ASYNC_IO contains rows when the I/O is asynchronous. Asynchronous I/O is obtained either with I/O processes or because it is supported by the underlying operating system.

The results of a backup or restore job remain in memory until the database instance shuts down. Thus, you can query the views after the job completes.

To determine whether the tape is streaming when the I/O is synchronous:

1. Start SQL*Plus and connect to the target database.
2. Query the EFFECTIVE_BYTES_PER_SECOND column in the V\$BACKUP_SYNC_IO or V\$BACKUP_ASYNC_IO view.

If EFFECTIVE_BYTES_PER_SECOND is less than the raw capacity of the hardware, then the tape is not streaming. If EFFECTIVE_BYTES_PER_SECOND is greater than the raw capacity of the hardware, the tape may or may not be streaming.

Compression may cause the `EFFECTIVE_BYTES_PER_SECOND` to be greater than the speed of real I/O.

See Also:

Oracle Database Reference for more information about these views

23.3.2.1 Identifying Bottlenecks with Synchronous I/O

With synchronous I/O, it is difficult to identify specific bottlenecks because all synchronous I/O is a bottleneck to the process. The only way to tune synchronous I/O is to compare the rate (in bytes per second) with the device's maximum throughput rate. If the rate is lower than the rate that the device specifies, then consider tuning this aspect of the backup and restore process.

To determine the rate of synchronous I/O:

1. Start SQL*Plus and connect to the target database.
2. Query the `DISCRETE_BYTES_PER_SECOND` column in the `V$BACKUP_SYNC_IO` view to display the I/O rate.

If you see data in `V$BACKUP_SYNC_IO`, then the problem is that you have not enabled asynchronous I/O or you are not using disk I/O slaves.

23.3.2.2 Identifying Bottlenecks with Asynchronous I/O

Long waits are the number of times the backup or restore process told the operating system to wait until an I/O was complete. **Short waits** are the number of times the backup or restore process made an operating system call to poll for I/O completion in a nonblocking mode. **Ready** indicates the number of times when I/O was ready for use, so there was no need to make an operating system call to poll for I/O completion.

To determine the rate of asynchronous I/O:

1. Start SQL*Plus and connect to the target database.
2. Query the `LONG_WAITS` and `IO_COUNT` columns in the `V$BACKUP_ASYNC_IO` view to display the I/O rate.

The simplest way to identify the bottleneck is to find the data file that has the largest ratio for `LONG_WAITS` divided by `IO_COUNT`. For example, you can use the following query:

```
SELECT  LONG_WAITS/IO_COUNT, FILENAME
FROM    V$BACKUP_ASYNC_IO
WHERE   LONG_WAITS/IO_COUNT > 0
ORDER BY LONG_WAITS/IO_COUNT DESC;
```

Note:

If you have synchronous I/O but you set `BACKUP_DISK_IO_SLAVES`, then the I/O is displayed in `V$BACKUP_ASYNC_IO`.

See Also:

Oracle Database Reference for descriptions of the `V$BACKUP_SYNC_IO` and `V$BACKUP_ASYNC_IO` views

23.4 Tuning RMAN Backup Performance

Many factors can affect backup performance. Often, finding the solution to a slow backup is a process of trial and error.

To obtain the best performance for a backup, follow these steps:

1. Remove the `RATE` parameter for channel settings as described in "[Removing the RATE Parameter from Channel Settings](#) (page 23-15)".
2. If your disk does not support asynchronous I/O, then set the `DBWR_IO_SLAVES` parameter as described in "[Setting DBWR_IO_SLAVES to Simulate Asynchronous I/O](#) (page 23-15)".
3. Set the `LARGE_POOL_SIZE` parameter as described in "[Setting LARGE_POOL_SIZE to Resolve Shared Memory Issues](#) (page 23-16)".
4. Remove bottlenecks that affect backup performance as described in "[Tuning the Read, Write, and Copy Phases](#) (page 23-17)".

23.4.1 Removing the RATE Parameter from Channel Settings

The `RATE` parameter on a channel is intended to reduce, rather than increase, backup throughput so that more disk bandwidth is available for other database operations. If the backup is not streaming to tape, then confirm that the `RATE` parameter is not set.

To remove the RATE parameter:

1. Examine your backup script.
2. Do one of the following:
 - If the backup is in a `RUN` command, then remove the `RATE` parameter, if it is specified, from the `ALLOCATE` command. Skip the remaining steps.
 - If the backup is not in a `RUN` command, then start RMAN, connect to the target database, and proceed to the next step.
3. Execute the `SHOW ALL` command to show the currently configured settings.
4. Remove the `RATE` parameter, if it is set, from the `CONFIGURE CHANNEL` command.

Note:

"[RATE Channel Parameter](#) (page 23-6)"

23.4.2 Setting DBWR_IO_SLAVES to Simulate Asynchronous I/O

Some operating systems support native asynchronous I/O. If and only if your disk does *not* support asynchronous I/O, then set `DBWR_IO_SLAVES`. Any nonzero value

for `DBWR_IO_SLAVES` causes a fixed number of disk I/O slaves to be used for backup and restore, which simulates asynchronous I/O.

To enable disk I/O slaves:

1. Start SQL*Plus and connect to the target database.
2. Shut down the database.
3. Set `DBWR_IO_SLAVES` initialization parameter to a nonzero value.

This setting enables the database writer processes to use slaves. Thus, you may need to increase the value of the `PROCESSES` initialization parameter.

4. Restart the database.
5. Restart the RMAN backup.

See Also:

["Synchronous and Asynchronous Disk I/O \(page 23-5\)"](#)

23.4.3 Setting `LARGE_POOL_SIZE` to Resolve Shared Memory Issues

Set the `LARGE_POOL_SIZE` initialization parameter if the database reports an error in the alert log stating that it does not have enough memory and that it cannot start I/O slaves. The message resembles the following:

```
ksfqxcrc: failure to allocate shared memory means sync I/O will be used whenever
async I/O to file not supported natively
```

The large pool is used for RMAN and for other purposes, so its total size must accommodate all uses. This is especially true if `DBWR_IO_SLAVES` has been set and the DBWR process needs buffers.

To set the large pool size:

1. Start SQL*Plus and connect to the target database.
2. Optionally, query `V$SGASTAT.POOL` to determine in which pool (shared pool or large pool) the memory for an object resides.
3. Set the `LARGE_POOL_SIZE` initialization parameter in the target database.

You can execute an `ALTER SYSTEM SET` statement to set the parameter dynamically. The formula for setting `LARGE_POOL_SIZE` is as follows:

$$\text{LARGE_POOL_SIZE} = \text{number_of_allocated_channels} * (16 \text{ MB} + (4 * \text{size_of_tape_buffer}))$$

4. Restart the RMAN backup.

See Also:

Oracle Database Concepts for more information about the large pool and *Oracle Database Reference* for complete information about initialization parameters

23.4.4 Tuning the Read, Write, and Copy Phases

There are several tasks that you can perform to identify and remedy bottlenecks that affect backup performance. This includes the following tasks:

- [Using Backup Validation To Distinguish Between Read and Write Bottlenecks](#) (page 23-17)
- [Tuning the Read Phase](#) (page 23-17)
- [Tuning the Copy and Write Phases](#) (page 23-18)

23.4.4.1 Using Backup Validation To Distinguish Between Read and Write Bottlenecks

One reliable way to determine whether the output device or input disk I/O is the bottleneck in a given backup job is to compare the time required to run backup tasks with the time required to run `BACKUP VALIDATE` of the same tasks. `BACKUP VALIDATE` of a backup performs the same disk reads as a real backup but performs no I/O to an output device.

To compare backup and validation times:

1. Ensure your NLS environment date format variable is set to show the time. For example, set the NLS variables as follows:

```
setenv NLS_LANG AMERICAN_AMERICA.WE8DEC;
setenv NLS_DATE_FORMAT "MM/DD/YYYY HH24:MI:SS"
```

2. Edit your backup script to use the `BACKUP VALIDATE` command instead of the `BACKUP` command.
3. Run the backup script.
4. Examine the RMAN output and calculate the difference between the times displayed in the `Starting backup at` and `Finished backup at` messages.
5. Edit the backup script to use the `BACKUP` command instead of the `BACKUP VALIDATE` command.
6. Run the backup script.
7. Examine the RMAN output and calculate the difference between the times displayed in the `Starting backup at` and `Finished backup at` messages.
8. Compare the backup times for the validation and real backup.

If the time for the `BACKUP VALIDATE` to tape is about the same as the time for a real backup to tape, then reading from disk is the likely bottleneck. See "[Tuning the Read Phase](#) (page 23-17)".

If the time for the `BACKUP VALIDATE` to tape is significantly less than the time for a real backup to tape, then writing to the output device is the likely bottleneck. See "[Tuning the Copy and Write Phases](#) (page 23-18)".

23.4.4.2 Tuning the Read Phase

RMAN may not be able to send data blocks to the output device fast enough to keep it occupied. For example, during an [incremental backup](#), RMAN only backs up blocks

changed since a previous data file backup as part of the same strategy. If you do not turn on [block change tracking](#), then RMAN must scan whole data files for changed blocks, and fill output buffers as it finds such blocks. If few blocks changed, and if RMAN is making an SBT backup, then RMAN may not fill output buffers fast enough to keep the tape drive streaming.

You can improve backup performance by adjusting the [level of multiplexing](#), which is number of input files simultaneously read and then written into the same RMAN backup piece. The level of multiplexing is the minimum of the `MAXOPENFILES` setting on the channel and the number of input files placed in each backup set. The following table makes recommendations for adjusting the level of multiplexing.

Table 23-4 Adjusting the Level of Multiplexing

ASM	Striped Disk	Recommendation
No	Yes	Increase the level of multiplexing. Determine which is the minimum, <code>MAXOPENFILES</code> or the number of files in each backup set, and then increase this value. In this way, you increase the rate at which RMAN fills tape buffers, which makes it more likely that buffers are sent to the media manager fast enough to maintain streaming.
No	No	Increase the <code>MAXOPENFILES</code> setting on the channel.
Yes	Not applicable	Set the <code>MAXOPENFILES</code> parameter on the channel to 1 or 2.

See Also:

- ["About Multiplexed RMAN Backup Sets \(page 8-8\)"](#) to learn how the `MAXOPENFILES` and `FILESPERSET` settings affect the level of multiplexing
 - ["About RMAN Incremental Backups \(page 8-17\)"](#) for a conceptual overview
-
-

23.4.4.3 Tuning the Copy and Write Phases

If the read phase is performing well, then the copy or write phases are probably the bottleneck. In particular, if RMAN is sending data blocks to the tape drive fast enough to support streaming, but the tape is not streaming, then the SBT write phase is the bottleneck.

Try to improve performance using one of the following techniques:

Table 23-5 Techniques for Improving Copy and Write Performance

Technique	Description	Additional Informaiton
If the backup is a full backup , then consider using incremental backups	Incremental level 1 backups write only the changed blocks from data files to tape, so that any bottleneck on writing to tape has less impact on your overall backup strategy. In particular, if tape drives are not locally attached to the node of the database being backed up, then incremental backups can be faster. .	" Making and Updating RMAN Incremental Backups (page 9-33)"
If the backup uses the basic compression algorithm, then consider using the Oracle Advanced Compression option		<ul style="list-style-type: none"> • "Configuring Compression Options (page 6-7)" • "About Binary Compression for RMAN Backup Sets (page 8-5)"
If the database host uses multiple CPUs, and if the backup uses binary compression, then increase the number of channels		
If the backup is encrypted, then change the encryption algorithm to AES128	The AES128 algorithm is the least CPU-intensive algorithm.	" Configuring the Backup Encryption Algorithm (page 6-13)"
(For tape backups only) Adjust the size of the tape I/O buffers	Use the <code>PARMS</code> and <code>BLKSIZE</code> parameters of the <code>ALLOCATE CHANNEL</code> or <code>CONFIGURE CHANNEL</code> command to set the size. The size of the tape I/O buffers is platform-dependent. The <code>BLKSIZE</code> setting overrides the default.	
(For tape backups only) Adjust settings in the media management software	Some media manager settings, including the tape block size, may affect backup performance.	
If RMAN is backing up files to ASM, then increase the number of channels	For example, if RMAN is backing up the database to a single disk group with 16 physical disks, then allocate or configure at least 4 disk channels, up to a maximum of 16.	

Troubleshooting RMAN Operations

This chapter describes how to troubleshoot Recovery Manager. This chapter contains the following topics:

- [Interpreting RMAN Message Output](#) (page 24-1)
- [Using V\\$ Views for RMAN Troubleshooting](#) (page 24-8)
- [Testing the Media Management API](#) (page 24-12)
- [Terminating an RMAN Command](#) (page 24-14)

24.1 Interpreting RMAN Message Output

Recovery Manager provides detailed error messages that can aid in troubleshooting problems. Also, Oracle Database and the third-party media vendors generate useful debugging output of their own. The following discussion explains how to identify and interpret the different errors that you may encounter.

24.1.1 Identifying Types of RMAN Message Output

Output that is useful for troubleshooting failed or unresponsive RMAN jobs is located in several different places, as explained in [Table 24-1](#) (page 24-1).

Table 24-1 *Types of Message Output*

Type of Output	Produced By	Location	Description
RMAN messages	RMAN	<p>Completed job information is in <code>V \$RMAN_STATUS</code> and <code>RC_RMAN_STATUS</code>. Current job information is in <code>V \$RMAN_OUTPUT</code>.</p> <p>When running RMAN from the command line, you can direct output to the following places:</p> <ul style="list-style-type: none"> • Standard output • A log file specified by <code>LOG</code> on the command line or the <code>SPOOL LOG</code> command • A file created by redirecting RMAN output (for example, in UNIX, using the <code>></code> operator) 	<p>Contains actions relevant to the RMAN job and error messages generated by RMAN, the database server, and the media vendor. RMAN error messages have an <code>RMAN-</code> prefix. Normal action descriptions do not have a prefix.</p> <p>You can execute the following PL/SQL to remove all entries from <code>V \$RMAN_STATUS</code>:</p> <pre>update node set high_rsr_recid=0 where db_key = our_target_database_db_key ;</pre> <p>The preceding function removes all job-related entries. No rows are visible until new backup jobs are shown in <code>V \$RMAN_BACKUP_JOB_DETAILS</code>.</p>

Table 24-1 (Cont.) Types of Message Output

Type of Output	Produced By	Location	Description
alert_ <i>SID</i> .log	Oracle Database	The alert subdirectory of the Automatic Diagnostic Repository (ADR) home	Contains a chronological log of errors, initialization parameter settings, and administration operations. Records values for overwritten control file records.
Oracle trace file	Oracle Database	The trace subdirectory of the ADR home	Contains detailed output generated by Oracle Database processes. This file is created when an ORA-600 or ORA-3113 error message occurs, whenever RMAN cannot allocate a channel, and when the database fails to load the media management library.
sbtio.log	Third-party media management software	The trace subdirectory of the ADR home	Contains vendor-specific information written by the media management software. This log does not contain Oracle Database or RMAN errors.
Media manager log file	Third-party media management software	The file names for any media manager logs other than sbtio.log are determined by the media management software.	Contains information about the functioning of the media management device

24.1.2 Recognizing RMAN Error Message Stacks

RMAN reports errors as they occur. If an error is not retrievable, that is, if RMAN cannot perform failover to another channel to complete a particular job step, then RMAN also reports a summary of the errors after all job sets complete. This feature is known as deferred error reporting.

One way to determine whether RMAN encountered an error is to examine its return code, as described in "[Identifying RMAN Return Codes](#) (page 24-8)". A second way is to search the RMAN output for the string RMAN-00569, which is the message number for the error stack banner. All RMAN errors are preceded by this error message. If you do not see an RMAN-00569 message in the output, then there are no errors. [Example 24-1](#) (page 24-2) shows a syntax error.

Example 24-1 RMAN Syntax Error

```

RMAN-00571: =====
RMAN-00569: ===== ERROR MESSAGE STACK FOLLOWS =====
RMAN-00571: =====
RMAN-00558: error encountered while parsing input commands
RMAN-01005: syntax error: found "): expecting one of: "archivelog, backup,
  backupset, controlfilecopy, current, database, datafile, datafilecopy, (, plus, i,
  tablespace"
RMAN-01007: at line 1 column 18 file: standard input

```

24.1.3 Identifying RMAN Error Codes

Typically, you find the following types of error codes in RMAN message stacks:

- Errors prefixed with RMAN-

These are RMAN errors.

- Errors prefixed with `ORA-`
Media manager errors use the `ORA-` prefix.
- Errors preceded by the line `Additional information:`

See Also:

- [RMAN Error Message Numbers](#) (page 24-3) for the error ranges of RMAN errors
 - [ORA-19511: Media Manager Errors](#) (page 24-4) for the error ranges of media manager errors
 - *Oracle Database Error Messages* for explanations of RMAN and ORA error codes
-
-

24.1.3.1 RMAN Error Message Numbers

The following table indicates the error ranges for common RMAN error messages, all of which are described in *Oracle Database Error Messages*.

Table 24-2 RMAN Error Message Ranges

Error Range	Cause
0550-0999	Command-line interpreter
1000-1999	Keyword analyzer
2000-2999	Syntax analyzer
3000-3999	Main layer
4000-4999	Services layer
5000-5499	Compilation of <code>RESTORE</code> or <code>RECOVER</code> command
5500-5999	Compilation of <code>DUPLICATE</code> command
6000-6999	General compilation
7000-7999	General execution
8000-8999	PL/SQL programs
9000-9999	Low-level keyword analyzer
10000-10999	Server-side execution
11000-11999	Interphase errors between PL/SQL and RMAN
12000-12999	Recovery catalog packages

24.1.3.2 ORA-19511: Media Manager Errors

If a media manager error occurs, ORA-19511 is signaled, and the media manager is expected to provide RMAN a descriptive error. RMAN displays the error passed back to it by the media manager. For example, you might see this:

```
ORA-19511: Error received from media manager layer, error text:
  sbtpvt_open_input: file .* does not exist or cannot be accessed, errno = 2
```

The message from the media manager should provide you with enough information to let you fix the root problem. If it does not, then refer to the documentation for your media manager or contact your media management vendor support representative for further information. ORA-19511 errors originate with the media manager, not with Oracle Database. The database just passes on the message from the media manager. The cause can be addressed only by the media management vendor.

If you are still using an [SBT 1.1-compliant media management layer](#), you may see some additional error message text. Output from an SBT 1.1-compliant media management layer is similar to the following:

```
ORA-19507: failed to retrieve sequential file, handle="c-140148591-20031014-06",
parms=""
ORA-27007: failed to open file
Additional information: 7000
Additional information: 2
ORA-19511: Error received from media manager layer, error text:
  SBT error = 7000, errno = 0, sbtopen: backup file not found
```

The "Additional information" provided uses error codes specific to SBT 1.1. The values displayed correspond to the media manager message numbers and error text listed in [Table 24-3](#) (page 24-5). RMAN again signals the error, as an ORA-19511 Error received from media manager layer error, and a general error message related to the error code returned from the media manager and including the SBT 1.1 error number is then displayed.

The SBT 1.1 error messages are listed here for your reference. [Table 24-3](#) (page 24-5) lists media manager message numbers and their corresponding error text. In the error codes, *O/S* stands for *operating system*. The errors marked with an asterisk (*) are internal and are not typically seen during normal operation.

Table 24-3 Media Manager Error Message Ranges

Cause	No.	Message
sbtopen	7000	Backup file not found (only returned for read)
	7001	File exists (only returned for write)
	7002*	Bad mode specified
	7003	Invalid block size specified
	7004	No tape device found
	7005	Device found, but busy; try again later
	7006	Tape volume not found
	7007	Tape volume is in-use
	7008	I/O Error
	7009	Can't connect with Media Manager
	7010	Permission denied
	7011	O/S error for example malloc, fork error
	7012*	Invalid argument(s) to sbtopen
sbtclose	7020*	Invalid file handle or file not open
	7021*	Invalid flags to sbtclose
	7022	I/O error
	7023	O/S error
	7024*	Invalid argument(s) to sbtclose
	7025	Can't connect with Media Manager
sbtwrite	7040*	Invalid file handle or file not open
	7041	End of volume reached
	7042	I/O error
	7043	O/S error
	7044*	Invalid argument(s) to sbtwrite
sbtread	7060*	Invalid file handle or file not open
	7061	EOF encountered
	7062	End of volume reached
	7063	I/O error
	7064	O/S error
	7065*	Invalid argument(s) to sbtread
sbtremove	7080	Backup file not found
	7081	Backup file in use
	7082	I/O Error
	7083	Can't connect with Media Manager
	7084	Permission denied
	7085	O/S error
	7086*	Invalid argument(s) to sbtremove

Table 24-3 (Cont.) Media Manager Error Message Ranges

Cause	No.	Message
sbtinfo	7090	Backup file not found
	7091	I/O Error
	7092	Can't connect with Media Manager
	7093	Permission denied
	7094	O/S error
	7095*	Invalid argument(s) to sbtinfo
sbtinit	7110*	Invalid argument(s) to sbtinit
	7111	O/S error

24.1.4 Interpreting RMAN Error Stacks

It is important to identify the relevant messages in the RMAN error stack.

Note the following tips and suggestions while interpreting RMAN messages:

- Read the messages from the bottom up, because this is the order in which RMAN issues the messages. The last one or two errors displayed in the stack are often the most informative.
- When you are using an SBT 1.1 media management layer and you are presented with SBT 1.1 style error messages containing the "Additional information:" numeric error codes, look for the ORA-19511 message that follows for the text of error messages passed back to RMAN by the media manager. These messages identify the real failure in the media management layer.
- Look for the RMAN-03002 or RMAN-03009 message (RMAN-03009 equals RMAN-03002 but includes the channel ID), immediately following the error banner. These messages indicate which command failed. Syntax errors generate RMAN-00558.
- Identify the basic type of error according to the error range chart in [Table 24-2](#) (page 24-3) and then refer to the error messages for information about the most important messages.

See Also:

- [Interpreting RMAN Errors: Example](#) (page 24-6) and [Interpreting Server Errors: Example](#) (page 24-7) for examples of RMAN error messages
 - [Interpreting SBT 2.0 Media Management Errors: Example](#) (page 24-7) and [Interpreting SBT 1.1 Media Management Errors: Example](#) (page 24-8) for examples of interpreting media management errors
 - *Oracle Database Error Messages* for information about the error messages
-
-

24.1.4.1 Interpreting RMAN Errors: Example

You attempt a backup of tablespace users and receive the following message:

```

Starting backup at 29-AUG-13
using channel ORA_DISK_1
RMAN-00571: =====
RMAN-00569: ===== ERROR MESSAGE STACK FOLLOWS =====
RMAN-00571: =====
RMAN-03002: failure of backup command at 08/29/2013 15:14:03
RMAN-20202: tablespace not found in the recovery catalog
RMAN-06019: could not translate tablespace name "USESR"

```

The RMAN-03002 error indicates that the BACKUP command failed. You read the last two messages in the stack first and immediately see the problem: no tablespace `usersr` appears in the recovery catalog because you mistyped the name as `usersr`.

24.1.4.2 Interpreting Server Errors: Example

Assume that you attempt to recover a tablespace and receive the following errors:

```

RMAN> RECOVER TABLESPACE users;

Starting recover at 29-AUG-13
using channel ORA_DISK_1

starting media recovery
media recovery failed
RMAN-00571: =====
RMAN-00569: ===== ERROR MESSAGE STACK FOLLOWS =====
RMAN-00571: =====
RMAN-03002: failure of recover command at 08/29/2013 15:18:43
RMAN-11003: failure during parse/execution of SQL statement: alter database recover
if needed tablespace USERS
ORA-00283: recovery session canceled due to errors
ORA-01124: cannot recover data file 8 - file is in use or recovery
ORA-01110: data file 8: '/oracle/oradata/trgt/users01.dbf'

```

As suggested, you start reading from the bottom up. The ORA-01110 message explains there was a problem with the recovery of data file `users01.dbf`. The second error indicates that the database cannot recover the data file because it is in use or being recovered. The remaining RMAN errors indicate that the recovery session was canceled due to the server errors. Hence, you conclude that because you were not recovering this data file, the problem must be that the data file is online and you must take it offline and restore a backup.

24.1.4.3 Interpreting SBT 2.0 Media Management Errors: Example

Assume that you use a tape drive and see the following output during a backup job:

```

RMAN-00571: =====
RMAN-00569: ===== ERROR MESSAGE STACK FOLLOWS =====
RMAN-00571: =====
ORA-19624: operation failed, retry possible
ORA-19507: failed to retrieve sequential file, handle="/tmp/mydir", parms=""
ORA-27029: skgfrtrv: sbtrestore returned error
ORA-19511: Error received from media manager layer, error text:
  sbtpvt_open_input:file /tmp/mydir does not exist or cannot be accessed, errno=2

```

The error text displayed following the ORA-19511 error is generated by the media manager and describes the real source of the failure. See the media manager documentation to interpret this error.

24.1.4.4 Interpreting SBT 1.1 Media Management Errors: Example

Assume that you use a tape drive and see the following output during a backup job:

```

RMAN-00571: =====
RMAN-00569: ===== ERROR MESSAGE STACK FOLLOWS =====
RMAN-00571: =====
RMAN-03009: failure of backup command on c1 channel at 09/04/2013 13:18:19
ORA-19506: failed to create sequential file, name="07d36ecp_1_1", parms=""
ORA-27007: failed to open file
SVR4 Error: 2: No such file or directory
Additional information: 7005
Additional information: 1
ORA-19511: Error received from media manager layer, error text:
      SBT error = 7005, errno = 2, sbtopen: system error

```

The main information of interest returned by SBT 1.1 media managers is the error code in the "Additional information" line:

```
Additional information: 7005
```

Referring to [Table 24-3](#) (page 24-5), you discover that error 7005 means that the media management device is busy. So, the media management software is not able to write to the device because it is in use or there is a problem with it.

Note:

The `sbtio.log` contains information written by the media management software, *not* Oracle Database. Thus, you must consult your media vendor documentation to interpret the error codes and messages. If no information is written to the `sbtio.log`, then contact your media manager support to ask whether they are writing error messages in some other location, or whether there are steps you must take to have the media manager errors appear in `sbtio.log`.

24.1.5 Identifying RMAN Return Codes

One way to determine whether RMAN encountered an error is to examine its return code or exit status. The RMAN client returns 0 to the shell from which it was invoked if no errors occurred, and a nonzero error value otherwise.

How you access this return code depends upon the environment from which you invoked the RMAN client. For example, if you run UNIX with the C shell, then, when RMAN completes, the return code is placed in a shell variable called `$status`. The method of returning exit status is a detail specific to the host operating system rather than the RMAN client.

24.2 Using V\$ Views for RMAN Troubleshooting

When `LIST`, `REPORT`, and `SHOW` do not provide all the information that you need for RMAN operations, some V\$ views can provide useful details.

Sometimes it is useful to identify exactly what a server session performing a backup and recovery job is doing. The views described in [Table 24-4](#) (page 24-9) are useful for obtaining information about RMAN jobs.

Table 24-4 Useful V\$ Views for Troubleshooting

View	Description
V\$PROCESS	Identifies currently active processes
V\$SESSION	Identifies currently active sessions. Use this view to determine which database server sessions correspond to which RMAN allocated channels.
V\$SESSION_WAIT	Lists the events or resources for which sessions are waiting

You can use the preceding views to perform the following tasks:

- [Monitoring RMAN Interaction with the Media Manager](#) (page 24-9)
- [Correlating Server Sessions with RMAN Channels](#) (page 24-10)

24.2.1 Monitoring RMAN Interaction with the Media Manager

You can use the event names in the dynamic performance event views to monitor RMAN calls to the media management API. The event names have one-to-one correspondence with SBT functions, as shown in the following examples:

```
Backup: MML v1 open backup piece
Backup: MML v1 read backup piece
Backup: MML v1 write backup piece
Backup: MML v1 query backup piece
Backup: MML v1 delete backup piece
Backup: MML v1 close backup piece
.
.
.
```

To obtain the complete list of SBT events, you can use the following query:

```
SELECT NAME
FROM   V$EVENT_NAME
WHERE  NAME LIKE '%MML%';
```

Before making a call to any of functions in the media management API, the server adds a row in V\$SESSION_WAIT, with the STATE column including the string WAITING. The V\$SESSION_WAIT.SECONDS_IN_WAIT column shows the number of seconds that the server has been waiting for this call to return. After an SBT function is returned from the media manager, this row disappears.

A row in V\$SESSION_WAIT corresponding to an SBT event name does not indicate a problem, because the server updates these rows at run time. The rows appear and disappear as calls are made and returned. However, if the SECONDS_IN_WAIT column is high, then the media manager may be suspended.

To monitor the SBT events, you can run the following SQL query:

```
COLUMN EVENT FORMAT a17
COLUMN SECONDS_IN_WAIT FORMAT 999
COLUMN STATE FORMAT a15
COLUMN CLIENT_INFO FORMAT a30

SELECT p.SPID, s.EVENT, s.SECONDS_IN_WAIT AS SEC_WAIT,
       sw.STATE, s.CLIENT_INFO
```

```

FROM   V$SESSION_WAIT sw, V$SESSION s, V$PROCESS p
WHERE  sw.EVENT LIKE '%MML%'
AND    s.SID=sw.SID
AND    s.PADDR=p.ADDR;

```

Examine the SQL output to determine which SBT functions are waiting. For example, the following output indicates that RMAN has been waiting for the `sbtbackup` function to return for 10 minutes:

SPID	EVENT	SEC_WAIT	STATE	CLIENT_INFO
8642	Backup: MML creat	600	WAITING	rman channel=ORA_SBT_TAPE_1

Note:

The `V$SESSION_WAIT` view shows only database events, not media manager events.

See Also:

Oracle Database Reference for descriptions of the `V$SESSION_WAIT` view.

24.2.2 Correlating Server Sessions with RMAN Channels

To identify which server sessions correspond to which RMAN channels, you can query `V$SESSION` and `V$PROCESS`. The `SPID` column of `V$PROCESS` identifies the operating system ID number for the process or thread. For example, on UNIX the `SPID` column shows the process ID, whereas on Windows the `SPID` column shows the thread ID. You have two basic methods for obtaining this information, depending on whether you have multiple RMAN sessions active concurrently.

This section contains the following topics:

- [Matching Server Sessions with Channels When One RMAN Session Is Active](#) (page 24-10)
- [Matching Server Sessions with Channels in Multiple RMAN Sessions](#) (page 24-11)

24.2.2.1 Matching Server Sessions with Channels When One RMAN Session Is Active

When only one RMAN session is active, the easiest method for determining the server session ID for an RMAN channel is to execute the following query on the target database while the RMAN job is executing:

```

COLUMN CLIENT_INFO FORMAT a30
COLUMN SID FORMAT 999
COLUMN SPID FORMAT 9999

SELECT s.SID, p.SPID, s.CLIENT_INFO
FROM   V$PROCESS p, V$SESSION s
WHERE  p.ADDR = s.PADDR
AND    CLIENT_INFO LIKE 'rman%';

```

The following shows sample output:

```

SID SPID          CLIENT_INFO
-----
14 8374          rman channel=ORA_SBT_TAPE_1

```

If you set an ID using the RMAN SET COMMAND ID command instead of using the system-generated default ID, then search for that value in the CLIENT_INFO column instead of 'rman%'.

24.2.2.2 Matching Server Sessions with Channels in Multiple RMAN Sessions

If multiple RMAN sessions are active, then the V\$SESSION.CLIENT_INFO column can yield the same information for a channel in each session. For example:

```

SID SPID          CLIENT_INFO
-----
14 8374          rman channel=ORA_SBT_TAPE_1
 9 8642          rman channel=ORA_SBT_TAPE_1

```

In this case, you have the following methods for determining which channel corresponds to which SID value.

24.2.2.2.1 Obtaining the Channel ID from the RMAN Output

In this method, you must first obtain the sid values from the RMAN output and then use these values in your SQL query.

To correlate a process with a channel during a backup:

1. In an active session, run the RMAN job as usual and examine the output to get the SID for the channel. For example, the output may show:

```

Starting backup at 21-AUG-13
allocated channel: ORA_SBT_TAPE_1
channel ORA_SBT_TAPE_1: sid=14 devtype=SBT_TAPE

```

2. Start a SQL*Plus session and then query the joined V\$SESSION and V\$PROCESS views *while the RMAN job is executing*. For example, enter:

```

COLUMN CLIENT_INFO FORMAT a30
COLUMN SID FORMAT 999
COLUMN SPID FORMAT 9999

SELECT s.SID, p.SPID, s.CLIENT_INFO
FROM   V$PROCESS p, V$SESSION s
WHERE  p.ADDR = s.PADDR
AND    CLIENT_INFO LIKE 'rman%'
/

```

Use the sid value obtained from the first step to determine which channel corresponds to which server session:

```

          SID SPID          CLIENT_INFO
          -----
          14 2036          rman channel=ORA_SBT_TAPE_1
          12 2066          rman channel=ORA_SBT_TAPE_1

```

24.2.2.2.2 Correlating Server Sessions with Channels by Using SET COMMAND ID

In this method, you specify a command ID string in the RMAN backup script. You can then query V\$SESSION.CLIENT_INFO for this string.

To correlate a process with a channel during a backup:

1. In each session, set the `COMMAND ID` to a different value *after* allocating the channels and then back up the desired object. For example, enter the following in session 1:

```
RUN
{
  ALLOCATE CHANNEL c1 TYPE disk;
  SET COMMAND ID TO 'sess1';
  BACKUP DATABASE;
}
```

Set the command ID to a string such as `sess2` in the job running in session 2:

```
RUN
{
  ALLOCATE CHANNEL c1 TYPE sbt;
  SET COMMAND ID TO 'sess2';
  BACKUP DATABASE;
}
```

2. Start a SQL*Plus session and then query the joined `V$SESSION` and `V$PROCESS` views *while the RMAN job is executing*. For example, enter:

```
SELECT SID, SPID, CLIENT_INFO
FROM   V$PROCESS p, V$SESSION s
WHERE  p.ADDR = s.PADDR
AND    CLIENT_INFO LIKE '%id=sess%';
```

If you run the `SET COMMAND ID` command in the RMAN job, then the `CLIENT_INFO` column displays in the following format:

```
id=command_id,rman channel=channel_id
```

For example, the following shows sample output:

SID	SPID	CLIENT_INFO
11	8358	id=sess1
15	8638	id=sess2
14	8374	id=sess1,rman channel=c1
9	8642	id=sess2,rman channel=c1

The rows that contain the string `rman channel` show the channel performing the backup. The remaining rows are for the connections to the target database.

See Also:

Oracle Database Backup and Recovery Reference for `SET COMMAND ID` syntax, and *Oracle Database Reference* for more information about `V$SESSION` and `V$PROCESS`

24.3 Testing the Media Management API

On some platforms, Oracle provides a diagnostic tool called `sbtttest`. This utility performs a simple test of the media management software by acting as the Oracle database server and attempting to communicate with the media manager.

This section contains the following topics:

- [Obtaining the sbtttest Utility](#) (page 24-13)

- [Obtaining Online Documentation for the sbttest Utility](#) (page 24-13)
- [Using the sbttest Utility](#) (page 24-13)

24.3.1 Obtaining the sbttest Utility

On UNIX, the `sbttest` utility is typically located in `$ORACLE_HOME/bin`. If for some reason the utility is not included with your platform, then contact Oracle Support Services to obtain the C version of the program. You can compile this version of the program on all UNIX platforms.

On platforms such as Solaris, you do not have to relink when using `sbttest`. On other platforms, relinking may be necessary.

24.3.2 Obtaining Online Documentation for the sbttest Utility

For online documentation of `sbttest`, issue the following on the command line:

```
% sbttest
```

The program displays the list of possible arguments for the program:

```
Error: backup file name must be specified
Usage: sbttest backup_file_name # this is the only required parameter
      <-dbname database_name>
      <-trace trace_file_name>
      <-remove_before>
      <-no_remove_after>
      <-read_only>
      <-no_regular_backup_restore>
      <-no_proxy_backup>
      <-no_proxy_restore>
      <-file_type n>
      <-copy_number n>
      <-media_pool n>
      <-os_res_size n>
      <-pl_res_size n>
      <-block_size block_size>
      <-block_count block_count>
      <-proxy_file os_file_name bk_file_name
              [os_res_size pl_res_size block_size block_count]>
      <-libname sbt_library_name>
```

The display also indicates the meaning of each argument. For example, following is the description for two optional parameters:

Optional parameters:

- dbname specifies the database name which will be used by SBT to identify the backup file. The default is "sbtddb"
- trace specifies the name of a file where the Media Management software will write diagnostic messages.

24.3.3 Using the sbttest Utility

Use `sbttest` to perform a quick test of the media manager.

If `sbttest` returns 0, then the test ran without error, which means that the media manager is correctly installed and can accept a data stream and return the same data when requested. If `sbttest` returns a nonzero value, then either the media manager is not installed or it is not configured correctly.

To use sbttest:

1. Confirm that the program is installed and included in the system path by typing `sbttest` at the command line:

```
% sbttest
```

If the program is operational, then you see a display of the online documentation.

2. Execute the program, specifying any of the arguments described in the online documentation. For example, enter the following to create test file `some_file.f` and write the output to `sbtio.log`:

```
% sbttest some_file.f -trace sbtio.log
```

You can also test a backup of an existing data file. For example, this command tests data file `tbs_33.f` of database `prod`:

```
% sbttest tbs_33.f -dbname prod
```

3. Examine the output. If the program encounters an error, then it provides messages describing the failure. For example, if the database cannot find the library, you see:

```
libobk.so could not be loaded. Check that it is installed properly, and that
LD_LIBRARY_PATH environment variable (or its equivalent on your platform)
includes the directory where this file can be found. Here is some additional
information on the cause of this error:
ld.so.1: sbttest: fatal: libobk.so: open failed: No such file or directory
```

In some cases, `sbttest` can work but an RMAN backup does not. The reasons can be the following:

- The user who starts `sbttest` is not the owner of the Oracle Database processes.
- If the database server is not linked with the media management library or cannot load it dynamically when needed, then RMAN backups to the media manager fail, but `sbttest` may still work.
- The `sbttest` program passes all environment parameters from the shell but RMAN does not.

24.4 Terminating an RMAN Command

There are several ways to terminate an RMAN command in the middle of execution:

- The preferred method is to press Ctrl+C (or the equivalent "attention" key combination for your system) in the RMAN interface. This also terminates allocated channels, unless they are suspended in the media management code, as happens when, for example, they are waiting for a tape to be mounted.
- You can end the server session corresponding to the RMAN channel by running the SQL `ALTER SYSTEM KILL SESSION` statement as described in [Terminating the Session with ALTER SYSTEM KILL SESSION](#) (page 24-15).
- You can terminate the server session corresponding to the RMAN channel on the operating system as described in [Terminating the Session at the Operating System Level](#) (page 24-15).

24.4.1 Terminating the Session with ALTER SYSTEM KILL SESSION

You can identify the Oracle session ID for an RMAN channel by looking in the RMAN log for messages with the format shown in the following example:

```
channel chl: sid=15 devtype=SBT_TAPE
```

The `sid` and `devtype` are displayed for each allocated channel. The Oracle Database `sid` is different from the operating system process ID. You can end the session using a SQL `ALTER SYSTEM KILL SESSION` statement.

`ALTER SYSTEM KILL SESSION` takes two arguments, the `sid` printed in the RMAN message and a serial number, both of which can be obtained by querying `V$SESSION`. For example, run the following statement, where `sid_in_rman_output` is the number from the RMAN message:

```
SELECT SERIAL#
FROM   V$SESSION
WHERE  SID=sid_in_rman_output;
```

Then, run the following statement, substituting the `sid_in_rman_output` and serial number obtained from the query:

```
ALTER SYSTEM KILL SESSION 'sid_in_rman_output,serial#';
```

This statement has no effect on the session if the session stopped in media manager code.

24.4.2 Terminating the Session at the Operating System Level

Finding and terminating the processes that are associated with the server sessions is operating system-specific. On some platforms, the server sessions are not associated with any processes at all. See your operating system-specific documentation for more information.

24.4.3 Terminating an RMAN Session That Is Not Responding in the Media Manager

You may sometimes need to terminate an RMAN job that is not responding in the media manager. The best way to terminate RMAN when the channel connections are not responding in the media manager is to terminate the session in the media manager. If this action does not solve the problem, then on some platforms, such as Linux, you may be able to terminate the Oracle Database processes of the connections. (Terminating the Oracle processes may cause problems with the media manager. See your media manager documentation for details.)

This section contains the following topics:

- [Components of an RMAN Session](#) (page 24-15)
- [Process Behavior During a Suspended Job](#) (page 24-16)
- [Terminating an RMAN Session: Basic Steps](#) (page 24-16)

24.4.3.1 Components of an RMAN Session

The nature of an RMAN session depends on the operating system. In UNIX, an RMAN session has the following processes associated with it:

- The *RMAN client process* itself

- The *default channel*, the initial connection to the target database
- One *target connection* to the target database corresponding to each allocated channel
- The *catalog connection* to the recovery catalog database, if you use a recovery catalog
- An *auxiliary connection* to an auxiliary instance, during `DUPLICATE` or `TSPITR` operations
- A *polling connection* to the target database, used for monitoring RMAN command execution on the various allocated channels. By default, RMAN makes one polling connection. RMAN makes additional polling connections if you use different connect strings in the `ALLOCATE CHANNEL` or `CONFIGURE CHANNEL` commands. One polling connection exists for each distinct connect string used in the `ALLOCATE CHANNEL` or `CONFIGURE CHANNEL` command.

24.4.3.2 Process Behavior During a Suspended Job

RMAN usually stops responding because a channel connection is waiting in the media manager code for a tape resource. The catalog connection and the default channel appear to suspend, because they are waiting for RMAN to tell them what to do. Polling connections seem to be in an infinite loop while polling the RPC under the control of the RMAN process.

If you terminate the RMAN process itself, then you also terminate the catalog connection, the auxiliary connection, the default channel, and the polling connections. If target and auxiliary connections are suspended but not while executing media manager code, they also terminate. If either the target connection or any of the auxiliary connections are executing in the media management layer, then they do not terminate until the processes are manually terminated at the operating system level.

Not all media managers can detect the termination of the Oracle Database process. Those which cannot may keep resources busy or continue processing. Consult your media manager documentation for details.

Terminating the catalog connection does not cause the RMAN process to terminate because RMAN is not performing catalog operations while the backup or restore is in progress. Removing default channel and polling connections causes the RMAN process to detect that a channel is no longer present and then to exit. In this case, the connections to the unresponsive channels remain active as described previously.

24.4.3.3 Terminating an RMAN Session: Basic Steps

After the unresponsive channels in the media manager code are terminated, the RMAN process detects this termination and exits, removing all connections except target connections that are still operative in the media management layer. The warning about the media manager resources still applies in this case.

To terminate an Oracle Database process that is not responding in the media manager:

1. Query `V$SESSION` and `V$SESSION_WAIT` as described in "[Using V\\$ Views for RMAN Troubleshooting](#) (page 24-8)". For example, execute the following query:

```
COLUMN EVENT FORMAT a17
COLUMN SECONDS_IN_WAIT FORMAT 999
COLUMN STATE FORMAT a10
COLUMN CLIENT_INFO FORMAT a30
```



```

SELECT p.SPID, s.EVENT, s.SECONDS_IN_WAIT AS SEC_WAIT,
       sw.STATE, s.CLIENT_INFO
FROM   V$SESSION_WAIT sw, V$SESSION s, V$PROCESS p
WHERE  sw.EVENT LIKE '%MML%'
AND    s.SID=sw.SID
AND    s.PADDR=p.ADDR;

```

Examine the SQL output to determine which SBT functions are waiting. For example, the output may be as follows:

SPID	EVENT	SEC_WAIT	STATE	CLIENT_INFO
8642	Backup:MML write	600	WAITING	rman channel=ORA_SBT_TAPE_1
8374	Backup:MML write	600	WAITING	rman channel=ORA_SBT_TAPE_2

- Using operating system-level tools appropriate to your platform, end the unresponsive sessions. For example, on Linux execute a `kill -9` command:

```
% kill -9 8642 8374
```

Some platforms include a command-line utility called `orakill` that enables you to terminate a specific thread. From a command prompt, run the following command, where `sid` identifies the database instance to target, and the `thread_id` is the SPID value from the query in Step 1:

```
orakill sid thread_id
```

- Check that the media manager also clears its processes. If any remain, the next backup or restore operation may freeze again, due to the previous problems in the backup or restore operation. In some media managers, the only solution is to shut down and restart the media manager. If the documentation from the media manager does not provide the needed information, contact technical support for the media manager.

See Also:

Your operating system-specific documentation for the relevant commands

Part VII

Transferring Data with RMAN

The following chapters describe how to use RMAN for database and tablespace transport and migration. This part of the book contains these chapters:

- [Duplicating a Database](#) (page 25-1)
- [Duplicating a Database: Advanced Topics](#) (page 26-1)
- [Creating Transportable Tablespace Sets](#) (page 27-1)
- [Transporting Data Across Platforms](#) (page 28-1)

Duplicating Databases

This chapter describes how to use the `DUPLICATE` command to create an independently functioning database copy.

This chapter contains the following topics:

- [Overview of RMAN Database Duplication](#) (page 25-1)
- [Planning to Duplicate a Database](#) (page 25-15)
- [Preparing the Auxiliary Instance](#) (page 25-23)
- [Duplicating a Database](#) (page 25-29)
- [Duplicating CDBs and PDBs](#) (page 25-38)
- [Restarting DUPLICATE After a Failure](#) (page 25-44)
- [Examples: Duplicating Databases](#) (page 25-45)
- [Example: Script to Duplicate a Database Using Backup-based Duplication](#) (page 25-58)

25.1 Overview of RMAN Database Duplication

Database duplication is the use of the `DUPLICATE` command to copy all or a subset of the data in a source database. The duplicate database (the copied database) functions entirely independently from the source database (the database being copied).

This section contains the following topics:

- [Purpose of Database Duplication](#) (page 25-2)
- [Basic Concepts of Database Duplication](#) (page 25-2)
- [Types of Database Duplication](#) (page 25-5)
- [How RMAN Duplicates a Database](#) (page 25-12)
- [Contents of a Duplicate Database](#) (page 25-13)
- [About the Destination Host for Database Duplication](#) (page 25-14)
- [About Duplicate Database File Names](#) (page 25-14)
- [About Duplicating a Database to a Past Point-in-Time](#) (page 25-14)
- [Prerequisites for Duplicating a Database](#) (page 25-15)

25.1.1 Purpose of Database Duplication

A duplicate database is useful for a variety of purposes, most of which involve testing. You can perform the following tasks in a duplicate database:

- Test backup and recovery procedures
For example, you can duplicate the production database on `host1` to `host2`, and then use the duplicate database on `host2` to practice restoring and recovering this database while the production database on `host1` operates as usual.
- Test an upgrade to a new release of Oracle Database
- Test the effect of applications on database performance
- Create a standby database

You can create a physical standby database or an Oracle Data Guard far sync instance. A standby database is a copy of the primary database that you update continually with archived redo log files from the primary database. If the primary database is inaccessible, then you can fail over to the standby database, which becomes the new primary database. A database copy, however, cannot be used in this way: it is not intended for failover scenarios and does *not* support the various standby recovery and failover options.

- Generate reports

See Also:

Oracle Data Guards Concepts and Administration to learn how to create a standby database with the `DUPLICATE` command

25.1.2 Basic Concepts of Database Duplication

The source host is the computer that hosts the source database. The **source database instance** is the instance associated with the source database.

The destination host is the computer that hosts the duplicate database. The source host and destination host can be the same or different computers.

For the duplication process, the database instance associated with the duplicate database is called the auxiliary instance.

RMAN must perform database point-in-time recovery, even when no explicit point in time is provided for duplication. Point-in-time recovery is required because the online redo log files in the source database are not backed up and cannot be applied to the duplicate database. The farthest point of recovery of the duplicate database is the most recent redo log file archived by the source database.

RMAN assigns a new DBID to the duplicate database (except when a standby database is created, in which case the source DBID is retained). You can then register the duplicate database in the same recovery catalog as the source database.

If you copy a database with operating system utilities rather than the `DUPLICATE` command, then the DBID of the copied database remains the same as the original database. To register the copied database in the same recovery catalog with the

original, you must change the DBID with the DBNEWID utility (see *Oracle Database Utilities*).

25.1.2.1 Initialization Parameters for the Auxiliary Instance

The following table describes a subset of the possible initialization parameters for the auxiliary instance.

Table 25-1 Auxiliary Instance Initialization Parameters

Initialization Parameter	Value	Status
DB_NAME	The same name used in the DUPLICATE command. If you are using DUPLICATE to create a standby database, then the name must be the same as the primary database. The DB_NAME setting for the duplicate database must be unique among databases in its Oracle home.	Required
CONTROL_FILES	Control file locations	Required
DB_BLOCK_SIZE	The block size for the duplicate database. This block size must match the block size of the source database. If the source database parameter file contains a value for the DB_BLOCK_SIZE initialization parameter, then you must specify the same value for the auxiliary instance. If no DB_BLOCK_SIZE is specified in the source database initialization parameter file, however, then do not specify DB_BLOCK_SIZE in the auxiliary instance.	Required if this initialization parameter is set in the source database
DB_FILE_NAME_CONVERT	Pairs of strings for converting the names of data files and temp files. You can also specify DB_FILE_NAME_CONVERT on the DUPLICATE command itself. See " Using DB_FILE_NAME_CONVERT to Generate Names for Non-OMF or ASM Data Files (page 26-9)".	Optional

Table 25-1 (Cont.) Auxiliary Instance Initialization Parameters

Initialization Parameter	Value	Status
LOG_FILE_NAME_CONVERT	Pairs of strings for naming online redo log files. See "Using LOG_FILE_NAME_CONVERT to Generate Names for Non-OMF or ASM Log Files (page 26-9)".	Optional
DB_CREATE_FILE_DEST	Location for Oracle managed data files.	Optional
DB_CREATE_ONLINE_LOG_DEST_n	Location for Oracle managed online redo log files	Optional
DB_RECOVERY_FILE_DEST	Location for fast recovery area	Optional
Oracle Real Application Cluster (Oracle RAC) parameters:	Set these parameters for each instance of the Oracle RAC database.	Required for Oracle RAC configuration
• <INSTANCESIDn>. INSTANCE_NAME		
• <INSTANCESIDn>. INSTANCE_NUMBER		
• <INSTANCESIDn>. THREAD		
• <INSTANCESIDn>. UNDO_TABLESPACE		
• <INSTANCESIDn>. LOCAL_LISTENER		

See Also:

- *Oracle Database Reference* for more information about initialization parameters for the auxiliary instance
- [Table 26-1](#) (page 26-1) to learn about options for naming duplicate files

25.1.2.2 About Parallelizing Backup Set Creation During Active Database Duplication

RMAN multisection backups provide faster backup performance by backing up very large data files in parallel. Multiple backup pieces are created, with a separate channel writing to each backup piece. Starting with Oracle Database 12c Release 1 (12.1), you can use multisection backup sets to transfer the source files required to perform active database duplication.

Use the SECTION SIZE clause in the DUPLICATE command to create multisection backup sets. The following command creates multisection backup sets, with the size of

each backup piece being 400MB. Assume that the connection to the target database and auxiliary instance has been made using net service names.

```
DUPLICATE TARGET DATABASE TO dup_db
FROM ACTIVE DATABASE
PASSWORD FILE
SECTION SIZE 400M;
```

25.1.2.3 About Encrypting Backup Sets During Active Database Duplication

RMAN can use backup sets to transfer the source database files that need to be duplicated. The backup sets are transferred over the network to the auxiliary database. Backup sets can be encrypted for additional security. Use the `SET ENCRYPTION ALGORITHM` command before the `DUPLICATE` command to specify the encryption algorithm.

Before you perform active database duplication, use one of the following techniques to ensure that the encryption is successful:

- If the source database uses transparent encryption, then you must share the Oracle software keystore containing the encryption key between the source database and the auxiliary instance as described in [Making the Oracle Keystore Available to the Destination Host](#) (page 25-28).
- If the source database uses password encryption, then you must specify the password used to encrypt backups.

The following command sets the encryption password (where *password* is a placeholder for the actual password that you enter):

```
SET ENCRYPTION ON IDENTIFIED BY password;
```

25.1.2.4 About Compressing Backup Sets During Active Database Duplication

When backup sets are used to perform active database duplication, RMAN can use backup compression to minimize the size of the backup sets used to transfer files from the source database to the destination host. Thus, compression can enhance the performance of the duplication process.

Compressing backup sets used for active database duplication is supported starting with Oracle Database 12c Release 1 (12.1).

Use the `USING COMPRESSED BACKUPSET` clause of the `DUPLICATE` command to compress the backup sets containing data required to perform active database duplication. The following command performs active database duplication using compressed backup sets. Assume that the connection to the target database and auxiliary instance has been made using net service names.

```
DUPLICATE TARGET DATABASE TO dup_db
FROM ACTIVE DATABASE
PASSWORD FILE
USING COMPRESSED BACKUPSET;
```

25.1.3 Types of Database Duplication

RMAN provides the following types of database duplication:

- Backup-based duplication

The duplicate database is created by using preexisting RMAN backups or copies of the source database. You can use different techniques to duplicate a database using backup-based duplication.

- Active database duplication

The duplicate database is created by copying the live source database over the network to the auxiliary instance. The duplication can be performed using backup sets or image copies.

You can use any type of duplication to duplicate a database either to the local host or to a remote host.

See Also:

- [Overview of Backup-Based Duplication](#) (page 25-6)
 - [Techniques for Performing Backup-Based Duplication](#) (page 25-7)
 - [Overview of Active Database Duplication](#) (page 25-9)
 - [Techniques for Performing Active Database Duplication](#) (page 25-10)
 - [Factors that Determine Whether Backup Sets or Image Copies Are Used for Active Database Duplication](#) (page 25-12)
-
-

25.1.3.1 Overview of Backup-Based Duplication

In backup-based duplication, preexisting RMAN backups of the source database are used to create the duplicate database. A combination of full and incremental backups can be used. RMAN determines which backups and archived redo log files must be used based on the UNTIL condition.

In backup-based duplication, the primary work of duplicating the database is performed by auxiliary channels. You can configure additional channels as described in [Configuring RMAN Channels for Use in Duplication](#) (page 25-34).

Backup-based duplication can be used in the following scenarios:

- A connection to the source database is not available, but backups of the source database are available.
- Network bandwidth between the source host and the destination host is a constraint.

When network bandwidth between the source host and destination host is limited, using active database duplication may result in reduced performance. For example, the source host and the destination host are in different geographical locations and are connected over a WAN. In such cases, it may be preferable to use backup-based duplication.

See Also:

[Overview of Active Database Duplication](#) (page 25-9) for details of scenarios in which active database duplication is preferred.

25.1.3.2 Techniques for Performing Backup-Based Duplication

Use one of the following mutually-exclusive techniques to perform backup-based duplication:

- [Backup-Based Duplication with a Target Connection](#) (page 25-7)
- [Backup-Based Duplication Without a Target Connection](#) (page 25-7)
- [Backup-Based Duplication Without a Target Database and Recovery Catalog Connection](#) (page 25-8)

25.1.3.2.1 Backup-Based Duplication with a Target Connection

In this method, you must connect as TARGET to the source database and as AUXILIARY to the auxiliary instance.

[Figure 25-1](#) (page 25-7) below illustrates backup-based duplication *with* a target connection. You may connect to a recovery catalog but it is not mandatory (not in figure). RMAN uses the metadata in the control file of the source database to determine which backups or copies must be used to perform the duplication.

The destination host must have access to the RMAN backups that are required to create the duplicate database.

Figure 25-1 Backup-Based Duplication with a Target Connection

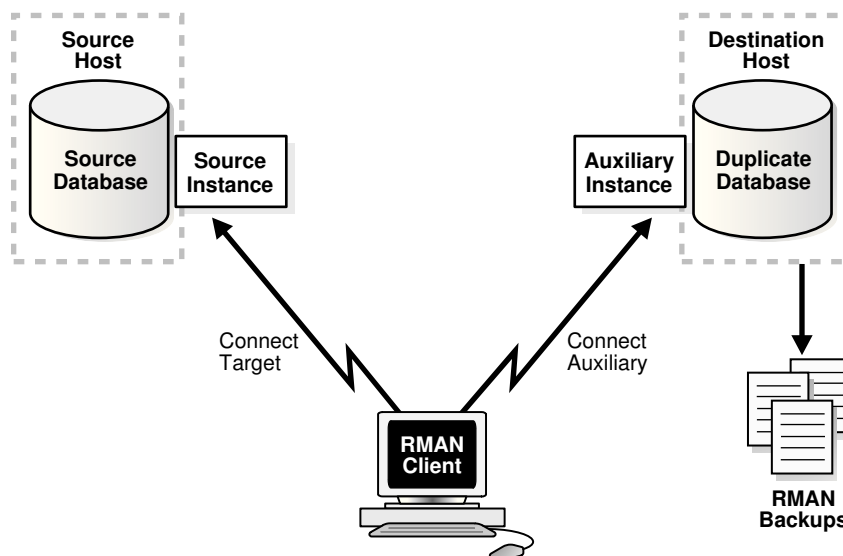

25.1.3.2.2 Backup-Based Duplication Without a Target Connection

In this method, you connect as CATALOG to the recovery catalog database and as AUXILIARY to the auxiliary instance.

[Figure 25-2](#) (page 25-8) illustrates backup-based duplication *without* a target connection. RMAN uses the metadata in the recovery catalog to determine which backups or copies are required to perform the duplication.

The destination host must have access to the RMAN backups required to create the duplicate database.

Figure 25-2 Backup-Based Duplication Without a Target Connection

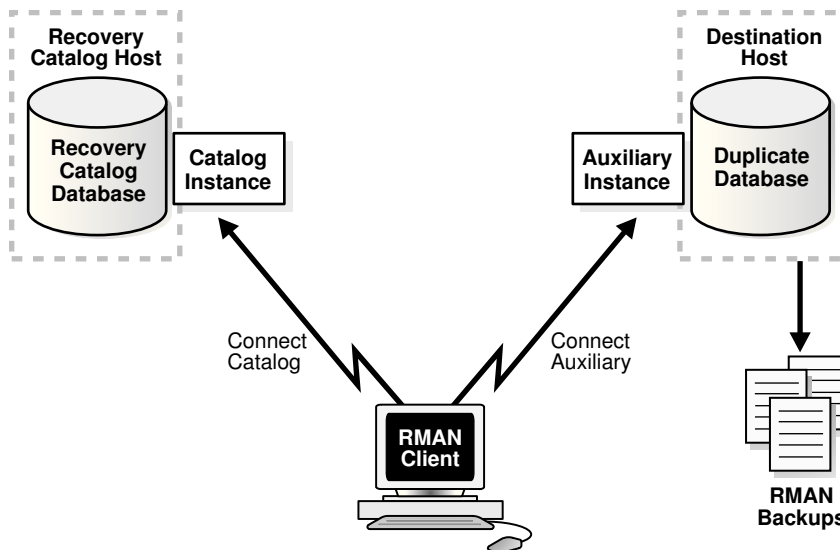

25.1.3.2.3 Backup-Based Duplication Without a Target Database and Recovery Catalog Connection

In this method, there is no connection to either the source database or the recovery catalog.

Figure 25-3 (page 25-9) illustrates backup-based duplication *without* connections to the target or to the recovery catalog database instance. You perform duplication by connecting to the auxiliary instance and using backups or copies of the source database that are stored in a disk location on the destination host. RMAN obtains metadata about where the backups and copies reside from the `BACKUP LOCATION` clause of the `Duplicate` command.

A disk backup location containing all the backups or copies required for duplication must be available to the destination host.

Note:

This method is not supported for backups that are stored on tape devices.

Figure 25-3 Backup-Based Duplication Without a Target Connection or Recovery Catalog Connection

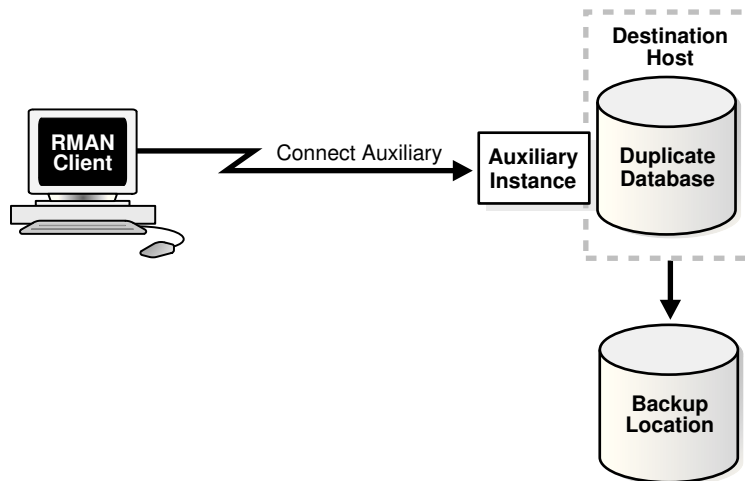

25.1.3.3 Overview of Active Database Duplication

Active database duplication does not require backups of the source database. It duplicates the live source database to the destination host by copying the database files over the network to the auxiliary instance. RMAN can copy the required files as image copies or backup sets.

For active database duplication, the duplication technique used determines which channel performs the principal work. When active database duplication is performed using backup sets, the principal work of duplication is performed by the auxiliary channels. When image copies are used, the primary work is performed by the target channels.

To perform active database duplication, a connection to the target database is required. Oracle recommends that you use active database duplication in general, unless network bandwidth between the source host and the destination host is a constraint. Active database duplication requires minimal setup and is simpler to perform.

Note:

For active database duplication, the source database must use a server parameter file.

Some of the scenarios in which active database duplication using backup sets may be preferred over using image copies are:

- You want to use multisection backups, compression, or encryption while duplicating your database.
- The source database does not have sufficient network resources to transfer the required database files to the duplicate database.
- You want to minimize the resources used by the duplication process.

Active database duplication with backup sets uses minimal resources on the source database.

25.1.3.4 Techniques for Performing Active Database Duplication

Multiple techniques are available for performing active database duplication.

Use one of the two mutually-exclusive methods to perform active database duplication:

- [Active Database Duplication Using Image Copies](#) (page 25-10)
- [Active Database Duplication Using Backup Sets](#) (page 25-10)

25.1.3.4.1 Active Database Duplication Using Image Copies

In this method, RMAN connects as `TARGET` to the source database and as `AUXILIARY` to the auxiliary instance. The source database then transfers the required database files over the network to the auxiliary instance. This method is referred to as the **push-based method** of active database duplication.

[Figure 25-4](#) (page 25-10) illustrates active database duplication using image copies. Using image copies for active database duplication may require additional resources on the source database. You can configure additional target channels to improve the duplication performance as described in [Configuring RMAN Channels for Use in Duplication](#) (page 25-34).

Figure 25-4 Active Database Duplication Using Image Copies

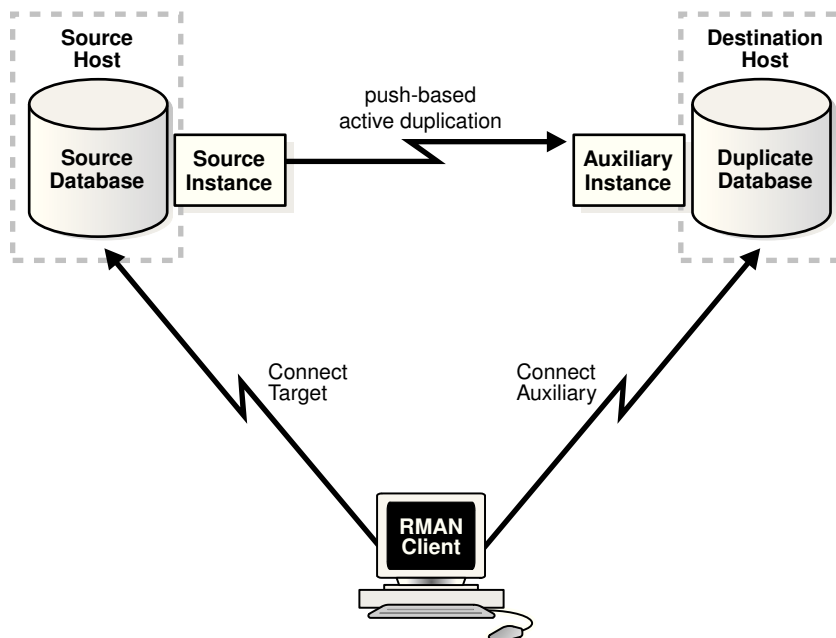

25.1.3.4.2 Active Database Duplication Using Backup Sets

Using backup sets to perform active database duplication is also known as the **pull-based method** of active database duplication.

In this method, RMAN connects as `TARGET` to the source database and as `AUXILIARY` to the auxiliary instance. The auxiliary instance then connects to the source database through Oracle Net Services and retrieves the required database files, over the network, from the source database. [Figure 25-5](#) (page 25-11) illustrates active database duplication using backup sets.

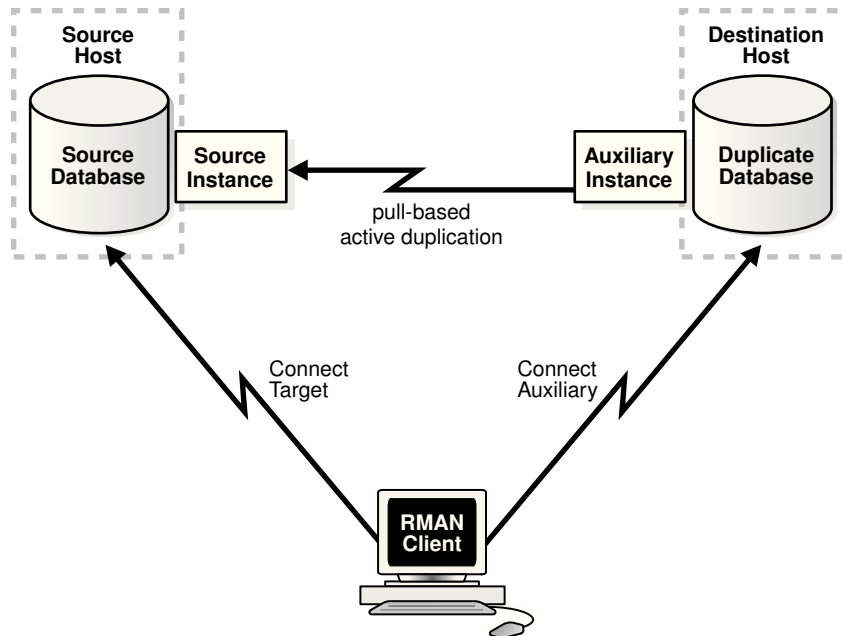
Figure 25-5 Active Database Duplication Using Backup Sets**Note:**

Performing active database duplication using backup sets is available starting Oracle Database 12c Release 1 (12.1).

Using backup sets for active database duplication provides the following advantages:

- RMAN can use unused block compression, thus reducing the size of backups that must be transported over the network.
- Backup sets can be created in parallel, on the source database, by using multisection backups.
- Backup sets created on the source database can be encrypted.

See Also:

- [About Compressing Backup Sets During Active Database Duplication](#) (page 25-5)
- [About Parallelizing Backup Set Creation During Active Database Duplication](#) (page 25-4)
- [About Encrypting Backup Sets During Active Database Duplication](#) (page 25-5)

25.1.3.5 Factors that Determine Whether Backup Sets or Image Copies Are Used for Active Database Duplication

RMAN uses backup sets to perform active database duplication when the connection to the target database is established using a net service name and any one of the following conditions is satisfied:

- The `DUPLICATE . . . FROM ACTIVE DATABASE` command contains either the `USING BACKUPSET`, `USING COMPRESSED BACKUPSET`, or `SECTION SIZE` clause.
- The number of auxiliary channels allocated is equal to or greater than the number of target channels allocated.

Otherwise, RMAN uses image copies to perform active database duplication.

Note:

Oracle recommends that you use backup sets to perform active database duplication.

25.1.4 How RMAN Duplicates a Database

RMAN automates the following steps as part of performing database duplicating operation:

1. Creates a default server parameter file for the auxiliary instance, if the following conditions are true:
 - Duplication does not involve a standby database
 - Server parameter files are not being duplicated
 - The auxiliary instance was not started with a server parameter file
2. Restores from backup or copies from the active database the latest control file that satisfies the `UNTIL` clause requirements.
3. Mounts the auxiliary instance using the restored control file or the backup control file copied from the active database.
4. Uses metadata in the RMAN repository to select the backups that will be used to restore the data files to the auxiliary instance. This step applies to backup-based duplication.
5. Copies the duplicate database files to the destination host and restores them to a noncurrent point in time using incremental backups and archived redo log files.
6. Shuts down and restarts the auxiliary database instance on the destination host in `NOMOUNT` mode.
7. Creates a new control file, which then creates and stores the new `DBID` in the data files.
8. Opens the duplicate database with the `RESETLOGS` option and creates the online redo log for the new database. If you do not want to open the duplicate database,

use the `NOOPEN` clause in the `DUPLICATE` statement as described in [Deciding the State of the Duplicate Database](#) (page 25-20).

See Also:

The `DUPLICATE` entry in *Oracle Database Backup and Recovery Reference* for a complete list of which files are copied to the duplicate database

25.1.5 Contents of a Duplicate Database

A duplicate database can include the same contents as the source database or only a subset of the tablespaces in the source database. For example, you can use the `TABLESPACE` option of the `DUPLICATE` command to duplicate only specified tablespaces, or the `SKIP READONLY` option to exclude read-only tablespaces from the duplicate database.

25.1.5.1 About Duplicating a Subset of the Source Database

It is not always necessary to duplicate all tablespaces of a database. For example, you may plan to generate reports that require only a subset of tablespaces from your source database. The `DUPLICATE` command enables you to duplicate a subset of the entire source database.

Note:

When excluding tablespaces in backup-based duplication *without* a target connection or *without* a target and a recovery catalog connection, RMAN has special prerequisites. See the Prerequisites section of the `DUPLICATE` entry in *Oracle Database Backup and Recovery Reference* for details

[Table 25-2](#) (page 25-13) explains `DUPLICATE` command options for specifying subsets of tablespaces for the duplicate database:

Table 25-2 Options to Specify Subsets of Tablespaces for the Duplicate Database

DUPLICATE Options	Explanation
<code>SKIP READONLY</code>	Excludes the data files of read-only tablespaces from the duplicate database.
<code>SKIP TABLESPACE 'tablespace_name', ...</code>	Excludes the specified tablespaces from the duplicate database. You cannot exclude the <code>SYSTEM</code> and <code>SYSAUX</code> tablespaces, tablespaces with <code>SYS</code> objects, undo tablespaces, tablespaces with undo segments, tablespaces with materialized views, or tablespaces in such a way that the duplicated tablespaces are not self-contained.
<code>TABLESPACE 'tablespace_name', ...</code>	Automatically includes the <code>SYSTEM</code> , <code>SYSAUX</code> , and undo tablespaces. The included tablespaces must be self-contained and the resulting skipped tablespaces must not contain <code>SYS</code> objects or materialized views.

25.1.6 About the Destination Host for Database Duplication

RMAN creates the duplicate database on the specified destination host. The destination host can be the same as the source host or different. When the same computer is used as the source host and the destination host, the duplication is termed as duplicating to the local host. When the source host and the destination host are on different computers, the duplication is termed as duplicating to a remote host.

About Duplicating a Database to the Local Host

When you duplicate a database to the local host, you must store the duplicate database files using a directory structure that is different from that of the source database. For example, if the source database files are stored in `/disk1/oracle`, then the duplicate database files can be stored in `/disk2/oracle`. The duplicate database file names can be the same as those of the source database or different. The techniques for specifying alternate names for duplicate database files are described in [Methods of Generating Database File Names for the Duplicate Database](#) (page 25-18).

About Duplicating a Database to a Remote Host

When you duplicate a database to a remote host, the duplicate database files can either use the same directory structure and file names as the source database or use a different directory structure and file names. If you choose to name duplicate database files differently, then you must use one the techniques described in [Methods of Generating Database File Names for the Duplicate Database](#) (page 25-18) to specify how duplicate database files are named.

Note:

Duplication to a remote host requires a password file and an Oracle Net Services connection to the auxiliary instance.

25.1.7 About Duplicate Database File Names

Depending on the destination host used and your duplication scenario, the duplicate database files can either use the same names as the source database or different names. The database files include the data file, control files, online redo log files, and temp files.

If you choose to name duplicate database files differently, you must specify a strategy for naming these files.

See Also:

- [Choosing a Strategy for Naming Duplicate Database Files](#) (page 25-16)
 - [About the Destination Host for Database Duplication](#) (page 25-14)
-
-

25.1.8 About Duplicating a Database to a Past Point-in-Time

By default, the `DUPLICATE` command creates the duplicate database by using the most recent backups of the target database and then performs recovery to the most recent consistent point contained in the incremental backups and archived redo logs.

However, you can recover the duplicate database to a past point in time by using one of the following methods:

- `DUPLICATE ... UNTIL` command
- `SET UNTIL` command before the `DUPLICATE` command

See Also:

Oracle Database Backup and Recovery Reference for an example of duplicating a database to a past point in time

25.1.9 Prerequisites for Duplicating a Database

The prerequisites depend on the type of database duplication being performed. Some prerequisites are common to all types of duplication and others are specific to a particular type of duplication.

See Also:

Oracle Database Backup and Recovery Reference for details about prerequisites for each duplication technique

25.2 Planning to Duplicate a Database

Before duplicating a database, you must make some decisions about the duplication process.

Planning to duplicate a database includes the following tasks:

- [Choosing a Duplication Technique](#) (page 25-15)
- [Choosing a Strategy for Naming Duplicate Database Files](#) (page 25-16)
- [Installing the Oracle Database Software on the Destination Host](#) (page 25-20)
- [Deciding the State of the Duplicate Database](#) (page 25-20)
- [Making Backups Accessible to the Duplicate Instance](#) (page 25-20)

25.2.1 Choosing a Duplication Technique

Your business requirements and the database environment determine which duplication technique is best for your situation. Consider the following questions:

- Are you familiar with the prerequisites for each duplication technique?

Review the Prerequisites section of the `DUPLICATE` command description in *Oracle Database Backup and Recovery Reference* for a complete list.

Some prerequisites are specific and depend on the duplication technique. For example, active duplication requires that the source and auxiliary instances use the same password as the source database, whereas backup-based duplication without connections to the target database and recovery catalog requires only that all backups and database copies reside in a single location.

- Do backups of the source database exist?

The principal advantage of active database duplication is that it does not require source database backups. Active duplication copies mounted or online database files over a network to the auxiliary instance. One disadvantage of this technique is the negative performance effect on the network. Another disadvantage is that the source database is running processes required to transfer the files to the auxiliary host, thereby affecting the source database and production workload.

If the source database backups exist, and if the effect on the network is unacceptable, then backup-based duplication may be a better option. You can copy backups to temporary storage and transfer them manually to the destination host. If duplication is made with a connection to the target or the recovery catalog, then the backup files on the destination host must have the same file specification as they had on the source host. Otherwise, this is not a requirement.

- Is a recovery catalog available?

If a recovery catalog exists, then you can perform backup-based duplication without connecting RMAN as `TARGET` to the source database. This technique is advantageous where network connections from the auxiliary host to the source database are restricted or prone to intermittent disruptions. In duplication without a `TARGET` connection, the source database is unaffected by the duplication.

- How much disk space is available on the destination host?

The disk space on the destination host can be an issue when you perform duplication using disk backups. For example, if the source database is 1 terabyte (TB), and if you duplicate the database from disk backups *without* using shared disk or network file system (NFS), then you must have at least 2 terabytes (TB) of space available on the destination host. In some environments, manual transfer of backups is necessary because NFS performance is a bottleneck.

- Are the source and destination hosts connected by a LAN or a WAN?

Performance of active database duplication is probably slower on a wide area network (WAN) than on a local area network (LAN). If the performance degradation on a WAN is unacceptable, then backup-based duplication may be the only viable option.

- When do you plan to duplicate the database?

If you must duplicate the database during a period of high user activity, then the loss of network throughput caused by active duplication may be a problem, making backup-based duplication a better choice. Also, in active database duplication, the RMAN channels required for copying files to the auxiliary host can affect performance.

25.2.2 Choosing a Strategy for Naming Duplicate Database Files

When duplicating a database, RMAN generates names for the database files in the duplicate database. This includes the control files, data files, temp files, and online redo log files.

Depending on your duplication scenario, you can name the duplicate database files using one of the following techniques:

- [Using the Same Names for Database Files in the Source Database and Duplicate Database](#) (page 25-17)

- [Using Different Names for the Database Files in the Source Database and Duplicate Database](#) (page 25-17)

If you do not specify a strategy to generate names for duplicate database files, then RMAN uses the same file names and directory structure as the source database for the duplicate database. In this case, you must use the `NOFILENAMECHECK` clause to indicate that RMAN must not display an error when the names of the files are the same.

Some of the methods used to specify alternate names for duplicate database files may generate file names that are the same as the ones used by the source database. This may happen if, for example, you used `SET NEWNAME` or `CONFIGURE AUXNAME` to specify names for the duplicate database files. Use caution when specifying the file names for the duplicate database, else you may mistakenly overwrite the source database files.

25.2.2.1 Using the Same Names for Database Files in the Source Database and Duplicate Database

The simplest duplication strategy is to configure the duplicate database to use the same directory structure and file names as the source database. You can use the same directory structure and names only when duplicating to a remote host. Ensure that you use the `NOFILENAMECHECK` clause in the `DUPLICATE` command to avoid errors on the duplication process.

Using the same directory structure and file names means that your environment meets the following requirements:

- If the source database uses ASM disk groups, then the duplicate database must use ASM disk groups with the same names.
- If the source database files are Oracle Managed Files, then the auxiliary instance must set `DB_CREATE_FILE_DEST` to the same directory location as the source database. Although the directories are the same on the source and destination hosts, Oracle Database chooses the relative names for the duplicate files.
- If the names of the database files in the source database contain a path, then this path name must be the same in the duplicate database.
- For Oracle Real Application Clusters (RAC) environments, use the same `ORACLE_SID` for the source and destination databases.

When you configure your environment as suggested, no additional configuration is required to name the duplicate files.

25.2.2.2 Using Different Names for the Database Files in the Source Database and Duplicate Database

If the source host and the destination host use different directory structures, or if they use the same directory structures but you want to name the database files differently, then you must specify how RMAN should generate names for the duplicate database files.

See Also:

[Methods of Generating Database File Names for the Duplicate Database](#)
(page 25-18)

Note:

It is recommended that you use different names for the ASM disk groups in the source and duplicate database.

25.2.2.3 Methods of Generating Database File Names for the Duplicate Database

Depending on the method that you choose, RMAN can either automatically generate file names or use specific names for the duplicate database files. The database files include the data files, control files, online redo log files, and temp files.

Use one of the following methods, listed in the order of precedence, to generate file names for the duplicate database:

- **SET NEWNAME** command
 Provides specific names for the duplicate database files. Based on your requirement, use the **SET NEWNAME FOR DATABASE**, **SET NEWNAME FOR DATAFILE**, **SET NEWNAME FOR TABLESPACE**, or **SET NEWNAME FOR TEMPFILE** command.

 For OMF and ASM database files, you must use **SET NEWNAME . . . TO NEW** and not explicitly provide names for the database files.
 See [Specifying Alternative Names for Duplicate Database Files](#) (page 26-1).
- **CONFIGURE AUXNAME** command
 Specifies non-OMF and non-ASM alternative names for duplicate database files.
 See [Specifying Alternative Names for Duplicate Database Files](#) (page 26-1).
- **SPFILE** clause of the **DUPLICATE** command
 Sets all the necessary initialization parameters involving duplicate database file names, with the exception of **DB_FILE_NAME_CONVERT**.

 See *Oracle Database Backup and Recovery Reference* for details about how to use the **SPFILE** clause
- (Online redo log files only) **LOGFILE** clause of the **DUPLICATE** command
 Names online redo log files in the duplicate database. You cannot use this method while creating a standby database.

Note:

When duplicating to the local host or to a remote host without the **NOFILENAMECHECK** clause, ensure that you do not use the name of an online redo log file that is currently in use by the source database.

See *Oracle Database Backup and Recovery Reference* for information about the **LOGFILE** clause.

- **DB_FILE_NAME_CONVERT** and **LOG_FILE_NAME_CONVERT** initialization parameters
 Specifies a rule for converting file names in the source database to names in the duplicate database. You can specify multiple conversion pairs.

When you use `DB_FILE_NAME_CONVERT` for ASM file names, only disk group name changes must be performed.

Note:

You cannot use this method to specify alternative names for duplicate database files if the source database uses Oracle Managed Files.

See [Specifying Alternative Names for Duplicate Database Files](#) (page 26-1).

- `DB_CREATE_FILE_DEST` and `DB_CREATE_ONLINE_LOG_DEST_n` parameters
Creates Oracle Managed Files at the location specified by these parameters. This is the recommended method to specify alternative names for OMF and ASM.

See [Specifying Alternative Names for Duplicate Database Files](#) (page 26-1).

If more than one method is used to specify alternate names for duplicate database files, then the order of precedence decides which technique is used to name files. Any files that are not renamed by a particular method are renamed by the method that follows it. For example, if two data files are not included in the `SET NEWNAME` command, then these data files will be renamed using the `DB_FILE_NAME_CONVERT` parameter.

Preventing File Name Checking During Database Duplication

It is possible for `CONFIGURE AUXNAME`, `SET NEWNAME`, or `DB_FILE_NAME_CONVERT` to generate a name that is already in use in the target database. In this case, use `NOFILENAMECHECK` to avoid an error message.

Generating Names for Control Files in the Duplicate Database

By default, RMAN creates the control file in the default location in the duplicate database. You can specify alternate files names and directory names to store the duplicate database control files. While choosing names for the control files, ensure that you do not mistakenly overwrite the control files of the source database.

Use one of the following techniques, listed in the order of precedence, to specify the location of the duplicate database control files:

- Set the `CONTROL_FILES` initialization parameter in the auxiliary instance's initialization parameter file.
- Create an OMF-based control file in a location which is determined by setting one of the following parameters:
 - `DB_CREATE_ONLINE_LOG_DEST_n`
 - `DB_CREATE_FILE_DEST`
 - `DB_RECOVERY_FILE_DEST`

If more than one of these parameters is set, then the order of precedence used is the order in which these parameters are listed.

25.2.3 Installing the Oracle Database Software on the Destination Host

If the source and destination host are different, then you must install the Oracle Database software on the destination host so that the auxiliary instance can be created. You can install the software in one of the following ways:

- Perform a normal installation with Oracle Universal Installer (OUI).
Install an Oracle Database that is the same release as the source database. Do not create a database; install the software only. Apply any required patches.
- Clone the source Oracle home.
Use OUI to clone the source Oracle home. This ensures that all patches applied to the source database are present in the duplicate database.

25.2.4 Deciding the State of the Duplicate Database

When you use the RMAN `DUPLICATE` command, the duplicate database is created and then opened in `RESETLOGS` mode. You can use the `NOOPEN` clause in the `DUPLICATE` command to specify that the duplicate database must not be opened.

You may not want to open the duplicate database immediately after creation in the following situations:

- Opening the duplicate database may cause errors.
- You need to modify the initialization parameters of the duplicate database.
For example, you need to modify flashback database settings, configure fast incremental backups, or modify block change tracking.
- You are creating a new database as part of an upgrade procedure.
During an upgrade you cannot open the database with `RESETLOGS` option. The `NOOPEN` clause enables you to duplicate the database and then leave it in a state that is ready for opening in upgrade mode and for subsequent execution of upgrade scripts.

25.2.5 Making Backups Accessible to the Duplicate Instance

Note:

If you are performing active database duplication, then this step is not necessary.

When duplicating with a target connection and recovery catalog connection or with just a target connection, RMAN uses metadata in the RMAN repository to locate backups and archived redo log files needed for duplication. If RMAN is connected to a recovery catalog, then RMAN obtains the backup metadata from the catalog. If RMAN is not connected to a catalog, as may be the case when performing backup-based duplication *with* a target connection, then RMAN obtains metadata from the control file.

Unless you are duplicating without a connection to the target and to the recovery catalog, the names of the backups must be available with the same names recorded in

the RMAN repository. Ensure that auxiliary channels on the destination host can access all data file backups and archived redo log files (required to restore and recover the duplicate database to the desired point in time). If not, duplication fails. The archived redo log files can be available either as image copies or backup sets.

Note:

The database backup need not have been generated with `BACKUP DATABASE`. You can mix full and incremental backups of individual data files, but a full backup of every data file is required.

See Also:

- [Making SBT Backups Accessible to the Auxiliary Instance](#) (page 25-21)
 - [Making Disk Backups Accessible to the Auxiliary Instance](#) (page 25-21)
-
-

25.2.5.1 Making SBT Backups Accessible to the Auxiliary Instance

The steps in this task are specific to your media manager configuration

To make SBT backups accessible to the auxiliary instance:

1. If necessary, install media management software on the destination host.
2. Make the tapes with the backups accessible to the destination host. Typically, you do one of the following:
 - Physically move the tapes to a drive attached to the remote host.
 - Use a network-accessible tape server.
3. If necessary, inform the remote media management software about the existence of the tapes.

25.2.5.2 Making Disk Backups Accessible to the Auxiliary Instance

When you make disk backups accessible to the auxiliary instance, your strategy depends on whether or not you duplicate the database while connected to the target or recovery catalog. If you do not connect to the target or recovery catalog, then you must designate a backup location for the duplication by using the `BACKUP LOCATION` clause.

When you use a backup location, the backups and copies can reside in a shared location or can be moved to the location on the destination host. In the latter case, you do not need to preserve the name or the original path of the backup or copy. The location specified in the `BACKUP LOCATION` option must contain sufficient backup sets, image copies, and archived logs to restore all of the files being duplicated, and recover them to the desired point in time.

It is not required that all of the backups be from the same point in time, or that they all be backup sets, or all image copies. Data file backups can be supplied as either image copies or backup sets. Archived logs can be supplied either in their normal format or as backup sets of archived logs.

When you use backups from different points in time, the backup location must contain archived logs covering the time from the start of the oldest backup until the desired recovery point.

If the backup location contains backup files from multiple databases, then the `DATABASE` clause must specify the name of the database that is to be duplicated. If the backup location contains backup files from multiple databases having the same name, then the `DATABASE` clause must specify both the name and `DBID` of the database that is to be duplicated.

The source database's Fast Recovery Area is particularly well suited for use as a backup location because it almost always contains all of the files needed for the duplication. To use a Fast Recovery Area as a backup location, you can either remotely access it from the destination system, or copy its contents to the destination system.

When you are not using a backup location, your strategy depends on the following mutually exclusive scenarios:

- Identical file systems for source and destination hosts

This scenario is the simplest and Oracle recommends it. For example, assume that the backups of the source database are stored in `/dsk1/bkp`. In this case, you can make disk backups accessible to the destination host in either of these ways:

- Manually transfer backups from the source host to an identical path in the destination host. For example, if the backups are in `/dsk1/bkp` on the source host, then use FTP to transfer them to `/dsk1/bkp` on the destination host.
- Use NFS or shared disks and ensure that the same path is accessible in the destination host. For example, assuming that the source host can access `/dsk1/bkp`, use NFS to mount `/dsk1/bkp` on the destination host and use `/dsk1/bkp` as the mount point name.

- Different file systems for source and destination hosts

In this case you *cannot* use the same directory name on the destination host as you use on the source host. You have the following options:

- You can use shared disk to make backups available. This section explains the shared disk technique.
- You cannot use shared disk to make backups available. [Making Disk Backups Accessible Without Shared Disk](#) (page 26-10) describes this technique.

Assume that you have two hosts, `srchost` and `dsthost`, and access to NFS or shared disk. The database on `srchost` is called `srcdb`. The backups of `srcdb` reside in `/dsk1/bkp` on host `srchost`. The directory `/dsk1/bkp` is in use on the destination host, but the directory `/dsk2/dup` is not in use on either host.

To transfer the backups from the source host to the destination host:

1. Create a backup storage directory in either the source or destination host.

For this example, create backup directory `/dsk2/dup` on the destination host.

2. Mount the directory created in the previous step on the other host, ensuring that the directory and the mount point names are the same.

For example, if you created `/dsk2/dup` on the destination host, then use NFS to mount this directory as `/dsk2/dup` on the source host.

3. Make the backups available in the new location on the destination host. You can use either of the following techniques:
 - Connect RMAN to the source database as `TARGET` and use the `BACKUP` command to back up the backups. For example, use the `BACKUP COPY OF DATABASE` command to copy the backups in `/dsk1/bkp` on the source host to `/dsk2/dup` on the source host. In this case, RMAN automatically catalogs the backups in the new location.

If you are duplicating a PDB, then use the `PLUGGABLE DATABASE` syntax of the `BACKUP COPY OF` command to copy only the backups of the PDB.
 - Use an operating system utility to transfer the backups to the new location. For example, use FTP to transfer the backups from `/dsk1/bkp` on the source host to `/dsk2/dup` on the destination host, or use the `cp` command to copy the backups from `/dsk1/bkp` on the source host to `/dsk2/dup` on the source host. Afterward, connect RMAN to the source database as `TARGET` and use the `CATALOG` command to update the RMAN repository with the location of the manually transferred backups.

25.3 Preparing the Auxiliary Instance

RMAN uses an auxiliary instance to create the duplicate database. You must prepare the auxiliary instance before you begin the duplication. Depending on your duplication scenario, you need to perform either some or all of the tasks described in this section.

Preparing the auxiliary instance includes the following tasks:

- [Creating Directories for the Duplicate Database](#) (page 25-23)
- [Creating an Initialization Parameter File for the Auxiliary Instance](#) (page 25-23)
- [Creating a Password File for the Auxiliary Instance](#) (page 25-26)
- [Establishing Oracle Net Connectivity Between the Source Database and Auxiliary Instance](#) (page 25-27)
- [Starting the Auxiliary Instance](#) (page 25-28)
- [Making the Oracle Keystore Available to the Destination Host](#) (page 25-28)

25.3.1 Creating Directories for the Duplicate Database

On the destination host, you must create the directories that will be used to store the duplicate database files on the destination host. This includes the directories that store the data files, control files, online redo log files, and temp files.

25.3.2 Creating an Initialization Parameter File for the Auxiliary Instance

An initialization parameter file is required to start the auxiliary instance. Use one of the following methods to create the initialization parameter file:

- Create an initialization parameter file manually

If the source database does not use a server parameter file, then you must set all the necessary parameters for the auxiliary instance in a text-based initialization parameter file.

See [Steps to Create an Initialization Parameter File for the Auxiliary Instance](#) (page 25-24).

- Direct RMAN to use the initialization parameter file of the source database for the auxiliary instance.

This technique is applicable only if the source database uses a server parameter file. Copying the initialization parameter file from the source database contains is useful when the duplicate database must use the same parameter settings as the source.

See [Copying the Server Parameter File from the Source Database](#) (page 25-26).

Note:

It is recommended to use a server parameter file instead of a text-based initialization parameter file for duplication.

The client-side parameter file for the auxiliary instance must reside on the same host as the RMAN client that performs the duplication.

It is recommended that you create the initialization parameter file in the default location on the auxiliary instance. On Windows, the default initialization parameter file is `ORACLE_HOME/dbs/initORACLE_SID.ora` and on Linux the file name is `ORACLE_HOME/database/intiORACLE_SID.ora`.

See Also:

- [Initialization Parameters for the Auxiliary Instance](#) (page 25-3)
 - [Steps to Create an Initialization Parameter File for the Auxiliary Instance](#) (page 25-24)
 - [Copying the Server Parameter File from the Source Database](#) (page 25-26)
-
-

25.3.2.1 Steps to Create an Initialization Parameter File for the Auxiliary Instance

The initialization parameter file must contain at least the `DB_NAME` and `DB_DOMAIN` initialization parameters. Additional parameters may be specified if required. Ensure that the initialization parameter file is on the same host as the RMAN client that performs the duplication.

To create the initialization parameter file for the auxiliary instance:

1. Do one of the following:
 - Copy the initialization parameter file from the source host to the destination host, placing it in the operating system-specific default location, and then modify `DB_NAME` and `DB_DOMAIN`.

If you are duplicating a CDB, ensure that the `ENABLE_PLUGGABLE_DATABASE` parameter is present and set to `TRUE`.

See [Copying the Server Parameter File from the Source Database](#) (page 25-26).

- Complete these steps:
 - a. Using a text editor, create an empty file for use as a text-based initialization parameter file, and save it in the operating system-specific default location.
 - b. In the parameter file, set `DB_NAME` and `DB_DOMAIN`. These are the only required parameters.

Setting `DB_DOMAIN` enables you to connect to the default database service when connecting with a net service name.
 - c. If the auxiliary instance is to be a CDB, then set the following parameter:

```
ENABLE_PLUGGABLE_DATABASE=TRUE
```

2. Set the various location parameters such as `CONTROL_FILES` and `DB_RECOVERY_FILE_DEST`.
3. If necessary, set other initialization parameters like those needed for Oracle Real Application Clusters.
4. Set the required environment variables, such as `ORACLE_HOME` and `ORACLE_SID`.
5. (Optional) Set initialization parameters that specify the location of the duplicate database files if one of the following conditions is satisfied:
 - The source host and the destination host are the same (duplication to the local host).
 - The duplicate database uses a directory structure that is different from that of the source host to store database files.

Depending on the technique used to specify alternate names for duplicate database files, include one or more of the following parameters in the initialization parameter file: `CONTROL_FILES`, `DB_FILE_NAME_CONVERT`, `LOG_FILE_NAME_CONVERT`, `DB_CREATE_FILE_DEST`, `DB_CREATE_ONLINE_FILE_DEST_n`, and `RECOVERY_FILE_DEST`.

Note:

It is recommended that you verify that all paths specified are accessible to the destination host and to the server session of the auxiliary instance.

See [Methods of Generating Database File Names for the Duplicate Database](#) (page 25-18).

6. Start SQL*Plus and connect to the auxiliary instance as a user with `SYSDBA` or `SYSBACKUP` privileges. Start the auxiliary instance in `NOMOUNT` mode. No `PFIL` parameter on the `STARTUP` command is necessary if the file is in the default location.

```
SQL> STARTUP NOMOUNT;
```

Example 25-1 Sample Initialization Parameter File for the Auxiliary Instance

```
DB_NAME=dupdb
CONTROL_FILES=(/dup/oracle/oradata/prod/control01.ctl,
               dup/oracle/oradata/prod/control02.ctl)
```

```
B_FILE_NAME_CONVERT=(/oracle/oradata/prod/,/dup/oracle/oradata/prod/)
LOG_FILE_NAME_CONVERT=(/oracle/oradata/prod/redo,/dup/oracle/oradata/prod/redo)
```

25.3.2.2 Copying the Server Parameter File from the Source Database

If the source database uses a server parameter file, then including the `SPFILE` clause in the `DUPLICATE` command directs RMAN to use the server parameter file from the source database for the auxiliary instance. For backup-based duplication, the server parameter file is restored from backups. For active database duplication, the server parameter file is copied from the source database to the auxiliary instance.

You can modify the values that were copied or restored from the server parameter file of the source database by using the `PARAMETER_VALUE_CONVERT` option of `SPFILE` or the `SET` clause of the `DUPLICATE`. For example, you can use the `SET` clause to change the value of the `DB_FILE_NAME_CONVERT` parameter in the auxiliary instance's server parameter file.

If the source database does not use a server parameter file or RMAN cannot restore a backup of the server parameter file, then you must manually create a text-based initialization parameter file as described in [Steps to Create an Initialization Parameter File for the Auxiliary Instance](#) (page 25-24).

When the source database uses a text-based initialization parameter file, use the `PFILE` clause in the `DUPLICATE` command to copy the source database's initialization parameter file to the auxiliary instance.

25.3.3 Creating a Password File for the Auxiliary Instance

Connections to the auxiliary instance can be established by using operating system authentication or password file authentication. For backup-based duplication, you can either create a password file or use operating system authentication to connect to the auxiliary instance. For active database duplication, you must use password file authentication.

To connect to a database using password file authentication, you must create a password file for the database. Setting up a password file is also mandatory when duplicating to a remote host.

Note:

Password files are always copied when you create a standby database using RMAN duplication. In all other cases, password files are copied only if you specify `PASSWORD FILE` in the `DUPLICATE` command.

Use one of the following options to create a password file for the auxiliary instance on the destination host:

- Use operating system-specific utilities to copy the source database password file to the destination host and then rename it to match the auxiliary instance name. This is applicable only if the source and destination hosts are on the same platform.
- Create the password file manually. Ensure that the password for the `SYSDBA` and `SYSBACKUP` users are the same in the source database and auxiliary instance.

See *Oracle Database Administrator's Guide* for information about creating a password file manually.

- Create the password file with the `orapwd` utility. The `SYSDBA` option creates a `SYSDBA` entry in the new password file.

See *Oracle Database Administrator's Guide* for information about using the `orapwd` utility.

- Specify the `PASSWORD FILE` option on the `DUPLICATE . . . FROM ACTIVE DATABASE` command.

RMAN copies the source database password file to the destination host and overwrites any existing password file for the auxiliary instance. This technique is useful if the source database password file has multiple passwords to make available on the duplicate database.

When using active database duplication, the password file must contain at least two passwords, for the `SYSDBA` user and the `SYSDBA` user. These passwords must match the passwords in the source database.

Note:

If you create a standby database with the `FROM ACTIVE DATABASE` option, then RMAN always copies the password file to the standby host.

25.3.4 Establishing Oracle Net Connectivity Between the Source Database and Auxiliary Instance

The auxiliary instance must be available through Oracle Net Services if any of the following conditions is true:

- The RMAN client is run from a host other than the destination host
- The duplication technique chosen is active database duplication
- The destination host is different from the source host

To perform active database duplication, you must connect to the auxiliary instance with `SYSDBA` or `SYSDBA` privilege and by using a net service name. The source database to which RMAN is connected as `TARGET` uses this net service name to connect directly to the auxiliary database instance.

To establish Oracle Net connectivity and set up a static listener:

- Follow the instructions in *Oracle Database Net Services Administrator's Guide* to configure a client for connection to a database and add static service information for the listener.

Example 25-2 Example: Establishing Oracle Net Connectivity Between the Source Database and Auxiliary Instance

Assume that the `DB_NAME` of the source database is `src` the source host name is `src.example.com`. The `DB_NAME` of the auxiliary instance is `dup` and the auxiliary instance is created on the host `dup.example.com`.

Use the following steps to establish Oracle Net connectivity between the source database and the auxiliary instance:

1. In the `tnames.ora` file of the source database, add the following entry that corresponds to the duplicate database:

```
dupdb = (DESCRIPTION=(ADDRESS=(PROTOCOL=TCP)(HOST=dup.example.com)(PORT=1521))
(CONNECT_DATA=(SERVICE_NAME=dup)))
```

2. On the destination host, create the `tnsnames.ora` file in the `$ORACLE_HOME/admin/network` folder. Add the following entry that corresponds to the source database.

```
srcdb = (DESCRIPTION=(ADDRESS=(PROTOCOL=TCP)(HOST=src.example.com)(PORT=1521))
(CONNECT_DATA=(SERVICE_NAME=src)))
```

25.3.5 Starting the Auxiliary Instance

The initialization parameter file created in [Creating an Initialization Parameter File for the Auxiliary Instance](#) (page 25-23) is used to start the auxiliary instance. RMAN shuts down and restarts the auxiliary instance as part of the duplication. Hence, it is a good idea to create a server-side initialization parameter file for the auxiliary instance in the default location. If you do not have a server-side initialization parameter file in the default location, then you must specify the client-side initialization parameter file with the `PFIL` parameter on the `DUPLICATE` command.

Note:

Because the auxiliary instance does not yet have a control file, you can only start the instance in `NOMOUNT` mode. Do not create a control file or try to mount or open the auxiliary instance.

To start the auxiliary instance:

1. Start RMAN.

```
% rman
```

2. Connect to the auxiliary instance as a user with the `SYSDBA` or `SYSBACKUP` privilege. The following example uses password file authentication to connect to the auxiliary instance.

```
RMAN> CONNECT SYS@dupdb AS SYSDBA;
```

The following example uses operating system authentication to connect to the auxiliary instance using the `SYSBACKUP` privilege.

```
RMAN> CONNECT / AS SYSBACKUP;
```

3. Start the auxiliary instance in `NOMOUNT` mode.

```
RMAN > STARTUP FORCE NOMOUNT;
```

25.3.6 Making the Oracle Keystore Available to the Destination Host

If transparent encryption is configured on the source database, then you must ensure that the Oracle software keystore from the source database is available to the auxiliary instance. The Oracle software keystore contains the TDE master key used to decrypt encrypted backups (for backup-based duplication) and database/tablespace data (for active database duplication of TDE-encrypted databases or tablespaces). Manually copy the source database keystore to the destination host.

The following are requirements for the keystore at the duplicate database:

- The keystore must be in the default location, or in the location indicated by the `sqlnet.ora` file.
- Permissions on the Oracle keystore file must be set so that the database can access the file.
- During duplication, the auxiliary instance is restarted thereby causing the Oracle software keystore to become unavailable. To ensure that the auxiliary instance has access to the keystore, set the `ENCRYPTION_WALLET_LOCATION` parameter in the `sqlnet.ora` file such that it points to the keystore location.
- With Oracle Real Application Clusters (Oracle RAC), register the auxiliary instance statically with an Oracle Grid Infrastructure listener and use the `ENVS` parameter in the `sqlnet.ora` file of the Oracle Grid home to specify environment variables that set the keystore location and the unique name of the database.

The following example sets the `ENVS` parameter in `sqlnet.ora` to specify the keystore location and unique database name:

```
(ENVS="ORACLE_UNQNAME=cdbp1, ENCRYPTION_WALLET_LOCATION=(SOURCE=(METHOD=FILE)
(METHOD_DATA=(DIRECTORY=/etc/ORACLE/WALLETS/cdbp1)))")
```

- If the source database uses a password-based software keystore (not an auto-login software keystore), then you must provide the keystore password before you begin the duplication.

Use the `SET` command with the `DECRYPTION WALLET OPEN IDENTIFIED BY` clause to specify the password that must be used to open the keystore.

The following command specifies the password used to open the keystore (where `password` is a placeholder for the actual password that you enter):

```
SET DECRYPTION WALLET OPEN IDENTIFIED BY password;
```

See Also:

- *Oracle Database Advanced Security Guide* for information about specifying the Oracle keystore location in `sqlnet.ora`
 - *Oracle Database Advanced Security Guide* for information about the default Oracle keystore location
 - *Oracle Database Advanced Security Guide* for information about converting a standard Oracle keystore to an auto-login keystore
 - *Oracle Database Backup and Recovery Reference* for information about the `SET` command
 - [Example: Performing Backup-based Duplication Using Encrypted Backups](#) (page 25-55)
-

25.4 Duplicating a Database

This section describes how to perform database duplication. The steps to duplicate CDBs and PDBs have minor variations from the steps used for non-CDBs.

Note:

Performing simultaneous duplication operations using the same source database is not supported.

See Also:

- [Duplicating the Whole Database](#) (page 25-30)
 - [Duplicating a Subset of the Source Database Tablespaces](#) (page 25-31)
 - [Duplicating an Oracle RAC Database](#) (page 25-32)
 - [Duplicating Sparse Databases](#) (page 25-33)
-
-

25.4.1 Duplicating the Whole Database

Use the `DUPLICATE` command to duplicate databases.

To duplicate a database:

1. Ensure that the prerequisites for the selected duplication technique are met.
See [Prerequisites for Duplicating a Database](#) (page 25-15).
2. Complete the required planning tasks before you begin database duplication.
See [Planning to Duplicate a Database](#) (page 25-15).
3. Prepare the auxiliary instance that is used when creating the duplicate database.
See [Preparing the Auxiliary Instance](#) (page 25-23).
4. Start RMAN and connect to required databases. Depending on your duplication technique, you may need to connect to one or more of the following: target database, auxiliary instance, or recovery catalog.
See [Starting RMAN and Connecting to Databases](#) (page 25-36).
5. Place the source database in a proper state (if necessary).
See [Placing the Source Database in the Proper State](#) (page 25-36).
6. (Optional) Configure RMAN channels to improve duplication performance. Channels perform the primary task of duplicating the database. .
See [Configuring RMAN Channels for Use in Duplication](#) (page 25-34).
7. Use the `DUPLICATE` command to duplicate the source database.
See [Using the DUPLICATE Command to Duplicate Databases](#) (page 25-38).

When you perform active database duplication, you can encrypt or compress the backup sets that are used to transfer files from the source database to the duplicate database. Additionally, you can create backup sets on the source database in parallel by using multisection backups.

See Also:

[Basic Concepts of Database Duplication](#) (page 25-2)

25.4.2 Duplicating a Subset of the Source Database Tablespaces

You can duplicate specified tablespaces within a source database.

To duplicate some tablespaces in a database:

1. Ensure that the prerequisites for the selected duplication technique are met.
See [Prerequisites for Duplicating a Database](#) (page 25-15).
2. Complete the required planning tasks before you begin database duplication.
See [Planning to Duplicate a Database](#) (page 25-15).
3. Prepare the auxiliary instance that is used when creating the duplicate database.
See [Preparing the Auxiliary Instance](#) (page 25-23).
4. Start RMAN and connect to required databases. Depending on your duplication technique, you may need to connect to one or more of the following: target database, auxiliary instance, or recovery catalog.
See [Starting RMAN and Connecting to Databases](#) (page 25-36).
5. Place the source database in a proper state (if necessary).
See [Placing the Source Database in the Proper State](#) (page 25-36).
6. (Optional) Configure RMAN channels to improve duplication performance. Channels perform the primary task of duplicating the database.
See [Configuring RMAN Channels for Use in Duplication](#) (page 25-34).
7. Run the `Duplicate` command with one or more of the options in [Table 1-1](#) (page 25-3).

Other factors that influence what tablespaces are copied include the `OFFLINE NORMAL` option. When tablespaces are taken offline with the `OFFLINE NORMAL` option before duplication, RMAN does not duplicate the associated data files, and issues `DROP TABLESPACE` statement for these tablespaces on the duplicate database. Therefore, you do not have to specify options to exclude these tablespaces.

Note:

RMAN does duplicate tablespaces that are taken offline with any other option besides `NORMAL` (unless they are named in a `SKIP TABLESPACE` option). Only `OFFLINE NORMAL` tablespaces are skipped automatically. As with online tablespaces, RMAN requires a valid backup for these tablespaces when you use backup-based duplication.

Example 25-3 *Excluding Read-Only Tablespaces*

This example shows how to skip read-only tablespaces during database duplication

```
DUPLICATE TARGET DATABASE TO dupdb
FROM ACTIVE DATABASE
SKIP READONLY;
```

Example 25-4 Excluding Specified Tablespaces

This example shows how to skip a tablespace named `tools` during database duplication.

```
DUPLICATE TARGET DATABASE
  TO dupdb
FROM ACTIVE DATABASE
SKIP TABLESPACE tools;
```

Example 25-5 Including Specified Tablespaces

You can use the `TABLESPACE` option to specify which tablespaces to include in the specified database. The remaining tablespaces are skipped. The duplicated subset of tablespaces must be self-contained. The resulting set of skipped tablespaces must not have undo segments or materialized views.

This example includes the `users` tablespace, which is assumed to be self-contained, and all other tablespaces are excluded, except for `SYSTEM` and `SYSAUX` tablespaces and tablespaces with undo segments.

```
DUPLICATE TARGET DATABASE
TO dupdb
FROM ACTIVE DATABASE
  TABLESPACE users;
```

Example 25-6 Including Specified Tablespaces with Undo Segments

This example performs backup-based duplication with a target connection, but without a recovery catalog connection. You want to specify a subset of tablespaces for duplication. If the target database is not open in this scenario, then RMAN has no way to obtain the names of the tablespaces with undo segments. Thus, you must specify the `UNDO TABLESPACE` option for these tablespaces. The `users` tablespace must be self-contained. The resulting set of skipped tablespaces must not have undo segments or materialized views.

```
DUPLICATE TARGET DATABASE TO dupdb
  TABLESPACE users
  UNDO TABLESPACE undotbs;
```

25.4.3 Duplicating an Oracle RAC Database

The steps to duplicate an Oracle Real Application Clusters (Oracle RAC) database contain minor variations from the ones used to duplicate databases.

1. Ensure that the prerequisites for the selected duplication technique are met.
See [Prerequisites for Duplicating a Database](#) (page 25-15).
2. Complete the required planning tasks before you begin database duplication.
See [Planning to Duplicate a Database](#) (page 25-15).
3. Prepare the auxiliary instance that is used when creating the duplicate database.

While duplicating an Oracle Real Application Clusters (Oracle RAC) database, set the `CLUSTER_DATABASE` initialization parameter on the auxiliary database to `FALSE`. This parameter can be reset to `TRUE` after the duplication completes.

-
- See [Preparing the Auxiliary Instance](#) (page 25-23).
4. Start RMAN and connect to required databases. Depending on your duplication technique, you may need to connect to one or more of the following: target database, auxiliary instance, or recovery catalog.
See [Starting RMAN and Connecting to Databases](#) (page 25-36).
 5. Place the source database in a proper state (if necessary).
See [Placing the Source Database in the Proper State](#) (page 25-36).
 6. (Optional) Configure RMAN channels to improve duplication performance. Channels perform the primary task of duplicating the database.
See [Configuring RMAN Channels for Use in Duplication](#) (page 25-34).
 7. Use the DUPLICATE command to duplicate the source database.
See [Using the DUPLICATE Command to Duplicate Databases](#) (page 25-38).

Note:

For more information about duplicating an Oracle RAC database, refer to My Oracle Support Note 1617946.1 at <https://support.oracle.com/rs?type=doc&id=1617946.1>

25.4.4 Duplicating Sparse Databases

The duplication process for a sparse database begins with an implicit restore and then completes duplicating the database containing sparse data files.

Ensure that the backing file of the sparse data file is available for duplication.

Note:

Active database duplication is not allowed for sparse databases.

To duplicate a sparse database:

1. Ensure that the prerequisites for the selected duplication technique are met.
See [Prerequisites for Duplicating a Database](#) (page 25-15).
2. Complete the required planning tasks before you begin database duplication.
See [Planning to Duplicate a Database](#) (page 25-15).
3. Prepare the auxiliary instance that is used when creating the duplicate database.
While duplicating an Oracle Real Application Clusters (Oracle RAC) database, set the CLUSTER_DATABASE initialization parameter on the auxiliary database to FALSE. This parameter can be reset to TRUE after the duplication completes.
See [Preparing the Auxiliary Instance](#) (page 25-23).

4. Start RMAN and connect to required databases. Depending on your duplication technique, you may need to connect to one or more of the following: target database, auxiliary instance, or recovery catalog.

See [Starting RMAN and Connecting to Databases](#) (page 25-36).

5. Place the source database in a proper state (if necessary).

See [Placing the Source Database in the Proper State](#) (page 25-36).

6. (Optional) Configure RMAN channels to improve duplication performance. Channels perform the primary task of duplicating the database.

See [Configuring RMAN Channels for Use in Duplication](#) (page 25-34).

7. Run the DUPLICATE command for the sparse database.

The following command duplicates the sparse database db1 :

```
DUPLICATE FROM SPARSE DATABASE 'DB1' TO 'DUP1';
```

Note:

The base (read-only) data files in a sparse database are not encrypted. Ensure that the base data files are stored in a protected storage and accessed using secured communications.

25.4.5 Configuring RMAN Channels for Use in Duplication

The primary job of database duplication is performed by RMAN channels. Each channel corresponds to an Oracle Database server session that performs the duplication tasks. Depending on the duplication technique, RMAN uses either auxiliary channels or target channels.

Use one of the following methods to configure channels:

- Automatically allocate channels by using the `CONFIGURE` command
- Manually allocate channels by using the `ALLOCATE` command

If no automatic channels are configured, then you can manually allocate at least one channel before you begin the duplication. The `ALLOCATE` command that allocates channels must be in the same `RUN` block as the `DUPLICATE` command.

RMAN can use the same channel configurations on the source database for duplication on the destination host even if the source database channels do not specify the `AUXILIARY` option.

See Also:

- [Configuring Channels for Backup-based Duplication](#) (page 25-35)
 - [Configuring Channels for Active Database Duplication](#) (page 25-36)
-
-

25.4.5.1 Configuring Channels for Backup-based Duplication

For backup-based duplication, the principal work of the duplication is performed by the auxiliary channels. An auxiliary channel corresponds to a server session on the auxiliary instance on the destination host. RMAN uses the channels to restore backups in the auxiliary instance.

Configure additional auxiliary channels to improve the performance of the duplicate operation. If you do not explicitly configure auxiliary channels, then RMAN uses the same channel configurations on the source database for duplication on the destination host. RMAN can use these configurations even if the source database channels do not specify the `AUXILIARY` option.

Note the following additional considerations:

- With disk-based backups, you can increase the speed of the duplication operation by allocating additional channels.
With tape-based duplication, you can allocate only as many channels as the number of tape devices available.
- The channel type (`DISK` or `sbt`) of the auxiliary channel must match the backup media. In general, the more channels you allocate for disk backups, the faster the duplication. You cannot increase the speed of duplication after the disks reach their maximum read/write rate. For tape backups, limit the number of channels to the number of devices available.
- If the auxiliary channels need special parameters (for example, to point to a different media manager), then you can configure an automatic channel with the `AUXILIARY` option of the `CONFIGURE` command.
- When you perform duplication without a target connection and without a recovery catalog, only disk channels can be used. If no user-allocated channels are used, then only one channel initially restores the control file. After the control file is mounted, the number of allocated channels depends on the configuration in the restored control file.
- If you omit the `USING BACKUPSET` clause from the `DUPLICATE` command and the number of allocated auxiliary channels is greater than or equal to the number of target channels, then RMAN still uses active database duplication with backup sets.
- If the auxiliary channels cannot access backups of the required data files and archived redo log files, then the duplication fails.

Example: Configuring Auxiliary Channels for Disk-based Backups

The following example allocates three auxiliary channels to duplicate a database to disk.

```
run
{
  ALLOCATE AUXILIARY CHANNEL c1 DEVICE TYPE disk;
  ALLOCATE AUXILIARY CHANNEL c2 DEVICE TYPE disk;
  ALLOCATE AUXILIARY CHANNEL c3 DEVICE TYPE disk;
  . . .
  DUPLICATE DATABASE . . . ;
}
```

25.4.5.2 Configuring Channels for Active Database Duplication

In active database duplication, you need not change your source database channel configuration or configure auxiliary channels. However, you may want to increase the parallelism setting of the source database disk channels so that RMAN copies files over the network in parallel.

The type of active database duplication technique used determines which channels perform the principal work of duplication. When image copies are used to perform active database duplication, the primary work is performed by the target channels. Configure multiple target channels on the source database to improve the duplication performance. When active database duplication is performed using backup sets, the principal work of duplication is performed by the auxiliary channels. Therefore, it is recommended that you allocate additional auxiliary channels. The number of auxiliary channels must be greater than or equal to the number of target channels. Using backup sets for active duplication also enables parallelism which can improve the speed of the duplication process.

25.4.6 Placing the Source Database in the Proper State

Note:

If you are performing backup-based duplication without a target connection, then skip to [Starting RMAN and Connecting to Databases](#) (page 25-36)

If RMAN is connected to the source database as `TARGET`, then the source database must be in the proper state for the duplication.

To ensure that the source database is in the proper state:

1. If the source database instance is not mounted or open, then mount or open it.
2. If you are performing active database duplication, then ensure that the following additional requirements are met:
 - If the source database is open, then archiving must be enabled.
 - If the source database is not open, then the database does not require instance recovery.

25.4.7 Starting RMAN and Connecting to Databases

In this task, you must start the RMAN client and connect to the database instances required by the duplication technique chosen in [Choosing a Duplication Technique](#) (page 25-15). The RMAN client can be located on any host so long as it can connect to the necessary databases over the network.

To start RMAN and connect to the target and auxiliary instances:

1. Start the RMAN client on any host that can connect to the necessary database instances.

For example, enter the following command at the operating system prompt on the destination host:

```
% rman
```

2. At the RMAN prompt, run `CONNECT` commands for the database instances required for your duplication technique.

Note:

When duplicating a whole CDB or one or more PDBs, connect to the root of both instances.

- For active database duplication using image copies, you must connect to the source database as `TARGET` and to the auxiliary instance as `AUXILIARY`. You must supply the net service name to connect to the `AUXILIARY` instance. A recovery catalog connection is optional. A recovery catalog connection is optional. On both instances, the password for the user performing the duplication must be the same. Any user with a `SYSDBA` or `SYSBACKUP` privilege can perform duplication.
 - For active database duplication using backup sets, you must connect to the source database as `TARGET` using a net service name. The auxiliary instance uses this net service name to connect to the source database and retrieve the backup sets required for the duplication. Connect to the auxiliary instance as `AUXILIARY`. If you are connecting to the auxiliary instance remotely or intend to use the `PASSWORD FILE` option of the `DUPLICATE` command, then connect to the auxiliary instance with a net service name. On both instances, the password for the user performing the duplication must be the same. Any user with a `SYSDBA` or `SYSBACKUP` privilege can perform duplication. A recovery catalog connection is optional.
 - For backup-based duplication *without* a target connection, you must connect to the auxiliary instance as `AUXILIARY` and the recovery catalog as `CATALOG`.
 - For backup-based duplication *with* a target connection, you must connect to the source database as `TARGET` and the auxiliary instance as `AUXILIARY`. A recovery catalog is optional.
 - For backup-based duplication without target and recovery catalog connections, you must connect to the auxiliary instance as `AUXILIARY`.
-
-

Note:

You cannot connect as `TARGET` to a standby database.

Example: Connecting to the Required Databases When Performing Active Database Duplication

In this example, a connection is established to the source database and the auxiliary instance using net service names. The Net Service name of the source database is `srcdb` and that of the auxiliary instance is `dupdb`.

To connect to required databases from the destination host:

1. Start the RMAN client on the destination host.

```
% rman
```
2. Connect to the source database as `TARGET`.

```
RMAN> CONNECT TARGET sys@srcdb;
```

Enter the password for the SYS user on the source database when prompted

3. Connect to the auxiliary instance as AUXILIARY.

```
RMAN> CONNECT AUXILIARY sys@dupdb;
```

Enter the password for the SYS user on the auxiliary instance when prompted.

25.4.8 Using the DUPLICATE Command to Duplicate Databases

Depending on your requirement, use one of the following syntaxes of the DUPLICATE command:

- DUPLICATE DATABASE or DUPLICATE ... ACTIVE DATABASE

Use these for duplicating non-CDBs and CDBs.

- DUPLICATE DATABASE ... FOR STANDBY

Use this to create a standby database by duplicating the source database.

Use the DUPLICATE DATABASE ... FOR FARSYNC command to create an Oracle Data Guard far sync instance using duplication.

- DUPLICATE PLUGGABLE DATABASE

Use this to duplicate one or more PDBs while connected to the root.

When you use the SET NEWNAME command to specify alternate names for duplicate database files, ensure that you enclose the DUPLICATE command and the SET NEWNAME commands within a RUN block.

See Also:

- [Examples: Duplicating Databases](#) (page 25-45)
 - *Oracle Database Backup and Recovery Reference* for examples on duplication
-

25.5 Duplicating CDBs and PDBs

Use the DUPLICATE command to duplicate multitenant container databases (CDBs), one or more pluggable databases (PDBs), sparse CDBs, and sparse PDBs. The steps to duplicate CDBs and PDBs are similar to those of duplicating non-CDBs with minor variations to the procedure for duplicating a non-CDB. This section describes how to duplicate CDBs and PDBs.

See Also:

- [Duplicating CDBs](#) (page 25-39)
 - [Duplicating PDBs](#) (page 25-41)
 - [Duplicating Tablespaces Within a PDB](#) (page 25-44)
-

25.5.1 Duplicating CDBs

Duplicating a whole multitenant container database (CDB) or one or more pluggable databases (PDBs) requires only minimal adjustments to the procedure for duplicating a non-CDB as described in [Duplicating the Whole Database](#) (page 25-30).

To duplicate a CDB:

1. Complete the planning tasks described in [Planning to Duplicate a Database](#) (page 25-15) with the following change:

In [Making Backups Accessible to the Duplicate Instance](#) (page 25-20) and [Making Disk Backups Accessible Without Shared Disk](#) (page 26-10), note the following adjustment:

Use the `PLUGGABLE DATABASE` syntax of the `BACKUP` command to copy only the backups of a specific PDB.

The following command transfers the backup files for the entire CDB:

```
BACKUP COPY OF DATABASE;
```

The following command transfers only the backup files for the PDB `pdb3`:

```
BACKUP COPY OF PLUGGABLE DATABASE pdb3;
```

2. Ensure that the prerequisites for the selected duplication technique are met. See [Prerequisites for Duplicating a Database](#) (page 25-15).
3. Prepare the auxiliary instance as described in [Preparing the Auxiliary Instance](#) (page 25-23), with the following changes:
 - You must create the auxiliary instance as a CDB. To do so, start the instance with the following declaration in the initialization parameter file:

```
enable_pluggable_database=TRUE
```
 - When instructed to create an initialization parameter file for the auxiliary instance, you must copy the file from the source database. This ensures that the auxiliary instance is also a CDB. After copying, perform the following steps:
 - Modify the `DB_NAME` parameter
 - Modify the various destination/location parameters
 - When instructed to connect to the necessary instances, connect to the root as a user with `SYSDBA` or `SYSBACKUP` privilege. On both instances, the password for the user performing the duplication must be the same.
4. Start RMAN and connect to the root as a user with the `SYSDBA` or `SYSBACKUP` privilege.

On both the auxiliary instance and the target database, the password for the user performing the duplication must be the same.
5. Place source database in proper state (if necessary).

See [Placing the Source Database in the Proper State](#) (page 25-36).
6. Configure RMAN channels (if necessary).

The primary task of duplication is performed by RMAN channels. Configuring additional channels improves the duplication performance.

See [Configuring RMAN Channels for Use in Duplication](#) (page 25-34).

7. Use the `DUPLICATE` command to duplicate the source CDB.

See [Using the DUPLICATE Command to Duplicate Databases](#) (page 25-38).

25.5.2 Duplicating Sparse CDBs

Use the `DUPLICATE` command to duplicate sparse multitenant container databases (CDBs).

To duplicate a sparse CDB:

1. Complete the planning tasks described in [Planning to Duplicate a Database](#) (page 25-15) with the following change:

In [Making Backups Accessible to the Duplicate Instance](#) (page 25-20) and [Making Disk Backups Accessible Without Shared Disk](#) (page 26-10), note the following adjustment:

Use the `PLUGGABLE DATABASE` syntax of the `BACKUP` command to copy only the backups of a specific PDB.

The following command transfers the backup files for the entire CDB:

```
BACKUP COPY OF DATABASE;
```

The following command transfers only the backup files for the PDB `pdb3`:

```
BACKUP COPY OF PLUGGABLE DATABASE pdb3;
```

2. Ensure that the prerequisites for the selected duplication technique are met as described in [Prerequisites for Duplicating a Database](#) (page 25-15).
3. Prepare the auxiliary instance as described in [Preparing the Auxiliary Instance](#) (page 25-23), with the following changes:
 - You must create the auxiliary instance as a CDB. To do so, start the instance with the following declaration in the initialization parameter file:

```
enable_pluggable_database=TRUE
```
 - When instructed to create an initialization parameter file for the auxiliary instance, you must copy the file from the source database. This ensures that the auxiliary instance is also a CDB. After copying, perform the following steps:
 - Modify the `DB_NAME` parameter
 - Modify the various destination/location parameters
 - When instructed to connect to the necessary instances, connect to the root as a user with `SYSDBA` or `SYSBACKUP` privilege. On both instances, the password for the user performing the duplication must be the same.
4. Start RMAN and connect to the root as a user with the `SYSDBA` or `SYSBACKUP` privilege.

On both the auxiliary instance and the target database, the password for the user performing the duplication must be the same.

5. Place source database in proper state (if necessary).

See [Placing the Source Database in the Proper State](#) (page 25-36).

6. Configure RMAN channels (if necessary).

The primary task of duplication is performed by RMAN channels. Configuring additional channels improves the duplication performance.

See [Configuring RMAN Channels for Use in Duplication](#) (page 25-34).

7. Run the `DUPLICATE` command with the `FROM SPARSE` option.

For example, the following command will duplicate the CDB on to `cdb2`:

```
DUPLICATE FROM SPARSE TO cdb2 DATABASE;
```

25.5.3 Duplicating PDBs

RMAN enables you to duplicate PDBs with the `DUPLICATE` command. You can duplicate a single PDB, a set of PDBs, or a set of tablespaces within a PDB. You must be logged in to the root of the CDB as a user who is granted the `SYSDBA` or `SYSDBACKUP` privilege.

To duplicate PDBs, you must create the auxiliary instance as a CDB. To do so, start the auxiliary instance with the declaration `enable_pluggable_database=TRUE` in the initialization parameter file. When you duplicate one or more PDBs, RMAN also duplicates the root (`CDB$ROOT`) and the CDB seed (`PDB$SEED`). The resulting duplicate database is a fully functional CDB that contains the root, the CDB seed, and the duplicated PDBs. [Table 25-3](#) (page 25-41) describes the options that you can use to duplicate PDBs or tablespaces within PDBs.

Table 25-3 Options to Duplicate PDBs

DUPLICATE Option	Explanation
<code>PLUGGABLE DATABASE <i>pdb_name</i></code>	Duplicates the specified PDBs in the CDB. Use a comma-delimited list to duplicate multiple PDBs.
<code>SKIP PLUGGABLE DATABASE <i>pdb_name</i></code>	Duplicates all the PDBs in the CDB, except the PDBs specified by <i>pdb_name</i> . Use a comma-delimited list to specify multiple PDBs that must be excluded.
<code>TABLESPACE <i>pdb_name:tablespace_name</i></code>	Duplicates specified tablespaces within a PDB. The tablespace name must be prefixed with the name of the PDB that contains the tablespace. If you omit the name of the PDB, root is taken as the default.
<code>SKIP TABLESPACE <i>pdb_name:tablespace_name</i></code>	Duplicates all tablespaces in the CDB except the specified tablespaces in the specified PDB.

To duplicate a PDB:

1. Complete the planning tasks described in [Planning to Duplicate a Database](#) (page 25-15) with the following change:

In [Making Backups Accessible to the Duplicate Instance](#) (page 25-20) and [Making Disk Backups Accessible Without Shared Disk](#) (page 26-10), note the following adjustment:

Use the `PLUGGABLE DATABASE` syntax of the `BACKUP` command to copy only the backups of a specific PDB.

For example, the following command transfers only the backups files for the PDB `pdb3`:

```
BACKUP COPY OF PLUGGABLE DATABASE pdb3 ;
```
2. Ensure that the prerequisites for the selected duplication technique are met.

See [Prerequisites for Duplicating a Database](#) (page 25-15).
3. Prepare the auxiliary instance as described in [Preparing the Auxiliary Instance](#) (page 25-23), with the following changes:
 - You must create the auxiliary instance as a CDB. To do so, start the instance with the following declaration in the initialization parameter file:

```
enable_pluggable_database=TRUE
```
 - When instructed to create an initialization parameter file for the auxiliary instance, you must copy the file from the source database. This ensures that the auxiliary instance is also a CDB. After copying, perform the following steps:
 - Modify the `DB_NAME` parameter
 - Modify the various destination/location parameters
 - When instructed to connect to the necessary instances, connect to the root as a user with `SYSDBA` or `SYSBACKUP` privilege. On both instances, the password for the user performing the duplication must be the same.
4. Start RMAN and connect to the root as a user with the `SYSDBA` or `SYSBACKUP` privilege.

On both the auxiliary instance and the target database, the password for the user performing the duplication must be the same.
5. Place source database in proper state (if necessary).

See [Placing the Source Database in the Proper State](#) (page 25-36).
6. Configure RMAN channels (if necessary).

The primary task of duplication is performed by RMAN channels. Configuring additional channels improves the duplication performance.

See [Configuring RMAN Channels for Use in Duplication](#) (page 25-34).
7. Duplicate the PDB by using the `DUPLICATE ... PLUGGABLE DATABASE` command.

Examples: Duplicating PDBs

- To duplicate the PDB `pdb1` to the CDB `cdb1`, use the following command:

```
DUPLICATE DATABASE TO cdb1 PLUGGABLE DATABASE pdb1;
```

- To duplicate the PDBs pdb1, pdb3, and pdb4 to the database cdb1, use the following command:

```
DUPLICATE DATABASE TO cdb1 PLUGGABLE DATABASE
pdb1 ,pdb3 ,pdb4 ;
```

- To duplicate all the PDBs in the CDB, except the PDB pdb3, use the following command:

```
DUPLICATE DATABASE TO cdb1 SKIP PLUGGABLE DATABASE pdb3 ;
```

25.5.4 Duplicating Sparse PDBs

Use the `DUPLICATE` command to duplicate sparse pluggable databases (PDBs).

To duplicate a sparse PDB:

1. Complete the planning tasks described in "[Planning to Duplicate a Database](#) (page 25-15)" with the following change:

In "[Making Backups Accessible to the Duplicate Instance](#) (page 25-20)" and "[Making Disk Backups Accessible Without Shared Disk](#) (page 26-10)", use the `PLUGGABLE DATABASE` syntax of the `BACKUP` command to copy only the backups of a specific PDB.

For example, the following command transfers only the backups files for the PDB pdb3:

```
BACKUP COPY OF PLUGGABLE DATABASE pdb3 ;
```

2. Ensure that the prerequisites for the selected duplication technique are met as described in "[Prerequisites for Duplicating a Database](#) (page 25-15)".
3. Prepare the auxiliary instance as described in "[Preparing the Auxiliary Instance](#) (page 25-23)", with the following changes:
 - Create the auxiliary instance as a CDB. To do so, start the instance with the following declaration in the initialization parameter file:

```
enable_pluggable_database=TRUE
```
 - When instructed to create an initialization parameter file for the auxiliary instance, you must copy the file from the source database. This ensures that the auxiliary instance is also a CDB. After copying, perform the following steps:
 - Modify the `DB_NAME` parameter
 - Modify the various destination/location parameters
 - When instructed to connect to the necessary instances, connect to the root as a user with `SYSDBA` or `SYSBACKUP` privilege. On both instances, the password for the user performing the duplication must be the same.
4. Start `RMAN` and connect to the root as a user with the `SYSDBA` or `SYSBACKUP` privilege.

On both the auxiliary instance and the target database, the password for the user performing the duplication must be the same.

5. Place source database in proper state (if necessary) as described in "[Placing the Source Database in the Proper State](#) (page 25-36)".
6. (Optional) Configure RMAN channels to improve duplication performance as described in "[Configuring RMAN Channels for Use in Duplication](#) (page 25-34)".
7. Run the DUPLICATE command with the PLUGGABLE DATABASE and FROM SPARSE options.

To duplicate PDB pdb1 to CDB cdb2, run the following command:

```
DUPLICATE FROM SPARSE to cdb2 PLUGGABLE DATABASE pdb1;
```

Note:

The base (read-only) data files in a sparse database are not encrypted. Ensure that the base data files are stored in a protected storage and accessed using secured communications.

25.5.5 Duplicating Tablespaces Within a PDB

You can duplicate one or more tablespaces within a PDB by using the DUPLICATE command.

To duplicate tablespaces within a PDB:

1. Ensure that you have completed Steps 1 to 4 in [Duplicating PDBs](#) (page 25-41).
2. Run the DUPLICATE command with the TABLESPACE option described in [Table 25-3](#) (page 25-41).

The following are some examples of duplicating tablespaces contained in PDBs:

To duplicate the `users` tablespace that is part of PDB `pdb1`, use the following command:

```
DUPLICATE DATABASE TO cdb1 TABLESPACE pdb1:users;
```

To duplicate the PDB `pdb1` and the `users` tablespace in PDB `pdb2`, use the following command:

```
DUPLICATE DATABASE TO cdb1 PLUGGABLE DATABASE pdb1
TABLESPACE pdb2:users;
```

25.6 Restarting DUPLICATE After a Failure

RMAN automatically optimizes a DUPLICATE command that is a repeat of a previously failed DUPLICATE command. The repeat DUPLICATE command notices which data files were successfully copied earlier and does not copy them again. This applies to all forms of duplication, whether they are backup-based (with or without a target connection) or active database duplication. The automatic optimization of the DUPLICATE command can be especially useful when a failure occurs during the duplication of very large databases.

To restart a DUPLICATE operation:

1. Exit RMAN.

2. Start SQL*Plus and connect to the auxiliary instance with SYSDBA or SYSBACKUP privilege. Start the auxiliary instance in NOMOUNT mode with the same SPFILE or PFILE specification that you used initially. If you omitted this specification initially, then omit it again here.

This example starts the auxiliary instance using the parameters in /home/my_pfile.ora:

```
STARTUP FORCE PFILE=/home/my_pfile.ora
```

3. Exit SQL*Plus and start RMAN.
4. Connect to the same databases as initially
5. Repeat the DUPLICATE command.

The second DUPLICATE operation:

- Locates the data files that were successfully duplicated by the initial DUPLICATE command.
- Displays a message similar to the following for each data file that it does not need to duplicate again:

```
RMAN-05560: Using previous duplicated file /oradata/new/data01.f for
datafile 1 with checkpoint SCN of 1654665
```

- Restores only the missing or incomplete data files, thereby avoiding recopying and restoring all the data files.

If you do not want RMAN to automatically recover from a failed DUPLICATE operation, specify the keyword NORESUME to disable the functionality. Using the keyword NORESUME in the first invocation of DUPLICATE prevents a subsequent DUPLICATE command for the new database from using this automatic optimization.

25.7 Examples: Duplicating Databases

This section contains examples on duplicating databases using different duplication techniques.

See Also:

- [Example: Duplicating a Database to a Remote ASM Host Using Active Database Duplication with Backup Sets](#) (page 25-46)
 - [Example: Duplicating a Database to a Remote Host Using Active Database Duplication with Image Copies](#) (page 25-48)
 - [Example: Duplicating a Database to a Remote Host by Using Backup-based Duplication without a Target Connection or Recovery Catalog](#) (page 25-49)
 - [Example: Duplicating a Database to a Remote Host by Using Backup-Based Duplication with a Recovery Catalog](#) (page 25-51)
 - [Example: Duplicating a Database to a Remote Host by Using Backup-based Duplication with a Target Connection](#) (page 25-53)
 - [Example: Performing Backup-based Duplication Using Encrypted Backups](#) (page 25-55)
-
-

25.7.1 Example: Duplicating a Database to a Remote ASM Host Using Active Database Duplication with Backup Sets

This example assumes the following scenario:

- The source host and the destination host are different.
- Both the source database and the duplicate database manage database files using ASM.
- The duplicate database files use a different directory structure than the source database.
- Network bandwidth on the source host is limited.
- The duplicate database must be opened after the duplication process completes.

Use the following steps to create a duplicate database for the scenario described in this example:

1. Plan the duplication as described in "[Planning to Duplicate a Database](#) (page 25-15)". This includes the following tasks:
 - Choose a duplication technique that suits the scenario and requirements.
Because network bandwidth on the source host is limited, we perform active database duplication using backup sets.
 - Choose a strategy to name duplicate database files.
In this example, the `DB_CREATE_FILE_DEST` initialization parameter is used to specify the location of the duplicate database files.
 - Configure six auxiliary channels on the auxiliary instance.
In this example, there are two target channels configured on the source database. For RMAN to use backup sets to perform active database

duplication, the number of auxiliary channels must be equal to or greater than the number of target channels.

See "[Configuring RMAN Channels for Use in Duplication](#) (page 25-34)".

2. Ensure that the prerequisites for the chosen duplication technique are met.

See "[Prerequisites for Duplicating a Database](#) (page 25-15)".

3. Prepare the auxiliary instance as described in "[Preparing the Auxiliary Instance](#) (page 25-23)".

- Create the disk groups that will store the database files on the destination host.

If it does not already exist, create the +DGROUP2 disk group to store the duplicate database files.

- Copy the password file from the source database to the destination database as described in "[Creating a Password File for the Auxiliary Instance](#) (page 25-26)".

- Set up Oracle Net Services connectivity between the source database and the auxiliary instance using a static listener.

- Copy the source database software keystore to the destination host. Specify the password that must be used to open the password-based software keystore using the SET command.

See "[Making the Oracle Keystore Available to the Destination Host](#) (page 25-28)".

- Start the auxiliary instance in NOMOUNT mode as described in "[Starting the Auxiliary Instance](#) (page 25-28)".

4. Start RMAN and connect to the source database as TARGET and to the auxiliary instance as AUXILIARY.

```
%rman
RMAN> CONNECT TARGET sys@srcdb as SYSDBA;
RMAN> CONNECT AUXILIARY sys@dupdb AS SYSBACKUP;
```

Note: For active database duplication, connection to the auxiliary instance must also use password file authentication.

5. Duplicate the database using the DUPLICATE command.

The SPFILE clause directs RMAN to copy the server parameter file from the source database to the auxiliary instance. Use the DB_CREATE_FILE_DEST parameter to specify the disk group that is used to store the duplicate database files in the duplicate database.

```
DUPLICATE DATABASE to dupdb
FROM ACTIVE DATABASE
PASSWORD FILE
SPFILE
SET DB_CREATE_FILE_DEST='+DGROUP2' ;
```

See Also: [Examples: Duplicating Databases](#) (page 25-45)

25.7.2 Example: Duplicating a Database to a Remote Host Using Active Database Duplication with Image Copies

This example assumes the following scenario:

- The source host and the destination host are different.
- The duplicate database files use a directory structure that is different from that of the source database.
- The source database and the duplicate database use Oracle Managed Files (OMF) to create database files.
- The source database must be available during the duplication process.
- The duplicate database must be opened after the duplication process completes.

Use the following steps to create a duplicate database for the scenario described in this example:

1. Plan the duplication as described in "[Planning to Duplicate a Database](#) (page 25-15)". This includes the following tasks:
 - Choose a duplication technique that suits the scenario and requirements.
Since the bandwidth between the source and destination is limited, we perform active database duplication using image copies.
 - Choose a strategy to name duplicate database files.
In this example, the `DB_FILE_NAME_CONVERT` and `LOG_FILE_NAME_CONVERT` initialization parameters are used to specify how the source database file names are converted to duplicate database file names.
 - When performing active database duplication using image copies, RMAN uses image copies either if no auxiliary channels are configured or if the number of auxiliary channels is lesser than the number of target channels. Therefore, no additional channels need to be configured to perform active database duplication using image copies.
2. Ensure that the prerequisites for the chosen duplication technique are met.
See "[Prerequisites for Duplicating a Database](#) (page 25-15)".
3. Prepare the auxiliary instance as described in "[Preparing the Auxiliary Instance](#) (page 25-23)".
 - Create the directories that will store the database files on the destination host.
In this example, create the `/app/db_home2/database` directory to store the data files, control file, and server parameter file and the `/app/db_home2/logfiles` directory to store the online redo log files.
 - On the destination host, create a minimal initialization parameter file for the auxiliary instance. The file is called `initdup.ora` and is located in the `/app/db_home1/database` directory. It contains the following entries:

```
DB_NAME=dup
DB_DOMAIN = dup.example.com
```

See ["Creating an Initialization Parameter File for the Auxiliary Instance \(page 25-23\)"](#).

- Copy the password file from the source database to destination host as described in ["Creating a Password File for the Auxiliary Instance \(page 25-26\)"](#)
 - Set up Oracle Net Services connectivity between the source database and the auxiliary instance using a static listener as described in ["Establishing Oracle Net Connectivity Between the Source Database and Auxiliary Instance \(page 25-27\)"](#).
 - Start the auxiliary instance in NOMOUNT mode as described in ["Starting the Auxiliary Instance \(page 25-28\)"](#).
4. Start RMAN and connect to the source database as TARGET and to the auxiliary instance as AUXILIARY.

```
% rman
RMAN> CONNECT TARGET sys@srcdb as SYSDBA;
RMAN> CONNECT AUXILIARY sys@dupdb AS SYSBACKUP;
```

Note: For active database duplication, connection to the auxiliary instance must also use password file authentication.

5. Duplicate the database using the DUPLICATE command. Include the SPFILE clause with the DB_FILE_NAME_CONVERT and LOG_FILE_NAME_CONVERT parameters to specify that the server parameter file from the source database must be used for the auxiliary instance.

The duplicate database files are stored in the duplicate database using OMF-generated names. The PARAMETER_VALUE_CONVERT option of the SPFILE clause specifies that the path name /app/db_home1 should be converted to /app_db_home2.

```
DUPLICATE DATABASE TO dupdb
FROM ACTIVE DATABASE
PASSWORD FILE
SPFILE PARAMETER_VALUE_CONVERT='/app/dbhome1', '/app/db_home2'
SET db_file_name_convert='/app/dbhome1/dbs', '/app/db_home2/database/dbs'
SET log_file_name_convert='/app/dbhome1/log', '/app/db_home2/logfiles';
```

See Also:

[Examples: Duplicating Databases \(page 25-45\)](#)

25.7.3 Example: Duplicating a Database to a Remote Host by Using Backup-based Duplication without a Target Connection or Recovery Catalog

This example uses the following scenario:

- A complete backup of the source database including the control files, data files, and archived redo log files is available in the /backups/db_files directory on the destination host.
- A connection to the target database or recovery catalog is not available.
- The source host and destination host are different.

- The duplicate database uses a directory structure that is different from that used by the source database to store the duplicate database files. The data files and control file of the duplicate database files are stored in the `/oracle2/database` directory and the online redo logs files are stored in `/oracle2/database/logs` directory.
- The `DB_NAME` of the source database is `db12` and that of the duplicate database is `dup`.
- The duplicate database must be opened after the duplication process completes.

Use the following steps to create a duplicate database for the scenario described in this example:

1. Plan the duplication as described in "[Planning to Duplicate a Database](#) (page 25-15)". This includes the following tasks:
 - Choose a duplication technique that suits the scenario and requirements.
In this example, backup-based duplication without a target connection or recovery catalog connection is performed. Therefore, we use the `BACKUP LOCATION` clause to specify the location of the source database backups.
 - Because the duplicate database uses a directory structure that is different from the source database, you must choose a strategy to generate duplicate database file names.
In this example, the `SET NEWNAME FOR DATABASE` command specifies the location of the data files and control file. The `LOGFILE` clause of the `DUPLICATE` command specifies the location of the online redo log files.
 - Copy the required backups to the destination host using the same directory structure used on the source database.
In this example, the backups of the data files and archived redo log files must be stored in `/backups/db_files` and the backups of the control files and server parameter file in `/backups/cf` on the destination host.
2. Ensure that the prerequisites for the chosen duplication technique are met.
See "[Prerequisites for Duplicating a Database](#) (page 25-15)".
3. Prepare the auxiliary instance.
 - Create the directories that will store the duplicate database files on the destination host.
In this example, you create the `/oracle2/database` directory to store the data files, control file, and server parameter file. Create the `/oracle2/database/logs` directory to store the online redo log files.
 - Create a minimal initialization parameter file for the auxiliary instance. The file is called `initdup.ora` and is located in the `/oracle2/database` directory. In addition to any other specific settings, it must contain the following entries:

```
DB_NAME = dup
DB_DOMAIN = dupdb.example.com
```

See "[Creating an Initialization Parameter File for the Auxiliary Instance](#) (page 25-23)".

- Create a password file for the auxiliary instance by using the `orapwd` utility. A password file is required because the duplicate database is being created on a remote host.
See "[Creating a Password File for the Auxiliary Instance](#) (page 25-26)".
 - Set up Oracle Net Services connectivity between the source database and the auxiliary instance using a static listener. This is required because this example duplicates a database to a remote host.
See "[Establishing Oracle Net Connectivity Between the Source Database and Auxiliary Instance](#) (page 25-27)".
 - Start the auxiliary instance in NOMOUNT mode as described in "[Starting the Auxiliary Instance](#) (page 25-28)".
4. Start RMAN and connect to the source database as TARGET and to the auxiliary instance as AUXILIARY.

```
%rman
RMAN> CONNECT TARGET /
RMAN> CONNECT AUXILIARY sys@dup AS SYSBACKUP;
```

Enter the passwords when prompted.

5. Duplicate the database by using the DUPLICATE command.

Include the `BACKUP LOCATION` clause to specify the location of the source database backups. Enclose the `SET NEWNAME FOR DATABASE` and `DUPLICATE` command within a `RUN` block. The `LOGFILE` clause specifies the names and location of the online redo log files.

```
run
{
set newname for database to '/oracle2/database/%b';
duplicate database 'dbl2' to 'dup'
logfile group 1 ('/oracle2/database/logs/r1.f', '/ oracle2/database/logs/r2.f')
size 4m reuse,
      group 2 ('/ oracle2/database/logs/r3.f', '/oracle2/database/logs/r4.f')
size 4m reuse
backup location '/backups/db_files';
}
```

See Also:

[Examples: Duplicating Databases](#) (page 25-45)

25.7.4 Example: Duplicating a Database to a Remote Host by Using Backup-Based Duplication with a Recovery Catalog

This example assumes the following scenario:

- A complete backup of the source database is available on the source host. The backups of the data files and archived redo log files are stored in `/bkups/db_files`. The backups of the control files and server parameter file are stored in `/bkups/cf`.
- A connection to the source database is not available, but a connection to the recovery catalog is available.

- The source host and destination host are different. The destination host used OMF and has the Oracle Database software installed.
- The duplicate database stores database files in a different directory structure than the source database. The database files of the duplicate database must be stored in the `/app/oracle2/dbs` directory.
- The `DB_NAME` of the source database is `ora` and its Net Service name is `oradb`. The `DB_NAME` of the duplicate database is `dup` and its Net Service name is `dupdb`.
- The read-only tablespaces in the source database must be excluded from the duplicate database.
- The duplicate database must not be opened after the duplication process completes.

Use the following steps to create a duplicate database for the scenario described in this example:

1. Plan the duplication as described in "[Planning to Duplicate a Database](#) (page 25-15)". This includes the following tasks:
 - Choose a duplication technique that suits the scenario and requirements.
In this example, backup-based duplication using a recovery catalog connection is performed.
 - Choose a strategy to generate duplicate database file names.
Since the duplicate database uses OMF, use the `DB_CREATE_FILE_DEST` parameter in the auxiliary instance's initialization parameter file to specify the directory in which the duplicate database files are stored.
 - Use the `NOOPEN` clause of the `DUPLICATE` command to specify that the duplicate database must not be opened using `RESETLOGS` after the duplication completes.
 - Copy the required backups to the destination host using the same directory structure used on the source database.
In this example, the backups of the data files and archived redo log files must be stored in `/scratch/db_files` and the backups of the control files and server parameter file in `/scratch/cf` on the destination host.
2. Ensure that the prerequisites for the chosen duplication technique are met.
See "[Prerequisites for Duplicating a Database](#) (page 25-15)".
3. Prepare the auxiliary instance as described in "[Preparing the Auxiliary Instance](#) (page 25-23)".
 - Create the directories that will store the duplicate database files on the destination host.
In this example, you create the `/app/oracle2/dbs` directory to store the data files, control file, online redo log files, and server parameter file.
 - Create an initialization parameter file for the auxiliary instance. The file is called `initdup.ora` and is located in the `/app/oracle2/dbs` directory. In addition to any other specific settings, it must contain the following entries:

```
DB_NAME=dup
DB_DOMAIN = dupdb.example.com
DB_CREATE_FILE_DEST= /app/oracle2/dbs
```

See "[Creating an Initialization Parameter File for the Auxiliary Instance](#) (page 25-23)".

- Create a password file for the auxiliary instance by using the orapwd utility. A password file is required because the duplicate database is being created on a remote host.

See "[Creating a Password File for the Auxiliary Instance](#) (page 25-26)".

- Set up Oracle Net Services connectivity between the source database and the auxiliary instance using a static listener. This is required because this example duplicates a database to a remote host.

See "[Establishing Oracle Net Connectivity Between the Source Database and Auxiliary Instance](#) (page 25-27)".

- Start the auxiliary instance in NOMOUNT mode as described in "[Starting the Auxiliary Instance](#) (page 25-28)".

4. Start RMAN and connect to the source database as TARGET and to the auxiliary instance as AUXILIARY.

```
%rman
RMAN> CONNECT TARGET sys@oradb;
RMAN> CONNECT AUXILIARY sys@dupdb;
```

Enter the passwords when prompted.

5. Duplicate the database by using the DUPLICATE command.

Include the SKIP READONLY clause to exclude the read-only tablespaces from the duplicate database. Because there is no connection to a target database, you must specify the name of the target database that is being duplicated.

```
DUPLICATE DATABASE db12 TO dup
SKIP READONLY;
```

See Also:

[Examples: Duplicating Databases](#) (page 25-45)

25.7.5 Example: Duplicating a Database to a Remote Host by Using Backup-based Duplication with a Target Connection

This example uses the following scenario:

- A complete backup of the source database including the control file, data files, and archived redo log files is available.
- A connection to the source database is available.
- The source host and destination host are different.
- The source database is configured to use transparent encryption with a password-based software keystore.

- The duplicate database uses the same directory structure and file names as the source database to store database files.
On the source host, the data file, control files and server parameter file are stored in `/app/db_home1/database` and the online redo log files are stored in `/app/db_home1/logfiles`.
- The `DB_NAME` of the source database is `src` and its Net Service name is `srcdb`. The `DB_NAME` of the duplicate database is `dup` and its Net Service name is `dupdb`.
- On the source host, backups of the data files and archived redo log files are stored in `/bkups/oradata/db_files`. The backups of the control files and server parameter file are stored in `/bkups/oradata/cf`.
- The tablespaces `HR` and `SH` must be excluded from the duplicate database
The remaining tablespaces in the source database are self-contained and do not have links to `hr` and `sh`.
- The duplicate database must be opened after the duplication process completes.

Use the following steps to create a duplicate database for the scenario described in this example:

1. Plan the duplication as described in "[Planning to Duplicate a Database](#) (page 25-15)". This includes the following tasks:
 - Choose a duplication technique that is suitable for your scenario.
In this example, backup-based duplication using a target connection is performed.
 - Because the duplicate database uses the same directory structure as source database, you need not specify an alternative file naming strategy.
However, use the `NOFILENAMECHECK` clause in the `DUPLICATE` command to prevent RMAN from checking if the data files and online redo logs files of the source database use the same names as that on the duplicate database.
 - Configure three additional auxiliary channels as described in "[Configuring RMAN Channels for Use in Duplication](#) (page 25-34)". Using additional auxiliary channels enhances the performance of the duplication process
 - Copy the required backups to the destination host using the same directory structure used on the source database.
In this example, the backups of the data files and archived redo log files must be stored in `/bkups/oradata/db_files` and the backups of the control file and server parameter file in `/bkups/oradata/cf` on the destination host.
2. Ensure that the prerequisites for the chosen duplication technique are met.
See "[Prerequisites for Duplicating a Database](#) (page 25-15)".
3. Prepare the auxiliary instance as described in "[Preparing the Auxiliary Instance](#) (page 25-23)".
 - Create the directories that will store the duplicate database files on the destination host.
In this example, the source database and the duplicate database use the same directory structure. Create the `/app/database` directory to store the data files,

control file, and server parameter file and the /app/logfiles directory to store the online redo log files.

- Create a minimal initialization parameter file for the auxiliary instance. The file is called `initdup.ora` and is located in the /app/database directory. It contains the following entries:

```
DB_NAME=dup
DB_DOMAIN = dup.example.com
```

See "[Creating an Initialization Parameter File for the Auxiliary Instance](#) (page 25-23)".

- Create a password file for the auxiliary instance by copying the password file from the source database to the duplicate database.

See "[Creating a Password File for the Auxiliary Instance](#) (page 25-26)".

- Set up Oracle Net Services connectivity between the source database and the auxiliary instance using a static listener.

See "[Establishing Oracle Net Connectivity Between the Source Database and Auxiliary Instance](#) (page 25-27)".

- Start the auxiliary instance in NOMOUNT mode as described in "[Starting the Auxiliary Instance](#) (page 25-28)"

4. Start RMAN and connect to the source database as TARGET and to the auxiliary instance as AUXILIARY. These connections are established from the destination host and the auxiliary connection uses operating system authentication.

```
%rman
RMAN> CONNECT TARGET sys@dupdb AS SYSBACKUP;
RMAN> CONNECT AUXILIARY /
```

5. Duplicate the database by using the DUPLICATE command.

Include the `SKIP TABLESPACE` clause to specify the tablespaces that must be omitted during the duplication process. Use the `SPFILE` clause to specify that the server parameter file from the source database must be restored and copied to the duplicate database.

```
DUPLICATE DATABASE TO dup
SPFILE
SKIP TABLESPACE HR, SH
NOFILENAMECHECK;
```

See Also:

[Examples: Duplicating Databases](#) (page 25-45)

25.7.6 Example: Performing Backup-based Duplication Using Encrypted Backups

RMAN enables you to use the `DUPLICATE` command to perform backup-based duplication using encrypted backups.

This example uses the following scenario:

- The source host and destination host are different.
- Both source and destination database use Oracle Managed Files (OMF) to manage database file names. However, the duplicate database uses a directory structure that is different from that of the source database.
- Source database backups are encrypted using transparent-mode encryption with the encryption key stored in a password-based software keystore. The keystore password is set up using a command such as the following (where *password* is a placeholder for the actual password that you enter):

```
ALTER SYSTEM SET ENCRYPTION KEY IDENTIFIED BY password;
```

- A complete backup of the source database including the control files, data files, and archived redo log files is stored in `/oracle2/rman_backups`.
- The `DB_NAME` of source database is `db_src` and that of the duplicate database is `dup_db`.
- The `EXAMPLE` and `TOOLS` tablespaces must be excluded from the duplicate database.
- The duplicate database must be opened after the duplication process completes.

To perform backup-based database duplication using encrypted backups:

1. Plan the duplication as described in "[Planning to Duplicate a Database](#) (page 25-15)". This includes the following tasks:

- a. Choose a duplication technique that suits the scenario and requirements.

In this example, backup-based duplication without target connection or recovery catalog connection is performed. The `BACKUP LOCATION` clause is used to specify the location of the source database backups.

- b. Choose a strategy to generate duplicate database file names.

Because the duplicate database uses a directory structure that is different from the source database, use the `DB_CREATE_FILE_DEST` parameter in the auxiliary instance's initialization parameter file to specify the location in which duplicate database files are stored.

- c. Copy the required backups to the destination host using the same directory structure that was used on the source database.

2. Ensure that the prerequisites for the chosen duplication technique are met.

See "[Prerequisites for Duplicating a Database](#) (page 25-15)".

3. Prepare the auxiliary instance.

- a. Create the directories that will store the database files on the destination host.

In this example, create the `/app/db_home2/database` directory to store the data files, control file, and server parameter file and the `/app/db_home2/logfiles` directory to store the online redo log files.

- b. Create a minimal initialization parameter file for the auxiliary instance.

The file is called `initdup.ora` and is located in the `/app/db_home2/database` directory. It contains the following entries:

```
DB_NAME=dup_db
DB_DOMAIN = dup.example.com
DB_CREATE_FILE_DEST = /app/db_home2/database
```

See "[Creating an Initialization Parameter File for the Auxiliary Instance](#) (page 25-23)".

- c. Copy the password file from the source database to destination host. A password file is required because the duplicate database is being created on a remote host.

See "[Creating a Password File for the Auxiliary Instance](#) (page 25-26)".

- d. Set up Oracle Net Services connectivity between the source database and the auxiliary instance using a static listener. This is required because this example duplicates a database to a remote host.

See "[Establishing Oracle Net Connectivity Between the Source Database and Auxiliary Instance](#) (page 25-27)".

- e. Start the auxiliary instance in NOMOUNT mode using the parameter file `initdupdb.ora` created in Step 3b.

4. Start RMAN and connect to the source database as TARGET and to the auxiliary instance as AUXILIARY.

```
%rman
RMAN> CONNECT TARGET /
RMAN> CONNECT AUXILIARY sys@dup_db AS SYSBACKUP
```

Enter the passwords when prompted.

5. Because the source database backups used to duplicate the database are encrypted backups, specify the password that must be used to open the software keystore that contains the encryption key (where *password* is a placeholder for the actual password that you enter).

```
SET DECRYPTION WALLET OPEN IDENTIFIED BY password;
```

Note that the password specified in the SET command must be the same as the one that was set on the source database using the ALTER SYSTEM SET ENCRYPTION KEY command.

6. Duplicate the database using the DUPLICATE command.

Before you perform the duplication, you must specify the password that must be used to decrypt the RMAN backups.

```
DUPLICATE TARGET DATABASE TO 'dup_db'
SKIP TABLESPACE example, tools
PFFILE '/ app/db_home2/initdupdb.ora'
BACKUP LOCATION '/oracle2/rman_backups';
```

See Also:

[Examples: Duplicating Databases](#) (page 25-45)

25.8 Example: Script to Duplicate a Database Using Backup-based Duplication

This example shows how to use a script to automate the process of duplicating a target database.

This example assumes the following:

- backups of the target database are available to the auxiliary instance
- connection to the RMAN recovery catalog that contains metadata for the target database is available (connection to the target database is not required)
- both source and duplicate database use Oracle Managed Files (OMF)
- operating system used is Linux or UNIX
- audit directory is created on the auxiliary database host
- prerequisites for backup-based duplication are met

The script provided in this example performs the following tasks:

- drops the auxiliary database
- backs up the target database
- creates a dummy auxiliary instance and opens it in NOMOUNT mode
- duplicates the target database using the target database backups and metadata in the RMAN recovery catalog

The duplicate database control file is stored as `+REDO/ORACLE_SID/CONTROLFILE/cf3.ctl` and the data files are stored in the `+DATA` directory.

- verifies that the required objects are created in the duplicate database

To duplicate a target database using backup-based duplication without a target connection:

1. Create a parameter file (pfile) for the auxiliary instance. The pfile contains only the `DB_NAME` initialization parameter which is set to the SID of the duplicate database.

The following pfile, called `init_dup.ora` and located in the `/home/oracle` directory, sets the `DB_NAME` parameter. Replace `dup_db` with the SID of your duplicate database:

```
*.db_name = 'dup_db'
```

2. Use a text editor and create a Shell script (called `dup_db.sh` in this example) with the contents shown below and with the following modifications:
 - Replace the value of the `ORACLE_HOME` variable with the Oracle home directory of your auxiliary instance.
 - Replace the value of the `logdir` variable with the directory in which you want to store log files.
 - Replace the following placeholders (shown in *Italics*) with values appropriate to your duplication scenario:

dup_db: system identifier (SID) and service name of the auxiliary instance

tgt_db: SID and service name of the target database

sys_pswd: Password for the SYS user of the target database

rman_cat_user: Name of the RMAN catalog user

cat_user_pswd: Password for the RMAN catalog user *rman_cat_user*

rman_catalog_db: SID of the RMAN catalog database

system_pswd: Password for the SYSTEM user in the target database

- If you want to store the duplicate database control file using a name and location that is different from `+REDO/ORACLE_SID/CONTROLFILE/cf3.ctl`, then replace the value of `control_files` in the `dup_aux_db` function with a value that is appropriate for your duplication scenario.
- If you want to store the duplicate data files in a directory that is different from `+DATA`, then replace the value of `db_create_file_dest` in the `dup_aux_db` function with a value that is appropriate for your duplication scenario.

```
#!/bin/bash
export ORACLE_HOME=/u01/app/oracle/product/11.2.0.4/dbhome_2
export ORACLE_BASE=/u01/app/oracle
export ORACLE_SID=dup_db
export PATH=$PATH:$HOME/bin:$ORACLE_HOME/bin:$ORACLE_HOME/Opatch
export LD_LIBRARY_PATH=$ORACLE_HOME/lib:$ORACLE_HOME/rdbms/lib:/lib:/usr/lib;
export LD_LIBRARY_PATH
export logdir=/home/oracle/log
export dt='date +%y%m%d%H%M%S'
export NLS_DATE_FORMAT='DD-MM-YYYY HH24:MI:SS'

function drop_aux_db {
export ORACLE_SID=dup_db
$ORACLE_HOME/bin/sqlplus -s '/' as sysdba' <<EOF2
set pagesize 999 linesize 999 heading off feedback off
select name, open_mode from v\$database;
shutdown immediate;
startup mount exclusive restrict;
drop database;
exit;
EOF2
}

echo "Backup the target database"
function backup_source_db {
$ORACLE_HOME/bin/rman target sys/sys_pswd@tgt_db catalog
rman_cat_user/cat_user_pswd@rman_catalog_db <<EOF
RUN {
backup as backupset cumulative incremental level 1 database include current
controlfile plus archivelog not backed up delete input;}
exit;
EOF
}

sleep 120

echo "List the backup of the target database"
function check_source_db_backup {
$ORACLE_HOME/bin/rman target sys/sys_pswd@tgt_db catalog
rman_cat_user/cat_user_pswd@rman_catalog_db <<EOF
```

```

LIST BACKUP OF DATABASE COMPLETED AFTER '(SYSDATE-1/24)';
EOF
}

echo "Start the auxiliary database in FORCE NOMOUNT mode"
function nomount_aux_db {
export ORACLE_SID=dup_db
$ORACLE_HOME/bin/rman target / <<EOF2
startup force nomount pfile='/home/oracle/init_dup.ora';
exit;
EOF2
}

echo "Duplicate the target database"
function dup_aux_db {
export ORACLE_SID=dup_db
$ORACLE_HOME/bin/rman catalog rman_cat_user/cat_user_pswd@rman_catalog_db
AUXILIARY /
<<EOF
duplicate database tgt_db to dup_db spfile
set control_files '+REDO/${ORACLE_SID}/CONTROLFILE/cf3.ctl'
set db_create_file_dest '+DATA/' ;
exit;
EOF
}

echo "Check schema objects on the target"
function check_source_db {
$ORACLE_HOME/bin/sqlplus -s system/system_pswd@tgt_db <<EOF2
set pagesize 999 linesize 999 heading off feedback off
select name, open_mode from v\${database};
select table_name, num_rows from dba_tables where owner='SOE';
exit;
EOF2
}

echo "Check schema objects on the auxiliary"
function check_aux_db {
export ORACLE_SID=dup_db
$ORACLE_HOME/bin/sqlplus -s '/' as sysdba' <<EOF2
set pagesize 999 linesize 999 heading off feedback off
select name, open_mode from v\${database};
select table_name, num_rows from dba_tables where owner='SOE';
exit;
EOF2
}

drop_aux_db
backup_source_db
check_source_db_backup
nomount_aux_db
dup_aux_db
check_source_db
check_aux_db

```

3. Set execute permissions for the script `dup_db.sh` using the `chmod` command.

```
$ chmod +x dup_db.sh
```

4. On the duplicate host (that hosts the duplicate database), run the `dup_db.sh` script.

The following command runs the `dup_db.sh` script that is stored in the `/home/my_scripts/duplication` directory:

```
$. /home/my_scripts/duplication/dup_db.sh
```

Duplicating Databases: Advanced Topics

This chapter explains advanced forms of database duplication.

This chapter contains the following topics:

- [Specifying Alternative Names for Duplicate Database Files](#) (page 26-1)
- [Making Disk Backups Accessible Without Shared Disk](#) (page 26-10)

26.1 Specifying Alternative Names for Duplicate Database Files

If the source database and duplicate database do not use the same names for database files, then you must choose an alternative naming strategy for the duplicate files.

Depending on whether the source and duplicate databases use Oracle Managed Files (OMF) or Oracle Automatic Storage Management (ASM), use one of the following strategies:

- [Specifying Non-OMF or Non-ASM Alternative Names for Duplicate Database Files](#) (page 26-1)
- [Using CONFIGURE AUXNAME to Name File System Data Files and OMF/ASM Target Data Files](#) (page 26-4)

If the source data files use OMF, then you cannot rename them using `DB_FILE_NAME_CONVERT`. [Using Non-ASM Storage](#) (page 21-14) discusses the details and options of OMF-managed data files.

26.1.1 Specifying Non-OMF or Non-ASM Alternative Names for Duplicate Database Files

This section explains how to specify names for the duplicate files when the source and duplicate database either use different directory structures or use the same structure but you want to name the duplicate files differently. [Table 26-1](#) (page 26-1) summarizes the formats available for naming each type of file.

Table 26-1 Substitution Variables for SET NEWNAME

Variable	Description
<code>%b</code>	Specifies the file name stripped of directory paths. For example, if a data file is named <code>/oradata/prod/financial.dbf</code> , then <code>%b</code> results in <code>financial.dbf</code> .
<code>%f</code>	Specifies the absolute file number of the data file for which the new name is generated. For example, if data file 2 is duplicated, then <code>%f</code> generates the value 2.
<code>%I</code>	Specifies the DBID.

Table 26-1 (Cont.) Substitution Variables for SET NEWNAME

Variable	Description
%N	Specifies the tablespace name.
%U	Specifies the following format: data-D-%d_id-%I_TS-%N_FNO-%f

Use one of the following techniques to provide alternate names for non-OMF or non-ASM duplicate database files:

- [Using SET NEWNAME to Name File System Data Files and Temp Files](#) (page 26-2)
- [Using CONFIGURE AUXNAME to Name File System Data Files and OMF/ASM Target Data Files](#) (page 26-4)

26.1.1.1 Using SET NEWNAME to Name File System Data Files and Temp Files

One way to name duplicate data files is to use the SET NEWNAME command before executing the DUPLICATE command.

RMAN supports the following commands, listed in order of precedence:

1. SET NEWNAME FOR DATAFILE and SET NEWNAME FOR TEMPFILE
2. SET NEWNAME FOR TABLESPACE
3. SET NEWNAME FOR DATABASE

The order of precedence means that SET NEWNAME FOR TABLESPACE specifies names for files not named by SET NEWNAME FOR DATAFILE and SET NEWNAME FOR TEMPFILE, whereas SET NEWNAME FOR DATABASE specifies names for files not named by SET NEWNAME FOR TABLESPACE, SET NEWNAME FOR DATAFILE, or SET NEWNAME FOR TEMPFILE.

When using SET NEWNAME FOR DATAFILE, you can specify a full path as a literal, as in /oradata1/system01.dbf. When using SET with FOR DATABASE or FOR TABLESPACE, however, you must use at least one of these substitution variables described in [Table 26-1](#) (page 26-1): %b, %f, %U. (%I and %N are optional.).

To use SET NEWNAME to specify new file names:

1. Ensure that the prerequisites for the selected duplication technique are met.
See [Prerequisites for Duplicating a Database](#) (page 25-15).
2. Complete the required planning tasks before you begin database duplication.
See [Planning to Duplicate a Database](#) (page 25-15).
3. Prepare the auxiliary instance that is used when creating the duplicate database.

While duplicating an Oracle Real Application Clusters (Oracle RAC) database, set the CLUSTER_DATABASE initialization parameter on the auxiliary database to FALSE. This parameter can be reset to TRUE after the duplication completes.

See [Preparing the Auxiliary Instance](#) (page 25-23).

4. Start RMAN and connect to required databases. Depending on your duplication technique, you may need to connect to one or more of the following: target database, auxiliary instance, or recovery catalog.

See [Starting RMAN and Connecting to Databases](#) (page 25-36).

5. Place the source database in a proper state (if necessary).

See [Placing the Source Database in the Proper State](#) (page 25-36).

6. (Optional) Configure RMAN channels to improve duplication performance. Channels perform the primary task of duplicating the database.

See [Configuring RMAN Channels for Use in Duplication](#) (page 25-34).

7. Within a RUN command, issue the SET NEWNAME command before issuing DUPLICATE.

Example 26-1 Duplicating with SET NEWNAME FOR DATAFILE

This example illustrates a script that specifies new names for data files 1 through 5 and temp file 1. The script does not set a new name for data file 6 because it is in the TOOLS tablespace, which is excluded from the duplicate database.

Assume the following:

- DBID is 87650928
- Database name is PROD

```

RUN
{
SET NEWNAME FOR DATAFILE 1 TO '/oradata1/system01.dbf';
SET NEWNAME FOR DATAFILE 2 TO '/oradata2/sysaux01.dbf';
SET NEWNAME FOR DATAFILE 3 TO '/oradata3/undotbs01.dbf';
SET NEWNAME FOR DATAFILE 4 TO '/oradata4/users01.dbf';
SET NEWNAME FOR DATAFILE 5 TO '/oradata5/users02.dbf';
SET NEWNAME FOR TEMPFILE 1 TO '/oradata1/temp01.dbf';
DUPLICATE TARGET DATABASE TO dupdb
  SKIP TABLESPACE tools
  LOGFILE
    GROUP 1 ('/duplogs/redo01a.log', '/duplogs/redo01b.log') SIZE 4M REUSE,
    GROUP 2 ('/duplogs/redo02a.log', '/duplogs/redo02b.log') SIZE 4M REUSE;
}

```

Example 26-2 Duplicating with SET NEWNAME FOR DATAFILE and FOR TABLESPACE

This example is a variation of [Example 26-1](#) (page 26-3) and uses one SET NEWNAME command to name all data files in the tablespace users. After the example completes, the file names for tablespace users are set to: /oradata4/users01.dbf and /oradata5/users02.dbf.

```

{
SET NEWNAME FOR TABLESPACE users TO '/oradata%f/%b';
SET NEWNAME FOR DATAFILE 1 TO '/oradata1/system01.dbf';
SET NEWNAME FOR DATAFILE 2 TO '/oradata2/sysaux01.dbf';
SET NEWNAME FOR DATAFILE 3 TO '/oradata3/undotbs01.dbf';
SET NEWNAME FOR TEMPFILE 1 TO '/oradata1/temp01.dbf';
DUPLICATE TARGET DATABASE TO dupdb
  SKIP TABLESPACE tools
  LOGFILE

```

```

GROUP 1 ('/duplogs/redo01a.log', '/duplogs/redo01b.log') SIZE 4M REUSE,
GROUP 2 ('/duplogs/redo02a.log', '/duplogs/redo02b.log') SIZE 4M REUSE;
}

```

Example 26-3 Duplicating with SET NEWNAME FOR DATABASE

This example is a variation of [Example 26-1](#) (page 26-3) and uses a single SET command to name all data files in the database.

```

RUN
{
SET NEWNAME FOR DATABASE TO '/oradata/%U';
DUPLICATE TARGET DATABASE TO dupdb
  SKIP TABLESPACE tools
  LOGFILE
    GROUP 1 ('/duplogs/redo01a.log', '/duplogs/redo01b.log') SIZE 4M REUSE,
    GROUP 2 ('/duplogs/redo02a.log', '/duplogs/redo02b.log') SIZE 4M REUSE;
}

```

The following table shows the results from this example.

Table 26-2 Results for the SET NEWNAME DATABASE Command

Before SET NEWNAME DATABASE	Tablespace Name	Data File Number	After SET NEWNAME DATABASE TO '/oradata/%U';
.../ system01.dbf	SYSTEM	1	/oradata/data-D-PROD_id-87650928_TS-SYSTEM_FNO-1
.../ sysaux01.dbf	SYSAUX	2	/oradata/data-D-PROD_id-87650928_TS-SYSAUX_FNO-2
.../ undotbs01.dbf	UNDOTS	3	/oradata/data-D-PROD_id-87650928_TS-UNDOTS_FNO-3
.../ users01.dbf	USERS	4	/oradata/data-D-PROD_id-87650928_TS-USERS_FNO-4
.../ users02.dbf	USERS	5	/oradata/data-D-PROD_id-87650928_TS-USERS_FNO-5
.../ temp01.dbf	TEMP	1	/oradata/data-D-PROD_id-87650928_TS-TEMP_FNO-1

See Also:

Oracle Database Backup and Recovery Reference for details on substitution variables usable in SET NEWNAME

26.1.1.2 Using CONFIGURE AUXNAME to Name File System Data Files and OMF/ASM Target Data Files

The CONFIGURE AUXNAME command is an alternative to the SET NEWNAME command. The difference is that after you configure the auxiliary name the first time, additional DUPLICATE commands reuse the configured settings. In contrast, you must

reissue the `SET NEWNAME` command every time you execute the `DUPLICATE` command.

To use `CONFIGURE AUXNAME` to specify names for duplicate data files:

1. Issue a `CONFIGURE AUXNAME` command for each file to name in the duplicate database.

For example, enter the following commands at the RMAN prompt to specify names for files data files 1 through 5:

```
CONFIGURE AUXNAME FOR DATAFILE 1 TO '/oradata1/system01.dbf';
CONFIGURE AUXNAME FOR DATAFILE 2 TO '/oradata2/sysaux01.dbf';
CONFIGURE AUXNAME FOR DATAFILE 3 TO '/oradata3/undotbs01.dbf';
CONFIGURE AUXNAME FOR DATAFILE 4 TO '/oradata4/users01.dbf';
CONFIGURE AUXNAME FOR DATAFILE 5 TO '/oradata5/users02.dbf';
```

2. Issue a `DUPLICATE` command.

For example, enter the following command at the RMAN prompt:

```
SET NEWNAME FOR TEMPFILE 1 TO '/oradata/temp01.dbf';
DUPLICATE TARGET DATABASE
  TO dupdb
  SKIP TABLESPACE tools
  LOGFILE
    GROUP 1 ('/duplogs/redo01a.log', '/duplogs/redo01b.log') SIZE 4M REUSE,
    GROUP 2 ('/duplogs/redo02a.log', '/duplogs/redo02b.log') SIZE 4M REUSE;
```

See Also:

Oracle Database Backup and Recovery Reference for details on using `CONFIGURE AUXNAME`

26.1.2 Specifying OMF or ASM Alternative Names for Duplicate Database Files

You must specify how to name duplicate database files when the source database and duplicate database do not use the same names for database files.

The following sections discuss requirements and procedures for creating a duplicate database when some or all files of the duplicate database use OMF or ASM:

- [Settings and Restrictions for OMF Initialization Parameters](#) (page 26-6)
- [Setting Initialization Parameters for ASM](#) (page 26-7)
- [Examples: Duplicating Databases to ASM](#) (page 26-7)
- [Using `SET NEWNAME` to Create OMF or ASM Files](#) (page 26-8)
- [Using `DB_FILE_NAME_CONVERT` to Generate Names for Non-OMF or ASM Data Files](#) (page 26-9)
- [Using `LOG_FILE_NAME_CONVERT` to Generate Names for Non-OMF or ASM Log Files](#) (page 26-9)

See Also:

Oracle Automatic Storage Management Administrator's Guide for an introduction to ASM and OMF

26.1.2.1 Settings and Restrictions for OMF Initialization Parameters

When creating a duplicate database that uses Oracle Managed Files, you must set initialization parameters in the auxiliary instance. If you use the `SPFILE` clause of `DUPLICATE` to name the files, then you can set initialization parameters in the `SPFILE` clause. [Table 26-3](#) (page 26-6) describes the relevant parameters and recommended settings.

Table 26-3 Initialization Parameters for Oracle Managed Files

Initialization Parameter	Purpose	Recommendation
<code>DB_CREATE_FILE_DEST</code>	Specifies the default location for Oracle managed data files. This location is also the default location for Oracle managed control files and online logs if no <code>DB_CREATE_ONLINE_LOG_DEST</code> initialization parameters are specified.	Set this parameter to the location for the Oracle Managed Files. Any database files for which no other location is specified are created in <code>DB_CREATE_FILE_DEST</code> by <code>DUPLICATE</code> . You can override the default for specific files using <code>SET NEWNAME</code> , as described in Using SET NEWNAME to Create OMF or ASM Files (page 26-8).
<code>DB_CREATE_ONLINE_LOG_DEST_n</code>	Specifies the default location for Oracle managed control files and online redo logs. If multiple parameters are set, then one control file and one online redo log is created in each location.	Set these parameters (<code>_1</code> , <code>_2</code> , and so on) only if you want to multiplex the control files and online redo log files in multiple locations.
<code>DB_RECOVERY_FILE_DEST</code>	Specifies the default location for the fast recovery area. The fast recovery area contains multiplexed copies of current control files and online redo log files.	Set this parameter if you want a multiplexed copy of the control file and online redo log file in the recovery area.

[Table 26-4](#) (page 26-6) lists the restrictions on setting other initialization parameters.

Table 26-4 Initialization Parameter Restrictions for Oracle Managed Files

Initialization Parameter	Purpose	Restriction
<code>CONTROL_FILES</code>	Specifies one or more names of control files, separated by commas.	Do not set this parameter if you want the duplicate database control files in an OMF format. Oracle recommends that you use a server parameter file at the duplicate database when using control files in an OMF format.

Table 26-4 (Cont.) Initialization Parameter Restrictions for Oracle Managed Files

Initialization Parameter	Purpose	Restriction
DB_FILE_NAME_CONVERT	Converts the file name of a new data file on the primary database to a file name on the duplicate database.	Do not set this parameter. Omitting this parameter enables the database to generate valid Oracle managed file names for the duplicate data files.
LOG_FILE_NAME_CONVERT	Converts the file name of a new log file on the primary database to the file name of a log file on the standby database.	Do not set this parameter. Omitting this parameter allows the database to generate valid Oracle managed online redo log file names. To direct duplicate database online redo log files to Oracle managed storage, you can use the DB_CREATE_FILE_DEST, DB_RECOVERY_FILE_DEST, or DB_CREATE_ONLINE_LOG_DEST_n initialization parameters to identify an Oracle managed location for the online logs.

26.1.2.2 Setting Initialization Parameters for ASM

The procedure for creating a duplicate database to an ASM location is similar to the procedure described in [Settings and Restrictions for OMF Initialization Parameters](#) (page 26-6). The difference is that you must identify the initialization parameters that control the location where files are created and set these parameters to an ASM disk group. For example, set DB_CREATE_FILE_DEST, DB_CREATE_ONLINE_DEST_n, and CONTROL_FILES to +DISK1.

26.1.2.3 Examples: Duplicating Databases to ASM

This section contains examples on duplicating databases to ASM.

Example 26-4 Duplicating a Database from a File System to ASM

In this example, you use active database duplication. If the source database uses a server parameter file (or a backup is available), then you can create a temporary initialization parameter file on the destination host and set only the DB_NAME parameter.

Assume that the source database prod is on host1 and stores its data files in a non-ASM file system. The control files for prod are located in /oracle/oradata/prod/. You want to duplicate the source database to database dupdb on remote host host2. You want to store the duplicate database files in ASM disk group +DISK1.

After connecting RMAN to the target, duplicate, and recovery catalog databases, run the following RMAN script to duplicate the database.

```

DUPLICATE TARGET DATABASE TO dupdb
FROM ACTIVE DATABASE
SPFILE
PARAMETER_VALUE_CONVERT '/oracle/oradata/prod/', '+DISK1'
SET DB_CREATE_FILE_DEST +DISK1;

```

When the `DUPLICATE` command completes, the duplicate database is created, with data files, online redo log files, and control files in ASM disk group `+DISK1`.

Example 26-5 Duplicating a Database from ASM to ASM

In this example, you use active database duplication. If the source database uses a server parameter file (or a backup is available), then you can create a temporary initialization parameter file on the destination host and set only the `DB_NAME` parameter.

Assume that the source database `prod` is on `host1` and stores its data files in ASM disk group `+DISK1`. You want to duplicate the target to database `dupdb` on remote host `host2`. You want to store the data files for `dupdb` in ASM. Specifically, you want to store the data files and control files in disk group `+DISK2`.

In the `DUPLICATE` command, set `PARAMETER_VALUE_CONVERT` to convert all directory locations from `+DISK1` to `+DISK2`. The new file names in `+DISK2` are generated by ASM and do not match the original file names in disk group `+DISK1`.

After connecting to the target, duplicate, and catalog databases, run the following RMAN script to duplicate the database.

```
DUPLICATE TARGET DATABASE
TO dupdb
FROM ACTIVE DATABASE
SPFILE PARAMETER_VALUE_CONVERT '+DISK1','+DISK2'
SET DB_RECOVERY_FILE_DEST_SIZE='750G';
```

When the `DUPLICATE` command completes, the duplicate database is created, with data files, online redo logs, and control files in the larger ASM disk group `+DISK2`.

26.1.2.4 Using SET NEWNAME to Create OMF or ASM Files

To name Oracle managed data files, you can use the same `SET NEWNAME` commands described in [Using SET NEWNAME to Name File System Data Files and Temp Files](#) (page 26-2), but with `TO NEW` instead of `TO filename`. RMAN creates the specified data files or temp files with Oracle Managed File names in the location specified by `DB_CREATE_FILE_DEST`.

To use SET NEWNAME to specify names for Oracle Managed Files:

1. Set the `DB_CREATE_FILE_DEST` initialization parameter at the auxiliary instance to the desired location.
2. Enclose the `DUPLICATE` command in a `RUN` block and use `SET NEWNAME` with the `TO NEW` option for Oracle Managed Files.

Example 26-6 Duplicating with SET NEWNAME FOR DATAFILE and FOR TABLESPACE

This example illustrates a script that specifies literal names for data files 1-5. The only Oracle Managed Files in the source database are the data files in the `users` tablespace. Therefore, `TO NEW` is specified in the `SET NEWNAME` command for these files.

```
RUN
{
SET NEWNAME FOR TABLESPACE users TO NEW;
SET NEWNAME FOR DATAFILE 3 TO NEW;
SET NEWNAME FOR DATAFILE 1 TO '/oradata1/system01.dbf';
SET NEWNAME FOR DATAFILE 2 TO '/oradata2/sysaux01.dbf';
SET NEWNAME FOR TEMPFILE 1 TO '/oradata1/temp01';
DUPLICATE TARGET DATABASE TO dupdb
```

```

SKIP TABLESPACE tools
LOGFILE
  GROUP 1 ('/duplogs/redo01a.log', '/duplogs/redo01b.log') SIZE 4M REUSE,
  GROUP 2 ('/duplogs/redo02a.log', '/duplogs/redo02b.log') SIZE 4M REUSE;
}

```

Example 26-7 Using SET NEWNAME to Create Files in an ASM Disk Group

This example uses SET NEWNAME to direct individual data files, temp files, or tablespaces to a specified ASM disk group.

```

RUN
{
SET NEWNAME FOR DATAFILE 1 TO "+DGROUP1";
SET NEWNAME FOR DATAFILE 2 TO "+DGROUP2";
.
.
.
DUPLICATE TARGET DATABASE
TO dupdb
FROM ACTIVE DATABASE
SPFILE SET DB_CREATE_FILE_DEST +DGROUP3;
}

```

26.1.2.5 Using DB_FILE_NAME_CONVERT to Generate Names for Non-OMF or ASM Data Files

Another technique to generate names besides using SET NEWNAME or CONFIGURE AUXNAME commands is to use DB_FILE_NAME_CONVERT to transform target file names. For example, you can change the target file name from /oracle/ to /dup/oracle/. DB_FILE_NAME_CONVERT allows you to specify multiple conversion file name pairs. It can also be used to produce names for data files and temp files.

You can specify DB_FILE_NAME_CONVERT in the DUPLICATE command or you can set it in the initialization parameter of the auxiliary instance.

Restrictions of DB_FILE_NAME_CONVERT:

You cannot use the DB_FILE_NAME_CONVERT clause of the DUPLICATE command to control generation of new names for files at the duplicate instance that are in the Oracle Managed Files (OMF) format at the source database instance. See *Oracle Database Backup and Recovery Reference* for details on this restriction.

26.1.2.6 Using LOG_FILE_NAME_CONVERT to Generate Names for Non-OMF or ASM Log Files

If the LOG_FILE clause has been omitted and no Oracle Managed Files initialization parameters DB_CREATE_FILE_DEST, DB_CREATE_ONLINE_DEST_n, or DB_RECOVERY_FILE_DEST are specified, then LOG_FILE_NAME_CONVERT can transform target file names. This works in much the same way as the DB_FILE_NAME_CONVERT and can transform target file names from log_* to duplog_*. You can specify multiple conversion file name pairs with this parameter.

When you specify LOG_FILE_NAME_CONVERT, RMAN uses the REUSE parameter when creating the online redo logs. If an online redo log file exists at the named location and is of the correct size, then it is reused for the duplicate.

Restrictions of LOG_FILE_NAME_CONVERT:

- Do not specify LOG_FILE_NAME_CONVERT if you set Oracle Managed Files initialization parameters.

- `LOG_FILE_NAME_CONVERT` cannot be specified as a `DUPLICATE` clause, it can only be specified in the initialization parameter of the auxiliary instance.
- You cannot use the `LOG_FILE_NAME_CONVERT` initialization parameter to control generation of new names for files at the duplicate instance that are in the Oracle Managed Files (OMF) format at the source database instance.

26.2 Making Disk Backups Accessible Without Shared Disk

You can use the shared disk technique to make backups available to the auxiliary instance. When NFS or shared disk is not an option, then the path that stores the backups must exist on *both* the source and destination hosts, unless the `BACKUP LOCATION` option is used for the `DUPLICATE` command without a target or recovery catalog connection.

Assume that you maintain two hosts, `srchost` and `dsthost`. The database on `srchost` is `srcdb`. The RMAN backups of `srcdb` reside in `/dsk1/bkp` on host `srchost`. The directory `/dsk1/bkp` is in use on the destination host, so you intend to store backups in `/dsk2/dup` on the destination host.

To transfer the backups from the source host to the destination host:

1. Create a directory in the source host that has the same name as the directory on the destination host that will contain the backups.

For example, if you intend to store the RMAN backups in `/dsk2/dup` on the destination host, then create `/dsk2/dup` on the source host.
2. On the source host, copy the backups to the directory created in the previous step, and then catalog the backups. You can use either of the following approaches:
 - Connect RMAN to the source database as `TARGET` and use the `BACKUP` command to back up the backups. For example, use the `BACKUP COPY OF DATABASE` command to copy the backups in `/dsk1/bkp` on the source host to `/dsk2/dup` on the source host. In this case, RMAN automatically catalogs the backups in the new location. If you are duplicating a pluggable database (PDB), then use the `PLUGGABLE DATABASE` syntax of the `BACKUP COPY OF` command to copy only the backups of the PDB.
 - Use an operating system utility to copy the backups in `/dsk1/bkp` on the source host to `/dsk2/dup` on the source host. Afterward, connect RMAN to the source database as `TARGET` and use the `CATALOG` command to update the source control file with the location of the manually transferred backups.
3. Manually transfer the backups in the new directory on the source host to the identically named directory on the destination host.

For example, use FTP to transfer the backups in `/dsk2/dup` on the source host to `/dsk2/dup` on the destination host.

The auxiliary channel can search for backups in `/dsk2/dup` on the destination host and restore them.

Creating Transportable Tablespace Sets

This chapter explains how to use RMAN to create transportable tablespace sets by restoring backups. This discussion assumes that you are familiar with the [transportable tablespace](#) procedure described in *Oracle Database Administrator's Guide*. The procedure in this chapter is an alternative technique for generating transportable tablespace sets. This chapter contains the following sections:

- [Overview of Creating Transportable Tablespace Sets](#) (page 27-1)
- [Customizing Initialization Parameters for the Auxiliary Instance](#) (page 27-5)
- [Creating a Transportable Tablespace Set](#) (page 27-7)
- [Troubleshooting the Creation of Transportable Tablespace Sets](#) (page 27-8)
- [Transportable Tablespace Set Scenarios](#) (page 27-8)

27.1 Overview of Creating Transportable Tablespace Sets

This section explains the basic concepts and tasks involved in creating transportable tablespace sets from RMAN backups.

27.1.1 Purpose of Creating Transportable Tablespace Sets

A [transportable tablespace set](#) contains data files for a set of tablespaces and an export file containing structural metadata for the set of tablespaces. The export file is generated by Data Pump Export.

One use of transportable tablespace sets is to create a tablespace repository. For example, if you have a database with some tablespaces used for quarterly reporting, you can create transportable sets for these tablespaces for storage in a tablespace repository. Subsequently, versions of the tablespace can be requested from the repository and attached to another database for use in generating reports.

Another use for transportable tablespaces is in an Oracle Streams environment. When preparing to use Oracle Streams to keep a destination database synchronized with a source database, you must perform Oracle Streams instantiation. You must bring the destination database up to a given SCN at which the two databases were known to be synchronized before you can use Oracle Streams to move subsequent updates from the source database to the destination database. You can create transportable tablespace sets from backups as part of the Oracle Streams instantiation.

A key benefit of the RMAN `TRANSPORT TABLESPACE` command is that it does not need access to the live data files from the tablespaces to be transported. In contrast, the transportable tablespace technique described in *Oracle Database Administrator's Guide* requires that the tablespaces to be transported are open read-only during the transport. Thus, transporting from backups improves database availability, especially for large tablespaces, because the tablespaces to be transported can remain open for

writes during the operation. Also, placing a tablespace in read-only mode can take a long time, depending on current database activity.

The RMAN `TRANSPORT TABLESPACE` command also enables you to specify a target point in time, SCN, or restore point during your recovery window and transport tablespace data as it existed at that time (see "[Creating a Transportable Tablespace Set at a Specified Time or SCN](#) (page 27-8)"). For example, if your [backup retention policy](#) guarantees a 1 week recovery window, and if you want to create transportable tablespaces based on the contents of the database on the last day of the month, then RMAN can perform this task at any time during the first week of the next month.

See Also:

- *Oracle Database Backup and Recovery Reference* for reference information about the `TRANSPORT TABLESPACE` command
 - *Oracle Streams Replication Administrator's Guide* for more details on RMAN and Oracle Streams instantiations
-
-

27.1.2 Basic Concepts of Transportable Tablespace Sets

You create a transportable tablespace set by connecting RMAN to a source database as `TARGET` and then executing the `TRANSPORT TABLESPACE` command. The source database contains the tablespaces to be transported.

You must have a backup of all needed tablespaces and archived redo log files available for use by RMAN that can be recovered to the target point in time for the `TRANSPORT TABLESPACE` operation. [Figure 27-1](#) (page 27-3) illustrates the basic process of transportable tablespace creation.

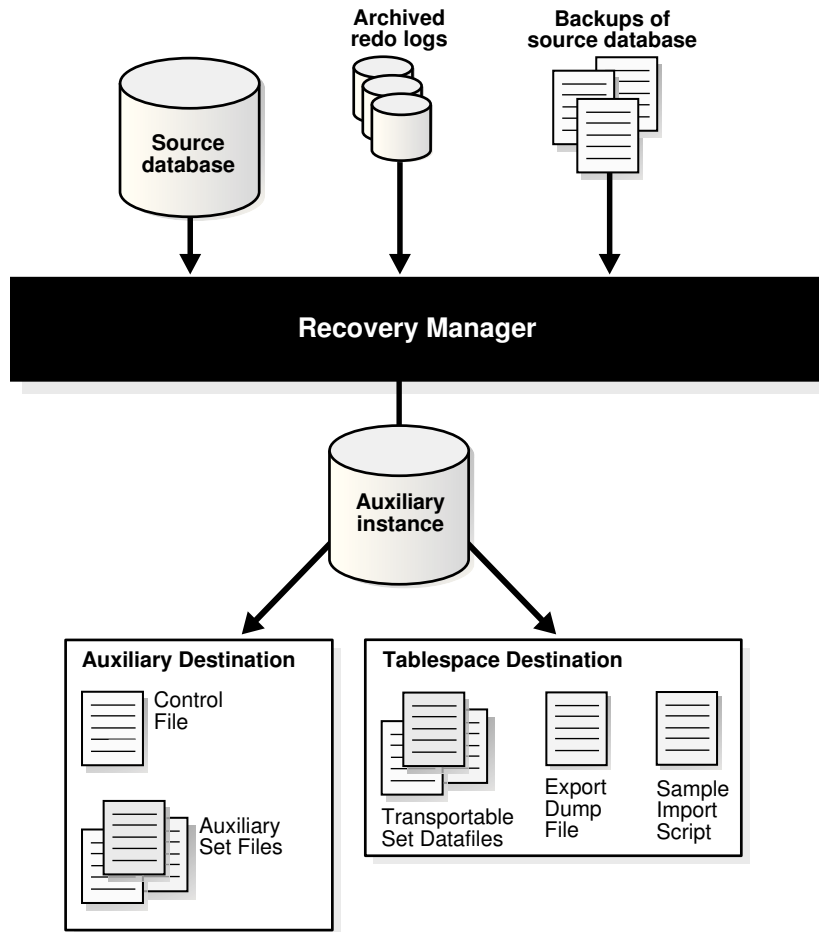
Figure 27-1 RMAN Transportable Tablespace from Backup: Architecture

The process shown in [Figure 27-1](#) (page 27-3) occurs in the following phases:

1. RMAN starts an [auxiliary instance](#).

An auxiliary instance is created by RMAN on the same host as the source database to perform the restore and recovery of the tablespaces. RMAN automatically creates an initialization parameter file for the auxiliary instance and starts it `NOMOUNT`.

2. RMAN restores a backup of the source database control file to serve as the auxiliary instance control file and mounts this control file.
3. RMAN restores [auxiliary set](#) and transportable set data files from the backups of the source database.

The [auxiliary set](#) includes data files and other files required for the tablespace transport but which are not themselves part of the transportable tablespace set. The auxiliary set typically includes the `SYSTEM` and `SYSAUX` tablespaces, temp files, and data files containing rollback or undo segments. The auxiliary instance has other files associated with it, such as its own control file, parameter file, and online logs, but they are not part of the auxiliary set.

RMAN stores the auxiliary data files in the selected [auxiliary destination](#). The auxiliary destination is a disk location where RMAN can store auxiliary set files such as the parameter file, data files (other than those in the transportable set),

control files, and online logs of the auxiliary instance during the transport. If the transport succeeds, then RMAN deletes these files.

RMAN stores the transportable set files in the [tablespace destination](#). The tablespace destination is a disk location that by default contains the data file copies and other output files when the tablespace transport command completes.

4. RMAN performs [database point-in-time recovery \(DBPITR\)](#) at the auxiliary instance.

The recovery updates auxiliary and transportable set data files to their contents as of the target time specified for the `TRANSPORT TABLESPACE` command. If no target time is specified, then RMAN recovers with all available redo. RMAN restores archived redo logs from backup as necessary at the auxiliary destination (or other location) and deletes them after they are applied.

5. RMAN opens the auxiliary database with the `RESETLOGS` option.

The data files now reflect the tablespace contents as of the target SCN for the tablespace transport operation.

6. RMAN places the transportable set tablespaces of the auxiliary instance into read-only mode. RMAN also invokes Data Pump Export in transportable tablespace mode to create the [export dump file](#) for the transportable set.

By default, the dump file is located in the tablespace destination. To specify the dump file location, see "[Specifying Locations for Data Pump Files](#) (page 27-9)".

RMAN also generates the sample Data Pump import script for use when plugging in the transported tablespaces at a target database. The contents of this script are written to a file named `impscript.sql` in the tablespace destination. The commands for the script are also included in the RMAN command output.

7. If the preceding steps are successful, then RMAN shuts down the auxiliary instance and deletes all files created during the `TRANSPORT TABLESPACE` operation except for the transportable set files, the Data Pump Export file, and the sample import script.

27.1.3 Basic Steps of Creating Transportable Tablespace Sets

Before creating transportable tablespace sets you must meet several prerequisites. These prerequisites are described in the `TRANSPORT TABLESPACE` entry in *Oracle Database Backup and Recovery Reference*.

The basic steps of creating transportable tablespace sets are as follows:

1. Start the RMAN client and connect to the source database and, if used, the recovery catalog.
2. If necessary, set additional parameters in the auxiliary instance parameter file.

This task is described in "[Customizing Initialization Parameters for the Auxiliary Instance](#) (page 27-5)".

3. Execute the `TRANSPORT TABLESPACE` command.

This basic technique is described in "[Creating a Transportable Tablespace Set](#) (page 27-7)". Variations on this technique are described in "[Transportable Tablespace Set Scenarios](#) (page 27-8)".

4. If the `TRANSPORT TABLESPACE` command fails, troubleshoot the problem and then retry the command until it succeeds.

This technique is described in "[Troubleshooting the Creation of Transportable Tablespace Sets](#) (page 27-8)".

5. Return to the procedure for transporting tablespaces described in *Oracle Database Administrator's Guide*.

27.2 Customizing Initialization Parameters for the Auxiliary Instance

RMAN enables you to customise initialization parameters that are used for the auxiliary instance.

When RMAN creates the auxiliary instance, it creates an initialization parameter file. The default values work for most `TRANSPORT TABLESPACE` cases, especially if you specify the `AUXILIARY DESTINATION` option on the `TRANSPORT TABLESPACE` command. RMAN can also use an auxiliary instance parameter file that contains values for additional initialization parameters. These values override the values of parameters defined in the default initialization parameter file.

You might use an auxiliary instance parameter file for the following reasons:

- To increase `STREAMS_POOL_SIZE` and `SHARED_POOL_SIZE` if needed for Data Pump Export.
- To manage locations for auxiliary instance data files. For example, you do not want all auxiliary instance data files stored in the same location on disk, but you do not want to specify the location of every file individually.
- To specify names for online redo logs with `LOG_FILE_NAME_CONVERT`.

The auxiliary instance parameter file is not intended to be a complete initialization parameter file for the auxiliary instance. Any parameters specified are added to or override the default parameters for the auxiliary instance. It is not necessary to specify parameters in the initialization file that you do not intend to override.

See Also:

- [Using Initialization Parameters to Name Auxiliary Files](#) (page 27-12)
 - [Using Initialization Parameters to Name Auxiliary Files](#) (page 27-12)
 - [About Setting Initialization Parameters for the RMAN Auxiliary Instance](#) (page 27-5)
 - [Setting the Location of the Auxiliary Instance Parameter File](#) (page 27-6)
-
-

27.2.1 About Setting Initialization Parameters for the RMAN Auxiliary Instance

RMAN defines the basic initialization parameters in [Table 27-1](#) (page 27-6) for the automatic auxiliary instance.

Table 27-1 Default Initialization Parameters for the Auxiliary Instance

Initialization Parameter	Value
DB_NAME	Same as DB_NAME of the source database.
COMPATIBLE	Same as the compatible setting of the source database.
DB_UNIQUE_NAME	Generated unique value based on DB_NAME.
DB_BLOCK_SIZE	Same as the DB_BLOCK_SIZE of the source database.
DB_FILES	Same value as DB_FILES for the source database
SGA_TARGET	280M recommended value.
DB_CREATE_FILE_DEST	Auxiliary destination (only if the AUXILIARY_DESTINATION argument to TRANSPORT_TABLESPACE is set). RMAN creates Oracle managed control files and online logs in this location.

Overriding a basic initialization parameter in [Table 27-1](#) (page 27-6) with an inappropriate value in the auxiliary instance parameter file can cause TRANSPORT_TABLESPACE to fail. If you encounter a problem, then try returning the initialization parameter to its default value.

See Also:

["Using Initialization Parameters to Name Auxiliary Files](#) (page 27-12)" to learn how to use DB_FILE_NAME_CONVERT and LOG_FILE_NAME_CONVERT to name files

27.2.2 Setting the Location of the Auxiliary Instance Parameter File

By default, RMAN looks for the auxiliary initialization parameter file at an operating system-dependent location on the host running the RMAN client. This location may not be on the host running the auxiliary instance. For UNIX systems, this location is `$?/rdbms/admin/params_auxint.ora`, where the question mark (?) stands for ORACLE_HOME on the host running RMAN. If no file is found in the default location, then RMAN does not generate an error.

If you use the default initialization parameters for the auxiliary instance, then check whether an auxiliary instance parameter file exists before running TRANSPORT_TABLESPACE.

To specify a different location for the auxiliary instance parameter file, you can use the RMAN SET_AUXILIARY_INSTANCE_PARAMETER_FILE command in a RUN block before the TRANSPORT_TABLESPACE command. As with the default location of the auxiliary instance parameter file, the path specified when using the SET_AUXILIARY_INSTANCE_PARAMETER_FILE command is a client-side path.

Assume that you create a file named `/tmp/auxinstparams.ora` on the host running the RMAN client. This file contains the following initialization parameter:

```
SHARED_POOL_SIZE=150M;
```

You can then use the initialization parameter file with TRANSPORT_TABLESPACE as shown in [Example 27-1](#) (page 27-7). The SHARED_POOL_SIZE parameter in `/tmp/`

`auxinstparams.ora` overrides the default value used for `SHARED_POOL_SIZE` when RMAN creates the auxiliary instance.

Example 27-1 Specifying an Auxiliary Instance Parameter File

```
RUN
{
  SET AUXILIARY INSTANCE PARAMETER FILE TO '/tmp/auxinstparams.ora';
  TRANSPORT TABLESPACE tbs_2
    TABLESPACE DESTINATION '/disk1/transportdest'
    AUXILIARY DESTINATION '/disk1/auxdest';
}
```

27.3 Creating a Transportable Tablespace Set

This section describes the use of `TRANSPORT TABLESPACE` in the most basic and automated case. See "[Transportable Tablespace Set Scenarios](#) (page 27-8)" for variations on the basic case.

It is assumed that you have met the prerequisites described in the `TRANSPORT TABLESPACE` entry in *Oracle Database Backup and Recovery Reference*. It is also assumed that you have met the requirements described in *Oracle Database Administrator's Guide*:

- Confirmed that tablespace transport is supported between your source and destination platforms
- Identified a self-contained set of tablespaces to include in the transportable set

To create a transportable tablespace set:

1. Start the RMAN client and connect to the source database and, if used, the recovery catalog database.
2. Run the `TRANSPORT TABLESPACE` command in RMAN.

In the most basic case, you specify an `AUXILIARY DESTINATION` clause, which is optional but recommended. RMAN uses default values that work for most cases. If you do not specify an auxiliary location, then ensure that locations are specified for all auxiliary instance files. See the rules described in "[Specifying Auxiliary File Locations with Transportable Tablespaces](#) (page 27-10)" to learn how to name auxiliary files.

The following example creates a transportable tablespace set that includes tablespaces `tbs_2` and `tbs_3`.

```
TRANSPORT TABLESPACE tbs_2, tbs_3
  TABLESPACE DESTINATION '/disk1/transportdest'
  AUXILIARY DESTINATION '/disk1/auxdest';
```

After the command completes successfully, note the following results:

- The transportable set data files are left in the location `/disk1/transportdest` with their original names. The transportable tablespace set data files are not automatically converted to the endian format of the destination database by `TRANSPORT TABLESPACE`. If necessary, use the `RMAN CONVERT` command to convert the data files to the endian format of the destination database after creating the transportable set.

- The Data Pump [export dump file](#) for the transportable set is named `dmpfile.dmp`, the export log is named `explog.log`, and the sample import script is named `impscrpt.sql`.

All files are created in `/disk1/transportdest`. If a file under the name of the [export dump file](#) already exists in the tablespace destination, then `TRANSPORT TABLESPACE` fails when it calls Data Pump Export. If you are repeating a previous `TRANSPORT TABLESPACE` operation, delete the previous output files, including the [export dump file](#).

- The auxiliary set files are removed from `/disk1/auxdest`.
3. If necessary, edit the sample import script.

The sample import script assumes that the files used to import the tablespaces into the destination database are stored in the same locations where they were created by `TRANSPORT TABLESPACE`. If files have been moved to new disk locations before being plugged in, then you must update the sample script with the new locations of the files before using the script to plug in the transported tablespaces.

4. Return to the process for transporting tablespaces described in *Oracle Database Administrator's Guide*.

27.4 Troubleshooting the Creation of Transportable Tablespace Sets

When the `RMAN TRANSPORT TABLESPACE` command fails, the failed auxiliary instance files are left intact in the auxiliary instance destination for troubleshooting.

If your `SET NEWNAME`, `CONFIGURE AUXNAME`, and `DB_FILE_NAME_CONVERT` settings cause multiple files in the auxiliary or transportable tablespace sets to have the same name, then `RMAN` reports an error during the `TRANSPORT TABLESPACE` command. To correct the problem, use different values for these parameters to ensure that duplicate file names are not created. Naming techniques are described in "[Specifying Auxiliary File Locations with Transportable Tablespaces](#) (page 27-10)".

27.5 Transportable Tablespace Set Scenarios

This section contains the following topics:

- [Creating a Transportable Tablespace Set at a Specified Time or SCN](#) (page 27-8)
- [Specifying Locations for Data Pump Files](#) (page 27-9)
- [Specifying Auxiliary File Locations with Transportable Tablespaces](#) (page 27-10)

27.5.1 Creating a Transportable Tablespace Set at a Specified Time or SCN

You can specify a target time or SCN with the `TRANSPORT TABLESPACE` command. During the tablespace transport operation, `RMAN` restores the tablespace at the auxiliary instance with backups from before the target time and performs point-in-time recovery on the auxiliary database to the specified target time. Backups and archived redo logs needed for this point-in-time recovery must be available.

You can specify the target time with an SCN (in the current incarnation or its ancestors) as shown in [Example 27-2](#) (page 27-9).

Example 27-2 Specifying an End SCN

```

TRANSPORT TABLESPACE tbs_2
  TABLESPACE DESTINATION '/disk1/transportdest'
  AUXILIARY DESTINATION '/disk1/auxdest'
  UNTIL SCN 11379;

```

You can also specify a restore point as shown in [Example 27-3](#) (page 27-9).

Example 27-3 Specifying an End Restore Point

```

TRANSPORT TABLESPACE tbs_2
  TABLESPACE DESTINATION '/disk1/transportdest'
  AUXILIARY DESTINATION '/disk1/auxdest'
  TO RESTORE POINT 'before_upgrade';

```

You can also specify an end time as shown in [Example 27-4](#) (page 27-9).

Example 27-4 Specifying an End Time

```

TRANSPORT TABLESPACE tbs_2
  TABLESPACE DESTINATION '/disk1/transportdest'
  AUXILIARY DESTINATION '/disk1/auxdest'
  UNTIL TIME 'SYSDATE-1';

```

27.5.2 Specifying Locations for Data Pump Files

You can change the names of the Data Pump [export dump file](#) for the transportable set, the sample import script for use at the target database, the log file generated by Data Pump Export, and the directory to which they are written.

By default, these files are stored in the tablespace destination and named as follows:

- The Data Pump [export dump file](#) is named `dmpfile.dmp`.
- The export log file is named `explog.log`.
- The sample import script is named `impscript.sql`.

You can place the dump file and the export log in a different directory by using the `DATAPUMP DIRECTORY` clause of the `TRANSPORT TABLESPACE` command, passing in the name of a database directory object. The database directory object used by the `DATAPUMP DIRECTORY` clause is not the directory path of an actual file system directory. The value passed corresponds to the `DIRECTORY` command-line argument of Data Pump Export.

See Also:

Oracle Database Utilities for more details on the use of directory objects with Data Pump Export

You can rename these files with the `DUMP FILE`, `EXPORT LOG`, and `IMPORT SCRIPT` clauses of `TRANSPORT TABLESPACE`. The file names cannot contain full file paths with directory names. If the `DUMP FILE` or `EXPORT LOG` file names specify file paths, then `TRANSPORT TABLESPACE` fails when it attempts to generate the export dump files. Use the `DATAPUMP DIRECTORY` clause to specify a database directory object that identifies a location for the outputs of Data Pump Export.

The following scenario illustrates the use of `TRANSPORT TABLESPACE` with the `DATAPUMP DIRECTORY`, `DUMP FILE`, `EXPORT LOG`, and `IMPORT SCRIPT` file names

specified. Assume that you create a database directory object as follows for use with Data Pump Export:

```
CREATE OR REPLACE DIRECTORY mypumpdir as '/datapumpdest';
```

[Example 27-5](#) (page 27-10) shows a TRANSPORT TABLESPACE command with optional arguments that specify output file locations.

Example 27-5 Specifying Output File Locations

```
TRANSPORT TABLESPACE tbs_2
  TABLESPACE DESTINATION '/transportdest'
  AUXILIARY DESTINATION '/auxdest'
  DATAPUMP DIRECTORY mypumpdir
  DUMP FILE 'mydumpfile.dmp'
  IMPORT SCRIPT 'myimportscript.sql'
  EXPORT LOG 'myexportlog.log';
```

After a successful run, RMAN cleans up the auxiliary destination, creates the Data Pump [export dump file](#) and the export log in the directory referenced by DATAPUMP DIRECTORY (/datapumpdest/mydumpfile.dmp and /datapumpdest/myexportlog.log), and stores the transportable set data files in /transportdest.

27.5.3 Specifying Auxiliary File Locations with Transportable Tablespaces

Several rules are applicable to the location of auxiliary instance files created during the transport.

If RMAN determines that any of the auxiliary files, designated by any of the methods for specifying auxiliary file locations, contain a data file copy that is suitable to be used for the desired point in time for this transport operation, then that data file copy is used instead of restoring the data file. Any data file copies that are present, but not suitable for this transport operation, because they are more recent than the requested point in time, or are not recognized as part of the target database, are overwritten when the data files are restored.

The simplest technique is to use the AUXILIARY DESTINATION clause of the TRANSPORT TABLESPACE command and let RMAN manage all file locations automatically.

The following table lists the techniques available for specifying file locations when relocating some or all auxiliary instance files, in the order of precedence that RMAN uses:

Table 27-2 Options for specifying auxiliary file locations

Order of Precedence	Auxiliary File Naming Technique	Additional Information
1	SET NEWNAME FOR DATAFILES SET NEWNAME FOR TABLESPACE SET NEWNAME FOR DATABASE	"Using SET NEWNAME for Auxiliary Data Files (page 27-11)"
2	CONFIGURE AUXNAME	"Using CONFIGURE AUXNAME for Auxiliary Data Files (page 27-11)"

Table 27-2 (Cont.) Options for specifying auxiliary file locations

Order of Precedence	Auxiliary File Naming Technique	Additional Information
3	AUXILIARY DESTINATION clause of the TRANSPORT TABLESPACE command	"Using AUXILIARY DESTINATION to Specify a Location for Auxiliary Files (page 27-12)"
4	LOG_FILE_NAME_CONVERT and DB_FILE_NAME_CONVERT in the initialization parameter file	"Using Initialization Parameters to Name Auxiliary Files (page 27-12)"

If you use several of these options, then the first option in the list that applies to a file determines the file name.

27.5.3.1 Using SET NEWNAME for Auxiliary Data Files

You can use the following SET NEWNAME commands in a RUN block to specify file names for use in the TRANSPORT TABLESPACE command:

- SET NEWNAME FOR DATAFILE
- SET NEWNAME FOR DATABASE
- SET NEWNAME FOR TABLESPACE

The SET NEWNAME FOR DATAFILE commands in [Example 27-6](#) (page 27-11) cause the auxiliary instance data files to be restored to the locations named instead of to /disk1/auxdest.

Example 27-6 Using SET NEWNAME FOR DATAFILE to Name Auxiliary Data Files

```

RUN
{
  SET NEWNAME FOR DATAFILE '/oracle/dbs/tbs_12.f'
  TO '/bigdrive/auxdest/tbs_12.f';
  SET NEWNAME FOR DATAFILE '/oracle/dbs/tbs_11.f'
  TO '/bigdrive/auxdest/tbs_11.f';
  TRANSPORT TABLESPACE tbs_2
  TABLESPACE DESTINATION '/disk1/transportdest'
  AUXILIARY DESTINATION '/disk1/auxdest';
}

```

SET NEWNAME is best used with one-time operations. If you expect to create transportable tablespaces from backup regularly for a particular set of tablespaces, then consider using CONFIGURE AUXNAME instead of SET NEWNAME to make persistent settings for the location of the auxiliary instance data files.

27.5.3.2 Using CONFIGURE AUXNAME for Auxiliary Data Files

You can use the CONFIGURE AUXNAME command to specify persistent locations for transportable tablespace set or auxiliary set data files. RMAN restores each data file for which a CONFIGURE AUXNAME command has been used to the specified location before recovery. RMAN deletes auxiliary set data files when the operation is complete, unless the operation failed.

An example illustrates the relationship between the `CONFIGURE AUXNAME` and `TRANSPORT ... AUXILIARY DESTINATION` commands. Suppose that you want to transport tablespace `tbs_11`. The tablespace `tbs_12`, which contains data file `tbs_12.f`, is part of the auxiliary set. You execute the following steps:

1. You use the `CONFIGURE AUXNAME` statement to set a persistent nondefault location for the auxiliary set data file `/oracle/dbs/tbs_12.f`.

For example, you enter the following command:

```
CONFIGURE AUXNAME FOR DATAFILE '/oracle/dbs/tbs_12.f'  
TO '/disk1/auxdest/tbs_12.f';
```

2. You execute the `TRANSPORT TABLESPACE` command with the `AUXILIARY DESTINATION` and `TABLESPACE DESTINATION` parameters.

For example, you enter the following command:

```
TRANSPORT TABLESPACE tbs_11  
AUXILIARY DESTINATION '/myauxdest'  
TABLESPACE DESTINATION '/disk1/transportdest';
```

In the preceding scenario, RMAN restores the auxiliary set copy of data file `/oracle/dbs/tbs_12.f` to `/disk1/auxdest/tbs_12.f` instead of the location specified by `AUXILIARY DESTINATION`. The `CONFIGURE AUXNAME` setting is higher in the order of precedence than `AUXILIARY DESTINATION`.

Note:

You can view any current `CONFIGURE AUXNAME` settings by executing the `SHOW AUXNAME` command, which is described in *Oracle Database Backup and Recovery Reference*.

27.5.3.3 Using `AUXILIARY DESTINATION` to Specify a Location for Auxiliary Files

If you use an `AUXILIARY DESTINATION` argument with `TRANSPORT TABLESPACE`, then any auxiliary set file that is not moved to another location using a `SET NEWNAME` or `CONFIGURE AUXNAME` command is stored in the auxiliary destination during the `TRANSPORT TABLESPACE` operation.

If you do not use `AUXILIARY DESTINATION`, then you must use `LOG_FILE_NAME_CONVERT` to specify the location of the online redo log files for the auxiliary instance. Neither `SET NEWNAME` nor `CONFIGURE AUXNAME` can affect the location of the auxiliary instance online redo logs. Thus, if you do not use `AUXILIARY DESTINATION` or `LOG_FILE_NAME_CONVERT`, then RMAN has no information about where to create the online redo logs.

27.5.3.4 Using Initialization Parameters to Name Auxiliary Files

You can use the `LOG_FILE_NAME_CONVERT` and `DB_FILE_NAME_CONVERT` initialization parameters in an auxiliary instance parameter file to determine the names for online redo logs and other database files at the auxiliary instance. If no `AUXILIARY DESTINATION` clause is specified on the `TRANSPORT TABLESPACE` command, then these parameters determine the location of any files for which no `CONFIGURE AUXNAME` or `SET NEWNAME` command was run.

You cannot use `LOG_FILE_NAME_CONVERT` or `DB_FILE_NAME_CONVERT` to generate new Oracle Managed Files (OMF) names for files at the auxiliary instance when the

original files are OMF files. The database manages the generation of unique file names in each OMF destination. You must use an `AUXILIARY DESTINATION` clause to control the location of the online redo log files. You must use the `AUXILIARY DESTINATION` clause, `SET NEWNAME` or `CONFIGURE AUXNAME` commands, or `DB_CREATE_FILE_DEST` initialization parameter to specify the location for OMF data files.

See Also:

Oracle Database Reference for more details on the `LOG_FILE_NAME_CONVERT` and `DB_FILE_NAME_CONVERT` initialization parameters

Transporting Data Across Platforms

You can use RMAN to transport tablespaces across platforms with different endian formats. You can also use RMAN to transport an entire database to a different platform so long as the two platforms have the same endian format.

This chapter contains the following topics:

- [About Cross-Platform Data Transport](#) (page 28-1)
- [Overview of Cross-Platform Data Transport Using Image Copies](#) (page 28-3)
- [Performing Cross-Platform Tablespace Conversion with Image Copies](#) (page 28-5)
- [Performing Cross-Platform Data File Conversion with Image Copies](#) (page 28-7)
- [Performing Cross-Platform Database Conversion with Image Copies](#) (page 28-10)
- [Overview of Cross-Platform Data Transport Using Backup Sets](#) (page 28-19)
- [Performing Cross-Platform Database Transport with Backup Sets](#) (page 28-26)
- [Performing Cross-Platform Transport of Read-Only Tablespaces Using Backup Sets](#) (page 28-29)
- [Overview of Cross-Platform Transport of Tablespaces Using Inconsistent Backups](#) (page 28-32)
- [Performing Cross-Platform Transport of Tablespaces Using Inconsistent Backups](#) (page 28-33)
- [Performing Cross-Platform Data Transport in CDBs and PDBs](#) (page 28-41)

28.1 About Cross-Platform Data Transport

Cross-platform transportable tablespace is a variation of ordinary transportable tablespace. All of the restrictions that apply to transportable tablespaces apply here also, such as the need to ensure that all of the objects being transported are completely contained within the set of tablespaces being transported. Cross-platform transportable tablespace can be performed between platforms that have the same, or different, endian format.

Cross-platform transportable database is not the same thing as transportable tablespace. In this case you are copying an entire database, including the `SYSTEM` tablespace from one platform to another. Containment checks are irrelevant, and because the `SYSTEM` tablespace is being copied, no export/import step is required. Cross-platform transportable database can only be performed between platforms that have the same endian format.

28.1.1 Purpose of Cross-Platform Data Transport

You can transport tablespaces in a database that runs on one platform into a database that runs on a different platform. Typical uses of cross-platform transportable tablespaces include the following:

- Publishing structured data as transportable tablespaces for distribution to customers, who can convert the tablespaces for integration into their existing databases regardless of platform
- Moving data from a large data warehouse server to data marts on smaller computers such as Linux-based workstations or servers
- Sharing read-only tablespaces across a heterogeneous cluster in which all hosts share the same endian format
- Migrating tablespaces across platforms with minimal application downtime

A full discussion of transportable tablespaces, their uses, and the different techniques for creating and using them is found in *Oracle Database Administrator's Guide*.

You can also use RMAN to transport an entire database from one platform to another. For example, business requirements demand that you run your databases on less expensive servers that use a different platform. In this case, you can use RMAN to transport the entire database rather than re-create it and use import utilities or transportable tablespaces to repopulate the data.

You can convert a database on the destination host or source host. Reasons for converting on the destination host include:

- Avoiding performance overhead on the source host due to the conversion process
- Distributing a database from one source system to multiple recipients on several different platforms
- Evaluating a migration path for a new platform

28.1.2 Methods of Transporting Data Across Platforms

RMAN enables you to transport data files, tablespaces, or an entire database from one platform to another. When you transport an entire database to a different platform, the destination platform must have the same endian format as the source platform.

Use one of the following methods to transport data across platforms:

- Transport data using image copies
- Transport data using backup sets

See Also:

- ["Overview of Cross-Platform Data Transport Using Image Copies \(page 28-3\)"](#)
 - ["Overview of Cross-Platform Data Transport Using Backup Sets \(page 28-19\)"](#)
-
-

28.1.3 Platforms that Support Cross-Platform Data Transport

The Oracle Database maintains a list of internal names for each platform that supports cross-platform data transport. These names are stored in the `V$TRANSPORTABLE_PLATFORM` view. Use this view to determine the internal name of the [source platform](#) or [destination platform](#). While transporting data across platforms, you may need to specify the exact name of the source or destination platform. Any platform names specified as a parameter of the `CONVERT` or `BACKUP` command must be entered exactly as shown in the `V$TRANSPORTABLE_PLATFORM` view.

Use the following query to obtain the platform name of the connected database:

```
SELECT PLATFORM_NAME
   FROM V$TRANSPORTABLE_PLATFORM
  WHERE PLATFORM_ID =
        ( SELECT PLATFORM_ID FROM V$DATABASE );
```

Use the following query to obtain the name of the Linux platform:

```
SELECT PLATFORM_ID, PLATFORM_NAME, ENDIAN_FORMAT
   FROM V$TRANSPORTABLE_PLATFORM
  WHERE UPPER(PLATFORM_NAME) LIKE '%LINUX%';
```

28.2 Overview of Cross-Platform Data Transport Using Image Copies

RMAN enables you to use image copies to transport tablespaces, data files, or an entire database. You use the `RMAN CONVERT` command to perform cross-platform transport with image copies. Tablespace transport is sometimes performed by individually transporting the data files that store the tablespace data. However, it is not possible to transport a single data file that is part of a tablespace that consists of multiple data files.

You must use the `RMAN CONVERT` command in a transportable tablespace operation when the [source platform](#) is different from the [destination platform](#) and the endian formats are different. If you are converting part of the database between platforms that have the same endian format, you can use operating system methods to copy the files from the source to the destination. If you are converting an entire, same endian database, any data files with undo information must be converted. You cannot copy these files directly from the source to the destination platform.

28.2.1 Overview of Tablespace and Data File Conversion Using Image Copies

You can perform tablespace conversion with the `RMAN CONVERT TABLESPACE` command on the source host, but not on the destination host. The `CONVERT TABLESPACE` command does not perform in-place conversion of data files. Rather, the command produces output files in the correct format for use on the destination platform. The command does not alter the contents of data files in the [source database](#).

You can use the `CONVERT DATAFILE` command to convert files. Typically, the `CONVERT DATAFILE` command is used on the destination host and the `CONVERT TABLESPACE` command is used on the source host. When you use the `CONVERT DATAFILE` command on the source host, ensure that data files are cleanly offline or the tablespaces containing those data files are read-only. The Data Pump Export utility generates an [export dump file](#) that, with data files manually copied to the destination host, can be imported into the [destination database](#). Until the Data Pump export dump file is imported into the destination database, the data files are not associated with a tablespace name in the database. In this case, RMAN cannot translate the tablespace

name into a list of data files. Therefore, you must use `CONVERT DATAFILE` and identify the data files by file name.

Note:

Using `CONVERT TABLESPACE` or `CONVERT DATAFILE` is only one step in using cross-platform transportable tablespaces. Read the discussion of transportable tablespaces in *Oracle Database Administrator's Guide in its entirety* before attempting to follow the procedures in this chapter.

See Also:

The following sections describe how to perform cross-platform transport of tablespaces and data files using image copies:

- ["Performing Cross-Platform Tablespace Conversion with Image Copies \(page 28-5\)"](#)
 - ["Performing Cross-Platform Data File Conversion with Image Copies \(page 28-7\)"](#)
-

28.2.2 Overview of Database Conversion Using Image Copies

To convert a whole database to a different platform, both platforms must use the same endian format. The `RMAN CONVERT DATABASE` command automates the movement of an entire database from a source platform to a destination platform. The transported database contains the same data as the [source database](#) and also has, with a few exceptions, the same settings as the source database.

Files automatically transported to the destination platform include:

- Data files that belong to permanent tablespaces
Unlike transporting tablespaces across platforms, transporting entire databases requires that certain types of blocks, such as blocks in undo segments, be reformatted to ensure compatibility with the destination platform. Even though the endian formats for the source and destination platforms are the same, certain types of files must undergo a conversion process. See "[Checking the Database Before Cross-Platform Database Conversion \(page 28-10\)](#)" for details about the types of files that need conversion.
- Initialization parameter file or server parameter file
If the database uses a text-based initialization parameter file, then `RMAN` transports it. If the database uses a server parameter file, then `RMAN` generates an initialization parameter file based on the server parameter file, transports it and creates a new server parameter file at the destination based on the settings in the initialization parameter file.
Usually, some parameters in the initialization parameter file require manual updating for the new database. For example, you may change the `DB_NAME` and parameters such as `CONTROL_FILES` that indicate the locations of files on the destination host.

You can convert the format of the data files either on the source platform or on the destination platform. The `CONVERT DATABASE ON DESTINATION PLATFORM`

command does not convert the format of data files. Rather, it generates scripts that you can run manually to perform the conversion. The `CONVERT SCRIPT` parameter creates a [convert script](#) that you can manually execute at the destination host to convert data file copies in batch mode. The `TRANSPORT SCRIPT` parameter generates a [transport script](#) that contains SQL statements to create the new database on the destination platform.

See Also:

My Oracle Support Note 1079563.1, "RMAN DUPLICATE/RESTORE/RECOVER Mixed Platform Support" for the following information:

- List of platform combinations that do not require the `CONVERT DATABASE` command
 - Prerequisites for the source database and destination databases
-
-

See Also:

<http://www.oracle.com/goto/maa> for best practices on using cross-platform transportable tablespace and database procedures as part of data migration tasks

See Also:

The following sections describe how to perform cross-platform transport of a database using image copies:

- ["Checking the Database Before Cross-Platform Database Conversion \(page 28-10\)"](#)
 - ["Converting Data Files on the Source Host When Transporting a Database \(page 28-13\)"](#)
 - ["Converting Data Files on the Destination Host When Transporting a Database \(page 28-16\)"](#)
-
-

28.3 Performing Cross-Platform Tablespace Conversion with Image Copies

See the list of `CONVERT` command prerequisites described in *Oracle Database Backup and Recovery Reference*. Meet all these prerequisites before doing the steps in this section.

For purposes of illustration, assume that you must transport tablespaces `finance` and `hr` from [source database](#) `prod_source`, which runs on a Sun Solaris host. You plan to transport them to [destination database](#) `prod_dest` running on a Linux PC. You plan to store the converted data files in the temporary directory `/tmp/transport_linux/` on the source host.

See Also:

["Overview of Tablespace and Data File Conversion Using Image Copies \(page 28-3\)"](#)

To perform cross-platform tablespace conversion with image copies:

1. Start SQL*Plus and connect to the source database `prod_source` with administrator privileges.
2. Query the name for the destination platform in the `V$TRANSPORTABLE_PLATFORM` view.

The `PLATFORM_NAME` for Linux on a PC is `Linux IA (64-bit)`.

See Also:

["Platforms that Support Cross-Platform Data Transport \(page 28-3\)"](#) for information about determining the platform name

3. Check if the tablespaces to be transported are self-contained by executing the `DBMS_TTS.TRANSPORT_SET_CHECK` procedure. If the `TRANSPORT_SET_VIOLATIONS` view contains rows corresponding to the specified tablespaces, then you must resolve the dependencies before proceeding with the conversion.

See Also:

[Example 21-1](#) (page 21-8) for information about executing the `DBMS_TTS.TRANSPORT_SET_CHECK` procedure

4. Place the tablespaces to be transported in read-only mode. For example, enter:

```
ALTER TABLESPACE finance READ ONLY;  
ALTER TABLESPACE hr READ ONLY;
```

5. Choose a method for naming the output files.

See Also:

["About Renaming Output Files During RMAN Cross-Platform Data File Conversion \(page 28-7\)"](#)

6. Start RMAN and connect to the *source* database (not the destination database) as `TARGET`. For example, enter:

```
% rman  
RMAN> CONNECT TARGET "sbu@prod_source AS SYSBACKUP";
```

7. Run the `CONVERT TABLESPACE` command to convert the data files into the endian format of the destination host.

In the following example, the `FORMAT` argument controls the name and location of the converted data files:

```

RMAN> CONVERT TABLESPACE finance,hr
2> TO PLATFORM 'Linux IA (64-bit)'
3> FORMAT '/tmp/transport_linux/%U';

```

The result is a set of converted data files in the `/tmp/transport_linux/` directory, with data in the correct endian format for the Linux IA (64-bit) platform.

See Also:

Oracle Database Backup and Recovery Reference for the full semantics of the CONVERT command

8. Follow the rest of the general outline for transporting tablespaces:
 - a. Use the Oracle Data Pump Export utility to create the [export dump file](#) on the source host.
 - b. Move the converted data files and the export dump file from the source host to the desired directories on the destination host.
 - c. Plug the tablespace in to the new database with the DataPump Import utility.
 - d. If applicable, place the transported tablespaces into read/write mode.

See Also:

Oracle Database Administrator's Guide for information about using transportable tablespaces

28.4 Performing Cross-Platform Data File Conversion with Image Copies

See the list of CONVERT command prerequisites described in *Oracle Database Backup and Recovery Reference*. Meet these prerequisites before performing the steps in this section.

This section contains the following topics:

- [About Renaming Output Files During RMAN Cross-Platform Data File Conversion](#) (page 28-7)
- [Performing Tablespace Transportation on the Destination Host Using RMAN CONVERT DATAFILE](#) (page 28-8)

28.4.1 About Renaming Output Files During RMAN Cross-Platform Data File Conversion

Data file conversion necessitates that you choose a technique for naming the output files. You must use the `FORMAT` or `DB_FILE_NAME_CONVERT` arguments to the CONVERT command to control the naming of output files. The rules are listed in order of precedence:

1. Any file that matches any pattern provided in the `DB_FILE_NAME_CONVERT` clause is named based upon this pattern.

2. If you specify a `FORMAT` clause, then any file not named based on the pattern provided in the `DB_FILE_NAME_CONVERT` clause is named based on the `FORMAT` pattern.

Note:

You cannot use the `DB_FILE_NAME_CONVERT` clause to generate output file names for the `CONVERT` command when both the source and destination files are Oracle Managed Files.

If the source and destination platforms differ, then you must specify the `FROM PLATFORM` parameter. View platform names by querying the `V$TRANSPORTABLE_PLATFORM`. The `FROM PLATFORM` value must match the format of the data files to be converted to avoid an error. If you do not specify `FROM PLATFORM`, then this parameter defaults to the value of the destination platform.

See Also:

"[Platforms that Support Cross-Platform Data Transport](#) (page 28-3)" for information about determining the platform name

28.4.2 Performing Tablespace Transportation on the Destination Host Using RMAN CONVERT DATAFILE

This section explains how to use the `CONVERT DATAFILE` command. The section assumes that you intend to transport tablespaces `finance` (data files `fin/fin01.dbf` and `fin/fin02.dbf`) and `hr` (data files `hr/hr01.dbf` and `hr/hr02.dbf`) from a [source database](#) named `prod_source`. The database runs on a Sun Solaris host. You plan to transport these tablespaces into a [destination database](#) named `prod_dest`, which runs on a Linux PC. You plan to perform conversion on the destination host.

When the data files are plugged in to the destination database, you plan to store them in `/orahome/dbs` and preserve the current directory structure. That is, data files for the `hr` tablespace are stored in the `/orahome/dbs/hr` subdirectory, and data files for the `finance` tablespace are stored in the `/orahome/dbs/fin` directory.

See Also:

"[Overview of Tablespace and Data File Conversion Using Image Copies](#) (page 28-3)"

To perform cross-platform data file conversion with image copies:

1. Start SQL*Plus and connect to the [source database](#) `prod_source` with administrator privileges.
2. Query the name for the source platform in `V$TRANSPORTABLE_PLATFORM`.

For this scenario, assume that the `PLATFORM_NAME` for the source host is `Solaris[tm] OE (64-bit)`.

See Also:

["Platforms that Support Cross-Platform Data Transport \(page 28-3\)"](#) for information about determining the platform name

3. Identify the tablespaces to be transported from the source database and place them in read-only mode.

For example, enter the following SQL statements to place `finance` and `hr` in read-only mode:

```
ALTER TABLESPACE finance READ ONLY;
ALTER TABLESPACE hr READ ONLY;
```

4. On the source host, use Data Pump Export to create the [export dump file](#)

In this example, the dump file is named `expdat.dmp`.

5. Make the [export dump file](#) and the data files to be transported available to the destination host.

You can use NFS to make the dump file and current database files (not copies) accessible. Alternatively, you can use an operating system utility to copy these files to the destination host.

In this example, you store the files in the `/tmp/transport_solaris/` directory of the destination host. You preserve the subdirectory structure from the original location of the files; that is, the data files are stored as:

- `/tmp/transport_solaris/fin/fin01.dbf`
- `/tmp/transport_solaris/fin/fin02.dbf`
- `/tmp/transport_solaris/hr/hr01.dbf`
- `/tmp/transport_solaris/hr/hr02.dbf`

6. Start RMAN and connect to the [destination database](#) (not the source database) as `TARGET`. For example, the following command connects to the target database `prod_dest` using the `sbu` user who is granted the `SYSBACKUP` privilege:

```
% rman
RMAN> CONNECT TARGET "sbu@prod_dest AS SYSBACKUP";
```

7. Execute the `CONVERT DATAFILE` command to convert the data files into the endian format of the destination host.

In this example, you use `DB_FILE_NAME_CONVERT` to control the name and location of the converted data files. You also specify the `FROM PLATFORM` clause.

```
RMAN> CONVERT DATAFILE
2> '/tmp/transport_solaris/fin/fin01.dbf',
3> '/tmp/transport_solaris/fin/fin02.dbf',
4> '/tmp/transport_solaris/hr/hr01.dbf',
5> '/tmp/transport_solaris/hr/hr02.dbf'
6> DB_FILE_NAME_CONVERT
7> '/tmp/transport_solaris/fin','/orahome/dbs/fin',
8> '/tmp/transport_solaris/hr','/orahome/dbs/hr'
9> FROM PLATFORM 'Solaris[tm] OE (64-bit)';
```

The result is a set of converted data files in the `/orahome/dbs/` directory that are named as follows:

- `/orahome/dbs/fin/fin01.dbf`
- `/orahome/dbs/fin/fin02.dbf`
- `/orahome/dbs/hr/hr01.dbf`
- `/orahome/dbs/hr/hr02.dbf`

8. Follow the rest of the general outline for transporting tablespaces:
 - a. Plug the tablespace in to the new database with the DataPump Import utility.
 - b. If applicable, place the transported tablespaces into read-only mode.

See Also:

- *Oracle Database Backup and Recovery Reference* for the syntax and semantics of the `CONVERT` command
 - *Oracle Database Administrator's Guide* for information about transportable tablespaces
-
-

28.5 Performing Cross-Platform Database Conversion with Image Copies

When you perform cross-platform database conversion with image copies, you can convert the data files on either the source host or the destination host.

This section contains:

- [Checking the Database Before Cross-Platform Database Conversion](#) (page 28-10)
- [Converting Data Files on the Source Host When Transporting a Database](#) (page 28-13)
- [Converting Data Files on the Destination Host When Transporting a Database](#) (page 28-16)

28.5.1 Checking the Database Before Cross-Platform Database Conversion

As explained in "[Overview of Cross-Platform Data Transport Using Image Copies](#) (page 28-3)", you can use the `RMAN CONVERT DATABASE` command to automate the copying of an entire database from one platform to another. You convert the database data files on either the source or destination platforms.

Before converting the database, see the list of `CONVERT DATABASE` command prerequisites described in *Oracle Database Backup and Recovery Reference*. Confirm that you meet all these prerequisites before attempting the procedure in this section.

One prerequisite is that both the source and destination platform must share the same endian format. For example, you can transport a database from Microsoft Windows to Linux for x86 (both little-endian), or from HP-UX to AIX (both big-endian), but not from HP-UX to Linux for x86 (big-endian to little-endian).

Note:

If you cannot use the `CONVERT DATABASE` command because the platforms do not share endian formats, then you can create a new database on the destination platform and then use cross-platform transportable tablespace to copy your data.

When you transport entire databases, note that certain files require RMAN conversion to ensure compatibility with the destination platform. Even though the endian formats for the source and destination platform are the same, these files cannot be simply copied from the source to the destination system. The following kinds of files require RMAN conversion:

- Any file containing undo segments
- Any file containing automatic segment space management (ASSM) segment headers that is being transported to or from the HP Tru64 platform

Note:

When converting to or from Tru64 UNIX platform, even if the databases use the same endian format, you must use the `CONVERT` command to convert data files with automatic segment space management (ASSM) headers. See My Oracle Support Note 732053.1 for information about identifying data files that contain undo data or ASSM headers.

The `CONVERT DATABASE` command, by default, processes all data files in the database using RMAN conversion. The RMAN conversion copies the files from one location to another, even when it does not make any changes to the file. If you have other preferred means to copy those files that do not require RMAN conversion, you can use the `SKIP UNNECESSARY DATAFILES` option of the `CONVERT DATABASE` command. If you select this option, then the `CONVERT DATABASE` command only processes the files that require conversion. All other files must either be made accessible to the user or copied from the source to the [destination database](#).

Whether the data file conversion is performed at the source or destination host, you must copy the files while the [source database](#) is open in read-only mode.

To check the database before cross-platform conversion:

1. On the [source database](#), start a SQL*Plus session as a user with the SYSDBA or SYSBACKUP privilege.
2. Open the database in read-only mode.

```
SHUTDOWN IMMEDIATE
STARTUP MOUNT
ALTER DATABASE OPEN READ ONLY;
```

3. Ensure that server output is on in SQL*Plus.

For example, enter the following SQL*Plus command:

```
SET SERVEROUTPUT ON
```

4. Execute the `DBMS_TDB.CHECK_DB` function.

This check ensures that no conditions prevent the transport of the database, such as incorrect compatibility settings, in-doubt or active transactions, or incompatible endian formats between the source platform and destination platform.

You can call `CHECK_DB` without arguments to see if a condition at the source database prevents transport. You can also call this function with the arguments shown in [Table 28-1](#) (page 28-12).

Table 28-1 *CHECK_DB Function Parameters*

Parameter	Description
<code>target_platform_name</code>	The name of the destination platform as it appears in the <code>V_\$DB_TRANSPORTABLE_PLATFORM</code> view. This parameter is optional, but is required when the <code>skip_option</code> parameter is used. If omitted, it is assumed that the destination platform is compatible with the source platform, and only the conditions not related to platform compatibility are tested.
<code>skip_option</code>	Specifies which, if any, parts of the database to skip when checking whether the database can be transported. Supported values (of type <code>NUMBER</code>) are: <ul style="list-style-type: none"> • <code>SKIP_NONE</code> (or 0), which checks all tablespaces • <code>SKIP_OFFLINE</code> (or 2), which skips checking data files in offline tablespaces • <code>SKIP_READONLY</code> (or 3), which skips checking data files in read-only tablespaces

The following example illustrates executing `CHECK_DB` on a 32-bit Linux platform for transporting a database to 32-bit Windows, skipping read-only tablespaces.

```
DECLARE
  db_ready BOOLEAN;
BEGIN
  db_ready :=
    DBMS_TDB.CHECK_DB('Microsoft Windows IA (32-bit)',DBMS_TDB.SKIP_READONLY);
END;
/
```

PL/SQL procedure successfully completed.

If no warnings appear, or if `DBMS_TDB.CHECK_DB` returns `TRUE`, then you can transport the database. Proceed to Step 6.

If warnings appear, or if `DBMS_TDB.CHECK_DB` returns `FALSE`, then you cannot currently transport the database. Proceed to Step 5.

5. Examine the output to learn why the database cannot be transported, fix the problem if possible, and then return to the Step 4.

See Also:

Oracle Database PL/SQL Packages and Types Reference for information about `DBMS_TDB`

- Execute the `DBMS_TDB.CHECK_EXTERNAL` function to identify any external tables, directories, or BFILEs. RMAN cannot automate the transport of these files, so you must copy the files manually and re-create the database directories.

The following example shows how to call the `DBMS_TDB.CHECK_EXTERNAL` function.

```
DECLARE
    external BOOLEAN;
BEGIN
    /* value of external is ignored, but with SERVEROUTPUT set to ON
    * dbms_tdb.check_external displays report of external objects
    * on console */
    external := DBMS_TDB.CHECK_EXTERNAL;
END;
/
```

If no external objects exist, then the procedure completes with no output. If external objects exist, however, then the output is similar to the following:

```
The following external tables exist in the database:
SH.SALES_TRANSACTIONS_EXT
The following directories exist in the database:
SYS.DATA_PUMP_DIR, SYS.MEDIA_DIR, SYS.DATA_FILE_DIR, SYS.LOG_FILE_DIR
The following BFILEs exist in the database:
PM.PRINT_MEDIA

PL/SQL procedure successfully completed.
```

28.5.2 Converting Data Files on the Source Host When Transporting a Database

When you transport entire databases, certain types of blocks such as blocks in undo segments must be reformatted to ensure compatibility with the destination platform. Even though the endian formats for the source and destination platform are the same, certain data files must undergo a conversion process and cannot be simply copied from one platform to another.

Data files with undo information and those from the HP Tru64 platform must be converted. By default, all data files are converted when the `CONVERT DATABASE` command is executed. If, however, `SKIP UNNECESSARY DATAFILES` is used in the `CONVERT DATABASE` command, then the data files with undo segments and those from the HP Tru64 platform are converted. All other data files do not require conversion and can be copied to the new database using FTP, an operating system copy command, or some other mechanism.

See Also:

["Overview of Database Conversion Using Image Copies \(page 28-4\)"](#)

This section assumes that you have met all of the `CONVERT DATABASE` prerequisites and followed the steps in ["Checking the Database Before Cross-Platform Database Conversion \(page 28-10\)"](#). The goal of this procedure is to convert the format of data files on the source host as part of a cross-platform database transport.

Assume that you want to convert a database running on Solaris to a database that runs on Windows.

To convert the database on the source host:

1. Open the [source database](#) in read-only mode.

```
SHUTDOWN IMMEDIATE;
STARTUP MOUNT;
ALTER DATABASE OPEN READ ONLY;
```

2. Start RMAN and connect to the source database as TARGET as described in "[Making Database Connections with RMAN](#) (page 4-2)".
3. Run the CONVERT DATABASE command.

The following example shows a CONVERT DATABASE command (sample output included). The TRANSPORT SCRIPT parameter specifies the location of the generated SQL script that you can use to create the new database. The TO PLATFORM parameter indicates the platform of the [destination database](#). The DB_FILE_NAME_CONVERT parameter specifies the naming scheme for the generated data files.

```
RMAN> CONVERT DATABASE
2> NEW DATABASE 'newdb'
3> TRANSPORT SCRIPT '/tmp/convertdb/transportscript.sql'
4> TO PLATFORM 'Microsoft Windows IA (32-bit)'
5> DB_FILE_NAME_CONVERT '/disk1/oracle/dbs' '/tmp/convertdb';
```

```
Starting conversion at source at 25-NOV-13
using channel ORA_DISK_1
```

```
External table SH.SALES_TRANSACTIONS_EXT found in the database
.
.
.
Directory SYS.ORACLE_HOME found in the database
Directory SYS.ORACLE_BASE found in the database
Directory SYS.LOG_FILE_DIR found in the database
.
.
.
BFILE PM.PRINT_MEDIA found in the database
```

```
User SYS with SYSDBA and SYSOPER privilege found in password file
User SBU with SYSBACKUP privilege found in password file
channel ORA_DISK_1: starting datafile conversion
input datafile fno=00001 name=/disk1/oracle/dbs/tbs_01.f
converted datafile=/tmp/convertdb/tbs_01.f
channel ORA_DISK_1: datafile conversion complete, elapsed time: 00:00:15
channel ORA_DISK_1: starting datafile conversion
input datafile fno=00002 name=/disk1/oracle/dbs/tbs_ax1.f
converted datafile=/tmp/convertdb/tbs_ax1.f
channel ORA_DISK_1: datafile conversion complete, elapsed time: 00:00:03
.
.
.
channel ORA_DISK_1: starting datafile conversion
input datafile fno=00016 name=/disk1/oracle/dbs/tbs_52.f
converted datafile=/tmp/convertdb/tbs_52.f
channel ORA_DISK_1: datafile conversion complete, elapsed time: 00:00:01
Edit init.ora file init_00gb3vfv_1_0.ora. This PFILE will be used to
create the database on the target platform
Run SQL script /tmp/convertdb/transportscript.sql on the target platform
```



```

to create database
To recompile all PL/SQL modules, run utlirp.sql and utlrp.sql on
the target platform
To change the internal database identifier, use DBNEWID Utility
Finished conversion at source at 25-NOV-13

```

4. After CONVERT DATABASE completes, you can open the source database read/write again.
5. Move the data files generated by CONVERT DATABASE to the desired locations on the destination host.

In Step 3 (page 28-14), the command creates the files in the /tmp/convertdb/ directory on the source host. Move these files to the directory on the destination host that will contain the destination database files.

6. If the path to the data files is different on the destination host, then edit the transport script to refer to the new data file locations.
7. If necessary, edit the initialization parameter file to change any settings for the destination database.

You must edit several entries at the top of the initialization parameter file when the database is moved to the destination platform. For example, the initialization parameter file may look as follows:

```

# Please change the values of the following parameters:
control_files          = "/tmp/convertdb/cf_D-NEWDBT_id-1778429277_00gb9u2s"
service_names         = "NEWDBT.example.com"
db_recovery_file_dest = "/tmp/convertdb/orcva"
db_recovery_file_dest_size= 10737418240
instance_name         = "NEWDBT"
db_name               = "NEWDBT"
plsql_native_library_dir = "/tmp/convertdb/plsqlnld1"

```

8. If necessary, edit the transport script to use the new names for the converted data files.

In the example in Step 3 (page 28-14), the transport script is named /tmp/convertdb/transportscript.sql. You run this script on the [destination host](#) to create the database. Thus, you must edit this script with the correct names for the data files.

9. On the destination host, start SQL*Plus and connect to the destination database instance as SYSDBA or SYSBACKUP using operating system authentication.

For example, connect as follows:

```
SQL> CONNECT / AS SYSBACKUP
```

If you choose not to use operating system authentication, you can create a [password file](#) and then connect with a user name and password.

10. Execute the transport script in SQL*Plus to create the new database on the destination host.

```
SQL> @transportscript
```

When the transport script finishes, the creation of the new database is complete.

See Also:

Oracle Database Administrator's Guide for information about operating system authentication and password file authentication

28.5.3 Converting Data Files on the Destination Host When Transporting a Database

This section assumes that you have met all of the `CONVERT DATABASE` command prerequisites and followed the steps in "[Checking the Database Before Cross-Platform Database Conversion](#) (page 28-10)". The goal of this procedure is to convert the format of data files on the destination host as part of a cross-platform database transport.

See Also:

"[Overview of Database Conversion Using Image Copies](#) (page 28-4)"

Perform the data file conversion in the following phases:

1. [Performing Preliminary Data File Conversion Steps on the Source Host](#) (page 28-16)
2. [Running the Conversion Scripts on the Destination Host](#) (page 28-18)

28.5.3.1 Performing Preliminary Data File Conversion Steps on the Source Host

In this procedure, you execute the `CONVERT DATABASE` command on the source host. This command generates an initialization parameter file and scripts that you can edit for use on the destination host. You also copy the unconverted data files from the source host to the destination host.

To perform preliminary data file conversion steps on the source host:

1. Ensure that the database is open in read-only mode.
2. Start RMAN and connect to the *source* database as `TARGET`, as described in "[Making Database Connections with RMAN](#) (page 4-2)".
3. Run the `CONVERT DATABASE ON DESTINATION PLATFORM` command.

The following example shows a sample `CONVERT DATABASE` command (sample output included). The `ON DESTINATION PLATFORM` parameter specifies that any `CONVERT` commands required for data files are executed on the destination platform rather than the source platform. The `FORMAT` parameter specifies the naming scheme for the generated files.

```
RMAN> CONVERT DATABASE
2> ON DESTINATION PLATFORM
3> CONVERT SCRIPT '/tmp/convertdb/convertscript-target'
4> TRANSPORT SCRIPT '/tmp/convertdb/transportscript-target'
5> NEW DATABASE 'newdbt'
6> FORMAT '/tmp/convertdb/%U';
```

```
Starting conversion at source at 28-JAN-13
using target database control file instead of recovery catalog
allocated channel: ORA_DISK_1
channel ORA_DISK_1: sid=39 devtype=DISK
```

```

External table SH.SALES_TRANSACTIONS_EXT found in the database
.
.
.
Directory SYS.ORACLE_HOME found in the database
Directory SYS.ORACLE_BASE found in the database
Directory SYS.LOG_FILE_DIR found in the database
.
.
.
BFILE PM.PRINT_MEDIA found in the database

User SYS with SYSDBA and SYSOPER privilege found in password file
User SBU with SYSBACKUP privilege found in password file
channel ORA_DISK_1: starting to check datafiles
input datafile fno=00001 name=/disk1/oracle/dbs/tbs_01.f
channel ORA_DISK_1: datafile checking complete, elapsed time: 00:00:00
channel ORA_DISK_1: starting to check datafiles
input datafile fno=00002 name=/disk1/oracle/dbs/tbs_ax1.f
channel ORA_DISK_1: datafile checking complete, elapsed time: 00:00:00
channel ORA_DISK_1: starting to check datafiles
input datafile fno=00017 name=/disk1/oracle/dbs/tbs_03.f
channel ORA_DISK_1: datafile checking complete, elapsed time: 00:00:00
.
.
.
channel ORA_DISK_1: starting to check datafiles
input datafile fno=00015 name=/disk1/oracle/dbs/tbs_51.f
channel ORA_DISK_1: datafile checking complete, elapsed time: 00:00:00
channel ORA_DISK_1: starting to check datafiles
input datafile fno=00016 name=/disk1/oracle/dbs/tbs_52.f
channel ORA_DISK_1: datafile checking complete, elapsed time: 00:00:00
Edit init.ora file /tmp/convertdb/init_00gb9u2s_1_0.ora. This PFILE will be used
to create the database on the target platform
Run SQL script /tmp/convertdb/transportscript-target on the target platform to
create database
Run RMAN script /tmp/convertdb/convertscript-target on target platform to convert
datafiles
To recompile all PL/SQL modules, run utlirp.sql and utlrp.sql on the target
platform
To change the internal database identifier, use DBNEWID Utility
Finished conversion at source at 28-JAN-13

Starting Control File Autobackup at 28-JAN-13
piece handle=/disk2/oracle/backups/c-1678658224-20131202-02 comment=NONE
Finished Control File Autobackup at 28-JAN-13

```

The previous command creates a transport script, an initialization parameter file for the new database, and a convert script containing RMAN CONVERT DATAFILE commands for each data file being converted.

Note:

CONVERT DATABASE ON DESTINATION PLATFORM does *not* produce converted data file copies. The command only creates scripts.

4. Use an operating system utility to copy the following files to a temporary location on the destination host:

- The data files to be converted
- The convert script
- The transport script
- The initialization file for the destination database

5. Make the source database read/write.

28.5.3.2 Running the Conversion Scripts on the Destination Host

This section explains how to use the scripts created in the previous section to convert the data files on the destination host and complete the transport process.

The convert script created in the previous phase uses the original data file names of the [source database](#) files. The `FORMAT` parameter specifies the name that was generated with the `FORMAT` or `DB_FILE_NAME_CONVERT` parameter of the `CONVERT DATABASE` command.

If the data files of the source database are accessible from the destination host with the same path names, then so long as the source database is read-only you can run the convert script on the destination host without any changes. For example, if the source and destination hosts both use NFS to mount a disk containing the source data files, and if the mount point for both hosts is `/fs1/dbs/`, then no editing is needed.

To run the conversion scripts on the destination host:

1. If necessary, edit the convert script.

In the script, one `CONVERT DATAFILE` command exists for each data file to be converted. The convert script must indicate the current temporary file names of the unconverted data files and the output file names of the converted data files. A typical convert script looks as follows:

```
RUN
{
  CONVERT
  FROM PLATFORM 'Linux IA (32-bit)'
  PARALLELISM 10
  DATAFILE '/disk1/oracle/dbs/tbs_01.f'
  FORMAT '/tmp/convertdb/data_D-TV_I-1778429277_TS-SYSTEM_FNO-1_7qgb9u2s'

  DATAFILE '/disk1/oracle/dbs/tbs_ax1.f'
  FORMAT '/tmp/convertdb/data_D-TV_I-1778429277_TS-SYSAUX_FNO-2_7rgb9u2s'

  DATAFILE '/disk1/oracle/dbs/tbs_03.f'
  FORMAT '/tmp/convertdb/data_D-TV_I-1778429277_TS-SYSTEM_FNO-17_7sgb9u2s'

  DATAFILE '/disk1/oracle/dbs/tbs_51.f'
  FORMAT '/tmp/convertdb/data_D-TV_I-1778429277_TS-TBS_5_FNO-15_8egb9u2u'

  DATAFILE '/disk1/oracle/dbs/tbs_52.f'
  FORMAT '/tmp/convertdb/data_D-TV_I-1778429277_TS-TBS_5_FNO-16_8fgb9u2u';
}
```

Edit each `DATAFILE` command in the convert script to specify the temporary location of each data file as input. Also, edit the `FORMAT` parameter of each command to specify the desired final location of the data files of the transported database.

2. If necessary, edit the initialization parameter file on the destination host to change settings for the [destination database](#).

You must edit several entries at the top of the initialization parameter file. For example, the initialization parameter file may look as follows:

```
# Please change the values of the following parameters:
control_files          = "/tmp/convertdb/cf_D-NEWDBT_id-1778429277_00gb9u2s"
db_recovery_file_dest = "/tmp/convertdb/orcva"
db_recovery_file_dest_size= 10737418240
instance_name         = "NEWDBT"
service_names         = "NEWDBT.example.com"
plsq1_native_library_dir = "/tmp/convertdb/plsqlnld1"
db_name               = "NEWDBT"
```

3. On the destination host, use SQL*Plus to start the database instance in NOMOUNT mode.

Specify the initialization parameter file that you copied in the preceding step. For example, enter the following command:

```
SQL> STARTUP NOMOUNT PFILE='/tmp/init_convertdb_00i2gj63_1_0.ora'
```

4. Start RMAN and connect to the destination database (not the source database) as TARGET. For example, enter the following command:

```
% rman
RMAN> CONNECT TARGET "sbu@prod_dest AS SYSBACKUP";
```

5. Run the convert script at the RMAN prompt. For example, enter the following command:

```
RMAN> @/tmp/convertdb/convertscript-target
```

6. Shut down the database instance.

This step is necessary because the transport script that must execute includes a `STARTUP NOMOUNT` command.

7. If necessary, edit the transport script to use the new names for the converted data files.

In the example in Step 3 (page 28-14), the transport script is `/tmp/convertdb/transportscript.sql`. You run this script on the destination host to create the database. Thus, you must edit this script with the correct names for the data files.

8. Execute the transport script in SQL*Plus.

For example, create the new database on the destination host as follows:

```
SQL> @/tmp/convertdb/transportscript
```

When the transport script completes, the destination database is created.

28.6 Overview of Cross-Platform Data Transport Using Backup Sets

RMAN can transport databases, data files, and tablespaces across platforms by using backup sets. Performing cross-platform data transport with backup sets enables you to use block compression to reduce the size of backups. This improves backup performance and reduces the time taken to transport backups over the network.

Note:

To perform cross-platform data transport using backup sets, the version of the destination database must be Oracle Database 12c Release 1 (12.1) or later.

When you transport an entire database to a different platform, the source platform and the destination platform must use the same endian format. However, user tablespaces can be transported to a destination platform that uses a different endian format from the source platform.

On the [source database](#), you create a [cross-platform backup](#) of the data that needs to be transported. A cross-platform backup is an RMAN backup that can be restored on a destination platform that is different from the source platform. On the [destination database](#), you restore and then recover the [cross-platform backup](#) to obtain the data that you wanted to transport. Cross-platform backups can be restored on any platform that is supported in the `V$TRANSPORTABLE_PLATFORM` view.

RMAN does not catalog backup sets created for cross-platform transport in the control file. This ensures that backup sets created for cross-platform transport are not used during regular restore operations.

About Clauses Used to Create Cross-Platform Backups Using Backups Sets

Use the `FOR TRANSPORT` or `TO PLATFORM` clause in the `BACKUP` command to create cross-platform backups. When you create a cross-platform backup of read-only tablespaces using either of these clauses, RMAN can also create a Data Pump [export dump file](#) containing the metadata required to plug these tablespaces into the destination database.

Although the `TO PLATFORM` and `FOR TRANSPORT` clauses are not supported in Oracle Database 10g Release 2 (10.2) or Oracle Database 11g, you can transport data from these versions of the database to Oracle Database 12c Release 1 (12.1). On the source database, you first create backup sets of the tablespaces to be transported and then create the Data Pump export dump file by using the `expdp` command. To restore these backups on the destination database, you perform a restore operation using the `RESTORE` command and then use the `impdp` command to import the Data Pump export dump file.

Scenarios in Which RMAN Automatically Creates a Cross-Platform Backup of the Database

When you use backup sets to back up an entire database RMAN automatically creates a [cross-platform backup](#) of the database in addition to the specified backup if the following conditions are met:

- Prerequisites for transporting an entire database as a backup set are satisfied.

See Also:

["Prerequisites for Cross-Platform Database Transport Using Backup Sets \(page 28-26\)"](#)

- The `BACKUP` command does not contain any clause that is incompatible with the `FOR TRANSPORT` or `TO PLATFORM` clause.

See Also:

Oracle Database Backup and Recovery Reference for information about the incompatible clauses

The following BACKUP command creates a cross-platform backup of the database. Although the command does not contain either the FOR TRANSPORT or TO PLATFORM clause to indicate that it is a cross-platform backup, because the conditions described in "[Prerequisites for Cross-Platform Database Transport Using Backup Sets \(page 28-26\)](#)" are satisfied, an implicit cross-platform backup of the database is created.

```
RUN
{
  ALLOCATE CHANNEL c1 DEVICE TYPE DISK;
  ALLOCATE CHANNEL c2 DEVICE TYPE DISK;
  ALLOCATE CHANNEL c3 DEVICE TYPE DISK;
  BACKUP
    SKIP OFFLINE
    FILESPERSET 1
    FORMAT '/tmp/xplat_backups/implicit_full_db_%U'
  DATABASE; }
```

High-Level Steps to Transport Data Across Platforms Using Backup Sets

Transporting data across platforms using backup sets consists of the following high-level steps:

1. On the [source database](#), use the BACKUP command to create a [cross-platform backup](#) of the database, tablespaces, or data files that need to be transported to a different platform. The backup is created as backup sets on the source host.

See Also:

- "[About Backing Up Data on the Source Database for Cross-Platform Data Transport \(page 28-23\)](#)"
 - "[About the Data Pump Export Dump File Used for Cross-Platform Tablespace Transport \(page 28-23\)](#)"
-

2. Transfer the backup sets created on the source host to the destination host.

You can transport the backup sets using operating system utilities. For example, if your operating system is Linux or UNIX, you can use the `cp` command to transfer backup sets.

3. On the [destination database](#), restore the backup sets that were transferred from the source host. Use the RESTORE command to restore cross-platform backups.

When you are transporting tablespaces across platforms by using inconsistent tablespace backups, the additional step of recovering the tablespaces is required as described in "[Performing Cross-Platform Transport of Tablespaces Using Inconsistent Backups \(page 28-33\)](#)".

See Also:

- ["About Restoring Data on the Destination Host During Cross-Platform Data Transport \(page 28-24\)"](#)
 - ["About Selecting Objects to Be Restored from Cross-Platform Backups \(page 28-25\)"](#)
 - ["About Names and Locations for Restored Objects on the Destination Database \(page 28-25\)"](#)
 - ["About Importing the Data Pump Export Dump File Created During Cross-Platform Tablespace Transport \(page 28-26\)"](#)
-

Detailed information about how to transport data across platforms using backup sets, the prerequisites, and the RMAN syntax used are provided in the following sections:

- ["Performing Cross-Platform Database Transport with Backup Sets \(page 28-26\)"](#)
- ["Performing Cross-Platform Transport of Read-Only Tablespaces Using Backup Sets \(page 28-29\)"](#)
- ["Performing Cross-Platform Transport of Tablespaces Using Inconsistent Backups \(page 28-33\)"](#)

28.6.1 Basic Terms Used in Cross-Platform Data Transport Using Backup Sets

Before using backup sets to perform cross-platform data transport, it is useful to understand the following terms.

Foreign Data File

Data files that do not belong to the [destination database](#) are called [foreign data files](#). These data files are being plugged in to the destination database as part of a data transfer to the destination database. In the [source database](#), this data file is identified by its original data file number.

Foreign Tablespace

A [foreign tablespace](#) is a set of foreign data files that comprise a tablespace in the [source database](#). These foreign data files do not belong to the [destination database](#), but are being transported into the destination database and are identified by the original tablespace name in the source database.

Foreign Data File Copy

A [foreign data file copy](#) is a data file that was restored from a [cross-platform backup](#). It cannot be directly plugged in to the [destination database](#) because it is inconsistent. You must apply a cross-platform incremental backup to this data file and recover it before you can plug it in to the destination database.

Data Pump Destination

A Data Pump destination is a location on the disk of the server host of the destination database on which the Data Pump [export dump file](#) and the Data Pump log files are stored.

28.6.2 About Backing Up Data on the Source Database for Cross-Platform Data Transport

To create the backup set containing data that must be transported to the [destination database](#), use the BACKUP command on the [source database](#). To indicate that you are creating a [cross-platform backup](#), the BACKUP command must contain either the FOR TRANSPORT or TO PLATFORM clause.

When you use FOR TRANSPORT, the backup set that is created can be transported to any destination database. If the destination database uses an endian format that is different from that of the source database, then the required endian format conversion is performed on the destination database. The benefit of this method is that the processing overhead of the conversion operation is offloaded to the destination database.

When you use TO PLATFORM, the endian format conversion is performed on the source database. The target platform specified by the TO PLATFORM clause must be a supported platform for cross-platform transport. The V\$TRANSPORTABLE_PLATFORM view contains the list of supported platforms.

You can create cross-platform backups that contain multiple backup pieces. See the *Oracle Database Backup and Recovery Reference* for examples.

You cannot use certain clauses of the BACKUP command when you create a [cross-platform backup](#) using either the FOR TRANSPORT or TO PLATFORM clause. See *Oracle Database Backup and Recovery Reference* for information about the clauses that are not compatible with TO PLATFORM and FOR TRANSPORT.

28.6.3 About the Data Pump Export Dump File Used for Cross-Platform Tablespace Transport

When you create a cross-platform consistent tablespace backup, the backup set contains the data files that contain data related to the specified tablespaces. A consistent tablespace backup is a backup of one or more tablespaces that is created when the tablespaces are in read-only mode. After you restore this backup in your [destination database](#), the tablespaces must be plugged in to the destination database. To do this, in addition to the backup set containing the tablespace data, you need the metadata for these tablespaces from the [source database](#).

On the source database, use the DATAPUMP clause in the BACKUP command to create the metadata required to plug tablespaces in to the target database. The metadata is stored in a Data Pump [export dump file](#) as a separate backup set. Use this backup set to plug the transported tablespaces in to the target database.

You can specify how the backup set containing the tablespace metadata is named by using the FORMAT option with the DATAPUMP clause. If you omit the FORMAT option, then the format specified in the BACKUP command is used to name the [export dump file](#). When no FORMAT option is specified in the BACKUP command, the default format is used.

Note:

When you use the DATAPUMP clause, the tablespaces that are being transported must be made read-only.

28.6.4 About Restoring Data on the Destination Host During Cross-Platform Data Transport

On the [destination database](#), you use the `RESTORE` command to restore the database, tablespaces, or data files contained in a [cross-platform backup](#) consisting of backup sets. When you perform a cross-platform restore operation, you must use the `foreignFileSpec` subclause of the `RESTORE` command. See *Oracle Database Backup and Recovery Reference* for more information.

When you restore cross-platform backups, you must specify the following information:

- Backup set that contains data that was backed up on the [source database](#)
Use the `BACKUPSET` option of the `foreignFileSpec` subclause to specify the name of the cross-platform backup set from which data must be restored. If the cross-platform backup consists of multiple backup sets, use a separate `BACKUPSET` clause for each backup set. To restore tablespaces, you must specify the backup sets that contain the tablespace data using the `BACKUPSET` clause and the backup set that contains the tablespace metadata using the `DUMP FILE` option of the `foreignFileSpec` subclause.

Using multiple backup sets is not supported during recovery. You cannot apply multiple backup sets to a set of foreign data files.

See Also:

Oracle Database Backup and Recovery Reference for information about `BACKUPSET` and `DUMP FILE`

- Data file numbers or names of tablespaces as they exist in the source database
If you are restoring data files or tablespaces, you can restore specific tablespaces or data files that are contained in a cross-platform backup.

See Also:

["About Names and Locations for Restored Objects on the Destination Database \(page 28-25\)"](#)

- Location where the restored data files must be stored
Use the `FORMAT` clause to specify the location and the names used to store the restored data files.
If you do not provide a destination, then the `DB_FILE_CREATE_DEST` initialization parameter must be set in the target platform. `RMAN` restores the data files to the location specified by this parameter using new Oracle Managed File (OMF) names.

See Also:

["About Names and Locations for Restored Objects on the Destination Database \(page 28-25\)"](#)

- Name of the source platform (only when conversion is performed on the destination database)

Use `FROM PLATFORM` to specify the name of the source platform on which the backup sets were created. The platform name must exactly match the name specified while creating the backup set. If there is a difference in the platform names, the restore operation fails.

See Also:

["About Backing Up Data on the Source Database for Cross-Platform Data Transport \(page 28-23\)"](#)

28.6.5 About Selecting Objects to Be Restored from Cross-Platform Backups

While restoring data from a [cross-platform backup](#), you can either restore all the data contained in the cross-platform backup or only certain objects.

See Also:

Oracle Database Backup and Recovery Reference for more information about the clauses described in this section

Restoring All Data Contained in the Cross-Platform Backup

To restore the entire database, use the `FOREIGN DATABASE` clause in the `RESTORE` command. This clause can only be used when restoring from a whole database backup set and when both the [source platform](#) and [destination platform](#) use the same endian format. You can optionally use the `FORMAT` clause to specify the pattern used to name restored files.

To restore all the data files contained in the cross-platform backup, use the `ALL FOREIGN DATAFILES` clause in the `RESTORE` command.

Restoring Part of the Data Contained in the Cross-Platform Backup Set

You can restore some data files or tablespaces contained in a cross-platform backup. To restore only some data files, use the `FOREIGN DATAFILE` clause in the `RESTORE` command. Specify the absolute file number of the data file in the [source database](#) while restoring data. To restore only some tablespaces contained in a cross-platform backup, use the `FOREIGN TABLESPACE` clause in the `RESTORE` command. Specify the names of the tablespaces that must be restored as part of this clause.

28.6.6 About Names and Locations for Restored Objects on the Destination Database

When you restore a [cross-platform backup](#), specify the data file names and the location to which they are restored using one of the following options in the `RESTORE` command:

- Use the `TO NEW` option with the `ALL FOREIGN DATAFILES` clause to restore the data files to the location specified by the `DB_FILE_CREATE_DEST` parameter. By default, RMAN uses OMF names for the data files.
- Use the `FORMAT` option to specify the pattern used to name restored data files. You can also specify the directory for these files as part of the `FORMAT` specification.

See Also:

Oracle Database Backup and Recovery Reference for more information about the clauses described in this section

28.6.7 About Importing the Data Pump Export Dump File Created During Cross-Platform Tablespace Transport

While restoring a cross-platform backup of read-only tablespaces on the [destination database](#), use the `DUMP FILE ... FROM BACKUPSET` option of the `foreignFileSpec` subclause to restore the backup set that contains the Data Pump [export dump file](#). The export dump file contains the metadata required to plug the tablespace in to the destination database.

Use the `DATA PUMP` clause in the `RESTORE` command to specify the location on the destination host to which the export dump file is restored. If you omit this clause, the dump file is restored to a default operating system-specific location.

By default, RMAN automatically imports the export dump file after all the required [foreign data files](#) are restored. You can choose not to import the export dump file by specifying the `NOIMPORT` clause. If you do not import the export dump file as part of the restore operation, then you must manually import the dump file when you want to plug the tablespaces in to the destination database.

Note:

If the export dump file is automatically imported (that is, the `NOIMPORT` clause is not used), then the destination database must be open in read/write mode.

28.7 Performing Cross-Platform Database Transport with Backup Sets

You can transport an entire database from a source platform to a different destination platform. While creating the cross-platform backup to transport a database, you can convert the database either on the source database or the destination database. The benefit of performing the conversion on the destination database is that the processing overhead of the convert operation is offloaded from the source to the destination database.

See Also:

["Overview of Cross-Platform Data Transport Using Backup Sets \(page 28-19\)"](#)

Prerequisites for Cross-Platform Database Transport Using Backup Sets

Before you create a [cross-platform backup](#) to transport a database across platforms, the following prerequisites must be met:

- The `COMPATIBLE` parameter in the server parameter file of the [source database](#) and the [destination database](#) must be set to 12.0.0 or higher.
- The source database must be open in read-only mode.

- The `DBMS_TDB.CHECK_DB` procedure must run successfully.

See Also:

["Checking the Database Before Cross-Platform Database Conversion \(page 28-10\)"](#) for information about using the `DBMS_TDB.CHECK_DB` procedure

- The source platform and destination platform must use the same endian format.

See Also:

["Steps to Transport a Database to a Different Platform Using Backup Sets \(page 28-27\)"](#)

28.7.1 Steps to Transport a Database to a Different Platform Using Backup Sets

Use the following steps to transport an entire database from one platform to another:

1. Ensure that the prerequisites required to perform cross-platform database transport are met.

See Also:

["Prerequisites for Cross-Platform Database Transport Using Backup Sets \(page 28-26\)"](#)

2. Start SQL*Plus and connect to the [source database](#) `prod_source` with administrator privileges.

```
% sqlplus sys@prod_source as SYSDBA
```

When prompted, enter the password for the `sys` user.

3. Query the name of the destination platform in `V$TRANSPORTABLE_PLATFORM`.

To transport the entire database, the endian formats of the source platform and the destination platform must be the same.

See Also:

["Platforms that Support Cross-Platform Data Transport \(page 28-3\)"](#) for information about determining the platform name

4. Choose a method for naming the output files.

Use the `FORMAT` clause of the `BACKUP` command to specify the names of the output files.

For example, the following `FORMAT` clause specifies that the output files must be stored using unique names that begin with `transport_` in the directory `/oradata/backups/special`.

```
FORMAT '/oradata/backups/special/transport_%U'
```

5. Start RMAN and connect to the source database as TARGET.

The source database is the database that contains the data that needs to be transported to a different platform.

In this example, `sbu` is a user who is granted the `SYSDUMP` privilege in the source database `prod_source`.

```
% RMAN
RMAN> CONNECT TARGET "sbu@prod_source AS SYSBACKUP";
```

Enter the password for the `sbu` user when prompted.

6. Place the database in read-only mode.

```
SHUTDOWN IMMEDIATE;
STARTUP MOUNT;
ALTER DATABASE OPEN READ ONLY;
```

7. Back up the source database using the `FOR TRANSPORT` or `TO PLATFORM` clause in the `BACKUP` command. Using either of these clauses creates a [cross-platform backup](#) that uses backup sets.

The following example creates a cross-platform backup of the entire database. This backup can be restored on any supported platform that uses the same endian format as the source database. The source platform is Sun Solaris x86 64-bit. Because the `FOR TRANSPORT` clause is used, the conversion is performed on the destination database. The cross-platform database backup is stored in `db_trans.bck` in the `/tmp/xplat_backups` directory on the source host.

```
BACKUP
FOR TRANSPORT
FORMAT '/tmp/xplat_backups/db_trans.bck'
DATABASE;
```

8. Disconnect from the source database.
9. Move the backup sets created by the `BACKUP` command to the destination host.

Use operating system-specific utilities to transfer the created backup sets from the source host to the destination host.

For example, if the operating system of your source and destination hosts is Linux or UNIX, use the `cp` command to move files.

10. Connect to the [destination database](#), to which the database must be transported, as TARGET.

In this example, `sbu` is a user who is granted the `SYSDUMP` privilege in the destination database `prod_dest`.

```
% RMAN
RMAN> CONNECT TARGET "sbu@prod_dest AS SYSBACKUP";
```

Enter the password for the `sbu` user when prompted.

11. Ensure that the destination database is in `NOMOUNT` state.
12. Restore the backup sets that were transferred from the source by using the `RESTORE` command with the `FOREIGN DATABASE` clause.

The following example restores the cross-platform database backup created in Step 7 (page 28-28). The destination database uses the same endian format as the source database. The `FROM PLATFORM` clause specifies the name of the platform on which the backup was created. This clause is required to convert backups on the destination. The backup set containing the cross-platform database backup is stored in the `/tmp/xplat_restores` directory on the destination host. The `TO NEW` option specifies that the restored [foreign data files](#) must use new OMF-specified names in the destination database. Ensure that the `DB_CREATE_FILE_DEST` initialization parameter is set.

```
RESTORE
FROM PLATFORM 'Solaris Operating System (x86-64)'
FOREIGN DATABASE TO NEW
FROM BACKUPSET '/tmp/xplat_restores/db_trans.bck';
```

28.8 Performing Cross-Platform Transport of Read-Only Tablespaces Using Backup Sets

Use the `BACKUP` command with the `FOR TRANSPORT` or `TO PLATFORM` clause to create backup sets that can be used to transport read-only tablespaces from one platform to another. When you transport read-only tablespaces, you must also export the metadata of these tablespaces. The metadata is required to plug the tablespaces in to the [destination database](#). While transporting tablespaces across platforms, the source and destination platform can use different endian formats.

You can restore all the data files or tablespaces contained in a [cross-platform backup](#) or only some of them. After restoring these objects, you can specify the name and location for the restored data files.

See Also:

- ["About Backing Up Data on the Source Database for Cross-Platform Data Transport \(page 28-23\)"](#)
 - ["About Selecting Objects to Be Restored from Cross-Platform Backups \(page 28-25\)"](#)
 - ["About Names and Locations for Restored Objects on the Destination Database \(page 28-25\)"](#)
-

Prerequisites for Performing Cross-Platform Tablespace Transport Using Backup Sets

Before you create a [cross-platform backup](#) that can be used to transport tablespaces to a different platform, the following prerequisites must be met:

- `COMPATIBLE` parameter in the server parameter file of the [source database](#) and destination database is set to 12.0.0 or greater.
- The tablespaces to be transported are self-contained.

Execute the `DBMS_TTS.TRANSPORT_SET_CHECK` procedure to check for dependencies. If the `TRANSPORT_SET_VIOLATIONS` view contains rows corresponding to the specified tablespaces, then you must resolve the dependencies before creating the cross-platform backup.

See Also:

[Example 21-1](#) (page 21-8) for information about executing the `DBMS_TTS.TRANSPORT_SET_CHECK` procedure

- The tablespaces to be transported are in read-only mode, unless the `ALLOW INCONSISTENT` clause is used in the `BACKUP` command.
-
-

See Also:

["Steps to Transport Read-Only Tablespaces to a Different Platform Using Backup Sets"](#) (page 28-30) for information about using the `DBMS_TDB.CHECK_DB` procedure

28.8.1 Steps to Transport Read-Only Tablespaces to a Different Platform Using Backup Sets

1. Ensure that the prerequisites required to transport tablespaces to another platform are met.
-
-

See Also:

["Prerequisites for Performing Cross-Platform Tablespace Transport Using Backup Sets"](#) (page 28-29)

2. Connect to the [source database](#) from which you need to transport tablespaces as `TARGET`.

In this example, `sbu` is a user who is granted the `SYSBACKUP` privilege on the source database `prod_source`.

```
$ RMAN
RMAN> CONNECT TARGET "sbu@prod_source AS SYSBACKUP";
```

Enter the password for the `sbu` user when prompted.

Note:

To perform cross-platform transport of an encrypted tablespace, you must connect to the PDB as a common user with the `SYSDBA` or `SYSBACKUP` privilege.

3. Query the name of the destination platform in `V$TRANSPORTABLE_PLATFORM`.
-
-

See Also:

["Platforms that Support Cross-Platform Data Transport"](#) (page 28-3) for information about determining the platform name

4. Place the tablespaces to be transported in read-only mode.

The following command places the tablespace `EXAMPLE` in read-only mode.

```
ALTER TABLESPACE example READ ONLY;
```

5. Choose a method for naming the output files.

Use the `FORMAT` clause of the `BACKUP` command to specify a pattern for naming the output files.

See Also:

["About Names and Locations for Restored Objects on the Destination Database \(page 28-25\)"](#)

6. If the tablespace being transported is a TDE-encrypted tablespace, then specify the passphrase that will be used to wrap the master key before storing it in the backupset.

The following command sets the passphrase to `encr_temp`.

```
RMAN> SET PASSPHRASE ON IDENTIFIED BY encr_temp;
```

7. Back up the tablespace on the source database using the `BACKUP` command with the `TO PLATFORM` or `FOR TRANSPORT` clause. Use the `DATAPUMP` clause to indicate that an [export dump file](#) for the tablespaces must be created. The export dump file is created in its own backup piece.

The following example creates a [cross-platform backup](#) of the tablespaces `projects` and `tasks` that can be restored on the Solaris[tm] OE (64-bit) platform. This backup is stored in the backup set `trans_ts.bck` in the `/tmp/xplat_backups` directory. The Data Pump export dump file containing metadata required to plug the tablespaces in to the [destination database](#) is stored in `trans_ts_dmp.bck` in the `/tmp/xplat_backups` directory.

```
RMAN > BACKUP
      TO PLATFORM 'Solaris[tm] OE (64-bit)'
      FORMAT '/tmp/xplat_backups/trans_ts.bck'
      DATAPUMP FORMAT '/tmp/xplat_backups/trans_ts_dmp.bck'
      TABLESPACE projects, tasks;
```

Because the `TO PLATFORM` clause is used, conversion to the endian format of the destination database is performed on the source database.

Note:

When you use the `DATAPUMP` clause, ensure that the target database is open.

8. Disconnect from the source database.
9. Move the backup sets created by the `BACKUP` command and the Data Pump export dump file to the destination host.

You can use operating system utilities to move the backup sets from the source host to the destination host.

10. Connect to the destination database, into which the tablespaces must be transported, as TARGET.

In this example, `sbu` is a user who is granted the `SYSDUMP` privilege on the destination database `prod_dest`.

```
% RMAN
RMAN> CONNECT TARGET "sbu@prod_dest AS SYSBACKUP";
```

Enter the password for the `sbu` user when prompted.

11. If the tablespace being transported is a TDE-encrypted tablespace, then provide the passphrase that was used on the source database to wrap the master key.

The following example sets the passphrase to `encr_temp`.

```
SET PASSPHRASE ON IDENTIFIED BY encr_temp;
```

12. Restore the backup sets that were transported from the source database using the `RESTORE` command. Use the `DUMP FILE` clause to import the export dump file containing the tablespace metadata and plug the tablespaces in to the destination database.

The following example restores the `projects` and `tasks` tablespaces from the cross-platform backup created in Step 7 (page 28-31). The backup set `trans_ts.bck` in the `/tmp/xplat_restores` directory on the destination host. The Data Pump export dump file containing the metadata that is required to plug these tablespaces in to the destination database is stored in the `trans_ts_dump.bck` in the `/tmp/xplat_restores` directory.

```
RMAN> RESTORE
      FOREIGN TABLESPACE projects, tasks TO NEW
      FROM BACKUPSET '/tmp/xplat_restores/trans_ts.bck'
      DUMP FILE FROM BACKUPSET '/tmp/xplat_restores/trans_ts_dmp.bck';
```

See Also:

Oracle Database Backup and Recovery Reference for additional examples on performing cross-platform backup and restore operations

28.9 Overview of Cross-Platform Transport of Tablespaces Using Inconsistent Backups

RMAN enables you to transport inconsistent tablespace backups across platforms. An inconsistent tablespace backup is a backup of one or more tablespaces that is created when the tablespaces are in read/write mode. The term inconsistent refers to the fact that data files in the backup contain changes that were made after the files were checkpointed. The [foreign data files](#) produced during a cross-platform inconsistent backup operation cannot be directly plugged in to the [destination database](#). They must be made consistent before they can be opened on the destination database. You make the foreign data files consistent by applying a cross-platform incremental backup, created when the tablespaces are placed in read-only mode, to these foreign data files. This backup must also include the export dump file containing the metadata required to plug the transported tablespaces in to the destination database.

Inconsistent tablespace backups enable you to reduce application downtime. When the tablespaces are online and available to the users, you create cross-platform inconsistent backups on the source database. The first backup must be a level 0 incremental backup. Subsequently, create smaller level 1 incremental backups that contain the changes made to the tablespaces since the most recent level 1 backup. These level 0 and level 1 incremental backups can be restored and applied on the destination database even as other level 1 incremental backups are being created on the source database. You need not wait until all the level 1 incremental backups are created on the source database before you start applying previously-created level 1 backups on the destination database. Since the tablespaces are still online while these incremental backups are being created, there is no application downtime at this stage. The final level 1 incremental backup is created with the tablespaces placed in read-only mode. The application downtime begins at this stage. This final backup must include the metadata required to plug the tablespaces in to the destination database.

On the destination database, you first restore the level 0 incremental backup to create a set of foreign data files. Next, apply the level 1 incremental backups that were created when the tablespaces were in read/write mode to these restored foreign data files. Apply these backups in the same order in which they were created. In most cases, the destination database catches up with the last level 1 incremental backup before the final incremental backup, taken with the tablespaces placed in read-only mode, is created on the source database. The last step is to restore the final level 1 incremental backup, created when the tablespaces were placed in read-only mode, to make the foreign data files consistent. This backup contains the tablespace metadata required to plug the tablespaces in to the destination database.

See Also:

["Performing Cross-Platform Transport of Tablespaces Using Inconsistent Backups \(page 28-33\)"](#)

28.10 Performing Cross-Platform Transport of Tablespaces Using Inconsistent Backups

You can transport inconsistent tablespaces across platforms using backup sets or image copies. Use the `BACKUP` command to create a [cross-platform backup](#) using backup sets. The `CONVERT` command creates cross-platform backups using image copies.

This section describes how to transport inconsistent tablespaces from one platform to another. An example of transporting an inconsistent tablespace across platforms using backup sets is included.

See Also:

For more information about using scripts to perform cross-platform transport using backup sets, refer to the My Oracle Support Note 1389592.1 at <https://support.oracle.com/rs?type=doc&id=1389592.1>

See Also:

- ["Overview of Cross-Platform Transport of Tablespaces Using Inconsistent Backups \(page 28-32\)"](#)
 - [Steps to Transport Inconsistent Tablespaces to a Different Platform \(page 28-35\)](#)
-
-

About Creating Inconsistent and Incremental Backups on the Source Database

Use the `ALLOW INCONSISTENT` clause in a `BACKUP` or `CONVERT` command to create a cross-platform inconsistent backup of one or more tablespaces. The tablespaces being transported are in read/write mode when an inconsistent backup is created. To create incremental backups, use the `INCREMENTAL LEVEL 1` clause in the `BACKUP` command.

The first inconsistent backup is a level 0 incremental backup. Subsequently, you can create multiple cross-platform level 1 incremental backups. The final cross-platform incremental backup must be a consistent backup that is created when the tablespaces are read-only. When you create this final incremental backup, use the `DUMP FILE` clause in the `BACKUP` command to create the dump file containing the tablespace metadata.

When you use the `CONVERT` command, you must explicitly create the [export dump file](#) that contains the metadata for the tablespaces by using the Data Pump Export utility.

Note:

The `ALLOW INCONSISTENT` clause cannot be used for cross-platform whole database backups.

See Also:

["Steps to Transport Inconsistent Tablespaces to a Different Platform \(page 28-35\)"](#) for information about specifying the SCN

About Restoring and Recovering Inconsistent Backups on the Destination Database

You first restore the cross-platform level 0 incremental backup, taken when the tablespaces are placed in read/write mode, on the [destination database](#). This operation creates restores the backup and creates foreign data file copies. These foreign data files are inconsistent because the tablespaces were not placed in read-only mode when the backup was created. To make these foreign data files consistent and achieve a consistent checkpointed SCN, apply the incremental backups in the order in which they were created. The final incremental backup applied must be a cross-platform incremental backup that was created when the tablespaces were in read-only mode. Next, to plug the tablespaces in to the destination database, you restore and import the dump file that contains the metadata of the tablespaces being transported.

Requirements for Applying Cross-Platform Incremental Backups to the Restored Data Files

To successfully apply a cross-platform incremental tablespace backup to a set of restored foreign data files, the following conditions must be satisfied:

- For each data file that is included in the cross-platform incremental backup, the start SCN must be lower than the current checkpoint SCN of the foreign data file copy.
- The foreign data file copies created by the restore operation must not be modified. For example, if a foreign data file copy has been plugged in to the [destination database](#), made read/write, and then made read-only, then RMAN considers that this file has been modified.

28.10.1 Steps to Transport Inconsistent Tablespaces to a Different Platform

This section describes the high-level steps to perform cross-platform transport of inconsistent tablespaces using backup sets or image copies.

The prerequisites for transporting inconsistent tablespaces using backup sets are described in "[Prerequisites for Performing Cross-Platform Tablespace Transport Using Backup Sets](#) (page 28-29)". The prerequisites for transporting inconsistent tablespaces using image copies (CONVERT command) are described in *Oracle Database Backup and Recovery Reference*.

Perform the following tasks to transport inconsistent tablespaces to a different platform:

1. Create the files required to transport one more tablespaces in the source database as described in [Creating Files Required to Transport Tablespaces to a Different Platform](#) (page 28-35)
2. Transfer files from the source host to the destination host as described in [Transferring Files Created on the Source Host to the Destination Host](#) (page 28-36).
3. Restore tablespaces and plug them into the destination database as described in [Restoring Tablespaces and Plugging them in to the Destination Database](#) (page 28-36).

28.10.1.1 Creating Files Required to Transport Tablespaces to a Different Platform

This step consists of performing the following tasks in the [source database](#):

1. If the tablespace being transported is a TDE-encrypted tablespace, then specify the passphrase that will be used to wrap the master key before storing it in the backupset.

The following command sets the passphrase to `encr_temp`.

```
RMAN> SET PASSPHRASE ON IDENTIFIED BY encr_temp;
```

2. Create a cross-platform level 0 inconsistent backup of the tablespaces that must be transported to a different platform. The tablespaces are in read/write mode.

Use the `ALLOW INCONSISTENT` and `INCREMENTAL LEVEL 0` clauses in the `BACKUP` command to indicate that the backup is an inconsistent backup of one or more tablespaces.

3. Create a cross-platform level 1 incremental backup of the tablespaces that must be transported to another platform. The tablespaces are in read/write mode.

Subsequent to the first level 0 inconsistent backup, you can create any number of level 1 incremental backups when the tablespaces are in read/write mode. Use the `ALLOW INCONSISTENT` and `INCREMENTAL LEVEL 1` clause to create these incremental backups. Performing frequent incremental backups when the tablespaces are in read/write mode is advantageous because this reduces the amount of changed data that needs to be applied to the [destination database](#) using the final incremental backup that is taken when the tablespace is read-only.

4. Create a cross-platform level 1 incremental backup of the tablespaces with the tablespaces in read-only mode.

This is the final incremental backup and it must include the dump file that contains the metadata required to plug the transported tablespaces in to the destination database. Use the `INCREMENTAL LEVEL 1` clause in the `BACKUP` command to create a level 1 incremental backup.

When you perform cross-platform transport using the `BACKUP` command, use the `DATAPUMP` clause to create the Data Pump export dump files along with the incremental backup. The dump file is created in a separate backup set. When you create cross-platform incremental backups using image copies, you must explicitly create the dump file containing tablespace metadata by using the Data Pump Export utility.

28.10.1.2 Transferring Files Created on the Source Host to the Destination Host

Use FTP, an operating system copy command, or some other mechanism to move the backup sets, data files, and the dump file that were created in the [source database](#) to the destination host.

28.10.1.3 Restoring Tablespaces and Plugging them in to the Destination Database

This step consists of performing the following tasks on the [destination database](#):

1. If the tablespace being transported is a TDE-encrypted tablespace, then provide the passphrase that was used on the source database to wrap the master key.

The following example sets the passphrase to `encr_temp`.

```
SET PASSPHRASE ON IDENTIFIED BY encr_temp;
```

2. Restore the cross-platform level 0 inconsistent backup.

This restore operation creates a set of [foreign data files](#) on the destination database. These foreign data files are inconsistent, and they need recovery before they can be plugged in to the destination database.

Use the `RESTORE` command to restore the cross-platform level 0 inconsistent backup. When you restore a cross-platform inconsistent backups that consist of backup sets, use the `FROM BACKUPSET` clause to specify the name of the backup set that contains the level 0 inconsistent backup.

See Also:

Oracle Database Backup and Recovery Reference for information about using the `RESTORE` command for cross-platform restore operations

3. Apply the cross-platform level 1 incremental backup, taken when the tablespaces were in read/write mode, to the foreign data files restored in Step 1.

If you created multiple cross-platform level 1 incremental backups, these incremental backups must be applied in the order in which they were created. Use the `RECOVER` command to apply the incremental backups. The `FOREIGN DATAFILECOPY` clause of the `RECOVER` command must list each data file to which the incremental backup must be applied. Use the `FROM BACKUPSET` clause to specify the name of the backup set that contains the data to be recovered.

4. Apply the cross-platform level 1 incremental backup, taken when the tablespaces were in read-only mode, to the foreign data files restored in Step 1.

Use the `RECOVER` command to apply the incremental backup. The `FOREIGN DATAFILECOPY` clause of the `RECOVER` command must list each data file to which the incremental backup needs to be applied. Use the `FROM BACKUPSET` clause to specify the name of the backup set that contains the data to be recovered.

5. Restore the backup set containing the tablespace metadata.

Use the `RESTORE` command to restore the backup set that contains the dump file created during the cross-platform incremental backup. The tablespaces were in read-only mode when this backup was created. You can optionally use the `DUMP FILE` clause to specify a name for the dump file on the destination database and the `DATA PUMP DESTINATION` clause to specify the directory in which the dump file is restored. If these clauses are omitted, `RMAN` uses the configured defaults. When transporting data using backup sets, use the `FROM BACKUPSET` clause to specify the name of the backup set that contains the dump file.

6. Import the dump file containing the tablespace metadata into the destination database.

Plug the recovered tablespaces in to the destination database by using the Data Pump Import utility to import the dump file created during the incremental backup. You must run the Data Pump Import utility as a user with the `SYSDBA` privilege.

28.10.2 Example: Performing Cross-Platform Inconsistent Tablespace Transport Using Backup Sets

This example transports the inconsistent tablespace `my_tbs` from the [source database](#), which is on the Sun Solaris platform, to a [destination database](#) on the Linux x86 64-bit platform.

See Also:

["Steps to Transport Inconsistent Tablespaces to a Different Platform \(page 28-35\)"](#) for conceptual information about each step in this example

The following steps enable you to transport the inconsistent tablespace `my_tbs` across platforms using backup sets:

1. Connect to the source database as a user who is granted the `SYSBACKUP` privilege.

```
RMAN> CONNECT TARGET "sbu@prod_source AS SYSBACKUP";
```

2. Ensure that the prerequisites required to transport tablespaces to another platform are met.

See Also:

["Prerequisites for Performing Cross-Platform Tablespace Transport Using Backup Sets \(page 28-29\)"](#)

3. Create a cross-platform level 0 inconsistent backup of the tablespace `my_tbs` when the tablespace is read/write mode. This backup is stored in a backup set named `my_tbs_incon.bck` in the directory `/tmp/xplat_backups`.

```
BACKUP
FOR TRANSPORT
ALLOW INCONSISTENT
INCREMENTAL LEVEL 0
TABLESPACE my_tbs FORMAT '/tmp/xplat_backups/my_tbs_incon.bck';
```

Because `FOR TRANSPORT` is used instead of `TO PLATFORM`, this cross-platform backup can be restored on any platform. The conversion will be performed on the destination database.

4. Create a cross-platform level 1 incremental backup of the tablespace `my_tbs` that contains the changes made after backup in Step 3 was created. The tablespace is still in read/write mode. This incremental backup is stored in `my_tbs_incon1.bck` in the directory `/tmp/xplat_backups`.

```
BACKUP
FOR TRANSPORT
ALLOW INCONSISTENT
INCREMENTAL LEVEL 1
TABLESPACE my_tbs FORMAT '/tmp/xplat_backups/my_tbs_incon1.bck';
```

To minimize application downtime, the level 0 and level 1 incremental backups created in Steps 3 and 4 can be restored and applied on the destination database while the source tablespace is still in read/write mode. When the destination database catches up with last level 1 incremental backup, you can create the final incremental backup with the tablespace placed in read-only mode.

5. Place the tablespace `my_tbs` in read-only mode.

```
ALTER TABLESPACE my_tbs READ ONLY;
```

6. Create the final cross-platform level 1 incremental backup of the tablespace `my_tbs`. This backup contains changes made to the database after the backup that was created in Step 4. It must include the [export dump file](#) that contains the tablespace metadata.

```
BACKUP
FOR TRANSPORT
INCREMENTAL LEVEL 1
TABLESPACE my_tbs
FORMAT '/tmp/xplat_backups/my_tbs_incr.bck'
DATAPUMP FORMAT '/tmp/xplat_backups/my_tbs_incr_dp.bck';
```

The incremental backup is stored in `my_tbs_incr.bck`. The export dump file containing the tablespace metadata is stored in a backup set named `my_tbs_incr_dp.bck`.

The following is a formatted output of the BACKUP command that was run in this step. The output is edited to display only the relevant information. Observe that the dump file is called `backup_tts_RDBMS_13462.dmp`, which is a name assigned by the operating system, and is stored in the directory specified by the DESTINATION clause.

```
Starting backup at 12-SEP-12
.....
Performing export of metadata for specified tablespaces...
EXPDP> Starting "SYS"."TRANSPORT_EXP_RDBMS_zocc":
.....
EXPDP>
*****
EXPDP> Dump file set for SYS.TRANSPORT_EXP_RDBMS_zocc is:
EXPDP> /ade/b/191802369/oracle/backup_tts_RDBMS_13462.dmp
EXPDP>
*****
.....
Export completed
.....
.....
channel ORA_DISK_1: specifying datafile(s) in backup set
input datafile file number=00006 name=/ade/b/191802369/oracle/dbs/tbs_11.f
input datafile file number=00007 name=/ade/b/191802369/oracle/dbs/tbs_12.f
input datafile file number=00020 name=/ade/b/191802369/oracle/dbs/tbs_14.f
input datafile file number=00010 name=/ade/b/191802369/oracle/dbs/tbs_13.f
.....
.....
Finished backup at 12-SEP-12
```

7. Move the backup sets and the export dump file generated in Steps 3, 4, and 6 from the source host to the desired directories on the destination host.

In this example, all the required files are moved to the directory `/tmp/xplat_restores` on the destination host.

8. Connect to the destination database as a user who is granted the SYSBACKUP privilege.

```
RMAN> CONNECT TARGET "sbu@prod_dest AS SYSBACKUP";
```

`sbu` is a user who is granted the SYSBACKUP privilege in the destination database.

9. Restore the cross-platform level 0 inconsistent backup created in Step 3.

Use the FOREIGN DATAFILE clause to specify the data files that must be restored. The FROM PLATFORM clause specifies the name of the platform on which the backup was created. This clause is required to convert backups on the destination database.

In this example, the data files with numbers 6, 7, 20, and 10 are restored to the names specified in the FORMAT clause corresponding to that data file. The data file numbers must be the numbers used on the source database. You can obtain the data file numbers from the RMAN output of the inconsistent backup created in Step 3.

```
RESTORE
FROM PLATFORM 'Solaris[tm] OE (64-bit)'
FOREIGN DATAFILE 6
FORMAT '/tmp/aux/mytbs_6.df',
7
```

```

FORMAT '/tmp/aux/mytbs_7.df',
20
FORMAT '/tmp/aux/mytbs_20.df',
10
FORMAT '/tmp/aux/mytbs_10.df'
FROM BACKUPSET '/tmp/xplat_restores/my_tbs_incon.bck';

```

- 10.** Recover the [foreign data files](#) obtained in Step 9 by applying the first cross-platform level 1 incremental backup that was created Step 4.

```

RECOVER
FROM PLATFORM 'Solaris[tm] OE (64-bit)'
FOREIGN DATAFILECOPY '/tmp/aux/mytbs_6.df', '/tmp/aux/mytbs_7.df', '/tmp/aux/
mytbs_20.df', '/tmp/aux/mytbs_10.df'
FROM BACKUPSET '/tmp/xplat_restores/my_tbs_incon1.bck';

```

In this example, the incremental backup that is being applied to the restored foreign data files is stored in `/tmp/xplat_restores/my_tbs_incon1.bck`.

- 11.** Recover the foreign data files obtained in Step 9 by applying the final cross-platform level 1 incremental backup that was created in Step 6. This backup was created with the tablespaces in read-only mode.

```

RECOVER
FROM PLATFORM 'Solaris[tm] OE (64-bit)'
FOREIGN DATAFILECOPY '/tmp/aux/mytbs_6.df', '/tmp/aux/mytbs_7.df', '/tmp/aux/
mytbs_20.df', '/tmp/aux/mytbs_10.df'
FROM BACKUPSET '/tmp/xplat_restores/my_tbs_incr.bck';

```

In this example, the incremental backup that is being applied to the restored foreign data files is stored in `/tmp/xplat_restores/my_tbs_incr.bck`.

- 12.** Restore the backup set containing the export dump file. This dump file contains the tablespace metadata required to plug the tablespaces into the destination database.

```

RESTORE
FROM PLATFORM 'Solaris[tm] OE (64-bit)'
DUMP FILE 'my_tbs_restore_md.dmp'
DATAPUMP DESTINATION '/tmp/dump'
FROM BACKUPSET '/tmp/xplat_restores/my_tbs_incr_dp.bck';

```

In this example, the dump file is restored to a file called `my_tbs_restore_md.dmp` in the directory `/tmp/dump`. You can omit the name of the dump file and the `DATAPUMP DESTINATION` clause and allow RMAN to use operating-system defaults for these parameters.

- 13.** Plug the tablespace in to the destination database. Use the Data Pump import utility to import the dump file containing the tablespace metadata in to the destination database.

```

# impdp directory=dp_dir dumpfile=backup_tts_RDBMS_13462.dmp
transport_datafiles='/tmp/aux/mytbs_6.df', '/tmp/aux/mytbs_7.df', '/tmp/aux/
mytbs_20.df', '/tmp/aux/mytbs_10.df' nologfile=Y

```

When prompted for a user name and password, enter the credentials of the `SYS` user. In this example, `dp_dir` is a directory object that was created using `CREATE DIRECTORY` command and is mapped to the `/tmp` directory.

28.11 Performing Cross-Platform Transport of Data Files Over the Network

RMAN enables you to perform cross-platform transport of data files over the network.

RMAN can connect to a source database, create the required data file backups in the backupset format, transfer them to the destination, and then restore the backups on the destination database. This task is performed by using the `FROM SERVICE` clause along with the `RESTORE FOREIGN DATAFILE` command.

You need to establish connectivity between the source database and the target database by adding the required entries to the `tnsnames.ora` and `listener.ora` files. The `COMPATIBLE` initialization parameter of the source and destination databases must be set to 12.2.

1. Open RMAN and connect `AS TARGET` to the target database (on which the data file must be restored) as a user with the `SYSDBA` or `SYSBACKUP` privilege
2. Restore the required data files by using the corresponding data files on the source database.

The `FROM SERVICE` clause specifies the service name of the source database from which the data files must be restored.

The following statement restores the data files 21 and 22 using data files from a source database with service name `source_db`. The `TO NEW` clause indicates that the data files restored for the specified tablespace must use new names that are different from those on the source database.

```
RESTORE
FOREIGN DATAFILE 21,22 TO NEW
FROM SERVICE 'source_db';
```

3. Recover the foreign data files that were restored in Step 2.

The `FROM SERVICE` clauses specifies the service name of the source database.

The following statement recovers the foreign data files specified by the `FOREIGN DATAFILECOPY` clause using data files in the source database whose service name is `source_db`.

```
RECOVER
FOREIGN DATAFILECOPY '/u01/oracle/oradata/db1_tbs21.dbf', '/u01/oracle/oradata/
db1_tbs22.db'
FROM SERVICE 'source_db';
```

28.12 Performing Cross-Platform Data Transport in CDBs and PDBs

RMAN provides support for transporting data across platforms in a multitenant environment. You can transport a whole [multitenant container database \(CDB\)](#), the [root](#) only, or one or more pluggable databases ([PDBs](#)) across platforms. The cross-platform transport can be performed using images copies or backup sets. The information in this chapter is applicable to CDBs and PDBs with the differences described in the following sections.

This section contains the following topics:

- [About Cross-Platform Transport of PDBs](#) (page 28-42)

- [Performing Cross-Platform Transport of a Whole CDB](#) (page 28-42)
- [Performing Cross-Platform Transport of a Closed PDB](#) (page 28-43)
- [Performing Cross-Platform Transport of a PDB Using Inconsistent Backups](#) (page 28-45)
- [Performing Cross-Platform Transport of Tablespaces in a PDB](#) (page 28-47)

28.12.1 About Cross-Platform Transport of PDBs

To transport an entire PDB to a different platform, the source platform and destination platform must use the same endian format. The `COMPATIBLE` parameter on the source and destination CDB must be set to 12.1 or higher.

Use one of the following techniques to transport PDBs across platforms:

- Connect to the root and use the `BACKUP FOR TRANSPORT ... PLUGGABLE DATABASE` or `BACKUP TO PLATFORM ... PLUGGABLE DATABASE` command to create a [cross-platform backup](#) of one or more PDBs.

When you are connected to the root, the following command creates a cross-platform backup of the PDBs `hr_pdb` and `sales_pdb`. The PDBs must be read-only mode before the cross-platform backup is created.

```
BACKUP FOR TRANSPORT
PLUGGABLE DATABASE hr_pdb, sales_pdb FORMAT '/tmp/backups/pdb_%U';
```

- Connect to the PDB and use the `BACKUP FOR TRANSPORT` or `BACKUP TO PLATFORM` commands to create backup sets that can be used to transport the PDB data to another platform.

Note:

Performing cross-platform data transport of one or more PDBs by using the `CONVERT` command is not supported.

See Also:

["Making RMAN Connections to a CDB](#) (page 4-7)"

28.12.2 Performing Cross-Platform Transport of a Whole CDB

In a CDB, the steps to transport data across platforms are similar to the ones used for non-CDBs. The only difference is that, on both the source and [destination databases](#), you must connect to the root as a [common user](#) with the common `SYSPBACKUP` or `SYSDBA` privilege.

See Also:

["Performing Cross-Platform Database Transport with Backup Sets](#) (page 28-26)"

To transport an entire CDB, the source platform and the destination platform must use the same endian format.

The `BACKUP FOR TRANSPORT` or `BACKUP TO PLATFORM` command creates a [cross-platform backup](#) of the whole CDB. The `CONVERT` command creates image copies of the CDB that can be transported to a different platform.

The following command, when connected to the root, creates a cross-platform backup of the whole CDB:

```
BACKUP
TO PLATFORM 'Linux x86 64-bit'
DATABASE FORMAT '/tmp/backups/cdb_%U;
```

While restoring the cross-platform backup on the destination database, the `RESTORE DATABASE` command restores the whole CDB.

See Also:

["Making RMAN Connections to a CDB \(page 4-7\)"](#)

28.12.3 Performing Cross-Platform Transport of a Closed PDB

Pluggable database (PDBs) can be transported and plugged in to a destination multitenant container database (CDB) which is on a different platform than the source CDB. In addition to an RMAN backup of the PDB, you need the metadata required to plug the PDB into the destination CDB.

The `COMPATIBLE` parameter on the source CDB and destination CDB must be set to 12.2. The source CDB and the destination CDB must use the same endian format.

To perform cross-platform transport of a closed PDB into a destination CDB:

1. Perform the following steps on the source CDB:
 - a. Connect to the root as a common user with the `SYSDBA` or `SYSBACKUP` privilege.
 - b. Close the PDB that needs to be transported.

The following statement closes the PDB `hr_pdb`.

```
RMAN> ALTER PLUGGABLE DATABASE hr_pdb CLOSE IMMEDIATE;
```

- c. Create a cross-platform full backup of the PDB that must be transported by using the `BACKUP PLUGGABLE DATABASE` command.

To create a cross-platform backup, include either the `FOR TRANSPORT` or `TO PLATFORM` clause.

The following example creates a cross-platform backup of the PDB `hr_pdb` for the `Linux x86 64-bit` platform. The metadata required to plug this PDB into the destination CDB is specified using the `UNPLUG INTO` clause and stored in the XML file `metadata_hrpdb.xml`.

```
BACKUP TO PLATFORM= 'Linux x86 64-bit'
UNPLUG INTO '/u01/oradata/backups/metadata_hrpdb.xml'
PLUGGABLE DATABASE hr_pdb
FORMAT '/u01/oradata/backups/transport_hrpdb.bck';
```

2. Transport the backup sets and the XML file created in Step 1c to the destination CDB.
3. Perform the following steps on the destination CDB:
 - a. Connect to the root as a common user with the `SYSDBA` or `SYSBACKUP` privilege.

- b. Ensure that the CDB is open in read-write mode.

The following command displays the current mode of the CDB.

```
RMAN> SELECT open_mode FROM V$DATABASE;
```

- c. Determine if the source PDB that is being transported is compatible with the destination CDB by using the `DBMS_PDB.CHECK_PLUG_COMPATIBILITY` procedure.

The following function determines if the source PDB `hr_pdb`, whose metadata is stored in an XML file `metadata_hrpdb.xml`, can be plugged in to the destination CDB. The function returns `TRUE` if the source PDB is compatible with the destination CDB.

```
SQL> declare
  2   c boolean;
  3   begin
  4   c:=dbms_pdb.check_plug_compatibility('/u02/backup_restore/
metadata_hrpdb.xml','HR_PDB');
  5   if (c) then dbms_output.put_line('True');
  6   else dbms_output.put_line('False');
  7   end if;
  8   end;
  9   /
```

PL/SQL procedure successfully completed.

- d. Restore the PDB backup that was created on the source CDB.

The `USING` clause specifies the name of the XML file that contains the metadata required to plug the source PDB into the destination CDB. To copy data files to a different location than described in the XML file, use the `FILE_NAME_CONVERT` clause.

The following statement restores the backup of the PDB `hr_pdb` that is stored in the backupset `transport_hrpdb.bck`. The metadata for this PDB is stored in `metadata_hrpdb.xml`.

```
RESTORE
  USING '/u02/backup_restore/metadata_hrpdb.xml'
  FOREIGN PLUGGABLE DATABASE hr_pdb FORMAT '/u02/oracle/oradata/%U'
  FROM BACKUPSET '/u02/backup_restore/transport_hrpdb.bck';
```

- e. Open the restored PDB.

The following command opens the PDB `hr_pdb`.

```
RMAN> ALTER PLUGGABLE DATABASE hr_pdb OPEN;
```

Note:

If a PDB with the same name as the one being transported exists on the destination database, then the restore operation fails.

Note:

[Performing Cross-Platform Transport of a PDB Using Inconsistent Backups](#)
(page 28-45)

28.12.4 Performing Cross-Platform Transport of a PDB Using Inconsistent Backups

You can use a combination of inconsistent and consistent backups to transport a PDB and plug it into a CDB that is on a different platform. Inconsistent backups enable you to reduce application downtime because the PDB can be open while the backup is performed.

When the PDB is open, you create cross-platform inconsistent backups. The first backup is an incremental level 0 backup. Subsequent backups are incremental level 1 backups that contain changes made to the PDB since the last incremental backup. There is no restriction on the number of inconsistent level 1 backups. Finally, close the PDB, create the last consistent incremental level 1 backup and the XML file containing the metadata required to plug the source PDB into a destination CDB.

The `COMPATIBLE` parameter on the source CDB and destination CDB must be set to 12.2. The source CDB and the destination CDB must use the same endian format.

1. Perform the following steps on the source CDB:

- a. Connect to the root as a common user with the `SYSDBA` or `SYSBACKUP` privilege.
- b. Ensure that the PDB that must be transported is in read-write mode.
- c. Note the database SCN before a level 0 backup is created.

```
SELECT CHECKPOINT_CHANGE# FROM V$DATABASE;
```

- d. Create a cross-platform incremental level 0 backup of the PDB that must be transported by using the `BACKUP . . . PLUGGABLE DATABASE` command.

Use either the `FOR TRANSPORT` or `TO PLATFORM` clause to specify a cross-platform backup. Include the `ALLOW INCONSISTENT` clause to indicate that the PDB is not in a consistent state.

The following statement creates a cross-platform incremental level 0 backup of the PDB `hr_pdb`.

```
BACKUP INCREMENTAL LEVEL 0
FOR TRANSPORT
ALLOW INCONSISTENT
PLUGGABLE DATABASE hr_pdb FORMAT '/u01/backups/hr_pdb_level0.bck';
```

Because the PDB is in read-write mode, an inconsistent backup is created.

- e. Close the PDB being transported.

The following command closes the PDB `hr_pdb`.

```
RMAN> ALTER PLUGGABLE DATABASE hr_pdb CLOSE IMMEDIATE;
```

- f. Create a consistent cross-platform incremental backup. The point-in-time for the incremental backup must be from the SCN noted in Step 1c.

Include the `UNPLUG INTO` clause to specify the name of the XML that stores the metadata required to plug this PDB into the destination CDB.

The following statement creates a cross-platform incremental backup of the PDB `hr_pdb`. This is a consistent PDB backup.

```
BACKUP INCREMENTAL FROM SCN 36462
FOR TRANSPORT
UNPLUG INTO '/u01/backups/metadata_hr_pdb.xml'
PLUGGABLE DATABASE hr_pdb FORMAT '/u01/backups/hr_pdb_level1_con.bck';
```

2. Transport all the PDB backups and the XML file containing the PDB metadata to the destination database.

Note:

Typically, you would transport the inconsistent backups as they are created and then restore them on the destination CDB.

3. Perform the following steps on the destination CDB:

- a. Connect to the root as a common user with the `SYSDBA` or `SYSBACKUP` privilege.
- b. Ensure that the destination CDB is open in read-write mode.
- c. Restore the cross-platform inconsistent level 0 backup of the PDB that was created on the source CDB.

This restore operation creates a set of foreign data files that correspond to the source PDB in the destination CDB.

The following statement restores the cross-platform level 0 backup of the PDB `hr_pdb` that is stored in the backupset `hr_pdb_level0.bck`.

```
RESTORE
FOREIGN PLUGGABLE DATABASE hr_pdb FORMAT '/u02/oradata/%U'
FROM BACKUPSET '/u02/backup_restore/hr_pdb_level0.bck';
```

- d. Apply the cross-platform level 1 incremental backup created when the source PDB was closed to the data files restored in Step 3c. Use the XML file containing the source PDB metadata to plug the PDB into the destination CDB.

The following command recovers the foreign data files by using the incremental level 1 backup `hr_pdb_level1_con.bck`. There are two restored foreign data files specified using the `FOREIGN DATAFILECOPY` clause. The `USING` clause specifies the XML file that contains metadata required to plug the PDB into the destination CDB.

```
RECOVER
USING '/u02/backup_restore/metadata_hr_pdb.xml'
FOREIGN DATAFILECOPY '/u2/oradata/09qurbdp_1_1', '/u2/oradata/03bcdqrv_2_5'
FROM BACKUPSET '/u02/backup_restore/hr_pdb_level1_con.bck';
```

- e. Determine the name of the transported PDB in the destination CDB.

The source PDB is plugged in to the destination using a different name. Typically, the name is the unique name of the CDB followed by a randomly-generated number.

The following command displays the list of PDBs.

```
SELECT name FROM V$PDBS;
```

- f. Open the recovered PDB.

The following statement opens the PDB `mycdb_72346`.

```
RMAN> ALTER PLUGGABLE DATABASE mycdb_72346 OPEN;
```

Note:

If a PDB with the same name as the one being transported exists on the destination database, then the restore operation fails.

Note:

[Performing Cross-Platform Transport of a Closed PDB](#) (page 28-43)

28.12.5 Performing Cross-Platform Transport of Tablespaces in a PDB

RMAN enables you to transport user tablespaces contained in a PDB to a different platform by using either the `CONVERT` or `BACKUP` command. In this case, the source platform and the destination platform can use different endian formats.

Use one of the following techniques to transport a tablespace in a PDB:

- Connect to the PDB as `TARGET` and use the `BACKUP TABLESPACE` command to create a cross-platform backup of the selected tablespaces.

See "[Steps to Transport Read-Only Tablespaces to a Different Platform Using Backup Sets](#) (page 28-30)".

- Connect to the PDB as `TARGET` and use the `CONVERT TABLESPACE` command to transport a read-only tablespace.

The following command, when connected to the PDB, converts the read-only tablespace `my_tbs`:

```
CONVERT TABLESPACE my_tbs
  TO PLATFORM 'Solaris[tm] OE (64-bit)'
  FORMAT '/tmp/xplat_backups/my_tbs_%U.bck';
```

- Connect to the PDB as `TARGET` and use the `CONVERT DATAFILE` command.

The following command, when connected to the PDB, converts the data file `sales.df`:

```
CONVERT
  FROM PLATFORM 'Solaris[tm] OE (64-bit)'
  DATAFILE '/u01/app/oracle/oradata/orcl/sales.df'
  FORMAT '/tmp/xplat_backups/sales_df_solaris.dat'
```

However, when connected as `TARGET` to a PDB, you cannot use the `CONVERT DATAFILE` command to convert a tablespace that contains undo segments.

See Also:

[Example: Transporting a Tablespace in a PDB](#) (page 28-48)

28.12.5.1 Example: Transporting a Tablespace in a PDB

This example used the `CONVERT` command to transport the tablespace `sales_tbs` from the PDB `pdb5` to the destination PDB `pdb3`. The source PDB is on a Sun Solaris platform and the destination PDB is on a Linux x86 64-bit platform.

1. Ensure that the required prerequisites are met.

See Also:

- ["Prerequisites for Performing Cross-Platform Tablespace Transport Using Backup Sets](#) (page 28-29)"
 - *Oracle Database Backup and Recovery Reference* for the `CONVERT` command prerequisites
-

2. Start `SQL*Plus` and connect to the source PDB as a user who is granted the `SYSDBA` or `SYSBACKUP` privilege.

In this example, `sbu` is a user who has been granted the `SYSBACKUP` privilege on the source PDB `pdb5`.

```
% sqlplus sbu@pdb5 AS SYSBACKUP
```

3. Query the name for the destination platform in the `V$TRANSPORTABLE_PLATFORM` view.

In this example, the platform name for the destination platform is `Linux x86 64-bit`.

4. Verify that the tablespace that is to be transported is self-contained.

See Also:

Oracle Database Administrator's Guide for information about determining whether tablespaces are self-contained

5. Place the tablespace to be transported in read-only mode.

```
SQL> ALTER TABLESPACE sales_tbs READ ONLY;
```

6. Create the directory object that is used to store the files generated by the `DataPump` export and import utilities.

```
SQL> CREATE OR REPLACE DIRECTORY xtt_dir AS '/scratch/xtt';  
Directory created.
```

7. Start `RMAN` and connect to the source PDB as a user with the `SYSDBA` or `SYSBACKUP` privilege.

The following example starts RMAN and connects to the source PDB `pdb5` as the `sbu` user who has been granted the `SYSDBA` privilege.

```
% rman
RMAN> CONNECT TARGET "sbu@pdb5 as sysbackup"
```

8. Convert the tablespace on the source database using the `CONVERT` command.

The following command converts the tablespace `sales_tbs` to the destination platform Linux x86-64 bit. The converted data files are stored in `/tmp/xplat_convert/sales_tbs_conv.bck`.

```
RMAN> CONVERT TABLESPACE 'SALES_TBS'
TO PLATFORM 'Linux x86 64-bit'
FORMAT '/tmp/xplat_convert/sales_tbs_conv.bck';
```

9. Exit RMAN.

10. On the source database, use the DataPump export utility to create an export dump file containing the metadata for tablespace `sales_tbs`. Use the credentials of the `SYS` user to perform the export.

The following command creates an export dump file called `sales_tbs_conv.dmp` in the location specified by the directory object `xtt_dir`. The credentials used to perform the export are that of the `SYS` user.

```
# expdp "'sys@pdb5 as sysdba'" directory=xtt_dir dumpfile=sales_tbs_conv.dmp
logfile=sales_tbs_conv.log transport_tablespaces=sales_tbs
```

11. Copy the converted data files created in Step 8 (page 28-49) and the export dump file created in Step 10 (page 28-49) to the destination PDB. You can use operating system commands to copy the files.

12. On the destination PDB, plug the tablespace into the PDB by using the DataPump import utility. Use the credentials of the `SYS` user to perform the import.

The following example imports the metadata contained in the export dump file `sales_tbs_conv.dmp` and the converted data files in `/tmp/xplat_convert/sales_tbs_conv.bck` into the PDB `pdb3`.

```
# impdp "'sys@pdb3 as sysdba'" directory=xtt_dir dumpfile=sales_tbs_conv.dmp
datafiles=/tmp/xplat_convert/sales_tbs_conv.bck
```

13. Start SQL*Plus and connect to the destination PDB as a user with the `SYSDBA` or `SYSDBA` privilege.

The following command connects to the PDB `pdb3` as the `sbu` user who has been granted the `SYSDBA` privilege.

```
%sqlplus sbu@pdb3 as sysbackup
```

14. Verify the status of the converted tablespace on the destination PDB.

The following query determines the status of the tablespace `sales_tbs`.

```
SQL> SELECT status FROM dba_tablespaces
WHERE tablespace_name LIKE 'SALES_TBS';
```

```
STATUS
-----
READ ONLY
```

15. Make the tablespace `sales_tbs` in the destination PDB `pdb3` online.

```
SQL> ALTER TABLESPACE sales_tbs READ WRITE;
```

Part VIII

Performing User-Managed Backup and Recovery

The following chapters describe how to perform backup and recovery when using a user-managed backup and recovery strategy, that is, one that does not depend upon RMAN. This part of the book contains these chapters:

- [Making User-Managed Database Backups](#) (page 29-1)
- [Performing User-Managed Database Flashback and Recovery](#) (page 30-1)
- [Performing User-Managed Recovery: Advanced Scenarios](#) (page 31-1)

Making User-Managed Database Backups

This chapter describes methods of backing up an Oracle database in a user-managed backup and recovery strategy, that is, a strategy that does not depend on using Recovery Manager (RMAN).

This chapter contains the following topics:

- [Querying V\\$ Views to Obtain Backup Information](#) (page 29-1)
- [Making User-Managed Backups of the Whole Database](#) (page 29-3)
- [Making User-Managed Backups of CDBs and PDBs](#) (page 29-4)
- [Making User-Managed Backups of Tablespaces and Data Files](#) (page 29-5)
- [Making User-Managed Backups of Tablespaces in CDBs](#) (page 29-13)
- [Making User-Managed Backups of the Control File](#) (page 29-14)
- [Making User-Managed Backups of Archived Redo Logs](#) (page 29-15)
- [Making User-Managed Backups in SUSPEND Mode](#) (page 29-16)
- [Making User-Managed Backups to Raw Devices](#) (page 29-18)
- [Making Backups with Third-Party Snapshot Technologies](#) (page 29-22)
- [Verifying User-Managed Data File Backups](#) (page 29-23)

29.1 Querying V\$ Views to Obtain Backup Information

Before making a backup, you must identify all the files in your database and decide what to back up. You can use V\$ views to obtain this information.

This section contains the following topics:

- [Listing Database Files Before a Backup](#) (page 29-1)
- [Determining Data File Status for Online Tablespace Backups](#) (page 29-2)

29.1.1 Listing Database Files Before a Backup

Use the V\$DATAFILE and V\$CONTROLFILE views to identify the data files and control files for your database. This same procedure works whether you named these files manually or allowed Oracle Managed Files to name them.

Caution:

Never back up online redo log files.

To list data files and control files:

1. Start SQL*Plus and query V\$DATAFILE to obtain a list of data files. For example, enter:

```
SELECT NAME FROM V$DATAFILE;
```

You can also join the V\$TABLESPACE and V\$DATAFILE views to obtain a listing of data files along with their associated tablespaces:

```
SELECT  t.NAME "Tablespace", f.NAME "Data File"
FROM    V$TABLESPACE t, V$DATAFILE f
WHERE   t.TS# = f.TS#
ORDER BY t.NAME;
```

2. Obtain the file names of the current control files by querying the V\$CONTROLFILE view. For example, issue the following query:

```
SELECT NAME FROM V$CONTROLFILE;
```

You only need to back up one copy of a multiplexed control file.

3. If you plan to perform control file backup with the ALTER DATABASE BACKUP CONTROLFILE TO '*filename*' statement, then save a list of all data files and online redo log files with the control file backup. Because the current database structure may not match the database structure at the time a given control file backup was created, saving a list of files recorded in the backup control file can aid the recovery procedure.

29.1.2 Determining Data File Status for Online Tablespace Backups

To check whether a data file is part of a current online tablespace backup, query the V\$BACKUP view.

This view is useful only for user-managed online tablespace backups, because neither RMAN backups nor offline tablespace backups require the data files of a tablespace to be in [backup mode](#). Some user-managed backup procedures require you to place the tablespace in backup mode to protect against the possibility of a fractured block. However, updates to the database create more than the usual amount of redo in backup mode.

The V\$BACKUP view is most useful when the database is open. It is also useful immediately after an instance failure because it shows the backup status of the files at the time of the failure. Use this information to determine whether you have left any tablespaces in backup mode.

V\$BACKUP is not useful if the control file currently in use is a restored backup or a new control file created after the media failure occurred. A restored or re-created control file does not contain the information that the database needs to populate V\$BACKUP accurately. Also, if you have restored a backup of a file, this file's STATUS in V\$BACKUP reflects the backup status of the older version of the file, not the most current version. Thus, this view can contain misleading data about restored files.

For example, the following query displays which data files are currently included in a tablespace that has been placed in backup mode:

```

SELECT t.name AS "TB_NAME", d.file# as "DF#", d.name AS "DF_NAME", b.status
FROM   V$DATAFILE d, V$TABLESPACE t, V$BACKUP b
WHERE  d.TS#=t.TS#
AND    b.FILE#=d.FILE#
AND    b.STATUS='ACTIVE';

```

The following sample output shows that the `tools` and `users` tablespaces currently have `ACTIVE` status:

TB_NAME	DF#	DF_NAME	STATUS
TOOLS	7	/oracle/oradata/trgt/tools01.dbf	ACTIVE
USERS	8	/oracle/oradata/trgt/users01.dbf	ACTIVE

In the `STATUS` column, `NOT ACTIVE` indicates that the file is not currently in backup mode (that is, you have not executed the `ALTER TABLESPACE . . . BEGIN BACKUP` or `ALTER DATABASE BEGIN BACKUP` statement), whereas `ACTIVE` indicates that the file is currently in backup mode.

29.2 Making User-Managed Backups of the Whole Database

You can make a consistent whole database backup of all files in a database after the database has been shut down with the `NORMAL`, `IMMEDIATE`, or `TRANSACTIONAL` options. A whole database backup taken while the database is open or after an instance failure or `SHUTDOWN ABORT` command is inconsistent. In such cases, the files are inconsistent with the [database checkpoint SCN](#).

You can make a whole database backup if a database is operating in either `ARCHIVELOG` or `NOARCHIVELOG` mode. If you run the database in `NOARCHIVELOG` mode, however, then the backup must be consistent; that is, you must shut down the database cleanly before the backup.

The set of backup files that results from a consistent whole database backup is consistent because all files are checkpointed to the same SCN. You can restore the consistent database backup without further recovery. After restoring the backup files, you can perform additional recovery steps to recover the database to a more current time if the database is operated in `ARCHIVELOG` mode. Also, you can take inconsistent whole database backups if your database is in `ARCHIVELOG` mode.

Control files play a crucial role in database restore and recovery. For databases running in `ARCHIVELOG` mode, Oracle recommends that you back up control files with the `ALTER DATABASE BACKUP CONTROLFILE TO 'filename'` statement.

See Also:

["Making User-Managed Backups of the Control File \(page 29-14\)"](#) for more information about backing up control files

Making Consistent Whole Database Backups

This section describes how to back up the database with an operating system utility.

To make a consistent whole database backup:

1. If the database is open, then use SQL*Plus to shut down the database with the `NORMAL`, `IMMEDIATE`, or `TRANSACTIONAL` options.

2. Use an operating system utility to make backups of all data files and all control files specified by the `CONTROL_FILES` parameter of the initialization parameter file. Also, back up the initialization parameter file and other Oracle product initialization files. To find these files, do a search for `*.ora` starting in your Oracle home directory and recursively search all of its subdirectories.

For example, you can back up the data files, control files, and archived logs to `disk2/backup` as follows:

```
% cp $ORACLE_HOME/oradata/trgt/*.dbf /disk2/backup
% cp $ORACLE_HOME/oradata/trgt/arch/* /disk2/backup/arch
```

3. Restart the database with the `STARTUP` command in SQL*Plus.

See Also:

Oracle Database Administrator's Guide for more information about starting up and shutting down a database

29.3 Making User-Managed Backups of CDBs and PDBs

The information in this chapter applies to multitenant container databases (CDBs) and pluggable databases (PDBs) with only slight changes, as described in the following section.

To make a consistent whole database backup for a CDB:

1. Open SQL*Plus.
2. Connect to the `root` as a user with the `SYSDBA` or `SYSBACKUP` system privilege as described in "[Connecting as Target to the Root](#) (page 4-8)".
3. If the database is open, then use SQL*Plus to shut down the database with the `NORMAL`, `IMMEDIATE`, or `TRANSACTIONAL` options.
4. Use an operating system utility to make backups of all data files and all control files specified by the `CONTROL_FILES` parameter of the initialization parameter file. Also, back up the initialization parameter file and other Oracle product initialization files. To find these files, do a search for `*.ora` starting in your Oracle home directory and recursively search all of its subdirectories.

For example, you can back up the data files, control files, and archived logs to `disk3/backup` as follows:

```
% cp $ORACLE_HOME/oradata/cdb1/*.dbf /disk3/backup
% cp $ORACLE_HOME/oradata/cdb1/arch/* /disk3/backup/arch
```

5. Restart the database with the `STARTUP` command in SQL*Plus.

See Also:

- *Oracle Database SQL Language Reference* for more information about using `ALTER DATABASE` command for CDBs
 - *Oracle Database Administrator's Guide* for more information about starting up and shutting down a database
-

To make a consistent backup of a PDB:

1. Open SQL*Plus.
2. Connect to the PDB as a user with the `SYSDBA` or `SYSBACKUP` system privilege as described in "[Connecting as Target to a PDB](#) (page 4-9)".
3. Begin the backup with the SQL `ALTER DATABASE` command.

```
ALTER DATABASE BEGIN BACKUP;
```

4. Use an operating system utility to copy the data files belonging to the PDB to a backup device.
5. End the backup with the SQL `ALTER DATABASE` command.

```
ALTER DATABASE END BACKUP;
```

29.4 Making User-Managed Backups of Tablespaces and Data Files

The technique for making user-managed backups of tablespaces and data files depends on whether the files are offline or online.

This section contains the following topics:

- [Making User-Managed Backups of Offline Tablespaces and Data Files](#) (page 29-5)
- [Making User-Managed Backups of Online Tablespaces and Data Files](#) (page 29-6)

29.4.1 Making User-Managed Backups of Offline Tablespaces and Data Files

Note the following guidelines when backing up offline tablespaces:

- You cannot take offline the `SYSTEM` tablespace or a tablespace with active undo segments. The following technique cannot be used for such tablespaces.
- Assume that a table is in tablespace `Primary` and its index is in tablespace `Index`. Taking tablespace `Index` offline while leaving tablespace `Primary` online can cause errors when data manipulation language (DML) is issued against the indexed tables located in `Primary`. The problem appears only when the access method chosen by the optimizer must access the indexes in the `Index` tablespace.

To back up offline tablespaces:

1. Before beginning a backup of a tablespace, identify the tablespace's data files by querying the `DBA_DATA_FILES` view. For example, assume that you want to back up the `users` tablespace. Enter the following statement in SQL*Plus:

```
SELECT TABLESPACE_NAME, FILE_NAME
FROM SYS.DBA_DATA_FILES
WHERE TABLESPACE_NAME = 'USERS';
```

TABLESPACE_NAME	FILE_NAME
USERS	/oracle/oradata/trgt/users01.dbf

In this example, `/oracle/oradata/trgt/users01.dbf` is a fully specified file name corresponding to the data file in the `users` tablespace.

2. Take the tablespace offline using normal priority if possible, because it guarantees that you can subsequently bring the tablespace online without having to recover it. For example:

```
SQL> ALTER TABLESPACE users OFFLINE NORMAL;
```

3. Back up the offline data files. For example:

```
% cp /oracle/oradata/trgt/users01.dbf /d2/users01_'date +%m_%d_%y' '.dbf
```

4. Bring the tablespace online. For example:

```
ALTER TABLESPACE users ONLINE;
```

Note:

If you took the tablespace offline using temporary or immediate priority, then you cannot bring the tablespace online unless you perform tablespace recovery.

5. Archive the unarchived redo logs so that the redo required to recover the tablespace backup is archived. For example, enter:

```
ALTER SYSTEM ARCHIVE LOG CURRENT;
```

29.4.2 Making User-Managed Backups of Online Tablespaces and Data Files

You can back up all or only specific data files of an online tablespace while the database is open. The procedure differs depending on whether the online tablespace is read/write or read-only.

Note:

Do not back up temporary tablespaces.

This section contains the following topics:

- [Making User-Managed Backups of Online Read/Write Tablespaces](#) (page 29-7)
- [Making Multiple User-Managed Backups of Online Read/Write Tablespaces](#) (page 29-8)
- [Ending a Backup After an Instance Failure or SHUTDOWN ABORT](#) (page 29-9)
- [Making User-Managed Backups of Read-Only Tablespaces](#) (page 29-11)

29.4.2.1 Making User-Managed Backups of Online Read/Write Tablespaces

You must put a read/write tablespace in backup mode to make user-managed data file backups when the tablespace is online and the database is open. The `ALTER TABLESPACE . . . BEGIN BACKUP` statement places a tablespace in backup mode. In backup mode, the database copies whole changed data blocks into the redo stream. After you take the tablespace out of backup mode with the `ALTER TABLESPACE . . . END BACKUP` or `ALTER DATABASE END BACKUP` statement, the database advances the [data file checkpoint](#) SCN to the current [database checkpoint](#) SCN.

When restoring a data file backed up in this way, the database asks for the appropriate set of redo log files to apply if recovery is needed. The redo logs contain all changes required to recover the data files and make them consistent.

To back up online read/write tablespaces in an open database:

1. Before beginning a backup of a tablespace, use the `DBA_DATA_FILES` data dictionary view to identify all of the data files in the tablespace. For example, assume that you want to back up the `users` tablespace. Enter the following:

```
SELECT TABLESPACE_NAME, FILE_NAME
FROM   SYS.DBA_DATA_FILES
WHERE  TABLESPACE_NAME = 'USERS';
```

TABLESPACE_NAME	FILE_NAME
USERS	/oracle/oradata/trgt/users01.dbf
USERS	/oracle/oradata/trgt/users02.dbf

2. Mark the beginning of the online tablespace backup. For example, the following statement marks the start of an online backup for the tablespace `users`:

```
SQL> ALTER TABLESPACE users BEGIN BACKUP;
```

Caution:

If you do not use `BEGIN BACKUP` to mark the beginning of an online tablespace backup and wait for this statement to complete before starting your copies of online tablespaces, then the data file copies produced are not usable for subsequent recovery operations. Attempting to recover such a backup is risky and can return errors that result in inconsistent data. For example, the attempted recovery operation can issue a [fuzzy file](#) warning, and can lead to an inconsistent database that you cannot open.

3. Back up the online data files of the online tablespace with operating system commands. For example, Linux and UNIX users might enter:

```
% cp /oracle/oradata/trgt/users01.dbf /d2/users01_'date +%m_%d_%y' '.dbf
% cp /oracle/oradata/trgt/users02.dbf /d2/users02_'date +%m_%d_%y' '.dbf
```

4. After backing up the data files of the online tablespace, run the SQL statement `ALTER TABLESPACE` with the `END BACKUP` option. For example, the following statement ends the online backup of the tablespace `users`:

```
SQL> ALTER TABLESPACE users END BACKUP;
```

5. Archive the unarchived redo logs so that the redo required to recover the tablespace backup is archived. For example, enter:

```
SQL> ALTER SYSTEM ARCHIVE LOG CURRENT;
```

Caution:

If you fail to take the tablespace out of backup mode, then Oracle Database continues to write copies of data blocks in this tablespace to the online redo logs, causing performance problems. Also, you receive an ORA-01149 error if you try to shut down the database with the tablespaces still in backup mode.

29.4.2.2 Making Multiple User-Managed Backups of Online Read/Write Tablespaces

When backing up several online tablespaces, you can back them up either serially or in parallel. Use either of the following procedures depending on your needs:

- [Backing Up Online Tablespaces in Parallel](#) (page 29-8)
- [Backing Up Online Tablespaces Serially](#) (page 29-9)

29.4.2.2.1 Backing Up Online Tablespaces in Parallel

You can simultaneously create data file copies of multiple tablespaces requiring backups in backup mode. Note, however, that by putting all tablespaces in online mode together, you can generate large redo logs if there is heavy update activity on the affected tablespaces, because the redo must contain a copy of each changed data block in each changed data file. Be sure to consider the size of the likely redo before using the procedure outlined here.

To back up online tablespaces in parallel:

1. Prepare the online tablespaces for backup by issuing all necessary ALTER TABLESPACE statements together. For example, put tablespaces *users*, *tools*, and *indx* in backup mode as follows:

```
SQL> ALTER TABLESPACE users BEGIN BACKUP;
SQL> ALTER TABLESPACE tools BEGIN BACKUP;
SQL> ALTER TABLESPACE indx BEGIN BACKUP;
```

If you are backing up all tablespaces, you can use this command:

```
SQL> ALTER DATABASE BEGIN BACKUP;
```

2. Back up all files of the online tablespaces. For example, a Linux or UNIX user might back up data files with the **.dbf* suffix as follows:

```
% cp $ORACLE_HOME/oradata/trgt/*.dbf /disk2/backup/
```

3. Take the tablespaces out of backup mode as in the following example:

```
SQL> ALTER TABLESPACE users END BACKUP;
SQL> ALTER TABLESPACE tools END BACKUP;
SQL> ALTER TABLESPACE indx END BACKUP;
```

Again, if you are handling all data files together, you can use the ALTER DATABASE command instead of ALTER TABLESPACE:

```
SQL> ALTER DATABASE END BACKUP;
```

4. Archive the online redo logs so that the redo required to recover the tablespace backups is available for later media recovery. For example, enter:

```
SQL> ALTER SYSTEM ARCHIVE LOG CURRENT;
```

29.4.2.2 Backing Up Online Tablespaces Serially

You can place all tablespaces requiring online backups in backup mode one at a time. Oracle recommends the serial backup option because it minimizes the time between `ALTER TABLESPACE . . . BEGIN/END BACKUP` statements. During online backups, more redo information is generated for the tablespace because whole data blocks are copied into the redo log.

To back up online tablespaces serially:

1. Prepare a tablespace for online backup. For example, to put tablespace users in backup mode enter the following:

```
SQL> ALTER TABLESPACE users BEGIN BACKUP;
```

In this case you probably do not want to use `ALTER DATABASE BEGIN BACKUP` to put all tablespaces in backup mode simultaneously, because of the unnecessary volume of redo log information generated for tablespaces in online mode.

2. Back up the data files in the tablespace. For example, enter:

```
% cp /oracle/oradata/trgt/users01.dbf /d2/users01_'date "+%m_%d_%y"'.dbf
```

3. Take the tablespace out of backup mode. For example, enter:

```
SQL> ALTER TABLESPACE users END BACKUP;
```

4. Repeat this procedure for each remaining tablespace.
5. Archive the unarchived redo logs so that the redo required to recover the tablespace backups is archived. For example, enter:

```
SQL> ALTER SYSTEM ARCHIVE LOG CURRENT;
```

29.4.2.3 Ending a Backup After an Instance Failure or SHUTDOWN ABORT

The following situations can cause a tablespace backup to fail and be incomplete:

- The backup completed, but you did not run the `ALTER TABLESPACE . . . END BACKUP` statement.
- An instance failure or `SHUTDOWN ABORT` interrupted the backup.

Whenever recovery from a failure is required, if a data file is in backup mode when an attempt is made to open it, then the database does not open the data file until either a recovery command is issued, or the data file is taken out of backup mode.

For example, the database may display a message such as the following at startup:

```
ORA-01113: file 12 needs media recovery
ORA-01110: data file 12: '/oracle/dbs/tbs_41.f'
```

If the database indicates that the data files for multiple tablespaces require media recovery because you forgot to end the online backups for these tablespaces, then so long as the database is mounted, running the `ALTER DATABASE END BACKUP` statement takes all the data files out of backup mode simultaneously.

In high availability situations, and in situations when no database administrator (DBA) is monitoring the database, the requirement for user intervention is intolerable. Hence, you can write a failure recovery script that does the following:

1. Mounts the database
2. Runs the ALTER DATABASE END BACKUP statement
3. Runs ALTER DATABASE OPEN, enabling the system to start automatically

An automated crash recovery script containing ALTER DATABASE END BACKUP is especially useful in the following situations:

- All nodes in an Oracle Real Application Clusters (Oracle RAC) configuration fail.
- One node fails in a **cold failover cluster** (that is, a cluster that is *not* an Oracle RAC configuration in which the secondary node must mount and recover the database when the first node fails).

Alternatively, you can take the following manual measures after the system fails with tablespaces in backup mode:

- Recover the database and avoid issuing END BACKUP statements altogether.
- Mount the database, then run the ALTER TABLESPACE . . . END BACKUP statement for each tablespace still in backup mode.

29.4.2.3.1 Ending Backup Mode with the ALTER DATABASE END BACKUP Statement

You can run the ALTER DATABASE END BACKUP statement when you have multiple tablespaces still in backup mode. The primary purpose of this command is to allow a crash recovery script to restart a failed system without DBA intervention. You can also perform the following procedure manually.

To take tablespaces out of backup mode simultaneously:

1. Mount but do not open the database. For example, enter:

```
SQL> STARTUP MOUNT
```

2. If you are performing this procedure manually (that is, not as part of a failure recovery script), query the V\$BACKUP view to list the data files of the tablespaces that were being backed up before the database was restarted:

```
SQL> SELECT * FROM V$BACKUP WHERE STATUS = 'ACTIVE';
FILE#      STATUS      CHANGE#    TIME          CON_ID
-----
          12 ACTIVE          20863 25-NOV-02          0
          13 ACTIVE          20863 25-NOV-02          0
          20 ACTIVE          20863 25-NOV-02          0
3 rows selected.
```

3. Issue the ALTER DATABASE END BACKUP statement to take all data files currently in backup mode out of backup mode. For example, enter:

```
SQL> ALTER DATABASE END BACKUP;
```

You can use this statement only when the database is mounted but not open. If the database is open, then use ALTER TABLESPACE . . . END BACKUP or ALTER DATABASE DATAFILE . . . END BACKUP for each affected tablespace or data file.

Caution:

Do not use `ALTER DATABASE END BACKUP` if you have restored any of the affected files from a backup.

29.4.2.3.2 Ending Backup Mode with the SQL*Plus RECOVER Command

The `ALTER DATABASE END BACKUP` statement is not the only way to respond to a failed online backup; you can also run the SQL*Plus `RECOVER` command. This method is useful when you are not sure whether someone has restored a backup, because if someone has indeed restored a backup, then the `RECOVER` command brings the backup up-to-date. Only run the `ALTER DATABASE END BACKUP` or `ALTER TABLESPACE . . . END BACKUP` statement if you are sure that the files are current.

Note:

The `RECOVER` command method is slow because the database must scan redo generated from the beginning of the online backup.

To take tablespaces out of backup mode with the RECOVER command:

1. Mount the database. For example, enter:

```
SQL> STARTUP MOUNT
```

2. Recover the database as usual. For example, enter:

```
SQL> RECOVER DATABASE
```

3. Use the `V$BACKUP` view to confirm that there are no active data files:

```
SQL> SELECT * FROM V$BACKUP WHERE STATUS = 'ACTIVE';
```

```
no rows selected.
```

See Also:

[Performing User-Managed Database Flashback and Recovery](#) (page 30-1) for information about recovering a database

29.4.2.4 Making User-Managed Backups of Read-Only Tablespaces

When backing up an online read-only tablespace, you can simply back up the online data files. You do not have to place the tablespace in backup mode because the database is not permitting changes to the data files.

If the set of read-only tablespaces is self-contained, then in addition to backing up the tablespaces with operating system commands, you can also export the tablespace metadata with the transportable tablespace functionality. If a media error or a user error occurs (such as accidentally dropping a table in the read-only tablespace), you can transport the tablespace back into the database.

See Also:

Oracle Database Administrator's Guide to learn how to transport tablespaces

To back up online read-only tablespaces in an open database:

1. Query the DBA_TABLESPACES view to determine which tablespaces are read-only. For example, run this query:

```
SELECT TABLESPACE_NAME, STATUS
FROM DBA_TABLESPACES
WHERE STATUS = 'READ ONLY';
```

2. Before beginning a backup of a read-only tablespace, identify all of the tablespace's data files by querying the DBA_DATA_FILES data dictionary view. For example, assume that you want to back up the history tablespace:

```
SELECT TABLESPACE_NAME, FILE_NAME
FROM SYS.DBA_DATA_FILES
WHERE TABLESPACE_NAME = 'HISTORY';
```

TABLESPACE_NAME	FILE_NAME
HISTORY	/oracle/oradata/trgt/history01.dbf
HISTORY	/oracle/oradata/trgt/history02.dbf

3. Back up the online data files of the read-only tablespace with operating system commands. You do not have to take the tablespace offline or put the tablespace in backup mode because users are automatically prevented from making changes to the read-only tablespace. For example:

```
% cp $ORACLE_HOME/oradata/trgt/history*.dbf /disk2/backup/
```

Note:

When restoring a backup of a read-only tablespace, take the tablespace offline, restore the data files, then bring the tablespace online. A backup of a read-only tablespace is still usable if the read-only tablespace is made read/write after the backup, but the restored backup requires recovery.

4. Optionally, export the metadata in the read-only tablespace. By using the transportable tablespace feature, you can quickly restore the data files and import the metadata in case of media failure or user error. For example, export the metadata for tablespace history as follows:

```
% expdp DIRECTORY=dpump_dir1 DUMPFILE=hs.dmp TRANSPORT_TABLESPACES=history
LOGFILE=tts.log
```

See Also:

Oracle Database Reference for more information about the DBA_DATA_FILES and DBA_TABLESPACES views

29.5 Making User-Managed Backups of Tablespaces in CDBs

The procedures in the section "[Making User-Managed Backups of Tablespaces and Data Files](#) (page 29-5)" are applicable to CDBs and PDBs with the modifications described in the following sections:

- [Making User-Managed Backups of Offline Tablespaces and Data Files in CDBs](#) (page 29-13)
- [Making User-Managed Backups of Online Tablespaces in CDBs and PDBs](#) (page 29-14)

29.5.1 Making User-Managed Backups of Offline Tablespaces and Data Files in CDBs

The guidelines described in "[Making User-Managed Backups of Offline Tablespaces and Data Files](#) (page 29-5)" are also applicable to tablespaces and data files in CDBs and PDBs.

To backup offline tablespaces in a multitenant environment:

1. Open SQL*Plus.
2. Perform one of the following operations:
 - To back up offline tablespaces in the root, connect to the root as a common user with the SYSDBA or SYSBACKUP system privilege.
 - To back up offline tablespaces in a PDB, connect to the PDB as a common user or local user with SYSDBA or SYSBACKUP system privilege.
3. Before beginning a backup of a tablespace, identify the tablespace's data files by querying the DBA_DATA_FILES view. For example, assume that you want to back up the `users` tablespace. Enter the following statement in SQL*Plus:

```
SELECT TABLESPACE_NAME, FILE_NAME
       FROM SYS.DBA_DATA_FILES
       WHERE TABLESPACE_NAME = 'USERS';
```

TABLESPACE_NAME	FILE_NAME
USERS	/oracle/oradata/trgt/users01.dbf

In this example, `/oracle/oradata/trgt/users01.dbf` is a fully specified file name corresponding to the data file in the `users` tablespace.

4. Take the tablespace offline using normal priority if possible, because it guarantees that you can subsequently bring the tablespace online without having to recover it. For example:

```
SQL> ALTER TABLESPACE users OFFLINE NORMAL;
```

5. Back up the offline data files. For example:

```
% cp /oracle/oradata/trgt/users01.dbf /d2/users01_'date +%m_%d_%y' .dbf
```

6. Bring the tablespace online. For example:

```
ALTER TABLESPACE users ONLINE;
```

Note:

If you took the tablespace offline using temporary or immediate priority, then you cannot bring the tablespace online unless you perform tablespace recovery.

7. Archive the unarchived redo logs so that the redo required to recover the tablespace backup is archived. For example, enter:

```
ALTER SYSTEM ARCHIVE LOG CURRENT;
```

29.5.2 Making User-Managed Backups of Online Tablespaces in CDBs and PDBs

The guidelines described in "[Making User-Managed Backups of Online Tablespaces and Data Files](#) (page 29-6)" are also applicable to tablespaces and data files in CDBs and PDBs.

To back up online tablespaces in the root container:

1. Open SQL*Plus.
2. Connect to the root as a user with the SYSDBA or SYSBACKUP system privilege.
3. Follow the instructions in "[Making User-Managed Backups of Online Tablespaces and Data Files](#) (page 29-6)".

To backup online tablespaces in a PDB:

1. Open SQL*Plus.
2. Connect to the PDB as a user with SYSDBA or SYSBACKUP system privilege.
3. Follow the instructions in "[Making User-Managed Backups of Online Tablespaces and Data Files](#) (page 29-6)".

29.6 Making User-Managed Backups of the Control File

Back up the control file of a database after making a structural modification to a database operating in ARCHIVELOG mode. To back up a database's control file, you must have the ALTER DATABASE system privilege.

This section contains the following topics:

- [Backing Up the Control File to a Binary File](#) (page 29-14)
- [Backing Up the Control File to a Trace File](#) (page 29-15)

29.6.1 Backing Up the Control File to a Binary File

The primary method for backing up the control file is to use a SQL statement to generate a binary file. A binary backup is preferable to a trace file backup because it contains additional information such as the archived log history, offline range for read-only and offline tablespaces, and backup sets and copies (if you use RMAN). If COMPATIBLE is 10.2 or higher, binary control file backups include temp file entries.

To back up the control file after a structural change:

1. Make the desired change to the database. For example, you may create a tablespace:

```
CREATE TABLESPACE tbs_1 DATAFILE 'file_1.f' SIZE 10M;
```

2. Back up the database's control file, specifying a file name for the output binary file. The following example backs up a control file to `/disk1/backup/cf.bak`:

```
ALTER DATABASE BACKUP CONTROLFILE TO '/disk1/backup/cf.bak' REUSE;
```

Specify `REUSE` to make the new control file overwrite one that currently exists.

29.6.2 Backing Up the Control File to a Trace File

You can back up the control file to a text file that contains a `CREATE CONTROLFILE` statement. You can edit the trace file to create a script that creates a new control file based on the control file that was current when you created the trace file.

If you specify neither the `RESETLOGS` nor `NORESETLOGS` option in the SQL statement, then the resulting trace file contains versions of the control file for both `RESETLOGS` and `NORESETLOGS` options. Temp file entries are included in the output using `ALTER TABLESPACE ... ADD TEMPFILE` statements.

To avoid recovering offline normal or read-only tablespaces, edit them out of the `CREATE CONTROLFILE` statement. When you open the database with the re-created control file, the database marks these omitted files as `MISSING`. You can run an `ALTER DATABASE RENAME FILE` statement to rename them to their original file names.

The trace file containing the `CREATE CONTROLFILE` statement is stored in a subdirectory determined by the `DIAGNOSTIC_DEST` initialization parameter. You can look in the database alert log for the name and location of the trace file to which the `CREATE CONTROLFILE` statement was written. See *Oracle Database Administrator's Guide* to learn how to locate the alert log.

To back up the control file to a trace file:

1. Mount or open the database.
2. Execute the following SQL statement:

```
ALTER DATABASE BACKUP CONTROLFILE TO TRACE;
```

See Also:

["Recovery of Read-Only Files with a Re-Created Control File \(page 31-10\)"](#) for special issues relating to read-only, offline normal, and temporary files included in `CREATE CONTROLFILE` statements

29.7 Making User-Managed Backups of Archived Redo Logs

To save disk space in your primary archiving location, you may want to back up archived logs to tape or to an alternative disk location. If you archive to multiple locations, then only back up one copy of each log sequence number.

To back up archived redo logs:

1. To determine which archived redo log files the database has generated, query V\$ARCHIVED_LOG. For example, run the following query:

```
SELECT THREAD#, SEQUENCE#, NAME  
FROM V$ARCHIVED_LOG;
```

2. Back up one copy of each log sequence number by using an operating system utility. This example backs up all logs in the primary archiving location to a disk devoted to log backups:

```
% cp $ORACLE_HOME/oracle/trgt/arch/* /disk2/backup/arch
```

See Also:

Oracle Database Reference for more information about the data dictionary views

29.8 Making User-Managed Backups in SUSPEND Mode

This section contains the following topics:

- [About the Suspend/Resume Feature](#) (page 29-16)
- [Making Backups in a Suspended Database](#) (page 29-17)

29.8.1 About the Suspend/Resume Feature

Some third-party tools allow you to mirror a set of disks or logical devices, that is, maintain an exact duplicate of the primary data in another location, and then *split the mirror*. Splitting the mirror involves separating the copies so that you can use them independently.

With the SUSPEND/RESUME functionality, you can suspend I/O to the database, then split the mirror and make a backup of the split mirror. By using this feature, which complements the backup mode functionality, you can suspend database I/Os so that no new I/O can be performed. You can then access the suspended database to make backups without I/O interference.

Usually, you do not need to use SUSPEND/RESUME to make split mirror backups, although it is necessary if your system requires the database cache to be free of *dirty buffers* before a volume can be split. Some RAID devices benefit from suspending writes while the split operation is occurring; your RAID vendor can advise you on whether your system would benefit from this feature.

The ALTER SYSTEM SUSPEND statement suspends the database by halting I/Os to data file headers, data files, and control files. When the database is suspended, all preexisting I/O operations can complete; however, any new database I/O access attempts are queued.

The ALTER SYSTEM SUSPEND and ALTER SYSTEM RESUME statements operate on the database and not just the instance. If the ALTER SYSTEM SUSPEND statement is entered on one system in an Oracle RAC configuration, then the internal locking mechanisms propagate the halt request across instances, thereby suspending I/O operations for all active instances in a given cluster.

29.8.2 Making Backups in a Suspended Database

After a successful database suspension, you can back up the database to disk or break the mirrors. Because suspending a database does not guarantee immediate termination of I/O, Oracle recommends that you precede the `ALTER SYSTEM SUSPEND` statement with a `BEGIN BACKUP` statement so that the tablespaces are placed in backup mode.

You must use conventional user-managed backup methods to back up split mirrors. RMAN cannot make database backups or copies because these operations require reading the data file headers. After the database backup is finished or the mirrors are resilvered, then you can resume normal database operations using the `ALTER SYSTEM RESUME` statement.

Backing up a suspended database without splitting mirrors can cause an extended database outage because the database is inaccessible during this time. If backups are taken by splitting mirrors, however, then the outage is nominal. The outage time depends on the size of cache to flush, the number of data files, and the time required to break the mirror.

Note the following restrictions for the `SUSPEND/RESUME` feature:

- In an Oracle RAC configuration, do not start a new instance while the original nodes are suspended.
- No checkpoint is initiated by the `ALTER SYSTEM SUSPEND` or `ALTER SYSTEM RESUME` statements.
- You cannot issue `SHUTDOWN` with `IMMEDIATE`, `NORMAL`, or `TRANSACTIONAL` options while the database is suspended.
- Issuing `SHUTDOWN ABORT` on a database that is suspended reactivates the database. This prevents media recovery or failure recovery from getting into a unresponsive state.

To make a split mirror backup in SUSPEND mode:

1. Place the database tablespaces in backup mode. For example, to place tablespace `users` in backup mode, enter:

```
ALTER TABLESPACE users BEGIN BACKUP;
```

If you are backing up all of the tablespaces for your database, you can instead use:

```
ALTER DATABASE BEGIN BACKUP;
```

Caution:

Do not use the `ALTER SYSTEM SUSPEND` statement as a substitute for placing a tablespace in backup mode.

2. If your mirror system has problems with splitting a mirror while disk writes are occurring, then suspend the database. For example, issue the following statement:

```
ALTER SYSTEM SUSPEND;
```

3. Verify that the database is suspended by querying the `V$INSTANCE` view. For example:

```
SELECT DATABASE_STATUS FROM V$INSTANCE;
```

```
DATABASE_STATUS
-----
SUSPENDED
```

4. Split the mirrors at the operating system or hardware level.
5. End the database suspension. For example, issue the following statement:

```
ALTER SYSTEM RESUME;
```

6. Establish that the database is active by querying the V\$INSTANCE view. For example, enter:

```
SELECT DATABASE_STATUS FROM V$INSTANCE;
```

```
DATABASE_STATUS
-----
ACTIVE
```

7. Take the specified tablespaces out of backup mode. For example, enter the following statement to take tablespace users out of backup mode:

```
ALTER TABLESPACE users END BACKUP;
```

8. Copy the control file and archive the online redo logs as usual for a backup.

See Also:

- ["Making Split Mirror Backups with RMAN \(page 10-9\)"](#)
 - *Oracle Database Administrator's Guide* for more information about the SUSPEND/RESUME feature
 - *Oracle Database SQL Language Reference* for the ALTER SYSTEM SUSPEND syntax
-
-

29.9 Making User-Managed Backups to Raw Devices

A [raw device](#) is a disk or partition that does not have a file system. A raw device can contain only a single file. Backing up files on raw devices poses operating system specific issues. The following sections discuss some of these issues on UNIX, Linux, and Windows.

This section contains the following topics:

- [Backing Up to Raw Devices on Linux and UNIX \(page 29-18\)](#)
- [Backing Up to Raw Devices on Windows \(page 29-20\)](#)

29.9.1 Backing Up to Raw Devices on Linux and UNIX

The dd command on Linux and UNIX is the most common backup utility for backing up to or from raw devices. See your operating system-specific documentation for complete details about this utility.

Using `dd` effectively requires that you specify the correct options, based on your database. [Table 29-1](#) (page 29-19) lists details about your database that affect the options you use for `dd`.

Table 29-1 Aspects of the Database Important for `dd` Usage

Data	Explanation
Block size	You can specify the size of the buffer that <code>dd</code> uses to copy data. For example, you can specify that <code>dd</code> copies data in units of 8 KB or 64 KB. The block size for <code>dd</code> need not correspond to either the Oracle block size or the operating system block size: it is merely the size of the buffer used by <code>dd</code> when making the copy.
Raw offset	On some systems, the beginning of the file on the raw device is reserved for use by the operating system. This storage space is called the raw offset . Oracle Database does not back up or restore these bytes.
Size of Oracle Database block 0	At the beginning of every Oracle database file, the operating system-specific code places an Oracle block called block 0 . The generic Oracle code does not recognize this block, but the block is included in the size of the file on the operating system. Typically, this block is the same size as the other Oracle blocks in the file.

The information in [Table 29-1](#) (page 29-19) enables you to set the `dd` options specified in [Table 29-2](#) (page 29-19).

Table 29-2 Options for `dd` Command

This Option ...	Specifies ...
<code>if</code>	The name of the input file, that is, the file that you are reading
<code>of</code>	The name of the output file, that is, the file to which you are writing
<code>bs</code>	The buffer size used by <code>dd</code> to copy data
<code>skip</code>	The number of <code>dd</code> buffers to skip on the input raw device if a raw offset exists. For example, if you are backing up a file on a raw device with a 64 KB raw offset, and the <code>dd</code> buffer size is 8 KB, then you can specify <code>skip=8</code> so that the copy starts at offset 64 KB.
<code>seek</code>	The number of <code>dd</code> buffers to skip on the output raw device if a raw offset exists. For example, if you are backing up a file onto a raw device with a 64 KB raw offset, and the <code>dd</code> buffer size is 8 KB, then you can specify <code>skip=8</code> so that the copy starts at offset 64 KB.
<code>count</code>	The number of blocks on the input raw device for <code>dd</code> to copy. It is best to specify the exact number of blocks to copy when copying from a raw device to a file system; otherwise extra space at the end of the raw volume that is not used by the Oracle data file is copied to the file system. Remember to include block 0 in the total size of the input file. For example, if the <code>dd</code> block size is 8 KB, and you are backing up a 30720 KB data file, then you can set <code>count=3841</code> . This value for <code>count</code> actually backs up 30728 KB: the extra 8 KB are for Oracle block 0.

Because a raw device can be the input or output device for a backup, you have four possible scenarios for the backup. The possible options for `dd` depend on which scenario you choose, as illustrated in [Table 29-3](#) (page 29-20).

Table 29-3 Scenarios Involving dd Backups

Backing Up from ...	Backing Up to ...	Options Specified for dd Command
Raw device	Raw device	if, of, bs, skip, seek, count
Raw device	File system	if, of, bs, skip, count
File system	Raw device	if, of, bs, seek
File system	File system	if, of, bs

29.9.1.1 Backing Up with the dd Utility on Linux and UNIX: Examples

For these examples of dd utility usage, assume the following:

- You are backing up a 30720 KB data file.
- The beginning of the data file has a block 0 of 8 KB.
- The raw offset is 64 KB.
- You set the dd block size to 8 KB when a raw device is involved in the copy.

In the following example, you back up from one raw device to another raw device:

```
% dd if=/dev/rsd1b of=/dev/rsd2b bs=8k skip=8 seek=8 count=3841
```

In the following example, you back up from a raw device to a file system:

```
% dd if=/dev/rsd1b of=/backup/df1.dbf bs=8k skip=8 count=3841
```

In the following example, you back up from a file system to a raw device:

```
% dd if=/backup/df1.dbf of=/dev/rsd2b bs=8k seek=8
```

In the following example, you back up from a file system to a file system, and set the block size to a high value to boost I/O performance:

```
% dd if=/oracle/dbs/df1.dbf of=/backup/df1.dbf bs=1024k
```

29.9.2 Backing Up to Raw Devices on Windows

Like Linux and UNIX, Windows supports raw disk partitions in which the database can store data files, online logs, and control files. Each raw partition is assigned either a drive letter or physical drive number and does not contain a file system. As in Linux and UNIX, each raw partition on Windows is mapped to a single file.

Windows differs from Linux and UNIX in the naming convention for Oracle files. On Windows, raw data file names are formatted as follows:

```
\\.\drive_letter:  
\\.\PHYSICALDRIVEdrive_number
```

For example, the following are possible raw file names:

```
\\.\G:  
\\.\PHYSICALDRIVE3
```

The procedure for making user-managed backups of raw data files is basically the same as for copying files on a Windows file system, except that you use the Oracle `OCOPY` utility rather than the Windows-supplied `copy.exe` or `ntbackup.exe` utilities. `OCOPY` supports 64-bit file I/O, physical raw drives, and raw files. The `OCOPY` utility cannot back up directly to tape.

To display online documentation for `OCOPY`, enter `OCOPY` by itself at the Windows prompt. Sample output follows:

```
Usage of OCOPY:
  ocopy from_file [to_file [a | size_1 [size_n]]]
  ocopy -b from_file to_drive
  ocopy -r from_drive to_dir
```

Note the important `OCOPY` options described in [Table 29-4](#) (page 29-21).

Table 29-4 *OCOPY Options*

Option	Action
b	Splits the input file into multiple output files. This option is useful for backing up to devices that are smaller than the input file.
r	Combines multiple input files and writes to a single output file. This option is useful for restoring backups created with the <code>-b</code> option.

29.9.2.1 Backing Up with OCOPY: Example

In this example, assume the following:

- Data file 12 is mounted on the `\\.\G:` raw partition.
- The `C:` drive mounts a file system.
- The database is open.

To back up the data file on the raw partition `\\.\G:` to a local file system, you can run the following command at the prompt after placing data file 12 in backup mode:

```
OCOPY "\\G:" C:\backup\datafile12.bak
```

29.9.2.2 Specifying the -b and -r Options for OCOPY: Example

In this example, assume the following:

- `\\.\G:` is a raw partition containing data file 7
- The `E:` drive is a removable disk drive.
- The database is open.

To back up the data file onto drive `E:`, you can execute the following command at the Windows prompt after placing data file 7 in backup mode:

```
# first argument is file name, second argument is drive
OCOPY -b "\\G:" E:\
```

When drive `E:` fills up, you can use another disk. In this way, you can divide the backup of data file 7 into multiple files.

Similarly, to restore the backup, take the tablespace containing data file 7 offline and run this command:

```
# first argument is drive, second argument is directory  
OCOPY -r E:\ "\\.\G:"
```

29.10 Making Backups with Third-Party Snapshot Technologies

You can use Storage Snapshot Optimization to take third-party snapshots of the database, without placing the database in backup mode. The snapshots must conform to the requirements described in this section.

Storage Snapshot Optimization provides the following benefits:

- Eliminates the complexity and overhead associated with placing the database in backup mode.
- Performs the recovery in a single step by using the `RECOVER . . . SNAPSHOT TIME` command. You can recover either to the current time or to a point in time after the snapshot was taken.

To use Snapshot Storage Optimization, the third-party snapshot technology must conform to the following requirements:

- The database is crash consistent during the snapshot.
- The snapshot preserves write order for each file.
- The snapshot technology stores the time at which the snapshot is completed.

If the vendor cannot guarantee compliance with these requirements, then you must place your data files into [backup mode](#) by using the `ALTER DATABASE` or `ALTER TABLESPACE` statement with the `BEGIN BACKUP` clause. Place your data files in backup mode just before you create the snapshot. When a tablespace is in backup mode, the database writes the before image for an entire block to the redo stream before modifying a block. The database also records changes to the block in the online redo log. Backup mode also freezes the [data file checkpoint](#) until the file is removed from backup mode. Oracle Database performs this safeguard because it cannot guarantee that a third-party backup tool copies the file header before copying the data blocks. Immediately after the snapshot is created, use the `ALTER DATABASE` or `ALTER TABLESPACE` command with the `END BACKUP` clause to take the data files out of backup mode. You need not wait until the snapshot is actually copied to the backup media to end backup mode.

Note:

RMAN does not support storage-based replication technologies when the database being backed-up resides on Oracle Automatic Storage Management (Oracle ASM).

See Also:

["Recovery Using Storage Snapshot Optimization \(page 30-10\)"](#)

[Volume Shadow Copy Service \(VSS\)](#) is a set of Windows APIs that enable applications to create consistent snapshots called **shadow copies**. The [Oracle VSS writer](#) runs as a

service on Windows systems and is integrated with VSS-enabled applications. You can use these applications to create snapshots of database files managed by the Oracle instance. For example, you can make shadow copies of an Oracle database while it is open read/write.

See Also:

Oracle Database Platform Guide for Microsoft Windows to learn how to back up and recover the database with VSS-enabled applications

29.11 Verifying User-Managed Data File Backups

You must periodically verify your backups to ensure that they are usable for recovery.

This section contains the following topics:

- [Testing the Restoration of Data File Backups](#) (page 29-23)
- [Running the DBVERIFY Utility](#) (page 29-23)

29.11.1 Testing the Restoration of Data File Backups

The best way to test the usability of data file backups is to restore them to a separate host and attempt to open the database, performing media recovery if necessary. This option requires that you have a separate host available for the restore procedure.

See Also:

["Performing Complete Database Recovery](#) (page 30-12)" to learn how to recover files with SQL*Plus

29.11.2 Running the DBVERIFY Utility

The DBVERIFY program is an external command-line utility that performs a physical data structure integrity check on an offline data file. Use DBVERIFY to ensure that a user-managed backup of a data file is valid before it is restored or as a diagnostic aid when you have encountered data corruption problems.

The name and location of DBVERIFY is dependent on your operating system. For example, to perform an integrity check on data file `users01.dbf` on Linux or UNIX, run the `dbv` command as follows:

```
% dbv file=users01.dbf
```

Sample dbv output follows:

```
DBVERIFY - Verification starting : FILE = users01.dbf
```

```
DBVERIFY - Verification complete
```

```
Total Pages Examined          : 250
Total Pages Processed (Data)  : 1
Total Pages Failing (Data)    : 0
Total Pages Processed (Index) : 0
Total Pages Failing (Index)   : 0
```

Total Pages Processed (Other): 2
Total Pages Processed (Seg) : 0
Total Pages Failing (Seg) : 0
Total Pages Empty : 247
Total Pages Marked Corrupt : 0
Total Pages Influx : 0

See Also:

Oracle Database Utilities to learn about DBVERIFY

Performing User-Managed Database Flashback and Recovery

This chapter describes how to restore and recover a database and use the flashback features of Oracle Database in a user-managed backup and recovery strategy. A user-managed backup and recovery strategy means a method that does not depend on RMAN.

This chapter contains the following topics:

- [Performing Flashback Database with SQL*Plus](#) (page 30-2)
- [Overview of User-Managed Media Recovery](#) (page 30-5)
- [Performing Complete Database Recovery](#) (page 30-12)
- [Performing Incomplete Database Recovery](#) (page 30-20)
- [Recovering a Database in NOARCHIVELOG Mode](#) (page 30-24)
- [Troubleshooting Media Recovery](#) (page 30-25)

30.1 Performing Flashback Database with SQL*Plus

You can use SQL*Plus to perform flashback database operations on non-CDBs, multitenant container databases (CDBs), and pluggable databases (PDBs). Oracle Flashback Database returns your entire database or an entire PDB to a previous state without requiring you to restore files from backup.

Flashback Database requires you to create a fast recovery area for your database and enable the collection of flashback logs. The requirements and preparations for flashback database are the same whether you use RMAN or SQL*Plus.

See Also:

- [Performing Flashback and Database Point-in-Time Recovery](#) (page 18-1) for details about how the Flashback Database feature works, requirements for using Flashback Database, and how to enable the collection of flashback logs required for Flashback Database
 - [Performing Flashback Database of non-CDBs with SQL*Plus](#) (page 30-2)
 - [Performing Flashback Database of CDBs with SQL*Plus](#) (page 30-3)
 - [Performing Flashback Database of PDBs with SQL*Plus](#) (page 30-4)
-

30.1.1 Performing Flashback Database of non-CDBs with SQL*Plus

The SQL*Plus `FLASHBACK DATABASE` command performs the same function as the RMAN `FLASHBACK DATABASE` command: it returns the database to a prior state.

The prerequisites for performing a flashback database operation are described in [Prerequisites for Flashback Database and Restore Points](#) (page 7-10).

To perform a flashback of a non-CDB using SQL*Plus:

1. Query the target database to determine the range of possible flashback SCNs. The following SQL*Plus queries show you the latest and earliest SCN in the flashback window:

```
SELECT CURRENT_SCN FROM V$DATABASE;

SELECT OLDEST_FLASHBACK_SCN, OLDEST_FLASHBACK_TIME
FROM   V$FLASHBACK_DATABASE_LOG;
```

2. Use other flashback features if necessary to identify the SCN or time of the unwanted changes to your database.
3. Ensure that the target database is mounted.

The following commands start the database in MOUNT mode.

```
SHUTDOWN IMMEDIATE;
STARTUP MOUNT;
```

4. Start SQL*Plus with administrator privileges.
5. Run the `FLASHBACK DATABASE` statement to return the database to a prior `TIMESTAMP` or `SCN`. For example:

```
FLASHBACK DATABASE TO SCN 46963;
FLASHBACK DATABASE TO TIMESTAMP '2013-11-05 14:00:00';
FLASHBACK DATABASE
  TO TIMESTAMP to_timestamp('2013-11-11 16:00:00', 'YYYY-MM-DD HH24:MI:SS');
```

6. When the operation completes, open the database read-only and perform queries to verify that you have recovered the data you need.

If your chosen target time was not far enough in the past, then use another `FLASHBACK DATABASE` statement. Otherwise, you can use `RECOVER DATABASE` to return the database to the present time and then try another `FLASHBACK DATABASE` statement.

7. When satisfied with the results, open the database with the `RESETLOGS` option.

If appropriate, you can also use Data Pump Export to save lost data, use `RECOVER DATABASE` to return the database to the present, and reimport the lost object.

See Also:

- *Oracle Database Development Guide* to learn how to use related flashback features such as Oracle Flashback Query and Oracle Flashback Transaction Query
 - [Performing Flashback and Database Point-in-Time Recovery](#) (page 18-1) for details about how the Flashback Database feature works, requirements for using Flashback Database, and how to enable the collection of flashback logs required for Flashback Database
-

30.1.2 Performing Flashback Database of CDBs with SQL*Plus

Use the SQL*Plus `FLASHBACK DATABASE` command to return a whole multitenant container database (CDB) to a prior state. The SQL*Plus `FLASHBACK DATABASE` command performs the same function as the `RMAN FLASHBACK DATABASE` command.

The prerequisites for performing a flashback database operation are described in [Prerequisites for Flashback Database and Restore Points](#) (page 7-10).

To perform a flashback of the whole CDB using SQL*Plus:

1. Connect SQL*Plus to the root as a common user with the `SYSDBA` privilege.
2. Perform Steps 1 through 3 described in [Performing Flashback Database of non-CDBs with SQL*Plus](#) (page 30-2).
3. Run the `FLASHBACK DATABASE` command to return the CDB to a prior timestamp, SCN, or restore point.

The following are some examples of flashback operations of CDBs:

```
FLASHBACK DATABASE TO RESTORE POINT cdb_grp;
FLASHBACK DATABASE TO SCN 34468;
```

4. Perform Steps 5 and 6 described in [Performing Flashback Database of non-CDBs with SQL*Plus](#) (page 30-2).
5. Since the pluggable databases (PDBs) are not automatically opened when the CDB is opened, open the PDBs.

The following command, when connected to the root, opens all the PDBs:

```
ALTER PLUGGABLE DATABASE ALL OPEN;
```

If you want to open only some PDBs, then you can open each PDB separately. The following command, when connected to the root, opens the PDB `my_pdb`.

```
ALTER PLUGGABLE DATABASE my_pdb OPEN;
```

See Also:

[Performing Flashback and Database Point-in-Time Recovery](#) (page 18-1) for details about how the Flashback Database feature works, requirements for using Flashback Database, and how to enable the collection of flashback logs required for Flashback Database

30.1.3 Performing Flashback Database of PDBs with SQL*Plus

Use the SQL*Plus `FLASHBACK DATABASE` command to return a specific pluggable database (PDB) to a prior state. The remaining PDBs in the multitenant container database (CDB) are not impacted by the flashback operation on a single PDB.

The SQL*Plus `FLASHBACK DATABASE` command performs the same function as the `RMAN FLASHBACK DATABASE` command.

The prerequisites for performing a flashback database operation are described in [Prerequisites for Flashback Database and Restore Points](#) (page 7-10).

To perform a flashback of a PDB using SQL*Plus:

1. Connect SQL*Plus to the root as a common user with the `SYSDBA` privilege.
2. Ensure that the CDB is open.

The following command, when connected to the root, displays the mode in which the CDB is open.

```
SELECT open_mode from V$DATABASE;
```

3. Determine the desired SCN, restore point, or point in time for the `FLASHBACK DATABASE` command.

Query the `V$RESTORE_POINT` view to obtain the list of PDB restore points. `V$FLASHBACK_DATABASE_LOG` displays the oldest SCN to which a flashback operation can be performed.

4. Ensure that the PDB for which the Flashback Database operation must be performed is closed. Other PDBs can be open and operational.

When connected to the root, the following `ALTER PLUGGABLE DATABASE` command closes the PDB `my_pdb`.

```
ALTER PLUGGABLE DATABASE my_pdb CLOSE;
```

5. Perform a Flashback Database operation on the specified PDB to the desired point in time.

The following are some examples of flashback database operations on PDBs.

- For a PDB that uses local undo:

```
FLASHBACK PLUGGABLE DATABASE my_pdb TO SCN 24368;  
FLASHBACK PLUGGABLE DATABASE my_pdb TO RESTORE POINT guar_rp;
```

- For a PDB that uses shared undo, you can only use SQL*Plus to perform a flashback operation if you are flashing back the PDB to a clean PDB restore point. For example:

```
FLASHBACK PLUGGABLE DATABASE my_pdb TO RESTORE POINT before_appl_changes;
```

6. Open the PDB with `RESETLOGS`.

The following command opens the PDB named `my_pdb` with `RESETLOGS`:

```
ALTER PLUGGABLE DATABASE my_pdb OPEN RESETLOGS;
```

Note:

Flashback operations on a proxy PDB are not supported.

See Also:

[Performing Flashback and Database Point-in-Time Recovery](#) (page 18-1) for details about how the Flashback Database feature works, requirements for using Flashback Database, and how to enable the collection of flashback logs required for Flashback Database

30.2 Overview of User-Managed Media Recovery

This section provides an overview of recovery with SQL*Plus. This section contains the following topics:

- [About User-Managed Restore and Recovery](#) (page 30-5)
- [Automatic Recovery with the RECOVER Command](#) (page 30-7)
- [Recovery When Archived Logs Are in the Default Location](#) (page 30-8)
- [Recovery When Archived Logs Are in a Nondefault Location](#) (page 30-9)
- [Recovery Using Storage Snapshot Optimization](#) (page 30-10)
- [Recovery Cancellation](#) (page 30-11)
- [Parallel Media Recovery](#) (page 30-11)

30.2.1 About User-Managed Restore and Recovery

Typically, you restore a file when a media failure or user error has damaged or deleted one or more data files. In a user-managed restore operation, you use an operating system utility to restore a backup of the file.

If a media failure affects data files, then the recovery procedure depends on:

- The archiving mode of the database: ARCHIVELOG or NOARCHIVELOG
- The type of media failure
- The files affected by the media failure (data files, control files, archived redo logs, and the server parameter file are all candidates for restore operations)

If either a permanent or temporary media failure affects any data files of a database operating in NOARCHIVELOG mode, then the database automatically shuts down. If the media failure is temporary, then correct the underlying problem and restart the database. Usually, crash recovery recovers all committed transactions from the online redo log. If the media failure is permanent, then recover the database as described in "[Recovering a Database in NOARCHIVELOG Mode](#) (page 30-24)".

[Table 30-1](#) (page 30-6) explains the implications for media recovery when you lose files in a database that runs in ARCHIVELOG mode.

Table 30-1 User-Managed Restore Operations

If You Lose...	Then...
Data files in the <code>SYSTEM</code> tablespace or data files with active undo segments	The database automatically shuts down. If the hardware problem is temporary, then fix it and restart the database. Usually, crash recovery recovers lost transactions. If the hardware problem is permanent, then restore the data files from backups and recover the database as described in " Performing Closed Database Recovery (page 30-12)".
Data files not in the <code>SYSTEM</code> tablespace or data files that do not contain active rollback or undo segments	Affected data files are taken offline, but the database stays open. If the unaffected portions of the database must remain available, then do not shut down the database. Take tablespaces containing problem data files offline using the temporary option, then recover them as described in " Performing Open Database Recovery (page 30-16)".
All copies of the current control file	You must restore a backup control file and then open the database with the <code>RESETLOGS</code> option. If you do not have a backup, then you can attempt to re-create the control file. If possible, use the script included in the <code>ALTER DATABASE BACKUP CONTROLFILE TO TRACE</code> output. Additional work may be required to match the control file structure with the current database structure.
One copy of a multiplexed control file	Copy an intact multiplexed control file into the location of the damaged or missing control file and open the database. If you cannot copy the control file to its original location, then edit the initialization parameter file to reflect a new location or remove the damaged control file. Then, open the database.
One or more archived logs required for media recovery	You must restore backups of these archived logs for recovery to proceed. You can restore either to the default or nondefault location. If you do not have backups, then you must perform incomplete recovery up to an SCN before the first missing redo log and open <code>RESETLOGS</code> .
The server parameter file (SPFILE)	If you have a backup of the server parameter file, then restore it. Alternatively, if you have a backup of the client-side initialization parameter file, then you can restore a backup of this file, start the instance, and then re-create the server parameter file.

Note:

Restore and recovery of Oracle Managed Files is no different from restore and recovery of user-named files.

To perform media recovery, Oracle recommends that you use the `RECOVER` statement in SQL*Plus. You can also use the SQL statement `ALTER DATABASE RECOVER`, but the `RECOVER` statement is often simpler. To start any type of media recovery, you must adhere to the following restrictions:

- You must have administrator privileges.
- All recovery sessions must be compatible.
- One session cannot start complete media recovery while another performs incomplete media recovery.
- You cannot start media recovery if you are connected to the database through a shared server process.

30.2.2 Automatic Recovery with the RECOVER Command

When using SQL*Plus to perform media recovery, the easiest strategy is to perform automatic recovery with the SQL*Plus RECOVER command. Automatic recovery initiates recovery without manually prompting SQL*Plus to apply each individual archived redo log.

When using SQL*Plus, you have the following options for automating the application of the default file names of archived redo logs needed during recovery:

- Issuing SET AUTORECOVERY ON before issuing the RECOVER command. If you perform recovery with SET AUTORECOVERY OFF, which is the default, then you must enter file names manually or accept the suggested file name by pressing Enter.
- Specifying the AUTOMATIC keyword as an option of the RECOVER command.

In either case, no interaction is required when you issue the RECOVER command if the necessary files are in the correct locations with the correct names. When the database successfully applies a redo log file, the following message is returned:

```
Log applied.
```

You are then prompted for the next redo log in the sequence. If the most recently applied log is the last required log, then recovery is terminated.

The file names used for automatic recovery are derived from the concatenated values of LOG_ARCHIVE_FORMAT with LOG_ARCHIVE_DEST_ *n*, where *n* is the highest value among all enabled, local destinations. For example, assume that the following initialization parameter settings are in effect in the database instance:

```
LOG_ARCHIVE_DEST_1 = "LOCATION=/arc_dest/loc1/"
LOG_ARCHIVE_DEST_2 = "LOCATION=/arc_dest/loc2/"
LOG_ARCHIVE_DEST_STATE_1 = DEFER
LOG_ARCHIVE_DEST_STATE_2 = ENABLE
LOG_ARCHIVE_FORMAT = arch_%t_%s_%r.arc
```

In this example, SQL*Plus automatically suggests the file name /arc_dest/loc2/arch_%t_%s_%r.arc (where %t is the thread, %s is the sequence and %r is the resetlogs ID).

See Also:

- [Automatic Recovery with SET AUTORECOVERY](#) (page 30-7)
 - [Automatic Recovery with the AUTOMATIC Option of the RECOVER Command](#) (page 30-8)
-
-

30.2.2.1 Automatic Recovery with SET AUTORECOVERY

After restoring data file backups, you can run the SET AUTORECOVERY ON command to enable automatic recovery. For example, you could enter the following commands in SQL*Plus to perform automatic recovery and open the database:

```
STARTUP MOUNT
SET AUTORECOVERY ON
```

```
RECOVER DATABASE
ALTER DATABASE OPEN;
```

Note:

After issuing the SQL*Plus RECOVER command, you can view all files that have been considered for recovery in the V\$RECOVERY_FILE_STATUS view. You can access status information for each file in the V\$RECOVERY_STATUS view. These views are not accessible after you terminate the recovery session.

30.2.2.2 Automatic Recovery with the AUTOMATIC Option of the RECOVER Command

Besides using SET AUTORECOVERY to turn on automatic recovery, you can also simply specify the AUTOMATIC keyword in the RECOVER command. For example, you could enter the following commands in SQL*Plus to perform automatic recovery and open the database:

```
STARTUP MOUNT
RECOVER AUTOMATIC DATABASE
ALTER DATABASE OPEN;
```

If you use an Oracle Real Application Clusters configuration, and if you are performing incomplete recovery or using a backup control file, then the database can only compute the name of the first archived redo log file from the *first* redo thread. You may have to manually apply the first log file from the other redo threads. After the first log file in a given thread has been supplied, the database can suggest the names of the subsequent logs in this thread.

30.2.3 Recovery When Archived Logs Are in the Default Location

No additional setup is required to perform recovery when the archived redo log files are present in the default location.

During recovery, as a log is needed, the database suggests the file name. If you run nonautomatic media recovery with SQL*Plus, then the output is displayed in the format shown by this example:

```
ORA-00279: change 53577 generated at 11/26/02 19:20:58 needed for thread 1
ORA-00289: suggestion : /oracle/oradata/trgt/arch/arcr_1_802.arc
ORA-00280: change 53577 for thread 1 is in sequence #802
Specify log: [<RET> for suggested | AUTO | FROM logsource | CANCEL ]
```

Similar messages are returned when you use an ALTER DATABASE . . . RECOVER statement. However, no prompt is displayed.

The database constructs suggested archived log file names by concatenating the current values of the initialization parameters LOG_ARCHIVE_DEST_ *n* (where *n* is the highest value among all enabled, local destinations) and LOG_ARCHIVE_FORMAT and using log history data from the control file. The following are possible settings:

```
LOG_ARCHIVE_DEST_1 = 'LOCATION = /oracle/oradata/trgt/arch/'
LOG_ARCHIVE_FORMAT = arcr_%t_%s.arc
```

```
SELECT NAME FROM V$ARCHIVED_LOG;
```

```
NAME
-----
```

```

/oracle/oradata/trgt/arch/arcr_1_467.arc
/oracle/oradata/trgt/arch/arcr_1_468.arc
/oracle/oradata/trgt/arch/arcr_1_469.arc

```

Thus, if all the required archived log files are present at the LOG_ARCHIVE_DEST_1 destination, and if the value for LOG_ARCHIVE_FORMAT is never altered, then the database can suggest and apply log files to complete media recovery automatically.

30.2.4 Recovery When Archived Logs Are in a Nondefault Location

To perform media recovery when archived redo log files are stored in a nondefault location, you must specify the location of archived redo log files.

You have the following mutually exclusive options when performing media recovery when archived logs are not in their default location:

- Edit the LOG_ARCHIVE_DEST_1 parameter that specifies the location of the archived redo logs, then recover as usual.
This task is described in [Resetting the Archived Log Destination](#) (page 30-9).
- Use the SET statement in SQL*Plus to specify the nondefault log location before recovery, or the LOGFILE parameter of the RECOVER command.
This task is described in [Overriding the Archived Log Destination](#) (page 30-9).

30.2.4.1 Resetting the Archived Log Destination

You can edit the initialization parameter file or issue ALTER SYSTEM statements to change the default location of the archived redo logs.

To change the default archived log location before recovery:

1. Use an operating system utility to restore the archived logs to a nondefault location. For example, enter:

```
% cp /backup/arch/* /tmp/
```

2. Change the value for the archive log parameter to the nondefault location. You can issue ALTER SYSTEM statements while the instance is started, or edit the initialization parameter file and then start the database instance. For example, while the instance is shut down edit the parameter file as follows:

```
LOG_ARCHIVE_DEST_1 = 'LOCATION=/tmp/'
LOG_ARCHIVE_FORMAT = arcr_%t_%s.arc
```

3. Using SQL*Plus, start a new instance by specifying the edited initialization parameter file, and then mount the database. For example, enter:

```
STARTUP MOUNT
```

4. Begin media recovery as usual. For example, enter:

```
RECOVER DATABASE
```

30.2.4.2 Overriding the Archived Log Destination

In some cases, you may want to override the current setting for the archiving destination parameter as a source for archived log files.

To recover archived logs in a nondefault location with SET LOGSOURCE:

1. Using an operating system utility, copy the archived redo logs to an alternative location. For example, enter:

```
% cp $ORACLE_HOME/oradata/trgt/arch/* /tmp
```

2. Specify the alternative location within SQL*Plus for the recovery operation. Use the LOGSOURCE parameter of the SET statement. For example, start SQL*Plus and run:

```
SET LOGSOURCE "/tmp"
```

3. Recover the offline tablespace. For example, to recover the offline tablespace users do the following:

```
RECOVER AUTOMATIC TABLESPACE users
```

4. Alternatively, you can avoid running SET LOGSOURCE and simply run:

```
RECOVER AUTOMATIC TABLESPACE users FROM "/tmp"
```

Note:

Overriding the redo log source does not affect the archive redo log destination for online redo log groups being archived.

30.2.5 Recovery Using Storage Snapshot Optimization

Storage Snapshot Optimization enables you to use third-party snapshots of the database, taken when the database is not in backup mode, to recover the database either to the current time or to a specified point in time after the snapshot was created. If the database was not placed in backup mode when the storage snapshot was created, then you can perform recovery using this snapshot only if the snapshot conforms to Oracle requirements. See ["Making Backups with Third-Party Snapshot Technologies" \(page 29-22\)](#). If these conditions are met, then you can take the same basic recovery steps as any other backup method, using either RMAN or SQL*Plus.

If the storage snapshot does not conform to the requirements for using Storage Snapshot Optimization, then you create a snapshot by placing the data files in backup mode. To perform recovery using such snapshots, use the procedure described in [Performing Complete Database Recovery Using SQL*Plus \(page 30-12\)](#) or [Performing Incomplete Database Recovery \(page 30-20\)](#).

Specifying the Time for Snapshot Recovery

If a storage snapshot was created when the database was not in backup mode, you must specify the SNAPSHOT TIME option while using this snapshot to recover the database. The SNAPSHOT TIME option can be used in both the RMAN or SQL*Plus RECOVER command. The time specified using the SNAPSHOT TIME option must be a time that is immediately after the snapshot is complete. If you specify an incorrect time, then the database may be corrupt in a way that is not repairable.

Because the time clocks in the storage array, where the snapshot takes place, and the machine hosting the Oracle Database may not be perfectly synchronized, it is recommended that you add a few seconds to the time that you specify in the SNAPSHOT TIME option. This helps you avoid any possibility of leaving the files in an inconsistent state by recovering to a point before the snapshot was taken.

All times specified in the RECOVER command, including in the SNAPSHOT TIME clause, are assumed to be in the time zone of the Oracle Database host. However, the

time clocks in the storage array may be in a different time zone from the Oracle Database host. If the storage array reports its snapshot times in a different time zone, then you must take that difference into account when specifying the time in the `SNAPSHOT TIME` option.

Note:

The recovery point, specified by the `UNTIL` option, cannot be earlier than the specified `SNAPSHOT TIME`.

Examples: Recovery Using Storage Snapshots

The examples in this section use the `RECOVER DATABASE` command to perform recovery using snapshots. You can use the `RECOVER DATABASE` command from `RMAN` or `SQL*Plus`. However, the `UNTIL CANCEL` clause is valid only in `SQL*Plus`.

To completely recover a database:

```
RECOVER DATABASE;
```

To recover a database using a particular snapshot:

This example recovers uses a snapshot taken on August 15 at 2:00 P.M. to recover the database. The `UNTIL TIME` clause can specify any time after the snapshot.

```
RECOVER DATABASE UNTIL TIME '10/15/2012 15:00:00' SNAPSHOT TIME '10/15/2012
14:00:00';
```

To perform a partial recovery using archived redo log files:

This example uses the log files from a snapshot taken on August 15 at 2:00 P.M.

```
RECOVER DATABASE UNTIL CANCEL SNAPSHOT TIME '10/15/2012 14:00:00';
```

30.2.6 Recovery Cancellation During User-Managed Recovery

If you start media recovery and must then interrupt it, then either enter `CANCEL` when prompted for a redo log file, or use your operating system's interrupt signal if you must terminate when recovering an individual data file, or when automated recovery is in progress. After recovery is canceled, you can resume it later with the `RECOVER` command. Recovery resumes where it left off when it was canceled.

30.2.7 Parallel Media Recovery

By default, Oracle Database uses **parallel media recovery** to improve performance of the roll forward phase of media recovery. In parallel recovery of media, the database uses a "division of labor" approach to allocate different processes to different data blocks while rolling forward, thereby making the procedure more efficient. The number of processes used is derived from the `CPU_COUNT` initialization parameter, which by default equals the number of CPUs on the system. For example, if parallel recovery is performed on a system where `CPU_COUNT` is 4, and only one data file is recovered, then four spawned processes read blocks from the archive logs and apply redo.

Typically, media recovery is limited by data block reads and writes. Parallel recovery attempts to use all of the available I/O bandwidth of the system to improve performance. Unless there is a system I/O bottleneck or poor asynchronous I/O support, parallel recovery is likely to improve performance of recovery.

To override the default behavior of performing parallel recovery, use the SQL*Plus RECOVER command with the NOPARALLEL option, or RECOVER PARALLEL 0. The RECOVERY_PARALLELISM initialization parameter controls instance or crash recovery *only*. Media recovery is not affected by the value used for RECOVERY_PARALLELISM.

See Also:

*SQL*Plus User's Guide and Reference* for more information about the SQL*Plus RECOVER . . . PARALLEL and NOPARALLEL commands

30.3 Performing Complete Database Recovery Using SQL*Plus

Typically, you perform complete recovery of the database when a media failure has made one or more data files inaccessible. During complete database recovery, you use all available redo to recover the database to the current SCN.

The V\$RECOVER_FILE view indicates which files need recovery. Depending on the circumstances, you can either recover the whole database or recover individual tablespaces or data files. Because you do not have to open the database with the RESETLOGS option after complete recovery, you have the option of recovering some data files at one time and the remaining data files later.

The topics in this section describe the steps necessary to complete media recovery operations.

See Also:

- [Performing Closed Database Recovery](#) (page 30-12)
 - [Performing Open Database Recovery](#) (page 30-16)
 - [Performing Crash and Instance Recovery of CDBs](#) (page 30-19)
-

30.3.1 Performing Closed Database Recovery

When performing complete recovery while the database is not open, you can recover either all damaged data files in one operation or perform individual recovery of each damaged data file in separate operations.

This procedure assumes the following:

- The current control file is available.
- You have backups of all needed data files.
- All necessary archived redo logs are available.

To restore and recover damaged or missing data files:

1. If the database is open, query V\$RECOVER_FILE to determine which data files must be recovered and why they must be recovered.

If you are planning to perform complete recovery rather than point-in-time recovery, then you can recover only those data files that require recovery, rather than the whole database. For point-in-time recovery, you must restore and recover all data files, unless you perform RMAN TSPITR. You can also use Flashback

Database, but this procedure affects all data files and returns the entire database to a past time.

You can query the `V$RECOVER_FILE` view to list data files requiring recovery by data file number with their status and error information.

```
SELECT FILE#, ERROR, ONLINE_STATUS, CHANGE#, TIME
FROM V$RECOVER_FILE;
```

Note:

You cannot use `V$RECOVER_FILE` with a control file restored from backup or a control file that was re-created after the time of the media failure affecting the data files. A restored or re-created control file does not contain the information needed to update `V$RECOVER_FILE` accurately.

You can also perform useful joins by using the data file number and the `V$DATAFILE` and `V$TABLESPACE` views to get the data file and tablespace names.

The `ERROR` column identifies the problem for each file requiring recovery.

2. Query the `V$ARCHIVED_LOG` and `V$RECOVERY_LOG` views to determine which archived redo log files are needed.

`V$ARCHIVED_LOG` lists file names for all archived redo logs, whereas `V$RECOVERY_LOG` lists only the archived redo logs that the database needs to perform media recovery. The latter view also includes the probable names of the files based on the naming convention specified by using the `LOG_ARCHIVE_FORMAT` parameter.

Note:

`V$RECOVERY_LOG` is only populated when media recovery is required for a data file. Thus, this view is not useful for a planned recovery, such as recovery from a user error.

If a data file requires recovery, but no backup of the data file exists, then you need all redo generated starting from the time when the data file was added to the database.

3. If all archived logs are available in the default location, then skip to the Step 4.

If some archived logs must be restored, and if sufficient space is available, then restore the required archived redo log files to the location specified by `LOG_ARCHIVE_DEST_1`. The database locates the correct log automatically when required during media recovery. For example, you might enter a command such as the following on Linux or UNIX:

```
% cp /disk2/arch/* $ORACLE_HOME/oradata/trgt/arch
```

If sufficient space is not available, then restore some or all of the required archived redo log files to an alternative location.

4. If the database is open, then shut it down. For example:

```
SHUTDOWN IMMEDIATE
```

5. Inspect the media to determine the source of the problem.

If the hardware problem that caused the media failure was temporary, and if the data was undamaged (for example, a disk or controller power failure occurred), then no media recovery is required: start the database and resume normal operations.

If you cannot repair the problem, then proceed to the Step 6.

6. If the files are permanently damaged, then identify the most recent backups for the damaged files. Restore *only* the data files damaged by the media failure: do not restore undamaged data files or any online redo log files.

For example, if `ORACLE_HOME/oradata/trgt/users01.dbf` is the only damaged file, then you may find that `/backup/users01_10_24_02.dbf` is the most recent backup of this file. If you do not have a backup of a specific data file, then you may be able to create an empty replacement file that can be recovered.

7. Use an operating system utility to restore the data files to their default location or to a new location. For example, a Linux or UNIX user restoring `users01.dbf` to its default location might enter:

```
% cp /backup/users01_10_24_06.dbf $ORACLE_HOME/oradata/trgt/users01.dbf
```

Use the following guidelines when determining where to restore data file backups:

- If the hardware problem is repaired and you can restore the data files to their default locations, then restore the data files to their default locations and begin media recovery.
- If the hardware problem persists and you cannot restore data files to their original locations, then restore the data files to an alternative storage device. Indicate the new location of these files in the control file with the `ALTER DATABASE RENAME FILE` statement. See *Oracle Database Administrator's Guide*.
- If you are restoring a data file to a raw disk or partition, then the technique is basically the same as when you are restoring to a file on a file system. Be aware of the naming conventions for files on raw devices (which differ depending on the operating system), and use an operating system utility that supports raw devices.

8. Connect to the database with administrator privileges. Then start a new instance and mount, but do not open, the database. For example, enter:

```
STARTUP MOUNT
```

9. If you restored one or more damaged data files to alternative locations, then update the control file of the database to reflect the new data file names. For example, to change the file name of the data file in tablespace `users` you might enter:

```
ALTER DATABASE RENAME FILE '?/oradata/trgt/users01.dbf' TO
'/disk2/users01.dbf';
```

10. Obtain the data file names and statuses of all data files by checking the list of data files that normally accompanies the current control file or by querying the `V$DATAFILE` view. For example, enter:

```
SELECT NAME,STATUS FROM V$DATAFILE;
```

11. Ensure that all data files requiring recovery are online. The only exceptions are data files in an offline tablespace that was taken offline normally or data files in a read-only tablespace. For example, to guarantee that a data file named `/oracle/dbs/tbs_10.f` is online, enter the following:

```
ALTER DATABASE DATAFILE '/oracle/dbs/tbs_10.f' ONLINE;
```

If a specified data file is already online, then the database ignores the statement. If you prefer, create a script to bring all data files online simultaneously, as in the following example:

```
SPOOL onlineall.sql
SELECT 'ALTER DATABASE DATAFILE '''||name||''' ONLINE;' FROM V$DATAFILE;
SPOOL OFF
```

```
SQL> @onlineall
```

12. If you restored archived redo logs to an alternative location, then you can specify the location before media recovery with the `LOGSOURCE` parameter of the `SET` command in SQL*Plus. For example, if the logs are staged in `/tmp`, you can enter the following command:

```
SET LOGSOURCE /tmp
```

Alternatively, you can skip Step 12 and use the `FROM` parameter on the `RECOVER` command as in Step 13. For example, if the logs are staged in `/tmp`, you can enter the following command:

```
RECOVER AUTOMATIC FROM '/tmp' DATABASE
```

Note:

Overriding the redo log source does not affect the archive redo log destination for online redo log groups being archived.

13. Issue a statement to recover the database, tablespace, or data file. For example, enter one of the following `RECOVER` commands:

```
RECOVER AUTOMATIC DATABASE      # whole database
RECOVER AUTOMATIC TABLESPACE users # specific tablespace
RECOVER AUTOMATIC DATAFILE '?/oradata/trgt/users01.dbf'; # specific data file
```

If you choose not to automate the application of archived redo logs, then you must accept or reject each prompted log. If you automate recovery, then the database applies the logs automatically. Recovery continues until all required archived and online redo logs have been applied to the restored data files. The database notifies you when media recovery is complete:

```
Media recovery complete.
```

If no archived redo logs are required for complete media recovery, then the database applies all necessary online redo log files and terminates recovery.

14. After recovery terminates, open the database for use:

```
ALTER DATABASE OPEN;
```

15. After archived logs are applied, and after making sure that a copy of each archived log group still exists in offline storage, delete the restored copy of the archived redo log file to free disk space. For example:

```
% rm /tmp/*.arc
```

See Also:

- ["Recovering After the Loss of All Current Control Files \(page 31-2\)"](#) and ["Re-Creating a Control File \(page 31-7\)"](#) for information about restoring or re-creating the control file
 - ["Re-Creating Data Files When Backups Are Unavailable \(page 31-10\)"](#) for information about performing recovery when data file backups are missing
 - ["Performing Incomplete Database Recovery \(page 30-20\)"](#) for information about performing database point-in-time recovery when you are missing redo required to completely recover the database
 - ["Overview of User-Managed Media Recovery \(page 30-5\)"](#) for an overview of log application during media recovery
-

30.3.2 Performing Open Database Recovery

You can perform complete recovery of non-SYSTEM data files in a database while the database is open.

This procedure assumes the following:

- The current control file is available.
- You have backups of all needed data files.
- All necessary archived redo logs are available.

It is possible for a media failure to occur while the database remains open, leaving the undamaged data files online and available for use. Damaged data files—but not the tablespaces that contain them—are automatically taken offline if the database writer cannot write to them. If the database writer cannot open a data file, an error is still returned. Queries that cannot read damaged files return errors, but the data files are not taken offline because of the failed queries. For example, you may run a SQL query and see output such as:

```
ERROR at line 1:  
ORA-01116: error in opening database file 3  
ORA-01110: data file 11: '/oracle/oradata/trgt/cwmlite02.dbf'  
ORA-27041: unable to open file  
SVR4 Error: 2: No such file or directory  
Additional information: 3
```

Note:

You cannot use the procedure in this section to perform complete media recovery on the SYSTEM tablespace while the database is open. If the media failure damages data files of the SYSTEM tablespace, then the database automatically shuts down.

To restore data files in an open database:

1. Follow Step 1 (page 30-12) through Step 3 (page 30-13) in "Performing Closed Database Recovery (page 30-12)".
2. If the database is open, then take all tablespaces containing damaged data files offline. For example, if the tablespaces USERS and TOOLS contain damaged data files, then execute the following SQL statements:

```
ALTER TABLESPACE users OFFLINE TEMPORARY;
ALTER TABLESPACE tools OFFLINE TEMPORARY;
```

If you specify TEMPORARY, then Oracle Database creates a [checkpoint](#) for all online data files in the tablespace. Files that are offline when you issue this statement may require media recovery before you bring the tablespace back online. If you specify IMMEDIATE, then you must perform media recovery on the tablespace before bringing it back online.

3. Inspect the media to determine the source of the problem.

You can use the DBVERIFY utility to run an integrity check on offline data files.

If the hardware problem that caused the media failure was temporary, and if the data was undamaged, then no media recovery is required. You can bring the offline tablespaces online and resume normal operations. If you cannot repair the problem, or if DBVERIFY reports corrupt blocks, then proceed to the Step 4.

4. If files are permanently damaged, then use operating system commands to restore the most recent backup files of *only* the data files damaged by the media failure. For example, to restore users01.dbf you might use the cp command on Linux or UNIX as follows:

```
% cp /disk2/backup/users01.dbf $ORACLE_HOME/oradata/trgt/users01.dbf
```

If the hardware problem is fixed and the data files can be restored to their original locations, then do so. Otherwise, restore the data files to an alternative storage device. Do not restore undamaged data files, online redo logs, or control files.

Note:

In some circumstances, if you do not have a backup of a specific data file, you can use the ALTER DATABASE CREATE DATAFILE statement to create an empty replacement file that is recoverable.

5. If you restored one or more damaged data files to alternative locations, then update the control file of the database to reflect the new data file names. For example, to change the file name of the data file in tablespace users you might enter:

```
ALTER DATABASE RENAME FILE '?/oradata/trgt/users01.dbf' TO
'/disk2/users01.dbf';
```

6. If you restored archived redo logs to an alternative location, then you can specify the location before media recovery with the LOGSOURCE parameter of the SET command in SQL*Plus. For example, if the logs are staged in /tmp, you can enter the following command:

```
SET LOGSOURCE /tmp
```

Alternatively, you can skip Step 6 and use the FROM parameter on the RECOVER command as in Step 7. For example, if the logs are staged in /tmp, you can enter the following command:

```
RECOVER AUTOMATIC FROM '/tmp' TABLESPACE users, tools;
```

Note:

Overriding the redo log source does not affect the archive redo log destination for online redo log groups being archived.

7. Connect to the database with administrator privileges, and start offline tablespace recovery of all damaged data files in one or more offline tablespaces using one step. For example, recover users and tools as follows:

```
RECOVER AUTOMATIC TABLESPACE users, tools;
```

The database begins the roll forward phase of media recovery by applying the necessary archived and online redo logs to reconstruct the restored data files. Unless the application of files is automated with the RECOVER AUTOMATIC or SET AUTORECOVERY ON commands, the database prompts for each required redo log file.

Recovery continues until all required archived logs have been applied to the data files. The online redo logs are then automatically applied to the restored data files to complete media recovery. If no archived redo logs are required for complete media recovery, then the database does not prompt for any. Instead, all necessary online redo logs are applied, and media recovery is complete.

8. When the damaged tablespaces are recovered up to the moment that media failure occurred, bring the offline tablespaces online. For example, to bring tablespaces USERS and TOOLS online, issue the following statements:

```
ALTER TABLESPACE users ONLINE;
ALTER TABLESPACE tools ONLINE;
```

See Also:

- *Oracle Database Administrator's Guide* to learn about creating data files and *Oracle Database SQL Language Reference* to learn about ALTER DATABASE RENAME FILE
 - "[Running the DBVERIFY Utility](#) (page 29-23)"
 - "[Recovering After the Loss of All Current Control Files](#) (page 31-2)" and "[Re-Creating a Control File](#) (page 31-7)" for information about restoring or re-creating the control file
 - "[Re-Creating Data Files When Backups Are Unavailable](#) (page 31-10)" for information about performing recovery when data file backups are missing
 - "[Performing Incomplete Database Recovery](#) (page 30-20)" for information about performing database point-in-time recovery when you are missing redo required to completely recover the database
-

30.3.3 Performing Crash and Instance Recovery of CDBs

Oracle Database performs crash and instance recovery for the entire multitenant container database (CDB). You cannot recover individual pluggable databases (PDBs).

This procedure assumes the following:

- The current control file is available.
- You have backups of all needed data files.
- All necessary archived redo logs are available.

To perform crash and instance recovery for a CDB:

1. Open a SQL client such as SQL*Plus.
2. Connect to the [root](#) as a common user with the ALTER PLUGGABLE DATABASE system privilege.
3. Follow the procedures in "[Performing Closed Database Recovery](#) (page 30-12)".

If you do not want to recover a particular PDB, take its files offline.

See Also:

- ["Recovering After the Loss of All Current Control Files \(page 31-2\)"](#) and ["Re-Creating a Control File \(page 31-7\)"](#) for information about restoring or re-creating the control file
 - ["Re-Creating Data Files When Backups Are Unavailable \(page 31-10\)"](#) for information about performing recovery when data file backups are missing
 - ["Performing Incomplete Database Recovery \(page 30-20\)"](#) for information about performing database point-in-time recovery when you are missing redo required to completely recover the database
-

30.4 Performing Incomplete Database Recovery

Incomplete recovery is also known as database point-in-time recovery.

Typically, you perform [database point-in-time recovery \(DBPITR\)](#) in the following situations:

- You want to recover the database to an SCN before a user or administrative error.
- The database contains corrupt blocks.
- Complete database recovery failed because all necessary archived redo logs were not available.
- You are creating a test database or a reporting database from production database backups.

If the database is operating in ARCHIVELOG mode, and if the only copy of an archived redo log file is damaged, then the damaged file does not affect the present operation of the database. [Table 30-2](#) (page 30-20) describes situations that can arise depending on when the redo log was written and when you backed up the data file.

Table 30-2 Loss of Archived Redo Logs

If You Backed Up...	Then...
All data files after the filled online redo log group (which is now archived) was written	The archived version of the filled online redo log group is not required for complete media recovery.
A specific data file before the filled online redo log group was written	If the corresponding data file is damaged by a permanent media failure, then use the most recent backup of the damaged data file and perform tablespace point-in-time recovery of the damaged data file, up to the damaged archived redo log file.

Caution:

If you know that an archived redo log group has been damaged, then immediately back up all data files so that you have a whole database backup that does not require the damaged archived redo log.

The technique for DBPITR is very similar to the technique for performing closed database recovery, except that you terminate DBPITR by specifying a particular time or SCN or entering `CANCEL`. Cancel-based recovery prompts you with the suggested file names of archived redo logs. Recovery stops when you specify `CANCEL` instead of a file name or when all redo has been applied to the data files. Cancel-based recovery is the best technique to control which archived log terminates recovery.

See Also:

- ["Performing Cancel-Based Incomplete Recovery \(page 30-21\)"](#)
 - ["Performing Time-Based or Change-Based Incomplete Recovery \(page 30-23\)"](#)
 - ["Performing Closed Database Recovery \(page 30-12\)"](#)
-
-

30.4.1 Performing Cancel-Based Incomplete Recovery

In cancel-based recovery, recovery proceeds by prompting you with the suggested file names of archived redo log files. Recovery stops when you specify `CANCEL` instead of a file name or when all redo has been applied to the data files.

This procedure assumes the following:

- The current control file is available.
- You have backups of all needed data files.

To perform cancel-based recovery:

1. Follow Step 1 (page 30-12) through Step 8 (page 30-14) in ["Performing Closed Database Recovery \(page 30-12\)"](#).
2. Begin cancel-based recovery by issuing the following command in SQL*Plus:

```
RECOVER DATABASE UNTIL CANCEL
```

Note:

If you fail to specify the `UNTIL` clause on the `RECOVER` command, then the database assumes a complete recovery and does not open until all redo is applied.

The database applies the necessary redo log files to reconstruct the restored data files. The database supplies the name it expects to find from `LOG_ARCHIVE_DEST_1` and requests you to stop or proceed with applying the log file. If the control file is a backup, then you must supply the names of the online redo logs if you want to apply the changes in these logs.

3. Continue applying redo log files until the last log has been applied to the restored data files, then cancel recovery by executing the following command:

```
CANCEL
```

The database indicates whether recovery is successful. If you cancel before all the data files have been recovered to a consistent SCN and then try to open the database, then you get an ORA-1113 error if more recovery is necessary. You can query `V$RECOVER_FILE` to determine whether more recovery is needed, or if a backup of a data file was not restored before starting incomplete recovery.

4. Open the database with the `RESETLOGS` option. You must always reset the logs after incomplete recovery or recovery with a backup control file. For example:

```
ALTER DATABASE OPEN RESETLOGS;
```

If you attempt to use `OPEN RESETLOGS` when you should not, or if you neglect to reset the log when you should, then the database returns an error and does not open the database. Correct the problem and try again.

5. After opening the database with the `RESETLOGS` option, check the alert log.

Note:

The easiest way to locate trace files and the alert log is to run the following SQL query: `SELECT NAME, VALUE FROM V$DIAG_INFO.`

When you open with the `RESETLOGS` option, the database returns different messages depending on whether recovery was complete or incomplete. If the recovery was complete, then the following message appears in the alert log:

```
RESETLOGS after complete recovery through change scn
```

If the recovery was incomplete, then this message is reported in the alert log, where `scn` refers to the end point of incomplete recovery:

```
RESETLOGS after incomplete recovery UNTIL CHANGE scn
```

Also check the alert log to determine whether the database detected inconsistencies between the data dictionary and the control file. [Table 30-3](#) (page 30-22) describes two possible scenarios.

Table 30-3 Inconsistencies Between Data Dictionary and Control File

Data File Listed in Control File	Data File Listed in the Data Dictionary	Result
Yes	No	References to the unlisted data file are removed from the control file. A message in the alert log indicates what was found.
No	Yes	The database creates a placeholder entry in the control file under <code>MISSINGnnnnn</code> (where <code>nnnnn</code> is the file number in decimal). <code>MISSINGnnnnn</code> is flagged in the control file as offline and requiring media recovery. You can make the data file corresponding to <code>MISSINGnnnnn</code> accessible by using <code>ALTER DATABASE RENAME FILE</code> for <code>MISSINGnnnnn</code> so that it points to the data file. If you do not have a backup of this data file, then drop the tablespace.

See Also:

- "[About User-Managed Media Recovery Problems](#) (page 30-25)" for descriptions of situations that can cause ALTER DATABASE OPEN RESETLOGS to fail
 - "[Recovering After the Loss of All Current Control Files](#) (page 31-2)" for information about restoring or re-creating the control file
 - "[Re-Creating Data Files When Backups Are Unavailable](#) (page 31-10)" for information about performing recovery when data file backups are missing
-

30.4.2 Performing Time-Based or Change-Based Incomplete Recovery

You can specify an SCN or time for the end point of incomplete recovery.

If your database is affected by seasonal time changes (for example, daylight savings time), then you may experience a problem if a time appears twice in the redo log and you want to recover to the second, or later time. To handle time changes, perform cancel-based or change-based recovery.

This procedure assumes the following:

- The current control file is available.
- You have backups of all needed data files.

To perform change-based or time-based recovery:

1. Follows Step 1 (page 30-12) through Step 8 (page 30-14) in "[Performing Closed Database Recovery](#) (page 30-12)".
2. Issue the RECOVER DATABASE UNTIL statement to begin recovery. If recovering to an SCN, then specify as a decimal number without quotation marks. For example, to recover through SCN 10034 issue:

```
RECOVER DATABASE UNTIL CHANGE 10034;
```

If recovering to a time, then the time is always specified using the following format, delimited by single quotation marks: 'YYYY-MM-DD:HH24:MI:SS'. The following statement recovers the database up to a specified time:

```
RECOVER DATABASE UNTIL TIME '2000-12-31:12:47:30'
```

3. Apply the necessary redo log files to recover the restored data files. The database automatically terminates the recovery when it reaches the correct time, and returns a message indicating whether recovery is successful.

Note:

Unless recovery is automated, the database supplies the name from LOG_ARCHIVE_DEST_1 and asks you to stop or proceed with after each log. If the control file is a backup, then after the archived logs are applied you must supply the names of the online logs.

- Follow Steps 4 (page 30-22) and 5 (page 30-22) in "Performing Cancel-Based Incomplete Recovery (page 30-21)".

See Also:

- "Recovering After the Loss of All Current Control Files (page 31-2)" for information about restoring or re-creating the control file
 - "Re-Creating Data Files When Backups Are Unavailable (page 31-10)" for information about performing recovery when data file backups are missing
-
-

30.5 Recovering a Database in NOARCHIVELOG Mode

If a media failure damages data files in a NOARCHIVELOG database, then the only option for recovery is usually to restore a consistent whole database backup. If you are using logical backups created by Oracle Data Pump Export to supplement regular physical backups, then you can also attempt to restore the database by importing an exported backup of the database into a re-created database or a database restored from an old backup.

To restore and recover the most recent whole database backup:

- If the database is open, then shut down the database. For example, enter:

```
SHUTDOWN IMMEDIATE
```

- If possible, correct the media problem so that the backup database files can be restored to their original locations.
- Restore the most recent whole database backup with operating system commands. Restore all of the data files and control files of the whole database backup, not just the damaged files. If the hardware problem has not been corrected and some or all of the database files must be restored to alternative locations, then restore the whole database backup to a new location. The following example restores a whole database backup to its default location:

```
% cp /backup/*.dbf $ORACLE_HOME/oradata/trgt/
```

- If necessary, edit the restored initialization parameter file to indicate the new location of the control files. For example:

```
CONTROL_FILES = "/new_disk/oradata/trgt/control01.dbf"
```

- Start an instance using the restored and edited parameter file and mount, but do not open, the database. For example:

```
STARTUP MOUNT
```

- If the restored data file names are different (such as when you restore to a different file system or directory, on the same node or a different node), then update the control file to reflect the new data file locations. For example, to rename data file 1 you might enter:

```
ALTER DATABASE RENAME FILE '?/oradata/trgt/system01.dbf' TO
'/new_disk/oradata/system01.dbf' ;
```

7. If the online redo logs were located on a damaged disk, and the hardware problem is not corrected, then specify a new location for each affected online log. For example, enter:

```
ALTER DATABASE RENAME FILE '?/oradata/trgt/redo01.log' TO
                          '/new_disk/oradata/redo_01.log';
ALTER DATABASE RENAME FILE '?/oradata/trgt/redo02.log' TO
                          '/new_disk/oradata/redo_02.log';
```

8. Because online redo logs are never backed up, you cannot restore them with the data files and control files. To enable the database to reset the online redo logs, you must first mimic incomplete recovery:

```
RECOVER DATABASE UNTIL CANCEL
CANCEL
```

9. Open the database in RESETLOGS mode. This command clears the online redo logs and resets the log sequence to 1:

```
ALTER DATABASE OPEN RESETLOGS;
```

If you restore a NOARCHIVELOG database backup and then reset the log, the action discards all changes to the database made from the time the backup was taken to the time of the failure.

See Also:

Oracle Database Administrator's Guide for more information about renaming and relocating data files, and *Oracle Database SQL Language Reference* to learn about ALTER DATABASE RENAME FILE

30.6 Troubleshooting Media Recovery

This section describes how to troubleshoot user-managed media recovery, that is, media recovery performed without using Recovery Manager (RMAN). This section includes the following topics:

- [About User-Managed Media Recovery Problems](#) (page 30-25)
- [Investigating the Media Recovery Problem: Phase 1](#) (page 30-28)
- [Trying to Fix the Recovery Problem Without Corrupting Blocks: Phase 2](#) (page 30-28)
- [Deciding Whether to Allow Recovery to Mark as Corrupt Blocks: Phase 3](#) (page 30-30)
- [Allowing Recovery to Corrupt Blocks: Phase 4](#) (page 30-31)
- [Performing Trial Recovery](#) (page 30-32)

30.6.1 About User-Managed Media Recovery Problems

[Table 30-4](#) (page 30-26) describes potential problems that can occur during media recovery.

Table 30-4 Media Recovery Problems

Problem	Description
Missing or misnamed archived log	Recovery stops because the database cannot find the archived log recorded in the control file.
When you attempt to open the database, error ORA-1113 indicates that a data file needs media recovery.	<p>This error commonly occurs because:</p> <ul style="list-style-type: none"> • You are performing incomplete recovery but failed to restore all needed data file backups. • Incomplete recovery stopped before data files reached a consistent SCN. • You are recovering data files from an online backup, but not enough redo was applied to make the data files consistent. • You are performing recovery with a backup control file, and did not specify the location of a needed online redo log. • A data file is undergoing media recovery when you attempt to open the database. • Data files needing recovery were not brought online before you execute the RECOVER DATABASE command, and so were not recovered.
Redo record problems	<p>Two possible cases are as follows:</p> <ul style="list-style-type: none"> • Recovery stops because of failed consistency checks, a problem called stuck recovery. Stuck recovery can occur when an underlying operating system or storage system loses a write issued by the database during normal operation. • The database signals an internal error when applying the redo. This problem can be caused by an Oracle Database bug. If checksum verification is not being used, then the errors can also be caused by corruptions to the redo or data blocks.
Corrupted archived logs	Logs may be corrupted while they are stored on or copied between storage systems. If DB_BLOCK_CHECKSUM is enabled, then the database usually signals a checksum error. If checksum checking is disabled, then log corruption may appear as a problem with redo.
Archived logs with incompatible parallel redo format	If you enable the parallel redo feature, then the database generates redo logs in a new format. Prior releases of Oracle are unable to apply parallel redo logs. However, releases before Oracle9i Database Release 2 (9.2) can detect the parallel redo format and indicate the inconsistency with the following error message: External error 00303, 00000, "cannot process Parallel Redo".
Corrupted data blocks	A data file backup may have contained a corrupted data block, or the data block may become corrupted either during recovery or when it is copied to the backup. If DB_BLOCK_CHECKSUM is enabled, then the database computes a checksum for each block during normal operations and stores it in the block before writing it to disk. When the database reads the block from disk later, it recomputes the checksum and compares it to the stored value. If they do not match, then the database signals a checksum error. If checksum checking is disabled, then the problem may also appear as a redo corruption.

Table 30-4 (Cont.) Media Recovery Problems

Problem	Description
Random problems	Memory corruptions and other transient problems can occur during recovery.

The symptoms of media recovery problems are usually external or internal errors signaled during recovery. For example, an external error indicates that a redo block or a data block has failed checksum verification checks. Internal errors can be caused by either bugs in the database or errors arising from the underlying operating system and hardware.

If media recovery encounters a problem while recovering a database backup, then whether it is a stuck recovery problem or a problem during redo application, the database always stops and leaves the data files undergoing recovery in a consistent state, that is, at a consistent SCN preceding the failure. You can then do one of the following:

- Open the database read-only to investigate the problem.
- Open the database with the RESETLOGS option, if the requirements for opening RESETLOGS have been met. The RESETLOGS restrictions apply to opening the [physical standby database](#) as well, because a standby database is updated by a form of media recovery.

In general, opening the database read-only or opening with the RESETLOGS option requires all online data files to be recovered to the same SCN. If this requirement is not met, then the database may signal ORA-1113 or other errors when you attempt to open it. Some common causes of ORA-1113 are described in [Table 30-4](#) (page 30-26).

The basic methodology for responding to media recovery problems occurs in the following phases:

1. Try to identify the cause of the problem. Run a trial recovery if needed.
2. If the problem is related to missing redo logs or if you suspect that there is a redo log, memory, or data block corruption, then try to resolve the problem using the methods described in [Table 30-5](#) (page 30-28).
3. If you cannot resolve the problem using the methods described in [Table 30-5](#) (page 30-28), then do one of the following:
 - Open the database with the RESETLOGS option if you are recovering a whole database backup. If you have performed serial media recovery, then the database contains all the changes up to but not including the changes at the SCN where the corruption occurred. No changes from this SCN onward are in the recovered part of the database. If you have restored online backups, then opening RESETLOGS succeeds only if you have recovered through all the ALTER . . . END BACKUP operations in the redo stream.
 - Proceed with recovery by allowing media recovery to corrupt data blocks. After media recovery completes, try performing [block media recovery](#) using RMAN.
 - Call Oracle Support Services as a last resort.

See Also:

"[Performing Disaster Recovery](#) (page 20-9)" to learn about block media recovery

30.6.2 Investigating the Media Recovery Problem: Phase 1

If media recovery encounters a problem, then obtain as much information as possible after recovery halts. You do not want to waste time fixing the wrong problem, which may make matters worse.

The goal of this initial investigation is to determine whether the problem is caused by incorrect setup, corrupted redo logs, corrupted data blocks, memory corruption, or other problems. If you see a [checksum](#) error on a data block, then the data block is corrupted. If you see a checksum error on a redo log block, then the redo log is corrupted.

Sometimes the cause of a recovery problem can be difficult to determine. Nevertheless, the methods in this section enable you to quickly recover a database even when you do not completely understand the cause of the problem.

To investigate media recovery problems:

1. Examine the `alert.log` to see whether the error messages give general information about the nature of the problem. For example, does the `alert_SID.log` indicate any checksum failures? Does the `alert_SID.log` indicate that media recovery may have to corrupt data blocks to continue?
2. Check the trace file generated by the Oracle Database during recovery. It may contain additional error information.

30.6.3 Trying to Fix the Recovery Problem Without Corrupting Blocks: Phase 2

Depending on the type of media recovery problem you suspect, you have different solutions at your disposal. You can try one or a combination of the techniques described in [Table 30-5](#) (page 30-28). These solutions are common repair techniques and fairly safe for resolving most media recovery issues.

Table 30-5 Media Recovery Solutions

If You Suspect...	Then...
Missing or misnamed archived redo logs	Determine whether you entered the correct file name. If you did, then check whether the log is missing from the operating system. If it is missing, and if you have a backup, then restore the backup and apply the log. If you do not have a backup, then if possible perform incomplete recovery up to the point of the missing log.
ORA-1113 for ALTER DATABASE OPEN	Review the causes of this error in Table 30-4 (page 30-26). Ensure that all read/write data files requiring recovery are online. If you use a backup control file for recovery, then the control file and data files must be at a consistent SCN for the database to be opened. If you do not have the necessary redo, then you must re-create the control file.

Table 30-5 (Cont.) Media Recovery Solutions

If You Suspect...	Then...
Corrupt archived logs	<p>The log is corrupted if the checksum verification on the log redo block fails. If <code>DB_BLOCK_CHECKSUM</code> was not enabled either during the recovery session or when the database generated the redo, then recovery problems may be caused by corrupted logs. If the log is corrupt and an alternate copy of the corrupt log is available, then try to apply it and see whether this tactic fixes the problem.</p> <p>The <code>DB_BLOCK_CHECKSUM</code> initialization parameter determines whether checksums are computed for redo log and data blocks.</p>
Archived logs with incompatible parallel redo format	<p>If you run an Oracle Database release before Oracle9i Database Release 2, and if you attempt to apply redo logs created with the parallel redo format, then you must do the following steps:</p> <ol style="list-style-type: none"> 1. Upgrade the database to a later release. 2. Perform media recovery. 3. Shut down the database consistently and back up the database. 4. Downgrade the database to the original release.
Memory corruption or transient problems	<p>You may be able to fix the problem by shutting down the database and restarting recovery. The database should be left in a consistent state if the second attempt also fails.</p>
Corrupt data blocks	<p>Restore and recover the data file again with user-managed methods, or restore and recover individual data blocks with the <code>RMAN RECOVER . . . BLOCK</code> command. This technique may fix the problem.</p> <p>A data block is corrupted if the checksum verification on the block fails. If <code>DB_BLOCK_CHECKING</code> is disabled, then a corrupted data block problem may appear as a redo problem. If you must proceed with media recovery, then you may want to allow media recovery to mark the block as corrupt for now, continue recovery, and then use <code>RMAN</code> to perform block media recovery later.</p>

If you cannot fix the problem with the methods described in [Table 30-5](#) (page 30-28), then there may be no easy way to fix the problem without losing data. You have these options:

- Open the database with the `RESETLOGS` option (for whole database recovery).
This solution discards all changes after the point where the redo problem occurred, but guarantees a logically consistent database.
- Allow media recovery to corrupt one or more data blocks and then proceed.
This option only succeeds if the alert log indicates that recovery can continue if it is allowed to corrupt a data block, which is the case for most recovery problems. This option is best if you must bring up the database quickly and recover all changes. If you are considering this option, then proceed to "[Deciding Whether to Allow Recovery to Mark as Corrupt Blocks: Phase 3](#)" (page 30-30)".

See Also:

" [Performing Block Media Recovery](#) (page 19-1)" to learn how to perform block media recovery with the `RECOVER . . . BLOCK` command

30.6.4 Deciding Whether to Allow Recovery to Mark as Corrupt Blocks: Phase 3

When media recovery encounters a problem, the alert log may indicate that recovery can continue if it is allowed to mark as corrupt the data block causing the problem. The alert log contains information about the block: its block type, block address, the tablespace it belongs to, and so forth. For blocks containing user data, the alert log may also report the data object number.

In this case, the database can proceed with recovery if it is allowed to mark the problem block as corrupt. Nevertheless, this response is not always advisable. For example, if the block is an important block in the `SYSTEM` tablespace, marking the block as corrupt can eventually prevent you from opening the recovered database. Another consideration is whether the recovery problem is isolated. If this problem is followed immediately by many other problems in the redo stream, then you may want to open the database with the `RESETLOGS` option.

For a block containing user data, you can usually query the database to discover which object or table owns this block. If the database is not open, then you can open the database read-only, even if you are recovering a whole database backup. The following example cancels recovery and opens the database read-only:

```
CANCEL
ALTER DATABASE OPEN READ ONLY;
```

Assume that the data object number reported in the `alert_SID.log` is 8031. You can determine the owner, object name, and object type by issuing this query:

```
SELECT OWNER, OBJECT_NAME, SUBOBJECT_NAME, OBJECT_TYPE
FROM DBA_OBJECTS
WHERE DATA_OBJECT_ID = 8031;
```

To determine whether a recovery problem is isolated, you can run a diagnostic **trial recovery**, which scans the redo stream for problems but does not actually make any changes to the recovered database. If a trial recovery discovers any recovery problems, then it reports them in the `alert_SID.log`. You can use the `RECOVER . . . TEST` statement to invoke trial recovery, as described in "[Executing the RECOVER... TEST Statement](#) (page 30-33)".

After you have done these investigations, you can follow the guidelines in [Table 30-6](#) (page 30-31) to decide whether to allow recovery to permit corrupt blocks.

Table 30-6 Guidelines for Allowing Recovery to Permit Corrupt Blocks

If the Problem Is...	and the Block Is...	Then...
Not isolated		You can open the database with the <code>RESETLOGS</code> option. This response is important for stuck recovery problems, because stuck recovery can be caused by the operating system or a storage system losing writes. If an operating system or storage system suddenly fails, then it can cause stuck recovery problems on several blocks.
Isolated	In the <code>SYSTEM</code> tablespace	Do not corrupt the block, because it may eventually prevent you from opening the database. However, sometimes data in the <code>SYSTEM</code> tablespace is unimportant. If you must corrupt a <code>SYSTEM</code> block and recover all changes, then contact Oracle Support Services.
Isolated	Index data	Consider corrupting index blocks because the index can be rebuilt later after the database has been recovered.
Isolated	User data	Decide based on the importance of the data. If you continue with data file recovery and corrupt a block, then you lose data in the block. However, you can use <code>RMAN</code> to perform block media recovery later, after data file recovery completes. If you open <code>RESETLOGS</code> , then the database is consistent but loses any changes made after the point where recovery was stopped.
Isolated	Rollback or undo data	If all of the transactions are committed, then consider corrupting the rollback or undo block. The database is not harmed if the transactions that generated the undo are never rolled back. However, if those transactions are rolled back, then corrupting the undo block can cause problems. If you are unsure, then contact Oracle Support Services.

See Also:

"[Performing Trial Recovery](#) (page 30-32)" to learn how to perform trial recovery, and "[Allowing Recovery to Corrupt Blocks: Phase 4](#) (page 30-31)" if you decide to allow recovery to permit corrupt blocks

30.6.5 Allowing Recovery to Corrupt Blocks: Phase 4

If you decide to allow recovery to proceed despite block corruptions, then run the `RECOVER` command with the `ALLOW n CORRUPTION` clause, where *n* is the number of allowable corrupt blocks.

To allow recovery to corrupt blocks:

1. Ensure that all normal recovery preconditions are met. For example, if the database is open, then take tablespaces offline before attempting recovery.
2. Run the RECOVER command as in the following example:

```
RECOVER DATABASE ALLOW 5 CORRUPTION
```

30.6.6 Performing Trial Recovery

When problems such as stuck recovery occur, you have a difficult choice. If the block is relatively unimportant, and if the problem is isolated, then it is better to corrupt the block. But if the problem is not isolated, then it may be better to open the database with the RESETLOGS option.

Because of this situation, Oracle Database supports [trial recovery](#). A trial recovery applies redo in a way similar to normal media recovery, but it never writes its changes to disk and it always rolls back its changes. Trial recovery occurs only in memory.

This section contains the following topics:

- [How Trial Recovery Works](#) (page 30-32)
- [Executing the RECOVER... TEST Statement](#) (page 30-33)

See Also:

["Allowing Recovery to Corrupt Blocks: Phase 4](#) (page 30-31)"

30.6.6.1 How Trial Recovery Works

By default, if a trial recovery encounters a stuck recovery or similar problem, then it always marks the data block as corrupt in memory when this action can allow recovery to proceed. The database writes errors generated during trial recovery to alert files. These errors are clearly marked as test run errors.

Like normal media recovery, trial recovery can prompt you for archived log file names and ask you to apply them. Trial recovery ends when:

- The database runs out of the maximum number of buffers in memory that trial recovery is permitted to use
- An unrecoverable error is signaled, that is, an error that cannot be resolved by corrupting a data block
- You cancel or interrupt the recovery session
- The next redo record in the redo stream changes the control file
- All requested redo has been applied

When trial recovery ends, the database removes all effects of the test run from the system—except the possible error messages in the alert files. If the instance fails during trial recovery, then the database removes all effects of trial recovery from the system, because trial recovery never writes changes to disk.

Trial recovery lets you foresee what problems might occur if you were to continue with normal recovery. For problems caused by ongoing memory corruption, trial recovery and normal recovery can encounter different errors.

30.6.6.2 Executing the RECOVER... TEST Statement

You can use the TEST option for any RECOVER command. For example, you can start SQL*Plus and then issue any of the following commands:

```
RECOVER DATABASE TEST
RECOVER DATABASE USING BACKUP CONTROLFILE UNTIL CANCEL TEST
RECOVER TABLESPACE users TEST
RECOVER DATABASE UNTIL CANCEL TEST
```

By default, trial recovery always attempts to corrupt blocks in memory if this action allows trial recovery to proceed. Trial recovery by default can corrupt an unlimited number of data blocks. You can specify the ALLOW *n* CORRUPTION clause on the RECOVER . . . TEST statement to limit the number of data blocks that trial recovery can corrupt in memory.

A trial recovery command is usable in any scenario in which a normal recovery command is usable. Nevertheless, you only need to run trial recovery when recovery runs into problems.

See Also:

[How Trial Recovery Works](#) (page 30-32)

Performing User-Managed Recovery: Advanced Scenarios

This chapter describes several common media failure scenarios. It shows how to recover from each failure when using a user-managed backup and recovery strategy, that is, a strategy that does not depend on Recovery Manager. This chapter contains the following topics:

- [Responding to the Loss of a Subset of the Current Control Files](#) (page 31-1)
- [Recovering After the Loss of All Current Control Files](#) (page 31-2)
- [Re-Creating a Control File](#) (page 31-7)
- [Re-Creating Data Files When Backups Are Unavailable](#) (page 31-10)
- [Recovering NOLOGGING Tables and Indexes](#) (page 31-11)
- [Recovering Transportable Tablespaces](#) (page 31-12)
- [Recovering After the Loss of Online Redo Log Files](#) (page 31-13)
- [Recovering from a Dropped Table Without Using Flashback Features](#) (page 31-18)
- [Dropping a Database with SQL*Plus](#) (page 31-19)

31.1 Responding to the Loss of a Subset of the Current Control Files

Use the following procedures to recover a database if a permanent media failure has damaged one or more control files of a database and at least one current control file has *not* been damaged by the media failure.

This section contains the following topics:

- [Copying a Multiplexed Control File to a Default Location](#) (page 31-1)
- [Copying a Multiplexed Control File to a Nondefault Location](#) (page 31-2)

31.1.1 Copying a Multiplexed Control File to a Default Location

If the disk and file system containing the lost control file are intact, then you can simply copy an intact control file to the location of the missing control file. In this case, you do not have to edit the `CONTROL_FILES` initialization parameter.

To replace a damaged control file by copying a multiplexed control file:

1. If the instance is still running, then shut it down:

```
SQL> SHUTDOWN ABORT
```

2. Correct the hardware problem that caused the media failure. If you cannot repair the hardware problem quickly, then proceed with database recovery by restoring damaged control files to an alternative storage device, as described in ["Copying a Multiplexed Control File to a Nondefault Location"](#) (page 31-2).
3. Use an intact multiplexed copy of the database's current control file to copy over the damaged control files. For example, to replace `bad_cf.f` with `good_cf.f`, you might enter:

```
% cp /oracle/good_cf.f /oracle/dbs/bad_cf.f
```

4. Start a new instance and mount and open the database. For example, enter:

```
SQL> STARTUP
```

31.1.2 Copying a Multiplexed Control File to a Nondefault Location

If the disk and file system containing the lost control file are not intact, then you cannot copy a good control file to the location of the missing control file. In this case, you must alter the `CONTROL_FILES` initialization parameter to indicate a new location for the missing control file.

To restore a control file to a nondefault location:

1. If the instance is still running, then shut it down:

```
SQL> SHUTDOWN ABORT
```

2. If you cannot correct the hardware problem that caused the media failure, then copy the intact control file to alternative location.

For example, to copy a good version of `control01.dbf` to a new disk location you might issue the following commands:

```
% cp /disk1/oradata/trgt/control01.dbf /new_disk/control01.dbf
```

3. Edit the parameter file of the database so that the `CONTROL_FILES` parameter reflects the current locations of all control files and excludes all control files that were not restored.

Assume that the initialization parameter file contains the following setting:

```
CONTROL_FILES='/disk1/oradata/trgt/control01.dbf','/bad_disk/control02.dbf'
```

You can edit the `CONTROL_FILES` initialization parameter as follows:

```
CONTROL_FILES='/disk1/oradata/trgt/control01.dbf','/new_disk/control02.dbf'
```

4. Start a new instance and mount and open the database. For example:

```
SQL> STARTUP
```

31.2 Recovering After the Loss of All Current Control Files

Use the following procedures to restore a backup control file if a permanent media failure has damaged all control files of a database and you have a backup of the control file. When a control file is inaccessible, you can start the instance, but not

mount the database. If you attempt to mount the database when the control file is unavailable, then you receive the following error message:

```
ORA-00205: error in identifying control file, check alert log for more info
```

Note:

The easiest way to locate trace files and the alert log is to run the following SQL query: `SELECT NAME, VALUE FROM V$DIAG_INFO.`

You cannot mount and open the database until the control file is accessible again. If you restore a backup control file, then you must open the database with the `RESETLOGS` option.

As indicated in [Table 31-1](#) (page 31-3), the procedure for restoring the control file depends on whether the online redo logs are available.

Table 31-1 Scenarios When Control Files Are Lost

Status of Online Logs	Status of Data Files	Restore Procedure
Available	Current	If the online logs contain redo necessary for recovery, then restore a backup control file and apply the logs during recovery. You must specify the file name of the online logs containing the changes to open the database. After recovery, open the database with the <code>RESETLOGS</code> option. Note: If you re-create a control file, then it is not necessary to use the <code>OPEN RESETLOGS</code> option after recovery when the online redo logs are accessible.
Unavailable	Current	If the online logs contain redo necessary for recovery, then re-create the control file. Because the online redo logs are inaccessible, open <code>RESETLOGS</code> .
Available	Backup	Restore a backup control file, perform complete recovery, and then open the database with the <code>RESETLOGS</code> option.
Unavailable	Backup	Restore a backup control file, perform incomplete recovery, and then open <code>RESETLOGS</code> .

This section contains the following topics:

- [Recovering with a Backup Control File in the Default Location](#) (page 31-4)
- [Recovering with a Backup Control File in a Nondefault Location](#) (page 31-5)
- [Recovering Through an Added Data File with a Backup Control File](#) (page 31-6)
- [Recovering Read-Only Tablespaces with a Backup Control File](#) (page 31-7)

31.2.1 Recovering with a Backup Control File in the Default Location

If possible, restore the control file to its original location. In this way, you avoid having to specify new control file locations in the initialization parameter file.

To restore a backup control file to its default location:

1. If the instance is still running, shut it down:

```
SQL> SHUTDOWN ABORT
```

2. Correct the hardware problem that caused the media failure.
3. Restore the backup control file to all locations specified in the `CONTROL_FILES` parameter in the server parameter file or initialization parameter file. For example, if `/disk1/oradata/trgt/control01.dbf` and `/disk2/oradata/trgt/control02.dbf` are the control file locations listed in the server parameter file, then use an operating system utility to restore the backup control file to these locations:

```
% cp /backup/control01.dbf /disk1/oradata/trgt/control01.dbf
% cp /backup/control02.dbf /disk2/oradata/trgt/control02.dbf
```

4. Start a new instance and mount the database. For example, enter:

```
SQL> STARTUP MOUNT
```

5. Begin recovery by executing the `RECOVER` command with the `USING BACKUP CONTROLFILE` clause. Specify `UNTIL CANCEL` if you are performing incomplete recovery. For example, enter:

```
SQL> RECOVER DATABASE USING BACKUP CONTROLFILE UNTIL CANCEL
```

6. Apply the prompted archived logs. If you then receive another message saying that the required archived log is missing, then it probably means that a necessary redo record is located in the online redo logs. This situation can occur when unarchived changes were located in the online logs when the instance failed.

For example, assume that you see the following:

```
ORA-00279: change 55636 generated at 11/08/2002 16:59:47 needed for thread 1
ORA-00289: suggestion : /oracle/work/arc_dest/arc_r1_111.arc
ORA-00280: change 55636 for thread 1 is in sequence #111
Specify log: {<RET>=suggested | filename | AUTO | CANCEL}
```

You can specify the name of an online redo log and press Enter (you may have to try this a few times until you find the correct log):

```
ORACLE_HOME/oradata/redo01.dbf
Log applied.
Media recovery complete.
```

If the online logs are inaccessible, then you can cancel recovery without applying them. If all data files are current, and if redo in the online logs is required for recovery, then you cannot open the database without applying the online logs. If the online logs are inaccessible, then you must re-create the control file, using the procedure described in "[Re-Creating a Control File](#) (page 31-7)".

7. Open the database with the `RESETLOGS` option after finishing recovery:

```
SQL> ALTER DATABASE OPEN RESETLOGS;
```

31.2.2 Recovering with a Backup Control File in a Nondefault Location

If you cannot restore the control file to its original place because the media damage is too severe, then you must specify new control file locations in the server parameter file. A valid control file must be available in all locations specified by the `CONTROL_FILES` initialization parameter. If not, then the database prevents you from mounting the database.

To restore a control file to a nondefault location:

1. If the instance is still running, shut it down:

```
SQL> SHUTDOWN ABORT
```

2. Correct the hardware problem that caused the media failure.
3. Edit all locations specified in the `CONTROL_FILES` initialization parameter to reflect the new control file locations. Assume that the control file locations listed in the server parameter file are as follows, and both disks are inaccessible:

```
CONTROL_FILES='/disk1/oradata/trgt/control01.dbf',
              '/disk2/oradata/trgt/control02.dbf'
```

You can edit the initialization parameter file and specify accessible locations, as shown in the following example:

```
CONTROL_FILES='/disk3/cf/control01.dbf', '/disk4/cf/control02.dbf'
```

4. Restore the backup control file to all locations specified in the `CONTROL_FILES` parameter in the server parameter file or initialization parameter file. For example, if `/disk1/oradata/trgt/control01.dbf` and `/disk2/oradata/trgt/control02.dbf` are the control file locations listed in the server parameter file, then use an operating system utility to restore the backup control file to these locations:

```
% cp /backup/control01.dbf /disk1/oradata/trgt/control01.dbf
% cp /backup/control02.dbf /disk2/oradata/trgt/control02.dbf
```

5. Start a new instance and mount the database. For example, enter:

```
SQL> STARTUP MOUNT
```

6. Begin recovery by executing the `RECOVER` command with the `USING BACKUP CONTROLFILE` clause. Specify `UNTIL CANCEL` if you are performing incomplete recovery. For example, enter:

```
SQL> RECOVER DATABASE USING BACKUP CONTROLFILE UNTIL CANCEL
```

7. Apply the prompted archived logs. If you then receive another message saying that the required archived log is missing, then it probably means that a necessary redo record is located in the online redo logs. This situation can occur when unarchived changes were located in the online logs when the instance failed.

For example, assume that you see the following:

```
ORA-00279: change 55636 generated at 11/08/2002 16:59:47 needed for thread 1
ORA-00289: suggestion : /oracle/work/arc_dest/arcr_1_111.arc
ORA-00280: change 55636 for thread 1 is in sequence #111
Specify log: {<RET>=suggested | filename | AUTO | CANCEL}
```

You can specify the name of an online redo log and press Enter (you may have to try this a few times until you find the correct log):

```
ORACLE_HOME/oradata/redo01.dbf
Log applied.
Media recovery complete.
```

If the online logs are inaccessible, then you can cancel recovery without applying them. If all data files are current, and if redo in the online logs is required for recovery, then you cannot open the database without applying the online logs. If the online logs are inaccessible, then you must re-create the control file, using the procedure described in ["Re-Creating a Control File \(page 31-7\)"](#).

8. Open the database with the RESETLOGS option after finishing recovery:

```
SQL> ALTER DATABASE OPEN RESETLOGS;
```

31.2.3 Recovering Through an Added Data File with a Backup Control File

If database recovery with a backup control file rolls forward through a CREATE TABLESPACE or an ALTER TABLESPACE ADD DATAFILE operation, then the database stops recovery when applying the redo record for the added files and lets you confirm the file names.

For example, suppose that the following sequence of events occurs:

1. You back up the database.
2. You create a tablespace containing the following data files: /disk1/oradata/trgt/test01.dbf and /disk1/oradata/trgt/test02.dbf.
3. You restore a backup control file and perform media recovery through the CREATE TABLESPACE operation.

You may see the following error when applying the CREATE TABLESPACE redo data:

```
ORA-00283: recovery session canceled due to errors
ORA-01244: unnamed datafile(s) added to control file by media recovery
ORA-01110: data file 11: '/disk1/oradata/trgt/test02.dbf'
ORA-01110: data file 10: '/disk1/oradata/trgt/test01.dbf'
```

To recover through an ADD DATAFILE operation:

1. View the files added by querying V\$DATAFILE., as in the following example:

```
SELECT FILE#,NAME
FROM V$DATAFILE;

FILE#          NAME
-----
1              /disk1/oradata/trgt/system01.dbf
.
.
.
10             /disk1/oradata/trgt/UNNAMED00001
11             /disk1/oradata/trgt/UNNAMED00002
```

2. If multiple unnamed files exist, then determine which unnamed file corresponds to which data file by using one of these methods:

- Open the `alert_SID.log`, which contains messages about the original file location for each unnamed file.
 - Derive the original file location of each unnamed file from the error message and `V$DATAFILE`: each unnamed file corresponds to the file in the error message with the same file number.
3. Issue the `ALTER DATABASE RENAME FILE` statement to rename the data files. For example, enter:

```
ALTER DATABASE RENAME FILE '/db/UNNAMED00001' TO
                          '/disk1/oradata/trgt/test01.dbf';
ALTER DATABASE RENAME FILE '/db/UNNAMED00002' TO
                          '/disk1/oradata/trgt/test02.dbf';
```

4. Continue recovery by issuing the recovery statement. For example:

```
RECOVER AUTOMATIC DATABASE USING BACKUP CONTROLFILE UNTIL CANCEL
```

31.2.4 Recovering Read-Only Tablespaces with a Backup Control File

If you have a read-only tablespace on read-only or slow media, then you may encounter errors or poor performance when recovering with the `USING BACKUP CONTROLFILE` option. This situation occurs when the backup control file indicates that a tablespace was read/write when the control file was backed up. In this case, media recovery may attempt to write to the files. For read-only media, the database issues an error saying that it cannot write to the files. For slow media, such as a hierarchical storage system backed up by tapes, performance may suffer.

To avoid these problems, use current control files rather than backups to recover the database. If you must use a backup control file, then you can also avoid this problem if the read-only tablespace has not suffered a media failure. You have the following alternatives for recovering read-only and slow media when using a backup control file:

- Take data files from read-only tablespaces offline before doing recovery with a backup control file, and then bring the files online after media recovery.
- Use the correct version of the control file for the recovery. If the tablespace is read-only when recovery completes, then the control file backup must be from a time when the tablespace was read-only. Similarly, if the tablespace is read/write after recovery, then the control file must be from a time when the tablespace was read/write.

31.3 Re-Creating a Control File

If all control files have been lost in a permanent media failure, but all online redo log members remain intact, then you can recover the database after creating a new control file. You are *not* required to open the database with the `RESETLOGS` option after the recovery.

Depending on the existence and currency of a control file backup, you have the options listed in [Table 31-2](#) (page 31-8) for generating the text of the `CREATE CONTROLFILE` statement. The changes to the database are recorded in the `alert_SID.log`, so check this log when you are deciding which option to choose.

Table 31-2 Options for Creating the Control File

If you...	Then...
Executed ALTER DATABASE BACKUP CONTROLFILE TO TRACE NORESETLOGS after you made the last structural change to the database, and if you have saved the SQL command trace output	Use the CREATE CONTROLFILE statement from the trace output as-is.
Performed your most recent execution of ALTER DATABASE BACKUP CONTROLFILE TO TRACE before you made a structural change to the database	Edit the output of ALTER DATABASE BACKUP CONTROLFILE TO TRACE to reflect the change. For example, if you recently added a data file to the database, then add this data file to the DATAFILE clause of the CREATE CONTROLFILE statement.
Backed up the control file with the ALTER DATABASE BACKUP CONTROLFILE TO filename statement (not the TO TRACE option)	Use the control file copy to obtain SQL output. Create a temporary database instance, mount the backup control file, and then run ALTER DATABASE BACKUP CONTROLFILE TO TRACE NORESETLOGS. If the control file copy predated a recent structural change, then edit the trace option to reflect the change.
Do not have a control file backup in either TO TRACE format or TO filename format	Execute the CREATE CONTROLFILE statement manually (See <i>Oracle Database SQL Language Reference</i>).

Note:

If your character set is not the default US7ASCII, then you must specify the character set as an argument to the CREATE CONTROLFILE statement. The database character set is written to the alert log at startup. The character set information is also recorded in the BACKUP CONTROLFILE TO TRACE output.

To create a control file and recover the database:

1. Start the database in NOMOUNT mode. For example, enter:

```
STARTUP NOMOUNT
```

2. Create the control file with the CREATE CONTROLFILE statement, specifying the NORESETLOGS option (See to [Table 31-2](#) (page 31-8) for options). The following example assumes that the character set is the default US7ASCII:

```
CREATE CONTROLFILE REUSE DATABASE SALES NORESETLOGS ARCHIVELOG
    MAXLOGFILES 32
    MAXLOGMEMBERS 2
    MAXDATAFILES 32
    MAXINSTANCES 16
    MAXLOGHISTORY 1600
LOGFILE
GROUP 1 (
```



```

        '/diska/prod/sales/db/log1t1.dbf',
        '/diskb/prod/sales/db/log1t2.dbf'
    ) SIZE 100K,
GROUP 2 (
        '/diska/prod/sales/db/log2t1.dbf',
        '/diskb/prod/sales/db/log2t2.dbf'
    ) SIZE 100K
DATAFILE
        '/diska/prod/sales/db/database1.dbf',
        '/diskb/prod/sales/db/filea.dbf';

```

After creating the control file, the instance mounts the database.

3. Recover the database as usual (*without* specifying the USING BACKUP CONTROLFILE clause):

```
RECOVER DATABASE
```

4. Open the database after recovery completes (the RESETLOGS option is not required):

```
ALTER DATABASE OPEN;
```

5. Immediately back up the control file. The following SQL statement backs up a database's control file to /backup/control01.dbf:

```
ALTER DATABASE BACKUP CONTROLFILE TO '/backup/control01.dbf' REUSE;
```

To create a control file for a multitenant container database:

1. Ensure that the [multitenant container database \(CDB\)](#) is not mounted in any instance.
2. Open SQL*Plus.
3. Connect to the [root](#) as a user with the SYSDBA privilege.
4. Follow the previous procedure for creating a control file and recovering the database.

See Also:

["Backing Up the Control File to a Trace File \(page 29-15\)"](#), and ["Re-Creating Data Files When Backups Are Unavailable \(page 31-10\)"](#)

31.3.1 Recovering Through a RESETLOGS with a Created Control File

You can recover backups through an OPEN RESETLOGS operation so long as:

- You have a current, backup, or created control file that detects prior incarnations
- You have all available archived redo logs

If you must re-create the control file, then the trace file generated by ALTER DATABASE BACKUP CONTROLFILE TO TRACE contains the necessary commands to reconstruct the complete incarnation history. The V\$DATABASE_INCARNATION view displays the RESETLOGS history of the control file, and the V\$LOG_HISTORY view displays the archived log history.

It is possible for the incarnation history to be incomplete in the in re-created control file. For example, archived logs necessary for recovery may be missing. In this case, it is possible to create incarnation records explicitly with the `ALTER DATABASE REGISTER LOGFILE` statement.

In the following example, you register four logs that are necessary for recovery but are not recorded in the re-created control file, and then recover the database:

```
ALTER DATABASE REGISTER LOGFILE '/disk1/oradata/trgt/arch/arcr_1_1_42343523.arc';
ALTER DATABASE REGISTER LOGFILE '/disk1/oradata/trgt/arch/arcr_1_1_34546466.arc';
ALTER DATABASE REGISTER LOGFILE '/disk1/oradata/trgt/arch/arcr_1_1_23435466.arc';
ALTER DATABASE REGISTER LOGFILE '/disk1/oradata/trgt/arch/arcr_1_1_12343533.arc';
RECOVER AUTOMATIC DATABASE;
```

31.3.2 Recovery of Read-Only Files with a Re-Created Control File

If a current or backup control file is unavailable for recovery, then you can execute a `CREATE CONTROLFILE` statement. Do not list read-only files in the `CREATE CONTROLFILE` statement so recovery can skip them. No recovery is required for read-only data files unless you restored backups of these files when the data files were read/write.

After you create a control file and attempt to mount and open the database, the database performs a data dictionary check against the files listed in the control file. For each file that is not listed in the `CREATE CONTROLFILE` statement but is present in the data dictionary, an entry is created for them in the control file. These files are named as `MISSINGnnnnn`, where `nnnnn` is a 5-digit number starting with 0.

After the database is open, rename the read-only files to their correct file names by executing the `ALTER DATABASE RENAME FILE` statement for all the files whose names are prefixed with `MISSING`.

To prepare for a scenario in which you might have to re-create the control file:

Run the following statement when the database is mounted or open to obtain the `CREATE CONTROLFILE` syntax:

```
ALTER DATABASE BACKUP CONTROLFILE TO TRACE;
```

The preceding SQL statement produces a trace file that you can edit and use as a script to re-create the control file. You can specify either the `RESETLOGS` or `NORESETLOGS` (default) keywords to generate `CREATE CONTROLFILE . . . RESETLOGS` or `CREATE CONTROLFILE . . . NORESETLOGS` versions of the script.

All the restrictions related to read-only files in `CREATE CONTROLFILE` statements also apply to offline normal tablespaces, except that you must to bring the tablespace online after the database is open. Omit temp files from the `CREATE CONTROLFILE` statement and add them after opening the database.

See Also:

["Backing Up the Control File to a Trace File \(page 29-15\)"](#) to learn how to make trace backups of the control file

31.4 Re-Creating Data Files When Backups Are Unavailable

If a data file is damaged and no backup of the file is available, then you can still recover the data file if:

- All archived log files written after the creation of the original data file are available
- The control file contains the name of the damaged file (that is, the control file is current, or is a backup taken after the damaged data file was added to the database)

Note:

You cannot re-create any of the data files for the SYSTEM tablespace by using the CREATE DATAFILE clause of the ALTER DATABASE statement because the necessary redo is not available.

To re-create a data file for recovery:

1. Create an empty data file to replace a damaged data file that has no corresponding backup. For example, assume that data file `/disk1/oradata/trgt/users01.dbf` is damaged, and no backup is available. The following statement re-creates the original data file (same size) on `disk2`:

```
ALTER DATABASE CREATE DATAFILE '/disk1/oradata/trgt/users01.dbf' AS
                               '/disk2/users01.dbf';
```

This statement creates an empty file that is the same size as the lost file. The database looks at information in the control file and the data dictionary to obtain size information. The old data file is renamed as the new data file.

2. Perform media recovery on the empty data file. For example, enter:

```
RECOVER DATAFILE '/disk2/users01.dbf'
```

3. All archived logs written after the original data file was created must be applied to the new, empty version of the lost data file during recovery.

31.5 Recovering NOLOGGING Tables and Indexes

You can create tables and indexes with the CREATE TABLE AS SELECT statement. You can also specify that the database create them with the NOLOGGING option. When you create a table or index as NOLOGGING, the database does not generate redo log records for the operation. Thus, you cannot recover objects created with NOLOGGING, even if you run in ARCHIVELOG mode.

Note:

If you cannot afford to lose tables or indexes created with NOLOGGING, then make a backup after the unrecoverable table or index is created.

Be aware that when you perform media recovery, and some tables or indexes are created normally whereas others are created with the NOLOGGING option, the NOLOGGING objects are marked logically corrupt by the RECOVER operation. Any attempt to access the unrecoverable objects returns an ORA-01578 error message. Drop the NOLOGGING objects and re-create them if needed.

Because it is possible to create a table with the NOLOGGING option and then create an index with the LOGGING option on that table, the index is not marked as logically

corrupt after you perform media recovery. The table was unrecoverable (and thus marked as corrupt after recovery), however, so the index points to corrupt blocks. The index must be dropped, and the table and index must be re-created if necessary.

See Also:

Oracle Data Guard Concepts and Administration for information about the effect of NOLOGGING on a database

31.6 Recovering Transportable Tablespaces

The [transportable tablespace](#) feature of Oracle Database enables a user to transport a set of tablespaces from one database to another. Transporting a tablespace into a database is like creating a tablespace with loaded data. Using this feature is often an advantage for the following reasons:

- It is faster than using the Data Pump Export or SQL*Loader utilities because it involves only copying data files and integrating metadata
- You can use it to move index data, hence avoiding the necessity of rebuilding indexes

See Also:

Oracle Database Administrator's Guide for detailed information about using the transportable tablespace feature

Like normal tablespaces, transportable tablespaces are recoverable. However, even though you can recover normal tablespaces without a backup, you must have a consistent version of the transported data files to recover a transported tablespace.

To recover a transportable tablespace, use the following procedure:

1. If the database is open, then take the transported tablespace offline. For example, if you want to recover the `users` tablespace, then issue the following statement:

```
ALTER TABLESPACE users OFFLINE IMMEDIATE;
```

2. Restore a backup of the transported data files with an operating system utility. The backup can be the initial version of the transported data files or any backup taken after the tablespace is transported. For example, enter:

```
% cp /backup/users.dbf $ORACLE_HOME/oradata/trgt/users01.dbf
```

3. Recover the tablespace as usual. For example, enter:

```
RECOVER TABLESPACE users
```

You may see the error `ORA-01244` when recovering through a transportable tablespace operation just as when recovering through a `CREATE TABLESPACE` operation. In this case, rename the unnamed files to the correct locations using the procedure in "[Recovering Through an Added Data File with a Backup Control File](#) (page 31-6)".

31.7 Recovering After the Loss of Online Redo Log Files

If a media failure has affected the online redo logs of a database, then the appropriate recovery procedure depends on the following considerations:

- The configuration of the online redo log: mirrored or non-mirrored
- The type of media failure: temporary or permanent
- The types of online redo log files affected by the media failure: current, active, unarchived, or inactive

The following table displays V\$LOG status information that can be crucial in a recovery situation involving online redo logs.

Table 31-3 STATUS Column of V\$LOG

Status	Description
UNUSED	The online redo log has never been written to.
CURRENT	The online redo log is active, that is, needed for instance recovery, and it is the log to which the database is currently writing. The redo log can be open or closed.
ACTIVE	The online redo log is active, that is, needed for instance recovery, but is not the log to which the database is currently writing. It may be in use for block recovery, and may or may not be archived.
CLEARING	The log is being re-created as an empty log after an ALTER DATABASE CLEAR LOGFILE statement. After the log is cleared, then the status changes to UNUSED.
CLEARING_CURRENT	The current log is being cleared of a closed thread. The log can stay in this status if there is some failure in the switch such as an I/O error writing the new log header.
INACTIVE	The log is no longer needed for instance recovery. It may be in use for media recovery, and may or may not be archived.

This section contains the following topics:

- [Recovering After Losing a Member of a Multiplexed Online Redo Log Group](#) (page 31-13)
- [Recovering After Losing All Members of an Online Redo Log Group](#) (page 31-14)

31.7.1 Recovering After Losing a Member of a Multiplexed Online Redo Log Group

You can recover after losing a member of a multiplexed online redo log group. The database continues to function as usual during the following conditions:

If the online redo log of a database is multiplexed, and if at least one member of each online redo log group is not affected by the media failure, then the database continues functioning as usual, but error messages are written to the log writer trace file and the alert_SID.log of the database.

You can resolve the problem of a missing member of a multiplexed online redo log group by taking one of the following actions:

- If the hardware problem is temporary, then correct it. The log writer process accesses the previously unavailable online redo log files as if the problem never existed.
- If the hardware problem is permanent, then drop the damaged member and add a new member by using the following procedure.

Note:

The newly added member provides no redundancy until the log group is reused.

1. Locate the file name of the damaged member in V\$LOGFILE. The status is INVALID if the file is inaccessible:

```
SELECT GROUP#, STATUS, MEMBER
FROM V$LOGFILE
WHERE STATUS='INVALID';
```

```
GROUP#    STATUS    MEMBER
-----
0002      INVALID  /disk1/oradata/trgt/redo02.log
```

2. Drop the damaged member. For example, to drop member redo02.log from group 2, issue the following statement:

```
ALTER DATABASE DROP LOGFILE MEMBER '/disk1/oradata/trgt/redo02.log';
```

3. Add a new member to the group. For example, to add redo02.log to group 2, issue the following statement:

```
ALTER DATABASE ADD LOGFILE MEMBER '/disk1/oradata/trgt/redo02b.log'
TO GROUP 2;
```

If the file to add already exists, then it must be the same size as the other group members, and you must specify the REUSE option. For example:

```
ALTER DATABASE ADD LOGFILE MEMBER '/disk1/oradata/trgt/redo02b.log'
REUSE TO GROUP 2;
```

31.7.2 Recovering After Losing All Members of an Online Redo Log Group

If a media failure damages all members of an online redo log group, then different scenarios can occur depending on the type of online redo log group affected by the failure and the archiving mode of the database.

If the damaged online redo log group is current and active, then it is needed for crash recovery; otherwise, it is not. [Table 31-4](#) (page 31-14) outlines the various recovery scenarios.

Table 31-4 Recovering After the Loss of an Online Redo Log Group

If the Group Is...	Then...	And You Can...
Inactive	It is not needed for crash recovery	Clear the archived or unarchived group.

Table 31-4 (Cont.) Recovering After the Loss of an Online Redo Log Group

If the Group Is...	Then...	And You Can...
Active	It is needed for crash recovery	Attempt to issue a checkpoint and clear the log; if impossible, then you must either use Flashback Database or restore a backup and perform incomplete recovery up to the most recent available redo log.
Current	It is the redo log that the database is currently writing to	Attempt to clear the log; if impossible, then you must either use Flashback Database or restore a backup and perform incomplete recovery up to the most recent available redo log.

To determine whether the damaged group is active or inactive.

1. Locate the file name of the lost redo log in V\$LOGFILE and then look for the group number corresponding to it. For example, enter:

```
SELECT GROUP#, STATUS, MEMBER FROM V$LOGFILE;
```

```
GROUP#    STATUS    MEMBER
-----
0001             /oracle/dbs/log1a.f
0001             /oracle/dbs/log1b.f
0002    INVALID  /oracle/dbs/log2a.f
0002    INVALID  /oracle/dbs/log2b.f
0003             /oracle/dbs/log3a.f
0003             /oracle/dbs/log3b.f
```

2. Determine which groups are active.

For example, execute the following SQL query (sample output included):

```
SELECT GROUP#, MEMBERS, STATUS, ARCHIVED
FROM V$LOG;
```

```
GROUP# MEMBERS    STATUS    ARCHIVED
-----
0001    2          INACTIVE  YES
0002    2          ACTIVE    NO
0003    2          CURRENT   NO
```

3. Perform one of the following actions:

- If the affected group is inactive, then follow the procedure in "[Losing an Inactive Online Redo Log Group](#) (page 31-15)".
- If the affected group is active (as in the preceding example), then follow the procedure in "[Losing an Active Online Redo Log Group](#) (page 31-17)".

31.7.2.1 Losing an Inactive Online Redo Log Group

If all members of an online redo log group with `INACTIVE` status are damaged, then the procedure depends on whether you can fix the media problem that damaged the

inactive redo log group. If the failure is temporary, then fix the problem. The log writer can reuse the redo log group when required. If the failure is permanent, then the damaged inactive online redo log group eventually halts normal database operation. Reinitialize the damaged group manually by issuing the `ALTER DATABASE CLEAR LOGFILE` statement as described in this section.

31.7.2.1.1 Clearing Inactive, Archived Redo

You can clear an inactive redo log group when the database is open or closed. The procedure depends on whether the damaged group has been archived.

To clear an inactive, online redo log group that has been archived:

1. If the database is shut down, then start a new instance and mount the database:

```
STARTUP MOUNT
```

2. Reinitialize the damaged log group. For example, to clear redo log group 2, issue the following statement:

```
ALTER DATABASE CLEAR LOGFILE GROUP 2;
```

31.7.2.1.2 Clearing Inactive, Unarchived Redo

Clearing a not-yet-archived redo log allows it to be reused without archiving it. This action makes backups unusable if they were started before the last change in the log, unless the file was taken offline before the first change in the log. Hence, if you need the cleared log file for recovery of a backup, then you cannot recover that backup. Clearing a not-yet-archived-redo-log, prevents complete recovery from backups due to the missing log.

To clear an inactive, online redo log group that has not been archived:

1. If the database is shut down, then start a new instance and mount the database:

```
SQL> STARTUP MOUNT
```

2. Clear the log using the `UNARCHIVED` keyword.

For example, to clear log group 2, issue the following SQL statement:

```
SQL> ALTER DATABASE CLEAR UNARCHIVED LOGFILE GROUP 2;
```

If there is an offline data file that requires the cleared log to bring it online, then the keywords `UNRECOVERABLE DATAFILE` are required. The data file must be dropped because the redo logs necessary to bring the data file online are being cleared, and there is no copy of it. For example, enter:

```
SQL> ALTER DATABASE CLEAR UNARCHIVED LOGFILE GROUP 2 UNRECOVERABLE DATAFILE;
```

3. Immediately back up all data files in the database with an operating system utility, so that you have a backup you can use for complete recovery without relying on the cleared log group. For example, enter:

```
% cp /disk1/oracle/dbs/*.dbf /disk2/backup
```

4. Back up the database's control file with the `ALTER DATABASE` statement. For example, enter:

```
SQL> ALTER DATABASE BACKUP CONTROLFILE TO '/oracle/dbs/cf_backup.f';
```

31.7.2.1.3 Failure of CLEAR LOGFILE Operation

The `ALTER DATABASE CLEAR LOGFILE` statement can fail with an I/O error due to media failure when it is not possible to:

- Relocate the redo log file onto alternative media by re-creating it under the currently configured redo log file name
- Reuse the currently configured log file name to re-create the redo log file because the name itself is invalid or unusable (for example, due to media failure)

In these cases, the `ALTER DATABASE CLEAR LOGFILE` statement (before receiving the I/O error) successfully informs the control file that the log is being cleared and does not require archiving. The I/O error occurs at the step in which the `CLEAR LOGFILE` statement attempts to create the new redo log file and write zeros to it. This fact is reflected in `V$LOG.CLEARING_CURRENT`.

31.7.2.2 Losing an Active Online Redo Log Group

If the database is still running and the lost active redo log is *not* the current log, then issue the `ALTER SYSTEM CHECKPOINT` statement. If the operation is successful, then the active redo log becomes inactive, and you can follow the procedure in "[Losing an Inactive Online Redo Log Group](#) (page 31-15)". If the operation is unsuccessful, or if your database has halted, then perform one of procedures in this section, depending on the archiving mode.

The current log is the one LGWR is currently writing to. If a LGWR I/O operation fails, then LGWR terminates and the instance fails. In this case, you must restore a backup, perform incomplete recovery, and open the database with the `RESETLOGS` option.

31.7.2.2.1 Recovering from the Loss of Active Logs in NOARCHIVELOG Mode

In this scenario, the database archiving mode is `NOARCHIVELOG`.

To recover from the loss of an active online log group in NOARCHIVELOG mode:

1. If the media failure is temporary, then correct the problem so that the database can reuse the group when required.
2. Restore the database from a consistent, whole database backup (data files and control files). For example, enter:

```
% cp /disk2/backup/*.dbf $ORACLE_HOME/oradata/trgt/
```

3. Mount the database:

```
STARTUP MOUNT
```

4. Because online redo logs are not backed up, you cannot restore them with the data files and control files. To allow the database to reset the online redo logs, you must first mimic incomplete recovery:

```
RECOVER DATABASE UNTIL CANCEL
CANCEL
```

5. Open the database using the `RESETLOGS` option:

```
ALTER DATABASE OPEN RESETLOGS;
```

6. Shut down the database consistently. For example, enter:

```
SHUTDOWN IMMEDIATE
```

7. Make a whole database backup.

If the media failure is temporary, then correct the problem so that the database can reuse the group when required. If the media failure is not temporary, then use the following procedure.

31.7.2.2.2 Recovering from Loss of Active Logs in ARCHIVELOG Mode

In this scenario, the database archiving mode is ARCHIVELOG.

To recover from loss of an active online redo log group in ARCHIVELOG mode:

1. Begin incomplete media recovery, recovering up through the log before the damaged log.
2. Ensure that the current name of the lost redo log can be used for a newly created file. If not, then rename the members of the damaged online redo log group to a new location. For example, enter:

```
ALTER DATABASE RENAME FILE "/disk1/oradata/trgt/redo01.log" TO "/tmp/redo01.log";  
ALTER DATABASE RENAME FILE "/disk1/oradata/trgt/redo02.log" TO "/tmp/redo02.log";
```

3. Open the database using the RESETLOGS option:

```
ALTER DATABASE OPEN RESETLOGS;
```

Note:

All updates executed from the end point of the incomplete recovery to the present must be reexecuted.

31.7.2.3 Loss of Multiple Redo Log Groups

If you have lost multiple groups of the online redo log, then use the recovery method for the most difficult log to recover. The order of difficulty, from most difficult to least difficult, is as follows:

1. The current online redo log
2. An active online redo log
3. An unarchived online redo log
4. An inactive online redo log

31.8 Recovering from a Dropped Table Without Using Flashback Features

One common error is the accidental dropping of a table from your database. In general, the fastest and simplest solution is to use the Flashback Drop feature to reverse the dropping of the table. If you cannot use Flashback Table (for example, because Flashback Drop is disabled or the table was dropped with the PURGE option), then you can perform the procedure in this section.

In this scenario, assume that you do not have the Flashback Database functionality enabled, so the FLASHBACK DATABASE command is not an option. However, you do

have physical backups of the database. If possible, keep the database that experienced the user error online and available for use.

Note:

Grant powerful privileges only to appropriate users to minimize user errors that require recovery.

To recover a table that has been accidentally dropped:

1. Back up all data files of the existing database in case an error is made during the remaining steps of this procedure.
2. Restore a partial backup of the database to an alternative location. At minimum, restore the following:
 - SYSTEM and SYSAUX tablespaces
 - Tablespaces containing undo or rollback segments
 - Self-contained tablespaces that contain the data to be retrieved
3. Perform incomplete recovery of this backup using a restored backup control file, to the point just before the table was dropped.
4. Export the lost data from the temporary, restored version of the database using Data Pump Export. In this case, export the accidentally dropped table.

Note:

System audit options are exported.

5. Use the Data Pump Import utility to import the data back into the production database.
6. Delete the files of the temporary copy of the database to conserve space.

See Also:

Oracle Database Utilities for more information about Oracle Data Pump

31.9 Dropping a Database with SQL*Plus

You may need to remove a database, that is, the database files that form the database, from the operating system. For example, this scenario can occur when you create a test database and then no longer have a use for it. The SQL statement `DROP DATABASE` can perform this function.

See Also:

"[Dropping a Database](#) (page 12-27)" to learn how to use the equivalent RMAN command `DROP DATABASE`

To drop a database with SQL*Plus:

1. After connecting to the database with administrator privileges, ensure that the database is either mounted or open in restricted mode with no users connected.

For example, enter the following command:

```
SQL> STARTUP RESTRICT FORCE MOUNT
```

2. Remove the data files and control files from the operating system.

For example, enter the following command:

```
SQL> DROP DATABASE; # deletes all database files, both ASM and non-ASM
```

If the database is on raw disk, then the command does not delete the actual raw disk special files.

3. Use an operating system utility to delete all backups and archived logs associated with the database.

For example, on Linux and UNIX enter the following command:

```
% rm /backup/* /disk1/oradata/trgt/arch/*
```

Glossary

active database duplication

A [duplicate database](#) that is created over a network without restoring backups of the [target database](#). This technique is an alternative to [backup-based duplication](#).

ancestor incarnation

The [parent incarnation](#) is the database [incarnation](#) from which the [current incarnation](#) branched following an `OPEN RESETLOGS` operation. The parent of the parent incarnation is an ancestor incarnation. Any parent of an ancestor incarnation is also an ancestor incarnation.

application container

A named set of [application PDBs](#) that are plugged in to an [application root](#).

application PDB

A PDB that is plugged in to an [application container](#).

application root

The root container within an [application container](#). Every application container has exactly one application root. An application root can contain common objects and is created with the `CREATE PLUGGABLE DATABASE` statement.

archival backup

A database backup that is exempted from the normal backup and recovery strategy. Typically, these backups are archived onto separate storage media and retained for long periods.

archived redo log

A copy of a filled member of an online redo log group made when the database is in `ARCHIVELOG` mode. After the LGWR process fills each online redo log with redo records, the archiver process copies the log to one or more redo log archiving destinations. This copy is the archived redo log. RMAN does not distinguish between an original archived redo log and an image copy of an archived redo log; both are considered image copies.

archived redo log deletion policy

A configurable, persistent RMAN policy that governs when archived redo logs can be deleted. You can configure the policy with the `CONFIGURE ARCHIVELOG DELETION POLICY` command.

archived redo log failover

An RMAN feature that enables RMAN to complete a backup even when some archived log destinations are missing logs or have logs with corrupt blocks. For example, if you back up logs in the fast recovery area that RMAN determines are corrupt, RMAN can search for logs in other archiving locations and back them up instead if they are intact.

ARCHIVELOG mode

The mode of the database in which Oracle Database copies filled online redo logs to disk. Specify the mode at database creation or with the `ALTER DATABASE ARCHIVELOG` statement.

See Also: [archived redo log](#), [NOARCHIVELOG mode](#)

archiving

The operation in which a filled online redo log file is copied to an offline log archiving destination. An offline copy of an online redo logs is called an [archived redo log](#). You must run the database in ARCHIVELOG mode to archive redo logs.

asynchronous I/O

A server process can begin an I/O and then perform other work while waiting for the I/O to complete while RMAN is either reading or writing data. RMAN can also begin multiple I/O operations before waiting for the first I/O to complete.

automatic channel allocation

The ability of RMAN to perform backup and restore tasks without requiring the use of the `ALLOCATE CHANNEL` command. You can use the `CONFIGURE` command to specify disk and tape channels. Then, you can issue commands such as `BACKUP` and `RESTORE` at the RMAN command prompt without manually allocating channels. RMAN uses whatever configured channels that it needs to execute the commands.

Automatic Diagnostic Repository (ADR)

A system-managed repository for storing and organizing database trace files and other diagnostic data. ADR provides a comprehensive view of all the serious errors encountered by the database and maintains all relevant data needed for problem diagnostic and their eventual resolution. The repository contains data describing incidents, traces, dumps, alert messages, data repair records, [data integrity check records](#), SQL trace information, core dumps, and so on.

The initialization parameter `DIAGNOSTIC_DEST` specifies the location of the ADR base, which is the directory that contains one or more ADR homes. Each ADR home is used by a product or a product instance to store diagnostic data in well-defined

subdirectories. For example, diagnostic data for an Oracle Database instance is stored in its ADR home, which includes an `alert` subdirectory for alert messages, a `trace` subdirectory for trace files, and so on. The easiest way to locate trace files and the alert log is to run the following SQL query: `SELECT NAME, VALUE FROM V$DIAG_INFO`.

Automatic Storage Management (ASM)

A vertical integration of both the file system and the volume manager built specifically for Oracle Database files. ASM consolidates storage devices into easily managed disk groups and provides benefits such as mirroring and striping without requiring a third-party logical volume manager.

automatic undo management mode

A mode of the database in which undo data is stored in a dedicated [undo tablespace](#). The only undo management that you must perform is the creation of the undo tablespace. All other undo management is performed automatically.

auxiliary channel

An RMAN [channel](#) that is connected to an auxiliary instance. An auxiliary channel is specified with the `AUXILIARY` keyword of the `ALLOCATE CHANNEL` or `CONFIGURE CHANNEL` command.

auxiliary database

- (1) A database created from target database backups with the `RMAN DUPLICATE` command.
- (2) A temporary database that is restored to a new location and then started with a new instance name during [tablespace point-in-time recovery \(TSPITR\)](#). A TSPITR auxiliary database contains the [recovery set](#) and [auxiliary set](#).

auxiliary destination

In a [transportable tablespace](#) operation, the location on disk where auxiliary set files such as the parameter file, data files (other than those of the tablespaces being transported), control files, and online redo logs of the auxiliary instance can be stored.

auxiliary instance

The Oracle instance associated with an auxiliary database, or the temporary instance used in [tablespace point-in-time recovery \(TSPITR\)](#) or a [transportable tablespace](#) operation.

auxiliary set

In TSPITR, the set of files that is not in the recovery set but which must be restored in the [auxiliary database](#) for the TSPITR operation to be successful. In a transportable tablespace operation, the auxiliary set includes data files and other files required for the tablespace transport but which are not themselves part of the [recovery set](#).

backup

(1) A backup [copy](#) of data, that is, a database, tablespace, table, data file, control file, or archived redo log. Backups can be physical (at the database file level) or logical (at the database object level). Physical backups can be created by using RMAN to back up one or more data files, control files or archived redo log files. You can create logical backups with Data Pump Export.

(2) In an RMAN context, the output of the `BACKUP` command. The output format of a backup can be a [backup set](#), [proxy copy](#), or [image copy](#). Logs archived by the database are considered copies rather than backups.

backup and recovery

The set of concepts, procedures, and strategies involved in protecting the database against data loss due to media failure or users errors.

backup-based duplication

A [duplicate database](#) that is created by restoring and recovering backups of the [target database](#). This technique is an alternative to [active database duplication](#).

backup control file

A backup of the control file. You can back up the control file with the RMAN backup command or with the SQL statement `ALTER DATABASE BACKUP CONTROLFILE TO 'filename'`.

backup encryption

The encryption of backup sets by using an algorithm listed in `V $RMAN_ENCRYPTION_ALGORITHMS`. RMAN can transparently encrypt data written to backup sets and decrypt those backup sets when they are needed in a `RESTORE` operation. RMAN offers three modes of encryption: transparent, password protected, and dual mode.

backup mode

The database mode (also called **hot backup mode**) initiated when you issue the `ALTER TABLESPACE . . . BEGIN BACKUP` or `ALTER DATABASE BEGIN BACKUP` command before taking an [online backup](#). You take a tablespace out of backup mode when you issue the `ALTER TABLESPACE . . . END BACKUP` or `ALTER DATABASE END BACKUP` command.

When making a user-managed backup of data files in an online tablespace, you must place the tablespace in backup mode to protect against the possibility of a [fractured block](#). In backup mode, updates to the database create more than the usual amount of redo. Each time a block in the buffer cache becomes dirty, the database must write an image of the changed block to the redo log file, in addition to recording the changes to the data. RMAN does *not* require you to put the database in backup mode.

See Also: [corrupt block](#)

backup optimization

A configuration enabling RMAN to automatically skip backups of files that it has already backed up. You enable and disable backup optimization with the `CONFIGURE` command.

backup piece

The physical file format used to store an [RMAN backup set](#). Each logical backup set contains one or more physical backup pieces.

backup retention policy

A user-defined policy for determining how long backups and archived logs must be retained for media recovery. You can define a retention policy in terms of backup redundancy or a [recovery window](#). RMAN retains the data file backups required to satisfy the current retention policy, and any archived redo logs required for complete recovery of those data file backups.

backup set

A backup of one or more data files, control files, server parameter files, and archived redo log files. Each backup set consists of one or more binary files. Each binary file is called a [backup piece](#). Backup pieces are written in a proprietary format that can only be created or restored by RMAN.

Backup sets are produced by the `RMAN BACKUP` command. A backup set usually consists of only one backup piece. RMAN divides the contents of a backup set among multiple backup pieces only if you limit the backup piece size using the `MAXPIECESIZE` option of the `ALLOCATE CHANNEL` or `CONFIGURE CHANNEL` command.

See Also: [unused block compression](#), [multiplexing](#), [RMAN](#)

backup undo optimization

The exclusion of undo not needed for recovery of an RMAN backup because the it describes and contains already-committed transactions. For example, a user updates the `salaries` table in the `USERS` tablespace. The change is written to the `USERS` tablespace, while the before image of the data is written to the `UNDO` tablespace. A subsequent RMAN backup of the `UNDO` tablespace may not include the undo for the salary change. Backup undo optimization is built-in RMAN behavior and cannot be disabled.

backup window

A period of time during which a backup activity must complete.

base recovery catalog

The entirety of the [recovery catalog](#) schema. The base recovery catalog is distinguished from a [virtual private catalog](#), which is a subset of a recovery catalog.

binary compression

A technique whereby RMAN applies a compression algorithm to data in backup sets.

block change tracking

A database option that causes Oracle Database to track data file blocks affected by each database update. The tracking information is stored in a block change tracking file. When block change tracking is enabled, RMAN uses the record of changed blocks from the change tracking file to improve incremental backup performance by only reading those blocks known to have changed, instead of reading data files in their entirety.

block change tracking file

A binary file used by RMAN to record changed blocks to improve [incremental backup](#) performance. You create and rename this file with the `ALTER DATABASE` statement.

block media recovery

The recovery of specified blocks within a data file with the Recovery Manager `RECOVER . . . BLOCK` command. Block media recovery leaves the affected data files online and restores and recovers only the damaged or corrupted blocks.

breaking a mirror

The termination of a disk mirroring procedure so that a mirror image is no longer kept up-do-date.

CDB

An Oracle Database installation that contains at least one [PDB](#). A CDB also contains one [root](#) and one seed. Every Oracle Database is either a CDB or a [non-CDB](#).

CDB restore point

An alias for an SCN or a point in time in a [multitenant container database \(CDB\)](#). CDB restore points are accessible to all PDBs within the CDB.

channel

An RMAN channel represents one stream of data to or from a backup device. A channel can either be a `DISK` channel (used to perform disk I/O) or an `SBT` channel (used to perform I/O through a third-party [media management software](#)). Each allocated channel starts a new Oracle Database session. The session then performs backup, restore, and recovery operations.

See Also: [target database](#)

channel parallelism

Allocating multiple channels for RMAN operations.

checkpoint

A data structure that defines an SCN in the redo thread of a database. Checkpoints are recorded in the control file and each data file header, and are a crucial element of recovery.

checksum

A number calculated by the database from all the bytes stored in a data or redo block. If the `DB_BLOCK_CHECKSUM` initialization parameter is enabled, then the database calculates the checksum for every data file or online redo log block and stores it in the block header when writing to disk. The database can use the checksum value to check consistency.

circular reuse records

Control file records containing information used by RMAN for backups and recovery operations. These records are arranged in a logical ring. When all available record slots are full, Oracle either expands the control file to make room for a new records or overwrites the oldest record. The `CONTROL_FILE_RECORD_KEEP_TIME` initialization parameter controls how many days records must be kept before they can be overwritten. The default for `CONTROL_FILE_RECORD_KEEP_TIME` is 7 days.

See Also: [noncircular reuse records](#)

closed backup

A backup of one or more database files taken while the database is closed. Typically, closed backups are whole database backups. If you closed the database consistently, then all the files in the backup are consistent. Otherwise, the backups are inconsistent.

See Also: [consistent shutdown](#), [consistent backup](#)

cold backup

See [closed backup](#)

command file

In an RMAN context, a client-side text file containing a sequence of RMAN commands. You can run command files with the `@` or `@@` commands from within RMAN or from the operating system prompt with the `@` or `CMDFILE` parameters.

common user

In a [multitenant container database \(CDB\)](#), a database user that exists with the same identity in the [root](#) and in every existing and future [PDB](#).

complete recovery

Recovery of one or more data files that applies all redo generated after the restored backup. Typically, you perform complete [media recovery](#) when [media failure](#) damages one or more data files or control files. You fully recover the damaged files using all redo generated since the restored backup was taken.

See Also: [incomplete recovery](#)

consistent backup

A [whole database backup](#) that you can open with the `RESETLOGS` option without performing media recovery. You do not need to apply redo to this backup to make it consistent. Unless you apply the redo generated since the consistent backup was created, however, you lose all transactions since the time of the consistent backup.

You can only take consistent backups after you have performed a [consistent shutdown](#) of the database. The database must not be re-opened until the backup has completed.

See Also: [fuzzy file](#), [inconsistent backup](#)

consistent shutdown

A database shut down with the `IMMEDIATE`, `TRASACTIONAL`, or `NORMAL` options of the statement. A database shut down cleanly does not require recovery; it is already in a consistent state.

control file autobackup

The automatic backup of the current control file and server parameter file that RMAN makes after backups and, if the database is in `ARCHIVELOG` mode, after structural changes.

The control file autobackup has a default file name that allows RMAN to restore it even if the control file and recovery catalog are lost. You can override the default file name.

convert script

A script generated by the `CONVERT DATABASE` command that you can use to convert data file formats on the destination host.

copy

To back up a bit-for-bit image of an Oracle file (Oracle data files, control files, and archived redo logs) onto disk. You can copy in two ways:

- Using operating system utilities (for example, the UNIX `cp` or `dd`)
- Using the `RMAN BACKUP AS COPY` command

See Also: [backup](#)

corrupt block

An Oracle block that is not in a recognized Oracle format, or whose contents are not internally consistent. Typically, corruptions are caused by faulty hardware or operating system problems. Oracle identifies corrupt blocks as either logically corrupt (an Oracle internal error) or media corrupt (the block format is not correct).

You can repair a media corrupt block with [block media recovery](#), or dropping the database object that contains the corrupt block so that its blocks are reused for another object. If media corruption is due to faulty hardware, then neither solution works until the hardware fault is corrected.

crash recovery

The automatic application of online redo records to a database after either a single-instance database crashes or all instances of an Oracle Real Applications Cluster configuration crash. Crash recovery only requires redo from the online logs; archived redo logs are not required.

See Also: [recover](#)

cross-platform backup

A backup that is created on the [source database](#) and can be restored on the [destination database](#) that is running on a different platform than the [source platform](#). Cross-platform backups are used to transport data across platforms.

Cross-platform operations can be performed either on the source database or destination database. However, they are often performed on the destination database because this is the usually the non-production database.

crosscheck

A check to determine whether files on disk or in the [media management catalog](#) correspond to the data in the [RMAN repository](#). Because the [media management software](#) can mark tapes as expired or unusable, and because files can be deleted from disk or otherwise become corrupted, the RMAN repository can contain outdated information about backups. Run the CROSSCHECK command to perform a crosscheck.

See Also: [validation](#)

cumulative incremental backup

An [incremental backup](#) that backs up all the blocks changed since the most recent backup at level 0. When recovering with cumulative incremental backups, only the most recent cumulative incremental backup must be applied.

See Also: [differential incremental backup](#), [incremental backup](#)

current incarnation

The database [incarnation](#) in which the database is currently generating redo.

current online redo log

The [online redo log](#) file in which the LGWR background process is currently logging redo records.

See Also: [redo log](#), [redo log group](#)

data integrity check

An invocation of a checker, which is a diagnostic procedure registered with the Health Monitor.

data repair

The use of [media recovery](#) or [Oracle Flashback Technology](#) to recover lost or corrupted data.

Data Recovery Advisor

An Oracle Database tool that automatically diagnoses persistent data failures, presents repair options to the user, and executes repairs at the user's request.

database area

A location for the Oracle managed data files, control files, and online redo log files. The database area is specified by the `DB_CREATE_FILE_DEST` initialization parameter.

database checkpoint

The thread checkpoint that has the lowest SCN. All changes in all enabled redo threads with SCNs before the database checkpoint SCN are guaranteed to have been written to disk.

See Also: [checkpoint](#), [data file checkpoint](#)

database identifier

See [DBID](#)

database point-in-time recovery (DBPITR)

The recovery of an entire database to a specified past target time, SCN, or log sequence number.

See Also: [incomplete recovery](#), [tablespace point-in-time recovery \(TSPITR\)](#)

database registration

See [registration](#)

data file checkpoint

A data structure that defines an SCN in the redo thread of a database for a particular data file. Every data file has a [checkpoint](#) SCN, which you can view in `V$DATAFILE.CHECKPOINT_CHANGE#`. All changes with an SCN lower than this SCN are guaranteed to be in the data file.

data file media recovery

The application of redo records to a restored data file to roll it forward to a more current time. Unless you are doing [block media recovery](#), the data file must be offline while being recovered.

DBID

An internal, uniquely generated number that differentiates databases. Oracle creates this number automatically when you create the database.

destination database

The database into which data from the [source database](#) is being transported.

destination host

The computer on which a [duplicate database](#) resides.

destination platform

When transporting data across platforms, the platform on which the [destination database](#) is running.

differential incremental backup

A type of [incremental backup](#) that backs up all blocks that have changed since the most recent backup at level 1 or level 0. For example, in a differential level 1 backup RMAN determines which level 1 or [level 0 incremental backup](#) is most recent and then backs up all blocks changed since that backup. Differential backups are the default type of incremental backup. When recovering using differential incremental backups, RMAN must apply all differential incremental level 1 backups since the restored data file backup.

See Also: [cumulative incremental backup](#), [incremental backup](#)

direct ancestral path

When multiple OPEN RESETLOGS operations have been performed, the incarnation path that includes the [parent incarnation](#) of the current database incarnation and each [ancestor incarnation](#) of the [current incarnation](#).

disaster recovery

A strategic response to the loss of all data associated with a database installation. For example, a fire may destroy a server in a data center, forcing you to reinstall Oracle Database on a new server and recover the lost database from backups.

disk controller

A hardware component that is responsible for controlling one or more disk drives.

disk group

A collection of disks that are managed as a unit by [Automatic Storage Management \(ASM\)](#). The components of a disk group include disks, files, and allocation units.

disk quota

A user-specified limit to the size of the [fast recovery area](#). When the disk quota is reached, Oracle automatically deletes files that are no longer needed.

duplexed backup set

In RMAN, a duplexed [backup set](#) is an RMAN-generated identical copy of a backup set. Each backup piece in the original backup set is copied, with each copy getting a unique copy number (for example, 0tcm8u2s_1_1 and 0tcm8u2s_1_2).

duplicate database

A database created from target database backups using the RMAN duplicate command.

See Also: [auxiliary database](#)

expired backup

A backup whose status in the RMAN repository is EXPIRED, which means that the backup was not found. RMAN marks backups and copies as expired when you run a CROSSCHECK command and the files are absent or inaccessible.

export

The extraction of logical data (that is, not physical files) from a database into a binary file using Data Pump Export. You can then use Data Pump Import to import the data into a database.

See Also: [logical backup](#)

export dump file

A file created by the Data Pump Export utility. The dump file set is made up of one or more disk files that contain table data, database object metadata, and control information. The files are written in a proprietary, binary format.

failure

For [Data Recovery Advisor](#), a failure is a persistent data corruption that has been diagnosed by the database. A failure can manifest itself as observable symptoms such as error messages and alerts, but a failure is different from a symptom because it represents a diagnosed problem. Failures are recorded in a repository for diagnostic data located outside of the database.

For each failure, Data Recovery Advisor generates a problem statement that unambiguously describes it. Examples of failures include inaccessible data files and corrupted undo segments. Data Recovery Advisor maps every failure to a [repair option](#) or set of repair options.

failure priority

The priority of a [failure](#) diagnosed by [Data Recovery Advisor](#). Every failure that is not closed has CRITICAL, HIGH, or LOW status. You can manually change the status of HIGH and LOW failures with the CHANGE command.

failure status

The status of a [failure](#) diagnosed by [Data Recovery Advisor](#). Every failure has OPEN or CLOSED status.

fast recovery area

An optional disk location that you can use to store recovery-related files such as control file and online redo log copies, archived redo log files, [flashback logs](#), and RMAN backups. Oracle Database and RMAN manage the files in the fast recovery area automatically. You can specify the [disk quota](#), which is the maximum size of the fast recovery area. Formerly referred to as flash recovery area.

file section

A contiguous range of blocks in a data file. A [multisection backup](#) processes a large file in parallel by copying each section to a separate [backup piece](#).

flashback data archive

A historical repository of transactional changes to every record in a table for the duration of the record's lifetime. A flashback data archive enables you to use some [logical flashback features](#) to transparently access historical data from far in the past.

flashback database window

The range of SCNs for which there is currently enough flashback log data to support the FLASHBACK DATABASE command. The flashback database window cannot extend further back than the earliest SCN in the available [flashback logs](#).

flashback logs

Oracle-generated logs used to perform flashback database operations. The database can only write flashback logs to the fast recovery area. Flashback logs are written sequentially and are not archived. They cannot be backed up to disk.

flashback retention target

A user-specified time or SCN that specifies how far into the past you want to be able to perform a flashback of the database.

foreign archived redo log

An archived redo log received by a logical standby database for a LogMiner session. Unlike normal archived logs, foreign archived logs have a different DBID. For this reason, they cannot be backed up or restored on a logical standby database.

foreign data file

A data file that does not belong to the [target database](#), but is being plugged into the target database during a tablespace transport operation.

foreign data file copy

A data file that was created when a [cross-platform backup](#) is restored in the [destination database](#). It cannot be directly plugged in to the destination database because it is inconsistent.

foreign tablespace

A set of [foreign data files](#) that comprise a tablespace in the [source database](#). These foreign data files do not belong to the [target database](#), but are being transported into the target database from the source database.

fractured block

A block in which the header and footer are not consistent at a given SCN. In a [user-managed backup](#), an operating system utility can back up a data file at the same time that DBWR is updating the file. It is possible for the operating system utility to read a block in a half-updated state, so that the block that is copied to the backup media is updated in its first half, while the second half contains older data. In this case, the block is fractured.

For non-RMAN backups, the ALTER TABLESPACE . . . BEGIN BACKUP or ALTER DATABASE BEGIN BACKUP command is the solution for the fractured block problem. When a tablespace is in [backup mode](#), and a change is made to a data block, the database logs a copy of the entire block image before the change so that the database can reconstruct this block if media recovery finds that this block was fractured.

full backup

A non-incremental RMAN backup. The word "full" does not refer to how much of the database is backed up, but to the fact that the backup is not incremental. Consequently, you can make a full backup of one data file.

full resynchronization

An RMAN operation that updates the [recovery catalog](#) with all changed metadata in the database's control file. You can initiate a full catalog [resynchronization](#) by issuing the RMAN command RESYNC CATALOG. (It is rarely necessary to use RESYNC CATALOG because RMAN automatically performs resynchronizations when needed.)

fuzzy file

A data file that contains at least one block with an SCN greater than or equal to the checkpoint SCN in the data file header. Fuzzy files are possible because database writer does not update the SCN in the file header with each file block write. For example, this situation occurs when Oracle updates a data file that is in [backup mode](#). A fuzzy file that is restored always requires [media recovery](#).

guaranteed restore point

A [restore point](#) for which the database is guaranteed to retain the [flashback logs](#) for an [Oracle Flashback Database](#) operation. Unlike a [normal restore point](#), a guaranteed restore point does not age out of the control file and must be explicitly dropped. Guaranteed restore points use space in the [fast recovery area](#), which must be defined.

hot backup

See [online backup](#)

hot backup mode

See [backup mode](#)

image copy

A bit-for-bit [copy](#) of a single data file, archived redo log file, or control file that is:

- Usable as-is to perform recovery (unlike a backup set, which uses [unused block compression](#) and is in an RMAN-specific format)
- Generated with the RMAN `BACKUP AS COPY` command, an operating system command such as the UNIX `cp`, or by the Oracle archiver process

incarnation

A separate version of a database. The incarnation of the database changes when you open it with the `RESETLOGS` option, but you can recover backups from a prior incarnation so long as the necessary redo is available.

incomplete recovery

A synonym for [database point-in-time recovery \(DBPITR\)](#).

See Also: [complete recovery](#), [media recovery](#), [recover](#)

inconsistent backup

A backup in which some files in the backup contain changes that were made after the files were checkpointed. This type of backup needs recovery before it can be made consistent. Inconsistent backups are usually created by taking online database backups. You can also make an inconsistent backup by backing up data files while a database is closed, either:

- Immediately after the crash of an Oracle instance (or, in an Oracle RAC configuration, all instances)
- After shutting down the database using `SHUTDOWN ABORT`

Inconsistent backups are only useful if the database is in `ARCHIVELOG` mode and all archived redo logs created since the backup are available.

See Also: [consistent backup](#), [online backup](#), [system change number \(SCN\)](#), [whole database backup](#)

incremental backup

An RMAN backup in which only modified blocks are backed up. Incremental backups are classified by **level**. A [level 0 incremental backup](#) performs the same function as a [full backup](#) in that they both back up all blocks that have ever been used. The difference is that a full backup does not affect blocks backed up by subsequent incremental backups, whereas an incremental backup affects blocks backed up by subsequent incremental backups.

Incremental backups at level 1 back up only blocks that have changed since previous incremental backups. Blocks that have not changed are not backed up. An incremental backup can be either a [differential incremental backup](#) or a [cumulative incremental backup](#).

incremental forever

After a full backup, only incremental backups are stored. This allows for faster recovery because the current image copy of the database is readily available.

incrementally updated backup

An RMAN data file copy that is updated by an incremental backup. An effective backup strategy is to copy a data file, make an incremental backup, and then merge the incremental backup into the image copy. This strategy reduces the time required for media recovery because the image copy is updated with the latest data block changes.

instance failure

The termination of an Oracle instance due to a hardware failure, Oracle internal error, or SHUTDOWN ABORT statement. Crash or instance recovery is always required after an instance failure.

instance recovery

In an Oracle RAC configuration, the application of redo data to an open database by an instance when this instance discovers that another instance has crashed.

See Also: [recover](#)

interblock corruption

A type of block corruption in which the corruption occurs between blocks rather than within the block itself. This type of corruption can only be [logical corruption](#).

intrablock corruption

A type of block corruption in which the corruption occurs within the block itself. This type of corruption can be either a [physical corruption](#) or [logical corruption](#).

level 0 incremental backup

An RMAN [incremental backup](#) that backs up all data blocks in the data files being backed up. An incremental backup at level 0 is identical in content to a [full backup](#),

but unlike a full backup the level 0 backup is considered a part of the incremental backup strategy.

level of multiplexing

The number of input files simultaneously read and then written into the same RMAN [backup piece](#).

local user

In a [multitenant container database \(CDB\)](#), any user that is not a [common user](#). A local user exists in exactly one [PDB](#).

LogMiner

A utility that enables log files to be read, analyzed, and interpreted by SQL statements.

See Also: [archived redo log](#)

log sequence number

A number that uniquely identifies a set of redo records in a redo log file. When Oracle fills one online redo log file and switches to a different one, Oracle automatically assigns the new file a log sequence number.

See Also: [log switch](#), [redo log](#)

log switch

The point at which LGWR stops writing to the active redo log file and switches to the next available redo log file. LGWR switches when either the active log file is filled with redo records or you force a switch manually.

See Also: [redo log](#)

logical backup

A backup of database schema objects, such as tables. Logical backups are created and restored with the Oracle Data Pump Export utility. You can restore objects from logical backups using the Data Pump Import utility.

logical corruption

A type of corruption in which the block has a valid checksum, the header and footer match, and so on, but the contents are logically inconsistent.

logical flashback features

The set of [Oracle Flashback Technology](#) features other than [Oracle Flashback Database](#). The logical features enable you to view or rewind individual database objects or transactions to a past time.

long-term backup

A backup that you want to exclude from a backup retention policy, but want to record in the recovery catalog. Typically, long-term backups are snapshots of the database that you may want to use in the future for report generation.

lost write

A write to persistent storage that the database believes has occurred based on information from the I/O subsystem, when in fact the write has not occurred.

mean time to recover (MTTR)

The time required to perform recovery.

media failure

Damage to the disks containing any of the files used by Oracle, such as the data files, archived redo log files, or control file. When Oracle detects media failure, it takes the affected files offline.

See Also: [media recovery](#)

media management catalog

A catalog of records maintained by a [media management software](#). This catalog is completely independent from the RMAN [recovery catalog](#). The [Oracle Secure Backup](#) catalog is an example of a media management catalog.

media management library

A software library that RMAN can use to back up to tertiary storage. An [SBT](#) interface conforms to a published API and is supplied by a media management vendor. [Oracle Secure Backup](#) includes an SBT interface for use with RMAN.

media management software

An Oracle or third-party software library that integrates with Recovery Manager so that database backups can be written directly to [SBT](#) devices.

media manager multiplexing

Multiplexing in which the [media management software](#) rather than RMAN manages the mixing of blocks during an RMAN [backup](#). One type of media manager multiplexing occurs when the media manager writes the concurrent output from multiple RMAN channels to a single sequential device. Another type occurs when a backup mixes database files and non-database files on the same tape.

media recovery

The application of redo or incremental backups to a restored backup data file or individual data block.

When performing media recovery, you can recover a database, tablespace, data file, or set of blocks within a data file. Media recovery can be either [complete recovery](#) (in which all changes in the redo logs are applied) or [incomplete recovery](#) (in which only changes up to a specified point in time are applied). Media recovery is only possible when the database is in ARCHIVELOG mode.

See Also: [block media recovery](#), [recover](#)

mirroring

Maintaining identical copies of data on one or more disks. Typically, mirroring is performed on duplicate hard disks at the operating system level, so that if one disk is unavailable, the other disk can continue to service requests without interruptions. When mirroring files, Oracle Database writes once while the operating system writes to multiple disks. When [multiplexing](#) files, Oracle Database writes the same data to multiple files.

MTTR

See [mean time to recover \(MTTR\)](#)

multiplexed backup set

A backup set that contains blocks from multiple input files. For example, you could multiplex 10 data files into one backup set. Only whole files, never partial files, are included in a backup set.

multiplexing

The meaning of the term depends on which files are multiplexed.

Online redo logs: The automated maintenance of multiple identical copies of the online redo log.

Control file: The automated maintenance of multiple identical copies of a database control file.

Backup set: The RMAN technique of reading database files *simultaneously* from the disks and then writing the blocks to the *same* backup piece.

Archived redo logs: The Oracle archiver process can archive multiple copies of a redo log.

See Also: [mirroring](#)

multisection backup

An RMAN backup set in which each [backup piece](#) contains a [file section](#), which is a contiguous range of blocks in a data file. A multisection [backup set](#) contains multiple backup pieces, but a backup set never contains only a part of a data file.

You create a multisection backup by specifying the SECTION SIZE parameter on the BACKUP command. An RMAN [channel](#) can process each file section independently, either serially or in parallel. Thus, in a multisection backup, multiple channels can back up a single file.

multitenant architecture

The architecture that enables an Oracle database to function as a [multitenant container database \(CDB\)](#).

multitenant container database (CDB)

See [CDB](#)

native transfer rate

In a tape drive, the speed of writing to a tape without compression. This speed represents the upper limit of the backup rate.

NOARCHIVELOG mode

The mode of the database in which Oracle does not require filled online redo logs to be archived before they can be overwritten. Specify the mode at database creation or change it with the `ALTER DATABASE NOARCHIVELOG` command.

If you run in NOARCHIVELOG mode, it severely limits the possibilities for recovery of lost or damaged data.

See Also: [archived redo log](#), [ARCHIVELOG mode](#)

non-CDB

An Oracle Database that is not a [multitenant container database \(CDB\)](#). All Oracle Databases created using Oracle Database 11g Release 2 (11.2) or earlier versions are non-CDBs.

noncircular reuse records

Control file records containing critical information needed by the Oracle database. These records are never automatically overwritten. Some examples of information in noncircular reuse records include the locations of data files and online redo logs.

See Also: [circular reuse records](#)

normal restore point

A label for an SCN or time. For commands that support an SCN or time, you can often specify a [restore point](#). Normal restore points exist in the circular list and can be overwritten in the control file. However, if the restore point pertains to an [archival backup](#), then it is preserved in the [recovery catalog](#).

obsolete backup

A backup that is not needed to satisfy the current backup [retention policy](#). For example, if your retention policy dictates that you must maintain one backup of each data file, but you have two backups of data file 1, then the second backup of data file 1 is considered obsolete.

offline normal

A tablespace is offline normal when taken offline with the `ALTER TABLESPACE . . . OFFLINE NORMAL` statement. The data files in the tablespace are checkpointed and do not require recovery before being brought online. If a tablespace is not taken offline normal, then its data files must be recovered before being brought online.

offsite backup

An [SBT](#) backup that requires retrieval by the [media management software](#) before RMAN can restore it. You can list offsite backups with `RESTORE . . . PREVIEW`.

online backup

A backup of one or more data files taken while a database is open and the data files are online.

online redo log

The online redo log is a set of two or more files that record all changes made to the database. Whenever a change is made to the database, Oracle generates a redo record in the redo buffer. The LGWR process writes the contents of the redo buffer into the online redo log.

The [current online redo log](#) is the one being written to by LGWR. When LGWR gets to the end of the file, it performs a [log switch](#) and begins writing to a new log file. If you run the database in `ARCHIVELOG` mode, then each filled online redo log file must be copied to one or more archiving locations before LGWR can overwrite them.

See Also: [archived redo log](#)

online redo log group

The Oracle online redo log consists of two or more online redo log groups. Each group contains one or more identical online redo log members. An [online redo log member](#) is a physical file containing the redo records.

online redo log member

A physical online redo log file within an [online redo log group](#). Each log group must have one or more members. Each member of a group is identical.

operating system backup

See [user-managed backup](#)

operating system backup and recovery

See [user-managed backup and recovery](#)

Oracle Enterprise Manager Cloud Control

The primary product for managing your database is Oracle Enterprise Manager Cloud Control (Cloud Control), a Web-based interface. After you have installed the Oracle

Database software, created or upgraded a database, and configured the network, you can use Cloud Control to manage your database. Cloud Control also provides an interface for performance advisors and for Oracle utilities such as SQL*Loader and Recovery Manager (RMAN).

Oracle Flashback Database

The return of the whole database to a prior consistent SCN by the `FLASHBACK DATABASE` command in RMAN or SQL. A database flashback is different from traditional media recovery because it does not involve the restore of physical files, instead restoring your current data files to past states using saved images of changed data blocks. This feature uses [flashback logs](#) and archived redo logs.

Oracle Flashback Technology

A set of Oracle Database features that provide an additional layer of data protection. These features include Oracle Flashback Query, Oracle Flashback Version Query, Oracle Flashback Transaction Query, Oracle Flashback Transaction, Oracle Flashback Table, Oracle Flashback Drop, and [Oracle Flashback Database](#).

You can use flashback features to view past states of data and rewind parts or all of your database. In general, flashback features are more efficient and less disruptive than media recovery in most situations in which they apply.

Oracle managed file

A database file managed by the Oracle Managed Files feature.

Oracle Managed Files (OMF)

A service that automates naming, location, creation, and deletion of database files such as control files, redo log files, data files and others, based on a few initialization parameters. You can use Oracle managed files on top of a traditional file system supported by the host operating system, for example, VxFS or ODM. It can simplify many aspects of the database administration by eliminating the need to devise your own policies for such details.

Oracle Secure Backup

An Oracle media manager that supplies reliable data protection through file system backup to tape. The Oracle Secure Backup [SBT](#) interface also enables you to use RMAN to back up Oracle databases. All major tape drives and tape libraries in SAN, Gigabit Ethernet, and SCSI environments are supported.

Oracle-suggested backup strategy

A backup strategy available through a wizard in Oracle Enterprise Manager. The strategy involves periodically applying a level 1 [incremental backup](#) to a level 0 backup to create an [incremental forever](#). If run daily, this strategy provides 24 hour [point-in-time recovery](#) from disk.

Oracle VSS writer

A service on Windows systems that acts as coordinator between an Oracle Database instance and other [Volume Shadow Copy Service \(VSS\)](#) components, enabling data

providers to create a shadow copy of files managed by the Oracle instance. For example, the Oracle VSS writer can place data files in hot backup mode to provide a recoverable copy of these data files in a shadow copy set.

orphaned backups

Backups that were not made in the [direct ancestral path](#) of the [current incarnation](#) of the database. Orphaned backups cannot be used in the current incarnation.

parallel recovery

A form of recovery in which several processes simultaneously apply changes from redo log files. The `RECOVERY_PARALLELISM` initialization parameter determines the level of parallelism for instance and crash recovery. You can use the `PARALLEL` and `NOPARALLEL` options of the `RECOVER` command to control parallelism for media recovery. Oracle Database automatically chooses the optimum degree of recovery parallelism. Usually, manually setting the level of parallelism for instance, crash, or media recovery is not recommended or necessary.

parent incarnation

The database [incarnation](#) from which the [current incarnation](#) branched following an `OPEN RESETLOGS` operation.

partial resynchronization

A type of [resynchronization](#) in which RMAN transfers data about archived logs, backup sets, and data file copies from the target control file to the [recovery catalog](#).

password file

A file created by the `ORAPWD` command, and required if you want to connect using the `SYSDBA` or `SYSBACKUP` privilege over a network. For details on password files, see the *Oracle Database Administrator's Guide*.

PDB

In a [multitenant container database \(CDB\)](#), a portable collection of schemas, schema objects, and nonschema objects that appears to an Oracle Net client as a [non-CDB](#).

PDB restore point

An alias for an SCN or a point in time in a particular [pluggable database \(PDB\)](#). A PDB restore point is applicable only to the PDB in which it is defined and cannot be used to perform operations either on other PDBs or the CDB.

physical backup

A backup of physical files. A physical backup contrasts with a logical backup such as a table export.

physical corruption

A type of corruption in which the database does not recognize a [corrupt block](#). The database may not recognize the block because the checksum is invalid, the block contains all zeros, or the header and footer of the block do not match.

physical schema

The data files, control files, and redo logs in a database at a given time. Issue the RMAN REPORT SCHEMA command to obtain a list of tablespaces and data files.

physical standby database

A copy of a production database that you can use for disaster protection.

pluggable database (PDB)

See [PDB](#)

point-in-time recovery

The incomplete recovery of database files to a noncurrent time. Point-in-time recovery is also known as [incomplete recovery](#).

See Also: [media recovery](#), [recover](#)

problem

A critical error in the database that is recorded in the [Automatic Diagnostic Repository \(ADR\)](#). Critical errors include internal errors and other severe errors. Each problem has a problem key, which is a set of attributes that describe the problem. The problem key includes the ORA error number, error parameter values, and other information.

proxy copy

A backup in which the [media management software](#) manages the transfer of data between the media storage device and disk during RMAN backup and restore operations.

raw device

A disk or partition without a file system. Thus, you cannot use `ls`, Windows Explorer, and so on to view their contents. The raw partition appears to Oracle Database as a single file.

recover

To recover a database file or a database is typically to perform [media recovery](#), [crash recovery](#), or [instance recovery](#). This term can also be used generically to refer to reconstructing or re-creating lost data by any means.

See Also: [complete recovery](#), [incomplete recovery](#)

recovery

When used to refer to a database file or a database, the application of redo data or incremental backups to database files to reconstruct lost changes. The three types of recovery are [instance recovery](#), [crash recovery](#), and [media recovery](#). Oracle Database performs the first two types of recovery automatically using online redo records; only media recovery requires you to restore a backup and issue commands.

See Also: [complete recovery](#), [incomplete recovery](#)

recovery catalog

A set of Oracle tables and views used by RMAN to store RMAN repository information about one or more Oracle databases. RMAN uses this metadata to manage the backup, restore, and recovery of Oracle databases.

Use of a recovery catalog is optional although it is highly recommended. For example, starting with Oracle Database 11g, a single recovery catalog schema can keep track of database file names for all databases in a Data Guard environment. This catalog schema also keeps track of where the online redo logs, standby redo logs, temp files, archived redo logs, backup sets, and image copies are created for all databases.

The primary storage for RMAN repository information for a database is always in the control file of the database. A recovery catalog is periodically updated with RMAN repository data from the control file. For the loss of a control file, the recovery catalog can provide most or all of the lost metadata required for restore and recovery of the database. The recovery catalog can also store records of archival backups and RMAN stored scripts for use with target databases.

See Also: [recovery catalog database](#)

recovery catalog database

An Oracle Database that contains a recovery catalog schema.

recovery catalog schema

The [recovery catalog database](#) schema that contains the [recovery catalog](#) tables and views.

Recovery Manager (RMAN)

The primary utility for physical backup and recovery of Oracle databases. RMAN keeps records of Oracle databases in its own structure called an RMAN repository, manages storage of backups, validates backups. You can use it with or without the central information repository called a [recovery catalog](#). If you do not use a recovery catalog, then RMAN uses the database's control file to store information necessary for backup and recovery operations. You can use RMAN with third-party media management software to back up files to tertiary storage.

See Also: [backup piece](#), [backup set](#), [copy](#), [media management software](#), [recovery catalog](#)

recovery set

One or more tablespaces that are being recovered to an earlier point in time during [tablespace point-in-time recovery \(TSPITR\)](#). After TSPITR, all database objects in the recovery set have been recovered to the same point in time.

See Also: [auxiliary set](#)

recovery window

A recovery window is one type of RMAN backup [retention policy](#), in which the DBA specifies a period of time and RMAN ensures retention of backups and archived redo logs required for point-in-time recovery to any time during the recovery window. The interval always ends with the current time and extends back in time for the number of days specified by the user.

For example, if the retention policy is set for a recovery window of seven days, and the current time is 11:00 AM on Tuesday, RMAN retains the backups required to allow point-in-time recovery back to 11:00 AM on the previous Tuesday.

recycle bin

A data dictionary table containing information about dropped objects. Dropped tables and any associated objects such as indexes, constraints, nested tables, and so on are not removed and still occupy space. The Flashback Drop feature uses the recycle bin to retrieve dropped objects.

redo log

A redo log can be either an [online redo log](#) or an [archived redo log](#). The online redo log is a set of two or more redo log groups that records all changes made to Oracle data files and control files. An archived redo log is a copy of an online redo log that has been written to an offline destination.

redo log group

Each online redo log member (which corresponds to an online redo log file) belongs to a redo log group. Redo log groups contain one or more members. A redo log group with multiple members is called a multiplexed redo log group. The contents of all members of a redo log group are identical.

redo thread

The redo generated by an instance. If the database runs in a single instance configuration, then the database has only one thread of redo.

redundancy

In a [retention policy](#), the setting that determines many copies of each backed-up file to keep. A redundancy-based retention policy is contrasted with retention policy that uses a [recovery window](#).

redundancy set

A set of backups enabling you to recover from the failure or loss of any Oracle Database file.

registration

In RMAN, the execution of a `REGISTER DATABASE` command to record the existence of a target database in the [recovery catalog](#). A [target database](#) is uniquely identified in the catalog by its `DBID`. You can register multiple databases in the same catalog, and also register the same database in multiple catalogs.

repair

For [Data Recovery Advisor](#), a repair is an action or set of actions that fixes one or more [failures](#). Examples repairs include [block media recovery](#), [data file media recovery](#), [Oracle Flashback Database](#), and so on.

repair option

For [Data Recovery Advisor](#), one possible technique for repairing a [failure](#). Different repair options are intended to fix the same problem, but represent different advantages and disadvantages in terms of repair time and data loss.

RESETLOGS

A technique for opening a database that archives any current online redo logs (if using `ARCHIVELOG` mode), resets the log sequence number to 1, and clears the online redo logs. An `ALTER DATABASE OPEN RESETLOGS` statement begins a new database incarnation. The starting SCN for the new incarnation, sometimes called the `RESETLOGS SCN`, is the incomplete recovery SCN of the media recovery preceding the `OPEN RESETLOGS`, plus one.

An `ALTER DATABASE OPEN RESETLOGS` statement is required after incomplete recovery or recovery with a backup control file. An `OPEN RESETLOGS` operation does not affect the recoverability of the database. Backups from before the `OPEN RESETLOGS` operation remain valid and can be used along with backups taken after the `OPEN RESETLOGS` operation to repair any damage to the database.

resilver a split mirror

The process of making the contents of a split mirror identical with the contents of the storage devices from which the mirror was split. The operating system or the hardware managing the mirror refreshes a broken mirror from the half that is up-to-date and then maintains both sides of the mirror.

restartable backup

The feature that enables RMAN to back up only those files that have not been backed up since a specified date. The unit of restartability is last completed backup set or image copy. You can use this feature after a backup fails to back up the parts of the database missed by the failed backup.

restore

The replacement of a lost or damaged file with a backup. You can restore files either with commands such as UNIX `cp` or the RMAN `RESTORE` command.

restore failover

The automatic search by RMAN for usable backups in a restore operation if a corrupted or inaccessible backup is found.

restore optimization

The default behavior in which RMAN avoids restoring data files from backup when possible.

restore point

A user-defined name associated with an SCN of the database corresponding to the time of the creation of the restore point. A restore point can be a [guaranteed restore point](#) or a [normal restore point](#).

resynchronization

The operation that updates the [recovery catalog](#) with current metadata from the target database control file. You can initiate a [full resynchronization](#) of the catalog by issuing a `RESYNC CATALOG` command. A [partial resynchronization](#) transfers information to the recovery catalog about archived redo log files, backup sets, and data file copies. RMAN resynchronizes the recovery catalog automatically when needed.

retention policy

See [backup retention policy](#)

reverse resynchronization

In a Data Guard environment, the updating of a primary or standby database control file with metadata obtained from the [recovery catalog](#). For example, if you configure persistent RMAN settings for a standby database that is not the connected target database, then RMAN performs a reverse resynchronization the next time RMAN connects as target to the standby database. In this way, the recovery catalog keeps the metadata in the control files in a Data Guard environment up to date.

RMAN

See [Recovery Manager \(RMAN\)](#)

RMAN backup job

The set of `BACKUP` commands executed within a single [RMAN session](#). For example, assume that you start the RMAN client, execute `BACKUP DATABASE, BACKUP ARCHIVELOG`, and `RECOVER COPY`, and then exit the RMAN client. The RMAN backup job consists of the database backup and the archived redo log backup.

RMAN client

An Oracle Database executable that interprets commands, directs server sessions to execute those commands, and records its activity in the target database control file. The RMAN executable is automatically installed with the database and is typically located in the same directory as the other database executables. For example, the RMAN client on Linux is named `rman` and is located in `$ORACLE_HOME/bin`.

RMAN job

The set of RMAN commands executed in an [RMAN session](#). For example, assume that you start the RMAN client, execute `BACKUP DATABASE`, `BACKUP ARCHIVELOG`, and `RECOVER COPY`, and then exit the RMAN client. The RMAN job consists of the two backups and the roll forward of the data file copy.

RMAN maintenance commands

Commands that you can use to manage RMAN metadata records and backups. The maintenance commands are `CATALOG`, `CHANGE`, `CROSSCHECK`, and `DELETE`.

RMAN repository

The record of RMAN metadata about backup and recovery operations on the target database. The authoritative copy of the RMAN repository is always stored in the control file of the target database. A [recovery catalog](#) can also be used for longer-term storage of the RMAN repository, and can serve as an alternate source of RMAN repository data if the control file of your database is lost.

See Also: [recovery catalog database](#), [resynchronization](#)

RMAN session

An RMAN session begins when the RMAN client is started and ends when you exit from the client or the RMAN process is terminated. Multiple RMAN commands can be executed in a single RMAN session.

rollback segments

Database segments that record the before-images of changes to the database.

rolling back

The use of rollback segments to undo uncommitted changes applied to the database during the [rolling forward](#) stage of recovery.

rolling forward

The application of redo records or incremental backups to data files and control files to [recover](#) changes to those files.

See Also: [rolling back](#)

root

In a [multitenant container database \(CDB\)](#), a system-supplied set of schemas, schema objects, and non-schema objects that functions as the parent for [PDBs](#). Every CDB has only one root and all PDBs belong to the root.

RUN block

A series of RMAN commands that are executed sequentially.

SBT

System Backup to Tape. This term specifies a nondisk backup device type, typically a tape library or tape drive. RMAN supports channels of type disk and SBT.

shadow copy

In the [Volume Shadow Copy Service \(VSS\)](#) infrastructure on Windows, a consistent snapshot of a component or volume.

snapshot control file

A copy of a database control file created in an operating system-specific location by Recovery Manager. RMAN creates the snapshot control file so that it has a consistent version of a control file to use when either resynchronizing the recovery catalog or backing up the control file.

source database

The database that you are copying when you create a [duplicate database](#). When transporting data to another platform, the source database is the database that contains the data that is to be transported.

source host

The host on which a [source database](#) resides.

source platform

When transporting data, the platform on which the [source database](#) is running. The source database contains the data to be transported to a [destination database](#) running on a different platform.

sparse backup

An RMAN backup that backs up one or more sparse data files. For each sparse data file, a full backup of the shadow file (not the base file) is created.

sparse database

A database that contains one or more sparse data files.

sparse data file

A logical Oracle object that is created as the shadow of a base data file. The base data file is read-only. The sparse data file is read-write and contains the updates made to the base data file.

split mirror backup

A backup of database files that were previously mirrored. Some third-party tools enable you to use [mirroring](#) a set of disks or logical devices, that is, maintain an exact duplicate of the primary data in another location. Splitting a mirror involves separating the file copies so that you can use them independently. With the `ALTER SYSTEM SUSPEND/RESUME` database feature, you can suspend I/O to the database, split the mirror, and make a backup of the split mirror.

stored script

A sequence of RMAN commands stored in the [recovery catalog](#). Stored scripts can be global or local. Global scripts can be shared by all databases registered in the recovery catalog.

synchronous I/O

A server process can perform only one task at a time while RMAN is either reading or writing data.

system change number (SCN)

A stamp that defines a committed version of a database at a point in time. Oracle assigns every committed transaction a unique SCN.

tablespace destination

In a [transportable tablespace](#) operation, the location on disk which (by default) contains the data file copies and other output files when the tablespace transport command completes.

tablespace point-in-time recovery (TSPITR)

The recovery of one or more non-SYSTEM tablespaces to a noncurrent time. You use RMAN to perform TSPITR.

tag

Identifier for an RMAN backup. If you generate a backup set, then the tag is assigned to each backup piece rather than to the backup set. If you do not specify a tag for a backup, then RMAN assigns one automatically.

target database

In an RMAN environment, the database to which you are connected as `TARGET`. The target database is the database on which you are performing RMAN operations.

target host

The computer on which a [target database](#) resides.

target instance

In an RMAN environment, the instance associated with a [target database](#).

temp file

A file that belongs to a temporary tablespace and is created with the `TEMPFILE` option. Temporary tablespaces cannot contain permanent database objects such as tables, and are typically used for sorting. Because temp files cannot contain permanent objects, RMAN does not back them up. RMAN does keep track of the locations of temp files in the control file, however, and during recovery re-creates the temp files as needed at those locations.

transport script

A script generated by the `CONVERT DATABASE` command. This script contains SQL statements used to create the new database on the [destination platform](#).

transportable tablespace

A feature that transports a set of tablespaces from one database to another, or from one database to itself. Transporting a tablespace into a database is like creating a tablespace with loaded data.

transportable tablespace set

Data files for the set of tablespaces in a transportable tablespace operation, and an export file containing metadata for the set of tablespaces. You use Data Pump Export to perform the export of metadata.

trial recovery

A simulated recovery initiated with the `RECOVER . . . TEST` command in RMAN or SQL*Plus. A trial recovery applies redo in a way similar to normal [media recovery](#), but it never writes its changes to disk and it always rolls back its changes. Trial recovery occurs only in memory.

undo retention period

The minimum amount of time that Oracle Database attempts to retain old undo data in the [undo tablespace](#) before overwriting it. Old (committed) undo data that is older than the current undo retention period is said to be expired. Old undo data with an age that is less than the current undo retention period is said to be unexpired.

undo tablespace

A dedicated tablespace that stores only undo information when the database is run in [automatic undo management mode](#).

unused block compression

A feature by which RMAN reduces the size of data file backup sets by skipping data blocks. RMAN always skips blocks that have never been used. Under certain conditions, which are described in the `BACKUP AS BACKUPSET` entry in *Oracle Database Backup and Recovery Reference*, RMAN also skips previously used blocks that are not currently being used.

user-managed backup

A backups made using a non-RMAN method, for example, using an operating system utility. For example, you can make a user-managed backup by running the `cp` command on Linux or the `COPY` command on Windows. A user-managed backup is also called an [operating system backup](#).

user-managed backup and recovery

A backup and recovery strategy for an Oracle Database that does not use RMAN. This term is equivalent to [operating system backup and recovery](#). You can back up and restore database files using operating system utilities (for example, the `cp` command in UNIX), and recover using the SQL*Plus `RECOVER` command.

validation

In an RMAN context, a test that checks database files for block corruption or checks a backup set to determine whether it can be restored. RMAN can check for both physical and logical block corruption.

virtual private catalog

A subset of the metadata in a base [recovery catalog](#) to which a database user is granted access. The owner of a base recovery catalog can grant or revoke restricted access to the recovery catalog to other database users. Each restricted user has full read/write access to his own virtual private catalog.

Volume Shadow Copy Service (VSS)

An infrastructure on Windows server platforms that enables requestors, writers, and providers to participate in the creation of a consistent snapshot called a [shadow copy](#). The VSS service uses well-defined COM interfaces. See *Oracle Database Platform Guide for Microsoft Windows* to learn how to use RMAN with VSS.

whole database backup

A [backup](#) of the control file and all data files that belong to a database.

Zero Data Loss Recovery Appliance (Recovery Appliance)

An enterprise-level, cloud-scale Engineered System, that provides a single, centralized repository for backups of all your Oracle Databases. You can use RMAN commands to backup your target databases to Recovery Appliance.

Symbols

- %d substitution variable
 - BACKUP FORMAT, [2-5](#)
- %p substitution variable
 - BACKUP FORMAT, [2-5](#)
- %s substitution variable
 - BACKUP FORMAT, [2-5](#)
- %t substitution variable
 - BACKUP FORMAT, [2-5](#)
- %U substitution variable
 - BACKUP FORMAT, [2-5](#)

A

- ABORT option
 - SHUTDOWN statement, [30-24](#), [31-1](#), [31-2](#)
 - about
 - backing up CDBs, [4-7](#)
 - backing up PDBs, [4-7](#)
 - about, flashback database for CDBs, [18-4](#)
 - about, flashback database for PDBs, [18-4](#)
 - active database duplication, [4-10](#)
 - Advanced Security Option, [8-6](#)
 - ADVISE FAILURE command, [15-4](#), [15-11](#)
 - alert log, [12-5](#)
 - ALLOCATE CHANNEL command
 - MAXPIECESIZE option, [6-5](#)
 - ALLOW ... CORRUPTION clause, RECOVER command, [30-31](#)
 - ALTER DATABASE statement
 - CLEAR LOGFILE clause, [31-17](#)
 - END BACKUP clause, [29-10](#)
 - OPEN RESETLOGS clause, [13-35](#)
 - RECOVER clause, [30-10](#), [30-12](#), [30-16](#)
 - RESETLOGS option, [30-25](#)
 - ALTER SYSTEM statement
 - KILL SESSION clause, [24-15](#)
 - RESUME clause, [29-18](#)
 - SUSPEND clause, [29-17](#)
 - ALTER TABLESPACE statement
 - BEGIN BACKUP clause, [29-7](#), [29-9](#)
 - END BACKUP option, [29-9](#)
 - application containers
 - about backing up, [9-20](#)
 - backing up, [9-20](#), [9-21](#)
 - complete recovery, [17-31](#)
 - application errors, [1-3](#)
 - application PDBs
 - backing up, [9-22](#)
 - complete recovery, [17-31](#)
 - point-in-time recovery, [18-32](#)
 - application root
 - backing up, [9-21](#)
 - complete recovery, [17-29](#)
 - archival backups, [1-4](#), [9-44](#), [12-15](#)
 - archived redo log deletion policies, [5-36](#), [5-37](#), [9-30](#)
 - archived redo log files
 - applying during media recovery, [30-6](#), [30-8](#), [30-10](#)
 - backing up
 - using RMAN, [9-27](#)
 - with other backups, [9-28](#)
 - backing up, in CDBs, [9-31](#)
 - cataloging, [12-17](#)
 - changing default location, [30-9](#)
 - corrupted, [30-26](#)
 - delete after backups, [9-32](#)
 - delete after backups, in CDBs, [9-33](#)
 - deleting, [14-7](#), [30-12](#)
 - deletion after backup, [9-27](#)
 - failover, [9-27](#)
 - incompatible format, [30-26](#)
 - location during recovery, [30-6](#)
 - loss of, [30-20](#)
 - restoring using RMAN, [17-10](#)
- ARCHIVELOG mode
 - backups in, [2-5](#)
 - AS SELECT clause
 - CREATE TABLE statement, [31-11](#)
 - autobackups, control file
 - configuring, [5-8](#)
 - format, [5-8](#)
 - automated repairs
 - Data Recovery Advisor, [1-9](#)
 - automatic channel allocation, [6-1](#)

- automatic channels
 - configuring, [6-2](#)
 - naming conventions, [3-4](#)
 - overriding, [6-1](#)
- Automatic Diagnostic Repository (ADR), [5-13](#), [8-16](#), [12-4](#), [15-2](#), [16-2](#), [16-3](#), [24-2](#)
- Automatic Storage Management (ASM)
 - backups to, [9-4](#)
- Automatic Workload Repository (AWR), [7-19](#)
- AUTORECOVERY option
 - SET statement, [30-7](#)
- auxiliary instance parameter file
 - with TRANSPORT TABLESPACE, [27-5](#)
- availability
 - of RMAN backups, [12-15](#)
- AVAILABLE option
 - of CHANGE command, [12-15](#)

B

- backing up
 - application containers, [9-21](#)
 - application PDBs, [9-22](#)
 - application root, [9-21](#)
 - data files in PDBs, [9-19](#)
 - database, [9-1](#)
 - sparse PDBs, [9-26](#)
 - tablespaces in PDBs, [9-19](#)
 - with Oracle Enterprise Manager Cloud Control, [1-11](#)
- backup
 - to Recovery Appliance, [3-10](#)
- backup and recovery
 - definition, [1-1](#)
 - introduction, [1-1](#)
 - solutions, [1-4](#)
 - strategy, [1-2](#)
 - user-managed, [1-4](#)
- BACKUP command
 - ALLOW INCONSISTENT option, [28-35](#), [28-36](#)
 - ARCHIVELOG option, [9-28](#), [9-29](#)
 - AS COMPRESSION BACKUPSET option, [9-7](#)
 - AS COPY option, [2-4](#), [8-10](#)
 - BACKUPSET option, [6-9](#), [8-13](#), [8-14](#), [9-48](#), [9-50](#)
 - CHANNEL option, [5-6](#)
 - COMPRESSED BACKUPSET option, [9-7](#)
 - COPIES parameter, [8-13](#)
 - COPY OF option, [8-13](#), [8-15](#), [9-48](#), [9-51](#)
 - CURRENT CONTROLFILE option, [9-12](#), [9-13](#)
 - DATABASE option, [9-10](#)
 - DATAFILE option, [9-11](#)
 - DATAPUMP option, [28-23](#), [28-31](#), [28-37](#)
 - DB_FILE_NAME_CONVERT parameter, [8-10](#)
 - DELETE INPUT option, [9-32](#), [12-21](#)
 - DELETE option, [9-27](#)
 - DEVICE TYPE clause, [5-3](#), [5-31](#), [9-3](#), [9-13](#)

- BACKUP command (*continued*)
 - DURATION parameter, [10-15](#)
 - FILESERSET parameter, [8-8](#)
 - FOR RECOVER OF COPY option, [9-36](#)
 - FOR TRANSPORT parameter, [28-23](#), [28-28](#)
 - FORMAT parameter, [2-5](#), [5-12](#), [5-15](#), [8-6](#), [8-13](#), [9-4](#)
 - INCREMENTAL LEVEL 1 parameter, [28-36](#), [28-37](#)
 - INCREMENTAL LEVEL O parameter, [28-35](#), [28-37](#)
 - INCREMENTAL option, [2-7](#), [2-8](#), [9-33](#), [9-35](#), [9-36](#)
 - KEEP option, [9-44](#), [9-46](#), [9-47](#)
 - MAXSETSIZE parameter, [10-1](#)
 - NOT BACKED UP clause, [9-30](#)
 - PLUS ARCHIVELOG option, [9-28](#)
 - PROXY ONLY option, [8-10](#)
 - PROXY option, [8-10](#)
 - RECOVERY AREA option, [9-48](#)
 - SECTION SIZE parameter, [8-4](#), [9-8](#), [10-3](#)
 - SPFILE option, [9-14](#)
 - TABLESPACE option, [9-11](#)
 - TAG parameter, [2-5](#), [9-5](#)
 - TO PLATFORM parameter, [28-23](#), [28-31](#)
 - VALIDATE option, [2-9](#), [15-2](#), [15-9](#), [16-4](#)
- BACKUP CONTROLFILE clause
 - ALTER DATABASE statement, [29-2](#)
- BACKUP COPIES parameter
 - CONFIGURE command, [6-5](#)
- backup encryption
 - decrypting backups, [17-11](#)
 - default algorithm, [6-9](#)
 - dual-mode, [6-12](#), [10-13](#)
 - overview, [10-11](#)
 - password, [6-11](#), [10-12](#)
 - transparent, [6-10](#), [10-12](#)
- backup mode
 - ending with ALTER DATABASE END BACKUP, [29-10](#)
 - for online user-managed backups, [29-7](#), [29-22](#)
 - instance failure, [29-9](#)
- backup optimization
 - configuring, [5-31](#), [10-4](#)
 - definition, [5-31](#), [9-30](#)
 - disabling, [5-31](#), [5-35](#)
 - enabling, [5-31](#), [5-35](#)
 - redundancy and, [5-34](#)
 - retention policies and, [5-33](#)
- backup pieces
 - definition, [2-4](#)
 - maximum size, [6-5](#)
 - names, [8-6](#)
 - names on tape, [5-15](#)
- backup retention policies
 - affect on backup optimization, [5-33](#)
 - configuring, [5-29](#)

- backup retention policies (*continued*)
 - configuring for redundancy, [5-30](#)
 - definition, [8-22](#)
 - disabling, [5-31](#)
 - exempt backups, [9-44](#), [12-15](#)
 - recovery window, [8-22](#)
 - recovery windows, [5-30](#)
 - redundancy, [8-22](#), [8-25](#)
- backup sets
 - backing up, [8-14](#), [9-48](#)
 - backups
 - backups of, [8-14](#)
 - compressed, [5-4](#), [6-7](#), [9-7](#)
 - configuring as default, [5-4](#)
 - configuring maximum size, [6-4](#)
 - crosschecking, [12-12](#)
 - duplexing, [10-7](#)
 - how RMAN generates, [8-7](#)
 - limiting size, [8-7](#)
 - maximum size, [6-4](#), [10-1](#)
 - multiplexed, [2-4](#), [6-4](#), [8-8](#), [9-6](#), [23-4](#)
 - naming, [8-6](#)
 - overview, [8-3](#)
 - Recovery Manager
 - backups
 - backing up, [8-14](#)
 - specifying maximum size, [8-7](#)
 - specifying number, [8-7](#)
 - testing restore of, [17-9](#)
- Backup Solutions Program (BSP), [3-7](#)
- backup strategy
 - fast recovery area, [5-19](#)
- backup tags, RMAN, [9-5](#)
- backup techniques, comparison, [1-4](#)
- backup windows, [10-15](#)
- backups
 - archival, [1-4](#), [9-44](#)
 - archived redo log files, in CDBs, [9-31](#)
 - archived redo logs
 - using RMAN, [9-27](#)
 - availability, [12-15](#)
 - backup sets, [9-48](#)
 - closed, [29-3](#)
 - consistent
 - making using RMAN, [8-2](#)
 - control file, [9-12](#), [29-14](#)
 - control files
 - binary, [29-14](#)
 - correlating RMAN channels with, [24-11](#)
 - crosschecking, [12-11](#)
 - cumulative incremental, [8-19](#)
 - data file
 - using RMAN, [9-50](#), [9-51](#)
 - DBVERIFY utility, [29-23](#)
 - default type for RMAN, [5-4](#)
 - determining data file status, [29-2](#)
- backups (*continued*)
 - duplexing, [6-5](#), [10-7](#)
 - excluding tablespaces from backups, [6-6](#)
 - exempt from retention policy, [12-15](#)
 - expired, deleting, [12-25](#)
 - generating reports for, [11-1](#), [11-10](#)
 - image copies, [8-10](#)
 - inconsistent
 - making using RMAN, [8-2](#)
 - incremental, [8-18](#), [9-33](#), [10-8](#), [10-9](#)
 - incrementally updated, [9-36](#)
 - listing files needed, [29-1](#)
 - logical, [1-2](#)
 - long-term, [1-4](#)
 - managing, [12-1](#)
 - multisection, [3-4](#), [8-4](#), [16-4](#)
 - NOARCHIVELOG mode, [9-15](#)
 - obsolete, [8-25](#), [12-26](#)
 - offline, [29-5](#)
 - offsite, [17-8](#)
 - optimizing, [5-31](#), [9-30](#)
 - orphaned, [14-10](#)
 - PDBs, using Oracle Enterprise Manager Cloud Control, [9-18](#)
 - PDBs, using RMAN, [9-18](#)
 - physical, [1-2](#)
 - previewing, [17-7](#)
 - read-only tablespaces, [29-11](#)
 - recovering pre-RESETLOGS, [18-38](#)
 - recovery catalog, [13-17](#)
 - Recovery Manager, [9-2](#)
 - reporting objects needing backups, [11-11](#)
 - restartable, [10-14](#)
 - restoring user-managed, [30-5](#)
 - root
 - using Oracle Enterprise Manager Cloud Control, [9-17](#)
 - using RMAN, [9-17](#)
 - server parameter files, [9-14](#)
 - skipping files during, [10-7](#)
 - split mirror
 - using RMAN, [10-9](#)
 - stored scripts, [13-3](#), [13-20](#)
 - tablespace
 - using RMAN, [9-11](#), [9-50](#), [9-51](#)
 - testing RMAN
 - using media manager, [5-14](#)
 - user-managed, [29-1](#)
 - using storage snapshots, [29-22](#)
 - validating, [16-4](#), [16-6](#)
 - verifying, [29-23](#)
 - whole CDB, [9-16](#)
 - whole database, [9-10](#), [29-3](#)
- BEGIN BACKUP clause
 - ALTER TABLESPACE statement, [29-7](#)
- binary compression for backups, [9-7](#)

- block change tracking
 - disk space used for, [9-42](#)
 - enabling and disabling, [9-42](#), [9-43](#)
 - moving the change tracking file, [9-43](#)
- block corruptions
 - stored in V\$DATABASE_BLOCK_CORRUPTION, [16-4](#)
- block media recovery
 - automatic, [19-2](#)
- BSP, [3-7](#)

C

- cancel-based media recovery, [30-23](#)
- canceling RMAN commands, [24-14](#)
- CATALOG command
 - START WITH parameter, [13-10](#)
- CDB restore point, [7-6](#)
- CDB restore points, creating, [7-12](#)
- CDB restore points, viewing, [7-15](#)
- CDB, rewinding, [18-19](#)
- CDBs
 - about backup and recovery of, [4-7](#)
 - backing up, [9-16](#)
 - complete recovery
 - after switching to a copy, [17-29](#)
 - using Oracle Enterprise Manager Cloud Control, [17-25](#)
 - complete restore, [17-20](#)
 - connecting to, [4-7](#)
 - crash recovery, [30-19](#)
 - Data Recovery Advisor, [15-7](#)
 - diagnose failures, [15-7](#)
 - instance recovery, [30-19](#)
 - performing point-in-time recovery, [18-28](#)
 - repairing failures, [15-7](#)
 - reporting, [11-16](#)
 - transporting across platforms, [28-42](#)
 - user-managed backups, [29-4](#)
 - validating, [16-9](#)
- CDBs, restore points, [7-6](#)
- CHANGE command
 - AVAILABLE option, [12-15](#)
 - DB_UNIQUE_NAME parameter, [13-31](#)
 - RESET DB_UNIQUE_NAME option, [3-9](#)
 - UNCATALOG option, [12-20](#)
- CHANGE FAILURE command, [15-16](#)
- channels, RMAN
 - configuring, [5-5](#)
 - configuring advanced options, [6-1](#)
 - definition, [3-3](#)
 - generic, [5-5](#)
 - naming conventions, [3-4](#)
 - Oracle RAC environment, [6-2](#)
 - parallel, [5-6](#)
- character sets

- character sets (*continued*)
 - setting for use with RMAN, [4-12](#)
- circular reuse records, [12-4](#)
- clean PDB restore points, [7-7](#)
- CLEAR LOGFILE clause
 - of ALTER DATABASE, [31-17](#)
- client, RMAN, [2-1](#), [3-1](#), [3-6](#)
- cold failover cluster
 - definition, [29-10](#)
- command files, RMAN, [2-9](#)
- command interface
 - RMAN, [3-3](#)
- commands, Recovery Manager
 - ADVISE FAILURE, [15-4](#), [15-11](#)
 - ALLOCATE CHANNEL, [5-5](#), [6-1](#), [6-5](#), [9-5](#)
 - BACKUP
 - PROXY ONLY option, [8-10](#)
 - PROXY option, [8-10](#)
 - BACKUP CURRENT CONTROLFILE, [9-13](#)
 - canceling, [24-14](#)
 - CATALOG, [12-17](#)
 - CHANGE, [3-9](#), [12-11](#)
 - CHANGE FAILURE, [15-16](#)
 - CONFIGURE, [3-8](#), [5-5](#), [5-29](#), [5-37](#), [6-1](#), [6-5](#), [6-12](#), [6-13](#)
 - CREATE CATALOG, [13-7](#)
 - CREATE SCRIPT, [13-21](#)
 - CROSSCHECK, [12-11](#)
 - DELETE, [12-12](#), [12-17](#), [12-20](#)
 - DROP CATALOG, [13-42](#)
 - DROP DATABASE, [12-27](#)
 - EXECUTE SCRIPT, [13-20](#), [13-22](#)
 - EXIT, [2-2](#)
 - FLASHBACK DATABASE, [13-35](#)
 - how RMAN interprets, [3-3](#)
 - IMPORT CATALOG, [13-39](#)
 - LIST
 - INCARNATION option, [11-9](#), [13-35](#)
 - MAXSETSIZE, [6-4](#)
 - pipng, [4-18](#)
 - PRINT SCRIPT, [13-24](#)
 - RECOVER, [14-6](#)
 - REPAIR FAILURE, [15-14](#), [15-16](#)
 - REPLACE SCRIPT, [13-22](#)
 - REPORT
 - NEED BACKUP option, [11-11](#)
 - RESET DATABASE
 - INCARNATION option, [13-35](#)
 - RESTORE, [17-4](#)
 - RESYNC CATALOG
 - FROM CONTROLFILECOPY option, [13-19](#)
 - REVOKE, [13-15](#)
 - SET, [6-11](#)
 - SHOW, [2-3](#), [5-2](#)
 - SPOOL, [15-14](#)
 - SWITCH, [17-18](#)

- commands, Recovery Manager (*continued*)
 - terminating, [24-14](#)
 - UNREGISTER DATABASE, [13-32](#)
 - UPGRADE CATALOG, [13-36](#)
 - VALIDATE, [15-2, 15-9, 16-4](#)
- commands, SQL*Plus
 - RECOVER
 - UNTIL TIME option, [30-23](#)
 - SET, [30-7, 30-10, 30-12, 30-16](#)
- comments in RMAN syntax, [4-14](#)
- COMPATIBLE initialization parameter, [6-9](#)
- complete recovery
 - application containers, [17-31](#)
 - application PDBs, [17-31](#)
 - application root, [17-29](#)
 - overview, [17-1](#)
 - procedures, [30-12](#)
 - sparse databases, [17-34](#)
- compressed backups
 - algorithms, [6-7](#)
- CONFIGURE command
 - AUXNAME option, [6-13](#)
 - BACKUP OPTIMIZATION option, [5-35](#)
 - CHANNEL option, [5-5, 6-1](#)
 - CONTROLFILE AUTOBACKUP option, [8-16, 9-45](#)
 - DB_UNIQUE_NAME option, [5-37](#)
 - ENCRYPTION option, [6-12](#)
 - EXCLUDE option, [6-6](#)
 - FOR DB_UNIQUE_NAME option, [3-8](#)
 - MAXPIECESIZE option, [6-5](#)
 - MAXSETSIZE option, [6-4](#)
 - RETENTION POLICY clause, [8-22](#)
 - RETENTION POLICY option, [5-29](#)
- configuring media managers
 - installing, [5-11](#)
 - prerequisites, [5-11](#)
- configuring Recovery Manager
 - autobackups, [5-8, 8-15](#)
 - backup optimization, [5-31](#)
 - backup retention policies, [5-29](#)
 - backup set size, [6-4](#)
 - default backup type, [5-4](#)
 - default devices, [5-3](#)
 - overview, [5-1](#)
 - shared server, [6-15](#)
 - snapshot control file location, [6-14](#)
 - specific channels, [6-2](#)
 - tablespace exclusion for backups, [6-6](#)
- connecting
 - to CDBs, [4-7](#)
 - to PDBs, [4-7](#)
- consistent backups
 - using RMAN, [8-2](#)
 - whole database, [29-3](#)
- control file autobackups (*continued*)
 - after structural changes to database, [8-15](#)
 - configuring, [5-8, 8-15](#)
 - default format, [8-16](#)
 - format, [5-8](#)
- control files
 - backups
 - binary, [29-14](#)
 - including within database backup, [9-12](#)
 - manual, [9-13](#)
 - recovery using, [20-5](#)
 - using RMAN, [9-12](#)
 - circular reuse records, [12-4](#)
 - configuring location, [5-27](#)
 - creating after loss of all copies, [31-7](#)
 - finding file names, [29-2](#)
 - multiplexed
 - loss of, [31-1](#)
 - multiplexing, [12-6](#)
 - re-created, [31-7](#)
 - restoring, [20-6, 31-1, 31-2](#)
 - snapshot
 - specifying location of, [6-14](#)
 - user-managed restore after loss of all copies, [31-7](#)
- CONTROL_FILE_RECORD_KEEP_TIME initialization parameter, [12-4, 12-5](#)
- CONTROL_FILES initialization parameter, [20-6, 21-23, 31-2](#)
- CONVERT command
 - ALLOW INCONSISTENT option, [28-35, 28-36](#)
- COPIES option
 - BACKUP command, [10-9](#)
- corrupt blocks
 - recovering, [19-3](#)
 - RMAN and, [10-14](#)
- crash recovery
 - of CDBs, [30-19](#)
- CREATE CATALOG command, [13-7](#)
- CREATE DATAFILE clause, ALTER DATABASE statement, [31-11](#)
- CREATE SCRIPT command, [13-21](#)
- CREATE TABLE statement
 - AS SELECT clause, [31-11](#)
- CREATE TABLESPACE statement, [31-6](#)
- creating
 - virtual private catalogs, [13-13](#)
- creating, PDB restore points, [7-13](#)
- cross-platform data transport
 - data pump destination, [28-22](#)
- cross-platform transport
 - data files, using image copies, [28-7](#)
 - databases
 - using backup sets, [28-26](#)
 - using image copies, [28-10](#)
 - inconsistent tablespaces
 - about, [28-32](#)
 - example, [28-37](#)

- cross-platform transport (*continued*)
 - inconsistent tablespaces (*continued*)
 - steps, [28-35](#)
 - methods
 - using backup sets, [28-19](#)
 - using image copies, [28-3](#)
 - of CDBs, [28-42](#)
 - of PDBs, [28-42](#)
 - over the network, [28-41](#)
 - PDB to a new CDB, [28-43](#), [28-45](#)
 - read-only tablespaces
 - using backup sets, [28-29](#)
 - using image copies, [28-5](#)
 - tablespaces in PDBs, [28-47](#)
 - tablespaces, DataPump export dump file, [28-23](#)
- cross-platform transportable tablespace, [28-1](#)
- CROSSCHECK command, [12-11](#)
- crosschecking, RMAN
 - definition, [12-12](#)
 - recovery catalog with the media manager, [12-12](#)
- cumulative incremental backups, [2-7](#), [2-8](#), [8-17](#), [8-19](#)

D

- data blocks, corrupted, [1-2](#), [1-3](#), [2-14](#), [2-19](#), [14-1](#), [15-9](#), [15-16](#), [16-4](#), [19-1](#), [30-26](#), [30-27](#)
- data dictionary views, [29-5](#), [29-7](#), [29-12](#), [29-13](#)
- data files
 - backing up, [9-11](#), [9-50](#), [9-51](#), [29-5](#)
 - backing up, in PDBs, [9-19](#)
 - determining status, [29-2](#)
 - listing, [29-1](#)
 - losing, [30-5](#)
 - restoring, [14-3](#)
 - transporting across platforms, [28-7](#)
- Data Guard environment
 - archived log deletion policies, [5-36](#)
 - changing a DB_UNIQUE_NAME, [13-31](#)
 - configuring RMAN, [5-37](#)
 - reporting in a, [11-3](#)
 - RMAN backups, [9-2](#)
 - RMAN backups, accessibility of, [3-9](#)
 - RMAN backups, association of, [3-9](#)
 - RMAN backups, interchangeability of, [3-9](#), [9-12](#)
 - RMAN usage, [3-8](#)
- data integrity checks, [1-9](#), [15-2](#), [15-9](#)
- data preservation, definition of, [1-4](#)
- data protection, definition, [1-2](#)
- data pump destination, [28-22](#)
- Data Recovery Advisor
 - automated repairs, [1-9](#)
 - data integrity checks, [15-2](#), [15-9](#)
 - failure consolidation, [15-4](#)
 - failure priority, [15-4](#)
 - failures, [15-2](#), [15-3](#)
 - feasibility checks, [15-4](#)

- Data Recovery Advisor (*continued*)
 - for CDBs, [15-7](#)
 - overview, [1-9](#)
 - purpose, [15-1](#)
 - repair options, [15-11](#)
 - repairing failures, [15-14](#)
 - repairs, [15-2](#), [15-4](#), [15-5](#)
 - supported configurations, [15-6](#)
 - user interfaces, [15-2](#)
- data repair
 - overview, [14-1](#)
 - techniques, [14-1](#)
- data transfer, RMAN, [1-4](#)
- database connections
 - Recovery Manager
 - auxiliary database, [4-10](#)
 - hiding passwords, [4-10](#)
 - without a catalog, [4-2](#)
 - SYSBACKUP required for RMAN, [4-2](#)
 - types in RMAN, [4-2](#)
- Database Home page, accessing, [1-10](#)
- database point-in-time recovery
 - definition, [18-2](#)
 - Flashback Database and, [7-2](#)
 - prerequisites, [18-25](#)
 - user-managed, [30-20](#)
- databases
 - duplicating, [25-30](#)
 - listing for backups, [29-1](#)
 - media recovery procedures, user-managed, [30-1](#)
 - media recovery scenarios, [31-1](#)
 - multitenant container, [9-15](#)
 - recovery
 - after control file damage, [31-1](#), [31-2](#)
 - registering in recovery catalog, [13-9](#)
 - reporting on schemas, [11-14](#)
 - suspending, [29-16](#)
 - transporting across platforms
 - using backup sets, [28-26](#)
 - using image copies, [28-10](#)
 - unregistering from recovery catalog, [13-32](#)
- DB_BLOCK_CHECKSUM initialization parameter, [16-2](#)
- DB_CREATE_FILE_DEST initialization parameter, [9-42](#), [17-13](#)
- DB_FILE_NAME_CONVERT initialization parameter, [21-23](#)
- DB_FLASHBACK_RETENTION_TARGET initialization parameter, [5-23](#)
- DB_LOST_WRITE_PROTECT initialization parameter, [6-16](#)
- DB_NAME initialization parameter, [21-22](#)
- DB_RECOVERY_FILE_DEST initialization parameter, [2-1](#)
- DB_RECOVERY_FILE_DEST_SIZE initialization parameter, [2-1](#)

- DB_UNIQUE_NAME initialization parameter, [3-8](#), [3-9](#), [5-37](#), [11-3](#)
- DBA_DATA_FILES view, [29-5](#), [29-7](#), [29-12](#), [29-13](#)
- DBID
 - determining, [17-6](#)
 - problems registering copied database, [13-2](#)
- DBMS_PIPE package, [4-18](#)
- DBPITR, [18-25](#)
- DBVERIFY utility, [29-23](#)
- DELETE command
 - EXPIRED option, [12-12](#), [12-25](#)
 - OBSOLETE option, [8-25](#), [12-26](#)
- deleting
 - archived redo log files, [9-32](#)
 - archived redo log files, in CDBs, [9-33](#)
 - dropped PDB backups, [12-26](#)
- deleting backups, [2-13](#), [12-20](#), [12-21](#), [12-24](#)
- deletion policies, archived redo log
 - enabling, [5-37](#)
- devices, configuring default, [5-3](#)
- diagnose failures
 - in CDBs, [15-7](#)
- differential incremental backups, [2-7](#), [8-17](#), [8-18](#)
- direct ancestral path, [14-8](#), [18-16](#), [18-36](#)
- disabling
 - Flashback Database, [7-18](#)
- disaster recovery
 - definition, [1-3](#)
- disconnecting
 - from Recovery Manager, [2-2](#)
- disk API, [5-13](#)
- disk failures, [1-3](#)
- disk usage
 - monitoring, [12-8](#)
- DROP DATABASE command, [12-27](#)
- dropped tables, retrieving, [18-11](#)
- dropping a database, [12-27](#)
- dropping the recovery catalog, [13-42](#)
- dual mode backup encryption, [6-12](#)
- dual-mode backup encryption, [10-13](#)
- duplexing backup sets, [6-5](#), [8-13](#), [10-7](#)
- duplicate databases
 - active database duplication, [4-10](#)
- duplicating
 - databases, [25-30](#)
 - sparse CDBs, [25-40](#)
 - sparse databases, [25-33](#)
 - sparse PDBs, [25-43](#)
 - tablespaces, [25-31](#)
- duplication
 - SET NEWNAME, [26-2](#)
 - using encrypted backups, [25-55](#)
- DURATION parameter, BACKUP command, [10-15](#)

E

enabling

- enabling (*continued*)
 - Flashback Database, [7-17](#)
- encrypted backups
 - backup-based duplication, [25-55](#)
 - decrypting, [17-11](#)
- environment variables
 - NLS_DATE_FORMAT, [4-12](#)
 - NLS_LANG, [4-12](#)
- error codes
 - media manager, [24-4](#)
 - RMAN, [24-1-24-3](#)
- error messages, RMAN
 - interpreting, [24-6](#)
- error stacks, RMAN
 - interpreting, [24-6](#)
- example
 - duplicating databases, [25-58](#)
 - multisection incremental backups, [9-8](#)
 - recovering tables into new schema, [22-12](#)
- examples
 - recovering using third-party snapshots, [30-10](#)
 - rolling forward a physical standby, [20-23](#)
- EXECUTE SCRIPT command, [13-22](#)
- EXIT command, [2-2](#)
- exiting RMAN, [2-2](#)
- expired backups
 - deleting, [12-25](#)
- EXPIRED option
 - DELETE command, [12-25](#)

F

- failover, when restoring files, [14-4](#)
- failures
 - definition, [1-3](#)
 - media, [1-3](#)
- failures, Data Recovery Advisor
 - consolidation, [15-4](#)
 - priority, [15-4](#)
- fast recovery area
 - autobackups, [5-8](#)
 - changing locations, [12-10](#)
 - configuring, [5-19](#)
 - definition, [2-1](#)
 - disabling, [12-11](#)
 - effect of retention policy, [8-26](#)
 - enabling, [5-21](#)
 - flashback database window, [7-3](#)
 - maintaining, [12-7](#)
 - monitoring disk usage, [12-8](#)
 - monitoring usage, [12-8](#)
 - Oracle Managed Files, [5-21](#)
 - PDB point-in-time recovery, [18-28](#)
 - permanent and impermanent files, [5-19](#)
 - RMAN files in, [5-28](#)
 - setting location, [5-24](#)
 - setting size, [5-23](#)

- fast recovery area (*continued*)
 - snapshot control files, [6-14](#)
 - space management, [5-21](#)
- feasibility checks, Data Recovery Advisor, [15-4](#)
- file names, listing for backup, [29-1](#)
- file sections, [8-7](#), [8-8](#), [10-3](#), [16-4](#)
- flashback CDB, [18-19](#)
- flashback CDB, using SQL*Plus, [30-3](#)
- flashback data archive
 - definition, [1-7](#)
- Flashback Database
 - determining the flashback database window, [18-16](#)
 - disabling, [7-18](#)
 - enabling, [7-17](#)
 - flashback logs, [1-8](#), [7-8](#)
 - limitations, [7-3](#)
 - monitoring, [7-19](#)
 - overview, [1-8](#)
 - prerequisites, [18-15](#)
 - purpose, [18-1](#)
 - requirements, [7-10](#)
 - space management
 - estimating disk space requirement, [5-24](#)
 - tuning performance, [7-19](#)
- FLASHBACK DATABASE command, [18-16](#)
- flashback database window, [7-3](#)
- flashback database, and PITR for PDBs, [18-5](#)
- flashback database, PDBs, [18-22](#)
- Flashback Drop, [18-4](#), [18-11](#)
- flashback logs
 - guaranteed restore points and, [7-5](#)
- flashback PDB, local undo, [18-6](#)
- flashback PDB, shared undo, [18-6](#)
- flashback PDB, using SQL*Plus, [30-4](#)
- flashback retention target, [7-2](#)
- Flashback Table
 - using, [18-7](#), [18-8](#)
- FLASHBACK TABLE statement, [18-7](#), [18-8](#)
- Flashback Technology
 - logical features, [18-3](#)
 - overview, [1-7](#)
- flashback undrop
 - restoring objects, [18-12](#)
- foreign data file, [28-22](#)
- foreign data file copy, [28-22](#)
- foreign tablespace, [28-22](#)
- formats, for RMAN backups, [9-4](#)
- fractured blocks
 - detection, [8-2](#)
- full backups
 - incremental backups and, [2-7](#)

G

- generic channels
 - definition, [5-5](#)

- groups, redo log, [31-14](#), [31-15](#)
- guaranteed restore points
 - alternative to storage snapshots, [7-5](#)
 - compared to storage snapshots, [7-5](#)
 - creating, [7-11](#)
- flashback logs and, [7-5](#)
- requirements, [7-10](#)
- space usage in fast recovery area, [7-15](#)

H

- Health Monitor, [15-3](#)
- hot backup mode
 - failed backups, [29-9](#), [29-10](#)
 - for online user-managed backups, [29-8](#)

I

- I/O errors
 - effect on backups, [10-14](#)
- image copies
 - definition, [8-10](#)
 - testing restore of, [17-9](#)
- IMPORT CATALOG command, [13-39](#)
- INCARNATION option
 - LIST command, [11-9](#), [13-35](#)
 - RESET DATABASE command, [13-35](#)
- incarnations
 - database, [11-9](#), [14-7](#), [18-16](#), [18-36](#)
- INCLUDE CURRENT CONTROLFILE option
 - BACKUP command, [9-12](#)
- incomplete media recovery, [30-20](#)
- incomplete recovery
 - defined, [18-25](#)
 - in Oracle Real Application Clusters configuration, [30-8](#)
 - overview, [14-6](#)
 - time-based, [30-23](#)
 - with backup control file, [30-8](#)
- inconsistent backups
 - using RMAN, [2-5](#), [8-2](#)
- inconsistent tablespaces
 - transporting across platforms, [28-33](#)
- incremental backups
 - block change tracking, [9-40](#)
 - differential, [8-18](#)
 - how RMAN applies, [14-7](#)
 - making, [9-33](#)
 - multisection incremental backups, [9-8](#)
 - using RMAN, [10-8](#), [10-9](#)
- initialization parameter file, [14-6](#)
- initialization parameters
 - CONTROL_FILES, [20-6](#), [31-2](#)
 - DB_FILE_NAME_CONVERT, [21-23](#)
 - DB_NAME, [21-22](#)
 - LOG_ARCHIVE_DEST_n, [30-8](#)
 - LOG_ARCHIVE_FORMAT, [30-8](#)

initialization parameters (*continued*)
LOG_FILE_NAME_CONVERT, 21-22
instance failures
 backup mode and, 29-9
instance recovery
 of CDBs, 30-19
integrity checks, 16-1
interpreting RMAN error stacks, 24-6
interrupting media recovery, 30-11

J

jobs, RMAN
 monitoring progress, 23-11
 querying details about, 11-17

K

KEEP option
 BACKUP command, 12-15

L

level 0 incremental backups, 2-7, 8-17, 8-20
level 1 incremental backups, 8-18, 8-19
LIST command
 FAILURE option, 15-8
 INCARNATION option, 13-35
listing
 dropped PDB backups, 11-16
local undo, flashback PDB operations, 18-6
log sequence numbers, 30-6
LOG_ARCHIVE_DEST_n initialization parameter,
 5-28, 5-29, 17-10, 30-7, 30-8, 30-12, 30-21,
 30-23
LOG_ARCHIVE_FORMAT initialization parameter,
 30-8
LOG_FILE_NAME_CONVERT initialization
 parameter, 21-22
logical backups, 1-2
logical block corruption, 16-2
LOGSOURCE variable
 SET statement, 30-10, 30-12, 30-16
long waits, 23-14
loss of
 inactive log group, 31-15
lost writes, detecting, 6-16

M

maintenance commands, RMAN
 Data Guard environment, 12-2
managing RMAN metadata, 11-1, 12-1
MAXPIECESIZE parameter
 SET command, 5-15
MAXSETSIZE parameter
 BACKUP command, 6-4, 10-1

MAXSETSIZE parameter (*continued*)
 CONFIGURE command, 6-4
media failures
 archived redo log file loss, 30-20
 complete recovery, 30-12
 complete recovery, user-managed, 30-12
 control file loss, 31-7
 datafile loss, 30-5
 definition, 1-3
 NOARCHIVELOG mode, 30-24
 online redo log group loss, 31-14
 recovery, 30-12
 recovery procedures
 examples, 30-5
Media Management Layer (MML) API, 3-6, 6-5
media managers
 backing up files, 3-6
 backup piece names, 5-15
 Backup Solutions Program, 3-7
 catalog, 3-1
 configuring for use with RMAN, 5-12
 crosschecking, 12-12
 definition, 2-1
 error codes, 24-4
 file restrictions, 5-15
 installing, 5-11
 library location, 5-11
 linking
 testing, 5-13
 linking to software, 3-7, 5-11
 multiplexing backups, 8-8
 prerequisites for configuring, 5-11
 sbtest program, 24-13
 testing, 5-13, 5-14
 testing backups, 5-14
 testing the API, 24-12
 third-party, 5-10
 troubleshooting, 5-14
media recovery
 ADD DATAFILE operation, 31-6
 after control file damage, 31-1, 31-2
 applying archived redo logs, 30-6
 cancel-based, 30-20, 30-23
 complete
 closed database, 30-12
 complete, user-managed, 30-12
 corruption
 allowing to occur, 30-30
 errors, 30-27
 incomplete, 30-20
 interrupting, 30-11
 lost files
 lost archived redo log files, 30-20
 lost data files, 30-5
 lost mirrored control files, 31-1
 NOARCHIVELOG mode, 30-24

media recovery (*continued*)

- offline tablespaces in open database, [30-16](#)
- online redo log files, [31-13](#)
- parallel, [30-11](#)
- problems, [30-25](#), [30-27](#), [30-28](#)
- restarting, [30-11](#)
- restoring
 - whole database backups, [30-24](#)
- resuming after interruption, [30-11](#)
- roll forward phase, [30-6](#)
- scenarios, [31-1](#)
- time-based, [30-20](#)
- transportable tablespaces, [31-12](#)
- trial, [30-32](#)
- troubleshooting, [30-25](#), [30-27](#)
- user-managed, [30-1](#)
- using Recovery Manager, [14-6](#)

metadata, RMAN, [3-5](#), [11-1](#), [12-1](#), [13-1](#)

mirrored files

- backups using, [10-9](#)
- splitting
 - suspend/resume mode, [29-16](#)
 - using RMAN, [10-9](#)

monitoring fast recovery area usage, [12-8](#)

monitoring RMAN, [24-8](#)

MTTR, [15-1](#)

multiplexed backup sets, [6-4](#), [8-8](#), [9-6](#), [23-4](#)

multiplexed control files, [5-19](#), [5-27](#), [12-6](#), [17-3](#), [29-2](#), [30-6](#), [31-1](#)

multisection backups

- views, [9-8](#)

multisection incremental backups

- example, [9-8](#)

multitenant container databases, [4-7](#)

N

naming

- duplicate database files, [26-2](#)

naming backup sets, [8-6](#)

NLS_DATE_FORMAT environment variable, [4-12](#)

NLS_LANG environment variable, [4-12](#)

NOARCHIVELOG mode

- backing up, [9-15](#)
- disadvantages, [30-24](#)
- recovery, [30-24](#)

O

obsolete backups

- definition, [8-22](#)
- deleting, [2-13](#), [8-25](#), [12-26](#)

off-site backups, [17-8](#)

online redo logs

- active group, [31-14](#), [31-15](#)
- applying during media recovery, [30-6](#)

online redo logs (*continued*)

- archived group, [31-14](#), [31-15](#)
- clearing
 - failure, [31-17](#)
- clearing inactive logs
 - archived, [31-16](#)
 - unarchived, [31-16](#)
- configuring location, [5-27](#)
- current group, [31-14](#), [31-15](#)
- inactive group, [31-14](#), [31-15](#)
- loss of
 - active group, [31-17](#), [31-18](#)
 - all members, [31-14](#)
 - group, [31-14](#)
 - recovery, [31-13](#)
- loss of group, [31-17](#), [31-18](#)
- multiple group loss, [31-18](#)
- replacing damaged member, [31-13](#)
- status of members, [31-14](#), [31-15](#)

OPEN RESETLOGS clause

- ALTER DATABASE statement, [13-35](#), [14-7](#), [18-16](#), [18-35](#)

ORA-01578 error message, [31-11](#)

Oracle Advanced Compression option, [6-8](#)

Oracle Backup Solutions Program (BSP), [3-7](#)

Oracle Data Pump, [1-2](#), [18-19](#)

Oracle Enterprise Manager Cloud Control

- about, [1-10](#)
- accessing the Database Home page, [1-10](#)

Oracle Flashback Database, [1-8](#)

Oracle Flashback Drop, [1-7](#)

Oracle Flashback Query, [1-7](#)

Oracle Flashback Table, [1-7](#)

Oracle Flashback Transaction, [1-7](#)

Oracle Flashback Transaction Query, [1-7](#)

Oracle Flashback Version Query, [1-7](#)

Oracle keystore, [6-10](#)

Oracle Managed Files

- fast recovery, [5-21](#)

Oracle Real Application Clusters (Oracle RAC)

- RMAN channels and, [6-2](#)

Oracle Secure Backup, [3-7](#), [5-10](#)

Oracle software keystore

- and backups, [6-10](#)

Oracle VSS writer, [5-19](#)

orphaned backups, [14-10](#)

P

packages

- DBMS_PIPE, [4-18](#)

password backup encryption, [6-11](#)

password-mode encryption, [10-12](#)

passwords

- connecting to RMAN, [4-10](#)

PDB restore points, [7-7](#)

PDB restore points, creating, [7-13](#)

- PDB restore points, namespace, [7-8](#)
- PDB restore points, viewing, [7-15](#)
- PDBs
 - about backup and recovery of, [4-7](#)
 - backing up, using Oracle Enterprise Manager Cloud Control, [9-18](#)
 - backing up, using RMAN, [9-18](#)
 - complete recovery
 - data files, [17-26](#)
 - tablespaces, [17-26](#)
 - using RMAN, [17-23](#)
 - complete restore, [17-20](#)
 - connecting to, [4-7](#)
 - orphaned backups, [14-10](#)
 - performing point-in-time recovery, [18-30](#)
 - point-in-time recovery and fast recovery area, [18-28](#)
 - recovering table partitions, [22-9](#)
 - recovering tables, [22-9](#)
 - reporting, [11-16](#)
 - restrictions when connected to, [4-8](#)
 - transporting across platforms, [28-42](#)
 - user-managed backups, [29-4](#)
 - validating, [16-9](#)
- PDBs, clean PDB restore point, [7-7](#)
- PDBs, flashback database and PITR, [18-5](#)
- PDBs, flashback database operation, [18-22](#)
- PDBs, restore points, [7-7](#)
- PDBs, rewinding, [18-22](#)
- performance tuning
 - short waits
 - definition of, [23-14](#)
- performance tuning, RMAN
 - backup performance, [23-15](#)
 - long waits, [23-14](#)
- physical backups, [1-2](#)
- physical block corruption, [16-2](#)
- pipe interface, RMAN, [4-18](#)
- PITR, for PDBs, [18-5](#)
- pluggable databases, [4-7](#)
- point of recoverability
 - recovery window, [8-23](#)
- point-in-time recovery
 - application PDBs, [18-32](#)
 - of CDBs, [18-28](#)
 - of PDBs, [18-30](#)
 - performing
 - with current control file, [18-25](#)
 - tablespace, [18-2](#)
- PREVIEW option, RESTORE command, [11-1](#)
- previewing backups, [17-7](#)
- PRINT SCRIPT command, [13-24](#)
- proxy copies, [3-6](#), [8-10](#)
- PROXY option
 - BACKUP command, [8-10](#)

Q

- QUIT command, [2-2](#)
- quitting RMAN, [2-2](#)

R

- raw devices
 - backing up to, [29-18](#)
 - UNIX backups, [29-18](#)
 - Windows backups, [29-20](#)
- RC_ARCHIVED_LOG view, [11-20](#)
- RC_BACKUP_FILES view, [11-23](#)
- RC_BACKUP_PIECE view, [11-20](#)
- RC_BACKUP_SET view, [12-21](#)
- read-only tablespaces
 - backups, [29-11](#)
 - transporting across platforms
 - using backup sets, [28-29](#)
 - using image copies, [28-5](#)
- RECOVER clause
 - ALTER DATABASE statement, [30-10](#), [30-12](#), [30-16](#)
- RECOVER command
 - COPY option, [9-36](#)
 - FOREIGN DATAFILECOPY clause, [28-37](#)
 - FROM SERVICE parameter, [20-26](#)
 - PARALLEL and NOPARALLEL options, [30-11](#)
 - TEST option, [16-7](#)
 - unrecoverable objects and standby databases, [31-11](#)
 - UNTIL TIME option, [30-23](#)
 - USING BACKUP CONTROLFILE clause, [31-7](#)
- recovering
 - table partitions in PDBs, [22-9](#)
 - tables in PDBs, [22-9](#)
- recovering database file
 - over the network, [20-22](#)
- recovering database files
 - over the network, example, [20-23](#)
 - using physical standby, [20-22](#)
- recovering files over the network
 - scenarios, [20-22](#)
- recovering table partitions
 - example, [22-11](#)
 - limitations, [22-6](#)
 - overview, [22-1](#)
 - prerequisites, [22-7](#)
 - steps, [22-8](#)
- recovering tables
 - example, [22-10](#)
 - limitations, [22-6](#)
 - new schema, [22-6](#)
 - overview, [22-1](#)
 - prerequisites, [22-7](#)
 - steps, [22-8](#)
- recovery

recovery (*continued*)

- ADD DATAFILE operation, [31-6](#)
- automatically applying archived logs, [30-7](#)
- cancel-based, [30-23](#)
- complete
 - CDBs, [17-21](#)
 - CDBs using Oracle Enterprise Manager Cloud Control, [17-25](#)
 - closed database, [30-12](#)
 - data files in PDBs, [17-26](#)
 - offline tablespaces, [30-16](#)
 - PDBs, [17-23](#)
 - root, [17-22](#)
 - tablespaces in PDBs, [17-26](#)
 - tablespaces in PDBs using Cloud Control, [17-28](#)
- corruption
 - intentionally allowing, [30-30](#)
- data files, [30-5](#)
- database
 - complete, [17-1](#)
 - in NOARCHIVELOG mode, [20-1](#)
- database files
 - how RMAN applies changes, [14-7](#)
 - overview, [14-6](#)
- database, point-in-time, [18-1](#), [18-25](#)
- disaster using RMAN, [20-9](#)
- dropped table, [31-18](#)
- errors, [30-27](#)
- failures requiring, [1-3](#)
- interrupting, [30-11](#)
- media, [30-1](#), [30-25](#), [31-1](#)
- multiple redo threads, [30-8](#)
- of lost or damaged recovery catalog, [13-19](#)
- online redo logs
 - loss of group, [31-14](#)
- parallel, [30-11](#)
- preparing for, [17-4](#)
- problems
 - fixing, [30-28](#)
 - investigating, [30-28](#)
- stuck, [30-26](#)
- third-party snapshots
 - example, [30-10](#)
- time-based, [30-23](#)
- transportable tablespaces, [31-12](#)
- trial
 - explanation, [30-32](#)
 - overview, [30-32](#)
- troubleshooting, [30-25](#)
- user errors, [31-18](#)
- user-managed, [30-1](#), [30-25](#), [31-1](#)
- using backup control file
 - without recovery catalog, [20-7](#)
- using logs in a nondefault location, [30-9](#)
- using logs in default location, [30-8](#)
- using logs in nondefault location, [30-10](#)

recovery (*continued*)

- using storage snapshots, [30-10](#)
- using third-party snapshots, [30-10](#)
- with Oracle Enterprise Manager Cloud Control, [1-11](#)
 - without a recovery catalog, [12-6](#)
- Recovery Appliance
 - backing up to, [3-10](#)
- recovery catalog
 - backing up, [13-17](#)
 - cataloging backups, [12-17](#), [13-10](#)
 - centralization of metadata, [13-2](#)
 - creating, [13-5](#)
 - crosschecking, [12-12](#)
 - DBID problems, [13-2](#)
 - definition, [2-1](#), [3-1](#)
 - deleting backups, [12-20](#)
 - deleting records, [12-24](#)
 - dropping, [13-42](#)
 - log switch record, [12-17](#)
 - managing size of, [13-29](#)
 - operating with, [3-5](#)
 - purpose of, [13-1](#)
 - recovery of, [13-19](#)
 - refreshing, [13-27](#)
 - registering databases, [13-2](#), [13-8](#), [13-9](#)
 - resynchronizing, [13-27](#)
 - space requirements, [13-6](#)
 - stored scripts
 - creating, [13-21](#)
 - synchronization, [13-27](#)
 - unregistering databases, [13-32](#)
 - updating
 - after operating system deletions, [12-20](#)
 - upgrading, [13-36](#)
 - views, querying, [11-20](#)
 - virtual private catalogs, [3-5](#)
- recovery catalogs
 - backing up, [13-17](#)
 - dropping, [13-42](#)
 - importing, [13-39](#)
 - moving, [13-42](#)
- Recovery Manager
 - allocating tape buffers, [23-7](#)
 - archived redo logs
 - backups, [9-27](#)
 - backups
 - archived redo logs, [9-27](#)
 - backing up, [9-48](#)
 - batch deletion of obsolete, [8-25](#)
 - control files, [9-12](#)
 - data file, [9-11](#), [9-50](#), [9-51](#)
 - duplexed, [8-13](#)
 - image copy, [8-10](#)
 - incremental, [9-33](#), [10-8](#), [10-9](#)
 - optimization, [5-31](#), [9-30](#)

- Recovery Manager (*continued*)
 - backups (*continued*)
 - tablespace, [9-50, 9-51](#)
 - testing, [16-3, 16-4, 16-6](#)
 - validating, [16-4, 16-6](#)
 - whole database, [9-10](#)
 - channels
 - naming conventions, [3-4](#)
 - client, [2-1](#)
 - connecting to databases, [2-2](#)
 - corrupt data file blocks
 - handling I/O errors and, [10-14](#)
 - crosschecking recovery catalog, [12-12](#)
 - database character set, [4-12](#)
 - database connections
 - auxiliary database, [4-10](#)
 - duplicate database, [4-10](#)
 - hiding passwords, [4-10](#)
 - SYSDBA or SYSDBA required for target, [4-2](#)
 - without a catalog, [4-2](#)
 - DBMS_PIPE package, [4-18](#)
 - definition, [2-1](#)
 - disconnecting from, [2-2](#)
 - error codes
 - message numbers, [24-3](#)
 - errors
 - interpreting, [24-6](#)
 - file deletion, [12-21](#)
 - fractured block detection in, [8-2](#)
 - image copy backups, [8-10](#)
 - incremental backups
 - cumulative, [8-19](#)
 - differential, [8-18](#)
 - level 0, [8-17](#)
 - integrity checking, [16-1](#)
 - jobs, monitoring progress, [23-11](#)
 - jobs, querying details of, [11-17](#)
 - lists, [11-3](#)
 - maintenance commands, [2-12](#)
 - media management
 - backing up files, [3-6](#)
 - Backup Solutions Program (BSP), [3-7](#)
 - crosschecking, [12-12](#)
 - media manager, linking with a, [5-11](#)
 - metadata, [3-5, 11-1, 12-1, 13-1](#)
 - monitoring, [24-8](#)
 - overview, [2-1, 3-3](#)
 - performance
 - monitoring, [24-8](#)
 - pipe interface, [4-18](#)
 - proxy copy, [3-6](#)
 - recovery
 - after total media failure, [20-9](#)
 - recovery catalog
 - backing up, [13-17](#)
 - crosschecking, [12-12](#)

- Recovery Manager (*continued*)
 - recovery catalog (*continued*)
 - managing the size of, [13-29](#)
 - operating with, [3-5](#)
 - recovering, [13-19](#)
 - registration of target databases, [13-2, 13-8, 13-9](#)
 - resynchronizing, [13-27](#)
 - synchronization, [13-27](#)
 - upgrading, [13-36](#)
 - reports
 - database schema, [11-14](#)
 - objects needing a backup, [11-11](#)
 - obsolete backups, [11-13](#)
 - repository, [3-5](#)
 - restoring
 - archived redo logs, [17-10](#)
 - retention policies
 - configuring, [5-29](#)
 - return codes, [24-8](#)
 - setting time parameters, [4-12](#)
 - snapshot control file location, [6-14](#)
 - starting, [2-2](#)
 - synchronous and asynchronous I/O, [23-5, 23-8](#)
 - terminating commands, [24-14](#)
 - test disk API, [5-13](#)
 - types of backups, [8-10](#)
 - using RMAN commands, [3-3](#)
- recovery window
 - point of recoverability, [8-23](#)
- RECOVERY WINDOW parameter
 - CONFIGURE command, [5-30](#)
- recovery windows
 - configuring for retention policy, [5-30](#)
 - definition, [8-23](#)
- RECOVERY_CATALOG_OWNER role, [13-13](#)
- recycle bin
 - restoring objects from, [18-12](#)
- redo logs
 - incompatible format, [30-26](#)
 - naming, [30-8](#)
 - parallel redo, [30-26](#)
- redo records
 - problems when applying, [30-26](#)
- REGISTER command, [13-9](#)
- REPAIR FAILURE command, [15-14, 15-16](#)
- repair failures
 - in CDBs, [15-7](#)
- repair options, Data Recovery Advisor, [15-11](#)
- repairs, Data Recovery Advisor
 - consolidation of, [15-5](#)
 - manual and automatic, [15-4](#)
- REPLACE SCRIPT command, [13-22](#)
- REPORT command
 - NEED BACKUP option, [11-11](#)
 - OBSOLETE option, [8-25](#)
- reporting

- reporting (*continued*)
 - in CDBs, [11-16](#)
 - in PDBs, [11-16](#)
- reports, RMAN
 - backup jobs, [11-17](#)
 - database schema, [11-14](#)
 - files needing backups, [11-11](#)
 - obsolete backups, [11-13](#)
 - unrecoverable backups, [11-13](#)
- repository, RMAN, [3-5](#)
- RESET DATABASE command
 - INCARNATION option, [13-35](#)
- RESETLOGS operation
 - when necessary, [14-7](#)
- RESETLOGS option
 - of ALTER DATABASE, [30-25](#)
- restartable backups, [10-14](#)
- RESTORE command
 - ALL FOREIGN DATAFILES clause, [28-25](#)
 - BACKUPSET clause, [28-24](#)
 - DATAPUMP clause, [28-26](#)
 - DATAPUMP DESTINATION clause, [28-37](#)
 - DUMPFILE clause, [28-24](#), [28-37](#)
 - FORCE option, [14-6](#)
 - FOREIGN DATABASE clause, [28-25](#), [28-29](#)
 - FOREIGN DATAFILE clause, [28-25](#), [28-37](#)
 - FOREIGN TABLESPACE clause, [28-25](#), [28-32](#)
 - FROM BACKUPSET clause, [28-36](#)
 - FROM PLATFORM parameter, [28-25](#)
 - FROM SERVICE parameter, [20-23](#)
 - NOIMPORT option, [28-26](#)
 - PREVIEW option, [11-1](#), [17-7](#)
 - VALIDATE HEADER option, [11-1](#), [17-7](#)
- restore optimization, [14-6](#)
- restore points
 - creating, [7-11](#)
 - dropping, [7-16](#)
 - flashing back to, [18-36](#)
 - guaranteed
 - compared to storage snapshots, [7-5](#)
 - listing, [7-14](#)
 - multitenant environment, [7-6](#)
 - requirements, [7-10](#)
- restore points, creating in CDBs, [7-12](#)
- restore points, creating in PDBs, [7-13](#)
- restore points, in CDBs, [7-6](#)
- restore validation, [17-9](#)
- restoring
 - control files
 - to default location, [31-1](#)
 - to nondefault location, [31-2](#)
 - database
 - to default location, [30-24](#)
 - database files, [14-3](#), [14-4](#), [14-6](#)
 - encrypted backups, [14-5](#)
 - server parameter files, [20-2](#)
- restoring (*continued*)
 - testing, [16-7](#), [17-9](#)
 - user-managed backups, [30-5](#)
- restoring database file
 - over the network, [20-22](#)
- restoring database files
 - over the network, example, [20-23](#)
- restoring files over the network
 - scenarios, [20-22](#)
- restrictions
 - PDBs, [4-8](#)
- RESUME clause
 - ALTER SYSTEM statement, [29-18](#)
- resuming recovery after interruption, [30-11](#)
- RESYNC CATALOG command
 - FROM CONTROLFILECOPY option, [13-19](#)
- resynchronizing the recovery catalog
 - SET command
 - DBID option, [3-8](#)
- return codes
 - RMAN, [24-8](#)
- REVOKE command, [13-15](#)
- rewinding
 - CDBs, [18-19](#)
- RMAN, [3-1](#)
- RMAN repository, [1-4](#), [2-1](#)
- RMAN sessions, [2-15](#), [3-3](#)
- root
 - backing up
 - using Oracle Enterprise Manager Cloud Control, [9-17](#)
 - using RMAN, [9-17](#)
 - complete recovery, [17-22](#)
 - complete restore, [17-20](#)

S

- SBT, [3-4](#), [3-7](#), [5-16](#)
- sbttest program, [24-13](#)
- scenarios, Recovery Manager
 - NOARCHIVELOG backups, [9-15](#)
 - recovering pre-resetlogs backup, [18-38](#), [20-1](#)
 - recovery after total media failure, [20-9](#)
- scripts, RMAN
 - substitution variables in, [9-46](#)
- server parameter files
 - autobackups, [8-15](#)
 - backups, [9-14](#)
 - configuring autobackups, [5-8](#), [8-15](#)
 - restoring, [20-2](#)
- server sessions, Recovery Manager, [3-3](#)
- session architecture, Recovery Manager, [3-3](#)
- SET command
 - ENCRYPTION option, [6-11](#)
 - MAXCORRUPT option, [16-3](#)
- SET statement
 - AUTORECOVERY option, [30-7](#)

- SET statement (*continued*)
 - LOGSOURCE variable, [30-10](#), [30-12](#), [30-16](#)
- shadow copies, [9-36](#)
- shared server
 - configuring for use with RMAN, [6-15](#)
 - configuring RMAN, [6-15](#)
- shared undo, flashback PDB operations, [18-6](#)
- short waits
 - definition, [23-14](#)
- SHOW command, [2-3](#), [5-2](#)
- SHUTDOWN statement
 - ABORT option, [30-24](#), [31-1](#), [31-2](#)
- size of backup sets, setting, [8-7](#)
- skipping files in RMAN backups, [10-7](#)
- snapshot control file
 - specifying location, [6-14](#)
 - specifying location in Oracle Real Application Clusters environment, [6-15](#)
- snapshot control files, [6-14](#), [13-27](#)
- snapshots
 - backing up using third-party technologies, [29-22](#)
 - using Storage Snapshot Optimization, [29-22](#)
- sparse backups, [8-12](#)
- sparse CDBs
 - duplicating, [25-40](#)
- sparse data files
 - backing up, [9-24](#)
- sparse databases
 - duplicating, [25-33](#)
- sparse PDBs
 - backing up, [9-26](#)
 - duplicating, [25-43](#)
- sparse tablespaces
 - backing up, [9-24](#)
- split mirrors
 - suspend/resume mode, [29-16](#)
 - using as backups, [10-9](#)
- SPOOL command, [15-14](#)
- standby databases, [3-1](#)
- statements, SQL
 - ALTER DATABASE, [30-10](#), [30-12](#), [30-16](#)
- status
 - dropped PDB backups, [12-16](#)
- Storage Snapshot Optimization, [29-22](#)
- storage snapshots
 - recovering, [30-10](#)
- stored scripts
 - creating RMAN, [13-21](#)
 - deleting, [13-26](#)
 - dynamic, [13-23](#)
 - executing, [13-26](#)
 - listing names of, [13-25](#)
 - managing, [13-20](#)
 - printing, [13-24](#)
 - substitution variables in, [13-23](#)
- stuck recovery, [30-26](#)

- substitution variables, FORMAT parameter, [5-15](#), [8-6](#), [8-10](#)
- substitution variables, stored scripts, [13-23](#)
- SUSPEND clause
 - ALTER SYSTEM statement, [29-17](#)
- suspend/resume mode, [29-16](#)
- suspending a database, [29-16](#)
- SWITCH command, [17-18](#)
- SYSBACKUP privilege, [4-4](#)
- system backup to tape, [3-7](#)
- system time
 - changing
 - effect on recovery, [30-23](#)

T

- tables, recovery of dropped, [31-18](#)
- tablespace point-in-time recovery
 - performing on dropped tablespaces, [21-2](#)
 - planning, [21-6](#)
 - preparing the auxiliary instance, [21-21](#)
 - restrictions, [21-6](#)
 - why perform, [21-1](#)
- tablespaces
 - backups
 - offline, [29-5](#)
 - online, [29-8](#)
 - backups using RMAN, [9-11](#)
 - backups, in PDBs, [9-19](#)
 - excluding from backups, [6-6](#)
 - excluding from RMAN backups, [6-6](#)
 - read-only
 - backing up, [29-12](#)
 - read/write
 - backing up, [29-7](#)
 - recovering accessible
 - when database is open, [17-16](#)
 - recovering in PDBs
 - using Cloud Control, [17-28](#)
 - recovering offline in open database, [30-16](#)
 - transporting across platforms, in PDBs, [28-47](#)
 - transporting with RMAN, [27-1](#)
 - user-managed backups, in CDBs, [29-13](#)
 - user-managed backups, in PDBs, [29-13](#)
- tape devices, [3-7](#)
- target database
 - connecting to, [2-2](#)
 - definition, [2-1](#), [3-1](#)
- terminating RMAN commands, [24-14](#)
- test disk API, [5-13](#)
- testing RMAN
 - backups, [16-3](#), [16-4](#), [16-6](#)
 - with media management API, [24-12](#)
- third-party snapshots
 - specifying recovery time, [30-10](#)
- time format

- time format (*continued*)
 - RECOVER DATABASE UNTIL TIME statement, 30-23
- time parameters
 - setting for Recovery Manager use, 4-12
- time-based recovery, 30-23
- trace files, RMAN, 24-2
- transparent backup encryption, 6-10
- transparent-mode backup encryption, 10-12
- transportable tablespaces
 - creating with RMAN
 - and Data Pump Export, 27-9
 - and past points in time, 27-8
 - auxiliary destination, 27-3
 - auxiliary instance parameter file, 27-5, 27-6
 - file locations, 27-10
 - initialization parameters, 27-5
 - cross-platform, 28-1
 - recovery, 31-12
- transporting tablespaces, 27-1
- trial recovery, 16-7, 30-32
- tuning Recovery Manager
 - V\$ views, 24-8

U

- UNAVAILABLE option
 - of CHANGE, 12-15
- UNCATALOG option
 - CHANGE command, 12-20
 - deleting repository records, 12-20
- undo optimization, backup, 5-31, 8-6
- unrecoverable objects
 - recovery, 31-11
- UNREGISTER DATABASE command, 13-32
- unregistering databases, 13-32
- UNTIL TIME option
 - RECOVER command, 30-23
- upgrading
 - virtual private catalog, 13-16
- upgrading the recovery catalog, 13-36
- user errors
 - definition, 1-3
 - recovery from, 31-18
- user-managed backups
 - backup mode, 29-7, 29-9
 - control files, 29-14
 - definition, 8-11
 - determining data file status, 29-2
 - hot backups, 8-2, 29-10
 - listing files before, 29-1
 - of CDBs, 29-4
 - of PDBs, 29-4
 - offline tablespaces, 29-5
 - read-only tablespaces, 29-11
 - tablespaces, 29-8
 - tablespaces in CDBs, 29-13

- user-managed backups (*continued*)
 - tablespaces in PDBs, 29-13
 - verifying, 29-23
 - whole database, 29-3
- user-managed recovery
 - ADD DATAFILE operation, 31-6
 - complete, 30-12
 - incomplete, 30-20
 - interrupting, 30-11
 - scenarios, 31-1
- user-managed restore operations, 30-5

V

- V\$ARCHIVED_LOG view
 - listing all archived logs, 29-16
- V\$BACKUP view, 29-2
- V\$BACKUP_ASYNC_IO view, 23-13
- V\$BACKUP_DATAFILE view, 9-34, 12-18
- V\$BACKUP_FILES view, 5-30, 12-12, 12-18
- V\$BACKUP_PIECE view, 11-20, 12-18
- V\$BACKUP_REDOLOG view, 12-18
- V\$BACKUP_SET view, 12-18, 12-21
- V\$BACKUP_SPCFILE view, 12-18
- V\$BACKUP_SYNC_IO view, 23-13
- V\$BLOCK_CHANGE_TRACKING view, 9-43
- V\$CONTROLFILE view, 9-12
- V\$DATABASE view, 11-21, 18-9, 18-35
- V\$DATABASE_BLOCK_CORRUPTION view, 1-5, 2-19, 16-3, 16-4, 19-1, 19-3, 19-5, 19-8
- V\$DATABASE_INCARNATION view, 13-35
- V\$DATAFILE view
 - listing files for backups, 29-1
- V\$DATAFILE_HEADER view, 11-1, 17-5
- V\$DIAG_INFO view, 19-5
- V\$EVENT_NAME view, 24-9
- V\$FLASHBACK_DATABASE_LOG view, 5-24, 18-16, 18-35
- V\$FLASHBACK_DATABASE_STAT view, 7-19
- V\$INSTANCE view, 17-5
- V\$LOG_HISTORY view
 - listing all archived logs, 30-12
- V\$LOGFILE view, 21-22, 31-14, 31-15
- V\$PARAMETER view, 18-9
- V\$PROCESS view, 11-1, 24-10
- V\$RECOVER_FILE view, 17-5, 30-12
- V\$RECOVERY_AREA_USAGE view, 12-8
- V\$RECOVERY_FILE_DEST, 12-8
- V\$RECOVERY_FILE_DEST view, 12-8
- V\$RECOVERY_LOG view
 - listing logs needed for recovery, 30-12
- V\$RESTORE_POINT, 7-15
- V\$RESTORE_POINT view, 18-9
- V\$RMAN_BACKUP_JOB_DETAILS view, 11-17
- V\$RMAN_BACKUP_SUBJOB_DETAILS view, 11-17

V\$RMAN_ENCRYPTION_ALGORITHMS view, [6-9](#),
[6-13](#), [23-7](#)
V\$RMAN_OUTPUT view, [11-21](#)
V\$RMAN_STATUS view, [24-1](#)
V\$SESSION view, [6-15](#), [11-1](#), [24-10](#)
V\$SESSION_LONGOPS view, [23-11](#)
V\$SESSION_WAIT view, [24-9](#)
V\$SGASTAT view, [23-16](#)
V\$SYSSTAT view, [7-19](#)
V\$TABLESPACE view, [17-6](#), [29-2](#)
VALIDATE command
 SECTION SIZE parameter, [16-4](#)
VALIDATE HEADER option, RESTORE command,
 [11-1](#)
validating
 CDBs, [16-9](#)
 PDBs, [16-9](#)
validation, RMAN
 backups, [2-9](#), [16-4](#), [16-6](#)
 database files, [2-9](#), [16-4](#)
 restore operations, [17-9](#)
viewing, CDB restore points, [7-15](#)

viewing, PDB restore points, [7-15](#)
views
 for multisection backups, [9-8](#)
views, recovery catalog, [11-1](#), [11-20](#)
virtual private catalogs
 creating, [13-13](#)
 dropping, [13-16](#)
 upgrading, [13-16](#)
Volume Shadow Copy Service (VSS), [5-19](#), [9-36](#)

W

whole database backups
 ARCHIVELOG mode, [29-3](#)
 inconsistent, [29-3](#)
 NOARCHIVELOG mode, [29-3](#)
 preparing for, [29-3](#)
 using RMAN, [9-10](#)

Z

Zero Data Loss Recovery Appliance, [1-11](#)

